

ARCC 2023 CONFERENCE PROCEEDINGS

THE RESEARCH - DESIGN INTERFACE

EDITORS: Saif Haq and Adil Sharaf-Eldin

EDITORIAL ASSISTANT: Sepideh Niknia

Hosted By Texas Tech University

HUCKABEE
COLLEGE OF ARCHITECTURE

ARCC

ARCC 2023 CONFERENCE PROCEEDING

THE RESEARCH DESIGN INTERFACE

HOSTED BY
TEXAS TECH UNIVERSITY, APRIL 12-15, 2023

CONFERENCE CO-CHAIRS:
Saif Haq and Zahra Safaverdi

EDITORS:
Saif Haq and Adil Sharag-Eldin

EDITORIAL ASSISTANT:
Sepideh Niknia

PUBLISHER: Architectural Research Centers Consortium, Inc.
ISBN: 978-1-935129-33-2

© 2023 Architectural Research Centers Consortium, Inc. All rights reserved. No part of this book may be reproduced in any manner whatsoever without prior written permission from the publisher.

TABLE OF CONTENTS

INTRODUCTION – ARCC 2023 ANNUAL CONFERENCE XVII-XVIII

PEER REVIEW COMMITTEE XX-XXIII

KEYNOTES SPEAKERS XXIV-XXV

PLENARIES XXVI-XXXII

ARCC 2023 RESEARCH PAPERS AND POSTERS..... 1

Planning, Policy & Resilience Track..... 1

**Architectural Anachronism by Culture-based Urban Forms: Chinatowns in the US3-13
and Copycat Towns in China**

 Xiao Hu: University of Idaho, Moscow, ID

**Beyond “still standing”: A proposed framework for schools to intentionally support 15-23
community resilience after disasters**

 Traci Rose Rider, North Carolina State University, Raleigh, NC

Communities- Pilot Study for User Acceptance and Early Data Collection 25-32

 Sanaz Sadat Hosseini, University of North Carolina at Charlotte, Charlotte, NC
 Mona Azarbayjani, University of North Carolina at Charlotte, Charlotte, NC
 Hamed Tabkhi, University of North Carolina at Charlotte, Charlotte, NC

Design, Pedagogy and University-Community Partnerships in an Era of Global Challenges 33-40

 José L.S. Gámez, University of North Carolina Charlotte, Charlotte, NC

**Environmental Racism: How Design and Planning Policies Create Structural Injustices 41-47
in Cleveland and Detroit**

 Taraneh Meshkani, Kent state University, Kent, OH

**Estimating the Relative Benefit of Local Climate Change Policies to Neighborhood Social..... 49-56
Vulnerability**

 Adele Houghton, Harvard T.H. Chan School of Public Health, Boston, MA. Biositu, LLC
 Brett Turner, Harvard T.H. Chan School of Public Health, Boston, MA

**Learning at the Regional Level and Understanding at the Local Scale: Transect System 57-65
as Research Mixed Method for Resilient Design**

 Carla Brisotto, University of Florida, Florida Institute for Built Environment Resilience, Gainesville, Florida, US
 Forough Foroutan, University of Florida, Florida Institute for Built Environment Resilience, Gainesville, Florida, US
 Ali Mahmoud, University of Florida, Florida Institute for Built Environment Resilience, Gainesville, Florida, US
 Emilee Aguerrebere, University of Florida, Florida Institute for Built Environment Resilience, Gainesville, Florida, US
 Lisa Platt, University of Florida, Florida Institute for Built Environment Resilience, Gainesville, Florida, US
 Jeff Carney, University of Florida, Florida Institute for Built Environment Resilience, Gainesville, Florida, US

Modeling Reciprocities 67-74

 Nate Imai, Texas Tech University, Lubbock, TX
 Matthew Conway, UCLA + USC, Los Angeles, CA

**Parks Take Command; Public Space Centered Design Frameworks for Chicago's Large-scale.... 75-83
Private Developments**

Saldaña Perales Alejandro, College of Architecture at the Illinois Institute of Technology, Chicago, IL

Public Space: An Instrument of Urban Activism..... 85-92

Seung Ra, Oklahoma State University, Stillwater, OK

**SOLEIL: Combining Housing Affordability and Sustainability to Add a New Standard 93-100
for Neighborhood Compatibility**

Michael Garrison, School of Architecture, The University of Texas at Austin
Gabrielle Patracolla, School of Architecture, The University of Texas at Austin
Noah Heerdin, School of Architecture, The University of Texas at Austin
Julia Manion, School of Architecture, The University of Texas at Austin
Madison Bryan, School of Architecture, The University of Texas at Austin

**Sustainable Development and Affordable Housing in Kingston, Jamaica: Integrating..... 101-108
Research and Design**

Phoebe Crisman, University of Virginia, Charlottesville, VA

**Towards a Community-Led Design Studio: Cultivating Relationships and Stewarding 109-116
Projects**

Julia W. Robinson, School of Architecture, University of Minnesota, Minneapolis, MN
Timothy Griffin, Minnesota Design Center, University of Minnesota, Minneapolis, MN
Jaycie Thomsen, Northside Safety NET Environmental Initiative, Minneapolis, MN
Savannah L. Steele, School of Architecture, University of Minnesota, Minneapolis, MN
Michael Chaney, Project Sweetie Pie, Minneapolis, MN
Jamil Ford, Mobilize Design and Architecture, Minneapolis, MN

Troublesome Creeks: An Atlas of Appalachia in the Anthropocene..... 117-122

Jeff Fugate, University of Kentucky, Lexington, KY
Brent Sturlaugson, Morgan State University, Baltimore, MD

Health & Well-being Track 123

**A Biology-Architecture Collaboration: Integrating Biological Concepts with a Bio-Inspired 125-134
Design Process**

Mary Guzowski, School of Architecture, University of Minnesota, Minneapolis, MN
Emilie Snell-Rood, Department of Biology, University of Minnesota, Minneapolis, MN
William Weber, School of Architecture, University of Minnesota, Minneapolis, MN
Dimitri Smirnoff, Department of Curriculum and Instruction, University of Minnesota, Minneapolis, MN

**A Pilot Study on Indoor Air Quality in a Naturally Ventilated Classroom in Eugene, Oregon, ... 135-142
During the Covid-19 Pandemic**

Maria C. Coronado, University of Oregon Institution, Eugene, OR
Alison Kwok, University of Oregon Institution, Eugene, OR

**Accessible Public Space: Spatializing Adolescent Girls' Fears on the Urban Fringe of 143-151
Hyderabad, India**

Lyndsey Deaton, Clemson University, Clemson, SC

**Analyzing Effective Variables to Explain the Ratio Preferences among Autistic and 153-160
Non-Autistic Children**

Pariya Sheykhmaleki, Department of Design, Texas Tech University, Lubbock, TX
Seyed Abbas Agha Yazdanfar, School of Architecture and Environmental Design, the Iran University of Science and
Technology, Tehran, Iran

**Cool to be Cool: Impact of Cool Roof Coating on the Thermal Performance of Slum 161-167
Houses In Dhaka**

Zainab Faruqui Ali, Department of Architecture, Brac University, Dhaka, Bangladesh
Emmat Ara Khanam Ema, Department of Architecture, Brac University, Dhaka, Bangladesh
Mohammad Zillur Rahman, Department of Architecture, Brac University, Dhaka, Bangladesh

**Design Science Research Toward Integrated Production of Design Artifacts and 169-176
Knowledge in Outpatient Clinic Cases**

Jinoh Park, University of Arkansas, Fayetteville, AR

**Exposure to Particle Matter and Carbon Dioxide in a Naturally Ventilated Athletic Facility..... 177-185
during the COVID-19 Pandemic**

Panos Karaiskos, University of Texas at San Antonio, San Antonio, TX
Layla Iskandar, University of Texas at San Antonio, San Antonio, TX
Antonio Martinez-Molina, Drexel University, Philadelphia, PA
Miltiadis Alamaniotis, University of Texas at San Antonio, San Antonio, TX

**IEQ Factors in Learning: A Case Study of the Impact of Acoustics on Students with 187-194
Autism Spectrum Disorder (ASD) in a South-Central School in United States**

Michael Lekan-Kehinde, University of Minnesota, Saint Paul, MN
Abimbola Asojo, University of Minnesota, Saint Paul, MN
Bonnie Sanborn, DLR Group, Chicago, IL

**Impact of Vegetated Infrastructure to Mitigate the Urban Heat Island Effect in Dhaka, 195-203
Bangladesh**

Tasneem Tariq, Pennsylvania State University, State College, PA. Bangladesh University of Engineering and
Technology (BUET), Dhaka, Bangladesh
Ute Poerschke, Pennsylvania State University, State College, PA
Lisa Domenica Lulo, Pennsylvania State University, State College, PA

Logic Models as Conceptual Frameworks for Design 205-212

Schaeffer Somers, University of Virginia, Charlottesville, VA
Christine J. Le, University of Virginia, Charlottesville, VA

Potential Benefits of Vegetative Shading on Architecture Energy Efficiency..... 213-221

Rosa McDonald, North Carolina State University, Raleigh, NC
Wayne Place, North Carolina State University, Raleigh, NC
Traci Rose Rider, North Carolina State University, Raleigh, NC

The Benefits of Biophilic Architecture in Interior Spaces: Applications on Schools..... 223-230

Ebtehal Bahnasy, University of Minnesota, Minneapolis, MN

**The Impact of Spatial Light Patterns on Older Adults' Perception and Preference of the..... 231-239
Indoor Environment**

Nasrin Golshany, University of Oregon, Eugene, OR
Ihab Elzeyadi, University of Oregon, Eugene, OR

**The Impact of Space Function and Window View on Perceived Indoor Environmental 241-248
Quality and Privacy**

Anupam Satumane, Baker Lighting Lab, University of Oregon, Eugene, OR
Siobhan Rockcastle, Baker Lighting Lab, University of Oregon, Eugene, OR

**The Influence of Birth Room Spatial Qualities on Staff Behaviors and their Association with... 249-256
Women's Satisfaction Using Mixed Research Method**

Rafah Altaweli, University of Cincinnati, Cincinnati, OH
Pravin Bhiwapurkar, University of Cincinnati, Cincinnati, OH

**The Intersection of Ethics, Empathy, and Agency in Architecture Education: Using the 257-264
Design Studio to Research Client Needs**

Alexis Gregory, Mississippi State University, Mississippi State, MS

The *LivingRoom*, A Low-Cost Prototype Outdoor Classroom and Learning Garden 265-272

Benjamin L. Gunter, Mississippi State University, Starkville, MS
Hans C. Herrmann, Mississippi State University, Starkville, MS
Abbey Franovich, Mississippi State University, Starkville, MS
Warren C. Gallo, Mississippi State University, Starkville, MS
Sarah R. Lalk, Mississippi State University, Starkville, MS

**Towards an Optimal Lighting Comfort: Understanding a gender-specific indoor lighting 273-279
conditions via trainee's physiological signals for optimum physical training environment**

Dongwoo (Jason) Yeom, Arizona State University, Tempe, AZ

**Understanding of Occupant Wellbeing in Sustainable Built Environment - a Mindfulness 281-286
Framework**

Ming Hu, University of Maryland, College Park, MD

**Urban Morphology, Inequitable Exposure, and Intra-Urban Heat: A Local-Scale Pilot 287-294
Study in Cincinnati**

Debanjali Banerjee, University of Cincinnati, Cincinnati, OH
Pravin Bhiwapurkar, University of Cincinnati, Cincinnati, OH

Technology and Architecture Track 295

**A Framework Proposal for Developing Historical Video Games Based on Player 297-305
Review Data Mining to Support Historic Preservation**

Sarvin Eshaghi, Texas Tech University, Lubbock, TX
Sepehr Vaez Afshar, Texas Tech University, Lubbock, TX
Mahyar Hadighi, Texas Tech University, Lubbock, TX

**A look at residential building stock in the United States - Mapping life cycle 307-314
embodied carbon emissions and environmental impact**

Ming Hu, University of Notre Dame, Notre Dame, IN

**AI-assisted Generative EA Design with topological optimisations for an 80 or 50 315-321
meters long Hybrid 3D-printed WAAM Steel Bridge in Germany**

Thomas Spiegelhalter, Florida International University, Miami, FL. Carbon-Neutral-Projects LCC, Miami-Berlin, US-Germany

**An Environmental Analysis of a Residential Building in the US: Modeling Challenges 323-328
And Materials Optimization**

Ash Ragheb, Lawrence Technological University, Southfield, MI

**An Evolutionary Multi-objective Optimization Tool for Designing Kinetic Façades 329-336
Integrating Daylight and Lighting Energy Simulation**

Samin Kamalisarvestani, Southern Illinois University, Carbondale, IL
Mehdi Ashayeri, Southern Illinois University, Carbondale, IL
Narjes Abbasabadi, University of Washington, Seattle, WA

Beyond Patterning: Embedding Shading in Opaque Building Envelopes 337-344

Luis Santos, Department of Architecture, Design and Media Technology, Aalborg University, Aalborg, Denmark
Nick Safley, College of Architecture and Environmental Design, Kent State University, Kent, OH

Blockchain-Enabled BIM For Unified Lifecycle Design-Construction Data Management 345--352

Oluwatoyin O. Lawal, School of Architecture, University of Florida, Gainesville, FL
 Nawari O. Nawari, School of Architecture, University of Florida, Gainesville, FL

Changing Roles of Human in the Human-Robot Interactions in Design and Construction..... 353-360

Rui Liu, College of Architecture and Environmental Design, Kent State University, Kent, OH. College of Aeronautics and Engineering, Kent State University, Kent, OH
 Vahid Koliyae, College of Architecture and Environmental Design, Kent State University, Kent, OH
 Frederick Lucak, College of Architecture and Environmental Design, Kent State University, Kent, OH
 Yibei Guo, College of Aeronautics and Engineering, Kent State University, Kent, OH

**Combining Electrochromic Glazing Systems with Different Light Transmissions Towards..... 361-365
 Optimizing Daylight in Office Buildings**

Alireza Jahanara, The University of Texas at San Antonio, San Antonio, TX
 Jae Yong Suk, University of California, Davis, CA

**Comparison of Carbon Accounting between Linked BIM-LCA Tools for Mass Timber 367-374
 Buildings**

Giankeving Guzman Ganto, School of Civil and Environmental Engineering, Georgia Institute of Technology, Atlanta, GA
 Valerie M. Thomas, School of Industrial and Systems Engineering, Georgia Institute of Technology, Atlanta, GA
 María del Mar Ceballos, Office of Sustainability, Kennesaw State University, Kennesaw, GA
 Russell Gentry, School of Architecture, Georgia Institute of Technology, Atlanta, GA

Critical Material Regionalism..... 375-382

Susannah Dickinson, University of Arizona, Tucson, AZ

Energy Performance Simulation for 3D Concrete Printed Houses 383-390

Chengde Wu, Iowa State University, Ames, IA
 Shelby Doyle, Iowa State University, Ames, IA
 Nick Senske, Iowa State University, Ames, IA
 Pete Evans, Iowa State University, Ames, IA

Estimating Thermal Comfort and Energy Use with Future Warmer Weather..... 391-398

Wendy Meguro, University of Hawaii at Manoa, Honolulu, HI
 Elliot J. Glassman, WSP Built Ecology, New York, NY
 Josephine Briones, University of Hawaii at Manoa, Honolulu, HI

**Exploring the Potential of the Physical Space Design Techniques for Immersive..... 399-404
 Experiences in the Metaverse: An Interpretation of Spatial Perception**

Michelle Boyoung Huh, University of Arkansas, Fayetteville, AR
 Seogjae Choi, The University of Texas at Austin, Austin, TX

Full Scale: Educating Architects Through Performed Labor..... 405-412

Nick Safley, Kent State University, Kent, OH

**Generative Urban Design: A Workflow Integrating Real-World Mobility, Zoning, and 413-420
 Multi-Objective Simulation**

Peng Du, ¹Thomas Jefferson University, Philadelphia, PA
 Nithin Cheluva Ranganath Mavinkere, ¹Thomas Jefferson University, Philadelphia, PA
 Yang Yang, Cornell University, Ithaca, NY

Global United Spatial Systems: Toward Immersive Conviviality 421-428

Keith Kaseman, Georgia Institute of Technology, Atlanta, GA

**Green Skins for Gray Buildings: How High-Performance Building Envelope Retrofits 429-437
Impact Occupants' Health and Well-Being?**

Ihab M.K. Elzeyadi, University of Oregon, Eugene, OR
Stanley Gatland II, Saint-Gobain North America, Malvern, PA

Impacts of Repurposing Renewable Energy Waste as Oriented Strand Board in Texas 439-444

Patricia N. Kio, Fitchburg State University, Fitchburg, MA
Precious Batubo, University of Louisiana at Lafayette, Lafayette, LA

Investigations in 3D Printing of Precast Molds 445-451

Jeffrey Collins, Kennesaw State University, Marietta, GA

**Learning From the Past: Evaluation and Optimization of the Inherent Energy 453-461
Performance of a Residential Historic Building in a Hot and Humid Climate**

Layla Iskandar, The University of Texas at San Antonio, San Antonio, TX
Panos Karaiskos, The University of Texas at San Antonio, San Antonio, TX
Antonio Martinez-Molina, Drexel University, Philadelphia, PA
Saadet Beeson, The University of Texas at San Antonio, San Antonio, TX

**Low Cost & Low Tech: Democratizing Building Science Research through 463-469
Bottom-Up Design**

Elizabeth L. McCormick, University of North Carolina at Charlotte, Charlotte, NC. North Carolina State University,
Raleigh, NC
Lochana Desphande, University of North Carolina at Charlotte, Charlotte, NC

Making the Side-Yard House; A Passive Mass Housing Model 471-478

Craig S. Griffen, Thomas Jefferson University

Meaningful Technologies in Architecture Education: Three Case Studies 479-484

Tulio Resende Alcantara Fernandes, Universidade Federal de Vicosa, Minas Gerais, Brazil UFV
Clarissa Ferreira Albrecht, Universidade Federal de Vicosa, Minas Gerais, Brazil UFV

**Materials by Design: Seamless & Graded Transitional Interface Between Geopolymer 485-493
Concrete & Glass**

Shadi Nazarian, The Pennsylvania State University, University Park, PA
Maryam Hojati, University of New Mexico, Albuquerque, NM
José Duarte, The Pennsylvania State University, University Park, PA

New Schemes of Organized Complexity Based on Quasi-Crystalline Symmetries 495-502

Rima Ajlouni, University of Utah, Salt Lake City, UT

New Urban Enclaves: The Design of Tech Campuses 503-507

Taraneh Meshkani, Kent State University, Kent, OH

**Parametric Study and Multi-Objective Optimization of Deployable Scissor-Like 509-517
Bamboo Arch Structures**

Anastasia Maurina, Planning, Design, and Built Environment, Clemson University, Clemson, SC. Department of
Architecture, Universitas Katolik Parahyangan, Bandung, Indonesia
Vincent Y. Blouin, School of Architecture, Clemson University, Clemson, SC

**Performance Assessment of a Multifunctional 3D Building Integrated 519-525
Photovoltaic (BIPV) System**

Kyoung Hee Kim, University of North Carolina at Charlotte, Charlotte, NC
Chengde Wu, Iowa State University, Ames, IA
Seyedehamideh Hosseiniirani, University of North Carolina at Charlotte, Charlotte, NC
Catty Dan Zhang, University of North Carolina at Charlotte, Charlotte, NC

Rethinking The Architectural Review Through Immersive Virtual Reality	527-532
John Stack Ross, Mississippi State University, School of Architecture, Mississippi State, MS	
Rethinking Housing: Researching The Promise, And Limits, Of Emerging Technologies On Home Construction in the US	533-541
Scott Gerald Shall, Lawrence Technological University, Southfield, MI	
Rules of Thumb for Sizing Horizontal, Diagonal, and Vertical Components of Parallel-Chord Steel Trusses	543-550
Cesar A. Cruz, Ball State University, Muncie, IN	
Simulation Parsing for Optimal Daylight and Radiation Thresholds: A Case Study	551-558
Eiman Graiz, The University of Kansas, Lawrence, KS Keith Van de Riet, The University of Kansas, Lawrence, KS	
Soft Robotic Tessellated Origami Surface	559-566
Youness Yousefi, University of Calgary, Calgary, AB Vera Parlac, New Jersey Institute of Technology, Newark, NJ	
The Impact of Ceiling and Door Design on Building Fire Safety	567-574
Chengde Wu, Iowa State University, Ames, Iowa	
Using Virtual Reality to Visualize Sea Level Rise Impact and Mitigation	575-583
Sang Bum Park, Florida A&M University, Tallahassee, Florida David Kaul, Albright College, Reading, Pennsylvania Ana Orosco, Florida A&M University, Tallahassee, Florida Andrew Chin, Florida A&M University, Tallahassee, Florida	
Architecture & Humanities Track	585
Design Excellence Reset: Shifting Values and Interrogating Value in a Dramatically Different World	587-595
Brian R. Sinclair, University of Calgary + sinclairstudio inc., Calgary, Canada	
Developing a Visual Tool to Encourage Public Participation in Decision-Making Processes for Intervening in an Urban Historical Context	597-603
Najmeh Malekpour Bahabadi, Texas Tech University, Lubbock, TX Mahyar Hadighi, Texas Tech University, El Paso, TX	
Forced Migration and Housing Design in Receiver Communities	605-613
Forough Foroutan Jahromi, University of Florida, Gainesville, FL Jeffrey Carney, University of Florida, Gainesville, FL	
From form to formless	615-622
Arief Setiawan, Kennesaw State University, Marietta, GA	
How Do We Remember? A Data-Driven Approach to the Design of Monuments in Public Spaces	623-630
Tiffany Lin, Tulane University School of Architecture, New Orleans, LA Emilie Taylor Welty, Tulane University School of Architecture, New Orleans, LA Lisa Molix, Tulane University School of Science & Engineering, New Orleans, LA	

ARCC 2023 - THE RESEARCH-DESIGN INTERFACE

Portcitscapes as Liminal Spaces: Building Resilient Communities Through Parasitic Architecture in Port Cities 631-639

Asma Mehan, Huckabee College of Architecture, Texas Tech University, Lubbock, TX
Sina Mostafavi, Huckabee College of Architecture, Texas Tech University, Lubbock, TX

Sensitive Cultural Site as Center for Community and Education of Older Adults 641-644

Mary English, Auburn University, Auburn, AL

Social Currency: Alternative Home Economics 645-651

Gabriel Fries-Briggs, The University of New Mexico, School of Architecture + Planning, Albuquerque, NM
César A. Lopez, The University of New Mexico, School of Architecture + Planning, Albuquerque, NM

Spurensuche: On The Trail Of Seven Contemporary European Chapels 653-659

Andreas Luescher, Bowling Green State University, Bowling Green, OH

The Black Power Station: Collaborative Research-Design Methods in Makhanda, South Africa 661-668

Phoebe Crisman, University of Virginia, Charlottesville, VA

The Virtual St Paul’s Cathedral Project: Recreating the Experience of Lost Time and Lost Spaces 669-674

John N. Wall, NC State University, Raleigh, NC
David B. Hill, NC State University, Raleigh, NC
Yun Jing, Pennsylvania State University, State College, PA

Witness: Connecting People, Place, and Building 675-681

Jori Erdman, James Madison University, Harrisonburg, VA
Becky Beamer, OSLOMET University, Oslo, Norway

Research and Design Track 683

A “Jobs to be Done” Approach to Programming and Design for Diverse Communities 685-690

Brian Schermer, University of Wisconsin-Milwaukee and Workshop Architects, Milwaukee, WI

Analysis of Donald Judd’s Design Language for the “100 untitled works in mill aluminium” 691-699

Mehrdad Hadighi, Pennsylvania State University, University Park, PA
Mahyar Hadighi, Texas Tech University, El Paso, TX

Architecture’s Expanded Field: Territories of Collective Action 701-708

Frances Hsu, Marywood University, Scranton, PA

Developing a Transdisciplinary Assessment of User Research and Feedback from Early-Stage Experiential Prototype Development 709-716

Greg Garner, NC State University, Raleigh, North Carolina

Educate, Embed, And Empower: *Prioritizing Research in Practice* 717-722

Sarah Wicker, CallisonRTKL, Dallas, TX
Amy Keller Frye, CallisonRTKL, Dallas, TX
Helia Taheri, CallisonRTKL, Dallas, TX

Evaluation of a Framework for the Integration of Airflow Simulations into the Early Stages of Architectural Design using Delphi Method 723-730

Soo Jeong Jo, Louisiana State University, Baton Rouge, LA. Virginia Tech, Blacksburg, VA
James Jones, Virginia Tech, Blacksburg, VA

Optimizing Precast Concrete for Micro Housing 731-736

Gernot Riether, Hillier College of Architecture and Design, New Jersey Institute of Technology (NJIT), Newark, NJ
Mohamed Mahgoub, School of Applied Engineering and Technology, New Jersey Institute of Technology (NJIT), Newark, NJ

Patch, Stitch, Mend: A History of Urban Fabric Applied to Contemporary City Repair 737-743

Daniel Luis Martinez, Indiana University, Eskenazi School of Art, Architecture and Design, Bloomington, IN

The Powerhouse, a community-based adaptation of an industrial building 745-753

Gernot Riether, Hillier College of Architecture and Design, New Jersey Institute of Technology (NJIT), Newark, NJ

Third Places, Health and Urban Design: Lessons from a Cross-Sectional Study on Neighborhoods and Blood Pressure Among Parsis in Mumbai 755-762

Hitakshi Sehgal, University of Minnesota, Twin Cities, MN
William A. Toscano, University of Minnesota, Twin Cities, MN

Typo-morphology as a Methodological Framework to evaluate Urban Sustainability 763-771

Anirban Adhya, Lawrence Technological University, Southfield, MI
Philip D. Plowright, Lawrence Technological University, Southfield, MI

Walking for Context Analysis 773-779

Sarah Gamble, University of Florida, Gainesville, FL

Pedagogy Track 781

Behaviors and Failures; Using Novel Exercises as a Learning Tool in Teaching Structural Principles and Concepts to Architecture Students 783

Annicia Streete, Louisiana State University, Baton Rouge, LA

Learning Opportunities Through Immersive Technology: A Comparative Analysis Between Traditional and XR-Aided Learning in Design 797-806

S Y Andalib, Texas Tech University, Lubbock, TX
Muntazar Monsur, Texas Tech University, Lubbock, TX

Making a Case for Embodied Graphics Learning Methods in Architectural Structures Pedagogy 807-814

Bronne Dytoc, Kennesaw State University, GA

Natural Feedback Loops As Teaching Tool 815-820

Jay Yowell, Oklahoma State University, Stillwater, OK

OPERATING AT THE OVERLAP 821-829

Kelly Homan, Auburn University, Auburn, AL
Jennifer Smith, Auburn University, Auburn, AL
Robert Sproull, Auburn University, Auburn, A

Research-Design Interface for a Critical Teaching Practice 831-837

Patricia Kucker, Penn State University, University Park, PA
Cathy Braasch, Penn State University, University Park, PA

ARCC 2023 POSTERS	833
Adding Value by Design to Wind Turbine Blades and Solar Panels: A Literature Review	835
Burcu Salgin, Erciyes University, Türkiye. Texas A&M University, United States of America	
Ahmed K. Ali, Texas A&M University, United States of America	
Astrid Layton, Texas A&M University, United States of America	
Patricia Kio, ³ Fitchburg State University, United States of America	
An Overview Understanding of User Experience in a Neuroscience Outpatient Facility	835
Zeekra Baset Nadi, Kent State University, United States of America	
Attitudes Towards Infection Control Measures: The Role of The Physical Environment in	836
Healthcare Settings	
Zeekra Baset Nadi, Kent State University, United States of America	
Farimah Raisali, Kent State University, United States of America	
Nazli Jafari, Kent State University, United States of America	
Sara Bayramzadeh, Kent State University, United States of America	
Celebrating Forces of Nature: Envisioning A Floating Community	836
Yong Huang, Bowling Green State University, United States of America	
Trevor Hibbs, Bowling Green State University, United States of America	
Critical Teaching Practice for Collaboration & Teamwork	837
Braasch Cathy, Penn State, United States of America	
Patricia Kucker, Penn State, United States of America	
Designing the Inclusive Studio Environment	837
Wanda Kight, Penn State, United States of America	
Patricia Kucker, Penn State, United States of America	
Cathy Braasch, Penn State, United States of America	
Marc Miller, Penn State, United States of America	
Joel Priddy, Penn State, United States of America	
Dynamic Bioinspired Formwork	838
Mahsa Esfandiar, ¹ University of North Carolina at Charlotte, School of Architecture, Charlotte, NC	
Liz Liz McCormick, University of North Carolina at Charlotte, School of Architecture, Charlotte, NC.	
North Carolina State University, College of Design, Raleigh, NC	
MaryGrayson Roberts, ¹ University of North Carolina at Charlotte, School of Architecture, Charlotte, NC	
Liz Cooper, University of North Carolina at Charlotte, Dept. of Bioinformatics and Genomics	
Lindsay Shields, University of North Carolina at Charlotte, Dept. of Bioinformatics and Genomics	
Effectiveness of Narrative Storytelling to Convey the Significance of Historic Preservation	838
Modesto Melendez III, Texas Tech University, United States of America	
Engagement Stations, Design-build Pedagogy for Social Justice	839
Susan Melsop, The Ohio State University, United States of America	
Jo VandenBurg, University of Colorado, Denver	
Envisioning Adaptation to Sea Level Rise in Waikiki, HI	839
Wendy Meguro, University of Hawai'i at Mānoa, Environmental Research & Design Laboratory	
Charles Fletcher, University of Hawai'i at Mānoa, Climate Resilience Collaborative, SOEST	
Josephine Briones, University of Hawai'i at Mānoa, Environmental Research & Design Laboratory	
Ireland Castillo, ¹ University of Hawai'i at Mānoa, Environmental Research & Design Laboratory	

Implementing Happy City Design For A Better Quality Of Life.....840
 Mariah Zeien, North Dakota State University, United States of America
 Bakr Mourad Aly Ahmed, North Dakota State University, United States of America

Japanese Joinery + Computer Numerical Control.....840
 Lucas Theodore Murray, Mississippi State University, Starkville, MS, United States of America

The Power Of Architecture Renderings to Legitimize Design841
 Natalie Bobbi Florence, Arizona State University, United States of America

Timber Nest.....841
 Yong Huang, Bowling Green State University, United States of America
 John Kent, Bowling Green State University, United States of America
 Jack Collins, Bowling Green State University, United States of America
 Christopher Fletcher, Bowling Green State University, United States of America

Toward Blue Cities: Build On Water, Futuristic Sustainable Ubranism842
 Bakr Mourad Aly Ahmed, North Dakota State University, United States of America
 Mitchell Osland, North Dakota State University, United States of America

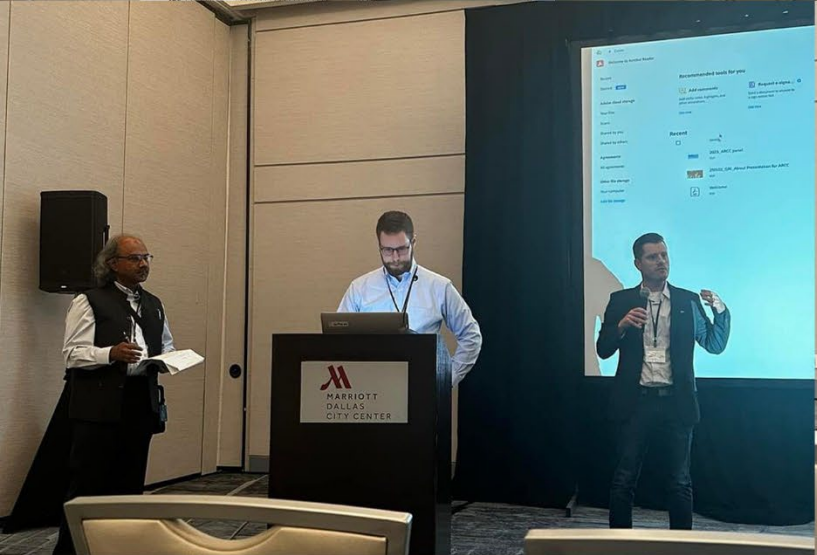

INTRODUCTION – ARCC 2023 ANNUAL CONFERENCE

THE RESEARCH DESIGN INTERFACE

The 2023 ARCC International conference was hosted by the Huckabee College of Architecture (HCoA) at Texas Tech University (TTU) in collaboration with the Design Leadership Alliance (DLA), a CoA alumni organization. It was held in the city of Dallas, TX, a fast-growing contemporary city vibrant in arts and culture with two major airports with direct national and international flights.

The Conference

Over the past two decades, architectural practice has been called on to be more 'responsible'. This is perhaps due to global realities such as climate changes, social disparities, health inequalities, on one hand, and emerging technology such as digital modeling, 3D printing, robotics, machine learning, , on the other. Together, they offer precise design and analysis opportunities. Within this context, a new approach, "Evidence Based Design," has been gaining momentum. This paradigm involves making design decisions with an informed client using the best available research evidence. The goal is to improve outcomes and continuously monitor for subsequent decision-making.

These transformative conditions call for a radical innovation in design thinking where the ability to interact with technical knowledge and scientific evidence becomes necessary. As research becomes accepted as an integral part of the design culture, the relationships between research results and practice applications – indeed that between researchers and designers -- become paramount. While considerable attention has been given to the research component, the needs of the change agent – the designer-- have not been adequately addressed.

The ARCC 2023 International conference brought together researchers who explore new ideas and answer relevant questions, design professionals who understand and implement them, and organizational clients and user groups. It focused on the intersection -- the 'sharp edge' or the 'blurry boundary', where research and design intersect and has created a set of ideas regarding the 'research-design interaction', the middle and often misunderstood ground between the mindsets of the researcher and the designer.

The conference theme was amazingly underpinned by three keynote speakers. Marina Tabassum, the internationally acclaimed architect, highlighted her work at the intersection of social, environmental, cultural, and economic aspects and the research that leads to her award-winning architecture. V. Mitch McEwen spoke about high-end computing technologies and their influence on architecture, and E. Sung Yi described the work of the NOW institute in communities, especially underprivileged ones across the globe.

The conference was organized around eight topical themes:

1. Planning, Policy, and Resilience

Included research on informal settlements and designed urban areas. The scope of this track was at the regional and city scales. It involved investigations on new forms of human settlements as they evolve with contemporary understandings of culture, ecology, climate change, economics, and politics.

2. Healthcare Facilities Design

Research that investigated healthcare building design as a distinguished area of research and how the type benefitted from the application of evidence-based design principles.

3. Wellness and the Built Environment

This track addressed the concept of wellness at all scales, including issues such as the relations between design and healthy lifestyles and the role of design to boost the balance between physical, emotional, cognitive, and spiritual wellbeing. More focused ideas of sustainability, green living, and pandemic responses were also part of this track.

4. Technology and Design

Research addressing the role of architectural and building technologies as an interface between research and design was the theme of this track. Topics included high-performance buildings, building information modeling, design decision support systems, digital fabrication, augmented and virtual reality, data mapping and visualization, smart materials.

5. Spatial and Formal Analysis, including Human Cognition

This track attracted researchers who studied the emergence of forms and spaces and the processes that contributed to their change over time. It also included contributions from human cognition research and the social-psychological sciences.

6. Architecture and Humanities

This theme represented researchers and designers who focused on architecture as a socio-cultural entity. The papers suggested that this amalgamation of the two paradigms, design and humanities created the discourse regarding identity, imagery, and meanings.

7. Role of Research in Practice

This track especially focused on how research informed the practice of architecture. It sought case studies of how specific research findings have changed typical design approaches and affected the culture of firms and client organizations.

8. Pedagogy

This track was for those authors who dealt with teaching research design intersections. Academic projects that addressed the understanding and application of research-derived evidence to design moves were featured here.

9. Open track:

This track included topics that did not directly address the categories above but offered interesting perspectives on the larger conference theme.

Acknowledgments

Texas Tech University is about 350 miles from Dallas Marriott Downtown hotel, where the conference was held. As such, we had to rely on many people in both locations for planning and logistics.

We are grateful to the ARCC board of directors for accepting the theme and the proposal (including location) and entrusting Texas Tech University's (TTU) Huckabee College of Architecture (HCoA) with organizing this year's conference --especially when the proposal included hosting it in a city away from the university. This was the first of its kind for ARCC.

The two co-chairs of the conference, Professors Saif Haq and Zahra Safaverdi took on the challenge of organization a major international conference at a location far away from their city and having the grit and tenacity to make sure that all details, both big and small, were handled and resolved in time and with success. Thank you!!!. Certainly, we are obliged to its president, Professor Adil Sharag-Eldin, for leading the paper submissions, double-blind review, and acceptance processes. This is vital for the success of this (or any) conference.

We are grateful to Dean Upe Flueckiger of HCoA for his enthusiasm and support. Associate Dean Hazem Rashed-Ali for being an integral part by acting as the bridge between conference organizers and HCoA administration, taking the lead when necessary, and being the institutional memory of ARCC that we could tap into for answers to all kinds of questions that arose. The Design Leadership Alliance was a valuable partner who made links to the professional community and connected us to sponsors. Also, we would like to acknowledge and give thanks to W. Mark Gunderson, AIA and Peter Raab, Associate Professor, for organizing two inspiring and information-rich tours of the architectural gems in Fort Worth and Dallas. Participants in these tours really appreciated the 'behind the scenes' experience.

We need to put in a special note about the staff members and student volunteers who really elevated the opportunity and went far beyond their responsibilities. Ms. Rachel Roe was responsible for the liaison between HCoA in Lubbock and the venue in Dallas. The spaces, food, and other arrangements were almost single-handedly arranged by her. Mr. Denny Mingus was responsible for the conference technology. Working remotely from Lubbock through a handful of student assistants, he made sure that there were no glitches anywhere. Ms. Trish Salinas made sure that all travel-related paperwork and logistics were done on time. Ms. Deirdre Odell coordinated with the DLA regarding alumni input and participation. Mr. Jeff Hoover made sure that all physical needs for the conference, including packing and transport of supplies and materials, were seamless. Mr. Alex Root managed the many meetings that had to be organized. He also drove a truck full of equipment to Dallas and back.

We cannot be more grateful to our student volunteers Amber Hodge, Raul Jimenez, Viviana Quezada and Ashton Rider. Their commitment to the success of the conference and positive attitudes uplifted the spirit of the entire conference.

The editors extend their heartfelt gratitude to the technical committee, abstract, and paper reviewers for their invaluable contribution to the conference. We reserve special appreciation for Professor Chris Jarrett, past president of ARCC, for his support and advice. We extend our appreciation to the many scholars who moderated the sessions expertly and ably. To the authors of the papers and posters presented, your dedication in responding to calls and refining your ideas for presentation and publication played a significant role in the conference's triumph. To everyone involved, thank you.

Finally, our thanks to Ms. Sepideh Niknia for all her painstaking work in making the proceedings a reality.

Saif Haq and Adil Sharag-Eldin, Editors

PEER REVIEW COMMITTEE

AL-Mohannadi, Asmaa Saleh
Qatar University

Alaqtum, Tasbeeh
University of Arizona

Almutlaq, Manal
Prince Stam University

Altaweli, Rafah
University of Cincinnati

Anis, Manal
University of Illinois at Urbana Champaign

Ashayeri, Mehdi
Southern Illinois University Carbondale

Ashrafi, Roshanak
UNC Charlotte

Balducci, Beatrice
Politecnico di Milano

Baudoin, Genevieve
Kansas State University

Bayramzadeh, Sara
Kent State University

Beltran, Liliana
Texas A&M University

Bernal, Sandra Maria
University of Arizona

Bhiwapurkar, Pravin
University of Cincinnati

Bollo, Christina
UIUC

Cabrera i Fausto, Ivan
Universitat Politècnica de València

Caldwell, Damon Edward
Louisiana Tech University

Cerro, Camilo
American University of Sharjah

Chamel, Olivier Emile
Florida A&M University School of Architecture &
Engineering Technology

Chinellato, Enrico
University of Bologna

Christenson, Mike
University of Minnesota

Cirino, Fernando Mario
FMC Urban Design

Codarin, Sara
LTU

Contin, Antonella Maria Eugenia
Politecnico di Milano

Crabbe, Matthew
Technische Universität Berlin

Daniels-Akunekwe, Chika Chioma
University of Calgary

De Paola, Pasquale
Louisiana Tech University

Deaton, Lyndsey
Clemson University

Del Bo, Adalberto
Politecnico di Milano

Demers, Matthew
Barker Nestor Architects

DeWitt, Erica Radcliff
University of Massachusetts, Amherst

Dreifuss-Serrano, Cristina
Universidad de Lima

Du, Peng
Thomas Jefferson University

El Khafif, Mona
University of Virginia

Elzeyadi, Ihab
University of Oregon

Esmaeili, Nooshin
University of Calgary

Faoro, Daniel
Lawrence Technological University

Farid Mohajer, Mahsa
Stantec

Foroutan Jahromi, Forough
University of Florida

Galili, Lior
Texas Tech University

Gamez, Jose L.S.
UNC Charlotte

Gandara, Andres
Texas Tech University

Gannon, Meghan
Thomas Jefferson University

ARCC 2023 - THE RESEARCH-DESIGN INTERFACE

Garcia, Elisandra
University of Oregon

Geraki, Stefania Palmyra
Palmyra PLLC

Giddings, Bob
Northumbria University

Gopalakrishnan, Srilalitha
Singapore ETH Centre

Graiz, Eiman
The University Of Kansas

Griffen, Craig S
Thomas Jefferson University

Gruen, J. Philip
Washington State University

Guzowski, Mary
University of Minnesota

Hadighi, Mahyar
Texas Tech University

Haglund, Bruce
University of Idaho

Haq, Saif
Texas Tech University

Harris, Catherine Page
University of New Mexico

Hartabela, Dadang
The University of Kitakyushu

Hayes, Richard L
Central Michigan University

Hennebury, Deirdre LC
University of Michigan

Hernandez, Keyla M
Kent State University

Hollengreen, Laura Holden
University of Arizona

Hosseini, Seyedeh Nazli
Tehran University of Art

Houghton, Adele
Biositu, LLC and Harvard T.H. Chan School of Public Health

Hu, Ming
University of Maryland

Hu, Xiao
University of Idaho

Huang, Hao
Texas A&M University

Imai, Nate Shigeo
Texas Tech University

Ingaramo, Roberta
Politecnico di Torino

Iulo, Lisa
Penn State University

Jarrett, Chris
University of North Carolina at Charlotte

Jo, Soo Jeong
Louisiana State University

Jones, Kristin
Illinois Institute of Technology / Studio Integra, Ltd.

Kader, Sharmin
Kent State University

Kio, Patricia Njideka
Texas A&M University

Klinkhammer, Barbara
Thomas Jefferson University

Koester, Robert
Ball State University

Konbr, Usama Abdelnaby
Tanta University

Kucker, Patricia
Penn State University

Li, Xiaowei
Clemson University

Liu, Rui
Kent State University

Louro, Margarida
Faculdade de Arquitetura - Universidade de Lisboa

Lux, Maria Stella
Politecnico di Milano

Machry, Herminia
University of Kansas

Mansy, Khaled
Oklahoma State University

Marks, Frederick
Salk Institute for Biological Studies

Martinez Arias, Andrea Soledad
Universidad de Concepción

Martinez Beltran, Andrea Gabriela
University of Zaragoza

McCormick, Elizabeth
University of North Carolina at Charlotte

McQuiston, Lauren Austin
University of Virginia

McReynolds, Victoria
Texas Tech University

Meek, Christopher Martin
University of Washington

Melhado, Silvio
École de technologie supérieure

Melnyk, Virginia
Virginia Tech

Melsop, Susan
The Ohio State University

Meshkani, Taraneh
Kent state University

Miranda Feltrin, Camila
FAUP

Mistur, Mark Steven
Kent State University

Molarinho Marques, Sara Cristina

Muller, Brook Weld
University of North Carolina at Charlotte

Murphy, Cristina
MSU

Myung, Junyoung
University of Illinois at Urbana-Champaign

Naik, Niyati Sudhir
CEPT University

Nasab, Maxim
FAMU

Nazarian, Shadi
Penn State University

Ncube, Chiko
Oxford Brookes University

Niemiec, Jacklynn
Drexel University

O'Geen, Charlie
University of Michigan

Oghazian, Farzaneh
The Pennsylvania State University

Osayamen, Esosa
University of Massachusetts Amherst

Park, Jinoh
University of Arkansas

Parlac, Vera
New Jersey Institute of Technology

Penvose, Jonathan
Southern California Institute of Architecture

Peterson, Eric
Florida International University

Plowright, Philip David
Lawrence Technological University

Poerschke, Ute
Pennsylvania State University

Polatoglu, Cigdem
Yildiz Technical University

Ra, Seung Kyu
Oklahoma State University

Raab, Peter S.
Texas Tech University

Radnia, Noushin
UNC Charlotte

Ragheb, Ash
Lawrence Tech University

Rashed-Ali, Hazem
Texas Tech University

Read, Gray
FIU

Rider, Traci
North Carolina State University

Ridwana, Iffat
University of Cincinnati

Robinson, Clare
University of Arizona

Robinson, Julia
University of Minnesota

Rockwood, David
University of Hawaii at Manoa

Rossi-Mastracci, Jessica
University of Minnesota

Rueda, Henry
Florida International University

Ruegger, Joerg
University of Utah

ARCC 2023 - THE RESEARCH-DESIGN INTERFACE

Sadiq Garcia, Fauzia
Temple University

Saleeb, Noha
Middlesex University

Santos, Luis
Aalborg University

Santus, Kevin
Politecnico di Milano

Sehgal, Hitakshi
University of Minnesota

Shah, Nadia
Illinois Institute of Technology

Shall, Scott Gerald
LTU

Sharag-Eldin, Adil
Kent State University

Sharag-Eldin, Adiyana
Kent State University

Sheykhmaleki, Pariya
Texas Tech University

Sinclair, Brian Robert
University of Calgary + sinclairstudio inc.

Singh, Manan
University of Florida

Spagnolo, Isabella
Politecnico di Milano

Staub, Alexandra
Penn State University

Tariq, Tasneem
Pennsylvania State University

Thaddeus, David
UNC Charlotte

Torrell, Betty
Morgan State College

Tricarico Orosco, Ana
FAMU

Uihlein, Marci
University of Illinois at Urbana-Champaign

Valente, Ilaria
POLITECNICO DI MILANO

Van de Riet, Keith
University of Kansas

White, Aaron
Mississippi State University

Willoughby, William Thomas
Kent State University

Wu, Chengde
Iowa State University

KEYNOTE SPEAKERS



Marina Tabassum

Marina Tabassum is a Bangladeshi architect and scholar. She is the principal architect of Marina Tabassum Architects. Marina Tabassum Architects (MTA) is an internationally recognized, leading architecture practice based in Dhaka, Bangladesh. The firm was founded in 2005 after her ten-year partnership with URBANA. MTA's work is well regarded in the world as environmentally conscious, socially responsible, and historically and culturally appropriate. Besides building design, MTA invests in extensive research works on the impacts of climate change in Bangladesh, working closely with geographers, landscape architects, planners, and other allied professionals. The focus of work also extends to the marginalized low to ultra-tra-income population of the country with a goal to elevate the environmental and living conditions of people. Marina Tabassum has been the Director of the Academic Program at Bengal Institute for Architecture, Landscapes, and Settlements since 2015. The list of awards includes Lifetime Achievement Award, Soane Medal, Arnold W. Brunner Memorial Prize, and the Aga Khan Award for Architecture, among others.



V. Mitch McEwen

V. Mitch McEwen is an American architect and, urban planner, cultural activist. She is a professor at the Princeton University School of Architecture, where she directs the architecture and technology research group Black Box, exploring mixed human-robotic processes in design and construction. She is the Principal of McEwen Studio and co-founder of Atelier Office, a design and cultural practice working within the fields of urbanism, technology, and the arts. McEwen is a co-founder and member of the Black Reconstruction Collective and a board member of the Van Alen Institute in New York. M. McEwen's design work has been awarded grants from the Graham Foundation, Knight Foundation, and New York State Council on the Arts. Atelier Office projects have been commissioned by the US Pavilion at the Venice Architecture Biennale, Museum of Modern Art, the Museum of Contemporary Art Detroit, and the Istanbul Design Biennial. Prior to founding Atelier Office, McEwen earned experience on complex large-scale projects at the New York City Department of City Planning and Bernard Tschumi Architects, as well as independent collaborations. Hands-on experience includes waterfront development, media zones, museum design, mixed-use neighborhood frameworks, and non-profit community space.



E. Sung Yi

Eui-Sung Yi is a Partner at Morphosis and Director of the NOW Institute. The NOW Institute is dedicated to understanding and improving urban environments. They work with cities, communities, and institutions around the world including Port-au-Prince, Cap-Haïtien, New Orleans, Madrid, and Los Angeles. The institute currently works on growing sustainability through regenerative and urban agriculture in Los Angeles, and on the connection of water, sanitary, and health infrastructures with cultural resilience in Haiti. They are committed to partnering with entities that have limited resources for strategy development and envisioning. They have worked with local and national governments, social and cultural institutions, assisted in community outreach, and tested both trends and hypotheses to find the right way to go ahead. Yi's position as the Director of The Now Institute is a 10-year culmination of research initiatives and speculations with Thom Mayne on emerging urban issues confronting major metropolises and disaster-stricken cities. Collaborating with Mayne, Yi has led graduate research studios in Los Angeles, Madrid, and most recently, Haiti and Cap-Haïtien. Significantly, his team received a PA Award for LA Now: Vol. 3, the first academic publication to be awarded the recognition. The NOW Institute has partnered with many universities, most prominently with UCLA's School of the Arts and Architecture. Other academic partners include UPenn's Weitzman School of Design, MIT, Rice, Syracuse University, Pratt Institute, and Harvard GSD. Since 2019, they run the postgraduate MS Design of Cities at SCI-Arc.

PLENARIES

ARCC will offer three (3) panel discussions during the Conference. The plenaries are intended to provide the conference with a platform on which a distinguished group of experts discuss topics relevant to the conference theme.

PANEL 1:

DESIGN RESEARCH INTERACTIONS: LESSONS FROM PRACTICE

In this session one researcher and one architect from three large firms (HKS, GENSLER and EYP) will team-present their work. They will discuss the methods they use to collaborate, the pitfalls they negotiate and the benefits their partnership brings to the firm and to their clients.

Over the past two decades architectural practice has been called on to be more ‘responsible’, and ‘research-based’. These conditions call for a radical transformation in design thinking where the ability to interact with technical knowledge and scientific evidence becomes necessary. As research becomes accepted as an integral part of design culture, the relationships between research results and practice applications – indeed that between researchers and designers – become paramount.

In this session one researcher and one architect from three large firms (HKS, GENSLER and EYP) will team-present their work. They will discuss the methods they use to collaborate, the pitfalls they negotiate and the benefits their partnership brings to the firm and to their clients.

MODERATOR: Saif Haq, PhD, Professor, Texas Tech University

PARTICIPANTS



Nena Martin, IIDA, NCIDQ Global Workplace Leader

Nena Martin brings more than 25 years of interior architecture and design experience to her role as a global workplace leader. Her leadership and easygoing personality allows her to build strong client relationships and lead large teams of architects, engineers, and designers for all types of clients, including Apple, Google, Facebook, Samsung, as well as professional and financial service companies. She’s been interviewed by Austin Business Journal, CoStar News, and Fast Company. She’s participated as a panelist and speaker for Austin Design Week, Bisnow, LinkedIn, Metropolis, and the University of Texas—Bernard O. Dow Leasing Institute.



Nate Meade AIA, LEED AP Lead Designer, Associate Principal

Cultivating a design concept from sketch to the built environment is what inspires me. And creating meaningful spaces to engage with the community motivates me. I'm an architect, passionate for the creative process. An artist, striving to evoke emotion. And a student, continuously in search of inspiration and improvement.

As a lead designer at Page, it is my role to guide clients through the design discovery process. What are their aspirations and what can design do to support them? I constantly challenge our team to realize the vision of "what's possible?"

I am curious by nature, always asking why. Because of my passion for continuous learning, leading Page's research team comes as a natural extension of my design responsibilities. Through research, we gain a deeper understanding of client,



Camilla Moretti , AIA, ACHA, LSSGB, LEED AP BD+C, Studio Practice Leader, Health Principal

Context, and history. Like a great composer intimately understanding how each instrument produces sound, designers must also understand the various influences on the built environment—technical, social, and environmental—to achieve a harmonious design. That challenge is what gets me up every morning. A native of Brazil, Camilla Moretti's resume includes planning, design and research for large-scale healthcare facilities around the world. A Lean Six Sigma Green Belt, she studies and facilitates workshops on operational, logistical and functional issues to enable the team and user groups to make design decisions that promote operational best practices and evidence-based design strategies. In addition to her project work, Camilla is heavily involved in applied research projects and how they can lead to innovative design. Her work represents over 10 million square feet and more than 4 billion dollars in domestic and international projects. In 2021 she was honored by Building Design + Construction magazine with the 40 under 40 recognition.

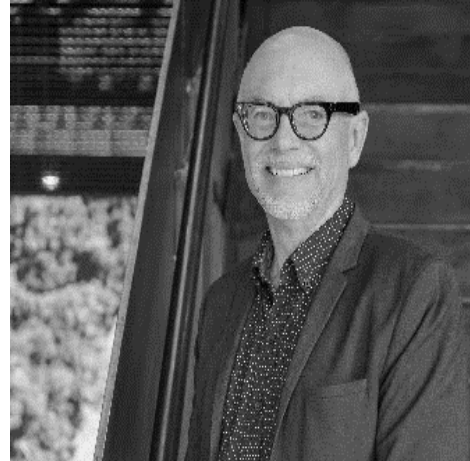

Mike O'Neill, Ph.D.

Dr. Mike leads Data Science Research for the Gensler Research Institute. His long-time research area is understanding the intersection between workplace and employee stress, well-being, and performance. He has decades of research leadership experience in the commercial office industry conducting research and consulting for Fortune 1000 clients and has published three books. His most recent, "The Healthy Workplace Nudge," was a finalist for the 2020 CORENET Global Innovation Award. Mike is a frequent speaker around the US and Europe. sCertified Professional Ergonomist and Six-Sigma Black Belt. He is a member of the Board of Trustees for the National University of Health Sciences, founded in 1906, with a focus on integrative medicine. Mike helps companies identify and track metrics around employee retention, performance, and well-being, and offers practical recommendations to optimize the workplace experience and measure the financial ROI on these outcomes



Justin Shultz PhD, BEMP Lead Building Performance Analyst, Associate Principal

Problem-solving is my passion. Working alongside architects and engineers, I use computational analysis to answer our most pressing sustainable design questions. As a Lead Building Performance Analyst in Building Sciences at Page, I work with clients and design teams to define sustainability goals, develop strategies, and evaluate pathways to success. Let's develop performance-based recommendations through climate, building energy, building envelope, daylighting, glare, and fluid dynamic analyses. With a Ph.D. in Architectural Sciences and a certificate in Building Energy Modeling, understanding complex problems and providing simple solutions has been the aim of my research and career.



Deborah Wingler, PhD Associate Director of Applied Research Principal

Dr. Deborah Wingler's research focuses on improving the patient and staff experience through research studies that elicit insight into patient and staff physiologic, psychologic, and neural responses to high stress healthcare environments. As Principal and Associate Director of Research for HKS, Deborah collaborates with research and design teams to develop and implement research initiatives that drive innovation and achieve a measurable impact across the healthcare practice, globally. Through her research, Deborah has had the opportunity to work with some of the most forward-thinking healthcare organizations, manufacturers, and design firms in the industry to support their respective research agendas.

PANEL 2:

TOWARD A CULTURE OF MATERIAL ENGAGEMENT IN ARCHITECTURE

For this panel discussion, we intend to gather individuals whose multi-faceted work addresses design-research projects at the intersection of architecture academy and practice. These panelists will highlight their workflow, and/or a particular project and elaborate how their focus on the evolving notion of materiality, material culture, and politics of representation would bring together the design and research under the same umbrella within the architecture discipline.

Over the past two decades architectural practice has been called on to be more responsible. These conditions call for a radical transformation in design thinking. As research becomes accepted as an integral part of design culture, the relationships between research results and practice applications – indeed that between researchers and designers – become paramount.

For this panel discussion, we intend to gather individuals whose multi-faceted work addresses design-research projects at the intersection of architecture academy and practice. These panelists will highlight their workflow, and/or a particular project and elaborate how their focus on the evolving notion of materiality, material culture, and politics of representation would bring together the design and research under the same umbrella within the architecture discipline. This will be a 90-minute moderated panel discussion with active participation of the audience.

MODERATOR: Zahra Safaverdi, Assistant Professor, Texas Tech University

PARTICIPANTS



Linda Zhang, OAA, AIA, NCARB, NCIDQ

Linda Zhang is a registered architect (OAA, AIA), interior designer (NCIDQ), drone pilot (RPAS advanced operations), assistant professor of architecture, and co-founding principal at Studio Pararaum (Toronto—Zürich).

She is a 2022 Artist-in-Residence at the EKWC, and 2021-2022 visiting scholar at NYU's A/P/A Institute. Previously, she was the recipient of the 2019 Multicultural Fellow at NCECA, 2017-2018 Boghosian Fellowship at Syracuse University SoA as well as 2017 Fellowship at the Berlin Center for Art and Urbanistics. She currently holds the 2020 Government of Canada's New Frontiers in Research Exploration Tri-council Fund and the 2021 SSHRC Exploration Fund. She was a Dean's Merit Scholar at Harvard GSD where she received the James Templeton Kelley Thesis Prize, and the AIA Henry Adams Certificate. Prior to joining Waterloo Architecture, Zhang was an assistant professor at Toronto Metropolitan University and Syracuse University. Her work has been exhibited and presented internationally in Canada, China, Germany, Korea, Italy, Japan, Netherlands, Spain, the United Kingdom, and the United States, including the London Festival of Architecture, Milan Architecture Design Expo, The Seoul Biennale of Architecture and Urbanism, Toronto Offsite Design Festival and the Canadian Centre of Architecture.



Maya Alam

Maya Alam is an architect, artist, and designer. She is one of the founding partners of A/P Practice and currently holds the chair 'Theory and Discourse of Design' at the School of Architecture and Engineering, Bergische University Wuppertal.

Since 2014 she has taught bachelor & graduate-level architecture design studios and seminars at several universities, including the University of Pennsylvania, Yale University, Syracuse University & the Southern California Institute of Architecture. Alam was awarded the AIA Henry Adams Certificate, a Selected Best Thesis Award, and was the inaugural recipient of the Boghosian Fellowship, the Dekoloniale Berlin Residency, and the Schloss Solitude Fellowship. She has worked in Germany, India, Switzerland, China, Italy, and the United States. Amongst others with P-A-T-T-E-R-N-S, NMDA, UNStudio, and Studio Fuksas. A/P's work has been exhibited internationally at the Smithsonian Institution in Washington, DC (2019), the Anchorage Museum in Alaska (2020) and the A+D Museum in Los Angeles, CA (2018, 2021) among many others.

She have been invited to teach workshops at institutions such as ACADIA - The Association for Computer Aided Design in Architecture and the STRELKA Institute for Media, Architecture and Design in Moscow, Russia and Yale University School of Architecture.



Katie MacDonald, AIA, NCARB

Katie MacDonald, AIA NCARB is a licensed architect, Assistant Professor of Architecture at the University of Virginia School of Architecture, Cofounder of After Architecture, Director of the Before Building Laboratory, and Co-Director of the Hemp Co-Lab at UVA.

Her scholarship has been supported by the AIA Upjohn Research Initiative, the Arnold W. Brunner Grant, the Robert James Eidlitz Fellowship from Cornell University, and the Paul M. Heffernan International Travel Award from Harvard University. After Architecture has completed projects in New York, Pennsylvania, Massachusetts, Vermont, Washington D.C., California, and Europe including a memorial in Washington D.C. and an installation at the Oslo Architecture Triennale 2019 "Enough: The Architecture of Degrowth." For her work at After Architecture, MacDonald has been recognized as "Next Progressive" by Architect Magazine.

Recent accolades include the Research Prize in the Architect's Newspaper Best of Design Awards, multiple AIA design awards, and a Society of American Registered Architects National Design Honor Award. Prior to joining UVA, MacDonald was the 2019-2020 Tennessee Architecture Fellow at the University of Tennessee and Collegiate Assistant Professor at Virginia Tech, receiving the Association of Collegiate Schools of Architecture (ACSA) national Housing Design Education Award in 2020 for her teaching.

PANEL 3:

RESEARCH IN ARCHITECTURAL ACADEMIC SETTINGS: CHALLENGES AND OPPORTUNITIES

A panel discussion with invited Associate Deans of Research examines academia's role in inculcating the culture of research in architecture programs in the US. The panelists will share their experiences, envisioning modern curricula and frameworks to merge design-based pedagogy with the empirical and theoretical streams of investigation. The panel will discuss emerging research fields to respond to challenges such as climate change, social and economic societal inequities, responding to communicable diseases, and adapting to future modes of practice.

The discussants will present the challenges and opportunities facing architecture program administration and explore approaches and solutions with the audience. The objective is to help the architecture field and its allied disciplines develop a clear path for research in architecture academia through faculty development and the creation of modern curricula to prepare students for an ever-changing and exciting future.

MODERATOR: Adil Sharag-Eldin, Kent State University.

ARCC 2023 RESEARCH PAPERS
Planning, Policy & Resilience Track

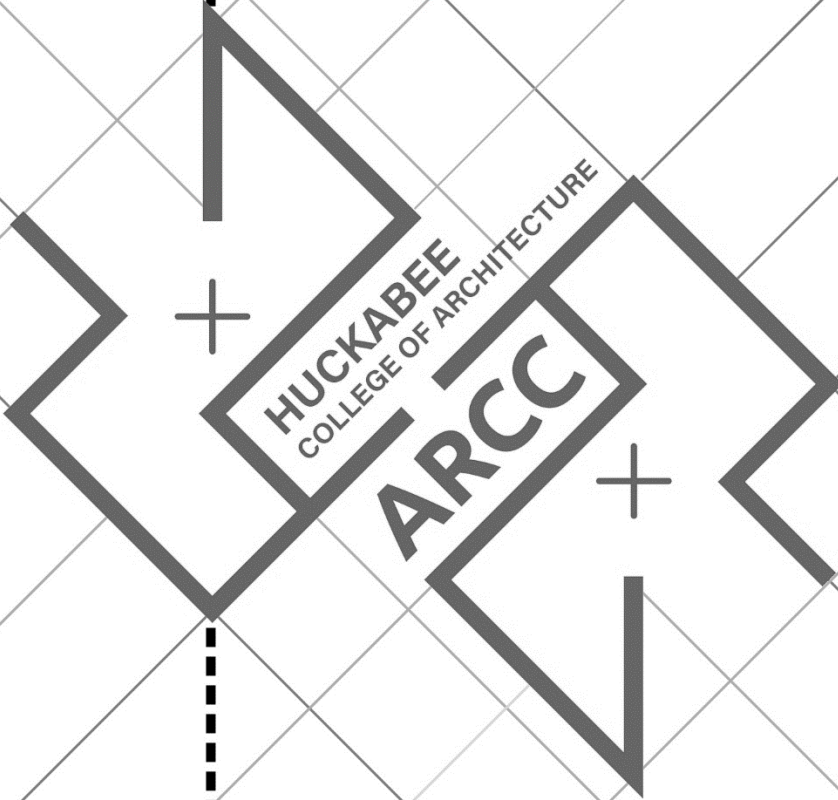

Architectural Anachronism by Culture-based Urban Forms: Chinatowns in the US and Copycat Towns in China

Xiao Hu¹

¹ University of Idaho, Moscow, ID

ABSTRACT: Chinatowns in North America and the Western style copycat towns recently built in China are two unique patterns of the built environment in today's urban contexts – the former emerged as the entry ports of “lands of opportunity” and an ethnic enclave in late 19th and early 20th century and later transformed as a tourist destination for leisure, shopping and entertainment and a symbol of multiculturalism; the latter emerged in many Chinese cities the 1990s to the 2010s featured by buildings, streets and decorations in classic Western styles as a popular approach of new urban neighborhood development, reflecting an effort to marketize places for real estate growth by manipulating culture-based forms. Both have kept producing forms of architectural mimicry that make cultural exotism visible and create the physical features of being “foreign” or “other” from their surrounding contexts. In spite of using different culture-based forms, the two have a fundamental commonality: they seek a strong visual contrast and attempt to promote the idea of being “different.”

This paper qualitatively examines the architectural anachronism through comparing the storybook renditions of symbolic urban forms in Chinatowns and the copycat town. Taking the Chinatown in Seattle and a copycat town in China as examples, this paper introduces the concept of “window” to understand the linkage between physical features of urban forms and the perceived meaning by users. By demonstrating the similarities and differences in the culture-based symbolic urban forms between Chinatowns and the copycat town for the purpose of creating “windows” for cultural exotism, this paper will provide a theoretical framework to understand the capacity of cultural resilience based on the community's changing needs.

KEYWORDS: Culture-based, Form, Exoticism, Window

INTRODUCTION

Ethnic enclaves were products of “spatial sorting” (Lazear, 1999) driven by both the host cities' segregation planning and the individual immigrants' location decisions. In an unfamiliar and hostile environment, new immigrants tended to live closer with their fellow immigrants from the same ethnic group to overcome the barriers for critical information and resources. This “spatial sorting” created an ethnic concentration in a neighborhood that had social and economic structures diverging from those in the surrounding areas while offering a protective effect against a generally hostile climate facing immigrants and ethnic minorities and a pathway for social mobility (Espinoza-Kulick, Fennelly, Beck, & Castaneda, 2021). During the waves of immigration in the US history, there were many ethnic enclaves emerged in the major cities, such as the Little Havana in Miami for Cubans, Little Italy in Manhattan, NYC, South Boston for Irish people, and the Greek Town in NYC.

Chinatowns in North America have emerged as a historically critical and unique urban environment in major cities such as New York, San Francisco, Chicago, and Boston, where multicultural and multiethnic identities become visible through the exotica of urban forms and distinct cultural practices and life patterns. Due to the noticeable differences of physical urban forms and human activities from the established mainstream norms of the host cities, Chinatowns are normally perceived as “foreign” or “other” places separated from their contexts, an ethnic enclave in the city. The “foreign” or “other” places marked both the physical and mental separation from the mainstream American urban contexts, which generated the mysterious and dangerous images of Chinatowns, as represented by Roman Polanski's 1975 film *Chinatown* and Michael Cimino's 1985 film *Year of the Dragon* (Lin, 1998).

Since the 1950s, many ethnic enclaves in the US have experienced significant transformations – some neighborhoods were changed into different ethnic enclaves for new ethnic immigrants or minorities when the old ethnic residents moved out; and some were dissolved and transformed into new commercial /business districts to be a part of expanding downtown centers. However, the Chinatowns seemed to be exceptional from this change (Kwong, 1988). Most Chinatowns remained the centers of economic, social, and cultural lives of local ethnic Chinese communities today. Some scholars considered the consistent arrivals of large numbers of new Chinese immigrants from the 1960s to the 1990s critically contributed to Chinatowns' survival when other ethnic enclaves were struggled in seeing new commers (Lin, 1998; Marcuse, 1997). Some scholars stressed the significance of the “foreign” or “other” characters of urban

forms in Chinatowns that delivered an exotic experience for food, shopping and entertainment of foreign delicacy outside of the mainstream life (Lin, 1998; Klein & Zitcer, 2013; Nguyen, 2011).

Since the beginning of the 21st Century, a new kind of ethnic enclaves has emerged and become prevalent in China. During the past two decades, dozens of new urban neighborhoods have been constructed to replicate towns in Europe and North America, such as a replica of Jackson Hole, Wyoming located outside of Beijing, a German town in the outskirts of Shanghai, a Netherland village in Shenyang, and a twin of Dorchester, England in Chengdu. Most of those developments are located in the suburbs of larger cities but it is not hard to find some cases in China's 2nd or 3rd tier cities. Within those copycat towns, the forms of buildings, structures, and streets are identical to their Western prototypes. The entire built environment appears to have been "airlifted from their historical and geographical foundations" in Europe and North America (Bosker, 2013). Unlike most ethnic enclaves in other places where complicated social, economic, and political forces historically shaped the emergence and growth of those enclave neighborhoods over times, those copycat towns in China are intentionally built in a short period of time to spoof places with imported themes. Also, they are not intended to be used as theme parks but thriving communities where daily lives of local residents will take place. Through the imitated built environment replicating a foreign place, the copycat towns provide a vicarious experience of living in "foreign" or "other" places separated from their indigenous contexts and cultural traditions.

In today's China, there are many buildings that incorporate Western architectural styles and features. However, the trend of developing copycat towns is not only a practice of mimicking the spatial morphology of a foreign place in a much larger scale, but also a process of social construction which treats a place as a commodity by branding the place with symbolic forms. Each copycat neighborhood is a unique example of ethnic enclaves, where the alien sense of a place, or the sense of "foreign" is intentionally created and developed by remaking a place with imported symbols and elements of foreign architecture. As a result, building copycat towns is a strategy of place-promotion to attract incoming people (residents and/or tourists), businesses, and capitals. In the copycat towns, it is the sense of "foreign" or "other" that is more critical than the replication of Western forms, signages, and lifestyle amenities.

In both cases of the Chinatowns in the US and the copycat towns in China, culture-based urban forms play significant roles – Chinese architectural elements in Chinatowns and Western symbols in the copycat towns. They are widely employed because they carry symbolic meanings to represent a "foreign" culture, which is essential for an ethnic enclave. Those culture-based urban forms create the image and experience of cultural exotism that make a place disconnect from its immediate surroundings and contexts and enable the formation of a unique value consumed by people.

Built in a century apart, both the Chinatowns and the copycat towns have highly relied upon symbolic culture-based urban forms to create the image and experience of cultural exotism while different social, economic and political forces have shaped critical differences between the two cases in terms of spatial functionality, representations and identities. In addition, ethnic Chinese people are the targeted users in the beginning of development of both Chinatowns and the copycat towns. However, with the shifting social, economic and political situations in later times, people with more diverse demographic backgrounds join in the user population and start to reorient and renovate major features of the built environment.

Although subjects of architecture in Chinatowns have been well explored in the literature, current studies of cultural representations in Chinatowns tend to view the urban forms as a passive response to outside social, cultural and political forces. In the meantime, although China's copycat towns have been in the spotlights of social media and news reports in recent years, showing the visible tip of the iceberg of an interesting architectural phenomenon, they are still outside of the mainstream scopes of today's urban studies. Bosker (2013), one of the few scholars who studied those copycat towns, considered China's copycat towns were social-cultural products that responded to the social change in China with the rising wealthy middle class attracted by providing visible symbols of success from the West. This paper takes a different perspective to examine the symbolic meanings of culture-based urban forms through the comparison of the two cases -- the Chinatowns in the US and the copycat towns in China. In this study, the culture-based urban forms are compared to see how the idea of "exotic enclaves" have been achieved through the intentionally development of symbolic expressions of built elements from a different culture.

Seattle's Chinatown is a key example that is characterized by shifting images of a well-developed cultural enclave and the changing culture-based urban forms while maintaining a strong manifestation of ethnic Chinese culture. Started as temporary settlements in the 1860s, the Seattle's Chinatown (or the International District, renamed in 1999) is a historic neighborhood featured rich immigrant multiethnic cultures, colorful community lives, and home to many tourism-based amenities and ethnic Asian restaurants and businesses. Today's Chinatown is still the primary home for many immigrants mostly from East Asia, such as Chinese, Filipinos and Vietnamese. It has successfully changed from a segregated urban ghetto to one of the most vibrant and diverse communities in Northwest US.

One China's copycat town, the Thames Town in Songjiang, an outskirts district of Shanghai, is also studied in this paper. This example reflects a major type of copycat towns developed in China: it has been driven by local governmental initiatives and resources as a new strategy to develop satellite cities. The development of the Thames Town has set

up an example for similar approaches of other Western-style towns developed across China in later decade. From the focus of architectural details to the partnership between the public and private sectors, the Thames Town provides many aspects of new town-planning ideas for Chinese developers, authorities and architects in the 21st century.

There are three analysis methods used in this study: 1) systematic review – his study systematically and explicitly examine the building forms from the three cases in the contexts of cultural, social, and historical systems; 2) morphological analysis – this study dissects the complicate meanings of the culture-based into different spatial elements, each of which is qualitatively analyzed; and 3) comparative evaluation – by comparing the similarities and differences of the storybook renditions of symbolic urban forms between Seattle's Chinatown and the two copycat towns in China, this study investigates the development of architectural anachronism in today's architectural practices.

1.0 THE MAKING OF DIFFERENCES BY CULTURE-BASED FORMS

1.1. The Chinatown in Seattle

There are two images of Seattle's Chinatown. The first is a typical historical district close to the Downtown with some old buildings and tons of urban amenities for its residents and visitors. The second is characterized by various forms of Chinese culture, from the color of street-light poles and the unique storefronts to the street signs in foreign languages and decorations and peculiar souvenirs in oriental styles, which promote the cultural pluralism and exoticism of the place. Those urban forms have highlighted something that are visually different from the familiar and known mainstream norms – the Downtown and the surrounding neighborhoods. The visual differences mark the border of the "local" or "we" for the urban center occupied by the white-dominated population and the "foreign" or "other" for the Chinatown occupied by Asian immigrants. Therefore, it is always intriguing to experience the "foreign" or "other" because the exoticism and unfamiliarity deliver an alluring attraction for curiosity.

The differences between the "local" or "we" and the "foreign" or "other" initially can be easily recognized by physical appearances and languages of the populations. More profound understandings of the difference are driven by different patterns of behaviors, cultural practices, and perspectives, most of which can be expressed in the built environment. Like other cities in the US, Seattle has been white dominated since its beginning. It is natural for the white residents to consider themselves to be the norm and the mainstream, the centered "local" or "we" while perceive everything else beyond its central domain as the peripheral "foreign" or "other" (Khan, 2015). In addition, this perception of "local" vs. "foreign" and "we" vs. "other" also implies a sense of positional hierarchy with "local" and "we" regarded as superior and the "foreign" and "other" as inferior. Therefore, the "foreign" forms of Chinese architecture have promoted the widely accepted paradigm of the Chinatown, its residents, and events to be an exotic "others."

The beginning of Chinatowns in North America was a product of anti-immigrant movements in the 1800s and the Chinese Exclusion Act in 1882 (Lin, 1998). The inassimilable difference and the lack of language skills and social support reinforced their spatial marginalization and isolation from their urban contexts. The early urban forms of the Chinatown in Seattle were characterized by a concentration of Chinese immigrants and economic activities within one or more city blocks that formed a unique component of the urban fabric, which created "an idiosyncratic oriental community amidst an occidental urban environment" (Lai, 1988) and started the process of being "foreign" or "other." The first noticeable culture-based urban forms used in Seattle's Chinatown was the physical barriers that carried little cultural meanings or perceptions but was used to mark ethnic difference and cultural isolation for "foreigners" and "others". In the end of the 1880s and beginning of the 1900s, the anti-Chinese sentiment, exclusions from entering certain occupations and discrimination in the labor market led to the Chinese immigrants' concentration into certain retail and service occupations that were generally undesired by ordinary Americans (Lin, 1998).

Like many other Chinatowns in North America, Seattle's Chinatown was formed in a marginal and undesirable land near the Downtown center (Abramson, Manzo, & Hou, 2006). Railroad tracks and industrial warehouses from the west, steep terrain to the north and east, and the undeveloped lands to the south isolated the Chinatown from other urban communities both visually and physically, despite the close distance to the Downtown. The physical barriers that varied in different formats ranging from railroad tracks to harsh topographies made the physical boundary of the Chinatown clearly defined as a "other" place and separated it from its immediate surroundings. This physical isolation not only marked the different social, economic and ethnic status of the residents in the Chinatown and pushed them away from the mainstream society, but also fostered a strongly inward community that served as the cocoon of comfort zone and provided a home feeling to immigrants living there. It was the physical barriers that allowed the ethnic cultural representations to be possible within the Chinatown. Also, due to the Chinatown was physically isolated, the cultural & ethnic built forms of Chinese architecture could survive from the interventions from the outside forces and started to grow into the native urban forms of the Chinatown.

The immediate change of urban forms with the Chinese immigrants' moving-in was the increasing street signs in Chinese characters and store fronts decorated with simple Chinese architectural elements, which reflected the active attempts to attract customers with Chinese backgrounds. They demonstrated the increasing concentration of social and economic activities of Chinese immigrants within the Chinatown. Those early examples of culture-based forms were simple, humble, and attached to existing buildings, which echoed the general socioeconomic status of Chinese immigrants who lacked the economic and social /political resources to afford more complicated culture-based forms.

The Chin Gee Hee Building built in 1889 at the 2nd and Washing Street by rich Chinese immigrants was an important example of how Chinese immigrants responded to being treated as “foreigners” or “others.” This building was the first brick structure in Chinatown finished after the 1889 Great Seattle Fire. Its south façade was featured with a unique balcony that had a simplified Chinese hip roof with two Greek Ionic columns on both sides. This odd combination reflected an early example of grassroots approach towards a more cosmopolitan identity. The Chinese style roof indicated strong ethnic reflections of home culture while the Greek Ionic columns represented the desire of merging into the mainstream society. This example highlighted the dichotomous view hold by many Chinese immigrants: on one hand they wanted to retain their cultural connections to the home, which implied that they acknowledged the imposed identity as the “foreign” or the “other,” different from other residents of the city; but on another hand, they were eager to end the social and physical isolation to join the mainstream, which reflected their acceptance of being socially inferior.

Since the 1920s, residents of the Chinatown had more financial and social resource and more confidence to celebrate their cultural roots. In 1924, the completion of the Chinese Grand Opera Theater marked the first building in the Chinatown designed by a Chinese American architect, Wing Sam Chinn who was born in San Francisco and received architecture degree from the University of Washington (Ochsner, 2017). Its western façade, the main façade, used a simplified form of a traditional Chinese gateway – the façade had its central portion being taller and having more decorations sided by two identical portions, a typical design treatment used in traditional Chinese architecture to highlight the significance of the center. This form celebrated a stronger representation of ethnic elements, reflecting a stronger ethnic consciousness and defining a stronger “foreign” place. This style was also employed by several buildings in Seattle’s Chinatown in later times. In addition, the development of a formal cultural facility for Chinese opera symbolized the fact that the Chinatown also became a center of Chinese immigrants’ social activities.

Since the 1960s, the City of Seattle attempted to remove the social and cultural isolation of the community and celebrate the new development of multiculturalism to promote tourism. With this changing context, the Chinatown was turned into an icon of “foreign” or “other” to be celebrated and protected. In order to demonstrate Seattle’s multiculturalism, the Chinatown should be made more “Chinese” – in another word, to be more “foreign.” Promoting architectural motifs and symbols of traditional China in urban forms becomes more reasonable and necessary.

The Hing Hay Park (Fig. 1) was an example of efforts to commodify Seattle’s Chinatown to be an affordable amusement of visiting a different culture by repackaging the “foreign” and “other” places. As the first formal public plaza within the Chinatown, the Hing Hay Park built in the 1970s was featured an authentic Chinese pavilion in the center and a unique pavement pattern based on the idea of Eight Diagram (Ba Gua), a traditional symbol of Taoism. The culturally based built forms used for the Hing Hay Park promoted the stereotypic image of the Chinatown being “foreign” and “distant”, echoing typical visual perception of China by middle-class and upper-class white tourists.



Figure 1: The Hing Hay Park is featured by an authentic Chinese pavilion. Source: (Author 2018).

After 2000, new developments have continued the effort to reinforce the definition of “oriental otherness.” More full-scale culture-based forms have been employed to sell exotic experience. The construction of an authentic traditional Chinese gateway structure in 2007, the Chinatown Gate (Fig.2), marking the west entrance of the Chinatown is a noticeable example. The 45-foot-tall Chinatown Gate, located at the corner of South King Street and the 5th Avenue,

took the form of a traditional Chinese Pailou archway with authentic ornaments of various Chinese elements, highly similar to those in other Chinatowns in Vancouver, B.C., San Francisco, and Washington D.C. As a result, the border between the Chinatown and the Downtown Seattle was marked by a symbolic ethnic architecture that was used to epitomize a cultural difference to boost local distinctiveness.



Figure 2: Seattle's Chinatown Gate takes the traditional form of a Chinese Pailou archway to mark the border between the Chinatown and Downtown Seattle. Source: (Author 2022).

1.2. Shanghai's Thames Town

In the end of the 1990s, the Shanghai Government made an ambitious and aggressive urban plan to relieve the fast growth of its urban population by constructing nine satellite cities /towns around Shanghai. This plan, titled "One City - Nine Towns," intended to develop ten new cities, including one large urban sub-center (Songjiang New City) and nine urban towns to accommodate 5.4 million residents by 2020 in order to reduce population within the city center and to form a polycentric growth (Shanghai City Government, 2001). According to the plan, each city /town would provide urban infrastructures and amenities, job opportunities, and residences that made a closer linkage among work, live and play. Although there was no evidence of urban sprawl in China comparable to the US case during that time, the plan was highly inspired by the concept of New Urbanism that was prevalent among urban studies and practices in the West. With the ambition of not only demonstrating technically advanced construction for sustainability but also showing the developed urban aesthetics connected to predominantly Western lifestyles, the plan designated different themes to the ten new urban developments (Hassenpflug & Kammebauer, 2010). The theme of Songjiang New City was planned to be built into an English town while other nine towns were designated with different themes, including German town, Australian Town, Spanish Town, American Town, Dutch Town, Scandinavian Town, Italian Town, Euro-American Town, and finally, Chinese Town. This announced the beginning of copycat town development in China.

The government of Shanghai has never released its purpose of building new towns with the Western themes. Among the limited numbers of studies, some scholars attempt to provide explanations. Bosker (2013) considers architectural reproduction or replication is a common practice in Chinese architecture, very different from the Western views of practice. Hartog (2009) sees it as an effort of experiment to establish a theme of a new town in order to promote the sense of a place. Hassenpflug (2010) noticed that the concept of New Urbanism was introduced to China during the period when the One City – Nine Towns plan was being developed. As a result, he concludes that the development of new towns with Western forms is an effort of creating the pictorial representation of the culturally "typical" (he refers to typical American and European styles) urban planning and designs, which satisfies the emerging needs of China's increasing middle-class for modern life.

As a part of effort to make the Songjiang New City to be an English town, the one square kilometer big Thames town (named after the River Thames in southern England) was constructed in the west of the city with the intention of providing residences for 10,000 residents, most of whom were employees of the nearby Songjiang University District. Atkins Group, a British architectural firm, was in charge of planning and designing the Thames Town from 2001 to 2006 where the majority of building forms were low density residences and single-family homes with massive green spaces (60%) and a large lake.

The entire layout and all building forms are unique – none of them can be found in any town (old or new) in China. The Thames Town is modeled after a rural British village in Berkshire or Surrey, filled with architectural forms from a variety of British styles, including Tudor, Victorian, Georgian, Edwardian, and Gothic (Fig. 3). Most buildings are two or three floors tall with the ground floors reserved for commercial or retail uses. Almost all buildings are featured by textured wall surfaces and steep rooflines with many gables facing different directions. A large Gothic church, a replica of the Christ Church in Bristol, England, stands in the center of the town, becoming the most significant landmark of the Thames Town. In order to promote the presence of British ambience, status of famous British figures (historical or fictional), such as Winston Churchill, Shakespeare, Byron, Newton, Princess Diana, David Beckham, James Bond and Harry Potter, are placed around the town and all the streets leading to the church are named after a British town, like Oxford Street, Kent Street, and Gower Street. In addition, all the gated residential complexes also get British-sound names – Victoria Garden, Hampton Garden, Rowland Heights, Kensington Garden, and Chelsea Garden. Even the security staffs dressed like the British Royal Guards with the red jackets, black mandarin collar and gold trimmings, and the black tall cap.



Figure 3: Buildings within the Thames Town borrow architectural forms from different British styles in history. Source: (Author 2019).

In an attempt to create urban public spaces reflecting the historical changes of a British town, the Thames Town defines three centers for public activities with various architectural styles in different eras – the Historical Town Center featured by a Gothic church and an open square (called the Love Square) with buildings in Georgian and Victorian styles, the Waterfront District featured by buildings in red and grey bricks for small scale shops, stores, cafes, restaurants, and pubs, representing early Industrial era, and the Civic Square at the east side of the town, enclosed by more modern facades leading the view to the New Songjiang Sub-Urban Center across the lake.

However, the Thames Town is not just a simple replication of a British town. In contrast, it is a British town made in China. It still reflects many spatial features often employed by urban planning, design, and development in China. One important distinction between neighborhood spaces in China and Britain is the clear separation of private spaces from the public spaces. For example, the majority of the land in the Thames Town is occupied by gated residential complexes, a popular real estate type in China for middle- and upper-class population, where residential uses are well protected within the enclosed complexes through fenced buildings. Inside each residential complex, there is an internal garden and a centered public space used only by the residents of the complex. The connection to the outside public life is only through several secured gates. Gated residential complexes have divided the whole Thames Town into multiple segregated pieces where the British inter-connected streets and neighborhood public spaces are converted into semi-enclosed or enclosed Chinese luxury residences. Within those private luxury residential complexes, most villas and single-family houses are placed along the south-north orientation with inner gardens and centers that can be found in most urban residences in Chinese cities. In addition, buildings that are used to enclose a gated complex are mixed used – the first floor (sometimes including the second floor) are normally used for retail /commercial purposes facing the streets while the upper floors are condo units accessed from the inside of the complex (Fig. 4).

As a result, the Thames Town is not an essentially a replication of a British town. Rather, it is a “Chinese” neighborhood with “British” facades. Symbolic spatial forms are strategically extracted from their British contexts and are purposively repackaged into a Chinese neighborhood. In the Thames Town, the focus is not to make British residential forms to recreate another kind of residence but to make any form that look like “British” to be consumed for commercial /retails purposes. Hence, the British forms and elements are highly concentrated along the major streets where the most public activities are located, while all the Chinese elements are hide behind. By doing so, the Thames Town creates a massive theater set – users move around the three-dimensional built environment filled with symbolic British spatial forms to shop, to play, and to engage with other users. They are the actors of a reality show taking place every day on the main streets of the Thames Town. In the meantime, the real life is also continuing in the backstage areas where the Chinese forms provide supports of daily needs for the Chinese residents.

It is the co-existence of the British forms and Chinese forms at the Thames Town that makes this neighborhood attractive to the targeted Chinese users. To a large extent, the replications of British forms have created an assemblage of architectural images of a British town that satisfies the Chinese users’ fantasy of being in a “foreign” place. However, the sense of a “foreign” place can only be achieved when a sense of “local” also presents. Hence, it is necessary to have the Chinese forms as the spatial carriers to support behaviors and activities that make the Chinese users comfortably stay in their daily life patterns while being visually in a “foreign” place. In addition, the contrast between the British forms and the Chinese contexts has further promoted the sense of “foreign” as the visual features and experience offered by the Thames Town is unique and exclusive. Consequently, a new cultural enclave has been created to offer exotic experience of British some towns.



Figure 4: In the gated communities within the Thames Town, buildings are mixed used – the ground floor is primarily used for retail /commercial purposes while upper floors are residential units. Source: (Author 2019).

The exotic forms at the Thames Town creates an exotic image that makes the exotic experience possible. As Hassenpflug (2010) points out, the Thames Town has immediately become a giant El Dorado of wedding photography site for Shanghai and its surrounding region. Wedding services occupy many stores along the major streets. Every day, dozens of new married or soon-to-be married couples are posing in front of buildings with clear British forms, presenting that they are in a foreign land. Sometimes, couples are dressed in their Western wedding suites taking Victoria carriages clatter around the streets and alleys. The exotic experience is also promoted by exotic cultural practices and life patterns. Hotels, cafes, bars, restaurants, and tea rooms within the town filled with Western food, drinks, furniture, decorations, and signs allow Chinese users to taste a “foreign” experience without physically going overseas. Western art lovers can easy find many exhibitions, presentations, and talks at the two public museums, one public art gallery and multiple private art galleries on a daily base. In 2011, the church at the Historical Town Center, the most outstanding landmark of the town, opened to the public. A public Catholic mass led by priests and attended by hundreds of worshippers and visitors is hold every Sunday afternoon. Thousands of visitors are drawn to stroll around the Thames Town every day, seeking leisure, recreational, and cultural experience within the British style setting.

However, unlike the Disney Resort or Universal Studio, the Thames Town is not a theme park that only draws visitors from the outside. The town is also designed as a home for thousands of residents. Although it experienced some struggles in early years to attract enough home buyers, the population of the Thames Town has gradually increased from 900 in 2008 to 3,500 in 2022 (Jiefang Daily, 2022). There are two grocery stores, one sports center with a large gym, a swimming center, and facilities for basketball, tennis, badminton, and ping pong. There are one post office, two daycares, an elementary school and a middle school. There are two bookstores, a clinic, budget hotels, and many convenience stores and small restaurants. Comparing to many other newly developed urban neighborhoods, the Thames Town provides a far more comprehensive and better infrastructure to meet local residents' daily life needs. The Chinese forms ensure all residents to have their daily lives continue in the Chinese way like any other urban population in any Chinese cities, while the British forms bring the residents a sense of privilege and prestige as there is no other neighborhood in China with the same or similar architectural features. Therefore, the Thames Town is regarded as a luxury neighborhood where the housing cost is more expensive than other places without the Western themes. The residents of the Thames Town also consider themselves are more cosmopolitan and socially competent.

2.0 THE WINDOW OF LINKAGE FOR TWO CO-EXISTENCE WORLDS

As a product of social and spatial segregation, Chinatowns supports the transition of most immigrants to a new place by offering opportunities for housing and jobs through their internal institutions, informal ethnic economy, and culturally familiar urban forms. Being an ethnic enclave, Seattle's Chinatown creates a native authentic home culture in a foreign place to the immigrants, while, at the same time, giving a microscopic view of a foreign culture to the mainstream residents. In the urban center of Seattle, there are two co-existing worlds: the Downtown Seattle and the Chinatown. Although the separation of both is the focus of spatial policies in early times and the main selling point for tourism market in recent times, the Chinatown has always been a place for the contact and engagement of different ethnic groups.

In contemporary China, the Thames Town presents an example of new ideas and strategies for urban neighborhood development, particularly those imported from the West. Besides its British architectural features, the Thames Town indicates some superior features that are hardly found in other new developments in China: lower density, massive green spaces and public spaces, human-scale streets, pedestrian-oriented circulation, and rural style landscaping. It provides a great opportunity for the Chinese architects, urban designers, planners, policy-makers, and developers to learn how to apply the Western design and planning principles to help modernize China's urban spaces. In addition, by employing Western forms, the Thames Town creates a tangible and physical product of a British fairy tale that meets the Chinese users' imagination of what Britain is like and what modern life is like. For British people and Western users, the Thames Town is a fake British town. But for millions of Chinese who have not travelled to the West, the Thames Town is real as it exactly reflects their mental images of a British town.

In Alfred Hitchcock's 1954 movie "Rear Window," the main character, Jeff spent his days and nights watching his neighbors through the rear window of his apartment. The window showed his neighbors' lives as images in a cinema-like view for Jeff. He was the spectator of the film and sat and watched from his chair. Here, Jeff's world co-existed with his neighbors' worlds. Through his window, Jeff stayed in his world while having a limited participation in other worlds by watching. For Jeff, it was not important about what he could see from his window. Rather, it was critical about what he wanted to see, and if he could see what he wanted to see.

As a basic physical spatial element, a window is a divider, defining, separating and linking the inside and outside. Therefore, windows, as a means of spatial element, dissect a space into two different kinds of fragments. It also marks the boundary between the two different spatial fragments. By doing so, windows divide the space users into two different groups, the insiders and the outsiders, according to their physical locations to the window. Windows control the possibility of access. When the windows are closed, the insiders are restricted to be inside while the outsiders stay outside. This paper considers both the Thames Town and Seattle's Chinatown perform as a "window" to deliver an opportunity of linking the two co-existed worlds that both the Thames Town and Seattle's Chinatown are attempting to divide.

As discussed above, with the prevailing references of Chinese forms in the Chinatown and British forms in the Thames Town, a strong Chinese and British imageries are constructed respectively to promote the cultural "difference" and the experience of a "foreign" or "other" place. However, the point of exoticism is not just about having the symbolic forms of Chinese or British elements. Rather, the sense of exoticism can be only achieved when the Chinese forms are placed into an enclave that are surrounded by non-Chinese forms and when the British forms are placed into an enclave that are surrounded by non-British forms. That means that the sense of exoticism can only be achieved through the co-existence of two morphologically different worlds – 1) the Chinatown and the outside world and 2) the Thames Town and its surroundings. What matters is not the Chinatown is a presence of China or the Thames Town is a reference of Britain; but the Chinatown is a presence of China in American contexts, and the Thames Town is built in Chinese soil. This suggests that the non-Chinese outsiders and the Chinatown's surrounding contexts are equally critical to the exotic forms in the Chinatown; the Chinese forms and contexts are highly significant to the exotic experience in the Thames Town. The two morphologically different worlds should be first clearly defined and then linked. Back to Hitchcock's

movie, what interesting was not about Jeff's neighbors' lives, or Jeff's behaviors. Rather, it was about how Jeff could watch his neighbors from his apartment and how we could watch Jeff's behaviors from our world that made the movie attractive.

Through a window, a meaningful linkage between two different worlds can be established. The differences of the two worlds are marked by the comparison of "local" forms in one world and "foreign" forms in another. A window is the interface between the two worlds, which allows people in one world can mainly watch another world. In addition, a window makes it possible for people in one world to have a controlled participation to a different world with convenience and protections, just like we were watching Jeff watching his neighbors from his chair. Therefore, through windows, users can access to exterior scenic views while still staying in safe & comfortable interior; bank tellers and clients can handle businesses while remaining in their own domains; and game players can explore virtual world while still being in the real world.

The Chinatown provide both the outsiders and the Chinese immigrants with a controlled participation in each other's world while staying within their own worlds. The Chinatown acts as a magnet for Chinese foods, gadgets, clothing, souvenirs, arts, and life patterns, offering various opportunities of affordable recreation, shopping, and entertainment that anyone can develop a controlled participation into Chinese culture without shifting their own cultural practices. A tourist can experience some kinds of Chinese culture without physically travel to China. She can order a Chinese noodle in a restaurant and purchases some Chinese gifts from shops in Chinatown. But eventually, she will leave the Chinatown and return to her own world. She can choose if she wants to come back or not in a later time. In the meantime, the Chinatown serves as a safe haven and home for Chinese immigrants to develop their skills, confidences, and wealth that enable them to interact with the outside world. That means the Chinatown prepares Chinese immigrants to be Americans while allowing them to maintain the Chinese cultural practices and identity. They can try to find a job or got to a school outside of the Chinatown. If they do not feel comfortable of being outside, they can always come back to the Chinatown to return to their old lives.

In the Thames Town, Chinese users are given a chance to explore Western customs and traditions without being forced to give up their own cultures and lifestyles. In addition to the visual forms that promote the British sensibility, the Thames Town offers the facilities like shops, café houses, restaurants, galleries, religious spaces, and public spaces that make the Chinese users exposed to the British cultural products and practices without traveling to Britain. With affordable time and cost, a regular Chinese can explore British history in an exhibition in a gallery, tour British architecture by walking around the town, enjoy a cup of cream tea with scones at a tearoom, read a chapter of *A Tale of Two Cities* by Charles Dickens in a quiet corner of the street, and head to a restaurant for a nice meal of fish and chips. No matter if the Chinese user is a visitor to the Thames Town or a local resident, she will eventually return to her Chinese life routine. But she can always choose the time and the format how she likes to engage with the "foreign" culture again next time. For the local residents, the close proximity to a "foreign" culture and the capability of easily switching between the "local" and "foreign" worlds reflect a privilege that is exclusive to those who can only afford to purchase the housing units at the Thames Town. As a result, the physical forms of the British architecture also become the symbols of the wealth and social powers of the residents.

There are four layers of windows found in Seattle's Chinatown and the Thames Town:

1. Delivering exotic experience to tourists and visitors: the Chinese forms in the Chinatown and the British forms in the Thames Town become the window for outside tourists and visitors who seek exotic experience of Chinese and British culture respectively. Through street signs, ethnic architectural elements, and decorations, and the intentionally built ethnic landmarks (like the Chinatown Gate and the Church in the Thames Town), the tourists and visitors can have a controlled exploration by experiencing certain foreign cultural products without travel.
2. Ensuring a controlled cultural exploration to the residents: For the immigrants living inside the Chinatown, the Chinatown serves as the home in a foreign land, offering safety and security and supporting the transition to a new place. In addition to allow the immigrants to identify and access key resources from the inside, the Chinatown also is the window through which the immigrants start to taste American culture and life outside of the Chinatown while knowing there is a cocoon of comfort base to back their explorations. For the residents of the Thames Town, the British forms provide a playground where they can comfortably engage with a "foreign" culture but the Chinese forms at the backstage are the real homes where the essential daily life is taking place.
3. Defining an anomalous and distort format of cultural representation: For the visitors from China, the Chinatown represents a place of cultural anomaly and distortion. In spite of the constructed "Chinese imagery," the Chinatown is still a neighborhood in a foreign setting, which demonstrates how the native Chinese culture is manipulated and changed to fit the perceived image of China by Americans. Therefore, the Chinatown presents a different kind of "foreign" or "other" to the Chinese visitors who are interested in exploring the marriage of Chinese culture and its American contexts. In the Chinatown, there are many buildings that present the ethnic Chinese architectural elements in unusual ways or combine Chinese elements with other non-Chinese elements. An interesting fact is that there is no Thames Town in Britain. The Thames Town is a unique product made in China, although it is designed by British architects. For people from the Britain and the West, the Thames Town is not only a distorted and comical reflection of

British architecture with Chinese elements, but also presents a new way of architectural approach – it treats the entire culture and history of Britain as a grocery store where different products can be picked, ordered, and remade to create a distinctive product that fits the mental image of Britain by the Chinese people.

4. Becoming a means of place branding: Seattle's Chinatown today is becoming a colorful icon of multiculturalism for the city when its unique ethnic architectural forms continuing making it visually and morphologically different from the surrounding contexts. Making the Chinatown more Chinese is not just the need of Chinatown's residents, but also a critical demand of the city. For Seattle, the Chinatown is a symbol of cultural inclusiveness and cosmopolitanism, and an invaluable asset and showcase that celebrates its historical connection to Asia and its achievements of cultural and social diversity. Therefore, the Chinatown is a window that promote the positive image of Seattle.

In Shanghai, the Thames Town is an unprecedented product of a pilot study that introduces new planning and design ideas imported from the West. It is a symbol that highlights the capability and technology advancements of a Chinese city that can not only make new developments in the Chinese way, but also remake an entire Western town and beyond, which becomes the clear evidence of Shanghai's progress. Through the window of the Thames Town, Shanghai is making a powerful statement: it is and will be continuing open to the world and is willing to absorb everything from everywhere.

CONCLUSION

Built a century apart, Seattle's Chinatown and Shanghai's Thames Town have been created and developed by totally different social, political, economic, and cultural forces. Although they are tremendously different in many aspects, they share one thing in common: the two cases have heavily and intentionally employed culture-based forms to create an "ethnic foreignness." Through the one century of enormous changes in Seattle's Chinatown and the recent development of the Thames Town in Shanghai, the symbolic forms of a foreign culture are borrowed, repackaged, and represented to highlight the visual and morphological differences of the place.

Since the sense of differences primarily come from the visual and morphological differences, it is critical to pick spatial forms that can be easily recognized as a representation of a foreign culture. Therefore, the two cases are not simply a replication or a fake representation of the foreign culture. Rather, certain spatial forms are carefully chosen from the assembly of architectural symbols from the whole history. There is no Chinatown in China and there is no Thames Town in Britain. Both cases make a distinctive way to combine different architectural forms from a foreign culture for the creation of an exotic place. From this point, both the Chinatown and the Thames Town are the original creation.

In both cases, the local forms are a significant integral part of the place, just like the foreign forms. The local forms contribute to creating a "local" world that is visually and morphologically different from the "foreign" world defined by the "foreign" forms. Only through the constant comparison between the local and foreign forms, can the Chinatown and the Thames Town successfully deliver the exotic experience to the users. Hence, both cases perform as a "window" where two visually and morphologically different worlds are divided but co-exist.

Both the Chinatown and the Thames Town also play the role of a window by linking the two opposite but co-exited worlds with providing the opportunity to participate in another world in a controlled manner. The culture-based forms allow users mainly in one culture to explore a foreign culture with affordable time and cost. More importantly, the exploration is well controlled by the mixture of the local forms and the foreign forms.

REFERENCES

- Bosker, B. (2013). *Original Copies: Architectural Mimicry in Contemporary China*. Hong Kong: Hong Kong University Press.
- Espinoza-Kulick, M. A., Fennelly, M., Beck, K., & Castaneda, E. (2021). Ethnic Enclaves. In L. Spillman, *Oxford Bibliographies*. New York: Oxford University Press. doi:DOI: 10.1093/OBO/9780199756384-025
- Hartog, H. (2009). Shanghai Towns: Searching for Community and Identity in A Sprawling Metropolis. *the 4th International Conference of the International Forum on Urbanism (IFoU)*, (pp. 1379-1386). Amsterdam.
- Hassenpflug, D., & Kammebauer, M. (2010). *The Urban Code of China*. Berlin: Walter de Gruyter GmbH.
- Jiefang Daily. (2022, Oct. 21). *The Thames Town becomes A National Model*. Retrieved from Shanghai Observer: <https://www.shobserver.com/sgh/detail?id=884756>
- Khan, S. (2015). "Otherness" of Ethnic Enclave Attractions in Multicultural Cities: A Study of Chinatowns and Little India. *Asia-Pacific Journal of Innovation in Hospitality and Tourism*, 4(1), 63-76.
- Klein, N., & Zitcer, A. (2013). Everything but the Chickens: Cultural Authenticity Onboard the Chinatown Bus. *Urban Geography*, 46-63.
- Kwong, P. (1988). *The New Chinatown*. New York: Hill & Wang.
- Lazear, E. (1999). Culture and Language. *Journal of Political Economy*, 107(S6), 95-126.
- Lin, J. (1998). *Reconstructing Chinatown: Ethnic Enclave, Global Change*. Minneapolis, MN: University of Minnesota Press.

- Marcuse, P. (1997). The Enclave, the Citadel, and the Ghetto: What Has Changed in the Post-Fordist U.S. City. *Urban Affairs Review*, 33(2).
- Nguyen, V. (2011). Chinatown: The Neoliberal Remaking of Culture in the Contemporary City. *Advocates' Forum*, 25-31. Retrieved from https://crownschool.uchicago.edu/sites/default/files/uploads/AdvocatesForum_2011_web.pdf
- Shanghai City Government. (2001). *The City Government's Memo of Issuing the Document of Pilot Projects to Improve Shanghai's Urbanization*. Shanghai.

Beyond “still standing”: A proposed framework for schools to intentionally support community resilience after disasters

Traci Rose Rider¹

¹North Carolina State University, Raleigh, NC

ABSTRACT: According to NOAA’s National Centers for Environmental Information, 20 weather/climate disaster events hit the United States in 2021 including droughts, flooding, severe weather, and wildfires, with losses exceeding \$1 billion each. While schools are identified by the Department of Homeland Security as one of 18 critical infrastructure sectors under Homeland Security Presidential Directive 7, resiliency guidelines speak about the continuity of the learning environment, not support of the larger community during a disaster’s aftermath.

Using a frame of situated resilience, this paper argues that movements toward resilience must be rooted in situated systems where the sociocultural issues can be observed, which aligns with the concept of community-supportive design. While there are guidelines around building resiliency, these plans do not equally focus on the needs of the larger community during the aftermath of the disaster. Beyond design for accessibility or public interest design, a situated resilience approach activates the civic structures in resilience planning and mitigation. Important considerations for this impact on community resiliency include both design strategies as well as the AEC community knowledge base.

Groat and Wang’s logical argumentation methodology supports the synthesis of *design for resilience* with *design for community support*, taking “conceptual systems that, once framed, interconnect previously unknown or unappreciated factors in relevant ways.” This approach outlines the school as a leverage point in larger community resiliency systems; the planning, design, construction, operation, and evaluation of community schools can inform, cultivate, and engage a broad range of physical and social resources to ensure improved quality of life in times of disaster or hazards. The AEC industry knowledge base around resilience strategies, as well as around community resiliency needs, is also addressed. A relationship between the two approaches is proposed for further development and testing, and appropriate methodologies are identified.

KEYWORDS: school design, resilient design, logical argumentation, design framework, disasters

INTRODUCTION

The goal of this inquiry is to work toward the creation of a design framework and evaluation metrics for establishing schools as intentionally designed resources in community disaster planning and mitigation, particularly in under resourced communities. While schools are seen as critical infrastructure and may utilize disaster mitigation guidelines depending on location and municipality, these infrastructure roles are not synthesized with the needs of community support at the building scale after disasters (see Figure 1). As natural and manmade disasters increase across the globe, a methodology is needed to position schools as key resources in supporting local disaster preparation, response, mitigation, and recovery. While the larger frame of this research is to establish frameworks, guidelines, and metrics for designing and assessing community schools, this paper will focus on the framing, considerations, and a proposed methodology for further development.

1.0 LITERATURE REVIEW

There is relatively little literature on how school facilities support communities in the wake of natural disasters (Long, 2017). As noted by the National Research Council (2009), “Although such [ecological] frameworks have existed for some time and there has been a growing call for research to take a ‘cumulative risk’ approach, systematically measuring or assessing the full continuum of stress is rarely done in practice or across disciplines and sectors together.” As such, this literature review explores the complementary but largely unsynthesized fields of ecological resiliency and community supportive design.

1.1. Ecological resiliency

While a number of guidelines for the built environment have been proposed and published over the last decade (Rajkovich and Holmes, 2021; Boshier and Chmutina, 2017; Eskew Dumez Ripple, 2014), most work at the macro scale; few of these frameworks apply to the level of communities to understand the larger concept of community resilience. Despite pushes for community engaged design, these efforts are often “for” the community, not “with” the

community (Jackson, 2016); while rigorous engagement certainly does occur, more often engagement is superficial. For example, while the work addressing coastal resilience is plentiful, guiding policy and design decisions applicable to nearly half of the country’s population, there is an issue with diffusion: despite a wealth of guidance, communities are struggling with transferring these resilience frameworks into action (Acosta, Chandra & Madrigano, 2017). This exploration seeks to further bridge the notable gap between theory and application in resilience.



Figure 1: Differing approaches to primary school buildings. Image by author.

1.2. Schools as community support

A few schools are starting to be designed for disaster resilience, such as for tornadoes in Greensburg, Kansas. Similarly, some schools around the country are being designed in tandem with community centers for intentionally supporting under-resourced communities. However, even fewer schools are being designed to intentionally serve both purposes – disaster resilience and holistic community support – an incredible missed opportunity for AEC industries who have such an impact on both environmental and social outcomes. A holistic approach to school design from planning to end-use and evaluation can provide valuable insight and rigor to complex, interdisciplinary design problems with a focus on disaster support in vulnerable communities.

In terms of popular school resiliency issues, the U.S. Government Accountability Office (GAO) focuses on threats of cyber-attacks while the National Education Association (NEA) addresses the continuous quality of the physical environment to support meaningful learning. Other initiatives, such as the Resilient Children/Resilient Communities (RCRC) Initiative at Columbia University’s National Center for Disaster Preparedness (NCDP), address the continuity of care for children when a disaster strikes, focusing on the children as the vulnerable population (RCRC, 2019). However, requirements for safety strategies designed into the school building is at the jurisdiction of the local counties or states. None of the tools provided in the RCRC Toolbox address the initial design, continued operations, and evaluation of the schools, especially as they may support the larger community in crisis beyond providing normalcy for children. In its 2017 publication *Safer, Stronger, Smarter: A Guide to Improving School Natural Hazard Safety*, FEMA (2017) recognizes that school buildings also serve as defacto community centers when needed. “[Schools] often serve as designated shelters for displaced families after a natural or manmade disaster...” The document is targeted to be a “comprehensive document for school administrators and staff, as well as concerned parents...” but does not mention the stakeholders and designers that are responsible for creating the spaces in the first place - - and who continues to create similar projects around the country. Most of the published guidance around school hazard safety is for operations and retrofitting facilities; there is no guidance for stakeholders and project teams as new schools are being built or majorly renovated. Though other building types are already used for disaster relief, including stadiums and sports halls, many of our most vulnerable rural communities are without these facilities to fall back on when disaster strikes. There are, however, schools everywhere.

Traditionally the building design and construction process starts with knowledge that focuses narrowly on the design team’s own experience and expertise, without extensive insight from either theory or user perspectives (Bilandzic & Venable, 2011). While design teams do have client representatives as the voice of building users, the design process often ends with very little direct end-user engagement; engaging entire communities around proposed projects is even more rare. In truth, many practitioners are not clear on what “socially-engaged” means in the AEC industries (Schneider, 2018). Most literature on community engagement in design is from the perspective of design education, not application in practice (Kee, 2016; Portschy, 2015). A true community-engaged, participatory-action research design process is rare. No evidence-based literature is found on designing buildings of varying programs (beyond intended shelters) for disaster response to support the community, from the community’s perspective. Additionally, schools are indeed often used to support community activities beyond educating children such as voting, food distribution, and more, depending on the community. However, these activities are byproducts of the larger spaces found in schools, not a product of the design intentions themselves.

A critical gap exists around how schools can serve communities and populations beyond their basic programming, and how social programs and school facilities can expand to intentionally support community resilience in the event of a hazard or disaster (Long, 2017; Stanley, 2022). The AEC industries are exceptionally well-suited to identifying and solving problems like these at various scales and for various stakeholders. Acknowledging the role of the built environment as an underutilized tool, this exploration seeks to realign school design with resilience through the lens of community support during disasters and hazards.

1.3. AEC knowledge base

Design and construction process traditionally focuses on space needs, site context, and restraints like building code requirements. AEC industries most often refer to an accrued knowledge base reflective of historical processes and familiar industry standards (Lam, 2000). In the case of disaster-prone areas, additional design requirements would be found in local building codes (PEER, n.d.; TAMU, 2015; Henson, 2018). While some building rating systems such as U.S. Green Buildings Council's Leadership in Energy and Environmental Design (LEED) have begun to address resiliency (USGBC, 2019), they are voluntary and are still focused on environmental impact strategies, not larger community resiliency, or even resiliency in general. There are rating systems in place for hazards, though these systems typically focus on a particular hazard like an earthquake and emphasize on preventing damage to structures in these particular events, like a fire or flood (Simpson, 2008).

While there is little literature or empirical research on how knowledge evolves in the AEC industries, or this specific Community of Practice (CoP), experience shows that a shift in process – and considering issues traditionally outside the scope of the AEC industries, like health or resiliency – is slow. For example, the USGBC launched LEED over 20 years ago and the built environment is still staggering in its environmental impact today. Further, in 2017, only 400 out of 20,000 architecture firms in the United States were participating in the AIA's 2030 Commitment to carbon neutrality by 2030 (Cramer, 2017). Though the participating number has increased (at the time of submission) to 1,117, that only accounts for approximately 5% of practices in the country. No data is found on AEC industry attitudes around resiliency or adapting of resiliency strategies in projects, or about the levels of knowledge around resiliency in the AEC community.

This conversation parallels those around scientific literacy in education literature, which address conceptual knowledge and competencies of scientific theories (Laugksch, 2000; Holbrook and Rannikmae, 2009). Understanding a group's level of scientific literacy – or in this case the AEC industry's literacy around resilient design strategies – can easily be thought to be measured as a sum of all individual knowledge. However, case study research indicates that this type of literacy could be seen collectively (Roth and Barton, 2004); this view would largely depend on having enough collective and distributed resources that community members can work together toward a common goal of improvement (Roth and Lee, 2002). While LEED and other rating systems serve as a metric and clearinghouse for sustainable design strategies, there is not a parallel source for resilient design. However, fitting for the AEC industries, Dewey's theory on education and building knowledge recommends an interdisciplinary curriculum to grow and apply specific understandings of specialized information (Toolshero, 20220), effectively building shared community knowledge. AEC industries mirror this interdisciplinary practice, growing understanding between team members and peers around best practice as tacit knowledge in praxis. As such, understanding the state of this tacit knowledge related to resiliency in the AEC industries – and what resources are needed to increase this knowledge - is paramount in supporting community resiliency.

1.4. Building evaluation

The post-occupancy evaluation (POE), the most common means of building evaluation, was developed as a process to assess how a building was meeting occupant needs and supporting well-being (Li, Froese and Brager, 2018). However, this evaluation method is rarely implemented (Watson, 2020), and certainly does not consider issues beyond the scope of the systems found in the building itself, much less the appropriateness of disaster relief and mitigation. Similarly, POEs focus on the immediate users and those that interact with buildings daily, not the community at large (Preiser, 1995). However, school environments can impact entire communities, particularly if viewed as critical infrastructure for disaster relief and mitigation. Given appropriate framing, these community facilities can be intentional from conception, building on a strong knowledge base around disaster planning and resilience, beyond one building's ability to simply remain standing and functioning. This exploration hopes to contribute to a rigorous evaluation framework for schools to utilize in terms of both resilient design and community resiliency during times of disasters.

2.0 THEORETICAL FRAMEWORK

There are a variety of meanings, attributes, and uses of the term *resilience* across fields, particularly between natural and social sciences (Olsson, et al., 2015). By its very nature, the school as a facility is at the center of a Venn diagram between these fields (see Figure 2); the building must respond to ecological issues as a structure while serving as a social institution. As such, this exploration places itself at the intersection of two definitions of resilience: (1) Ecology: the ability of a system to absorb change while keeping stable (Holling, 1973), and (2) Social: the ability of communities or groups to adapt and decrease risks to decrease social disintegration (Adger, 2000). This study conceptually bridges the two approaches; the design of the school should be informed by ecological resilience theory but must support community resilience when finished. This approach, though similar, is different that the social-ecological systems (SES)

resilience theory (Colding and Barthel, 2019), where social-ecological systems are closely linked in interaction. While this is fundamentally the case when considering a larger system, the focus on and function of the specific school building can be seen as keeping the two spheres of *ecology* and *social* intact; the design speaks to *ecology* while the use speaks to *social*. In the wealth of theories that try to bridge the two, the community-centeredness of this exploration fits best with *situated resilience* (Cote and Nightingale, 2012), explained below.

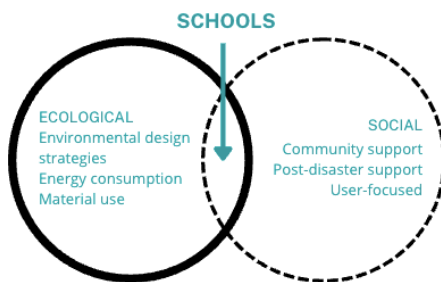

Figure 2: Venn diagram with schools at the intersection between Ecological and Social spheres. Image by author.

Regarding AEC practitioners' resilience literacy, resilience has not been formally taught to most currently practicing. Instead, the knowledge is grown through informal distribution, commonly shared among individuals either in the project teams or in the AEC industry as a whole. In other words, there is a collective knowledge and way of doing things in AEC organizations that addresses resiliency (Tsoukas, 1996; Larsen, 2001) – processes and strategies - particularly grouped by building type such as schools. Sociocultural learning theory holds that knowledge is rooted in interactions between individuals situated within social settings through collaborative knowledge building (Brown and Duguid, 2001; Hewitt and Scardamalia, 1998), such as communities of practice focusing on school design. These two theories – *situated resilience* and *collective knowledge* - create the foundation for the framing of this exploration.

2.1. Situated Resilience

This exploration is positioned under the situated resilience theory as outlined by Cote and Nightengale (2011). This approach argues that efforts toward resilience must be rooted in situated systems where the sociocultural issues and social relations of power impacting decision-making can be observed (Ibid.). In design of the built environment, this speaks to creating designs specifically for the needs of a particular community, which we have established is rare. AEC practitioners may argue that this theory could be about designing for a particular ecosystem, which happens more regularly, but that approach misses the very important point of social relations. Situated systems specifies that the concept of agency, while integral to discussions of vulnerability, is relatively nascent in studies around resilience (Miller et al., 2010), again referring to the engagement of the social. In other words, moving resilience forward, particularly in under-resourced communities that are most threatened, will necessitate a decisive shift from 'output-directed to process-oriented research that sees knowledge as co-produced' (Cannon and Müller-Mahn, 2010). This type of design, as likely seen in community-based schools, will concentrate on design processes for social/collective learning, reflection, and planning but through a resiliency lens (Tschakert & Tuana, 2013).

Overall, situated resilience advocates for a need to “analyze the adaptive capacity of social-ecological systems that involve different sets of stakeholders at various scales, with multiple approaches to resource valuation and leadership, and the heterogeneous social networks of relations that underlie and shape management practices.” (Cote and Nightingale, 2011) As established, the AEC industries are exceptionally well-suited to identifying and solving problems at various scales and for various stakeholders – but only if the problem is seen to be within their purview. The situated resilience approach to exploring how resilient strategies work for community members at large resonates well with intentions of community-design and post-occupancy evaluations from the AEC industries.

2.2. Collective Knowledge

In industry, the evolution of capabilities often relies on the industry's histories and the heterogeneity of their knowledge bases (Jacobides and Hitt, 2005); an industry's knowledge base is often largely contingent on collective knowledge (Kogut and Zander, 1992; Tsoukas, 1996), as mentioned previously. In organizational studies, collective knowledge “refers to the ways in which knowledge is distributed and shared among members.... It is the accumulated knowledge... stored in its rules, procedures, routines and shared norms which guide the problem-solving activities and patterns of interaction among its members.” (Lam, 2000, p.491) Given the history and tradition of AEC industries, it is unsurprising that routines and shared norms dominate processes, using tacit knowledge as the industry foundation. Previous studies on architecture show firms are more likely to embed the production of knowledge within their praxis; they are less likely to perceive growing knowledge as a distinct activity (ScotMARK, 2005). In other words, AEC industries learn incrementally by doing and sharing experiences. The knowledge of the AEC industries is collective.

Understanding, much less measuring, the growth of community knowledge is novel in AEC industries. The concept of Community of Practice (CoP), or those who share a passion and grow knowledge as they interact regularly (Wenger,

1998), is not rigorously explored in AEC fields; any research of CoP in architecture is relegated to discussion of teaching and higher education (Morton, 2012). This paper suggests that measuring collective knowledge around resiliency, and how the body of knowledge grows, both within particular design teams (micro) and in national AEC communities of practice (macro), is imperative.

3.0 METHODOLOG(IES)

The overarching goal of this exploration is to work toward establishing an empirically based design guideline and evaluation metrics to position schools as intentional resources in community disaster planning and mitigation, particularly in under resourced communities. Logical argumentation research (Groat and Wang, 2002) observes a series of shared attributes: broad systemic applicability, paradigmatic innovation, a priori argumentation, and testability. In process, this paper explores the ideas of the ecological resiliency of the school and the community resiliency support provided by the school (see Figure 1) through broad systemic applicability; both frames can be applied to civic projects that are integral to communities. By exploring these two different approaches to the “resiliency” of schools that traditionally address disconnected considerations, and connecting them in a unified framework, the developed discourse can extend into a different paradigm for what schools can - and should - be. The notion that school design impacts both ecological environments and community resiliency is an a priori principle key to developing the argument; as such, environmental and social consequences and supports of a school can be identified and assessed. Finally, the resulting framework, or theory, can be tested to impact normative standards in school design, altering praxis and enabling the theory to be community-based and action-oriented. This paper follows this logical argumentation methodology.

As a part of the proposed framework and data collection, a multiple case study research design would be most suited to build this type of theory (Eisenhardt, 1989) focusing on questions framed in How and Why (Yin, 2017). Establishing theory through case studies is particularly appropriate for topics without a solid knowledge base (Eisenhardt, 1989). Because there is little research done on how community schools provide support in instances of disasters, a mixed method grounded theory approach would be used to develop a framework for further research (Corbin and Strauss, 2014; Creswell, 2013). This approach assumes “that all of the concepts pertaining to a given phenomenon have not yet been identified, at least not in this population and place. Or, if so, the relationships between the concepts are poorly understood or conceptually undeveloped” (Corbin and Strauss, 2014). Theories generated through this process closely fit with gathered data, are useful, have conceptual density, show durability over time, are modifiable, and are explainable (Glaser and Strauss, 1999; Glaser, 1978; Charmaz, 2006, Eisenhardt, 1989). Lynham’s (2002) four phases of applied theory building are similar (see Figure 3); this applied theory building process has defined stages of theory development to guide the data gathering and analysis process. The methodology would establish a coherent and informed theoretical framework around the phenomenon of focus (Lynham, 2002).

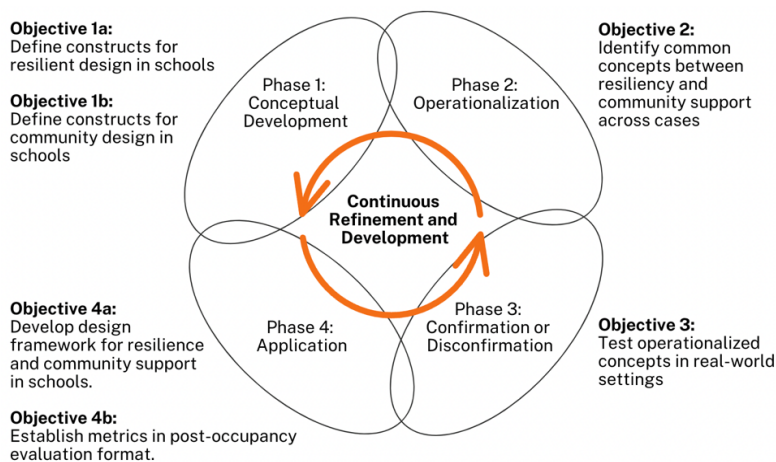

Figure 3: Applied Theory Building (Lynham, 2002) with project objectives.

This methodology would address the challenge of climate change by conceptualizing, operationalizing, and measuring the opportunity for new and renovated schools to intentionally contribute to community resiliency, addressing both the building design and the industry that creates those designs. Using a theory-building through multiple case study design (Eisenhardt, 1989), the framework uses 4 phases of applied theory-building (Lynham, 2002), aligned with 6 research objectives (see Figure 4). Two groups serve as bounded cases: schools that have experienced notable natural disasters and have rebuilt, and schools intentionally designed to serve under resourced communities. The methodology establishes a convergent mixed methods design, engaging in qualitative and quantitative data collection and analyses simultaneously (Creswell and Creswell, 2017). This framework uses qualitative research methods, including surveys, interviews, and site visits for extreme cases to understand and describe the case contexts and chosen resilience strategies in several community contexts. Quantitatively, a national survey of AEC teams measures attitudes,

perspectives, and strategies around resiliency, as well as the collective knowledge around resiliency in the AEC community. In addition, a survey to the designers of selected cases will ask about specific needs of the communities, selected strategies implemented in the designs, and essential community functions provided by schools during disasters. Taken together, these data collection methods could measure the collective knowledge base of the AEC industry around resiliency, and iteratively develop and test a conceptual model and metrics for resilient school design intentionally supporting communities post-disaster.

3.1. Case selection

A daunting list of natural disasters occur annually in the United States including winter storms, droughts, heat waves, floods, tornadoes, cyclones and hurricanes, and severe storms (NOAA, 2022). Some locations are susceptible to more than one hazard. States in the plains, such as Kansas and Oklahoma could see tornadoes, heatwaves, and winter storms, while coastal areas like New Orleans or Miami will likely experience hurricanes and flooding, as well as heat waves. While coastal territories are at risk for these hazards, they are also home to 40% of the U.S. population, compounding potential devastation.

With the goal of identifying (1) common approaches to planning and design for disaster relief and (2) intentional support of surrounding underserved communities, purposeful case selection provides for information-rich cases and the most effective use of resources (Patton, 2014). Two types of schools have been identified: (1) schools designed with disaster resiliency in mind, and (2) schools designed to intentionally increase community support. This pairing allows for the opportunity to identify common processes, strategies, or considerations across the two types. Working closely with design teams for selected projects will ensure access to projects, processes, documents, school leadership, and project goals (Patton, 2014), and enable survey distribution to measure the working knowledge base around resiliency.

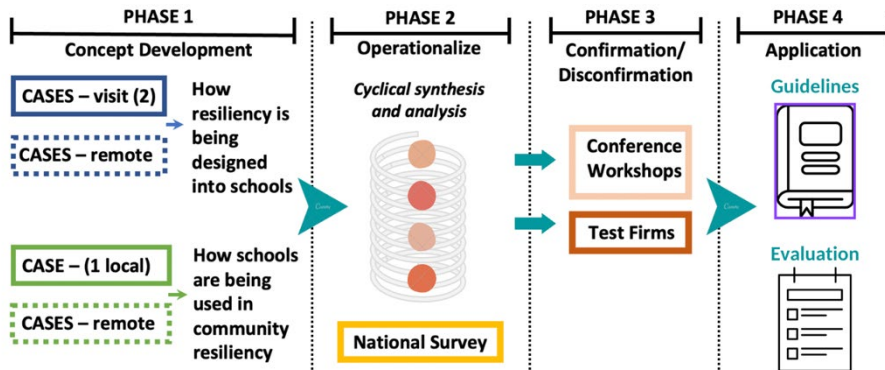

Figure 4: Research methods diagram. Image by author.

The central phenomena of interest in this framework are (1) the professional AEC knowledge base around resilient design, (2) the design process for schools through lenses of resiliency and community support, and (3) project evaluation in supporting communities. A social constructivist perspective emphasizes multiple realities and complexities of particular worlds and perspectives (Creswell, 2013), sitting well with the situated resilience theory adopted by this exploration. It is important to understand not only the direct experiences of the participants (designers, users, and stakeholders), but also to dig deeper and understand the knowledge bases, situations, and considerations from their perspectives, in addition to emphasizing and understanding hierarchies, opportunities, and communication in the process of design (Creswell, 2013).

A series of bounded case studies within their real-life context are proposed to use mixed methods in establishing a thorough understanding of the cases, using the applied theory-building process (Lynham, 2002) to identify transferable theory and application. Creswell & Creswell (2017) identify this approach as “a type of mixed methods study in which quantitative and qualitative data collection, results, and integration are used to provide in-depth evidence for a case.” They also note that the most popular strategy is a convergent design (Creswell and Creswell, 2017), which allows both types of data to contribute to building a “more nuanced and complete understanding” of the case (Curry and Nunez-Smith, 2015); convergent design would be suggested for this approach. The research plan is structured in four phases in line with Lynham’s applied theory-building process (see Figure 4).

3.1.1. Facilities designed around resiliency

To understand as many considerations as possible while still being efficient with data collection, extreme cases should be prioritized and included. These cases should have experienced notable disasters in the recent past and have rebuilt schools with those in mind. Suggestions for regional locations include the Midwest and Gulf Coast, two locations that are susceptible to every disaster listed above: winter storms, droughts, heat waves, floods, tornadoes, and severe storms are found in the Midwest, and the Gulf Coast is susceptible to heat waves, floods, cyclones and hurricanes, and severe storms.

3.1.2. Facilities designed around community

A series of hybrid school/ community center projects around the country have been intentionally designed for community support. These types of projects can be found in Raleigh, NC (Southeast Raleigh Elementary School/ YMCA); Atlanta, GA (KIPP Woodson Park Academy and YMCA Early Learning Center); Louisville, KY (Norton Commons YMCA/Elementary School); and Lincoln, NE (Philip H. Middle School & Fallbrook YMCA).

3.2. Data collection

Data collection around both types of projects should include in-depth interviews with the design teams, owners, and stakeholders. Specific focus should be on resiliency goals, responsibilities for achieving those goals, and documentation of the integrated design process. Transcribed interviews should be analyzed through a within-case analysis (Creswell, 2013), with coding for themes from resilient design literature (Rajkovich and Holmes, 2021; Boshier and Chmutina, 2017; Eskew Dumez Ripple, 2014).

Quantitative data could be gathered through a preliminary online survey, which could also guide interviews, focusing on knowledge generation, experience, and perceptions. Online surveys for the design teams and school administration would help to identify primary views, perspectives, and attitudes toward resiliency, specific needs, and implemented strategies, as well as which essential community functions (housing, employment, education, and public services) are addressed through the design speaking to resiliency (Feng et al., 2017). The AEC practitioners' survey should also include questions about the community of practice. The surveys would be analyzed with descriptive statistics; regression analysis could identify potential relationships between perspectives, knowledge, and implemented strategies; and analysis of variance testing (ANOVA) would look for differences between cases.

Qualitative data collection should be through surveys, focus groups, interviews, and site observations (Patton, 2014). Building on results from surveys, semi-structured interviews should be conducted with administration and design teams to deeply understand the relationships of design strategies with the view of and needs around resiliency in the communities served. On site observations for exemplary cases would be beneficial to focus on design processes, strategies, and transferrable design elements. Observations such as these would help to triangulate data received from surveys and interviews, providing additional insight into the use (existing and anticipated) of spaces. This qualitative data could be analyzed using grounded theory coding (Charmaz, 2006) and constant comparative methods (Corbin and Strauss, 2014; Patton, 2014). This type of analysis would allow for the identification of themes within cases across the different data collection methods, as well as to detect commonalities across cases. NVivo (QSR International Pty Ltd., 2020) or a similar software would be used to conduct the qualitative analysis. Initial mixed methods work would provide context for the design and an empirical basis for understanding the AEC team's knowledge. Qualitative work will inform the quantitative work by offering context and details and help to triangulate the findings.

CONCLUSION

This type of a cross-disciplinary, translational framework can be transformative for design research, particularly in the applications of both built environments and resiliency in under resourced communities, bridging a gap between design processes, built environments, and impacts. This type of exploration would contribute to an empirically justified theory that shifts the paradigm around intentions and impacts of designed environments, moving from the goal of a useful individual school to holistic community-resilience. This approach would link resiliency theories with design theories, identifying in-practice strategies for different scales of impact. This framework would allow design teams to operationalize and understand their processes and the final building's opportunity to contribute to resilient communities. This thread of research is new, encouraging the community school to be more than just a school, but to be an integral part of community survival in the face of increasing natural disasters and hazards. These new methodologies would provide AEC industries a new way in which to evaluate their projects and continue to grow, further supporting life-long learning in informal contexts (NRC, 2009). The advances from this type of exploration will encourage the AEC fields to embark upon new research questions and evaluation theories applicable to resiliency in practice in new and renovated projects.

REFERENCES

- Acosta, J. D., Chandra, A., and Madrigano, J. 2017. *An Agenda to Advance Integrative Resilience Research and Practice: Key Themes From a Resilience Roundtable*. Santa Monica, CA: RAND Corporation. https://www.rand.org/pubs/research_reports/RR1683.html. [Accessed 16 June 2022].
- Adger, W. N. 2000. *Social and ecological resilience: are they related?* Progress in Human Geography, 24(3), 347–364. <https://doi.org/10.1191/030913200701540465>
- Bilandzic, M. and Venable, J. 2011. *Towards participatory action design research: adapting action research and design science research methods for urban informatics*. Journal of Community Informatics. 7 (3).
- Boshier, L., and Chmutina, K. 2017. *Disaster risk reduction for the built environment*. Hoboken, New Jersey: Wiley Blackwell.
- Brown, J. S., & Duguid, P. 2001. *Structure and spontaneity: knowledge and organization*. Managing industrial knowledge: Creation, transfer and utilization, 44-67.
- Cannon, T. and Müller-Mahn, D. 2010. *Vulnerability, resilience and development discourses in context of climate change*. Natural Hazards, 55(3), pp.621-635. <https://doi.org/10.1007/s11069-010-9499-4>

- Charmaz, K. 2006. *Constructing Grounded Theory: A Practical Guide through Qualitative Analysis*. 1st edition. London; Thousand Oaks, Calif: SAGE Publications.
- Colding, J. and Barthel, S. 2019. *Exploring the social-ecological systems discourse 20 years later*. Ecology and Society 24(1):2. <https://doi.org/10.5751/ES-10598-240102>
- Corbin, J. and Strauss, A. 2014. *Basics of qualitative research: Techniques and procedures for developing grounded theory*. Thousand Oaks, Calif: SAGE Publications.
- Cote, M. and Nightingale, A. 2011. *Resilience thinking meets social theory*. Progress in Human Geography, 36(4), pp.475-489. <https://doi.org/10.1177/0309132511425708>
- Cramer, N. 2017. *The climate is changing. So must architecture*. Architect. https://www.architectmagazine.com/design/editorial/the-climate-is-changing-so-must-architecture_o [Accessed 21 July 2022].
- Creswell, J. W. 2013. *Educational research: Pearson new international edition: Planning, conducting, and evaluating quantitative and qualitative research*. Upper Saddle River, NJ: Pearson Higher Ed.
- Creswell, J.W. and Creswell, J.D. 2017. *Research Design: Qualitative, Quantitative, and Mixed Methods Approaches. 4th Edition*. Thousand Oaks, Calif: SAGE Publications.
- Curry, L., and Nunez-Smith, M. 2015. *Mixed methods in health sciences research*. Thousand Oaks, Calif: SAGE Publications. <https://dx.doi.org/10.4135/9781483390659>
- Eisenhardt, K. 1989. *Building Theories from Case Study Research*. Academy of Management Review, 14(4), pp.532-550.
- Eskew Dumez Ripple. 2014. *A framework for resilient design*. Eskew+Dumez+Ripple. New Orleans, LA: Eskew Dumez Ripple. <https://www.eskewdumezripple.com/assets/pdf/Fellowship/A%20Framework%20for%20Resilient%20Design.pdf> [Accessed 21 July 2022].
- FEMA. 2017. *Safer, Stronger, Smarter: A Guide to Improving School Natural Hazard Safety*. <https://www.atcouncil.org/docman/fema/306-fema-p-1000-safer-stronger-smarter-a-guide-to-improving-school-natural-hazard-safety/file> [Accessed 19 July 2022].
- Feng, K., Wang, N., Li, Q., and Lin, P. 2017. *Measuring and enhancing resilience of building portfolios considering the functional interdependence among community sectors*. Structural Safety, 66, 118-126. <https://doi.org/10.1016/j.strusafe.2017.02.006>
- Glaser, B. G. 1978. *Theoretical Sensitivity: Advances in the Methodology of Grounded Theory*. 1st edition. Mill Valley, Calif: The Sociology Press.
- Glaser, B. and Strauss, A. 1999. *The Discovery of Grounded Theory: Strategies for Qualitative Research*. New Brunswick: Routledge.
- Groat, L. and Wang, D. 2002. *Architectural Research Methods, 2nd Edition*. Hoboken, NJ: Wiley.
- Henson, B. 2018. *South Florida's Hurricane building code is strong—And North Florida's could be stronger*. Local Weather Forecast, News and Conditions | Weather Underground. <https://www.wunderground.com/cat6/South-Floridas-Hurricane-Building-Code-Strong-And-North-Floridas-Could-Be-Stronger> [Accessed 18 July 2022].
- Hewitt, J., and Scardamalia, M. 1998. *Design principles for distributed knowledge building processes*. Educational psychology review, 10(1), 75-96.
- Holbrook, J., and Rannikmae, M. 2009. *The meaning of scientific literacy*. International journal of environmental and science education, 4(3), 275-288.
- Holling, C. 1973. *Resilience and Stability of Ecological Systems*. Annual Review of Ecology and Systematics, 4(1), pp.1-23. <https://doi.org/10.1146/annurev.es.04.110173.000245>
- Jackson, E. 2016. *Balancing resilient design and community engagement. Let's Go Further*. Washington D.C.: NCARB - National Council of Architectural Registration Boards. <https://www.ncarb.org/blog/balancing-resilient-design-and-community-engagement> [Accessed 27 June 2022].
- Jacobides, M. G., and Hitt, L. M. 2005. *Losing sight of the forest for the trees? Productive capabilities and gains from trade as drivers of vertical scope*. Strategic Management Journal, 26(13), 1209-1227.
- Kee, T. 2016. *An emerging community-engaged paradigm in architectural and design education*. The International Journal of Design Education, 10(3), 21-33. <https://doi.org/10.18848/2325-128x/cgplv10i03/21-33>
- Kogut, B. and Zander, U. 1992. *Knowledge of the firm, combinative capabilities, and the replication of technology*. Organization Science, 3, 383-397.
- Lam, A. 2000. *Tacit knowledge, organizational learning and societal institutions: An integrated framework*. Organization Studies, 21, 487-513.
- Larsen, J. N. 2001. *Knowledge, human resources and social practice: the knowledge-intensive business service firm as a distributed knowledge system*. Service Industries Journal, 21(1), 81-102.
- Laugksch, R. C. 2000. *Scientific literacy: A conceptual overview*. Science education, 84(1), 71-94.
- Li, P., Froese, T. M., & Brager, G. 2018. *Post-occupancy evaluation: State-of-the-art analysis and state-of-the-practice review*. Building and Environment, 133, 187-202. <https://doi.org/10.1016/j.buildenv.2018.02.024>
- Long, C. 2017. *Public Schools Offer Shelter from the Storm*. NEA. [online] Nea.org. Available at: <<https://www.nea.org/advocating-for-change/new-from-nea/public-schools-offer-shelter-storm>> [Accessed 17 July 2022].
- Lynham, S. A. 2002. *The general method of theory-building research in applied disciplines*. Advances in Developing Human Resources, 4(3), 221-241. <https://doi.org/10.1177/15222302004003002>

- Miller, F., H. Osbahr, E. Boyd, F. Thomalla, S. Bharwani, G. Ziervogel, B. Walker, J. Birkmann, S. Van der Leeuw, J. Rockström, J. Hinkel, T. Downing, C. Folke, and D. Nelson. 2010. *Resilience and vulnerability: complementary or conflicting concepts?*. Ecology and Society 15(3): 11. [online] URL: <http://www.ecologyandsociety.org/vol15/iss3/art11/>
- Morton, J. 2012. *Communities of practice in higher education: A challenge from the discipline of architecture*. Linguistics and Education, 23(1), 100-111.
- NOAA National Centers for Environmental Information (NCEI). 2022. *U.S. Billion-Dollar Weather and Climate Disasters*. <https://www.ncei.noaa.gov/access/billions/>, DOI: 10.25921/stkw-7w73. Accessed July 17, 2022.
- National Research Council (NRC). 2009. *Learning in Informal Environments: People, Places, and Pursuits*. Bell, P., Lewenstein, B., Shouse, A. W., and Feder, M. A., Eds.
- Olsson, L., Jerneck, A., Thoren, H., Persson, J. and O'Byrne, D. 2015. *Why resilience is unappealing to social science: Theoretical and empirical investigations of the scientific use of resilience*. Science Advances, 1(4). <https://doi.org/10.1126/sciadv.1400217>
- Patton, M. 2014. *Qualitative Research and Evaluation Methods. 4th Edition*. Thousand Oaks, CA: SAGE Publications.
- PEER - Pacific Earthquake Engineering Research Center. n.d. *Expected earthquake performance of buildings designed to the California Building Code*. California Alfred E. Alquist Seismic Safety Commission. https://peer.berkeley.edu/sites/default/files/peer2019-05_ssc19-01.pdf. Accessed July 18, 2022.
- Portschy, S. 2015. *Design partnerships between community-engaged architecture and academic education programs*. Pollack Periodica, 10(1), 173-180. <https://doi.org/10.1556/pollack.2015.10.1.17>
- Preiser, W. 1995. *Post-occupancy evaluation: how to make buildings work better*. Facilities, (13)11; 19-28.
- QSR International Pty Ltd. 2020. *NVivo* (released in March 2020), <https://www.qsrinternational.com/nvivo-qualitative-data-analysis-software/home>
- Rajkovich, N. B., and Holmes, S. H. 2021. *Climate adaptation and resilience across scales: From buildings to cities*. New York, NY: Routledge.
- RCRC. 2019. *Resilient Children/Resilient Communities Initiative*. New York, NY: National Center for Disaster Preparedness. <https://ncdp.columbia.edu/microsite-page/resilient-children-resilient-communities/rcrc-home/> [Accessed 18 July 2022].
- Roth, W., and Lee, S. 2002. *Scientific Literacy as Collective Praxis*. Public Understanding of Science, 11, 33-56.
- Schneider, T. 2018. *Chapter 1: What If ... or Toward a Progressive Understanding of Socially Engaged Architecture*. In F. Karim (Ed.), *The Routledge Companion to Architecture and Social Engagement*. (11p). Routledge. <https://doi.org/10.4324/9781315712697>
- ScotMARK. 2005. *Architecture Research and the Profession in Scotland: A research study for the Royal Incorporation of Architects in Scotland*. London: RIAS.
- Simpson, D. M. 2008. *Disaster preparedness measures: A test case development and application*. Disaster Prevention and Management: An International Journal, 17(5), 645- 661. <https://doi.org/10.1108/09653560810918658>
- Stanley, A. 2022. *How extreme weather has created a disaster for school infrastructure*. The Washington Post. <https://www.washingtonpost.com/magazine/2022/04/13/climate-school-migration/>
- TAMU. 2015. *State and local building codes: Coastal Resilience*. <https://coastalresilience.tamu.edu/home/introduction-to-coastal-resilience/legal-framework-for-planning/stateandlocal/building-codes/> Accessed July 18, 2022.
- Toolshero. 2022. *John Dewey theory*. toolshero.nl <https://www.toolshero.com/change-management/john-dewey-theory/> [Accessed 17 July 2022].
- Tschakert, P. and Tuana, N. 2013. *Situated Resilience: Reframing Vulnerability and Security in the Context of Climate Change*. In J. Dugard, A. L. S. Clair, & S. Gloppen (Eds.), *Climate Talk: Rights, Poverty and Justice* (pp. 75-96). Juta and Company.
- Tsoukas, H. 1996. *The firm as a distributed knowledge system: A constructionist approach*. Strategic Management Journal, 17(S2), 11-25. <https://doi.org/10.1002/smj.4250171104>
- USGBC. 2019. *LEED resilient design pilot credits brief*. Washington D.C.: U.S. Green Building Council, Policy Briefs. <https://www.usgbc.org/resources/leed-resilient-design-pilot-credits-brief> [Accessed 18 July 2022].
- Watson, Philip. 2020. *The Uncomfortable Truth about Post-Occupancy Evaluation*. The Architects' Journal (blog), July 21, 2020. <http://www.architectsjournal.co.uk/news/opinion/the-uncomfortable-truth-about-post-occupancy-evaluation>.
- Wenger, E. 1998. *Communities of practice: Learning, meaning, and identity*. Cambridge University Press. <https://doi.org/10.1017/CBO9780511803932>
- Yin, R. 2017. *Case Study Research and Applications: Design and Methods*. 6th edition. Thousand Oaks, CA: SAGE Publications.
- Wingo, W. 1963. *Automation's Impact*. The Science Newsletter, 84(18), 278.

Communities- Pilot Study for User Acceptance and Early Data Collection

Sanaz Sadat Hosseini¹, Mona Azarbayjani¹, Hamed Tabkhi¹

¹ University of North Carolina at Charlotte, Charlotte, NC

ABSTRACT: Poor access to public transportation is a major contributor to inequity and socioeconomic mobility in low-income communities. In low-income workers who rely heavily on public transportation, spatial disparities between home and work result in higher unemployment, longer job search times, and longer commute times. This paper addresses an extremely important long-term challenge to the accessibility of public transportation, particularly public bus transit, for the underserved and low-income communities in West Charlotte. The ultimate goal is to create a demand-responsive public transit system to efficiently meet dynamically changing daily transit demands and address ways of using existing equipment to provide real-time information about passenger loads at bus stations, bus locations, and arrival times. This paper aims to gather preliminary data that will enable us to develop an efficient, connected, coordinated, and demand-responsive public bus system that minimizes transit gaps in low-income, transit-dependent communities. As part of the effort, this paper evaluates the current CATS mobile applications in order to help passengers find bus routes and times. Our community survey methodology includes a questionnaire about the current bus system of the city of Charlotte with regard to a specific bus line and finding out potential user acceptance for future new smart technology. Using real-world transportation data, the Sprinter bus line connecting Charlotte's downtown with the Charlotte Douglas International Airport is selected for a pilot study. According to the primary survey results, the current bus system along the studied route has many flaws, the most important being the lack of timely service. It has been identified that long waiting times at stations and long commutes are the most common problems. In addition, the existing mobile application doesn't provide accurate information, and 90 percent of those surveyed are inclined to use new technology and mobile applications.

KEYWORDS: Public Transit, Artificial Intelligence, Wellness, Equity and Accessibility, Smart Technology, User-Acceptance.

INTRODUCTION

In a study, Charlotte ranked fiftieth out of the largest fifty cities in the U.S. in terms of opportunity for socio-economic mobility (Covington 2018). Lack of access to adequate public transportation is a significant component of this problem in Charlotte. While the city has expanded light rail service, low-income neighborhoods often only have access to bus services and this service typically requires multiple line changes to move between low-income residential areas and parts of the city where job opportunities exist (Figure 1). Sectors such as industry, shipping and handling, and similar jobs tend to be in other sections of the city, requiring workers to make multiple transfers via the bus system to travel between home and work. Half of the bus routes in Charlotte have average headways or intervals between buses of more than 45 minutes and there are multiple transfers via the bus system to travel between home and work due to the varying locations of some industries in the city (Brough, Freedman, and Phillips 2020).

The radial configuration of Charlotte's bus system requires residents from low-income areas to travel first to Center City where job density is high (but concentrated around banking and financial industries) and then transfer to other lines serving areas with more low-skill, low-wage jobs. The social equity challenge signifies the importance of securing transportation for low-income residents who often perform service jobs and are highly dependent on public transportation ("Electric Vehicles Research by IDTechEx" n.d.).

The west side of Charlotte not only represents low-income households with poor proximity to healthcare and other amenities but also indicates a pronounced transit gap. This gap is calculated as the difference between the rate of transit-dependent population (demand) and public transit supply with significant gaps. The data is extracted from a study on transit deserts in the city of Charlotte and Charlotte/Mecklenburg Quality of Life Explorer (Chetty et al. 2014; Tirachini and Cats 2020). In addition, we observed a strong correlation between (1) low-income communities, (2) poor proximity to low-cost health care, and (3) transit gaps.

To address this spatial disparity in "West Charlotte " which lacks adequate critical services and amenities as well as adequate public bus service to job-dense areas, this proposal aims to understand the demand-supply gap of public transportation and services for the low-income communities.

The overarching goal of this research study is to get initial data that would result in creating a connected, coordinated, demand-responsive, and efficient public bus system that minimizes transit gaps for low-income, transit-dependent communities. To create equitable metropolitan public transportation, this seed research makes initial steps evaluating the CATS mobile app, collecting data to understand the demand and transit gap of a pilot study-Sprinter Line, which connects Charlotte City Center to Charlotte International Airport. The study proposes steps to understand how much users are willing to use a demand-responsive new technology and a smart application in the future.

1.0 LITERATURE REVIEW

To overcome the public transit gap, many cities around the world are transitioning to smart transportation systems that respond to demand (Diab, Badami, and El-Geneidy 2015; “Transport, Data Analytics and AI: Why Tfl’s Latest Initiative Is Good News - Technology Services Group” n.d.; “Smart Public Transport – Key to Solving the Urban Challenge - Telia Company” n.d.; “NextBus TM Real-Time Passenger Information” n.d.; “A Multi-Agent Reinforcement Learning Approach for Bus Holding Control Strategies” n.d.; “AI-Controlled on Demand Bus Services Planned in Japan | Telecom Asia” n.d.).

On-demand buses controlled by artificial intelligence (AI) are a new and innovative approach to public transportation that depend on passenger requests submitted through smartphone apps. The AI utilizes these requests to create routes in real-time, which are then optimized using deep learning techniques that gather operational data on passenger destinations and traffic conditions. This leads to more efficient bus operations in the long run. Passengers can conveniently book their rides via their smartphones and pay for them using credit cards. Encouraging the use of these intelligent transportation systems and enhancing public transit can encourage people to reduce their dependence on personal cars and contribute to the development of more efficient and sustainable transportation systems in urban areas (“AI-Controlled on Demand Bus Services Planned in Japan | Telecom Asia” n.d.).

A few early studies have examined demand-responsive public bus transit that uses data analytics to optimize scheduling and minimize passenger wait times (“A Multi-Agent Reinforcement Learning Approach for Bus Holding Control Strategies” n.d.; Moosavi, Ismail, and Yuen 2020; Chen et al. 2012; Yu, Yao, and Yang 2010; Sun et al. 2019; Koh et al. 2018; Gkiotsalitis and Kumar 2018; Nannapaneni and Dubey 2019; Morales, Muñoz, and Gazmuri 2020). A study by (Koh et al. 2018) examined Mobility-on-demand ride-sharing services in a densely populated area of Singapore. The study examined dynamic bus routing (DBR). The project demonstrated that dynamically routed buses can be an efficient mode of mass transit, and may even hold significant advantages over existing fixed routes (Koh et al. 2018).

Next Mobility Co Ltd (Next Mobility JV), a Japanese company that operates on-demand buses under artificial intelligence controls, is another example of smart on-demand bus systems. Many public passenger road transportation providers in Japan often encounter difficulties in developing efficient and sustainable services due to the lack of profitability and drivers. Issues such as parking shortages, traffic congestion, and inadequate public transportation options are also prevalent in the region. To tackle these concerns, AI-controlled services are being offered (“AI-Controlled on Demand Bus Services Planned in Japan | Telecom Asia” n.d.).

To replace fixed-schedule transit services, some cities in the United States have adopted on-demand options. For instance, Wilson, a small town in North Carolina, has replaced all five scheduled bus routes with on-demand services that locals can request through a smartphone app. In Dallas, Texas, riders can also schedule rides via an app or phone call, and they can be picked up and dropped off within a specified zone for the same cost as a one-way bus pass (“Charlotte Considers Replacing Some Low-Ridership Buses with on-Demand Service | UNC Charlotte Urban Institute | UNC Charlotte” n.d.).

Charlotte has also recognized the necessity for a new intelligent approach. The city's public transit system is facing challenges in attracting bus riders back post-COVID. To address this issue, officials are considering incorporating more on-demand options and replacing some low-ridership, fixed-schedule routes with services that passengers could request on-demand. This is part of a CATS pilot project that aims to provide low-income bus riders with an Uber-like service to get to their desired location. A potential partnership with ride-share companies and bike and scooter services is also being explored. The initiative aims to reduce travel time and address the issues that riders have reported (“CATS to Integrate On-Demand Services, Expand to Low-Income Neighborhoods” n.d.).

The outcome of our study and survey on West Charlotte and one of the primary bus lines in the region have revealed extensive insights into existing ridership issues and the level of people's willingness to adopt the suggested technologies in the future.

2.0 METHODOLOGY

As previously stated, the paper seeks to address an extremely important long-term challenge on the accessibility of public transportation, specifically bus transit, and spatial mismatch in "West Charlotte," which lacks sufficient critical services and amenities, as well as adequate public bus service to job-dense areas, for the underserved and low-income

communities. Thus, the main target communities of this project are commuters, who are often transit-dependent, in service, and live in affordable housing in West Charlotte.

The testbed will focus on the Airport Sprinter bus line that connects downtown Charlotte (City Centre) to the Charlotte International Airport. The bus route provides west Charlotte residents with access to jobs, health services, and grocery stores in the uptown area. Also, it serves workers who live in low-income housing developments and have to commute downtown in order to work at the airport. We're seeking to discover current bus issues and other traveler-reported problems with this bus line and its services, and based on this, we will determine users' willingness for future changes and improvements on the bus system, through an on-demand bus system and also its supporting technology as a new mobile application.

As part of the study procedure, we conducted an in-person pencil-paper survey among 30 commuters on the Sprinter bus line with a closed multiple-choice questionnaire. To gather information, the research team interacted with bus line passengers at the bus stop locations. These passengers have been provided with a paper-pencil survey to complete. Our goal in this study is to know people's concerns about the use of buses. We posed the questions: given an advanced mobile application in the future that could provide a wide range of options to ensure the best route and station according to their final destination at a preferred time – a technology that would respect their privacy – “*how willing are you to use this new technology?*”.

The survey consists of 20 multiple-choice questions that take between 5 and 10 minutes to complete. The majority of people we asked to fill out the questionnaire for this research were willing to cooperate with us. Except for those who were rushing to board the bus. The questions related to the Sprinter bus line are in four separate parts. The first part is related to identifying demographic information of participants in the survey; such as people's age ranges, their place of life in Charlotte, and their range of income level. The second part is about recognizing concerns and issues regarding their travels on the Sprinter buses. The questions in this section are mostly related to identifying the shortcomings and problems in the current bus transportation system. The third portion of the questionnaire is related to assessing the level of customer satisfaction with the currently available mobile applications of CATS buses. Finally, in the fourth part, after providing a written explanation about the hypothetical smart connected system and the new technology, the user's opinion on upgrading current mobile applications or creating superior technology and bus systems in the future (based on their demand) is asked in the form of questions.

The analysis of information and data in this project will be both quantitative and qualitative. Regarding the review and analysis of survey questionnaires, statistical analysis tools for multiple-choice questions and qualitative analysis for descriptive questions will be used.

3.0 RESULTS AND FINDINGS

In this section of the paper, we are discussing our survey results for the study location, section by section, and question by question, trying to find the relation between all data which has been gathered from the questionnaires and our study's primary goals and questions.

As mentioned in previous sections, the survey from the Sprinter bus line has been taken from 30 passengers of this bus. The Charlotte Sprinter bus line as a direct route to the airport has its own passengers that are using the bus for different reasons.

3.1 Part One: Demographics Questions

There are four different demographic questions in the first part of the questionnaire and in this section, we will examine and analyze the questions and their results one by one. As mentioned in Table 1, most of the participants in this survey (about 23%) were 55-64 years old, although after this group, the second rank in age; is for people between 25-34 years old, which accounted for twenty percent of all participants. Also based on the survey results, about 73% of participants were men, using the Sprinter bus for different purposes. According to Figure 1. a, most of the participants live in the west and north Charlotte and as we had predicted, these people are from the underserved community.

Finally, the last question of this section is about the income level of participants, which indicates that most of the income levels are between less than \$12,550 to \$45,000; and these results are validating indicators of our prediction about riders using the Sprinter bus line who are predominantly from the underserved communities of Charlotte, with low-income levels, every day facing the transit gap existing in the city. The results are shown in Figure 1. b.

Table 1: Participants' age range. (Author 2022)

Age Ranges	18-24	25-34	35-44	45-54	55-64	65-74	75 or above
Percentage of Participants	13.33%	20.00%	16.67%	13.33%	23.33%	13.33%	-

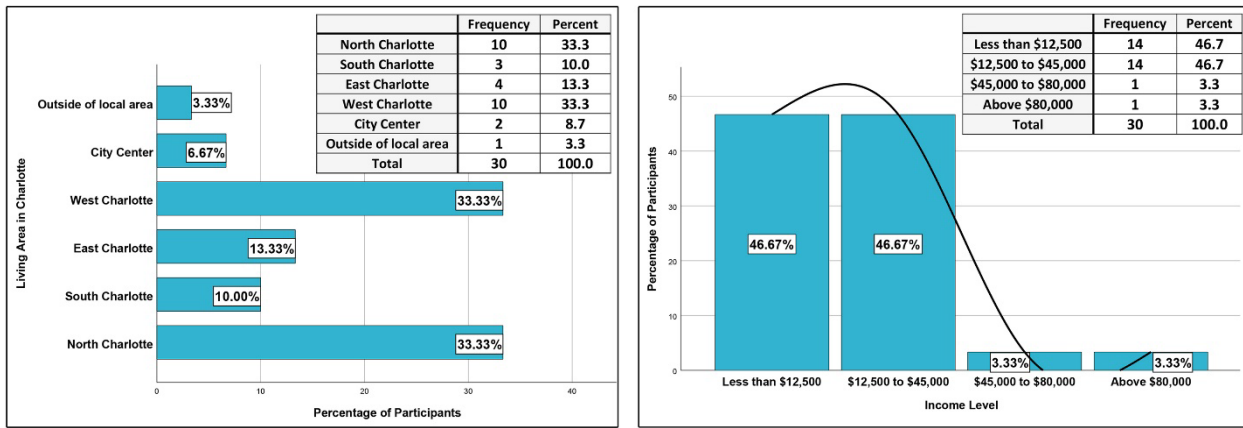

(a) Participants living area in Charlotte - (N:30) (b) Participants income level - (N:30)

Figure 1: Section one of the questions - Demographics. (Author 2022)

3.2 Part Two: Questions Related to The Quality of Travel by Bus

The main part of the questionnaires deals with questions about user experiences of buses and identifying issues with the current bus system. Our survey results show that 60.0% of participants use the bus daily as their primary mode of transportation thus demonstrating that it is indeed a highly in-demand bus line for its passengers.

The bus route extends from the city center of Charlotte to the CLT airport through the southwest of Charlotte. Which means that it does not have full coverage in other parts of the city. So, according to Figure 2. a, 63% of passengers are using another bus to reach the Sprinter bus station. This issue illustrates the existing transit and service gap in the northern and western parts of Charlotte that causes people to spend a lot of time on their daily travel/commute.

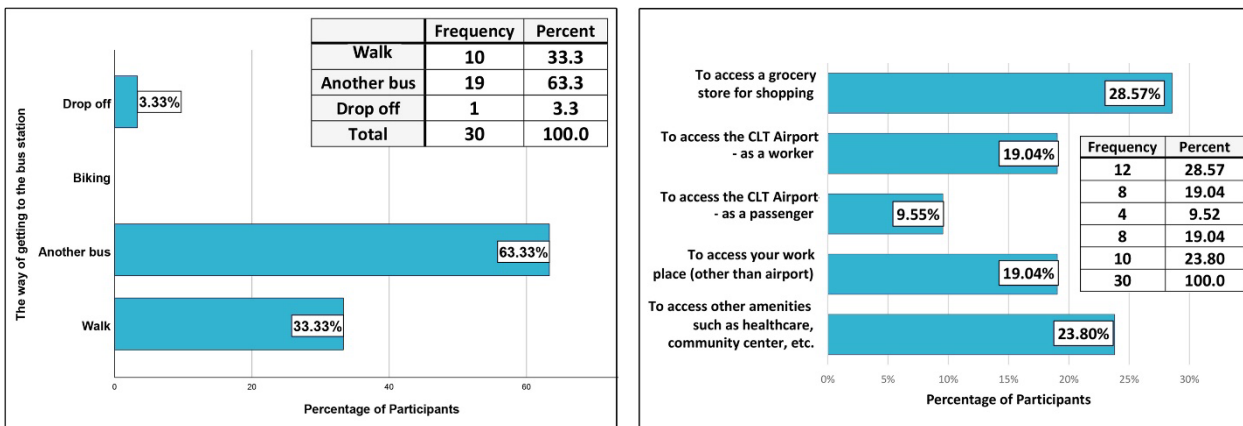

(a) How participants get to the bus station - (N:30) (b) The purpose of the trip participants taking - (N:30)

Figure 2: Section two of questions – part one. (Author 2022)

Figure 2. b, based on a multiple-answer question, shows that 29% of passengers were going to access a grocery store for shopping and 24% of them were using the bus to access other amenities such as healthcare, community center, etc. But only 10% of the participants were CLT airport passengers which means that few airport passengers use this bus for easier access to the airport which indicates that the bus is not well used for its main running purpose. In other words, the line that was supposed to take passengers from the Charlotte city center to the CLT airport is not actually being used for that purpose and is rather used primarily by the locals and people in underserved communities.

According to the survey results, 60% of participants have said that it takes 5-10 minutes for them to reach the bus stop from their home. But as mentioned, most of the participants have used another bus to reach the Sprinter bus line station, therefore, 5-10 minutes might not be a real commute time for the participants and the commute time might be longer.¹

¹ In this case, we realized we didn't clearly define commute time in the questionnaire, and participants assumed it meant the time it takes to get from the bus station to their destination.

In the following, based on Figure 3. a and Figure 3. b, during the day and night, on average, about 43% of participants have to wait for 10-20 minutes for the Sprinter bus to arrive at the bus stop; and also, most of them (about 67%) mentioned that they have to spend 10-30 minutes on the bus to arrive to their destinations.

Our results indicate that the Covid-19 pandemic (or other health aspects of using public transportation) was the concern of about 80% of participants while taking the bus while using overcrowded buses was the main concern for 50% of participants. It is clear that when a crowd of passengers uses a bus daily to reach their various destinations, this crowding will be dangerous for passengers, especially during the Covid-19 pandemic.

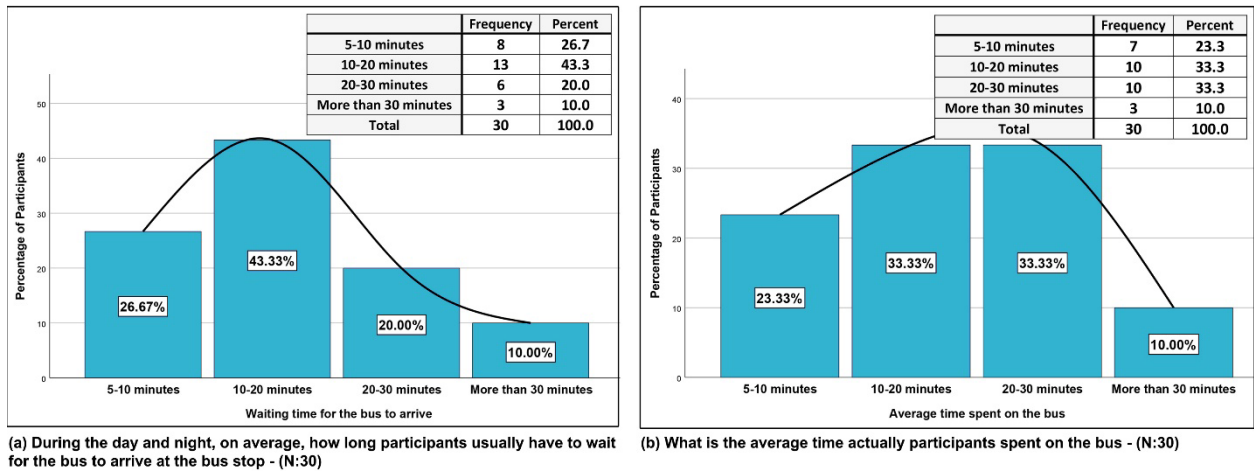

Figure 3: Section two of questions – part two. (Author 2022)

3.3 Part Three: Questions Related to the Current CATS Mobile Application

The third part of the questionnaire is about the current CATS mobile application, identifying the number of participants using it and their satisfaction with its services. Before asking people about their satisfaction with the mobile application, we should figure out how many participants actually have a smartphone to use the application or other navigation systems. Our survey results show that of all the participants, about 67% of them own a smartphone and use it for planning trips by bus. But still, about 33% of them do not have a smartphone which is a significant number, which again emphasizes the low income of people using these buses from underserved communities. Consequently, these people will have limited access to future transportation technologies and services.

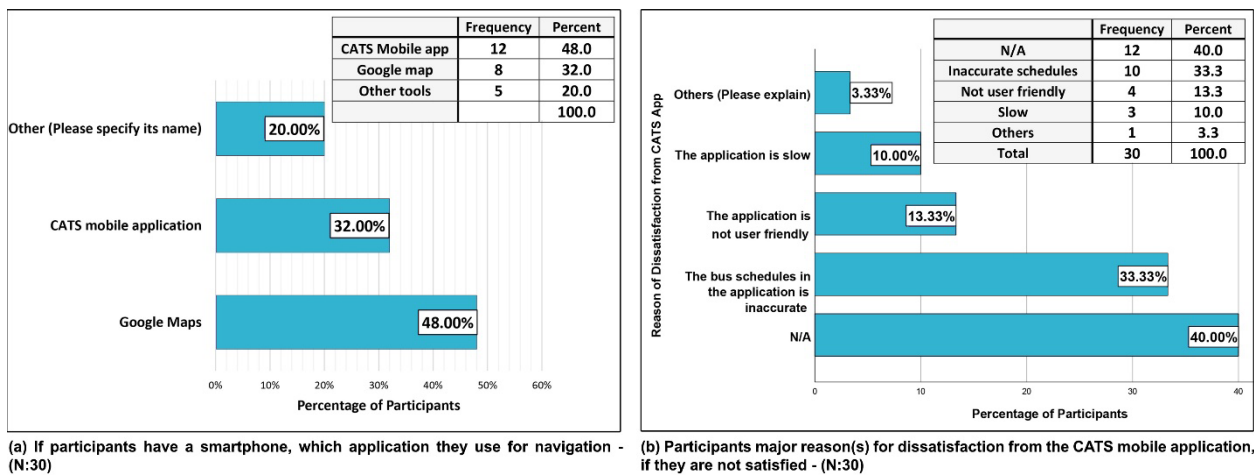

Figure 4: Section three of questions. (Author 2022)

According to the results shown in Figure 4. a – which is from a multiple-answer question, from the participants who do have a smartphone – 48% of participants use Google Maps for their navigation and only 32% of them use the CATS mobile application while others prefer to use other systems for the navigation, such as Apple Maps, transit information, and the internet version of CATS.

Based on Figure 4. b, 33.33% of participants indicated that the bus schedules in the CATS application are inaccurate and that this is the main reason for the dissatisfaction of travelers with the CATS application, while others mentioned

that the application is not user-friendly and is slow. Thus, it is clear from the results that the current application does not meet the needs of users.

3.4 Part Four: Questions Related To The New System and Application

The final part of the questions starts by introducing the future smart on-demand technology through the below quotation to determine potential user acceptance and their willingness to use the new technology in the future.

This section introduces you to new hypothetical technology. This new technology will be a new mobile application like the Uber application, with the difference that this time, this application will be only for bus transit. In this application, you will be able to enter your desired destination. According to your origin and by intelligently examining the bus stations and routes leading to your destination, the application will tell you in a customized way to use which bus to reach that destination. In fact, this new technology will make the use of city buses more desirable and efficient for you. It helps you reach your desired destination in the shortest time, efficiently, and easily.

The first question in this part, asks participants about how much they are willing to use the new application, which can reduce their wait time by 70% and reduce their overall trip time by 50%. Figure 5. a below, illustrates that 90% of participants are willing to use a new application with such a great service and promising initial results for future steps of this study.

Although based on Figure 5. b, from the participants who were not interested and willing to use the new application (10% of participants), 30% of them mentioned privacy issues as their main concern about the new application which is a concern that usually might be mentioned by the underserved people of the community, who often have more fears about their place in society.

And based on the final result of the questionnaire, we have determined that all in all about 90% of participants in the survey were willing to tap their travel information and destination in a new application to get to their destination faster; and it shows that most of them are eager to experience a new technology in which they can efficiently look for on-demand bus services.

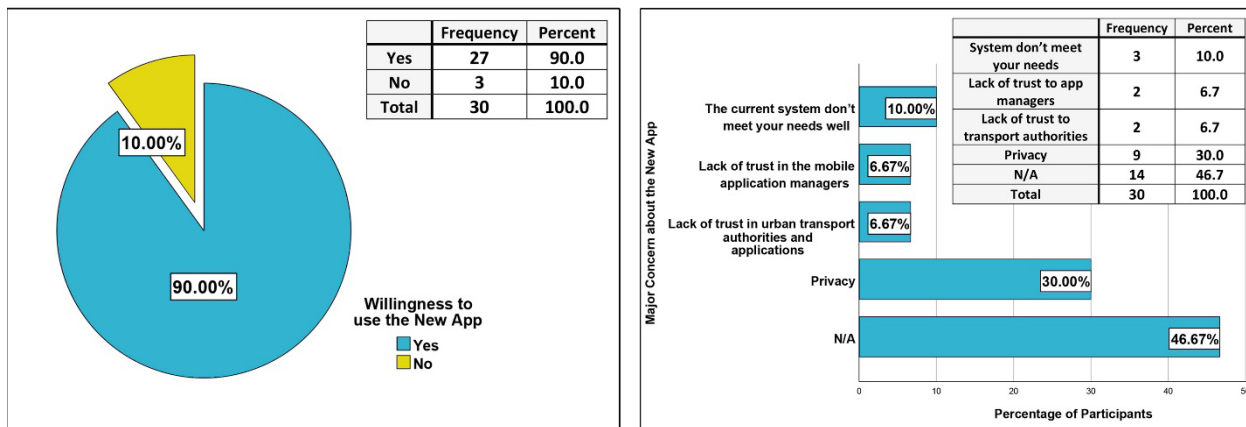

(a) Participants willingness to use a new application, if it can reduce their wait time by 70% and reduce their overall trip time by 50% - (N:30)

(b) If participants answer to the previous question is "No", what is their major concern about the new application - (N:30)

Figure 5: Section four of questions. (Author 2022)

CONCLUSION

As a result of this study, we can analyze the potential social acceptance of demand-responsive public bus transit which is one of the main goals of the study. The findings of the study clearly represent the current limitations and challenges regarding the Sprinter bus line and the CATS mobile application. Users of the Sprinter bus line, mostly living in the west and north of Charlotte, experience the existing disparities in the transit system of the city.

The results of our surveys generally show that currently, the main problems in this bus system are relatively long waiting times and the lack of reliability and accuracy of communication systems and related applications regarding travel schedules.

According to the results of the surveys conducted in the case study location, we can say that the majority of the participants were willing to use new smart technology in the future and sought to improve the quality of their travel with city buses. This is a significant point and an initial step to design and implement new and demanding technology for passengers that can meet their needs and also can be a step towards increasing transit ridership in the city of Charlotte.

Most of these people are locals from underserved communities who use the Sprinter bus for destinations other than the CLT airport and these riders, like other people of the city, have their own concerns about the existing condition of buses and mobile applications; they need more on-demand services for transportation with less waiting times and problems and are willing to use new technology or even bus systems which are more adaptive to their needs. Consequently, we are optimistic that in the future the Sprinter bus line – which is a line specifically designated to service CLT airport –, could be optimized for passengers whose final destination is actually the airport, and who choose to travel on this line for more convenient and efficient travel to the airport.

ACKNOWLEDGMENT

This research has been funded by the Gambrell Faculty Fellowship Program in 2021-2022 and is supported by The Charlotte Area Transit System (CATS). The authors would like to thank Charlotte Area Transit System for its support and assistance throughout the research process and all the other people who contributed to the survey process.

REFERENCES

- “A Multi-Agent Reinforcement Learning Approach for Bus Holding Control Strategies.” n.d. Accessed March 12, 2023. <http://www.atsinternationaljournal.com/index.php/2015-issues/special-issue-2015-vol2/792-a-multi-agent-reinforcement-learning-approach-for-bus-holding-control-strategies>.
- “AI-Controlled on Demand Bus Services Planned in Japan | Telecom Asia.” n.d. Accessed March 12, 2023. <https://www.telecomasia.net/content/ai-controlled-demand-bus-services-planned-japan/>.
- Brough, Rebecca, Matthew Freedman, and David Phillips. 2020. “Understanding Socioeconomic Disparities in Travel Behavior during the COVID-19 Pandemic.” SSRN Electronic Journal, December. <https://doi.org/10.2139/SSRN.3624920>.
- “CATS to Integrate On-Demand Services, Expand to Low-Income Neighborhoods.” n.d. Accessed March 12, 2023. <https://www.wbtv.com/2022/06/06/cats-integrate-uber-like-service-expand-low-income-neighborhoods/>.
- “Charlotte Considers Replacing Some Low-Ridership Buses with on-Demand Service | UNC Charlotte Urban Institute | UNC Charlotte.” n.d. Accessed March 12, 2023. <https://ui.charlotte.edu/story/charlotte-considers-replacing-some-low-ridership-buses-demand-service>.
- Chen, Weiya, Chunhua Yang, Fenling Feng, and Zhiya Chen. 2012. “An Improved Model for Headway-Based Bus Service Unreliability Prevention with Vehicle Load Capacity Constraint at Bus Stops.” *Discrete Dynamics in Nature and Society* 2012. <https://doi.org/10.1155/2012/313518>.
- Chetty, Raj, Nathaniel Hendren, Patrick Kline, Emmanuel Saez, Gary Becker, David Card, David Dorn, et al. 2014. “Where Is the Land of Opportunity? The Geography of Intergenerational Mobility in the United States,” January. <https://doi.org/10.3386/W19843>.
- Covington, Kenya L. 2018. “Overcoming Spatial Mismatch: The Opportunities and Limits of Transit Mode in Addressing the Black–White Unemployment Gap.” *Https://Doi.Org/10.1111/Cico.12278* 17 (1): 211–35. <https://doi.org/10.1111/CICO.12278>.
- Diab, Ehab I., Madhav G. Badami, and Ahmed M. El-Geneidy. 2015. “Bus Transit Service Reliability and Improvement Strategies: Integrating the Perspectives of Passengers and Transit Agencies in North America.” *Http://Dx.Doi.Org/10.1080/01441647.2015.1005034* 35 (3): 292–328. <https://doi.org/10.1080/01441647.2015.1005034>.
- “Electric Vehicles Research by IDTechEx.” n.d. Accessed March 12, 2023. <https://www.electricvehiclesresearch.com/>.
- Gkiotsalitis, Konstantinos, and Rahul Kumar. 2018. “Bus Operations Scheduling Subject to Resource Constraints Using Evolutionary Optimization.” *Informatics 2018, Vol. 5, Page 9* 5 (1): 9. <https://doi.org/10.3390/INFORMATICS5010009>.
- Koh, Kenneth, Cheryl Ng, Di Pan, and Keng Seng Mak. 2018. “Dynamic Bus Routing: A Study on the Viability of on-Demand High-Capacity Ridesharing as an Alternative to Fixed-Route Buses in Singapore.” *IEEE Conference on Intelligent Transportation Systems, Proceedings, ITSC 2018-November* (December): 34–40. <https://doi.org/10.1109/ITSC.2018.8569834>.
- Moosavi, Seyed Mohammad Hossein, Amiruddin Ismail, and Choon Wah Yuen. 2020. “Using Simulation Model as a Tool for Analyzing Bus Service Reliability and Implementing Improvement Strategies.” *PloS One* 15 (5). <https://doi.org/10.1371/JOURNAL.PONE.0232799>.
- Morales, Diego, Juan Carlos Muñoz, and Pedro Gazmuri. 2020. “A Stochastic Model for Bus Injection in an Unscheduled Public Transport Service.” *Transportation Research Part C: Emerging Technologies* 113 (April): 277–92. <https://doi.org/10.1016/J.TRC.2019.05.029>.
- Nannapaneni, Saideep, and Abhishek Dubey. 2019. “Towards Demand-Oriented Flexible Rerouting of Public Transit Under Uncertainty.” <https://doi.org/10.1145/3313237.3313302>.
- “NextBus™ Real-Time Passenger Information.” n.d. Accessed March 12, 2023.
- “Smart Public Transport – Key to Solving the Urban Challenge - Telia Company.” n.d. Accessed March 12, 2023. <https://www.teliacompany.com/en/news/news-articles/2017/report-smart-public-transportation/>.
- Sun, Fangzhou, Abhishek Dubey, Jules White, and Aniruddha Gokhale. 2019. “Transit-Hub: A Smart Public Transportation Decision Support System with Multi-Timescale Analytical Services.” *Cluster Computing* 22 (January): 2239–54. <https://doi.org/10.1007/S10586-018-1708-Z>.
- Tirachini, Alejandro, and Oded Cats. 2020. “COVID-19 and Public Transportation: Current Assessment, Prospects, and Research Needs.” *Journal of Public Transportation* 22 (1): 1–21. <https://doi.org/10.5038/2375-0901.22.1.1>.

“Transport, Data Analytics and AI: Why TfL’s Latest Initiative Is Good News - Technology Services Group.” n.d. Accessed March 12, 2023. <https://www.tsg.com/insights/transport-data-analytics-and-ai-why-tfls-latest-initiative-is-good-news/>.

Yu, Bin, Jin bao Yao, and Zhong Zhen Yang. 2010. “An Improved Headway-Based Holding Strategy for Bus Transit.” *Http://Dx.Doi.Org/10.1080/03081061003732417* 33 (3): 329–41. <https://doi.org/10.1080/03081061003732417>.

ENDNOTES

¹ In this case, we realized we didn't clearly define commute time in the questionnaire, and participants assumed it meant the time it takes to get from the bus station to their destination.

Design, Pedagogy and University-Community Partnerships in an Era of Global Challenges

José L.S. Gámez¹

¹University of North Carolina Charlotte, Charlotte, NC

ABSTRACT: Rapid urbanization has contributed to an era in which resource management and resilience are threatened due to global environmental and social challenges. Higher than previously predicted global sea level rise is now anticipated due to irreversible climate changes; global pandemics spread at alarming rates; inequalities have deepened; and, along the way, global populations will become 75% urbanized by 2050—with the majority of this urbanization occurring through informal processes. University-community partnerships provide vehicles to engage these global challenges and to enter arenas that are often unfamiliar to conventional design studios. The purpose of this paper is to share collaborative engagements involving design and research that demonstrate the power of implementing multiple cycles of action to achieve larger scale community outcomes within the context of local and global challenges.

Our programs are built upon multi-year research partnerships within specific regions of investigation—be they local neighborhoods or global centers. For example, multi-national collaborations have explored localized urban transformations while also facing questions of ecological change and cultural difference. In many ways, these collaborations fostered a design culture that privileged the sharing of expertise and a respect for local knowledge. This format enables evolving yet structured teaching environments in which faculty, students and local partners can investigate questions in an iterative fashion that sustain initiatives over time. By reflecting upon several multi-year partnerships, we find that design education can be deployed as a process of collaborative inquiry and as a tool for mobilizing collective critical imagination.

KEYWORDS: University-community partnerships, action research, design pedagogy

INTRODUCTION

Rapid urbanization has contributed to an era in which resource management and resilience are threatened due to global environmental and social challenges. Higher than previously predicted global sea level rise is now anticipated due to irreversible climate changes; global pandemics spread at alarming rates; inequalities are deepening; and, along the way, global populations will become 75% urbanized by 2050—with the majority of this urbanization occurring through informal processes. The list is long but, as Pratt Institute's President Frances Bronet (2018) has stated, these challenges “demand vigilance and new ways of seeing, new abilities, modes of learning” that will bring designers “into arenas we don't usually enter.”

These global transformations influenced the planning and implementation of our Master of Urban Design Program at the University of North Carolina Charlotte in 2008 as well as its subsequent required international capstone experience, which enabled our program to locate itself in places where global urbanization and sustainable development challenges could be examined first hand. This also presented opportunities to engage in community-university partnerships both locally and abroad through sustained partnerships. This is an important part of our urban design program because community-university partnerships provide vehicles to enter arenas that are often unfamiliar to conventional design studios. In our view, community-university partnerships are fertile ground for the integration of design and action research—a research model that Reason and Bradbury (2013) define as “a democratic and participative orientation to knowledge creation” that “brings together action and reflection, theory and practice, in the pursuit of practical solutions to issues of pressing concern.”

In other words, action research as we apply it in our curriculum, is a deliberative approach to problem-solving in collaboration with community members who are directly impacted by issues often characterized by inequality, environmental injustices, climate change, and urbanization. We work with community members to jointly define problems and, through processes of data collection and analysis, we collaboratively identify courses of action to remedy the issues. It is this active process of engagement that distinguishes action research from applied research (Greenwood & Levin, 2007). Combining action research with design pedagogy provides the added dimension of engaging students with real people in real places; this also enables academics to translate theory into practice and to reflect on practice to further inform theory.

1.0. REFLECTION THROUGH ITERATIVE TEACHING METHODS (LOCAL)

Looking back at several longstanding partnerships that we have maintained, one major reflection has been this: in order for action research to address complex social problems, our processes and methods must strategically build upon iterative phases of community engagement. While the steps of action research are well demonstrated in the existing literature, our contribution to community-university partnership discussions and action research is our identification and characterization of distinct phases that build on each other to develop neighborhood power. In a sense, we aim to design relationships that lead to local change. For us, this has been both pedagogy and method: our model leverages action research to build relationships with community members (Phase I). From there, we progress to increasing participation in Phase II, which involves helping organize events and small initiatives intended to build social capital.ⁱ We then develop a collective vision for change in Phase III through design workshops, charettes, and on-site engagements; and in Phase IV, we build power to affect community change through leveraged visions plans and through engagement with local democratic processes (community participation in local governance meetings, for example).

These phases build over time and are maintained over multiple academic courses, semesters, and years in specific locations. This intentional strategy of long-term engagement and capacity building helps sustain community-university partnerships, a key challenge that is noted throughout the literature. If indeed action research is to produce transformational knowledge (Reason and Bradbury, 2013), then one long-term goal of any action research project should be to develop the power of individuals and groups to change their circumstances, to improve their communities, and to shape their futures.

Our model of action research grew out of long-term collaborations with partnering organizations and community groups both locally and internationally. For example, locally, our design and action-based research teams have collaborated with 8 specific neighborhoods over a 10-year period (Bengle, et al, 2021). A case in point: we worked with Reid Park, which is a neighborhood characterized by low initial resident participation, a median household income of just under \$16K per year, and a population that is over 91% Black. Additionally, the neighborhood suffered from noticeable inequality in education, municipal funding, and access to resources as compared to the city overall. This combination of factors helped focus our collaborative efforts; and, as participation grew, the capacity of the neighborhood's residents to act for themselves led us to maintain this particular long-term relationship.

This community-university partnership has produced several tangible benefits on the ground, the most significant being a \$600,000 investment by Mecklenburg County Park and Recreation (MCPR) to build a new park within the community. Reid Park, however, had demonstrated a capacity for change long before our partnership began. Historically, there had been a tradition of organizing in the neighborhood; in the late 1980s, residents had formed a community development corporation that would later fall due to financial trouble and limited support from the city. More recently, participant numbers had dwindled to just one active leader at the start of our partnership but the legacy of past movements remained in the form of a focus on the development of a promised but never delivered neighborhood park.

This context provided an entry point for our action-based research partnership. Tying past goals to present concerns was one way to ground a new vision for a neighborhood plan in the community's collective memory. Neighborhood residents were vocal during meetings and one-on-one conversations with students during our many neighborhood activities. The relationships we built with individuals in this early stage had a lasting impact in the form of our sustained commitment to the partnership.

Relationship building began with the work of several graduate and undergraduate courses over a two-year period with data collection, neighborhood planning, and events the university helped facilitate. In fact, events played a key role in our early efforts as these provided opportunities to build relationships within the community, to illustrate that small acts can have significant results, and to build momentum towards larger goals. This was important to relationship and trust building, a core challenge of community-university partnerships. While the goals of academics are often met by generating data and writing reports, achieving neighborhood goals from the partnership requires action (Wiewel and Lieber, 1998).

Neighborhood meetings lead to neighborhood events that, over time, helped build greater resident participation. As our partnership unfolded, we arrived on stages of engagement that fostered visioning exercises in the form of community-based charrettes and workshops. These were integrated into community-engaged coursework and eventually into a Master's student thesis project that compared recreational funding in two differing contexts: Reid Park (predominantly Black) and Dilworth (predominantly White). One key benefit of this work to the residents was that the thesis project quantified disparities in municipal funding. By comparing recreational spaces (including geographic and landscape characteristics), socioeconomic characteristics, and public expenditures, findings indicated that per person spending on park and recreation improvements since 1992 was significantly higher in Dilworth (\$279.70) versus Reid Park (\$55.90).

Our work, in hindsight, illustrated what Goldsmith (1998) suggests are the benefits of processes that transfer knowledge and power from the researcher to citizens. In other words,

...interventions are likely to be more lasting when they lead to direct and immediate empowerment of weaker parties in disputes. This is because empowerment makes people more likely to continue to resist, and to resist again. Thus organizing, or providing technical assistance appears to be more promising when it involves people in the neighborhoods in ways that not only satisfy them, (even if only marginally), but also give them means of demanding (and getting) more. (p. 1220)

Our long-term collaboration facilitated the gathering of concrete data that positioned neighborhood residents to advocate for themselves. Our action-research partnership, in this sense, empowered our collaborators to take on city hall and to offer successful paths to change. As we reflected on the work with Reid Park, we created a list of all events and initiatives dating to the beginning of the partnership in 2009. From this, we generated a timeline and coded each component of our work according to several stages of action research. Critical to our work in Reid Park, as with all our collaborations, was an emphasis on long-term engagement. Our partnership, by this time, had been on-going in Reid Park for over six years. Relationships built over time enabled us to develop a critical component of a successful partnership: a level of trust built with community partners. As described by Brydon-Miller, Greenwood & Maguire (2003):

...building trust in communities that have every reason to be wary of outsiders and especially of academic outsiders doing research is a long-term project...but the impact of the project on the community and the richness of the insights generated in their work together are testament to the value of such patience. (p. 12)

Trust, however, is not enough. Action was needed, which, in this case, came in the form of community organizing, events, visioning workshops, and civic engagement opportunities (public meetings with county and city officials) that ultimately led to the implementation of a neighborhood park.ⁱⁱ

On-going, multi-year initiatives like ours in Reid Park help to sustain community-university partnerships, which is a key challenge often noted throughout the literature. It is this active and long-term process of engagement that distinguishes action research from applied research (Greenwood & Levin, 2007). This is one way that our process begins to stand apart from much of the existing literature focused on action research. By grounding our work in the dynamics of specific places, we have been able to critically assess how our work can become a venue for neighborhood partners to raise demands and to enable action through an evolving process.

2.0. REFLECTION AND ITERATIVE PRACTICE (GLOBAL)

Internationally, we have aimed to replicate this model of multi-stage, multi-year action research. We have collaborated with university teams and community partners in places like China and Brazil through extended workshops (5-week summer programs) over multi-year teaching cycles (typically 3 or more years). Given the temporal and geographic distances that shape our abilities to collaborate, we rely upon local partners who are willing to engage specific places through iterative engagements. A central strategy of this initiative is our ability to connect multiple university courses and student projects to local community partners' needs. This model has the potential to guide future community-university partnerships towards larger scale tangible outcomes particularly in situations where initial participation is low and capacity is limited.

These types of long-term and site-specific engagements frame our key contribution to the literature on community-university partnerships. Our international collaborations began by focusing on sustainable development strategies in China with a 3-year research cycle (2013-2015). This was followed by a 3-year partnership in Brazil that began in 2015 and concluded in 2017. In many ways, these three-year programs were designed to provide opportunities for our students to engage a range of topics not often studied in western design programs precisely because the most rapidly transforming urban contexts facing design professions often lie outside the United States.

Framed by themes of verticality, compactness, and sustainable development, our program in China focused upon emerging patterns of centralized planning and urbanization as well as their subsequent (unintended) impacts. These studies were followed by a series of research and design workshops set in Brazil where urbanization is often poorly controlled (lacking strong central oversight) and informally driven. The transformations we witnessed in both locations—those of rapid urbanization and associated environmental strains—required a reinterpretation design practices as they related to ecological systems and an investigation of the cultural frameworks informing urbanization both globally (in China and Brazil) and local (among our students and our partnering institutions).

In our model, community-university partnerships put community first. Within the context of an international collaboration, we aimed to balance traditional relationships between community and university actors such that our faculty and students and those with whom we partnered did not simply *study* a people or place. In our model of action research, we aim to empower citizen partners to set the research agenda through active engagement with local actors over time. Our partnerships in Charlotte have benefitted from this approach and we aim to replicate that model internationally. As researchers, we are aware of the need not only to interrogate existing theories in our disciplines but also of the need to dismantle systemic impediments to equitable engagement with our partners. However, differing cultural practices, differing political systems, geographic distance, and differing institutional frameworks introduce new layers of complexity. In this sense, a reconstruction of action research must also involve empowerment strategies and an acknowledgement of the often-problematic role that universities have played in local landscapes both at home and abroad. As we attempted to translate into our pedagogical approach, we focused on common questions of urbanization

and climate change, which could be woven into curricula and into partnerships involving two institutions (our university and our host university) and local community partners. In a sense, impending global crises demand a global pedagogy with local actions and this provides a common platform for cross-cultural engagement.

These issues set the stage for our design and action research workshops with Pontifical Catholic University at Rio de Janeiro's (PUC-Rio) Urbanism Laboratory within the Graduate Program of Architecture of the Architecture and Urbanism Department in Brazil. Using Rio de Janeiro as a laboratory, our students worked in multi-disciplinary and multi-institutional teams to explore the design, ecological, and socio-cultural dimensions of building resilient cities in the face of mega-event driven development (the Summer 2016 Olympics), informal urbanization (favela growth that accompanied Olympic projects) and the ecological challenges that threatened communities in Rio's Western Zone (the location of the Olympic Games). For example, Rio de Janeiro is also characterized by natural water systems that, due to poorly managed development, contribute to flooding and mudslides. Yet, growth continues in ecologically sensitive areas and this situation has been exacerbated by both formal and informal urbanization.ⁱⁱⁱ

This complex set of issues also required finding sympathetic local non-institutional partners, which raised new challenges to our model for collaborations. Without a regular presence in specific neighborhoods, we relied upon our local university partners for introductions and sustained engagements; this resulted in connections to local development actors and NGOs in local favela neighborhoods who supported our intended pedagogical goals and were interested in leveraging student energy and ideas in their efforts to create positive change in their city.

Ultimately, our teams included 4 or 5 students—2 or 3 from Charlotte and 2 or more from our Brazilian hosts (similar team structures were used in our collaborations in China). Design teams were composed of students and faculty from each participating university and each also engaged local professionals from a range of industries and organizations. In order to enrich the experience of our students, we cross-listed our coursework with the university's graduate program in Latin American Studies; this gave our students opportunities for new cultural insights from other students with specific cultural, political, or other regionally informed knowledge. Additionally, our collaborating partners opened the workshops to their interdisciplinary sustainable urbanism program so the mix of local students ranged from architecture to urbanism to environmental sciences to Biology.

The abilities of our teams of students to find ways forward in their workshops were related to the action-based approaches to research that framed our international partnerships. Each of our five-week workshops in Rio was organized within a 3-year cycle that enabled an evolving yet structured teaching environment in which faculty and students investigated urban design questions pertinent to that particular city in an iterative fashion. The method behind our workshops leveraged the hands-on studio environment common to design programs to serve both as an opportunity for pedagogical research relative to climate change literacy and as an opportunity to explore a specific city relative to sea level rise through engagement with community actors. Local faculty, governmental agencies, developers, and designers participated in each workshop by helping to introduce various aspects of each project, adding depth to frequent discussions and symposia, and participating in design reviews. In return, the students' projects provided local officials and representatives with unique insights and alternative ideas for development patterns, practices and programming.

Trust, just as in our work in Charlotte, was not enough. Action was needed, which, in this case, came in the form of workshops engaging local actors, our university partners, and various neighborhood, NGO and site visits. These activities provided the foundation for visioning workshops and civic engagement opportunities (public meetings and symposia) that provided venues to share student work and draft vision plans. On-going, multi-year initiatives also reinforced the commitment of our local non-university partners in Rio. Just as in our work back home, long-term relationships helped to sustain our partnerships and helped to enrich our model of action research. This is one way that our process begins to stand apart from much of the existing literature focused on action research as a venue for local partners to raise concerns and to enable action through an evolving process.

3.0. (GLOBAL) QUESTIONS: ENVIRONMENTAL JUSTICE AND CLIMATE LITERACY

As we began planning our international collaborations, we reviewed participant observation notes from our ten years of partnership with various groups and organizations in Charlotte. Here, Reid Park's example lent us many valuable lessons drawn from our published manuscripts and neighborhood reports developed collaboratively with residents. Graduate student projects, including two Master's thesis projects and one PhD dissertation, and other student work from Geography, Architecture and Urban Design courses were also used to inform a four-stage model that provided a foundation for our multi-year collaborations abroad.

In Rio, as with other international engagements, we did not have the same ability to maintain on-going relationship building experiences. However, we had our pedagogical model of integrated action research and design workshops, which had proven successful for us locally. For example, visioning workshops, in our work, have always been based on-site (off-campus) and built upon community engaged initiatives. Our use of design workshops allows us to bring together residents, neighborhood and university partners, as well as other important community stakeholders.^{iv}

By identifying critical issues and then providing venues for discussion, local actors showed up because they saw this as an opportunity to voice concerns and to set agendas for future meetings. In this sense, our workshops provided venues for local actors to shape agendas rather than having agendas set by outsiders—be they from outside the neighborhood or beyond. This was a moment in which residents could see their collective power in action. This, coupled with close partnerships on the ground, afforded opportunities to adapt our model and to engage with local experts and resources. The hands-on workshop format, which we borrow from design studio education, enabled us to integrate environmental, climate change and sustainable development pedagogies into a holistic approach through action-based research both in our local work and when working with partners in other countries.^v

Urban design, as a discipline, straddles a range of areas impacting the built environment; therefore, our international workshops became critical venues for the integration of strategies that can inform the creation of resilient, healthy and sustainable places for human inhabitation—not just for our students but also for our collaborating institutions and community partners. Using integrated workshop teams, we positioned topics of local import on everyone’s agendas. Students were excited and motivated by the opportunity to collaborate on “live” projects that could connect with and benefit real people. Our experience in Rio (and China) connects with literature indicating that direct exposure to questions of sea-level rise, for example, puts students in situations in which they are able to connect, wrestle with and formulate innovative questions about (if not solutions) the roles that design disciplines can play in shaping future resilient cities.

Student perceptions of the topics and their insights provided a way to introduce questions related to climate change in contexts that otherwise would find little room in conventional classes or public meetings. Each team represented a set of global cultures that had to negotiate working definitions of basic terms such as environment, density, scale, cultural legacy, or sea-level rise. For many students involved, this format necessitated a departure from a design culture that privileges individual competition in favor of shared expertise. In addition, the composition of each team challenged us and our students to think beyond the “rules of thumb” that we have come to rely upon in the U.S.; students from several parts of the world working collaboratively (and in consultation with local actors) quickly highlighted cultural dimensions of design rooted in differing educational and lived experiences. This opened opportunities for differences of interpretation and new modes of speculation.

Diversity became integral to the overall learning environment and was an asset that enabled cooperation as well as cultural and professional growth (Crysler 1995). These diverse teams enabled us to impact the students’ perceptions and understandings of climate change generally including our Brazilian student collaborators. Similarly, when we look back at Reid Park, we see that students and residents needed to find ways to come to terms with limited understandings of environmental justice, climate change impacts, or uneven resource allocations. Climate change literacy, as Katrina Leona Marzetta (2017) states, is vital if we expect students (and, by extension, our local partners) to make informed and important decisions about climate change, resilience, or other environmental concerns.

While many in higher educational environments are working towards raising climate change literacy, it is important to note that people with high levels of education often have a lower sense of risk as it relates to changes in the environment—particularly due to perceptions of the indirect connection between risks and their abilities to impact change; a psychological, spatial and/or temporal distance from risks; or a moral distance from a seemingly abstract set of risks (Markowitz, 2012; Spence, Poortinga, & Pidgeon, 2012). This ironic situation is also often reflected in general community populations both locally and internationally. This again is one situation that action-based workshops can help address; workshop environments in which experiential learning can take place provide settings in which participants learn through actions directly tied to and that challenge their belief systems. These kinds of learning environments create situations in which participants learn by generating questions on their own and by addressing the cognitive dissonance raised when their belief systems are challenged (Mazetta 2017).

RELEVANCE TO THE CONFERENCE THEMES (EVOLVING CONCLUSIONS)

Upon reflection, it is clear to us that unique opportunities exist to prepare students for success in a global society. These opportunities can help highlight global issues and their impacts upon local conditions; the need to redefine the roles of infrastructure, design and ecology, for example, can be placed in stark relief through first hand explorations in locations that already face significant impacts from climate change. Given the complexity of the issues that face 21st century cities, workshops such as those that we held in Brazil are crucial resources that can anchor international networks of experts, place global partnerships in positions to influence local actions, and to foster international outreach efforts. By grounding our work in the dynamics of specific places both locally and globally, we critically assess an evolving process and build upon intentional strategies of long-term, multi-stage engagements. In these ways, our process stands apart the existing literature focused on action research (Wiewel and Lieber 1998).

As we moved through various phases of engagement, discussion, and reflection (Bodorkós and Pataki 2009), we often found that our own horizon for action was more distant than what community members anticipated. Each phase of the project led us directly to the next phase as we reflected on what we learned and identified a new set of strategies. Using action research as our framework for a community development process enabled us to clearly articulate phases of

community development for future application. The idea of learning by doing, which is at the heart of action research and design education, posed its own issues, as residents doubted what we could offer in support of the community.

These differing expectations of the process can be one of the troubling spots for community partners when engaging in research in community-university partnerships. However, communities are empowered when their knowledge is valued and used in the generation of new knowledge when combined with scientific knowledge (Fals-Borda and Rahman, 1991). Our use of action research facilitated this valuing of knowledge and created the space for collaboration between community residents and university actors (Silverman et al., 2008). In this sense, our action research helped/helps establish cyclical processes that evolved/evolve through phases over time and in specific places. This framework provides civically valuable educational, research, and collaborative opportunities that are made operational through action research.

We recognize that our workshops represent a limited sample with regard to pedagogical research and the impacts that climate-change related design experiences may have had upon students generally.^{vi} However, the premise and formats of these workshops can be applied to others and to design studios generally within a range of globally engaged formats; we use a framework for faculty, students and community partners to foster real change through a focus on *process* (the production of knowledge through community empowerment); *product* (research questions developed and applied with the help of local actors and residents often in the form of action plans); and sustained *partnerships* that last beyond the semester. This framework provides civically valuable educational, research, and collaborative opportunities that are made operational through action research.

One next opportunity that we are currently pursuing involves the Cairo-based Megawra Built Environment Collective (Megawra BEC, NGO). Starting last year (2021-22), with the support of the Hollings Fund for International Dialog, this project represents the roots of a long-term partnership between the University of North Carolina College of Arts + Architecture, Megawra BEC, and their affiliated organizations (including local universities). This initiative brings together professionals, scholars, educators, public representatives, and students in order to develop holistic approaches to the redevelopment of resilient and equitable urban neighborhoods and districts through the alignment of the arts, heritage conservation, and urban design.

Using neighborhoods suffering from economic decline in Cairo and Charlotte as foci of inquiry, interdisciplinary teams will develop holistic approaches for a project-based educational platform that connects across disciplines and institutions to drive civic transformation. Unique to this initiative is the fact that our action-based research will integrate the arts, heritage conservation, design, and community engagement into a multi-year, multi-phased process intended to make qualitative differences in the material realities and the self and collective identities of urban citizenry in under-resourced areas in both cities. It is also hoped that such a methodology, when implemented, will demonstrate how the arts can help shape the public's understandings of culture, heritage and place-making.

Our past and future university-community partnerships build upon our understanding that our work is tied to interpersonal relationship-building, which often does not look like typical research models in which the researcher and research subject roles remain clearly delineated. We acknowledge that our embedded work blurs traditional research roles with the goal of empowering non-traditional researchers to mobilize their socio-cultural capital (power), to bolster their own problem setting and problem-solving capacity, and to ultimately develop independence from academic researchers.

This kind of action research is not without its pitfalls or "paradox(es) of participation"; as Arieli et al. (2009) caution, unintended situations can result when "action researchers, acting to actualize participatory and democratic values, unintentionally impose participatory methods upon partners who are either unwilling or unable to act as researchers" (p. 275). However, as reflective and engaged scholars, we believe that universities have an inherent commitment to their local communities (Boyer, 1996). And, this kind of work builds on the work of others such as Boyer and Mitgang (1996), Schon (1987), and Cuff (1992); however, our work aims to extend their reflective models through iterative and place-based long-term engagements.

In our view, design professions cannot gain an appreciation for localized concerns without engagements foster reflexivity in ways not typically addressed in the academy. The academic setting often removes problems from contextual constraints in order to clarify and focus upon specific issues within a coordinated set of increasingly complex learning experiences. This combination of factors distances the classroom from the community beyond, which limits the capacity of design education to address questions of social change. Our engagements with local communities aim to overcome this limitation by addressing issues of public import as both *public scholars* through research, critical speculation and active partnerships (Latham 2003).

Our university-community partnerships place student actions in specific locations and contexts in order to reinforce their learning experiences in ways that introduce the richness of real constraints and opportunities. This challenges all involved to look beyond designing for the status quo and to think beyond well-organized constituencies, municipalities, or developers. As a result, students' preconceived notions of appropriate design activities are challenged through hands-on, civically engaged learning in a wide range of contexts that fosters *pragmatic values* necessary for effective

multicultural practice environments (Sletto 2010). Our model adds new opportunities for action and reflection because it is situated within and able to focus upon contexts not from the confines of the classroom but instead from the immediacy of the field.

This drives us to offer our skills, knowledge, and resources such as our own and our students' time and labor, grant writing, etc., to collaborate with our local communities on pressing concerns, while also bringing to that practice an intentional approach involving action and reflection. In our work, research and teaching involve processes aimed at bringing together action, reflection, democratic dialog, critical examination of existing theory, and practical work on the ground. Ultimately, these various forms of knowledge are brought together and shared through collaborative partnerships with citizens whose concerns and visions form core research questions.

It should be noted that our efforts through university-community partnerships fall between what Dewar and Isaac (1998) describe as "liberal" and "radical" traditions within the literature of university and community relations. The liberal trend aims to promote citizen participation and empowerment by addressing a range of societal ills; the radical trend aims to democratize the university itself in ways that curb institutional encroachment upon marginalized communities in which they often perform research. Positioned between these two ends of the spectrum, our work requires that we develop a comfort level with the unexpected changes and disruptions that lead to reformulations of processes and to re-solutions to proposed outcomes. In this sense, we see learning as an iterative process in which all participating actors contribute to the production of knowledge.

Given this context, our work aims to position design-based education to address differing dimensions of globalization that include both cultural awareness as well as environmental ethics. This can be done both at local and global scales. Action research in design workshops can create spaces for collaboration between community residents and university actors (Silverman et al., 2008) and it can lead to increased participation in order to influence community development outcomes. Such opportunities can highlight global issues and their impacts upon local conditions through university-community collaborations, which are crucial educational alliances. This represents a necessary role for designers and design educators who must learn to translate and direct the cultural, scientific, and technical expertise of other disciplines through deliberative problem-solving collaborations that address the challenges that Bronet raises.

REFERENCES

- Arieli, D., Friedman, V., & Agbaria, K. (2009). "The Paradox of Participation in Action Research." *Action Research*, 7(3), 263-290.
- Bengle, T., Sorensen, J., Gámez, J. and Morrell, L. 2021. "A Model of Action Research for Building Neighborhood Decision-making Capacity." *Collaborations: A Journal of Community-based Research and Practice* 4: 1, 4 (1-11).
- Bodorkós, B., & Pataki, G. 2009. "Local communities empowered to plan? Applying PAR to establish democratic communicative spaces for sustainable rural development." *Action Research*, 7(3), 313-334.
- Boyer, E. L., and L. D. Mitgang. 1996. *Building Community: A New Future for Architecture Education and Practice*. Princeton: Carnegie Foundation for the Advancement of Teaching.
- Bronet, F. 2018. "Remarks for the Presidential Inauguration of Frances Bronet" <https://www.pratt.edu/resources/remarks-for-the-presidential-inauguration-of-frances-bronet/>
- Brydon-Miller M, Greenwood D, and Maguire P. 2003. "Why Action Research?" *Action Research* 1(1):9-28.
- Crysler, C. G. (1005). "Critical Pedagogy and Architectural Education." *The Journal of Architectural Education* 48 (4) 214.
- Cuff, D. 1991. *Architecture: The Story of Practice*. Cambridge: MIT Press. 248-63.
- Dewar, M. E., and C. B. Isaac. 1998. "Learning from Difference: The Potentially Transforming Experience of Community-University Collaboration." *Journal of Planning Education and Research* 17: 334-347.
- Fals-Borda, O. & Rahman, M.A. 1991. *Breaking the monopoly with participatory action research*. New York: Apex Press.
- Goldsmith, W. W. 1998. "Fishing Bodies Out of the River: Can Universities Help Troubled Neighborhoods?" *Connecticut Law Review*, 30(4), 1205-1246.
- Greenwood, D. J., & Levin, M. 2007. *Introduction to Action Research: Social Research for Social Change* (2nd. ed.). Thousand Oaks, CA: Sage Publications Ltd.
- Latham, A. 2003. "Liberal Education for Global Citizenship: Renewing Macalester's Traditions of Public Scholarship and Civic Learning." Occasional Paper sponsored by Project Pericles, Macalester College. <http://www.macalester.edu/pericles>
- Markowitz, E. M. 2012. "Is Climate Change an Ethical Issue? Examining Young Adults' Beliefs About Climate and Morality." *Climatic Change*, 114 (3), 479-495.
- Maiter, S., Simich, L., Jacobson, N., & Wise, J. (2008). "Reciprocity: An ethic for Community-based Participatory Action Research." *Action Research*, 6 (3), 305-325.
- Marzetta, K. L. 2017. "Changing the Climate of Beliefs: A Conceptual Model of Learning Design Elements to Promote Climate Change Literacy." *The Journal of Sustainability Education, Volume 16*.
- Reason, P. and Bradbury, H. 2013. *The SAGE Handbook of Action Research: Participative Inquiry and Practice*. London: Sage Publications Ltd.
- Schon, D. 1987. *Educating the Reflective Practitioner*. San Francisco: Josey-Bass.

- Silverman, R. M., Taylor, H. L., & Crawford, C. (2008). "The role of citizen participation and action research principles in Main Street revitalization: An analysis of a local planning project." *Action Research*, 6(1), 69-93.
- Sletto, B. 2010. "Educating Reflective Practitioners: Learning to Embrace the Unexpected Through Service Learning." *Journal of Planning Education and Research* 29 (4): 403–415.
- Spence, A., Poortinga, W., and Pidgeon, N. 2012. "The Psychological Distance of Climate Change." *Risk Analysis* 32, 957–972.
- Wiewel, W., and Lieber, M. 1998. "Goal achievement, relationship building and incrementalism: The challenges of university–community partnerships." *Journal of Planning Education and Research*, 17(4), 291–301.

ENDNOTES

ⁱ Relationship building often begins with the work of several graduate and undergraduate courses over multiple semesters with data collection, neighborhood planning, and events that the university helps facilitate. In fact, events play a key role in our early efforts as these provided opportunities to illustrate that small acts can have significant results, and to build momentum towards larger goals.

ⁱⁱ The fourth phase of this six-year action research project began with a dissertation project aimed at building neighborhood power to impact local decision-making. Although residents had produced a vision plan for the park, they lacked the power to secure resources for the implementation of that vision. They needed to harness the existing neighborhood interest in the park and push for funding from county decision makers.

ⁱⁱⁱ In Zona Oeste, or the western zone of Rio de Janeiro, these large-scale planned initiatives drew workers who built adjacent unplanned favelas alongside the construction sites of global event locations. This combined with a high-water table, the soft coastal basin soils, and sensitive ecological systems, makes Rio's Western Zone a poor candidate for regional development.

^{iv} With Reid Park, it was clear that environmental injustices and uneven distributions of resources were central to long standing struggles to exert positive influences on local landscapes. Broad participation by residents was ensured by canvassing the neighborhood and knocking on doors and, more importantly, by collectively identifying key issues that resonated with the larger community.

^v Many authors have pointed out that education (generally) must aim to instill an ethos of sustainability among students of all ages.

^{vi} In our case, 15 students (on average) per workshop per year were involved and their disciplinary demographics were overwhelmingly tied to architectural or urban design.

Environmental Racism: How Design and Planning Policies Create Structural Injustices in Cleveland and Detroit

Taraneh Meshkani¹

¹Kent state University, Kent, OH

ABSTRACT: Design, spatial practices, and planning policies significantly impact systematic racism concerning environmental inequalities. These inequalities can manifest in a myriad of ways, such as proximity to hazardous waste sites and industries, uneven distribution of tree canopies, lack of access to clean water or other urban systems and infrastructures, exposure to lead and air pollutants, and uneven development, among others. Historically, there have been specific planning policies that have also exacerbated these inequalities. One example is redlining which historically had caused residential segregation of the African American population in many cities.

There has been a lack of investigation in many mid-western cities' neighborhoods about the environmental impacts of structured racism. This paper aims to examine the research on racial segregation and environmental inequalities concerning design processes and planning policies. The Central neighborhood of Cleveland and two Southwest neighborhoods of Detroit, Delray, and Boynton are selected as case studies.

The paper adopts qualitative and quantitative methods of study in exploring design processes and planning policies concerning environmental inequalities in neighborhoods with the highest number of people of color, especially African Americans, in the two cities of Cleveland and Detroit. The study investigates the racial data of the selected urban areas and correlates and maps it in relation to the environmental justice issues in these neighborhoods. Also, there will be analyses of fieldwork and the results of tens of interviews, which will be conducted with residents concerning the most critical environmental concerns. The results of data analyses and interviews will be divided into three spatial categories, which include lack of vegetation and tree canopies, proximity to toxic industrial sites and waste hazards, and housing segregation and lead poisoning.

This study aims to illustrate the ongoing negative impacts of systematic racism on the well-being of communities of color in order to encourage new design practices and planning policies that are more sustainable and consider racial and environmental inequalities.

KEYWORDS: Environmental Racism, Redlining, Cleveland, Detroit

INTRODUCTION

Many environmental problems impact communities of color and low-income families disproportionately. Factors such as exposure to air and water pollution, proximity to industrial sites and highways, less vegetation and tree canopies, adjacency to brown and superfund sites, housing segregation, and lead exposure are among some of these environmental injustices which are the results of policies that have caused structural racism and systematic oppression. Many studies show that race is an important predictor of exposure to environmental hazards, and people of color and minorities are more likely to live near industries and factories (Mohai et al. 2009). Historically, the policies such as redlining segregated African Americans in urban industrial centers while the white left for developing suburbs (Massey & Enton 1988). In addition, research has also shown that the factories were intentionally placed in African American neighborhoods. Subsequently, the pollution from these sites and factories mainly impacted these populations. Still, in many of these segregated neighborhoods, people are suffering from the pollution that existing industrial facilities generate.

Aside from the health-related environmental injustices such as the high risk for Asthma and cancer, there have been planning policies such as urban renewal and parks movement, which created spatial limitations and segregation in terms of where the communities of color resided and how much of urban facilities they could access. For instance, Parks are typically planned in White neighborhoods of the city. "In New York City from 1930 to 1939, Robert Moses-then New York City's Parks Commissioner-built 255 neighborhood parks, yet only two of these were in African-American communities" (Gelobter 1994).

Environment Justice (EJ) is a contested term, but EPA defines it as "the fair treatment and meaningful involvement of all people regardless of race, color, national origin, or income with respect to the development, implementation and

enforcement of environmental laws, regulations and policies.” The movement against such environmental discrimination in the US started with the Memphis Sanitation Strike in 1968. It is believed that the strike was the first time that African Americans were mobilized against environmental injustices. According to EPA Timeline of Environmental Justice, later in 1982, the protests of Warren County by the mainly African American community in North Carolina against the hazardous waste landfill became the catalyst for the introduction of policies against Environmental injustices. The protest and sit-in in Warren County later initiated a study by the General Accounting Office (GAO), which concluded that three out of four hazardous waste landfills existed in neighborhoods where African Americans consisted of at least 26% of the population (Siting of Hazardous Waste Landfills 1983). Later in 1992, the Office of Environmental Equity was established, and in 1994, Executive Order of 12898 by President Clinton was signed, which was a federal action to address environmental justice in minority and low-income populations.

It was also around the same time that the term *Environmental Racism* was coined by the former executive director of the National Association for the Advancement of People of Color (NAACP), Reverend Dr. Benjamin F. while preparing a report at the National Press Club regarding the toxic waste sites and race in the US. The term is defined as “racial discrimination in environmental policy-making, enforcement of regulations and laws, and the deliberate targeting of communities of color for toxic waste disposal and the siting of polluting industries” (Bullard 1994).

Environmental racism in the cities of Detroit and Cleveland is multigenerational and has been affecting the communities of color, mostly African American, for approximately a century now. This paper correlates the historical HOLC map of redlining the neighborhoods with demographic along with environmental Justice Index data to demonstrate the extent of the adverse consequences of segregation policies on the selected neighborhoods, most importantly in terms of environmental issues.

1.0 METHODOLOGY

The paper reviews literature and relevant datasets to analyze the extent that systematic racism and redlining policies have had on environmental injustices in the two cities of Cleveland and Detroit. Neighborhoods from each city are selected to further analyze and compare the data that best represents the correlation between redlining policies and environmental problems. The paper used data from multiple sources, including the Census Bureau, the U.S. Environmental Protection Agency, and the Department of Housing and Urban Development.

Various environmental justice indexes are analyzed in the paper, such as tree canopies, air toxic cancer risk, traffic proximity and volume, superfund, hazardous waste, RMP proximities, lead paint, along with the information on population, income per capita, and percentages of poverty and people of color.

Aside from the quantitative data analysis, some information from the interviews conducted with the residents of these neighborhoods is also included in the findings.

1.1. Case Study Analysis

The paper examines selected neighborhoods of Central in the Cleveland Metropolitan area, and Delray and Boynton in Detroit, which have both received D grading from redlining policies. [Figure 1] Central is a neighborhood on the East side of Cleveland on the outskirts of downtown. Initially hosting many European working classes, its African American population rose from 8,448 in 1910 to 34,451 in 1920 since World War I (Encyclopedia of Cleveland History 2019). With the creation of the first public housing administration, the Cleveland Metropolitan Housing Authority (CMHA), many public housing projects were built in the neighborhood. The two projects of Outhwaite Homes and Cedar-Central were built, the former for African Americans and the latter for the White, which subsequently segregated the community in the neighborhood (Rothstein 2017). Later the redlining policies by the Homeowners Loan Corporation exacerbated the segregation and stopped the African American population from moving to the suburbs.

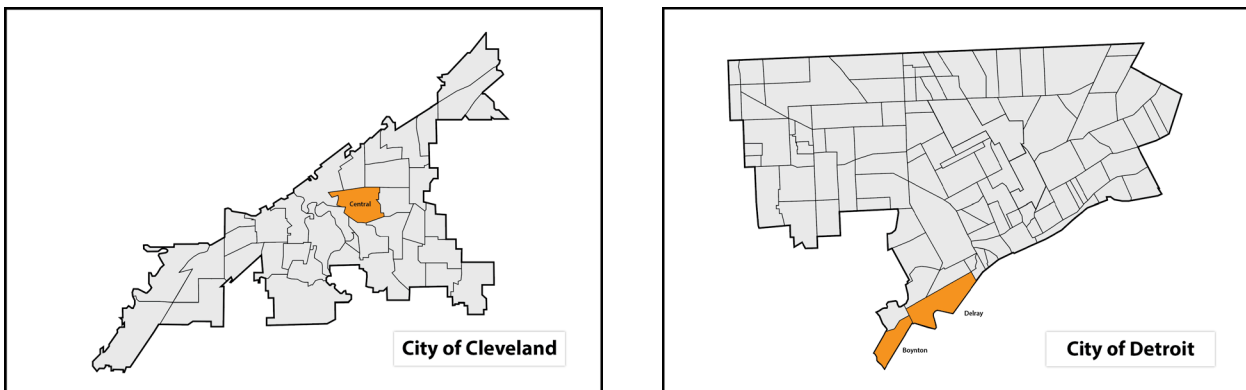

Figure 1: The selected neighborhoods of the Central in Cleveland and Boynton and Delray in Detroit. Source: (Author 2022)

Delray is southwest of Detroit, which is enclosed by the River Rouge, I-75, Fort Wayne, and Zug Island. Heavy industry came to the neighborhood in the late 19th century, which resulted in an increase in population. During WWII, manufacturing in Detroit grew and created a lot of blue-collar jobs. From 1940 to 1943, the unemployment number dropped by 131,000 people. In 1940, a wastewater plant opened in Delray, which caused the major demolition of many residential (Thoams & Bekkering 2015). This followed the migration of many residents from Delray to the suburbs, following the same pattern that took place in other neighborhoods of the city of Detroit. The main population loss happened in Delray during the 1960s when the neighborhood lost 25% of its people compared to 7.5% for Detroit (A Local Response to the Detroit River International Crossing 2007). The decision to build Interstate 75 also destroyed many more housing units. By this time, the neighborhood suffered greatly from population loss and pollution. In 1963, a federal study of Detroit’s riverfront suggested that the neighborhood of Delray become fully industrial. However, many residents protested against a planned incinerator at the site of Solway Process Co. and ultimately stopped the process. According to the US Environmental Protection Agency (EPA) EJ Screen ACS summary report of 2016-2022, Delray’s population is around 2,000, with 72% people of color and a per capita income of about 13,350. [Table 1]

Table 1: Population, % People of Color, Income Per Capita of the selected neighborhoods in Detroit and Cleveland. Source: (EPA)

Neighborhoods	Population	% People of Color	Income Per Capita
Delray (Detroit, Michigan)	1,994	72%	\$13,351

Neighborhoods	Population	% People of Color	Income Per Capita
Boynton (Detroit, Michigan)	6,508	96%	\$20,687

Neighborhoods	Population	% People of Color	Income Per Capita
Central (Cleveland, Ohio)	10,187	93%	\$8,545

Like Delray, Boynton is also located southwest of the city of Detroit and is heavily industrialized, with the only petroleum refinery of Marathon and other industries such as Asphalt plants, steel manufacturing, and a coal-fired power plant. Boynton, along with Oakwood Heights, occupies the 48217 Zip Code, which is the most polluted one in the state of Michigan. As it’s seen in the table above, the population of the neighborhood comprises more than 90% of people of color, who are mainly African Americans. The per capita income of the population is approximately between 18 to 22 thousand.

2.0 HISTORY OF REDLINING POLICIES IN DETROIT AND CLEVELAND

In the 1930s, the US government targeted neighborhoods where predominantly African Americans resided by labeling them as “hazardous” for investment. These areas were labeled as “D” or “Fourth Grade,” whereas neighborhoods,

where White residents lived were graded as “A” or “First Grade.” Areas that were adjacent to African American residents or had diverse immigrant populations were also given a low grade, making them ineligible for housing investments from the government. For example, in Detroit, neighborhoods such as Arden Park were graded “C” or “Third Grade” even though they had white residents because of their proximity to D-graded neighborhoods (Gonzalez et al. 2022). Research by University Hospitals in Cleveland also correlated the impact of redlining in 200 American cities to “poor health outcomes, including heart disease, kidney failure, and diabetes” (1930s Redlining Connected to Poor Health Outcomes Today 2022). Dr. Al-Kindi, the author of the study, found that only two grade A neighborhoods in Cleveland had a “high prevalence of coronary heart disease, stroke, or chronic kidney disease” (Kroen & Smith 2022) In contrast, 65% of graded D areas had similar health effects. The impact of discriminatory government policies had a lasting influence on American cities, and today, we can see the stark segregation it has created and the damage it has caused to predominantly colored neighborhoods.

3.0 FINDINGS

The results of the correlation study of redlining and data sets mentioned in the methodology section of the paper along with the qualitative analyses of interviews are categorized into three sets of findings which include: 1) The lack of vegetation and tree canopies, proximity to industrial sites and waste hazards, and housing segregation and lead poisoning.

3.1. Lack of Vegetation and Tree Canopies

Urban centers absorb the sun’s heat at greater levels than areas that have fewer buildings and concrete surfaces. As a result, they tend to have higher temperatures than non-urban spaces. One of the key solutions to tackle the heat island effect is through the use of tree canopies. However, the distribution of trees within urban centers is typically unequal, with certain neighborhoods having a greater number of trees, resulting in up to 12 degrees Celsius cooler land surface temperatures (Schwaab et al. 2021). The temperature on average in large cities compared to rural areas is about 1 to 3 degrees Celsius. On the other hand, the surface temperature is 10 to 20 degrees Celsius higher than the air temperature (Climate change impacts on urban heat).

A healthy goal for cities is to reach a 30% coverage of tree canopy with a combination of public, private, and industrial tree planting initiatives (Climate change impacts on urban heat). Cities can reach this goal by looking at neighborhoods

with lower socio-economic status, typically with lower tree canopy coverage. For example, an analysis conducted by American Forests demonstrated neighborhoods, where most people live in poverty have 25% less tree canopy than those who have an income of \$100k-\$250K. In certain areas, the disparity between wealthy areas and areas where people live in poverty becomes 65% more tree canopy (Tree Equity Score Methodology).

In addition to having less tree canopy, poorer neighborhoods and communities of color also tend to be in proximity to industrial areas and highways that create pollution and contribute to increased heat. There is also a correlation between urban heat and neighborhoods of color as a result of redlining. An analysis of 37 urban areas compares the level of tree canopy today to how they were graded by the Federal Home Owners Loan Corporation (HOLC) during the redlining period. The areas that housed lower socio-economic communities, which were graded D, have on average, 23% tree canopy today, whereas neighborhoods that are more prominently white and were graded A have, on average, 43% tree canopy (Locke 2020).

Redlining has affected both the city of Detroit and the city of Cleveland and as a result, their tree canopy map has also been impacted by the discriminatory regulations put in place in the 1930s. According to Eric Candela, manager of the Community ReLeaf program for American Forest, 30% tree canopy is the minimum level of canopy required to be considered a healthy city (Allnutt & Ignaczak 2022). In 2020, Detroit's tree canopy was 24%, while Cleveland's was 19%. But only Cleveland has a formal plan to reach 30% coverage by the decade's end. On the other hand, not all parts of the city are impacted by the island heat effect. In Cleveland, neighborhoods such as Shaker Heights has a canopy of 42% (Schneck 2020). Shaker Heights neighborhood had an A grade, according to the HOLC, and it has a very low percentage of people of color.

The maps below show the tree canopy percentages in the selected neighborhoods of Detroit and Cleveland in correlation with the poverty and people of color percentages. [Figure 2]

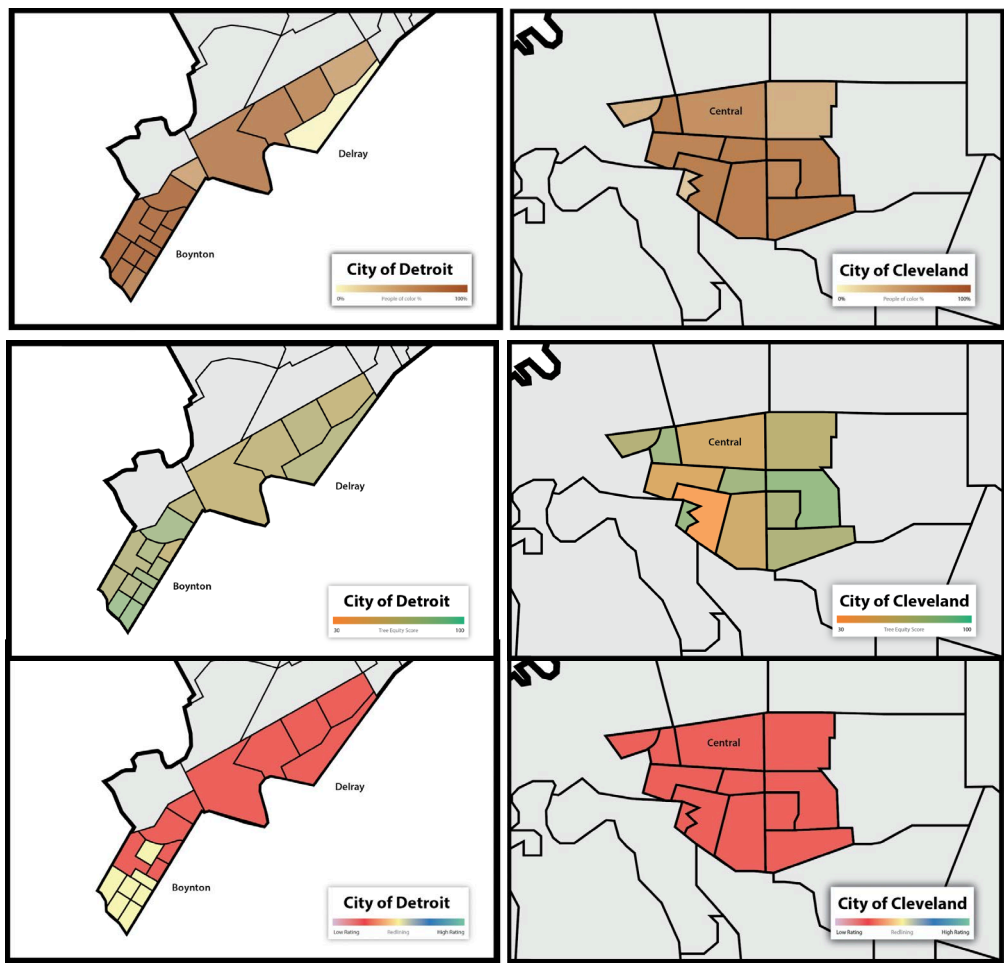

Figure 2: Percentages of poverty and tree canopies in relation to redlining in the selected neighborhoods. Source: (Tree Equity Score, author 2022)

3.2. Proximity to Toxic Industrial Sites and Waste Hazards

Communities of color and poor neighborhoods are typically exposed to more air pollution, and studies show that they are near hazardous waste sites and industries.

In the case of Detroit, both Boynton and Delray neighborhoods are in proximity to Marathon Petroleum Oil refinery and adjacent to Interstate 75, which creates noise and air pollution. The air pollution is also created by heavy traffic, mostly trucks which travel from the expressway to Canada via the Ambassador Bridge outside of Delray. A new bridge, Gordie Howe International, was proposed in 2013 to connect Detroit to the Windsor area, and Delray became the site for it. As the construction of the bridge started, many Delray residents were impacted and had to be relocated.

In the early 20th century, the riverfront attracted many industries to Delray, reshaping the village of Delray into an industrial town. Some examples include Detroit Iron Works, which was built on Zug Island, Detroit Edison, which opened a power plant, Allied Chemical, and Peerless Portland Cement Co., among others. [Table 2] demonstrates the list of TRI facilities existing in both neighborhoods. According to EPA, “The Toxics Release Inventory (TRI) compiles data on the quantities of chemicals included on the TRI list of toxic chemicals that are released into the environment or otherwise managed as waste by certain industrial and federal facilities.” (Toxics Release Inventory 2019). The zip code 48217 is the most polluted in the state of Michigan. According to Michelle Martinez, who is the coordinator of the Michigan Environmental Justice Coalition, “Detroit is a microcosm of the national and global crisis on climate change” (Costley 2020).

Table 2: TRI sites in the selected neighborhoods in Detroit (The top table belongs zip code 48217; the bottom table belongs to zip code 48209 – Only sites with stars are in the studied boundary.) Source: (EPA)

TRI Facility Name	Industry sector used in TRI Explorer analysis in 2021 Reporting Year
CADILLAC ASPHALT LLC	Petroleum
EDW C LEVY CO - PLANT 6	Mineral Product
AIR PRODUCTS & CHEMICALS INC/DETROIT HYDROGEN FACILITY	Chemicals
MARATHON PETROLEUM CO LP - MICHIGAN REFINING DIV	Petroleum

TRI Facility Name	Industry sector used in TRI Explorer analysis in 2021 Reporting Year
* ST MARY'S CEMENT INC	Nonmetallic Mineral Product
* SUPERIOR MATERIALS 32	Nonmetallic Mineral Product
* PLANT 820 - DETROIT SPRINGWELLS	Nonmetallic Mineral Product
EDW. C. LEVY CO. - PLANT 1	Nonmetallic Mineral Product
MAGNI INDUSTRIES INC.	Chemicals

People in these neighborhoods have a higher rate of asthma and cancer compared to others. According to a report on Disparities in Michigan’s Asthma Burden by the Michigan Department of Health and & Human Services (MDHSS), Asthma hospitalization rates for Black children and adults are more than three times the rates for White children and adults from 2011-2013. Also, asthma deaths for Black people occur at a rate of 3.2 times that of White people (Wisnieski et al. 2016).

The City of Cleveland, like Detroit, has also suffered from sprawl and industrial pollution. According to the 2017 report by the American Lung Association, the Cleveland-Akron-Canton metro area is ranked nine among the most air-polluted cities. The central neighborhood is one of the most affected areas in Cleveland. Redlining of the neighborhoods up until today has had an impact on their air quality, especially the ones with a high percentage of African Americans. The table below compares the selected neighborhoods in terms of the environmental justice indexes that create pollutants and risk people's health. [Table 3]

Table 3: Environmental Justice Indexes compared in neighborhood, state, and nation scales. Source: (EPA)

Delray (Detroit, Michigan)	Value	State Avg.	%ile in State	USA Avg.	%tile in USA
Air Toxics Cancer Risk (risk per MM)	40	23	99	28	95-100th
Traffic Proximity and Volume (daily traffic count/distance to road)	3,500	910	95	760	95
Superfund Proximity	0.063	0.150	53	0.13	51
Hazardous Waste Proximity (facility count/km distance)	6.7	1.1	99	2.20	91
RMP Proximity (facility count/km distance)	3.8	0.5	99	0.77	97

Boynnton (Detroit, Michigan)	Value	State Avg.	%ile in State	USA Avg.	%tile in USA
Air Toxics Cancer Risk (risk per MM)	30	23	99	28	80-90th
Traffic Proximity and Volume (daily traffic count/distance to road)	2,242	910	77	760	84
Superfund Proximity	0.083	0.150	63	0.13	60
Hazardous Waste Proximity (facility count/km distance)	3.5	1.1	90	2.20	80
RMP Proximity (facility count/km distance)	4.9	0.5	99	0.77	97

Central (Cleveland, Ohio)	Value	State Avg.	%ile in State	USA Avg.	%tile in USA
Air Toxics Cancer Risk (risk per MM)	30	24	99	28	80-90th
Traffic Proximity and Volume (daily traffic count/distance to road)	1,710	430	82	760	76
Superfund Proximity	0.022	0.093	26	0.13	21
Hazardous Waste Proximity (facility count/km distance)	11.0	1.7	99	2.20	96
RMP Proximity (facility count/km distance)	2.7	0.8	93	0.77	93

3.3. Housing Segregation and Lead Poisoning

Lead poisoning within residential properties can have a severe impact on one's health and well-being. As a result, government health departments keep track of areas where communities, particularly children, can become exposed to such materials. For example, the Ohio Department of Health tests about 160,000 children less than six years of age, and less than 3 percent have elevated levels of lead in their blood. However, certain areas are affected at a higher level than others.

In the City of Cleveland, the Ohio Department of Health has mapped the areas that are at high-risk for exposure to lead poisoning. There is an overlay between high-risk areas and neighborhoods with predominantly people of color residents. Cleveland Clinic considers Cleveland as the “epicenter of this public health crisis,” with four times the national average when it comes to lead poisoning (Why Lead Safety Has Become Cleveland Clinic’s Top Priority 2022)

In Detroit, one study found that “investor-owned homes purchased through tax foreclosure sale” expose children to higher blood lead levels, impacting racialized and low-income communities (Eisenberg et. Al 2020). After the water contamination crisis in Flint, Michigan, the number of parents testing their kids increased, leading to 28% jump in lead poisoning in children under 6 (Rochester 2017).

Overall, redlining in the 1930’s segregated people of color and lower-income neighborhoods from areas where wealthy white resided. The discriminatory policies limited access to federal investments and prevented homeownership in low-income communities. The concentrations of low-income individuals can today be overlapped with areas affected by lead positioning. [Table 4]

Table 4: Lead poisoning, an environmental justice index compared in the three selected neighborhoods. Source: (EPA)

Neighborhoods	Value	State Avg.	%ile in State	USA Avg.	%tile in USA
Delray (Detroit, Michigan)	0.71	0.37	80	0.27	86
Boynnton (Detroit, Michigan)	0.75	0.37	83	0.27	88
Central (Cleveland, Ohio)	0.51	0.40	58	0.27	73

CONCLUSION

This paper evaluates the cities of Cleveland and Detroit through a mapping exercise that correlates the impact of redlining with environmental injustices in neighborhoods with African American residents and other communities of color. The areas that were graded “D” during the redlining implementation were predominantly African American. Today, black people live in these neighborhoods that suffer from environmental discrimination. While redlining was a significant policy that laid the foundation for these injustices, some other policies and initiatives also contributed, such as urban renewal, intentional placement of highways, heavy industries, and hazardous waste sites. Generations of Black people have faced racism in America. Through this work, we can concretely see the impact of systematic environmental racism that has devastated the livelihood of these communities. The findings of this paper demonstrate correlations between the sources of environmental injustice and redlining policies. Hence, the solutions that can make a difference to these communities will also have to be systematic and at the same scale. Furthermore, redlining was a federal policy directly

linked to investment and financial support. Therefore, the resolutions also have to have the same level of investment to reverse the discriminatory impact that has created environmental segregation across cities in America.

REFERENCES

- "A local Response to the Detroit River International Crossing." *Urban and Regional Planning Program*, University of Michigan, 2007.
- Allnutt, B, Ignaczak, N. "Why Detroit needs a plan for tree equity." *Planet Detroit*, February 2022.
- Bullard, Robert Doyle. 1994. *Unequal Protection: Environmental Justice and Communities of Color*.
- "Climate change impacts on urban heat." *NSW Government*.
<https://www.climatechange.environment.nsw.gov.au/urban-heat>.
- Costley, D. "The blackest city in the US is facing an environmental justice nightmare." *The Guardian*, 2020.
- Cuda Kroen, Gretchen, and Smith, Zachary. 2022. "UH Researchers Find Near Century-Old Redlining Discriminatory Housing Policies Leave Lasting Legacy on Modern Day Heart Health." *cleveland.com*.
- Eisenberg, Alexa, Eric Seymour, Alex B. Hill, and Joshua Akers. 2020. "Toxic Structures: Speculation and Lead Exposure in Detroit's Single-Family Rental Market." *Health & Place* 64: 102390–10.
- "Factors to Consider When Using Toxics Release Inventory Data." *US Department of Health and Human Services, Toxic Release Inventory*, 2019.
- Gelobter, Michel. 1994. "The Meaning of Urban Environmental Justice." *The Fordham Urban Law Journal* 21 (3): 841–56.
- Gonzalez, David J X, Anthony Nardone, Andrew V Nguyen, Rachel Morello-Frosch, and Joan A Casey. 2022. "Historic Redlining and the Siting of Oil and Gas Wells in the United States." *Journal of Exposure Science & Environmental Epidemiology*.
- Locke, Dexter H., Billy Hall, J. Morgan Grove, Steward T. A. Pickett, Laura A. Ogden, Carissa Aoki, Christopher G. Boone, and Jarlath P. M. O'Neil-Dunne. 2021. "Residential Housing Segregation and Urban Tree Canopy in 37 US Cities." *Npj Urban Sustainability* 1 (1).
- Massey, D. S., and N. A. Denton. 1988. "The Dimensions of Residential Segregation." *Social Forces* 67 (2): 281–315.
- Mohai, Paul, Paula M Lantz, Jeffrey Morenoff, James S House, and Richard P Mero. 2009. "Racial and Socioeconomic Disparities in Residential Proximity to Polluting Industrial Facilities: Evidence From the Americans' Changing Lives Study." *American Journal of Public Health (1971)* 99 (S3): S649–S656.
- "1930s "Redlining" connected to poor health outcomes today." *University Hospitals*, July 2022.
- Rochester, M. J. "Lead poisoning in children under 6 jumped 28% in Detroit in 2016." *Detroit Free Press*, November, 2017.
- Rothstein, Richard. 2017. *The Color of Law : a Forgotten History of How Our Government Segregated America*. First edition. New York ; London: Liveright Publishing Corporation, a division of W.W. Norton & Company.
- Schneck, Ken. "Cleveland's plan to grow its tree canopy." *Cleveland Magazine*, July 2020.
- Schwaab, Jonas, Ronny Meier, Gianluca Mussetti, Sonia Seneviratne, Christine Bürgi, and Edouard L Davin. 2021. "The Role of Urban Trees in Reducing Land Surface Temperatures in European Cities." *Nature Communications* 12 (1): 6763–6763.
- "Siting of Hazardous Waste Landfills and Their Correlation With Racial and Economic Status of Surrounding Communities." *United States General Accounting Office*, 1983.
- Thomas, June Manning, and Henco Bekkering, eds. 2015. *Mapping Detroit: Land, Community, and Shaping a City*. Detroit: Wayne State University Press.
- "Tree Equity Score Methodology." *Tree Equity Score*, <https://www.treeequityscore.org/methodology/>.
- "Why Lead Safety Has Become Cleveland Clinic's Top Priority for Community Health." *Cleveland Clinic*, January 2022.
- Wisniewski L, Strane D, Anderson B, Wahl R, and Garcia E. "Disparities in Michigan's Asthma Burden. Lansing, Michigan: Bureau of Disease Control, Prevention, and Epidemiology." *Michigan Department of Health and Human Services*, 2016.

Estimating the Relative Benefit of Local Climate Change Policies to Neighborhood Social Vulnerability

Adele Houghton^{1,2}, Brett Turner¹

¹Harvard T.H. Chan School of Public Health, Boston, MA
²Biositu, LLC

ABSTRACT: The health effects of climate change are felt most acutely at the local level – particularly among low income and marginalized communities. Despite differences in environmental exposures and population health needs from one neighborhood to the next, climate change funding and building/land use policies continue to take a one-size-fits-all approach to greenhouse gas emissions and community resilience.

Seven years after the adoption of the Paris Climate Change Agreement worldwide, most cities in the U.S. are not on track to meet related targets for carbon neutrality and community resilience. The hypothesis motivating the study presented in this paper is that building design and operations could accelerate local government progress around climate and health goals and chronic disease goals (a related public health consideration) if they used research on how to identify neighborhood social and environmental health vulnerabilities to guide the green and healthy building strategies incorporated into the building and site design.

This paper will share the results of a difference-in-difference analysis comparing improvements in key climate and health and chronic disease indicators in the 500 largest cities in the U.S. before and after the We Are Still In Declaration that committed local actors such as communities to work toward the goals in the Paris Climate Agreement regardless of federal action on the topic. A secondary analysis estimates the differential impact of local policies on neighborhoods with varying levels of social vulnerability.

The study concluded that additional benefit that would have accrued if, rather than taking a one-size-fits-all-approach, local climate change policies targeting the built environment had been tailored to address the needs of the highest vulnerability census tracts, as defined by the CDC/ATSDR Social Vulnerability Index.

KEYWORDS: climate change, chronic disease, social vulnerability, green building, healthy building

INTRODUCTION

On December 12, 2015, 196 countries signed the Paris Agreement at the 21st Conference of Parties, an annual meeting of signatories to the United Nations Framework Convention on Climate Change. The agreement set three goals for collective global action to address the existential threat posed by climate change: (1) Mitigating Climate Change: Limiting global warming to well below 2°C above pre-industrial levels. (2) Adaptation and Resilience: Increasing the ability of society to adapt and build resilience to the negative impacts of climate change. (3) Direct financial resources towards mitigation and adaptation/resilience efforts. Furthermore, the Agreement directed signatories to center population health and vulnerable populations in all climate action (United Nations 2015). While the U.S. signed the Paris Agreement in 2015 under President Barack Obama, on June 1, 2017 the new President, Donald Trump, declared that the U.S. would withdraw from the agreement (U.S. White House 2017).

Four days later, on June 5, 2017, a coalition of 1,219 cities, states, tribes, universities, cultural institutions, health care organizations, faith groups, and private companies responded by issuing the “We Are Still In Declaration” – a pledge to “support climate action to meet the Paris Agreement” regardless of the official position of the U.S. federal government (We Are Still In 2017b).

Many of the local policies designed to meet U.S. obligations under the Paris Climate Agreement target the built environment, because buildings are responsible for 40% of global greenhouse gas emissions (Global Alliance for Buildings and Construction, International Energy Agency, United Nations Environment Programme 2019). These changes were organized into three categories: changes to public infrastructure, changes to the building code, and changes to the building and zoning code (Figure 1). Aspects of local built environment policies that help make progress on the climate mitigation goal in the Paris Climate Agreement include: investment in multi-modal infrastructure; investment in electric vehicle (EV) infrastructure and incentive programs; changes to the building code that increase requirements for energy efficiency, insulation, weatherization, and electrification; and, incentives and allowances for on-site renewable power generation and storage. Local built environment policies that support efforts to adapt to the changing climate and increase built environment and social resilience in the face of increasingly frequent and severe climatic events include: investment in multi-modal infrastructure; building design strategies that reduce exposure to climatic events like heat and flooding and make it possible for buildings to function during power outages; enhanced ventilation and filtration requirements to reduce exposure to air pollution; and, landscaping strategies that reduce

exposure to extreme heat, flooding, air pollution, wildfire, vectors (like ticks and mosquitoes), and other climatic hazards. Many of the same policies have the potential to also reduce the negative health effects of climatic events – particularly if they are tailored to support groups who are particularly vulnerable to negative health outcomes after exposure. These policies include: multi-modal infrastructure to increase the number and redundancy of evacuation routes; investment in EV infrastructure and enhanced ventilation and filtration to reduce exposure to air pollution, which contributes to cardiovascular disease, respiratory diseases like asthma, and mental health conditions; insulation, weatherization, light colored/garden roofs, and site vegetation to slow the rate at which a building warms up during an extreme heat event after the power goes out; on-site renewable power and storage to make it easier for occupants to shelter in place during climatic events when the power goes out; and, flood mitigation requirements to protect occupants from injuries during flooding events and respiratory harm from exposure to mold after the flood.

Figure 1 maps the ways in which local built environment policies modify exposure to environmental hazards, both directly and mediated by three built environment determinants of health: vehicular traffic, age of building stock, and impervious surface. These environmental exposures, in turn, change the risk of certain population health outcomes, such as cardiovascular disease, obesity, asthma, heat-related illness, and mental health. The level of safety associated with bike/pedestrian environments and the level of access to parks/green space can also increase or decrease a population’s risk of cardiovascular disease and/or obesity, due to their influence over the likelihood that a population will participate in leisure physical activity. Finally, the risk of negative population health outcomes is increased for certain groups of people, such as the elderly, children, racial and ethnic minorities, communities with low socioeconomic status, families experiencing housing instability, and individuals who work outdoors, as a result of social and economic structures known as the social determinants of health (Schulz and Northridge 2004; World Health Organization 2007).

This study uses the Difference-in-Difference method to ask two questions. (1) Was local implementation of the Paris Climate Agreement associated with a change in population health outcomes on average in cities that adopted the We Are Still In pledge (the pledge)? (2) Were those changes consistent city-wide, or did neighborhoods with higher levels of social vulnerability experience different trends in health outcomes compared with neighborhoods with lower levels of social vulnerability?

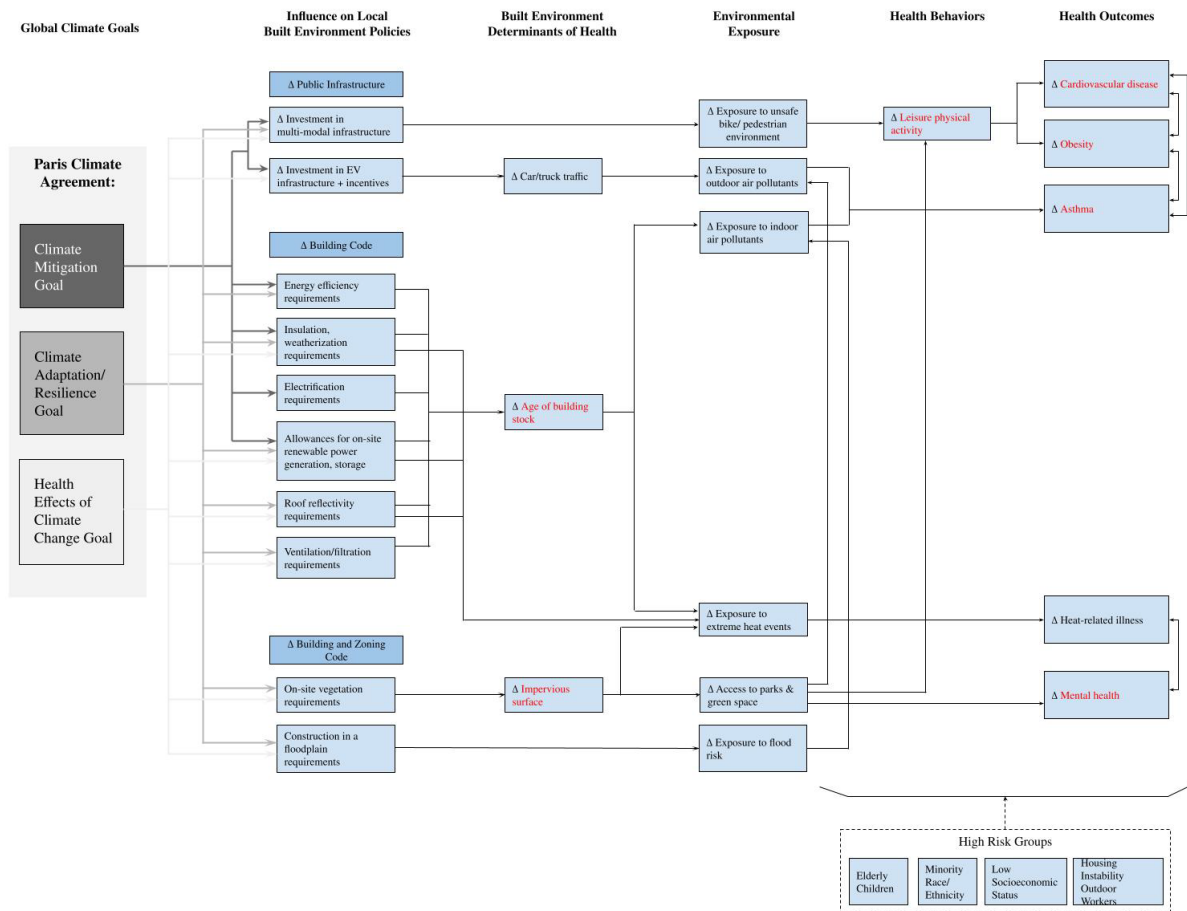

Figure 1: Logic Model Linking Global Climate Goals in the Paris Climate Agreement to Local Policies, Built Environment Determinants of Health, Environmental Exposures, Health Behaviors, and Health Outcomes. Source: (Adele Houghton 2022)

1.0 MATERIALS AND METHODS

1.1 Data Sources

We combined 10 data sources for this study: the 500 most populous cities in the U.S. according to the 2010 Census (U.S. Centers for Disease Control and Prevention 2019); the list of cities who signed the We Are Still In pledge (“We Are Still In” 2017a); 2015 and 2020 estimates of the percent of housing units built before 1950 by census tract based on American Community Survey 5-year estimates and accessed through the National Environmental Public Health Tracking Network data portal (U.S. Centers for Disease Control and Prevention n.d.); 2016 and 2021 estimates of the percent of developed impervious land by census tract based on data obtained from NLCD (National Land Cover Database) and accessed through the National Environmental Public Health Tracking Network data portal (U.S. Centers for Disease Control and Prevention n.d.); 2013/2014 and 2019/2020 census tract estimates for one health behavior (adults reporting no leisure physical activity over the past 30 days) and four population health outcomes (adult asthma, adult coronary heart disease, adult obesity, and adults reporting a poor mental health day over the past 14 days) based on data obtained from Behavioral Risk Factor Surveillance System (BRFSS), Census Bureau 2010 population data, and American Community Survey 5-year estimates and accessed from PLACES: Local Data for Better Health, U.S. Centers for Disease Control and Prevention (U.S. Centers for Disease Control and Prevention, n.d.); and, 2016 and 2020 census tract estimates of social vulnerability (U.S. database) obtained from the U.S. Centers for Disease Control and Prevention/ Agency for Toxic Substances and Disease Registry/ Geospatial Research, Analysis, and Services Program (Centers for Disease Control and Prevention/ Agency for Toxic Substances and Disease Registry/ Geospatial Research, Analysis, and Services Program 2022).

1.2. Characteristics of Pledge and Non-Pledge Cities

The authors sorted the cities included in the 500 Cities dataset (using U.S. Census 2010 population data) into cities that signed the We Are Still In pledge (pledge cities) and cities that did not (non-pledge cities). As shown in Table 1, the resulting two groups include a range of geographies, political parties, and population size (although pledge cities skew larger – i.e., more census tracts per city – than non-pledge cities).

128 cities, including 14,501 census tracts, were designated as pledge cities. 372 cities, including 12,475 census tracts, were designated as non-pledge cities. Census tracts from Honolulu, HI were removed from the data set due to missing values in the Social Vulnerability Index (SVI). Roughly 58% of the highest vulnerability census tracts (SVI05) and 54% of the second highest vulnerability census tracts (SVI04) were located in cities that signed the pledge, during both the pre- and post-periods (Table 2). 36 states are home to both pledge and non-pledge cities within the 500 Cities dataset. Only Alaska (R), Maryland (R), Vermont (R), and Washington, D.C. (D) had only pledge cities in the dataset. 11 states (Alabama (R), Delaware (D), Maine (D), Mississippi (R), Montana (R), New Hampshire (R), North Dakota (R), Oklahoma (R), South Dakota (R), West Virginia (R), Wyoming (R)) included only non-pledge cities in the 500 Cities dataset. The “R” and “D” in parentheses above indicate the political party of each state’s governor and Washington, D.C.’s mayor prior to the 2022 midterm elections (“National Governors Association” 2022). All three of the states with only pledge cities have Republican governors. And, three of the 12 with only non-pledge cities have Democratic governors.

Table 1: Pledge and Non-pledge Cities, Sorted by Number of Census Tracts, Number of Cities, and Number of Cities by State

	<i>Pledge Cities</i>	<i>Non-pledge Cities</i>		<i>Pledge Cities</i>	<i>Non-pledge Cities</i>
Number of Census Tracts	14,501	12,475			
Number of Cities	128	372			
Number of Cities by State					
Alabama	0	6	Montana	0	2
Alaska	1	0	Nebraska	1	1
Arizona	3	9	Nevada	1	4
Arkansas	2	5	New Hampshire	0	2
California	19	121	New Jersey	3	6
Colorado	5	9	New Mexico	2	2
Connecticut	3	5	New York	8	1
Delaware	0	1	North Carolina	5	9
Washington, DC	1	0	North Dakota	0	1
Florida	10	23	Ohio	3	6
Georgia	2	9	Oklahoma	0	6
Hawaii*	1	0	Oregon	3	5
Idaho	1	2	Pennsylvania	4	3
Illinois	3	15	Rhode Island	1	3
Indiana	5	6	South Carolina	2	3
Iowa	2	4	South Dakota	0	2
Kansas	1	6	Tennessee	2	4

Kentucky	1	1	Texas	5	42
Louisiana	2	4	Utah	8	1
Maine	0	1	Vermont	1	0
Maryland	1	0	Virginia	2	9
Massachusetts	6	7	Washington	3	11
Michigan	3	13	West Virginia	0	1
Minnesota	3	4	Wisconsin	3	4
Mississippi	0	2	Wyoming	0	1
Missouri	3	5			

* Excluded from dataset, because missing data.

Table 2. Number and Percent of Census Tracts in Pledge and Non-pledge Cities Before and After the We Are Still In Pledge.

	Period Before Pledge			Period After Pledge		
	Pledge Cities	Non-pledge Cities	Total Census Tracts	Pledge Cities	Non-pledge Cities	Total Census Tracts
SVI01 (lowest vulnerability)	3,055 (51.6%)	2,868 (48.4%)	5,924	2,128 (52.9%)	1,895 (47.1%)	4,023
SVI02	2,760 (50.5%)	2,705 (49.5%)	5,465	2,377 (52.7%)	2,133 (47.3%)	4,510
SVI03	2,758 (52.9%)	2,457 (47.1%)	5,215	2,621 (54.8%)	2,161 (45.2%)	4,782
SVI04	2,918 (55.4%)	2,348 (44.6%)	5,266	2,615 (54.8%)	2,154 (45.2%)	4,769
SVI05 (highest vulnerability)	3,009 (58.9%)	2,096 (41.1%)	5,105	2,862 (57.8%)	2,091 (42.2%)	4,953
Total	12,475 (46.3%)	14,500 (53.8%)	26,975	12,603 (54.7%)	10,434 (45.3%)	23,037

Note: Percentage in parentheses. 3,938 census tracts were not included in the analysis, because they were missing data for the post-period.

1.3. Statistical Analysis

Stata Standard Edition 17.0 (StataCorp, College Station, TX) was used to perform an ecological Difference-in-Difference analysis in order to isolate differential changes in the probability of two built environment determinants of health (age of housing stock and impervious surface), one health behavior (adults reporting no leisure physical activity), and four population health outcomes (adult asthma, adult coronary heart disease, adult obesity, and adults reporting a poor mental health day over the past 14 days) among cities who signed the pledge (pledge cities) compared with cities who did not sign the pledge (non-pledge cities) before and after the We Are Still In Declaration was issued in 2017 (Equation 1).

$$\text{Equation 1: } Outcome_{ijt} = \alpha + \beta Post_{jt} + \gamma Policy_{jt} + \delta (Post_{jt} * Policy_{jt}) + \eta City_j + \lambda Post_t + \varepsilon_{ijt}$$

where $Outcome_{ijt}$ is the built environment determinant of health, health behavior, or population health outcome (measured at the census tract level); $Post_{jt}$ is an indicator variable for the pre- or post-We Are Still In Declaration timeframe (i.e., before or after the Declaration’s publication in 2017); $Policy_{jt}$ indicates whether a city is a pledge or non-pledge city; and, $\eta City_j$ and $\lambda Post_t$ absorb unobserved, time-invariant differences between cities (i.e., fixed effects).

In order to understand whether neighborhoods with higher levels of social vulnerability experienced different trends in health outcomes compared with neighborhoods with lower levels of social vulnerability, a second series of Difference-in-Difference estimates were generated that controlled for census tract social vulnerability and stratified the outcomes by quintiles of social vulnerability (Equation 2).

$$\text{Equation 2: } Outcome_{ijt} = \alpha + \beta Post_t + \gamma Svi_{catijt} + \gamma Policy_{jt} + \delta (Post_t * Policy_{jt} * Svi_{catijt}) + \eta City_j + \lambda Post_t + \varepsilon_{it}$$

All regression models calculated robust standard errors clustered at the city level.

2.0 RESULTS

2.1. City-wide Difference-in-Difference

The analysis found statistically significant differences in the average scores for all built environment, health behavior, and population health outcomes, between census tracts in the group of cities that signed the pledge (treatment group)

and the group that did not (control group) (Table 3). The differences were particularly large for the two built environment determinants of health (pre-1950 housing and impervious surface) and the health behavior (leisure physical inactivity).

On average, census tracts in cities that did not sign the pledge had four times the percentage of pre-1950 housing (24.07% compared with 6.042%), 1.5 times less impervious surface (29.01% compared with 46.36%), and almost twice the percentage of adults reporting no leisure physical activity (30.35% compared with 18.79%) in the pre-pledge period as cities that signed the pledge.

Differences between the treatment and control groups pre-pledge were smaller for health behavior and health outcome variables, but still statistically significant. Adults living in cities that did not sign the pledge were estimated to experience higher rates of asthma (10.6% compared with 8.88%), coronary heart disease (7.541% compared with 4.417%), obesity (38.35% compared with 27.64%), and poor mental health (14.9% compared with 9.782%), on average, than adults living in cities that signed the pledge.

Signing the We Are Still In pledge was associated with reducing adult asthma by 0.354 percentage points, reducing adult coronary heart disease by 0.069 percentage points, and reducing adult obesity by 1.809 percentage points. Results were not statistically significant for either of the built environment determinants of health (pre-1950 housing and impervious surface), the health behavior variable (leisure physical inactivity), and one health outcome (poor mental health).

2.2. Difference-in-Difference, Stratified by SVI Quintile

When the difference in slope between pledge and non-pledge cities was stratified by SVI quintile, a different picture emerged (Table 3).

Signing the We are Still In pledge was associated, on average, with a 3.15 percentage point increase above the 15.842 percentage point increase in pre-1950 housing from the pre- to post- period in census tracts with the lowest quintile of social vulnerability; a 1.838 percentage point reduction in the 5.463 percentage point increase in census tracts in the 4th quintile; and, a 3.277 percentage point reduction in the 6.798 percentage point increase in census tracts with the highest levels of vulnerability. Results for SVI02 and SVI03 were not statistically significant.

Only census tracts in the highest vulnerability quintile returned statistically significant results for impervious surface. In that case, signing the We Are Still In pledge was associated, on average, with a 1.578 percentage point reduction in the 15.242 percentage point increase in impervious surface from the pre- to post- period.

The rate of increase in all of the health behavior and health outcome variables from the pre- to post- periods accelerated on average from lowest to highest social vulnerability quintiles. All of these results were statistically significant except in the lowest quintile of social vulnerability for adult asthma. The average effect of signing the pledge when stratified by SVI quintile was not consistent across all health behavior and health outcome variables.

The effect of signing the pledge also increased from the lowest to highest vulnerability census tracts among the statistically significant results. However, the reduction attributable to signing the pledge was not sufficient to account for the acceleration from one strata of vulnerability to the next. For example, adult obesity increased, on average, by 9.23 percentage points from the pre- to post- periods in the second highest vulnerability category (SVI04) and by 12.815 percentage points in the highest vulnerability category (SVI05). Signing the pledge was associated with reducing the acceleration in SVI05 by 1.914 percentage points – not the 3.585 that would be required to slow the acceleration to the rate of SVI04 census tracts. This pattern was repeated in adult asthma (where signing the pledge was associated with a 0.404 percentage point reduction in the 3.077 percentage point acceleration in adult asthma prevalence in SVI05 compared with a 2.206 percentage point acceleration in SVI04), and poor mental health (where signing the pledge was associated with a 1.29 percentage point reduction in a 6.947 percentage point acceleration in SVI05 compared with a 4.997 percentage point acceleration in SVI04).

Statistically significant results for the other end of the spectrum – the lowest vulnerability census tracts (SVI01) – were also striking, although less consistent than SVI05. For example, the lowest vulnerability census tracts were associated with the highest percentage acceleration of pre-1950 housing (a 15.842 percentage point increase) and signing the pledge further accelerated that increase by 3.15 percentage points. The acceleration of impervious surface was also highest in SVI01 compared with other vulnerability strata. And, SVI01 was the only vulnerability stratum that returned a statistically significant decrease in negative trends from the pre- to the post- period for four variables: adult leisure physical inactivity, adult coronary heart disease, adult obesity, and adults with poor mental health. The effect of signing the pledge was less consistent for SVI01. It was associated with a 0.221 percentage point reduction in the adult asthma trend, a 1.446 percentage point further reduction in the adult obesity downward trend of 1.527 percentage points, a 0.722 percentage point further reduction in the 5.591 percentage point downward trend in leisure physical inactivity, and a 0.598 percentage point increase in the 2.27 percentage point downward trend in adult poor mental health.

Table 3: Results of Difference-in-Difference Model, City-wide and By SVI Quintile

	<i>Signed Pledge</i>		<i>Did Not Sign Pledge</i>		<i>Difference in Slope</i>	<i>Difference in Slope by SVI Quintile (Slope by SVI Quintile)</i>				
	<i>Pre</i>	<i>Post</i>	<i>Pre</i>	<i>Post</i>		<i>SVI01</i>	<i>SVI02</i>	<i>SVI03</i>	<i>SVI04</i>	<i>SVI05</i>
<i>Built Environment Determinants of Health</i>										
<i>Pre-1950 Housing</i>	6.042 ***	5.407* **	24.07* **	16.168	-0.592	3.15*** (15.842***)	0.680 (-0.385)	0.141 (1.682**)	-1.838** (5.463***)	-3.277*** (6.798***)
<i>Impervious Surface</i>	46.36 ***	51.553 ***	29.01* **	48.548 ***	0.309	1.365 (19.45***)	0.313 (5.432***)	0.041 (9.075***)	-0.680 (12.085***)	-1.578* (15.242***)
<i>Health Behaviors and Health Outcomes</i>										
<i>Adult Asthma</i>	8.880 ***	9.201 **	10.600 ***	11.275 ***	-0.354**	-0.221* (-0.007)	-0.274* (0.649***)	-0.320* (1.363***)	-0.369* (2.206***)	-0.404** (3.077***)
<i>Adult Coronary Heart Disease</i>	4.417 ***	4.076 ***	7.541 ***	7.270 ***	-0.069*	-0.100 (-1.576***)	-0.098 (0.302***)	-0.033 (0.757***)	-0.023 (1.360***)	-0.048 (2.006***)
<i>Adult Obesity</i>	27.64 ***	29.423 ***	38.35 ***	41.943 ***	-1.809***	-1.446*** (-1.527***)	-1.616*** (2.359***)	-1.541** (5.490***)	-1.674* (9.230***)	-1.914* (12.815***)
<i>Adults Reporting No Leisure Physical Activity</i>	18.79 ***	18.541	30.35 ***	29.991	-0.213	-0.722* (-5.591***)	-0.779** (3.381***)	0.122 (7.511***)	0.419 (12.433***)	0.768 (17.410***)
<i>Adults Reporting Poor Mental Health Days</i>	9.782 ***	12.361 ***	14.90 ***	17.901 ***	-0.423	0.598*** (-2.270***)	0.300 (1.538***)	-0.222 (3.163***)	-0.798** (4.997***)	-1.290*** (6.947***)

Note: * p<0.05, ** p<0.005, *** p<0.0005

3.0 DISCUSSION

The difference in difference analysis found statistically significant differences in built environment determinants of health, health behavior, and health outcomes between cities who signed the We Are Still In pledge and cities that did not, in spite of the diversity in geography and population in both groups. These differences were present in the period before the pledge.

Interestingly, cities that signed the pledge were associated during the pre-pledge period with lower percentages of pre-1950 housing, higher impervious surface, lower adult asthma, lower adult coronary heart disease, lower adult obesity, lower adult leisure physical inactivity, and lower adult poor mental health than non-pledge cities.

Among the variables that returned statistically significant results city-wide (i.e., adult asthma, adult coronary heart disease, and adult obesity), signing the pledge was associated with a reduction in the post period compared with non-pledge cities.

Once stratified by social vulnerability, it became clear that census tracts with higher social vulnerability experienced more rapid increases in poor health behavior and health outcomes than census tracts with lower vulnerability. Signing the pledge city-wide helped to some degree. But, a city-wide policy was not sufficient to overcome the neighborhood-specific disparities associated with the social determinants of health.

The stratified results for the built environment determinants of health included in the study (pre-1950 housing and impervious surface) were more nuanced. In both cases, the percentage point increase was significant in the lowest vulnerability census tracts between the pre- and post- periods (15.842 percentage points for pre-1950 housing and 19.45 percentage points for impervious surface). Signing the pledge was associated with an additional increase of 3.15 percentage points for pre-1950 housing and a statistically insignificant increase in percentage of impervious surface. The remaining strata of SVI quintiles followed the same upward trend as health behaviors and health outcomes: the more socially vulnerable the census tracts, the higher the increase in pre-1950 housing or impervious surface, on average.

While signing the We Are Still In pledge attenuated that increase somewhat in the most vulnerable quintile census tracts (3.277 percentage points for pre-1950 housing and 1.578 percentage points for impervious surface), the reduction

associated with signing the pledge was not sufficiently large among SVI05 census tracts to counteract the rapid increase in each variable from SVI04 to SVI05.

In summary, while signing the We Are Still In Pledge was associated in the difference-in-difference analysis with reducing the negative trends in adult asthma, adult coronary heart disease, and adult obesity between the pre- and post-pledge periods, stratification by census tract social vulnerability found significant disparities in the policy's impact at the neighborhood level across vulnerability levels. Future local policies should therefore be tailored to neighborhood-specific needs in order to reduce the risk of disparities in outcomes and increase the potential co-benefits to population health behaviors and health outcomes, particularly among vulnerable groups.

3.1. Assumptions and Limitations

This study relies on a key assumption underlying the difference-in-difference (DID) method that should be taken into account when interpreting its results. The study assumes that outcomes in the pledge and non-pledge cities would move in parallel to each other if the We Are Still In pledge had not been enacted. However, we can not prove that this would be the case. And, DID cannot distinguish between the effect that the We Are Still In pledge had on the seven variables in the analysis compared with the differential influence that other policies or factors might have had in its absence (Gertler et al. 2016, 135–36). For example, the rapid rise in Community Health Needs Assessments and Implementation plans among nonprofit hospitals and local health departments following the passage of the Affordable Care Act in 2010, along with the other aspects of the Act that increased access to preventive care and health insurance across the U.S. (Institute of Medicine 2012), may have played a role in the change in prevalence among the health outcome variables before and after cities decided whether or not to sign the We Are Still In pledge.

The most important limitation to this observational study is the possibility of selection bias. In other words, the assignment of pledge and non-pledge cities was not random. Cities self-selected to sign or not sign the pledge. As a result, it is possible that other, unobserved factors that distinguish between the pledge and non-pledge cities contributed to the results. One counterpoint to that limitation is the geographic, population size, and political diversity of both the pledge and non-pledge groups. However, selection bias remains a concern. Including the social vulnerability index in the stratified analysis reduces the concern that the results are conditional on an unobserved socioeconomic or demographic covariate.

Furthermore, while the health outcomes (asthma, coronary heart disease, obesity, and mental health) are all associated with the kinds of local built environment policies that have been implemented and/or accelerated as a result of the We Are Still In pledge, they are also influenced by many other social and environmental determinants of health. And, five years of implementing a suite of local policies in the aftermath of signing the pledge are unlikely to have been the only underlying driver behind their change from the pre- to post- periods. Again, controlling for SVI was one way to address this limitation. But, it is likely that the We Are Still In pledge stood in for a larger push in the pledge cities to improve health behaviors and health outcomes, rather than spearheading the change on its own.

Finally, it can take decades to transform the built environment in a city so that all of its buildings are up to modern building code and every neighborhood has equitable access to a robust tree canopy, parks, and open space. It is therefore unsurprising that signing the We Are Still In pledge did not result in a statistically significant difference in either built environment determinant of health variable at the city scale. Having said that, the statistically significant differences in how census tracts in different SVI strata changed in pledge and non-pledge cities does indicate that change to the built environment can happen quickly in pockets of the city. And, local policies should be designed to maximize their potential co-benefits to community and planetary health and minimize their co-harms – particularly in highly vulnerable neighborhoods.

CONCLUSION

This study used difference-in-difference analysis to understand whether local implementation of the Paris Climate Agreement was associated with a change in population health outcomes on average in cities that adopted the We Are Still In pledge. It further investigated the differential impact of local policies on neighborhoods with varying levels of social vulnerability.

The analysis found statistically significant differences in built environment determinants of health, health behavior, and population health outcomes between cities who signed the We Are Still In pledge and cities that did not, in spite of the diversity in geography and population in both groups. These differences were present in the period before the pledge. Among the variables that returned statistically significant results city-wide (i.e., adult asthma, adult coronary heart disease, and adult obesity), signing the pledge was associated with a reduction in the post period compared with non-pledge cities. Census tracts with higher social vulnerability experienced more rapid increases in poor health behavior and population health outcomes from the pre- to the post-period. Signing the pledge city-wide helped to some degree. But, a city-wide policy was not sufficient to overcome the neighborhood-specific disparities associated with the social determinants of health.

Future local policies should therefore be tailored to neighborhood-specific needs in order to reduce the risk of disparities in outcomes and increase the potential co-benefits to population health behaviors and health outcomes, particularly among vulnerable groups.

ACKNOWLEDGEMENTS

The authors wish to thank Professor Sebastian Bauhoff for his guidance in econometric methods and Kate Wright for assistance with the paper conceptualization and development of the methodology.

REFERENCES

- Centers for Disease Control and Prevention/ Agency for Toxic Substances and Disease Registry/ Geospatial Research, Analysis, and Services Program. 2022. *CDC/ATSDR Social Vulnerability Index*. https://www.atsdr.cdc.gov/placeandhealth/svi/data_documentation_download.html.
- Gertler, Paul J., Sebastian Martinez, Patrick Premand, Laura B. Rawlings and Vermeersch, Christel M. J. 2016. *Impact Evaluation in Practice*. 2nd Edition. World Bank Group, Inter-American Development Bank. <https://www.worldbank.org/en/programs/sief-trust-fund/publication/impact-evaluation-in-practice>.
- Global Alliance for Buildings and Construction, International Energy Agency, United Nations Environment Programme. 2019. *2019 Global Status Report for Buildings and Construction: Towards a Zero-Emission, Efficient, and Resilient Buildings and Construction Sector*. <https://wedocs.unep.org/bitstream/handle/20.500.11822/30950/2019GSR.pdf>.
- Institute of Medicine. 2012. *Primary Care and Public Health: Exploring Integration to Improve Population Health*. Washington, D.C.: The National Academies Press. <https://doi.org/10.17226/13381>.
- National Governors Association. 2022. <https://www.nga.org>.
- Schulz, Amy and Northridge, Mary E. 2004. "Social Determinants of Health: Implications for Environmental Health Promotion." *Health Education & Behavior*, 31 (4): 455–71. <https://doi.org/10.1177/1090198104265598>.
- United Nations. 2015. *Paris Agreement*. <https://unfccc.int/process/conferences/pastconferences/paris-climate-change-conference-november-2015/paris-agreement>.
- U.S. Centers for Disease Control and Prevention. 2019. *500 Cities: Local Data for Better Health*. Accessed January 31, 2023. <https://www.cdc.gov/500cities/index.htm>.
- . n.d. *National Environmental Public Health Tracking Network*. Accessed January 31, 2023. <http://ephracking.cdc.gov/>.
- . n.d. *PLACES: Local Data for Better Health*. Accessed January 31, 2023. <https://www.cdc.gov/places/>.
- U.S. White House. 2017. *President Trump Announces U.S. Withdrawal From the Paris Climate Accord*. Press Statement. Washington, D.C. <https://trumpwhitehouse.archives.gov/articles/president-trump-announces-u-s-withdrawal-paris-climate-accord/>.
- We Are Still In. 2017a. Accessed January 31, 2023. <https://www.wearestillin.com>.
- . 2017b. *Leaders in U.S. Economy Say "We Are Still In" on Paris Climate Agreement*. <https://www.wearestillin.com/news/leaders-us-economy-say-we-are-still-paris-climate-agreement>.
- World Health Organization. 2007. *A Conceptual Framework for Action on the Social Determinants of Health*. http://www.who.int/social_determinants/resources/csdh_framework_action_05_07.pdf.

Learning at the Regional Level and Understanding at the Local Scale: Transect System as Research Mixed Method for Resilient Design

Carla Brisotto¹, Forough Foroutan¹, Ali Mahmoud¹, Emilee Aguerrebere¹, Lisa Platt¹, Jeff Carney¹

¹University of Florida, Florida Institute for Built Environment Resilience, Gainesville, Florida, US

ABSTRACT: The authors have conducted a cross-disciplinary research study in Jacksonville (Florida) since August 2022. The research aims to unfold the correlations between housing conditions, environmental deficits, and wellbeing (HEW) related to vulnerable populations living in Jacksonville's urban core. The case study is focusing on areas within the Hogans and McCoys creeks watershed. The watersheds are characterized by a lack of affordable housing, low socioeconomic statuses, and a degraded local environment, further impacted by the creeks' regular tidal and storm surge flooding. The focus of this paper is to describe the methodology rather than the findings of the research. A literature review on urbanized watersheds and vulnerability unveils that HEW has not been addressed comprehensively. The methods employed are usually quantitative, like remote sensing analysis for ecological assessment of creeks, or qualitative, like survey analysis, to study people's perception of creeks. Hence, understanding the interrelations between wellbeing, housing, and environment requires adopting a mixed methodology that integrates regional (ecosystem) and local data (place and people knowledge). The authors created a mixed method, the Transect System (TS), blending the Socio-Ecological System model (SES) with Transect Analysis (TA). The first approach, the SES model, offers a viable framework for quantifying the relationships between social, physical, and cultural factors at differing regional scales in an urban environment. This approach generated research hypotheses. In the second approach, the TA produced local geographical sections of places to show different typologies of environments. Through TA, the researchers identified historical, urban, and ecological patterns in spatial features. TS, the result of blending the two approaches, can connect regional data from the Florida level to the local scale of the watersheds by integrating data analysis with inclusive mapping. The method is helpful for climate change studies being able to connect these scales in fast-changing environments.

KEYWORDS: Mixed Method, Transect System, Socio-Ecological Systems Model, Transect Analysis, Resilient Design.

INTRODUCTION

This paper reviews the methodological approaches used by the authors to conduct urban studies research, Florida Resilient Cities: Engaging Jacksonville's Watershed Communities." The study uses a cross-disciplinary approach—the transect system (TS)—to unfold the correlations between housing conditions, creek environmental issues, and residents' wellbeing (HEW) related to vulnerable populations living in the watersheds of the Hogans and McCoys creeks in Jacksonville (Florida). These creeks are an integral piece of the City of Jacksonville's urban planning history. At the beginning of the 20th century, the City was revitalized to uphold the City Beautiful movement's principles to manage and beautify the creeks and channel portions of them (Davis, 2017).ⁱ Today, these once glorious creeks are undergoing harmful levels of fecal coliform bacteria and other pollutants in the water, major roads fragmenting ecological habitats, and housing that are vulnerable to sea level rise, storm surge, and poorly drained soils (Rich-Zeislter and Kingon, 2009; Wainwright, 2006). The outcome of this situation is highly compromising the watersheds' environment in the urban area that has been intensely densifying since the early 20th century (Figure 1). This combination of phenomena leads to a promiscuous cohabitation in which humans and the environment mutually impact each other.

Vulnerability in even one area of HEW can manifest through measures of chronic illness, housing insecurity, and other critical factors in a system where factors intertwine with each other (Agyeman, Bullard, & Evans, 2003), resulting in persistent vulnerability and inequity in these neighborhoods already precarious (Figure 2 and Figure 3). Hence, HEW must be understood as part of an overall socio-ecological system to mitigate and plan for a more equitable environment. The theoretical framework of this research is grounded on intersectionality, which is an analytic framework that identifies how interlocking systems of power affect those who are most marginalized in society and takes these relationships into account when working to promote equity (Collins and Bilge, 2016). Framed by this context and theoretical approach, one of the authors' objectives was to craft a method to explore this system of interconnections to inform planning design strategies. The authors designed TS as a mixed method consisting of collecting quantitative data at the regional level through a Socio-Ecological System model (SES) and collecting qualitative and quantitative data through urban Transect Analysis (TA).

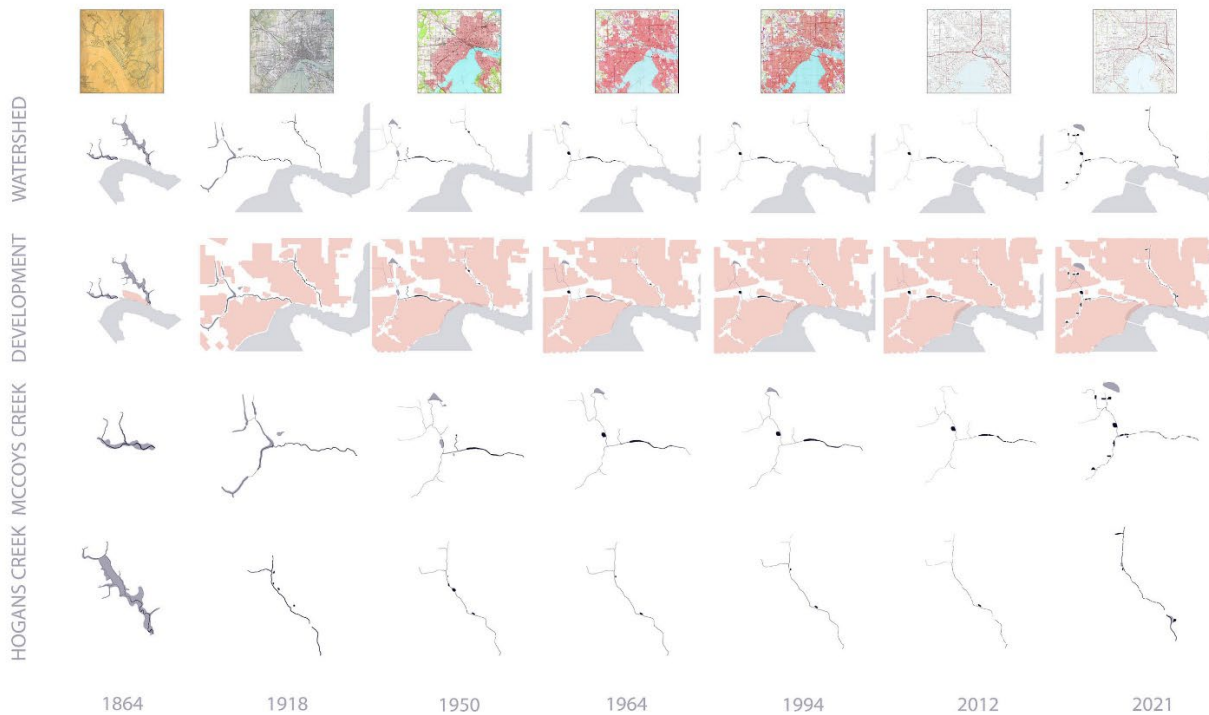

Figure 1: Graphic of the progressively urbanization of the watershed area. Source: (Eliza Breder, Brisotto, and Carney, 2021).

This essay is a method paper (Leist and Hengstler 2018) that aims to describe the mixed methodology used for the research project. The goal is to disseminate the methodology for other studies and implementations. The paper is organized into three sections. The first section will provide the framework of the methodological approach. The second section will describe the design of the methodology. The third section will explore how the method can produce new knowledge and its innovation value. The conclusion will follow these three sections.

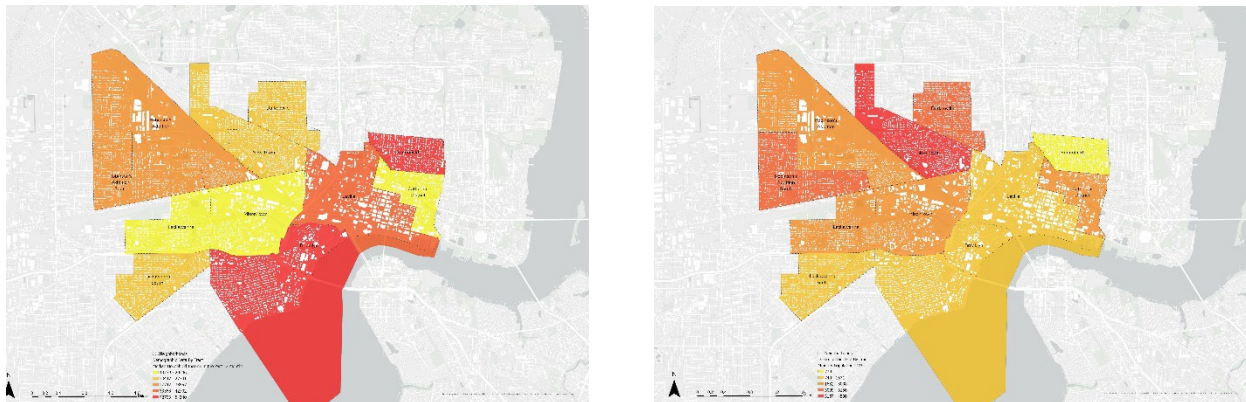

Figure 2 and 3: (Left) Graphic of the median household income. The area is overall characterized by a low-income population. In yellow incomes in the range \$13,739-\$20,446, in red incomes in the range \$42,703-\$54,340. Source: (Eliza Breder, Brisotto, and Carney, 2021). (Right) Graphic of the underrepresented groups population. In yellow lower rates of underrepresented groups, in red higher percentage of underrepresented groups. Source: (Eliza Breder, Brisotto, and Carney, 2021).

1.0 FRAMING

The authors conducted a systematic literature review to explore vulnerability in urbanized watersheds to (1) learn about the major issues related to vulnerabilities in urbanized watersheds,ⁱ (2) review the methodologies used to conduct these studies, and (3) assess if and how many studies consider the interrelations between housing, creeks, and residents' wellbeing simultaneously. This literature review is presented in summary for this proceeding paper.

The researchers used the following keywords 'urbanized watershed', 'vulnerability,' and 'United States' to find scholarly works that reported on specific urban, social, and geographical contexts. The authors made three searches dedicated

to environment, housing, and health/wellbeing - matching the keywords as mentioned above respectively with 'environment' and 'management,' 'housing,' and 'health' and 'wellbeing.' The results were reviewed three times, each time narrowing down the results. The first time the authors reviewed the titles, they eliminated doubles, international case studies, and coastal watersheds.ⁱⁱ In the latter two phases, the authors reinforce the first selections by including only the sources more relevant to the scope of work and better answer the literature review goals. Hence, the chosen sources focused on housing studies, environmental strategies for creeks reparations, and residents' wellbeing.

The research finds evidence of connections between urbanized watersheds and diminished water quality due to increased flooding and runoff and the presence of harmful materials, sediments, and pollutants in the water from agricultural and urban sources (Pavri et al. 2013, Bhandari 2017, Cutts et al. 2018, Messer et al. 2014, Hogan et al. 2014, Dahlke et al. 2013). Some studies explored the connections between environmental and housing conditions. People living in floodplain watersheds are likely to be low-income or facing poverty (Lee and Jung 2014, Palta et al. 2016, Eiffert et al. 2016, Ahmad 2020). This vulnerability affects the house-cost burdenⁱⁱⁱ that impacts people's wellbeing due to compromised health and lowers health insurance coverage (Eiffert et al. 2016, Ahmad 2020). The connection between housing and environmental conditions has also highlighted the high rate of asthma, especially among renters and/or mold in the houses^{iv} (Eiffert et al. 2018). In countless ways, the outcomes of poor health results, such as pneumonia, covid-19, asthma, pseudomonas, and legionella, derive from poor housing and environmental conditions.

Regarding the methodological approaches of the selected studies, the authors found that most of the studies used quantitative methodologies such as satellite and remote sensing analysis through Geographic Information System (GIS), biochemical analysis, sociodemographic data analysis, and statistical analysis (Bhandari et al., 2017; Dahlke, 2013; Shoredits & Clayton, 2013). Other studies used qualitative methodologies through survey collection and focus groups, especially concerning water quality and housing conditions studies regarding wellbeing. These latest studies were able to capture the perception of watershed-related problems by the residents. The papers highlighted a lack of water quality awareness amongst the population (Messer et al., 2014; Pradhananga et al., 2019; Hong & Chang, 2020) or the need to improve residents' understanding of watershed restoration about housing (Hong & Chang, 2020; Radonic et al., 2020; Palta et al., 2016). Additionally, these qualitative methodological approaches revealed distrust towards urbanized watershed restoration and fear of exclusion from the decision-making processes (Radonic et al., 2020).

The review unveiled a series of studies that explored the interconnections between the environmental conditions of an urbanized watershed and the impacts on its residents' wellness. However, no studies directly connected wellbeing and housing conditions within the specific case of urbanized watersheds. Nevertheless, the authors reviewed articles that connected poor housing conditions affected by mold and flooding to health issues that indirectly informed the rest of the review. The connection between housing and the environment was explored in terms of economic and social vulnerabilities emphasizing environmental justice issues associated with this type of urban context.

The review revealed that the three research foci on the environment, housing, and wellbeing had been investigated only in pairs. In terms of methodologies, the review demonstrated the necessity to address this research through geospatial analysis and socioecological research to gain knowledge on watersheds and social vulnerability (Cutts et al. 2018, Lee and Jung 2014, Hong and Chang 2020). Furthermore, the review addresses the importance of utilizing community engagement to include a qualitative understanding of the problem (Sousa and Rios-Touma 2018). Based on the review's results, the authors decided to craft a mixed method, the Transect System (TS), that explores the interconnections between wellbeing, housing, and the environment through socioecological data analysis and spatial characteristics analysis of the observed watersheds in Jacksonville. Hence, the research methodology blended the quantitative Socio-Ecological System model (SES) with the quantitative and qualitative Transect Analysis (TA), as described in the following sections.

1.1 Socio-Ecological System (SES)

The Socio-Ecological System model (SES) originated within the combined disciplines of sociology and urban planning and has more recently been used to inform public health risk assessments and constituent policy development. A socioecological system model (SES) is a type of statistical analysis that identifies possible correlations between variables. In the 1970s, scholars created SES to comprehend human activity as a system, and by the 1980s, it was codified as a theory (Kilanowski 2017). One of the known models of socioecological systems was developed by psychologist Urie Bronfenbrenner (1992). The socioecological model collects different levels of human activity comprising individual biological and socioeconomical characteristics and societal variables like community organization. Not only does SES represent the members' features within the community in relation to their social and ecological status, but it also denotes the interrelationships between each of these levels. For example, SES can detect how individual demographic information can influence community levels and vice-versa and suggest how to intervene to change these influences (CDC, 2018). Building on these traditional SES, authors in the behavioral sciences (Shibata 2009, McGannon et al. 2014) developed a model that emphasizes the dynamic links of personal and environmental variables that impact health behavior. It has been extensively used in research to assist health care providers in comprehending the multifaceted interaction between individual, interpersonal, intrapersonal, organizational, community, and cultural elements that influence the behavioral patterns of different people and groups. Other applications of SES include its use in the field of public health, which investigates how recommending interventions for public health importance can be changed by individual behaviors (Olaniyan et al. 2021). In the context of urban studies,

the socioecological model has been used in research addressing climate change using the causal loop dynamics (Oliveira et al. 2022).

1.2 Transect Analysis (TA)

Transect analysis has a long history starting with the work of the German geographer Alexander von Humboldt in 1793 and his botanical maps. Since then, the transect has been applied in several disciplines like geography, archeology, and ecology. These disciplines aim to describe the sequential temporal changes of an environment through three-dimensional sections (Han 2021). This ability to simultaneously capture information horizontally, vertically, and temporally made the transect a valuable tool for all the fields involved with the design of space: urban planning and landscape urbanism (Han 2021,1568, Duany and Talen 2002, Duany and Falk 2020). Transect analysis became a critical application to study urban environments across the region (from the rural to the urban), within the city (Klein and Clausen 2020), or to analyze urban growth (Thrall et al. 1995). Within the literature, it is widely recognized that the transect approaches ground on the studies of geographer Patrick Geddes and landscape architect Ian McHarg. Geddes's *valley section* represents the values of the place under economic, ecological, and cultural perspectives representing the relations between natural and human environments (Han 2021, 1569, Duany and Talen 2002, 247-249). McHarg's *sustainable section* illustrates a space's ecological and topographical values to inform evidence-based land use (Han 2021, 1571, Duany and Talen 2002, Talen 2002). In both antecedents, the transect methodology's main objective was to describe a landscape in its biological and human correlations as a necessary pre-planning phase to achieve a more sustainable human development successfully. In the 90s, transect analysis as a research tool transitioned to transect planning when used by the New Urbanist movement. In transect planning, the objective is to organize and design an environment for human habitat so that it is "true to locational character," maintaining the diversity between urban and rural topography, density, and morphology (Duany and Tallen 2002,246).

1.3 Transect System (TS)

SES model and TA are ecological and urban analyses that address large-scale problems by analysing multiple factors simultaneously. SES modelling analyses indicators one scale at a time. However, it needs to include a spatial and visual component. In this regard, TA can complement SES by analysing indicators in their existing urban setting. The benefit of using SES modelling is that looking at regionally specific datasets can identify potential meaningful correlations producing a series of hypotheses. These hypotheses can indicate what spatial features the researchers need to study at the local scale through TA. The advantage of TA is that it allows for the synthesis of rich qualitative and quantitative information that contributes to a deeper understanding of community-specific problems testing the validity of the hypothesis. Additionally, TA identifies specific elements finding patterns of diversity or similarities within those elements. The advantage of merging SES with TA in a TS approach is to find patterns of correlations between housing quality and affordability, environmental conditions, and wellbeing at the regional level, informing the focus of the research at the local level. In this way, the method can include local ecological, historical, and cultural factors enriching it with the residents' knowledge (Jones and jam 2015). Ultimately, the goal of TS is to describe the health of an integrated built and natural environment impacting the wellness of its community inspired by McHarg's principle that a thriving urban environment is a healthy environment for both people and the ecosystem (McHarg and Steiner 1998).

2.0 METHOD DESIGN

Using TS, the authors aimed to explore the possible connections between housing quality and conditions, creek environmental conditions, and wellness problems. The goal was to formulate a hypothesis at the Florida State level to identify the indicators to study at the local level of the watersheds through spatial analysis. The need was to understand the spatial features of the watersheds environments in a way that was not "sidestepping the importance of the larger environmental issues of regional sustainability" (Duany and Tallen 2002, 247)". In this regard, TS places itself within the methodologies studying climate change-related issues. Its pursuit is to describe a changing environment that cannot be understood exclusively at the local levels as it generates at larger scales and yet can be validated only at the local scale through morphology and community knowledge. By simultaneously approaching both scales, the research findings can inform design strategies that must consider regional planning and local design. In this light, the innovative aspect of TS resides in the ability to connect generalizable hypothesis to local conditions. The limitation of this method is that it was developed within the watershed studies domain, therefore its application and reproducibility is tied to these type for research. The authors explain the research design using specific examples in the following sections.

2.1. Design

The research design "Florida Resilient Cities: Engaging Jacksonville's Watershed Communities" articulates into two phases: first, the creation of a SES model and then the employment of a TA analysis. In Fall 2021, the authors conducted a systematic literature review of urbanized watersheds to understand the vulnerability of housing conditions, environmental issues, and wellness problems. The literature described in section 1.0 identified a list of indicators connected to population vulnerability due to the built environment. Table 1 summarizes these indicators and the sources from which they were derived. Each indicator was directly adopted in the SES and, in some cases, generated other indicators by scholarship associations from secondary sources (i.e.: exposure to lead has been associated to the age of housing anterior to 1979).

Table 1: Table of the literature originating the SES indicators. Source: (authors, 2021-22)

Sources	Indicators	Secondary Indicators	Problem
Amhad et al. 2020	Home crowdedness	Renters, vulnerability index	Health, Housing
Eiffert et al. 2016, Gray et al. 2018	Socio-demographic and economic data	Vulnerability index	Health, Housing, Environmental
Bhandari 2017	Lead	Housing Age	Health, Housing, Environment
Pavri 2013, Bhandari 2017	Urban Density		Environment
Lee and Jung 2014, Eiffert et al. 2016, Amhad et al. 2020	Housing Cost Burden	Socio-demographic and economic data, renters, vulnerability index	Health, Housing, Environment
Cutts et al. 2018, Hong and Chang 2020, Pavri et al. 2013, Pradhananga et al. 2019, Bhandari 2017, Messer et al. 2017, Hogan et al. 2014, Dahlke et al. 2013, Sousa and Rios-Touma 2018	Water Quality	Flooding	Environment
Bhandari et al. 2017	Heat Days		Environment, Health
Bhandari et al. 2017, Palta et al. 2016, Pavri et al. 2013	Tree Canopy	Air Quality, Land Imperviousness	Environment, Health
Radonic 2020, Veról et al. 2020, Trinh et al. 2013	Green Infrastructures	Air Quality	Environment, Health
Palta et al. 2016, Padowski et al. 2012, Rosen (2016)	Homelessness		Environment, Housing, Health
CDC Reports Infection as a Cause of Maternal Death 2019, Maternal Mortality 2019	Maternal health issues		Environment, Health
Kao et al. 2013, Peabody 2017	Legionella	Water quality	Environment, Health
Gray et al. 2018, Eiffert et al. 2016	Asthma	Housing Conditions, Tree Canopy	Environment, Housing, Health

After the above selection, the authors had thirty-eight indicators used in the SES model. The indicators were organized in the SES model into four parts (socio-demographics, housing, environment, and wellbeing). For each indicator, the authors found public datasets from rigorous and accredited sources on sixty-seven observations (one per each county in Florida).^v Based on the SES model, correlations appear to be a relationship between adverse chronic and acute health incidence and indicators of underperforming urban infrastructure. Furthermore, infrastructure factors such as housing quality and accessibility appear to be accurate classifying factors for regional health outcomes. Like housing and poor public health outcomes, urbanized watershed incidences like flooding risk appear to co-occur with certain regional socioecological variables. These correlations led to one hypothesis:

1. An urbanized watershed characterized by socioeconomic distress, poor housing conditions, and a lack of permeable surface can increase adverse chronic and acute health condition.

The authors used the hypothesis above to direct the second phase using the TA approach. In this second phase, the authors focused on the built environment indicators (housing and environment). Exploring the health conditions of the residents of the observed creeks was not a goal of the TA for ethical reasons (since this was an exploratory study, the authors requested and obtained Institutional Review Board permission for a non-medical study). Nevertheless, the research provided indirect findings on health and wellbeing by studying the condition of the urban context according to the SES's built environment health indicators.

To look at the indicators at the local level, the authors created twelve transects cutting across the watersheds every half a mile along the McCoys and Hogans creeks. Each transect generated an informative card synthesizing the area's socioeconomic, ecological, and housing data (Figure 4). The twelve cards first aimed to investigate the SES indicators on the Hogans and McCoys watersheds' most challenged neighborhoods. Each card collected the population number,

income data, numbers of renters and vacant lots in the area, sea level rise, and flooding visualizations. The second scope was to make an informed selection of the three transects^{vi} that most represented the issues of the watersheds according to the expertise of local organizations operating at the local level, which were also advisors of this research study. The authors, along with the organizations, students, and residents of the area, conducted a participatory walk across the three selected transects to explore the site and be better able to synthesize place-based data. The authors studied the three transects through mapping and sections with the creek at the center of it.

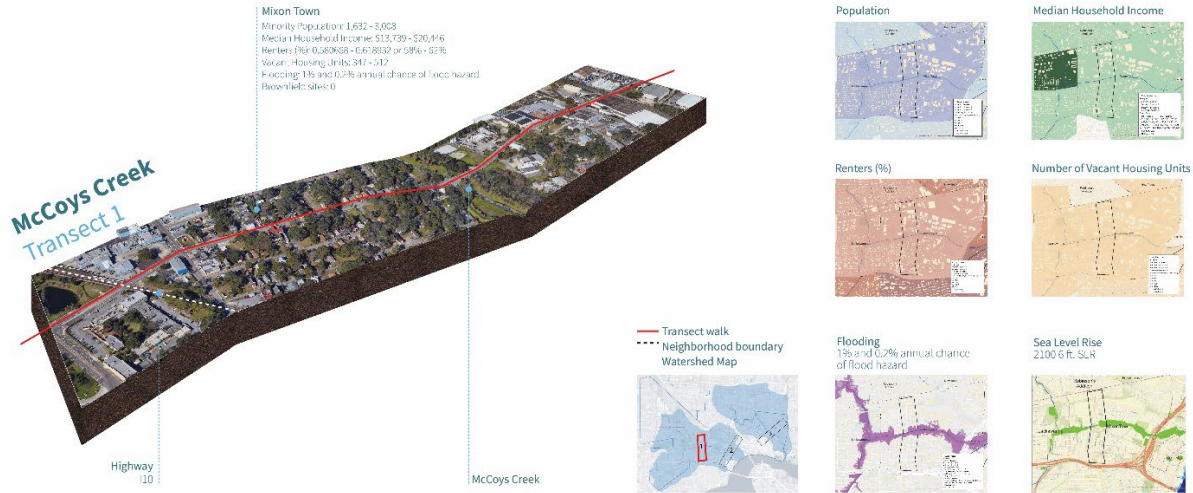

Figure 4: Transect card number 1 cut across the McCoys creek. Source: (Forough Foroutan, Brisotto, and Carney, 2022)

The analysis covered ownership, age, and typologies of buildings, outdoor temperatures, urban morphology, socio-demographic and economic data, and land uses. The goal was to understand if, when, and how the urban environment changed from the creek to the edges according to these indicators. For this reason, the section is divided into five parts, a central part around the creeks and their banks and two parts on each side. Each TA produced a series of findings that challenged the initial hypothesis adding new knowledge to the scholar work of urbanized watersheds residents' vulnerability to health and wellness issues as discussed in section 3.0.

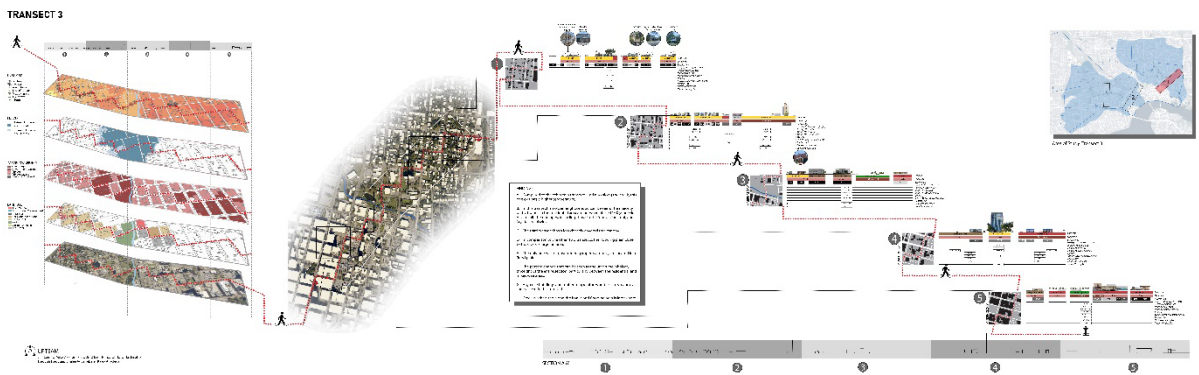

Figure 5: Final transect synthesis of transect 3 along the Hogan creek. Source: (Forough Foroutan, Arboleda, Brisotto, and Carney, 2022)

3.0 FROM RAW DATA TO NEW INFORMATION

SES is a model that generates statistical correlations between social, physical, and cultural factors specific to a complex socioecological problem. The SES employed for this study indicates correlations between respiratory diseases and socioeconomic distress, poor housing conditions, and a lack of permeable surface and shade. It also indicates the possible connection between socioeconomic distress, lack of green infrastructure, poor housing quality, and accessibility and respiratory issues. These correlations became the hypotheses that the TA explored through three geographical sections across the observed urbanized watersheds of the McCoys and Hogans creeks. These sections showed different types of environments moving from the creeks to the edges of the watersheds' boundaries.

The two transects across the McCoys creeks were revealed to differ from the third across the Hogans creek. The comparison between these two results led to an interesting observation. The authors observed a correlation between newer urban developments along the creek, lack of tree canopy, and higher flooding areas. This observation is also evident by looking at the heat map of the three transects. The results of the research study will become the subject of another paper. Nevertheless, this brief overview of the authors' findings illustrates how this mixed method can transform raw data into new information. The process reviewed published datasets to develop a generalizable hypothesis, use that hypothesis to narrow down the factors to explore through a place-based study, and then challenge the hypothesis with the localized new information. It is this new information that directs the research toward further development.

CONCLUSION

This paper describes the rationale and logic of a crafted mixed methodology, the Transect System analysis (TS). The method merges Socio-Ecological System model (SES), a statistical method that finds correlations between different socio-ecological factors of environments, and Transect Analysis (TA), a spatial method that describes the healthy (or unhealthy) connections between ecological and urban features. The SES model produced a hypothesis that the authors explored through a TA of the watersheds of the McCoys and Hogans creeks in Jacksonville. The hypothesis suggests that socioeconomic distress, poor housing conditions, and a lack of permeable surfaces are all indicators of poor human health. At the local level, the authors discovered that the urban watersheds show patterns of gentrification that increase imperviousness while diminished shade and water retention. Community members confirmed this finding. The authors are in the process of exploring these findings through a comprehensive participatory engagement with the scope to understand the wellness implication of it. Further development of this research is to understand how gentrification might compromise the improvement of community health issues.

ACKNOWLEDGEMENTS

This research has been funded with the generous support of the Jessie Ball Dupont Foundation. The study would not have been possible without the insights and guidance of professors William O'Dell, Nancy Clark, and Michael Volk and local organizations Groundworks Jacksonville, UF Health Jacksonville, and LISC Jacksonville. The authors are also grateful for the exceptional support received by graduate research assistant Eliza Breder and intern Kaley Arboleda throughout this research project. Additionally, we thank the contribution given by the students enrolled in an undergraduate research class taught by Prof. Timothy Murtha. Finally, the authors would like to thank the blind peer reviewers that provided meaningful feedback and comments in the initial phase of this paper preparation.

REFERENCES

- Ahmad, Khansa, Sebhat Erqou, Nishant Shah, Umair Nazir, Alan R Morrison, Gaurav Choudhary, and Wen-Chih Wu. "Association of Poor Housing Conditions with COVID-19 Incidence and Mortality Across US Counties." *PLoS one* 15, no. 11 (2020): e0241327–e0241327.
- Bhandari, S., Sridhar, B. M., & Wilson, B. L. 2017. Effect of land cover changes on the sediment and water quality characteristics of Brays Bayou watershed. *Water, Air, & Soil Pollution*, 228(9), 1-14.
- Bronfenbrenner, Urie. 1992. *Ecological Systems Theory*. Jessica Kingsley Publishers.
- Agyeman, J., Bullard, R. D., & Evans, B. (Eds.). 2003. *Just sustainabilities: Development in an unequal world*. MIT press.
- Collins, P. H., and Bilge, S. 2016. *Intersectionality*. Cambridge, UK: Polity Press.
- Cutts, B. B., Greenlee, A. J., Prochaska, N. K., Chantrill, C. V., Contractor, A. B., Wilhoit, J. M., and Hornik, K. (2018). Is a clean river fun for all? Recognizing social vulnerability in watershed planning. *PLoS one*, 13(5), e0196416.
- Dahlke, H., Easton, Z., Fuka, D., Walter, M., and Steenhuis, T. "Real-Time Forecast of Hydrologically Sensitive Areas in the Salmon Creek Watershed, New York State, Using an Online Prediction Tool." *Water (Basel)* 5, no. 3 (2013): 917–944.
- Davis, E. 2017. Guest Column: McCoys Creek is Downtown's Best Kept Secret. The Florida Times-Union Jacksonville. Retrieved from <https://www.jacksonville.com/columnists/opinion/2017-07-25/guest-column-mccoys-creek-downtown-s-best-kept-secret>
- Duany, A. and Falk, B. 2020. *Transect Urbanism: Readings in Human Ecology*. Edited by Andres Duany and Brian Falk. First edition. Novato, Calif.: ORO Editions.
- Duany, A., and Talen, E. 2002. "Transect Planning." *Journal of the American Planning Association* 68 (3): 245–66. <https://doi.org/10.1080/01944360208976271>.
- Eiffert, S., Noibi, Y., Vesper, S., Downs, J., Fulk, F., Wallace, J., Pearson, M., and Winquist, A. "A Citizen-Science Study Documents Environmental Exposures and Asthma Prevalence in Two Communities." *Journal of environmental and public health* 2016 (2016): 1962901–8.
- Gray, C. L., Danelle, T., Lobdell, K. M., Rappazzo, Y.J., Jyotsna, S. J., Messer, L. C., Patel, A.P., et al. "Associations Between Environmental Quality and Adult Asthma Prevalence in Medical Claims Data." *Environmental research* 166, no. C (2018): 529–536.
- Han, S. 2021. "The Use of Transects for Resilient Design: Core Theories and Contemporary Projects." *Landscape Ecology* 36 (5): 1567–82. <https://doi.org/10.1007/s10980-020-01172-9>.
- Hogan, D. M., Jarnagin, S. T., Loperfido, J. V., & Van Ness, K. (2014). Mitigating the effects of landscape development on streams in urbanizing watersheds. *JAWRA Journal of the American Water Resources Association*, 50(1), 163-178.

- Hong, C. Y., & Chang, H. (2020). Residents' perception of flood risk and urban stream restoration using multi-criteria decision analysis. *River research and applications*, 36(10), 2078-2088.
- Jones, P., and Jam, C. 2016. "Creating Ambiances, Co-Constructing Place: A Poetic Transect across the City." *Area* 48 (3): 317–24. <https://doi.org/10.1111/area.12262>.
- Kao, P.M., Tung, M.C., Hsu, B.M., Chiu, Y.C., She, C.Y., Shen, S.M., Huang, Y.L., and Huang, W.C. "Identification and Quantitative Detection of Legionella Spp. in Various Aquatic Environments by Real-Time PCR Assay." *Environmental science and pollution research international* 20, no. 9 (2013): 6128–6137.
- Kilanowski, J. F. "Breadth of the Socio-Ecological Model." *Journal of agromedicine* 22, no. 4 (2017): 295–297.
- Klein, T., and Clausen, S. "Urban Transects and Trunk Roads: Observations in Hamburg." *KN - Journal of Cartography and Geographic Information* 70, no. 1 (2020): 19–24.
- Lee, D., and Jung, J. "The Growth of Low-Income Population in Floodplains: A Case Study of Austin, TX." *KSCE journal of civil engineering* 18, no. 2 (2014): 683–693.
- Leist, M., and Hengstler, J. G. "Essential Components of Methods Papers." *ALTEX, alternatives to animal experimentation* 35, no. 3 (2018): 429–432.
- McGannon, K. R., Busanich, R., Witcher, C. S. G., Schinke, R.J. A social ecological exploration of physical activity influences among rural men and women across life stages. (2014). *Qualitative Research in Sport, Exercise and Health*. <https://www.tandfonline.com/doi/abs/10.1080/2159676X.2013.819374>
- McHarg, I. L., and Steiner, F. 1998. *To Heal the Earth: Selected Writings of Ian McHarg*. Washington, DC: Island Press.
- Messer, L. C., Jagai, J. S., Rappazzo, K. M., & Lobdell, D. T. (2014). Construction of an environmental quality index for public health research. *Environmental Health*, 13(1), 1-22.
- Olaniyan, A., Isiguzo, C., and Hawk, M. "The Socioecological Model as a Framework for Exploring Factors Influencing Childhood Immunization Uptake in Lagos State, Nigeria." *BMC public health* 21, no. 1 (2021): 867–867.
- Oliveira, B. M., Boumans, R., Fath, B.D., and Harari, J. "Socio-Ecological Systems Modelling of Coastal Urban Area Under a Changing Climate – Case Study for Ubatuba, Brazil." *Ecological modelling* 468 (2022): 109953.
- Palta, M., du Bray, M.V., Stotts, R., Wolf, A., and Wutich, A. "Ecosystem Services and Disservices for a Vulnerable Population: Findings from Urban Waterways and Wetlands in an American Desert City." *Human Ecology* 44, no. 4 (2016): 463–478.
- Pavri, F., Springsteen, A., Dailey, A., & MacRae, J. D. 2013. Land use and socioeconomic influences on a vulnerable freshwater resource in northern New England, United States. *Environment, development and sustainability*, 15(3), 625-643.
- Peabody, M. A., Caravas, J.A., Morrison, S.S., Mercante, J.W., Prystajacky, N.A., Raphael, B.H., and Brinkman, F.L.S. "Characterization of Legionella Species from Watersheds in British Columbia, Canada." *mSphere* 2, no. 4 (2017).
- Pradhananga, A., Davenport, M., & Green, E. 2019. Cultural narratives on constraints to community engagement in urban water restoration. *Journal of Contemporary Water Research & Education*, 166(1), 79-94.
- Radonic, L., Cooper, L. T., & Omans, M. 2020. At the crossroads of flood mitigation and urban revitalization: residents' perspectives of shifting floodplain governance in the United States rust belt. *Human Organization*, 79(2), 117-129.
- Rich-Zeislter, J., and Kingon, K. 2009. Final TMDL Report: Fecal Coliform TMDL for McCoy Creek, WBID 2257. *Florida Department of Environmental Protection*. Retrieved from <https://floridadep.gov/dear/water-quality-evaluation-tmdl/documents/mccoy-creek-wbid-2257fecal-coliform-tmdl>
- Rosen, J. (2016). Climate, environmental health vulnerability, and physical planning: A review of the forecasting literature. *Journal of Planning Literature*, 31(1), 3-22.
- Shibata, A., Oka, K., Harada, K., Nakamura, Y., and Muraoka, I. 2009. Psychological, social, and environmental factors to meeting physical activity recommendations among Japanese adults. *International Journal of Behavioral Nutrition and Physical Activity*, 6(1), 60. <https://doi.org/10.1186/1479-5868-6-60>
- Shoredits, A.S., and Clayton, J.A. "Assessing the Practice and Challenges of Stream Restoration in Urbanized Environments of the USA." *Geography compass* 7, no. 5 (2013): 358–372.
- Sepsis Alliance. 2019. *CDC Reports Infection as a Cause of Maternal Death*. Retrieved from <https://www.sepsis.org/news/cdc-reports-infection-as-a-major-cause-of-maternal-death/>
- Sousa, E., R.D.C., and Rios-Touma, B. 2018. Stream restoration in Andean cities: learning from contrasting restoration approaches. *Urban ecosystems*, 21(2), 281-290.
- Talen, E. 2002. "Help for Urban Planning: The Transect Strategy." *Journal of Urban Design* 7 (3): 293–312. <https://doi.org/10.1080/1357480022000039349>.
- Thrall, G. I., McClanahan, M., and Elshaw-Thrall, S. 1995. Ninety years of urban growth as described with GIS: An historic geography. *Geo Info Systems*, 5(4), 20–27, 45.
- Veról, A. P., Bigate Lourenço, I., Fraga, J. P. R., Battermarco, B. P., Linares Merlo, M., Canedo de Magalhães, P., and Miguez, M. G. 2020. River Restoration Integrated with Sustainable Urban Water Management for Resilient Cities. *Sustainability*, 12(11), 4677.
- Wainwright, D. 2006. TMDL Report: Fecal Coliform TMDL for Hogan Creek, WBID 2252. *Florida Department of Environmental Protection*. Retrieved from https://floridadep.gov/sites/default/files/tmdl_document2252_0.pdf

ENDNOTES

- ⁱ A watershed is a catchment basin of land from which all water drains toward a destination (river, creek, lake, ocean, sea) characterized by distinct geomorphological features (elevation, ridges, topography, etc.). An urbanized watershed is a catchment basin that has been urbanized altering the geomorphological features of the land and therefore the way water drains.
- ⁱⁱ The focus of this study was on urban creeks, therefore the authors decided to include in the literature review only sources that look at the fluvial portion of the watersheds
- ⁱⁱⁱ The house cost burden (HCB) is defined when a person spends over 50% of their income to pay for housing. Usually, renters are more vulnerable to HCB.
- ^{iv} The study by Effert et al. showed that 14% of residents in a low-income neighbourhood in Atlanta (US) self-reported they had asthma, and 76% of residents with asthma were renters. More specifically, compared to households without mold, 35% of homes that had visible mold showed higher mean of Environmental Relative Moldiness Index (ERMI).
- ^v Data came from these sources: US Census, Health Resources and Services Administration, Agency for Toxic Substances and Disease Registry, CDC, National Environmental Public Health Tracking, Environmental Protection Agency, The Shimberg Center for Housing Studies, Florida Department of Health, CDC Diabetes Surveillance System, Centers for Medicare & Medicaid Services, and First Street Foundation
- ^{vi} The grant generously given by the Jessie Ball DuPont Foundation allows the authors to dedicate a graduate research assistant working on transect analysis for a certain amount of time and therefore the decision to pursue three transects rather than all the initial twelve.

Modeling Reciprocities

Nate Imai¹, Matthew Conway²

¹Texas Tech University, Lubbock, TX

²UCLA + USC, Los Angeles, CA

ABSTRACT: How can a form-based approach to real estate establish a reciprocal relationship between architecture and development? This paper examines the potential for custom software that visualizes pro formas as 3D digital massings to make the development process more accessible to designers and render for developers the formal potential of their financial models. This interface synthesizes form with real estate metrics to provide architects and developers a tool to research the qualitative and quantitative aspects of their design iterations and exchange ideas between the two fields. An initial investigation on Yona Friedman’s “Flatwriter” machine serves to historically ground the research. Additional discussion on James Petty’s *Architect & Developer* and Office of Jonathan Tate’s *The Starter Home** examines contemporary attitudes on the impacts architects can make in the development process.

This paper identifies a representational gap between developers’ spreadsheet calculations and architects’ CAD/BIM software environments. Black-box solutions such as Autodesk’s Spacemaker provide generative design options for urban massings but are biased towards maximizing capital returns at the expense of design exploration. The tool discussed in this investigation integrates a pro forma suite within existing CAD/BIM applications. By situating this instrument directly inside modeling software, we are collapsing the historically disparate relationship between form-making and real estate, by visualizing an editable 3D pro forma.

The tool discussed in this paper provides architects quantitative numerics to allow them to develop their own pro formas as easily as they would iterate a massing model. It also allows developers to visualize their financial models as three-dimensional forms. By conflating financial calculations with form-finding strategies, this digital software tool encourages dialogue between architects and developers through an interface for making better informed real estate decisions in regards to both urban goals and economic realities.

KEYWORDS: digital design, urbanism, computation, real estate, mapping

INTRODUCTION

The need to create new urban developments—especially those providing housing—to accommodate our growing city populations necessitates that we reevaluate conventional design and development processes between architects and developers. The influx of new residents and the diminishing supply of vacant land creates a situation in which future development must be more efficient to justify building in the context of rising cost of land and construction associated with materials, labor, and growing consultant teams. This move towards greater efficiency should not come at the expense of the people residing in these cities, as is often the case in the lower quality of construction and materials used in affordable housing projects, or the exclusion of mid or lower income populations in high-end residential construction in which costs are passed on to renters or owners. Rather than ignoring these economic challenges presented by contemporary urban developments, this paper identifies the conventional relationship between architects and developers, specifically the lack of shared tools between these disciplines, as an area to optimize in order to design a more economically efficient and urbanistically responsive method of development moving forward.

The roles of architects and developers are typically separate and distinct. Conventional developments are initiated by developers and foundational decisions such as property acquisition and programming are commonly made without an architect involved. While this model has traditionally been suitable for large-sized lots or suburban parcels in which economies of scale or standardized plans for regulated lot sizes are conducive to generative (and oftentimes generic) design approaches, this method is not suited for urban infill sites in which variable geometries and dimensions and unique infrastructural conditions require a more surgical methodology. At the same time, urban infill lots present a design challenge architects are uniquely suited to address through their designs that can generate value from such atypical conditions. Risk, a common obstacle in any development, is what dissuades developers and architects from individually taking on such infill sites—developers are reluctant to develop parcels that do not fit their proven financial models, and architects, by their training as service providers, hesitate to take on the debt required to finance such projects. As a result, many of these urban infill sites go undeveloped that would otherwise greatly benefit both municipal governments through increased tax revenue and residents by situating them closer to existing amenities and shared resources.

Bringing architects and developers together earlier in the development process is critical in order to fully maximize the economic and urban potential of these infill lots. Pairing architects' expertise in programming and site analysis with developers' understanding of market demands and financial models makes for a potent collaboration that can identify and leverage parcels otherwise overlooked by typical developers.

This paper identifies the gap between tools used by architects and developers as an opportunity for optimization. One of the key instruments used by architects in programming and site analysis is the massing model, increasingly generated in CAD software environments such as Rhino, Revit, and AutoCAD. Likewise, a central instrument used by developers when developing a prospectus is the "pro forma"—a financial model that outlines expected costs and profits—that is typically created in a spreadsheet program such as Excel. While these disciplines' software tools are uniquely tailored and designed for their specific trades, each has its own inherent blind spots: architecture tools fail to holistically capture the economic picture of their designs, and developer tools are not equipped to represent the spatial possibilities that accompany financial constraints.

By better designing the interface between these two instruments through bespoke software, this paper provides a methodology to recursively represent the relationship between building massing and economic performance. By getting developer outputs with architectural inputs, and vice versa, this method provides a model for architects and developers to collaborate on developing urban infill sites that would otherwise be overlooked.

1.0 CONTEXT

This investigation asks the question, "how can a form-based approach to real estate establish a reciprocal relationship between architecture and development?" In order to provide an answer, this paper first references several sources to contextually ground the research and understand the contemporary relationship between these two disciplines.

Yona Friedman's "Flatwriter" machine and eponymous essay offers one example of an architectural interface that helps visualize future development. As previously discussed, this paper identifies the information gap between architects' massing models for programming and site analysis and developers' pro forma models for forecasting economic performance as an area for optimization in the development process. Friedman's Flatwriter provides an appropriate precedent for bridging architecture's visual and development's computational languages all while remaining responsive to contemporary social and urban issues. The takeaway from this project is Friedman's use of code to create bespoke housing solutions for a shifting market.

Understanding that "the majority of architects designing housing today do not work for millionaires, but for millions of individuals who will work or live in the architects' projects" (Friedman 1971), the Flatwriter is designed to respond to the individual living preferences of residents moving to burgeoning cities. Friedman's solution to directly involve prospective residents in the design process of their future apartments leverages visualization software to calculate pricing, acquire permitting, and print out plans that can be shared with other members of the community. Described by Friedman as a "simple code" that eliminates the need for "intermediary professionals" (Friedman 1971), the Flatwriter frames software as a potential tool for forming a recursive relationship between architects and developers to address the challenge of developing atypical infill sites in urban areas.

Contemporary architectural discourse has seen increased attention on the advantages of architects becoming involved at earlier stages in the development process. James Petty's book *Architect & Developer* is targeted specifically towards architects and explains the development process to an audience with a design background. Petty identifies the absence of architects at the initial stages—in which oftentimes "programming, market studies, and cost estimates are based on market averages"—as a reason why many projects result in average buildings (Petty 2018). In downtown infill sites, collaboration between architects and developers is required to produce creative and innovative results that can outperform conventional methods. Petty outlines the pro forma as "the most important tool for a developer," explaining, "this malleable document calculates all the variables that go into putting a deal together with the intent of giving you the ability to make informed decisions regarding the project's expected financial performance" (Petty 2018). He furthermore sees the value of architects being involved in the development of urban infill projects. Understanding typical developers work with "standard lots," Petty argues, "oddly shaped lots that are leftover" present the best deals and opportunities for design, as "standard developers pass these over to avoid the costly expense of an architect, depressing the value per square foot on the land" (Petty 2018). By pairing expertise on programming and site analysis with a working understanding of a pro forma, architects can collaborate with developers or work independently to leverage urban infill lots as opportunities to generate innovative design solutions.

One example of a contemporary architectural practice taking this approach is Office of Jonathan Tate (OJT). Operating at the intersection of architecture and development, OJT has garnered national recognition for its Starter Home* project that rethinks the conventional single-family residential home as a malleable building type that can be adapted to the idiosyncrasies of atypical urban infill sites. The office's research documented in its book *The Starter Home** identifies "the transition from home as consumption good to home as investment commodity" as a reason for the production of housing that is out of scale and out of sync with its residents' needs. By taking an active role in the development process, OJT argues for "a strategic model, with a tactical architecture" that is "based in the market as much as it is in

a progressive conceptual framing” to “address the typological and economic stagnation we find the condition of the contemporary American starter home” (Bost et al. 2015a). OJT applies this thesis to “un-developable” lots in metropolitan areas, bringing the concept of the starter home to city centers where they have been traditionally excluded due to “the assumption that homogeneity is a precondition for success” in a market rate driven developer approach (Bost et al. 2015a). Instead, OJT envisions these types of atypical urban infill lots as opportunities in which “a new kind of economy-of-scale becomes necessary: one that requires integration of design and development interests, agility, and the ability to accommodate changes in each project’s matrix of preconditions, drivers, goals and resources” (Bost et al. 2015a).

This approach is best exemplified by the firm’s pilot Starter Home* project, 3106 St Thomas, a “speculative infill single-family house” in New Orleans completed in 2015 (Tate 2016). Premised on “developing the un-developable,” OJT initiated the project and leveraged GIS data to identify a set of small-scale odd lots from which they acquired one to build as a developer (Bost et al. 2015b). Exploiting the “eccentricities of its particular site” (Bost et al. 2015b), the building was designed and constructed within its narrow 16 ½ foot wide buildable footprint without a variance. This project that is tailored to the housing needs of an emerging first-time city homeowner population demonstrates the novel architectural solutions that can emerge when architecture and development are paired early together from the outset of a development project.

The value in combining architectural representational methods with real estate developer models is reflected in the emergence of software interfaces that allow users to understand the financial performance of three-dimensional digital massing models. One prime example is Autodesk’s Spacemaker, which originally began as the independent start-up Spacemaker, AI. Branded as “an intuitive, collaborative, cloud-based AI software that empowers architects, urban planners and real estate developers to design high-quality site proposals” (Haukeland 2022), Spacemaker leverages machine learning to provide generative design options that are informed by a myriad of design considerations that include noise, wind, and solar analyses. While the potential exhibited by this program prompted Autodesk to acquire it for \$240 million in 2020, its standalone 3D modeling environment that is separate from design industry standard platforms such as Rhino, Revit, and AutoCAD and its reliance on cloud-based artificial intelligence makes it difficult to use as a design tool and yields outputs that are biased towards generic, financially driven forms. As a counterpoint to this methodology, this paper advocates for an approach that creates greater reciprocity between architects and developers by designing software that runs natively in programs like Rhino to allow designers and developers to evaluate design iterations in regards to both their financial performance and urban contributions.

In order to design for atypical urban infill sites, it is important to develop a framework for collaboration between architects and developers. Understanding projects conventionally initiated solely by developers are typically predicated on market averages, this investigation seeks to outline the value an architectural approach can add to the early stages of the process, especially in cases involving unconventionally sized lots. By synthesizing architects’ representational toolkit with developers’ pro forma models, we set to create a methodology for creating a feedback loop to inform surgical interventions in urban areas.

2.0 METHODOLOGY

Since the advent of the spreadsheet software, real estate developer models have been tabulated in rows, columns, and tabs. Spreadsheets’ software allows developers access to advanced calculation and computation capabilities including pivot tables and graph insertions as well as macro scripting through Visual Basic for Applications. This model has the ability to immediately update when input information is adjusted. However, the results are traditionally output as static documents, with calculations hidden and only resulting figures shown.

While real estate developer models exist in two-dimensional space, architects are continuing their affinity for three-dimensional modeling, typically in advanced computer aided drafting (CAD) software such as McNeel & Associate Rhino and Autodesk Revit. These CAD software have numerous graphical user-interfaces (GUI). CAD GUI in these and other CAD software consists of a three-dimensional model space view, model outline (Layers panel & Project Browser panel respectively), Properties panel, and visual scripting window (Grasshopper & Dynamo respectively). Our custom software bridges the gap between the three-dimensional model space GUI and spreadsheet calculations, superimposing real-estate metrics on three-dimensional geometry. Our initial study uses a custom C# real-estate library referenced into compiled C# Grasshopper components, run using Grasshopper and Rhino (Because the library is C# without Grasshopper or Rhino assembly references, it is easy to replicate in other applications through API wrappers).

Real estate developer spreadsheets have input Cells for architectural quantities including number of units and unit area sizes. This is limiting to architectural production in two ways. First, the spreadsheet software Cell as interface requires the use of the keyboard and mouse-click to update, causing required translation from the architecture model. This reduces the speed with which real estate calculations can be updated. Second, the number of cells is limited to generic inputs like unit count and general prices per area. This limit imposed by spreadsheet software creates developer incentive to also limit programmatic variation to what is efficient to input into a spreadsheet. To overcome these spreadsheet software limitations, our software uses the CAD model view GUI as the main input. Both Rhino Object Name and/or User Attributes could have been used to store architectural program type. We opted instead to use each

Rhino Object's Layer property to contain architectural program type data. This creates a reciprocity between the model organization and the program type, while also allowing users the ability to quickly copy and paste (ctrl + c -> ctrl + v) to try new programmatic variations. Additionally, Layers in Rhino can be assigned color, which is then applied to any Rhino Objects under that Layer. This color-coding provides an intuitive and quick architectural program reading, increasing program literacy by providing spatial context (unlike the flattened spreadsheet). Users can quickly adjust architectural program massing geometry, add additional units, and/or create new program types and everything is automatically calculated and updated in our software, removing the back and forth between architecture model and real-estate developer model.

The CAD software model view GUI handles as much input as possible, but numeric input is still required for financial calculations. In our custom software, these financial numeric inputs are accessed through text components in Rhino's visual scripting Grasshopper window. These text components are labeled, graphically differentiated (and isolated), and grouped to signify to the user what numbers may be adjusted. By exposing these numeric inputs, it is possible for the user to create their own numeric combinations to evaluate different real-estate developer models simultaneously.

Exposing the model to both the CAD software model view and visual scripting text component allows for mass custom generative calculations. With no visual scripting access required save to open the script and adjust any financial numeric inputs as necessary, CAD users can easily duplicate and manipulate their models ad infinitum (as the computer's memory allows) and receive instant and unique real-estate feedback. More comfortable visual scripting users can take this approach further and generate numerous architectural program massing forms natively in Grasshopper or create combinatronic financial numeric inputs to test different financial conditions (Figure 1).

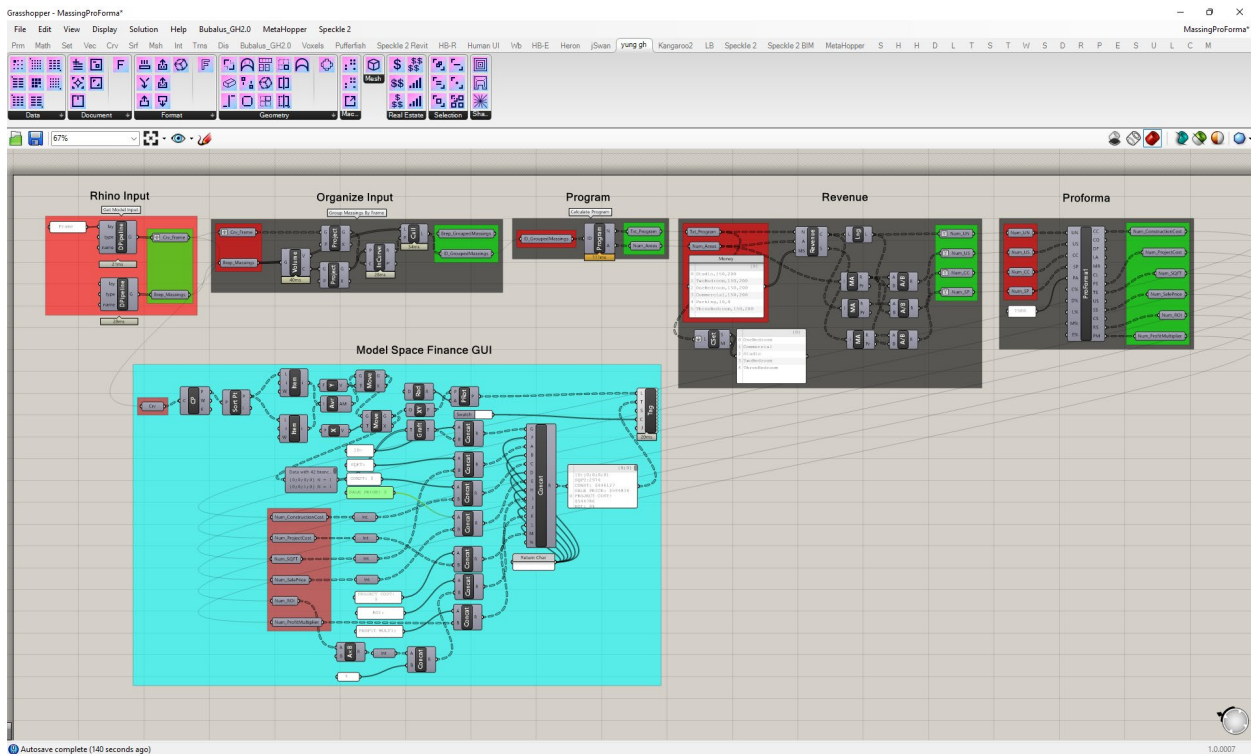

Figure 1: Grasshopper window showing an architectural massing pro forma including custom compiled C# scripts for calculating finance and organizing Rhino Object inputs (Program, Revenue, ProForma1). The calculations work without scripting literacy (the model view GUIs the only required interface), but advanced users can further customize the script's generative potential. Source: Authors 2023

In addition to using CAD software's model view GUI and visual scripting combinatorics and generative abilities, our software also utilizes the visual scripting Component's ToolTips (Figure 2). The Tooltip is a common GUI element, when hovered over a text box displays information about the element (usually a description). Software spreadsheets do have Tooltip capabilities though they require custom setup and can only be added one at a time. Our C# real-estate library is organized in such a way that all input and output names and descriptions are located in a single text file. These names and descriptions are accessed via each object's Tooltip, providing real-time descriptive information to users as they are modeling.

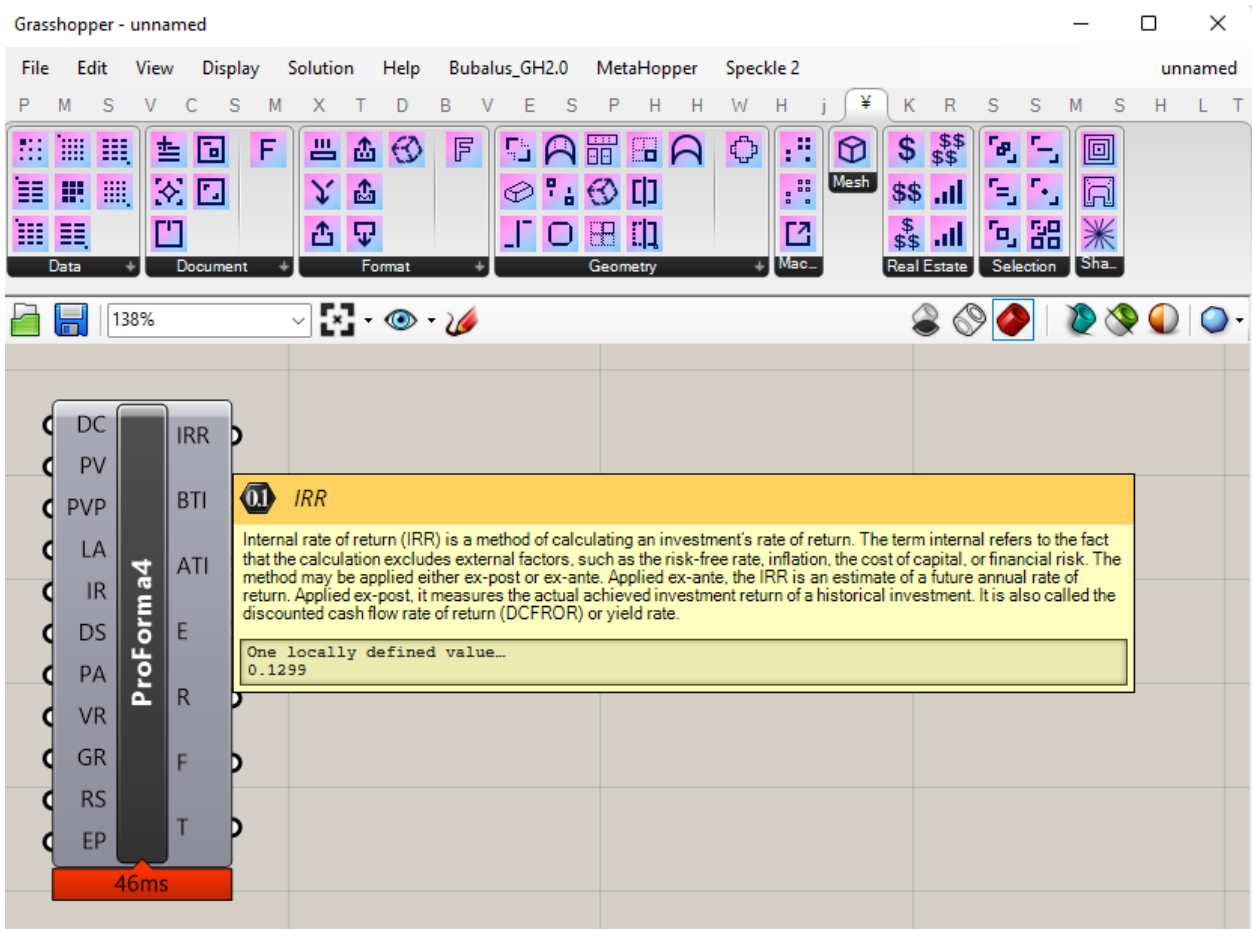

Figure 2: Grasshopper window showing the custom compiled C# ProForma4 Component with the user hovering their mouse over the IRR output to initialize the ToolTip describing IRR. Source: Authors 2023

Lastly, the real-estate numeric output is re-projected from the visual scripting window back into the three-dimensional model space, a GUI inside a GUI. Numeric output our software computes includes construction costs, construction contingency, design fees, legal fees, marketing fees, closing costs, cash on cash, return on investment (ROI), profit multiplier, developer equity distributions, accrued interest, financed amount, mezzanine debt, mezzanine profit, tax liability, amortization of principal, net operating income (NOI), debt service, depreciation, taxable income, internal rate of return (IRR). A number of these computations require the use of iteration and complex references that are possible but difficult to do in a spreadsheet (i.e. accrued interest, amortization, IRR, etc.). This allows for simultaneous reading of both the architecture and real-estate model, removing the disconnect through interface integration. By superimposing this financial data with architectural form, our software pairs the architectural model and real-estate developer model, thereby pairing the architect and developer.

3.0 RESULTS

The software was used on a small-scale odd lot in Lubbock, Texas. The unique geometry of this lot made it antagonistic to typical developer speculation and formulas. Using our software we were able to create numerous pro formas through a variety of architectural program massings. Left in the two-dimensional realm of spreadsheets, the chosen scheme is most likely to be that which optimizes certain numeric outputs. Our model space GUI superimposes these numeric outputs directly with the architectural program massing that generated them, providing a reciprocity between form and finance. This reciprocity allows architectural decisions to be considered alongside financial ones.

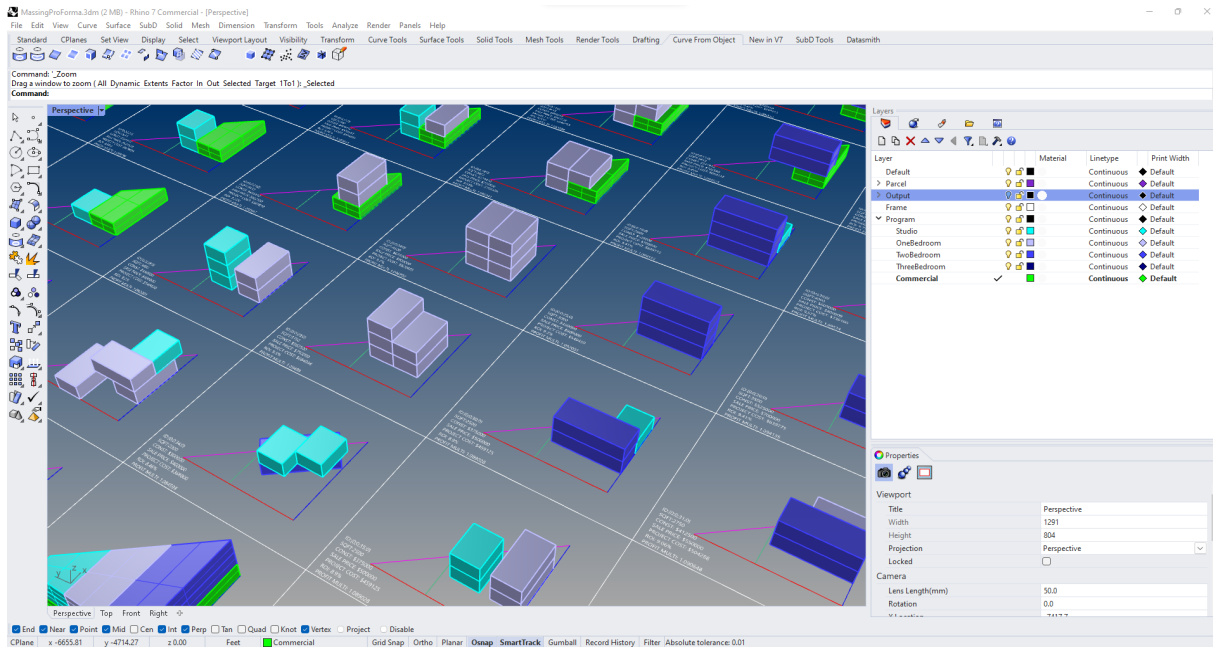

Figure 3: Using the custom script, users can multiply and adjust program massings using only the model view and layer panels as interface and receive immediate pro forma feedback on each scheme. Program type is indicated with colors and dynamic numeric pro forma output is shown as white text. Source: Authors 2023

For our results, we looked at return on investment (ROI) to determine financial viability. Our result (Figure 3) shows that by not choosing the maximum or minimum financially viable schemes, but something in between them we have the opportunity for more architectural character (Figure 4). In our example, a one-bedroom and studio space were the minimum financially viable program, while commercial space that maximized the allowable envelope provided the financially maximized program. One can see from the image that our chosen scheme between these two extremes allows for a more varied program mix and open contextual relationship (both qualitative characteristics), while still maintaining financial viability. We can also apply additional scripting to graphically represent the ROI with color: red (255,0,0) means maximum financial viability and cyan (0,255,255) means financially minimum viability (Figure 5).

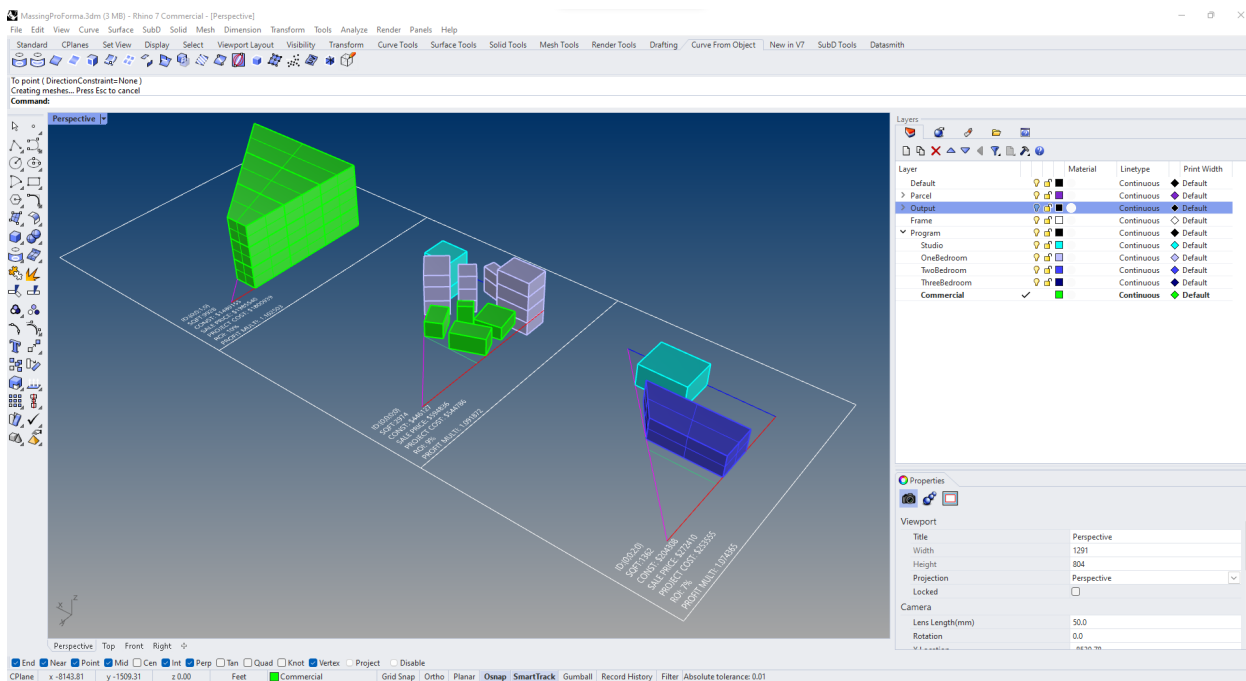

Figure 4: Rhino Model close up showing pro forma data projected into model space GUI and the simple Layer organization in the Layer panel GUI. This example shows the minimum (right), maximum (left), and our chosen (center) financially viable scheme as determined by ROI. Source: Authors 2023

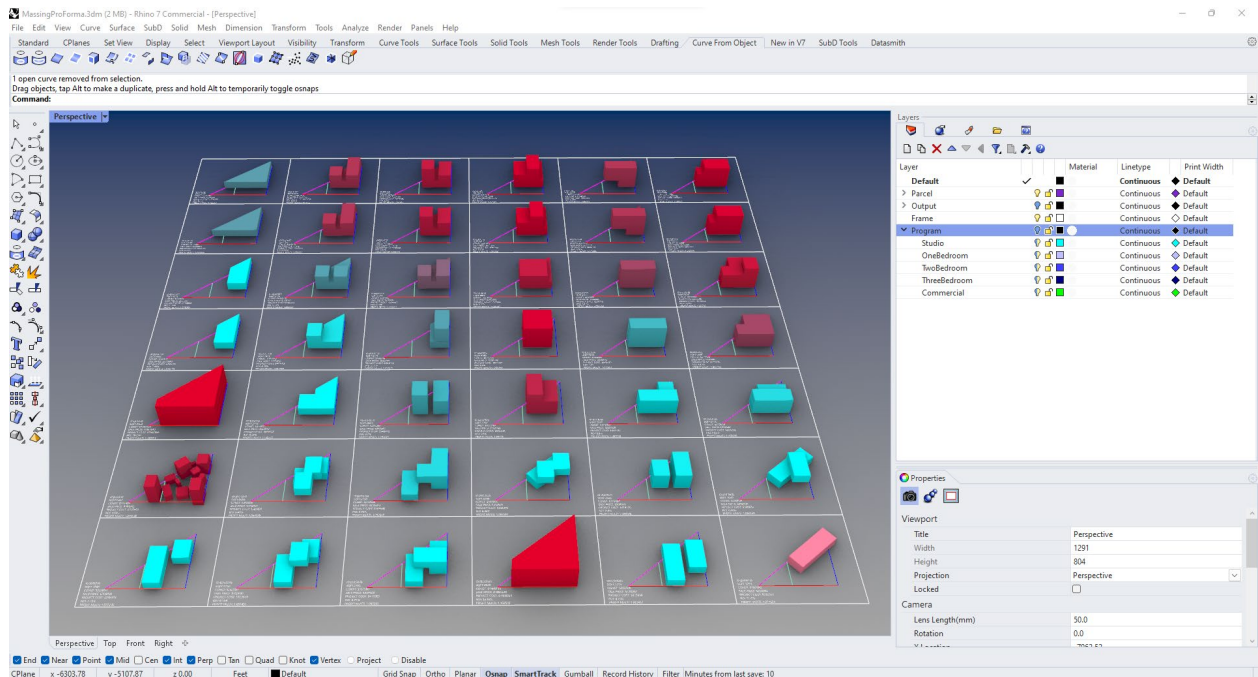

Figure 5: More advanced users can further customize the script to add additional graphical information or organizational output. In this example we see the architectural massings colored with a gradient based on ROI. Source: Authors 2023

The gradient spread as GUI shows that our chosen scheme is more financially viable than most of the other schemes. Urbanistically we are interested in mixed architectural programming for sociological and ecological reasons and are interested in open contexts architecturally, both issues we were able to maintain through the real estate developer process with the aid of our custom software that maintained formal and financial relationships throughout the iterations.

4.0 DISCUSSION

A form-based approach to real estate provides a framework for collaboration between architects and developers to develop atypical urban infill lots and other sites normally overlooked. By creating custom software that bridges CAD GUIs and spreadsheets' matrix of calculations, we advocate for a recursive process that allows development proposals to be evaluated on both their financial performance and urban contributions. The synthesis of architects' digital massing models with developers' pro formas has three observed outcomes: 1) it provides an interface that allows architects and developers to communicate with each other through terms understood by each respective discipline, 2) the ability to create multiple iterations quickly allows design to take place earlier in the development process, and 3) it permits architects and developers to understand their design options in both urbanistically qualitative and financially quantitative terms simultaneously.

This investigation identifies several avenues in which the research can be developed further. The first is the introduction of this Grasshopper plug-in suite in architectural design studios and seminars. This pedagogical application will allow students to holistically understand the financial implications and opportunities associated with their design decisions. Applications in community engagement and outreach collaborations can create opportunities to leverage the findings in these courses to help local stakeholders identify moments for development and design in local communities. Furthermore, this paper sees this tool as an opportunity for interdisciplinary collaboration between schools of architecture, planning, and business to rethink conventional approaches to development, especially interventions in urban areas.

Another next step is to research other pro forma models and incorporate additional design considerations into the Grasshopper component. The inclusion of construction schedules, line items such as facade and unit costs, and grossing and net factors that include Building Owners and Managers Association (BOMA) International calculations can add greater intelligence to the tool and allow architects and developers to identify certain aspects of their design to be optimized and, or, invested in.

Developing this tool further along these lines coincides with the research's intent to develop an interface that fosters interdisciplinary collaboration in the development and design of areas in our cities that have historically been overlooked. This approach advocates for leveraging software as means to bridge working methods unique to specific disciplines and in turn create a framework for communication and dialogue for generating novel approaches for creating projects that are responsive to our evolving cities' needs.

CONCLUSION

This investigation proposes a form-based approach to real estate to establish a reciprocal relationship between architecture and development. Understanding there is a growing need to create new urban developments to accommodate our growing city populations, we identify the gap between tools used by architects and developers as an opportunity for optimization. By designing an interface that allows these disciplines to engage in dialogue through a shared model that operates in terms understandable by both fields, architects and developers can collaborate in the development of novel projects responsive to both urban contexts and financial models.

With diminishing supplies of vacant land and the increasing cost of development, it is increasingly necessary to align architectural and development interests to create innovative working methods for developing underutilized lots. The synthesis of CAD GUIs with spreadsheet calculations creates a feedback loop that allows architects and developers to explore multiple iterations and explore creative design solutions typically absent early in the development process, and in turn weigh both urban and financial considerations when initiating projects.

In addition to its practical applications, this research frames this tool as a powerful platform for collaboration. By writing bespoke software that integrates both urban and financial considerations, architects and developers can develop projects that better respond to the contexts within which they operate.

REFERENCES

- Bost, Travis, Jonathan Tate, Robert Baddour, Rebecca Fitzgerald, Sabeen Hasen, Lauren Hickman, Marguerite Lloyd, Jessica O'Dell, Charles Rutledge, Kristian Mizes, and OJT, Issuing Body. *The Starter Home* Volume One*, OJT, 2015a.
- Bost, Travis, Jonathan Tate, Robert Baddour, Rebecca Fitzgerald, Sabeen Hasen, Lauren Hickman, Marguerite Lloyd, Jessica O'Dell, Charles Rutledge, Kristian Mizes, and OJT, Issuing Body. *The Starter Home* Volume Two*, OJT, 2015b.
- Canadian Centre for Architecture. "How to: not become a 'developer.'" Accessed March 27, 2022. <https://www.cca.qc.ca/en/articles/83443/how-to-not-become-a-developer>.
- Friedman, Yona. "The Flatwriter: Choice by Computer." *Progressive Architecture*, March 1971, 98–101.
- Friedman, Yona. *Toward a Scientific Architecture*. MIT Press, 1975.
- Haukeland, Håvard. "Spacemaker: Early-Stage Planning, Reimagined." Spacemaker Software, November 3, 2022. <https://www.autodesk.com/products/spacemaker/overview>.
- O'Hear, Steve. "Spacemaker, AI software for urban development, is acquired by Autodesk for \$240M." *TechCrunch*, November 17, 2020. <https://techcrunch.com/2020/11/17/spacemaker-ai-software-for-urban-development-is-acquired-by-autodesk-for-240m/>.
- Petty, James. *Architect & Developer: A Guide to Self-initiating Projects*. PostScript Publishing, 2018.
- Tate, Jonathan. "3106 St. Thomas." OJT, 2016. <https://www.officejt.com/projects/3106-st-thomas>.

Parks Take Command; Public Space Centered Design Frameworks for Chicago's Large-scale Private Developments

Saldaña Perales Alejandro¹

¹College of Architecture at the Illinois Institute of Technology, Chicago, IL

ABSTRACT: The North American urban landscape faces major challenges at the threshold of a global climate emergency. A foreseeable cultural shift- the rise of the urban population- is an effort towards a more environmentally conscious future. In Chicago, like other major cities, the influx of newcomers is having detrimental consequences to the local population and their communities by displacing them. Currently, cities are mustering efforts to retain their current communities while allowing, if not encouraging, more people to call these growing urban centers home. This research considers the social and environmental implications of the current, and future, transformation of the North American urban landscape. It argues that cities like Chicago cannot afford to dismiss the private sector from these conversations. Similarly, it suggests that private developments can be collaborators, along with city authorities, and must actively participate in all efforts addressing the transformation of the urban landscape. This research favors large-scale private developments as a key strategy towards the expansion and growth of Chicago's contemporary urban landscape. Unlike most current design-based codes in North America, the research argues design and assessment of large-scale private developments ought to be centered on public space. As such, the design and assessment of large-scale private developments is critical towards addressing the social and environmental challenges Chicago, as most major North American cities, is currently facing.

KEYWORDS: Parks, Public Space, Chicago, Private Development, Design

INTRODUCTION

The present-day city of Chicago is the location of a unique cocktail of urban challenges. To architects, landscape architects, urbanists, as well as city authorities, the city's current expansion represents a grueling task. In a post-pandemic scenario, Chicago faces a crisis on two parallel fronts: On one hand, the ongoing expansion of its Central Area has exponentially increased the number of communities displaced and affected by it. These are mostly challenged Black and Brown communities, which have been severely transformed by decades of disinvestment. At the same time, the current global-scale climate emergency demands a high degree of enlightenment over a number of environmental variables towards sustainable urban growth.

1.0 BACKGROUND

Located in the South Side of Chicago, Bronzeville Lakefront, a four (4) billion dollar large-scale private development, faces the challenges mentioned above. Championed by diverse parties and stakeholders- ranging from local NGOs, real estate developers, and local politicians-, Bronzeville Lakefront, amongst other like-minded developments, shows itself as a model for future urban expansion at the threshold of what Prof. Kofi Boone, Landscape Architecture professor from the North Carolina State University, refers to "a dual-crisis scenario."(Boone 2021)

Enter the Covid-19 pandemic. If this enterprise wasn't difficult enough, the advent of Covid came to increase these challenges even more. When writing about the ongoing and future effects this pandemic has had over urban landscapes across the United States, author and urban scholar Richard Florida issued the following remarks: "As history demonstrates, the main effects will be to accelerate shifts already underway in how we live and work. Most of all, the intertwined crises of urban America and the political movement that has grown up around them and in their wake create a powerful resetting moment when it is possible to remake our cities, suburbs and entire metropolitan areas as more just, inclusive and resilient places."(Florida 2020) Florida's remarks, although meant as a warning, are also soaked in optimism. It is then understood that this is a crisis we can overcome. The scale of this battleground is that of the urban. Therefore, the disciplines in charge of all efforts should be those best suited to the urban scale.

In his 2020 book *The Nation City: Why Mayors are Now Running the World*, Emanuel shares his point of view in regards to the relationships of local city government policy and community-driven action. (Emanuel 2020) Emanuel's book implies the reliance of city politics on pragmatism, differing from the ideological narratives that stand at the core of federal or state levels. In doing so, the former Chicago mayor highlights the idiosyncratic values of urban scale politics, its scope, reach, and objectives. Indeed, cities are in a much better position to tackle the both social and climate crises due in part to the short distances between the local policy and their communities.

In most major cities all across the world, conscious responses to similar challenges are currently making headlines. The 15-Minute City, developed in Paris by Colombian-born urbanist Carlos Moreno, has achieved celebrity status since its inception last year. (Crook 2021) Over the past couple of years, it has been quite evident that most serious efforts in the collective quest to overcome social and climate disaster would come from cities. Their strategies are deeply rooted at the scale of the urban landscape.

Throughout its history, Chicago has been a city of competing narratives; its urban landscape descriptions often clash when seen from demographic, economic, social, and even architectural points of view. However, one must also understand the level of agency and control city authorities have over what happens in the city. Vertical analytical models, like the ones introduced by Prof. Neil Brenner from the University of Chicago, and more specifically the one employed by Prof. Derek Hyra from the American University in Washington, D.C., suggest other layers of factors to consider when understanding transformations at the urban scale. (Brenner 2019, and Hyra 2008)

In building what the Spirou & Judd coined as The City of Spectacle, former Chicago mayor Richard M. Daley established the physical boundaries of two distinct urban landscapes. (Spirou & Judd 2016) Spirou & Judd’s work is an assessment of an economic model, championed by a city government, involving large urban transformation exclusive to the Central Area. New divisions were physically reinforced with the preexisting urban landscape of the Central Area. Similarly, these borders were carved in the minds of Chicagoans living in the neighborhoods outside the Central Area.

Nowadays, large-scale private developments in Chicago are spreading outside the Central Area. Most of them take advantage of the availability of abandoned industrial yards and brownfields located right in between the Central Area and the city’s traditional neighborhoods. These developments export an urban model directly in conflict with their immediate vicinity. (Figure 1) The neighborhood urban landscape found adjacent to these developments, as well as their communities, displays signs of distress.



Figure 1: Satellite view of Chicago. Central Area highlighted. Current and proposed large-scale planned developments outlined in red. (Saldaña Perales, 2022).

Chicago has plenty of experience with large-scale urban developments. Through the tenure of Richard J. Daley as mayor of Chicago, the city battled the challenges posed by the post-war urban flight and the de-industrialization of the North American urban landscape and economy. Chicago scholar Ross Miller recognizes the efforts undertaken by the Daley administration and his predecessors in order to maintain a stable tax-paying base and stop a potentially catastrophic urban exodus. (Miller 2003) Miller’s work also centers on the endeavors to upgrade the Loop as Chicago’s response to the incoming talent and creative based economy. According to him, large portions of the blighted areas around the Loop were the ideal sites to accommodate new urban development to serve those working in downtown Chicago. Today, the Loop and its adjacent community areas encompassing what is known as “Downtown Chicago” are

the fastest growing in the United States. (Chicago Loop Alliance 2021) Many of Chicago’s assets play to its favor when it comes to financing large-scale developments. The size of the region’s economy, third in the USA and amongst the most powerful in the world, bring upon investments of such scale a sense of financial faith. As such, and despite not having direct investment commitments from the public sector, a qualitative element can be powerful enough to ensure funding throughout the duration of the project is constant. Finally, another asset Chicago possesses is access to independent investors, with billions of dollars, willing to invest, provided they have skin in the game.

Over the last 70 years, Bronzeville has suffered major transformations. These took place to satisfy -and in some cases induce- a similar demand of attractive urban neighborhoods for talented young creative professionals adjacent to downtown Chicago. (Wille 1997, Hunt & DeVries 2013, and Rast 2019) By virtue of its strategic location just south of downtown Chicago, good transit options, immediately adjacent to Lake Michigan and the lakeshore, its powerful cultural scenes, and reasonable land-values, Bronzeville introduces itself as an obvious choice for local, regional, and national migrant populations.

Over the last few months, public spaces are being re-evaluated as key components of the urban landscape. Regarding their recent path to stardom, Chicago based architect Carol Ross Barney says:

“I started out thinking that design will make a difference. As a kid, there were spaces that impressed me, that made my emotions change, and I was really aware of that power. I wanted to do that. But I had two epiphanies. One was that public space has a much bigger impact than other spaces. If you’re going to make everyday life better, why not do it in public? The second was that I’ve always felt empowered working in the public realm, because I see myself as a part of a community and that makes me not only the designer but the client.”(Mortice 2021, 26)

In the book titled Landscape Urbanism, Charles Waldheim, professor of Landscape Architecture at the Harvard Graduate School of Design (GSD), proposes Landscape Architecture as the discipline to take command of contemporary urban discussion and conversations. (Waldheim 2016) Waldheim argues that Landscape Architecture comes in to fill in a void left “as urban planning shifted from design to social science, and as urban design committed to neo traditional models of town planning.” In this work, Waldheim argues in favor of the idiosyncratic values of Landscape Architecture as tools towards urban expansion and growth.

Parks, thus public spaces and landscapes, are the organizing urban unit of Chicago. The combination of nature and the way it has merged into Chicago’s idiosyncrasy renders uniqueness to its case. Similarly, its citizens have been able to manage these resources and incorporate them into their lifestyles.

2.0 METHODOLOGY

My work puts forward a professional and objective strategy-oriented design matrix, centered on public space as a design framework to shape and assess new large-scale private developments in Chicago. This matrix is composed of seven frameworks grouped into three categories or scopes. Each framework, along with its theoretical composition and architectural attributes, was determined through extensive literature review. Similarly, literature review of each strategy provided clues towards selection of case studies to assess them individually. (Figure 2)

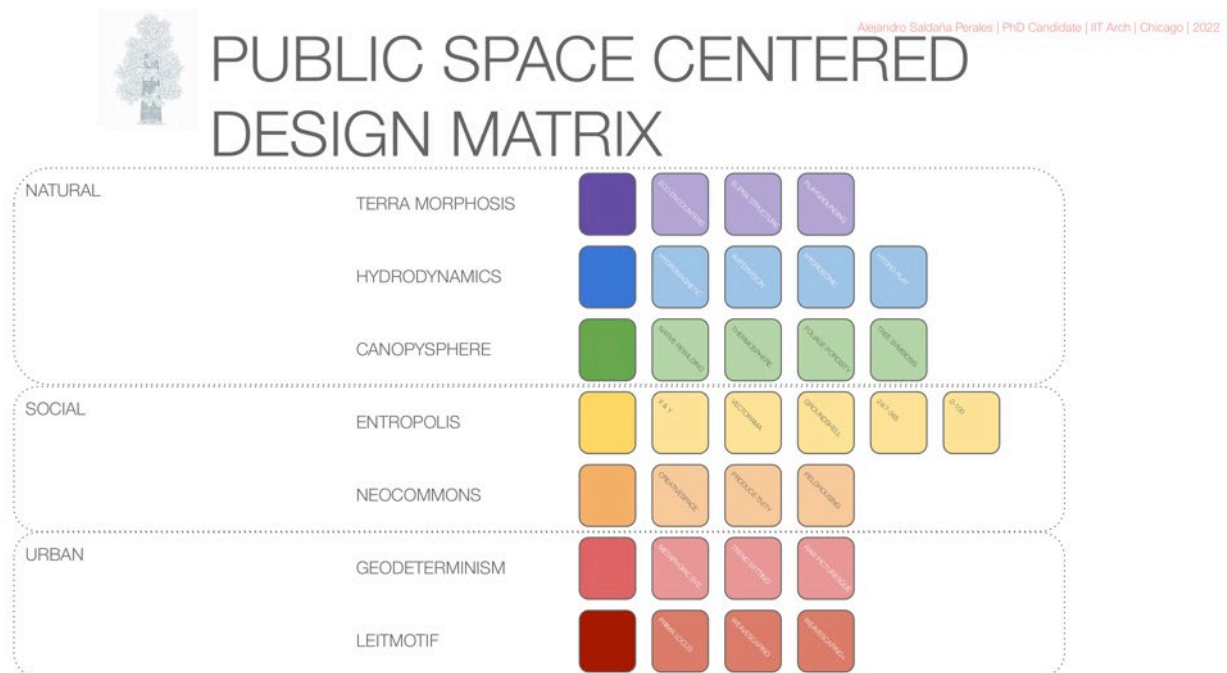

Figure 2: Public Space centered Design Matrix (Saldaña Perales, 2022).

Each case study focuses on a specific framework and illustrates the recommended strategies in this project. This research's case studies include a selection of large parks designed with the clear objective to either trigger, ignite, host, or poster the development of their city's urban landscape. These include (chronologically) Back Bay Fens Park in Boston, Lafayette Park in Detroit, Parque Fundidora in Monterrey, and Parc Downsvew Park, Waterfront Toronto, Wychwood Barns Park, & Corktown Commons -part of the Lower Don Lands- all in Toronto. Each park is thoroughly documented and analyzed in crafting the different strategies that compose this research's design matrix. (Figure 3)



Figure 3: Case studies shown next to each other at the same scale (Saldaña Perales, 2022).

Documentation of each park is performed using two parallel techniques. It begins with meticulous photographic documentation at eye-level, as opposed to aerial or satellite imagery, with high definition equipment to illustrate and carefully describe each strategy in the proposed design matrix. This activity is customized and is done with the purpose of defining and illustrating each strategy the way a person experiences the public space. In parallel, video documentation performed at three different times of the day -morning, afternoon, and evening- help to further elaborate on each of the strategies pushed forward by the case study. At the same time, video documentation emphasizes qualitative attributes that cannot be documented through photographic assessments alone. These, in such a manner, mimic an individual's autonomous sensory meridian response -ASMR- audiovisual stimuli. Such sensory-based documentation is performed with highly specific video and audio recording equipment, tailored for such tasks, and further enhanced throughout the editing process

3.0 PUBLIC SPACE CENTERED DESIGN FRAMEWORKS FOR LARGE-SCALE PRIVATE DEVELOPMENTS IN CHICAGO

Nowadays, Chicago faces the challenges posed by the global climate crisis. Despite being at an advantageous position, the city must not grow overconfident and risk doing nothing. (Recommendation: Reduce flood risk to protect people and assets 2022, and Rumore 2021] Current trends suggest more powerful storms will put the city and its infrastructure under tremendous stress. In the current panorama of a global climate crisis, local ecosystems are as important as any piece of urban infrastructure. (Cronon, 1991, 23-30 151-159, and Naikc, Ratti, & Proulx 2017, 93-101)

Unlike the heavily invested Central Area, the fastest growing neighborhood in America, [Chicago Loop Alliance, 2021) Black and Brown communities like Bronzeville lag behind after decades of neglect from city authorities; an unfortunate chapter in the city's history that spans most of the 20th Century with present-time repercussions. (Drake & Cayton 1993, Whiting 2005, and Spirou & Judd 2016) Urban development in Chicago, led by private investment, usually sidelines the natural landscape and its many functions, vital to the subsistence of the local ecosystem. Additionally, these urban landscapes are generally designed as contemplative rather than performative; they take advantage of the left over and abandoned industrial yards and brownfields surrounding downtown and within Black and Brown communities.

This research combines seven frameworks into a design matrix. It provides architects, landscape architects, and urbanists with the design strategies to shape large-scale private developments in Chicago, customized to Bronzeville

Lakefront. In parallel, it provides the City of Chicago with a comprehensive assessment tool for this and future like-minded developments.

3.1 Terra Morphosis [Natural]

Terra Morphosis centers on strategies towards the conscientious shaping of the ground level to address the challenges posed by our current climate crises. It pushes forward design strategies towards shaping climate resilient developments, performing as a natural frontline. Plus, it combines infrastructure and programmatic opportunities at the service of the development.

Terra Morphosis inquired about Corktown Commons in Toronto, part of the Lower Don Lands 2007 master plan; a 2013 work by Michael Van Valkenburgh Associates Inc. It has been covered in recent literature addressing high performing landscapes towards climate resilience. (Lister 2016, Masoud, 2021, 306-321, and Masoud 2022, 122-123)

Terra Morphosis is composed of three strategies: Eco Encounters, Supra Structure, and Playgrounding. Eco Encounters, a strategy operating at an ecological level, Calls for ground works as a strategy to face weather related challenges (i.e. rising water levels -gale-, strong wind/blizzard conditions. The Supra Structures strategy performs at an infrastructural level, asking for retrofitting a site with functioning public infrastructure as an opportunity to shape or sculpt the ground level. Finally, the strategy of Playgrounding invites land morphing of a site as a strategy to define programs as well as suggest programmatic shifts. In the *Bronzeville Lakefront* planned development, for instance, substantial earth works remain absent from preliminary design documents submitted to the local planning authorities. Their absence signals potential, currently unexplored, design opportunities for a site which, despite its location in the midwestern prairies, is not a flat surface whatsoever.

In synthesis, Terra Morphosis encompasses the strategies believed necessary to foster the design of evocative public landscapes alongside new urban developments at their service. It highlights design opportunities to foment ecological performance of public spaces. Finally, it aims to harness challenging climate enhanced ecological performance into architectural language towards the shaping of public spaces in large-scale private developments.

3.2 Hydrodynamics [Natural]

This framework focuses on the performance of a public space based on escalating degrees of human connection to water-based landscapes and infrastructure. The strategies it introduces are concerned with the various architectural efforts to nudge human activity towards water-based landscapes. This is done to connect natural water-based systems with the communities they serve. The framework works both at an infrastructure level and a sensory-oriented dimension. (Barragan, 1980)

Hydrodynamics assessed Brack Bay Fens Park in Boston. This Frederick Law Olmsted and Calvert Vaux design from 1879 has served the city of Boston not only as a major public space, but also as a tool to address the challenging tides of the Charles River and the North Atlantic Ocean. (Masoud & Holland 2021, 50-65, and Wilson 2021, 286-305) In parallel, it works as a brilliant example of how a work of public infrastructure, along with exquisite design, enabled the development of an entire new section of the 19th Century Boston urban landscape.

Hydrodynamics is made of four distinct strategies; Hydromagnetic, Watervision, Hydrosonic, and Water Play. Hydromagnetic, which unlike the rest of the strategies in this framework, has a scope around infrastructure. It calls to harness water, both in static and dynamic behaviors, into and towards designed locations and paths. Watervision suggests employing landscape architecture strategies (e.g. sideroad, trails, bluffs, revetments, slopes, lookouts, bridges, pontoons, decks, islands, and peninsulas) to establish diverse degrees of human-natural connections through sight. Hydrosonic favors employing landscape architecture tools (e.g. streams, creeks, shorelines, dikes, fountains, and waterfalls) to establish diverse degrees of human-natural connections through hearing. Finally, Hydro Play advocates employing landscape architecture strategies (e.g. decks, stepping stones, creeks, harbors, piers, landings, pools, fountains, and beaches) capable of establishing diverse degrees of human-natural connections by immersing citizens into water-based landscapes. In thinking of Bronzeville Lakefront, these strategies would positively enhance the design of its public landscapes. Even if acknowledged in the current design iteration, the project is located over a site with flooding hazards. Not to mention its location adjacent to Lake Michigan and susceptible to its forces.

Hydrodynamics nurtures public spaces within large-scale private developments capable of evoking powerful emotional connection to a high performing landscape. It raises awareness over our human dependence on such natural resource. In parallel, it enlightens over the need to achieve a symbiotic relationship with water through performing water-based landscapes at the center of our public realm, thus our daily lives.

3.3 Canopysphere [Natural]

This framework concentrates strategies to harness the qualitative virtues of tree canopy, performing as an atmospheric layer over the landscape, towards impacting the performance of the urban landscape. The strategies brought forward by The Canopysphere perform at two levels: the ecological and the programmatic. This framework understands the tree canopy as a living shelter over the public space capable of dictating actions at ground level.

Canopysphere studies Lafayette Park in Detroit. (Del Bo 2012, 4-41, Del Bo 2022, Harrington 2022, Waldheim, 2016, 107-109, and Denny & Waldheim 2020, 243-248) This 1956 collaboration between Ludwig Mies van der Rohe, Ludwig Hilberseimer, and Alfred Cladwell demonstrates the achievements of three masters in the disciplines of architecture, urbanism, and landscape architecture. Lafayette Parks sheds light on the many virtues a higher state of consciousness on the performance of vegetation (i.e. tree canopy) can provide.

The Canopysphere framework is made of four strategies grouped into two groups based on their performance. Ecologic strategies are titled Native Rewilding and Thermosphere. Programmatic strategies are Foliage Porosity and Tree

Symbiosis. Native Rewilding aims to reignite the site's ecological functions as core strategy via a minimum degree of intervention. It relies on the conscientious employment of native vegetation to assemble the urban landscape. Thermosphere calls for attentive design of the tree canopy towards a diverse degree of thermal control of the urban landscape. Foliage Porosity asks for understanding of foliage and tree density, selectively shaping canopy, evoking behavioral responses to imply programmatic determination and shifts (i.e. public & private) through the urban landscape. Tree Symbiosis invites collaboration and dialogue between tree canopy and adjacent structures and urban landscapes by performing as physical shelter and threshold between landscape and buildings. When thinking of Bronzeville Lakefront, its important to address the current state of the site, which the current design does not mention. Similarly, it would be useful to have further information regarding the different species of trees and their location in relation to the public spaces and building stock to better assess their effects over the development's urban landscape. The Canopysphere is an important piece of infrastructure to the public landscape in large-scale private development. Moreover, it is also a tool to suggest the activities that may take place at ground level. Through diligent design, the framework of the Canopysphere elevates the design of the public space by addressing the required ecologically performative tasks. Finally, it functions as an evocative natural, living, and always shifting tool in direct connection with human activity taking place in the public realm.

3.4 Entropolis [Social]

This framework harnesses programmatic density to nurture and boost qualitative performance of the urban landscape in relationship to the immediate communities. Entropolis pushes forwards a series of five strategies grouped into landscape-based and programmatic operations. It elaborates on the opportunities large concentrations of programs, distributed over the public spaces, cater to local communities and services the urban landscape.

Entropolis assessed Parc de la Villette in Paris. It included both the built project from Bernard Tschumi and OMA's unbuilt proposal, both part of the 1982 competition in charge of identifying the best design for this park. (Waldheim 2016, 15-17, Mostafavi 2016, 28, Mau & Koolhaas 1995, Koolhaas 2004, 152-160, and Kol & Zarco Sanz 2014, 191-208) However, the scope of this research, centering in privately developed public spaces within North America, demand a case study befitting of said criteria. Parque Fundidora in Monterrey was found to be a brilliant example including all the design virtues of Parc de la Villette whilst performing under the criteria established in this research. Therefore, this work employs Parque Fundidora as a case study for Entropolis. (Covarrubias Mijares 2000, Sánchez Macedo 2019, and Melé 2005)

The framework is composed of five strategies; X & Y, Vectorama, Groundshell, 24/7-365, and 0-100. X & Y invites strategic deployment of programs or amenities over either fixed or mobile coordinates within the urban landscape (i.e. rationalized as a Cartesian plane). Vectorama targets careful placement of corridors and paths, crisscrossing the urban landscape, to connect amenities and programs, as well as becoming programmatic units themselves. Groundshell aims to distribute programs covering large surfaces, or patches, to cover the entirety of the urban landscape with activity; thus, enhancing and balancing programmatic performance of the urban landscape. 27/7-365 calls for meticulous management of programs, densely packed into both 24-hour cycles, over each season (i.e. through diverse weather conditions) throughout the whole year. Last, 0-100 asks for diligent oversight of programs specially designed to reach all demographic groups by age. From programs suited to newborns all the way to the elderly.

Entropolis is concerned with the activation of the public spaces within a community's urban landscape. In parallel, it is entrusted with activating the urban landscape by virtue of tailoring the many programs taking place in that site. At last, Entropolis addresses the challenges faced by contemporary urban landscapes in terms of their performance as interdependent elements within a living community.

3.5 NeoCommons [Social]

NeoCommons establishes degrees of access to landscapes designed towards community-scale economic networks - exchange & production-. This framework is concerned with fostering community wealth through purposely performing public spaces. Furthermore, it boosts locally nurtured businesses as a preventive measure against gentrification.

NeoCommons analyzes Wychwood Barns Park in Toronto. Designed by DTAH in 2008, it has become a model for performative community scale public spaces. (Campigotto 2010, Goldberg-Miller 2015, 25-48, Clark & Silver 2016, 237-242, Silver 2021, 399-423) On a daily basis, Wychwood Barns Park demonstrates the potential of customized programming towards community service and social performance.

This framework is composed of three strategies; Creativespace, Produce-tivity, and Fieldhousing. Creativespace, mainly a programmatic exercise, centers programmatic governance towards creative activities -knowledge-based and artistic- capable of igniting economic ventures at the neighborhood scale. With a more natural focus, Produce-tivity calls for conscientious restoration of local nature; flora and fauna, harnessing all opportunities to foster on-site produce production and consumption at the neighborhood scale. And with an infrastructural scope, Fieldhousing suggests detailed assessment of existing structures and their attentive retrofitting towards housing community oriented programming.

NeoCommons promotes self-sustaining communities through neighborhood scale economic networks. This is a proactive measure where communities are empowered by having better platforms to create and manage businesses to cater their needs. Moreover, NeoCommons shares an idea that public space should also be a resource, available to all but customized to the needs of local communities, capable of generating wealth. This work believes this is achieved by nurturing productive activities to take over the public landscape.

3.6 Geodeterminism [Urban]

This framework dictates strategies towards awareness of environmental systems, favoring the development of human-nature symbiotic settlements. Geodeterminism argues large-scale private developments ought to be designed in tune with natural processes. In other words, they must be developed at a progressive pace rather than a one-time single effort. This framework shares the belief that it is possible to develop urban landscapes at an incremental pace and still be able to make a profit.

Geodeterminism assesses Parc Downsview Park in Toronto. (Kol & Zarco Sanz 2014, 191-208, Czerniak 1997, 110-120, Waldheim 2001, 80-85 98-100, Waldheim 2002, 10-17, Reed 2016, 338-343, Liscombe & Sabatino, 2016, 315, Waldheim 2016, and Mau 2022) This project, fruit of a 2001 collaborative effort between OMA and Bruce Mau Studio, sought to repurposing a former military airbase into a livable and thriving community with a major park at its center. The scale of this project's transcendence is implied in the list of stakeholders, which include the Canadian (federal), Ontario (provincial), and Toronto city government (local). Nowadays, Parc Downsview Park continues to demonstrate the viability of paced development as a successful alternative towards shaping the contemporary urban landscape.

The strategies laid out in Geodeterminism are Metaphoric Systems, Trend Setting, and Raw Picturesque. A strategy with a design scope, Metaphoric Systems aims to suggest, rather than impose, unified or collaborative design strategies as organizational systems of the urban landscape. Trend Setting, a development focused strategy, invites positioning of cyclical agendas, natural and human in parallel, in favor of progressive development of the urban landscape. Finally, under a performative scope Raw Picturesque asks for outlined adaptability (i.e. resiliency) of human and natural systems composing the urban landscape, favoring performance over picturesque design narratives; it Demands dominion and understanding of either system and their limitations.

Geodeterminism functions as a framework whose main focus is the ability of a large-scale private development to adopt natural models of growth as a development agenda. It aims to create a collaborative environment with the local ecosystems through adaptability. Thus, it embraces the transformative potential of its design. In doing so, the development holds a better opportunity to perform alongside the natural landscape within it. The development's public spaces have, therefore, a chance to act as an agent of climate resiliency, benefitting itself and the adjacent urban landscape.

3.7 Leitmotif [Urban]

This framework settles the strategies that stitch the development's many parts or pieces with each other as well as with the adjacent urban landscape, and maneuver identifying a common thread or rhythm -to employ musical terms- throughout the urban landscape of a single development. This rhythm will work as connective tissue in between the many public landscapes of a large-scale private development as well as those outside its boundaries.

Leitmotif studies Waterfront Toronto master plan by West8 and DTAH. This 2006 master plan, like Parc Downsview Park, is the result of a collaborative endeavor at all levels of government. The brief of the project suggested the need to bridge the gap between the city of Toronto and Lake Ontario through creative use of its lakefront. (Waterfront Toronto Takes Action to Reconnect City to its Lake 2001, Crombie 1992, Greenberg, Crombie & Ebrahim 2009, Logan 2021, 86-103, and Long 2022) Furthermore, the challenge was also to bridge the many gaps and barriers created by the very scale of this project and connect its many parts into a cohesive whole.

The strategies laid out in Leitmotif are Prima Locus, Weavescaping, and Weavescaping+. Prima Locus calls for prioritizing public spaces as the first elements within the development to be constructed towards immediate performance over the urban landscape. Weavescaping focuses on tectonic, natural, or programmatic connections amongst the different pieces of the development's urban landscape. And Weavescaping+ suggests meticulous use of tectonic, natural, or programmatic connections amongst the development with the adjacent urban and natural landscapes.

In brief, Leitmotif introduces scale to design. It encourages the diversity of the public spaces within a large-scale private development while meeting opportunities to stitch them together under a common banner. Finally, it acknowledges these developments do not operate in isolation and must in fact be willing to work with the immediate urban and natural landscapes to maximize their overall performance as well as the experience of the communities inhabiting them.

CONCLUSION

This research finds that cities are the vehicles propelling the most industrious strategies in the face of a global climate crisis and an increasingly divided society. In a polarized Chicago, the sites where these boundaries blur are where new large-scale private developments must shape buffer zones between two competing urban landscapes towards collaborative relationships. It highlights the importance of public spaces and their relationship to the overall performance of the contemporary urban landscape as a unified and living network. Furthermore, it finds that new urban developments can and must perform as ecologically resilient tools serving the communities they will attract and foster.

New large-scale private developments are part of a collaborative strategy and must be shaped as performing public parks. As such, their design ought to foster a vibrant public realm. In parallel, their public landscapes must perform to reignite the site's ecological functions.

The industrial landscapes, once common symbols of progress in a bygone era, now lay abandoned in Chicago as well as many North American cities. Strategically located near the Chicago Central Area, they supply land for new private developments targeting incoming populations. They represent the biggest opportunity to address current localized social conflicts and the global-scale climate emergency.

The private capitals, responsible for major portions of the contemporary urban landscape, must not be dismissed from the discourse, whether theoretical or practical, centering on shaping cities. Due to the way the economic models have been crafted and continue to perform, in North America, private developments are partners and a key component of the urban landscape.

The proposed design frameworks, tailored to Chicago, could perform as policy tools for similar cities in North America along what is known as the Rust Belt. The design matrix suggested in this work has the potential to democratize urban policy. Shaped as an objective tool, the use of this matrix can also be extended to communities and residents in any given urban area. It provides them with access to an assessment tool that, with proper guidance, can help decentralize decision-making.

Finally, architects, landscape architects, and urbanists in most urban landscapes in North America as a design tool can employ the design matrix introduced in this research. Similarly, it has the potential to perform as a pedagogical tool in a studio environment under academic leadership.

REFERENCES

- (2021, March 8). "Waterfront Toronto Takes Action to Reconnect City to its Lake." Waterfront Toronto. Retrieved February 13, 2022, from <https://waterfronttoronto.ca/nbe/portal/waterfront/Home/waterfronthome/newsroom/newsarchive/news/2021/march/waterfront+toronto+takes+action+to+reconnect+city+to+its+lake>
- (2021, October 19). "The Chicago Loop's New Demography: Reviewing Change from 2010-2020." Chicago Loop Alliance. Retrieved November 22, 2021, from <https://loopchicago.com/assets/The-Chicago-Loops-New-Demography.pdf>
- (2022, October). "Recommendation: Reduce flood risk to protect people and assets. On to 2050." Chicago Metropolitan Agency for Planning. Retrieved November 25, 2022, from <https://www.cmap.illinois.gov/2050/environment/flooding>
- Barragán, L. (1980) "Luis Barragán, 1980 Laureate Acceptance Speech. The Pritzker Architecture Prize. Retrieved November 25, 2022, from https://www.pritzkerprize.com/sites/default/files/inline-files/1980_Acceptance_Speech.pdf
- Boone, K. (2021, November 15). "Revisiting the Commons." University of Toronto, John H. Daniels Faculty of Architecture, Landscape, and Design, livestreamed webinar, 1:02:04, <https://www.youtube.com/watch?v=ZPQSeqJBGM8>
- Brenner, N. (2019). *New Urban Spaces: Urban Theory and the Scale Question*. Oxford, UK: Oxford University Press.
- Brizuela, O., & Adolfo, M. (2005) *La construcción del patrimonio urbano*. Translated into Spanish from Melé, P. "Patrimoine et action publique au centre des villes mexicaines", México: La Casa Chata.
- Campigotto, R. M. (2010). *Farmers' Markets and their practices concerning income, privilege, and race: A case study of Wychwood Artscape Barns in Toronto*. Thesis (Master's of Education). Toronto: University of Toronto.
- Clark, T. N. & Silver, D. A. (2016). *Scenescapes: How qualities of place shape social life*. Chicago: University of Chicago Press, pp. 237-242.
- Covarrubias Mijares, R. (2000). *Tierra, fuego, aire, agua: un estudio sobre el devenir urbanístico y arquitectónico de la Fundidora de Monterrey*. Monterrey, N.L.: Grafo Print Editores.
- Crombie, D. (1992). *Regeneration: Toronto's Waterfront and the Sustainable City : Final Report*. Toronto: Royal Commission on the Future of the Toronto Waterfront.
- Cronon, W. (1991). *Nature's Metropolis: Chicago and the Great West*. New York: W. W. Norton & Company. pp. 23-30, 151-159.
- Crook, L. (2021, October 26) "15-Minute City concept by Carlos Moreno wins Obel Award 2021." Dezeen. October 26, 2021. Retrieved December 1, 2021, from <https://www.dezeen.com/2021/10/26/15-minute-city-carlos-moreno-obel-award/>
- Czerniak, J. (1997, December). *Challenging the Pictorial: Recent Landscape Practice*. In *Assemblage*. Cambridge, MA: The MIT Press, Dec., 1997, No. 34. pp.110-120.
- Del Bo, A. (2012). *The Two Ludwig in Detroit*. Unpublished. pp.4-41.
- Denny, P. & Waldheim, C. (2020, June). *Reconsidering Hilberseimer's Chicago*. In *Cogitatio*. Lisbon: Licensee Cogitatio, Volume 5, Issue 2, pp. 243-248.
- Drake, S. C., & Cayton, H. (1993). *Black Metropolis: A Study of Negro Life in a Northern City*. Chicago: University of Chicago Press.
- Emanuel, R. (2020). *The Nation City: Why Mayors Are Now Running the World*. New York: Knopf.
- Florida, R. (2020, July 2). *The Forces That Will Reshape American Cities*. Bloomberg CityLab. <https://www.bloomberg.com/news/features/2020-07-02/how-coronavirus-will-reshape-u-s-cities>
- Goldberg-Miller, S.B. (2015). "Creative Toronto: Harnessing the Economic Development Power of Arts & Culture." *Artivate* 4(1), 25-48. doi:10.1353/artv.2015.0006.
- Greenberg, K., Crombie, D., and Ebrahim, Z. (2009). *Toronto Reborn: Design Successes and Challenges*. Toronto: Dundurn Press.
- Hunt, D. B., & DeVries, J. B. (2013). *Planning Chicago*. New York: Routledge.
- Hyra, D. S. (2008). *The New Urban Renewal: The Economic Transformation of Harlem and Bronzeville*. Chicago: University of Chicago Press.
- Kol, Z. & Zarco Sanz, C. (2014). "Collaborating with Indeterminacy: A framework to Intervene." In *Revista Europea de Investigación en Arquitectura*, Madrid: Universidad Europea de Madrid, No. 2. pp. 191-208.

- Koolhaas, R. & Mau, B. (1995) "Bigness or the Problem of Large," in: S, M, L, XL. New York: Monacelli Press.
- Koolhaas, R. (2004). *Delirio de Nueva York; un manifiesto retroactivo para Manhattan*. Barcelona, Editorial Gustavo Gili. pp. 152-160.
- Liscombe, R. W. & Sabatino, M. (2016). *Canada: Modern Architectures in History*. London: Reaktion Books. p.315.
- Lister, N. (2016). "Insurgent Ecologies: (Re)Claiming Ground in Landscape and Urbanism." *Ecological Urbanism*. Zurich: Lars Müller Publishers. pp. 550-561.
- Logan, K. (2021, June) "As Waterfront Toronto's Quayside Development Resets, Landscape Returns to the Fore" *Landscape Architecture Magazine*, pp.86-103.
- Masoud, F. (2021). *Terra-Sorta-Firma, Reclaiming the Littoral Gradient*. New York: Actar Publishers. pp.122-123.
- Masoud, F. (2021). "Landscape Resilience Frameworks for Urbanism on Reclaimed Land." *Terra-Sorta-Firma, Reclaiming the Littoral Gradient*. New York: Actar Publishers. pp.306-321.
- Masoud, F. & Holland, E. (2021). "Landscape Architecture is Resilient Design: Enduring strategies and Frameworks adapted from the Olmsted Office." in *Journal of Landscape Architecture* 16(3): pp.50-65.
- Miller, R. (2003). *Here's the Deal: The Buying and Selling of a Great American City*. Chicago: Northwestern University Press.
- Mortice, Z. (2021, October). "Newsmaker: Carol Ross Barney." *Architectural Record*.
- Mostafavi, M. (2016). "Why Ecological Urbanism?" in Moshen Mostafavi & Gareth Doherty, *Ecological Urbanism*. Zürich: Lars Müller Publishers,. p.28.
- Rast, J. (2019). *The Origins of the Dual City: Housing, Race, and Redevelopment in Twentieth-Century Chicago*. Chicago: University of Chicago Press
- Reed, C. (2016). "The Agency of Ecology." *Ecological Urbanism*. (Zürich: Lars Müller Publishers, pp. 338-343.
- Rumore, K. (2021, July 29). "It almost sounded like a hurricane': Derecho weather events in the Chicago area since 1965." *Chicago Tribune*, Retrieved November 25, 2022, from <https://www.chicagotribune.com/news/breaking/ct-cb-chicago-derecho-storms-20200811-zollgji5djf5feh3lb66lnary-story.html>
- Sánchez Macedo, J. (2019). *Donde habita el olvido: conformación y desarrollo del espacio público en el primer cuadro de la ciudad de Monterrey, 1980-2007*. Monterrey, N.L.: Centro de las Artes, Nave Dos.
- Silver, D. (2012). "Local Politics in the Creative City: The Case of Toronto." *The Politics of Urban Cultural Policy: Global Perspectives*. London: Routledge, pp. 399-423.
- Spirou, C., & Judd, D. R. (2016). *Building the City of Spectacle: Mayor Richard M. Daley and the Remaking of Chicago*. Ithaca: Cornell University Press.
- Seiferling, I., Naikc, N., Ratti, C., & Proulx, R. (2017). "Green streets – Quantifying and mapping urban trees with street-level imagery and computer vision." *Landscape and Urban Planning*. 165: pp. 93–101.
- Waldheim, C. (2001, March). "Park=City?." In *Landscape Architecture Magazine*, Vol. 91, No. 3. pp. 80-85, 98-100.
- Waldheim, C. (2002). "Landscape Urbanism: A Genealogy." In *PRAXIS: Journal of Writing + Building*, 2002, No. 4, *Landscapes*. pp. 10-17.
- Waldheim, C. (2016). *Landscape as Urbanism: A General Theory*. Princeton, NJ: Princeton University Press.
- Waldheim, C. (2016). *Landscape as Urbanism: A General Theory*. Princeton, NJ: Princeton University Press. pp.15-17, 107-109.
- Whiting, S. (2005). *Bas-Relief Urbanism: Chicago's Figured Filed*. Chicago Architecture: Histories, revisions, alternatives. Chicago: University of Chicago Press, pp. 314-326.
- Wille, L. (1997). *At Home in the Loop: How Clout and Community Built Chicago's Dearborn Park*. Carbondale, IL: Southern Illinois University Press.
- Wilson, M. (2021). "Boston's Shifting Ground in a Changing Climate." *Terra-Sorta-Firma, Reclaiming the Littoral Gradient*. New York: Actar Publishers. Pp.286-305.

Public Space: An Instrument of Urban Activism

Seung Ra¹

¹Oklahoma State University, Stillwater, OK

ABSTRACT: The public realm offers a powerful opportunity for bringing about transformational change in cities and societies. The paper focuses on ten selected student projects undertaken within a capstone architectural studio, which reimagine public spaces through the creation of ten different fictional stories. Culture is intrinsically woven into the pedagogical matter of this project, enabling it to respond to society's complex challenges as they emerge. These design fictions present a variety of narratives ranging from a metaphor of public space as an uneven battlefield between power and powerlessness to architecture's rejuvenating qualities as a reclamation process. Using fictional narratives is essential for exploring how architecture engages the city and its culture in a way other disciplines cannot. The projects aim to establish 'real' tales of and about people in these stories, with the narratives reflecting their unique challenges and struggles. The projects were conducted through a capstone studio that proposes re-appropriating public space to examine the cultural landscape and social behavior of public spaces. These fictional stories naturally integrated 'actionable knowledge' and ethical and critical thinking to address real-world concerns.

KEYWORDS: Public space, Culture, Narratives, Activism, Intervention

INTRODUCTION

This paper begins by examining the envisioning process. It is possible to define adequate public space from the perspective of various fields of study, including architecture, urban design, city planning, infrastructure, geography, and sociology. Can public spaces be evaluated comprehensively? How can we capture the meaningful qualities of public space through narrative storytelling? The pedagogic matter of the research project possesses the cultural sensibility needed to quantify and evaluate the performance of visible and invisible public spaces.

Many of urban design's foundational texts borrow analytical techniques from other disciplines. However, in diverse ways, they contribute to cultivating new knowledge about what is unique about the subject and practices of urban design. The discipline still faces considerable discord concerning its very nature, despite new knowledge being continuously infused into a singular and tolerably coherent field of study. While the Modern Movement produced many well-documented grand projects, some of them were falsely marketed based on their social benefits (Knox 2011). Urban design practitioners from practice-based backgrounds and those with a critical social science approach differ clearly. Many critics have dismissed design-led development as deterministic or irrelevant if it is coupled with socioeconomic or scientific factors that are less subjective or more certain (Kashef 2008).

The ultimate objective of the intentional design processes studied was to create a 'vision' for positive change. The design process of establishing public space varies greatly, so it is necessary to respond to the very different physical contexts they shape, the stakeholders they engage with, and the aspirations they address. In established urban visions, the design process is often lengthy, complex, and influenced by many factors. A creative design process is essential to accomplishing this, where the goal is to create an 'event'; a unique, attractive place that draws users in and encourages them to pause, even for a moment. Integrated with allied development processes, the method is an iterative design process of the type long represented in models of design methods.

1.0 EDUCATIONAL OBJECTIVES AND STRATEGY OF THE PROJECTS

Architecture has engaged masterplans for over one hundred years in order to influence city design as part of its preoccupation with influencing urban space. It provides control over the form of the city, and the way the city's morphology is programmed, as a form of representation. This mega-scale plan provided reassurance to the discipline that it would be able to maintain control of the city. However, it invites critique as it does not always adequately take into account the late 20th and early 21st Century city's ever-increasing complexity. This project explores how a new kind of representation—a super-drawing—can begin to account for the diverse conditions the city has to offer, while leaving room for the informal and impromptu design needed for cultural spaces to occur.

The projects explore how a super-drawing as alternative to masterplan can be used to uncover a diverse set of issues related to the city, and to generate a creative scenario that provides a compelling opportunity for transformative change in cities and societies. A collective of fictional stories becomes a tool for experimental proposals that encompass the realm of "actionable knowledge," or images that represent narratives that fertilize ethical and critical thinking to respond to contemporary urban problems (Salama 2002). The notion of fictional narratives is essential for responding to how

architecture imagines, engages, and realizes the city. Storytelling can be used to define the audiences that will interact with the space at a personal level, while simultaneously reaching a broader audience. A *real-life story* unfolds by realizing these narratives visually, with architectural modes of representation providing alternatives to existing urban conditions (Hayden 1995).

The super-drawing enables new configurations and possibilities for how unique ground conditions can address the physical and spatial elements of the masterplan, but expands those concerns to include considerations such as characters within the city, the nuances of the public realm, diverse contextual conditions, biodiversity of a changing climate, and the infrastructural demands that serve these relationships. Based on these four sequences, students created the super-drawings to visualize and convey new configurations and possibilities; 1) Feasibility and Strategy: Articulate the innovative character of the public space and review available options for environmental and social impact; 2) Concept and Experience: Utilize storytelling to uncover issues and generate a creative scenario that addresses the physical and spatial elements of the masterplan, including character, public realm, context, biodiversity, and infrastructure; 3) Image and User: Define the user groups who will interact with the space, and how it can be integrated simultaneously at a personal scale and for broader audiences; 4) Function and Structure: Meet the programmatic requirements for users and support evolving social structures.

The taxonomy of public space based on these unique conditions can address the masterplan's physical and spatial requirements, user groups, cultural nuances, diverse contexts, climate issues, and infrastructural needs. The following projects addressed these issues in various frameworks and scales, from the larger urban construct down to architectural place-making strategies for individual places.

2.0 METHODOLOGY 1: Using Narratives at The Urban Scale

First, we examine the narrative approach at the urban scale. According to Mumford (1961), the city has the primary function of transforming power into form, energy into culture, dead matter into living symbols of art, and biological reproduction into social creativity. There is no end to the story of the human experience, even though the details change over time and place. Comparative mythologist Joseph Campbell refers to this story as *The Hero's Journey* (2014). Any adventure story includes six elements that form a narrative arc: The Call, the Road of Trials, the Abyss, Transformation, Apotheosis, and The Return. Both physical aspects and situational and cultural aspects of urbanism are incorporated into the mythologizing of urbanism.

What makes a narrative of urbanism memorable? The stories of a city and its residents are shared between them. Through dreams and works of art, most epic stories throughout history have their origins in a defined space, especially the great ancient mythologies. The art of storytelling is an integral part of urban design. Taking the time to listen to stories of place can help designers understand the narrative fabric that is as crucial to the context of a site. Perhaps municipal urban designers should curate and advocate for the vitality of the narrative landscape by creating anthologies of neighborhoods' stories. Making strong settings for everyday stories, literary tales, and myths should be foundational to design. The role of urban designers could be crucial in nurturing an articulate, nuanced, well-informed, and lively exchange of thoughts about what makes each city unique. Storytelling helps urban development professionals to make more sound decisions, because at its core it begins with understanding a city or community's spirit of place. By understanding this spirit and identifying the problem to be solved together with stakeholders, storytellers can identify the true context of a place and begin to transform it.

Storytelling about places and retelling them, remodeling main street facades, and articulating design aesthetics for buildings are ongoing, evolving activities. We write and live out our personal stories in the places we live, whether they are cities, towns, villages, or suburbs. Memories of meaning are imprinted on certain places. The following student projects were established using the four sequences listed above to address larger issues of future urban life. The first example (Figure 1) describes two friends discussing the social conditions within a futuristic living pod:

Dwight: Hey Harry, have you enjoyed your first few months in the pods?

Harry: Oh, I am adjusting to life here, but overall it has been good.

Dwight: It is nice to have a breath of fresh air. I doubt that would ever happen here.

Harry: You are probably right. Overall, I am enjoying the pods, but have you heard what they have on the level above us?

Dwight: I have heard only rumors. What did you see?

Harry: It was incredible up there. They have way better living conditions.

In the second example, *Noircitiescapes* (Figure 2), societal isolation becomes normative, and technology will advance in areas that make isolation easier. Eventually, society will become so insular that they forget about their surroundings, leaving behind a derelict world. This reality takes place in a world in which isolation is not forced but is willfully adopted and encouraged. Although this Huxleyan dystopia is not yet upon us, increased isolation and lack of social interaction could bring it nearer. This submission aimed to call attention to the possible ramifications of this dystopian future. In the third example (Figure 2), *AngeLA* has lived in downtown Los Angeles her whole life. Her journey began when Angela's teacher gives the class a riddle to solve. The riddle goes like this:

*Find a place where you can play outdoors **But won't find swings or slide.***

*A place with streets and sidewalks **But no bus or train to ride.**
 A place where many people live **But no one has a home.**
 But a place that's growing, a place that deserves **Opportunities** like our own.*

These narratives address the uncertainties of future urban space. The growing interest in public urban space and the increase in academics and professionals involved in it have brought to light the need for a more precise definition of urban scale. How the narratives addressed these uncertainties was a key part of the studio projects, in which analysis of those aspects of urban design were studied. The storytelling became a vehicle to examine the aspects of urban scale which have caused so much ambiguity in order to address future possibilities.



Figure 1: #ANTHROPOCENE 99% of the earth's surface will be declared uninhabitable by 2099. Life in pods is irreversible. Source: (Oklahoma State University Urban Studio student work 2019)

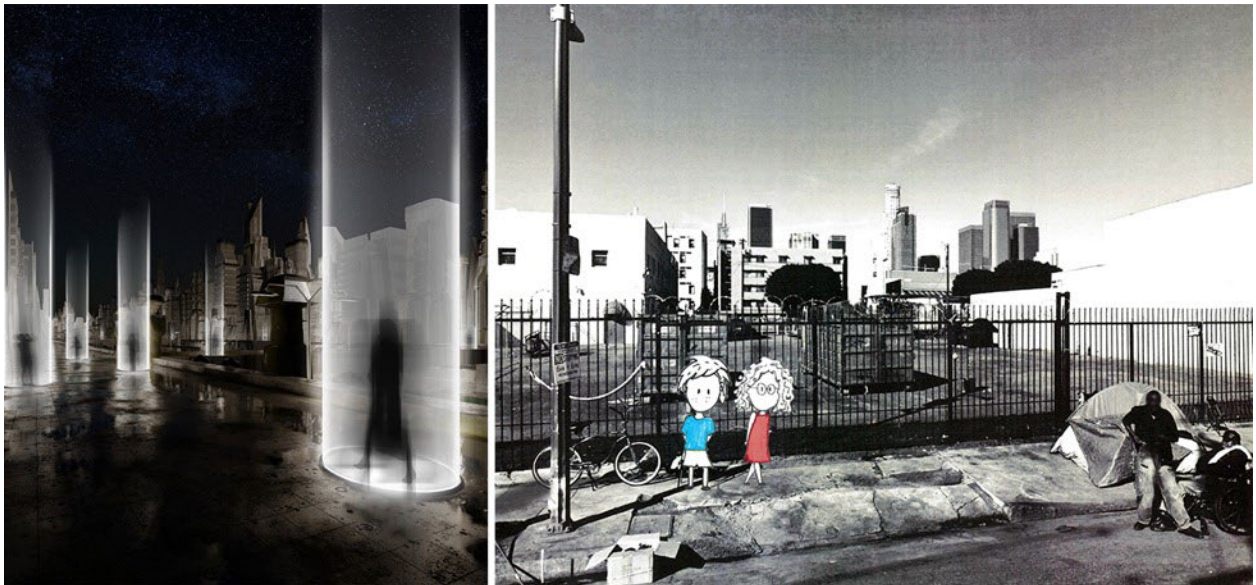

Figure 2: #NOIRCITYSCAPES(Left) Societal isolation becomes normative. #BETWEENTWOWORLDS(Right) AngeLA. Source: (Oklahoma State University Urban Studio student work 2020)

3.0 METHODOLOGY 2: Storytelling Shapes the Masterplan

At the level of the masterplan, students addressed particular areas within the city to focus upon. Urban design plays a critical role in this reshaping in its broadest sense and the role and challenges of urban design in shaping masterplans as architectural discourse is to achieve cohesion between structural elements and spaces. The masterplan serves to organize and connect the spatial and social aspects of urban space. This is accomplished via three types of elements: natural elements, human activity nodes, and architectural elements (Boyer 1996). A human activity node can be defined by a streetscape, a workplace, a residence, a storefront, or a cafe. The purpose of these public spaces is to connect natural elements and reinforce activity centers through architectural elements.

As a social process, urban design is characterized by the involvement of numerous actors (makers, controllers, and users of urban space) with various roles and interests that interact at different stages of master planning. The creative process of the masterplan reflects a new division of labor among stakeholders, shapes the built environment, coordinates and leads the development process, stabilizes market conditions, and markets the development. The masterplan is often shaped by a group of designers interacting with other professionals, including landowners, financiers, planning authorities, and politicians. Interaction involves participants in the implementation phase, users of the space, and those affected by it. There can, however, be tensions and incompatibilities between the three perspectives (makers, controllers, and users), as well as differences within each perspective (Jacobs 1985).

Although the masterplan is frequently used in educational and professional literature, it remains an ambiguous term, used differently by different groups in different situations (Madanipour 1997). It enhances the symbolic value of the city for its users, even though these values are always contested. This improves the competitiveness of the city, shapes its future, manages its environmental change, and contributes to good governance by encouraging different stakeholders to participate in the development and implementation of the city's vision. These projects highlighted the numerous stakeholders and their roles in the masterplan to demonstrate its value in urban renewal.

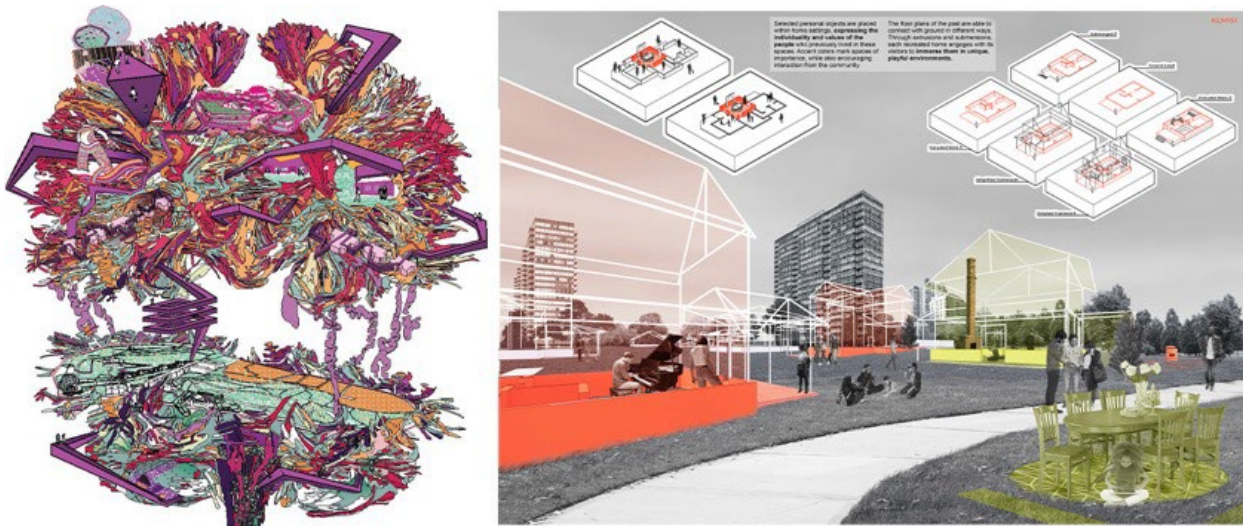

Figure 3: #DICHONOMY(Left) Relationship between human and oyster ecology. #COLLECTIVEMEMORY(Right) The Lake Meadows neighborhood of Chicago. Source: (Oklahoma State University Urban Studio student work 2020 & 2021)

In the first project, *Dichonomy* (Figure 3), Governor Island's master plan and design are influenced by a dichotomy between human and oyster ecology. Congruent design philosophy was developed as a result of the opposition between humans and oysters. Governors Island offers a unique landscape in a prominent location within New York City, where the past meets the present. It encapsulates a single motive: to be a center for climate solutions. The Island will promote sustainability, resiliency, and leadership by implementing novel development methods and adaptive reuse techniques. Nature is an inspiration for developing the Island's character, the public realm, context, biodiversity, and infrastructure. In a similar vein, *Metamorphosis* (Figure 4) addresses climate. Metamorphosis is a biological developmental process that involves relatively rapid change. As we face our own inevitable metamorphosis into humanity's next stage of development, we must pursue a symbiotic relationship with nature if we hope to adapt and survive long-term on this planet.



Figure 4: # METAMORPHOSIS: a symbiotic relationship with nature. Source: (Oklahoma State University Urban Studio student work 2021)

Another theme questioned how we address memory in urban space. *Collective Memory* (Figure 3) explores the Lake Meadows neighborhood of Chicago, an affluent neighborhood that features modernist towers and open fields. Formerly, this was a working-class neighborhood populated predominantly by people of color and immigrants. In the course of urban renewal, thousands of families were removed and excluded. Using vernacular artifacts, the project narrative documents the loss of community. Interventions highlighting critical moments in the community are used to define the sites. By juxtaposing these artifacts with the aesthetically planned community, they question the morality of architectural intervention.

4.0 METHODOLOGY 3: Stories Are Public Space

At the scale of individual public spaces, students were challenged to implement responsive solutions within the framework of larger urban issues. Identifying the major structural changes that cities are undergoing is the first step to understanding the significance of public space. Globalization has led to a new view of cities (Olds, 2001; United Nations, 2001; Sassen, 2002). The way public spaces are shaped in the contemporary city and the contexts, processes, and power relationships that inhabit them form an integrated framework (Bosselman 2008). In contemporary cities, public spaces are exemplified by a journey through time during which contemporary public spaces take shape. Taking urban design into account as a *place-shaping continuum*, the discussion advances a theory of the process of urban design (Carmona 2021). In all its complexity and variety, this urban design (or place-shaping) process is a powerful anchor for intellectual inquiry and policy/practice innovation in urban design.

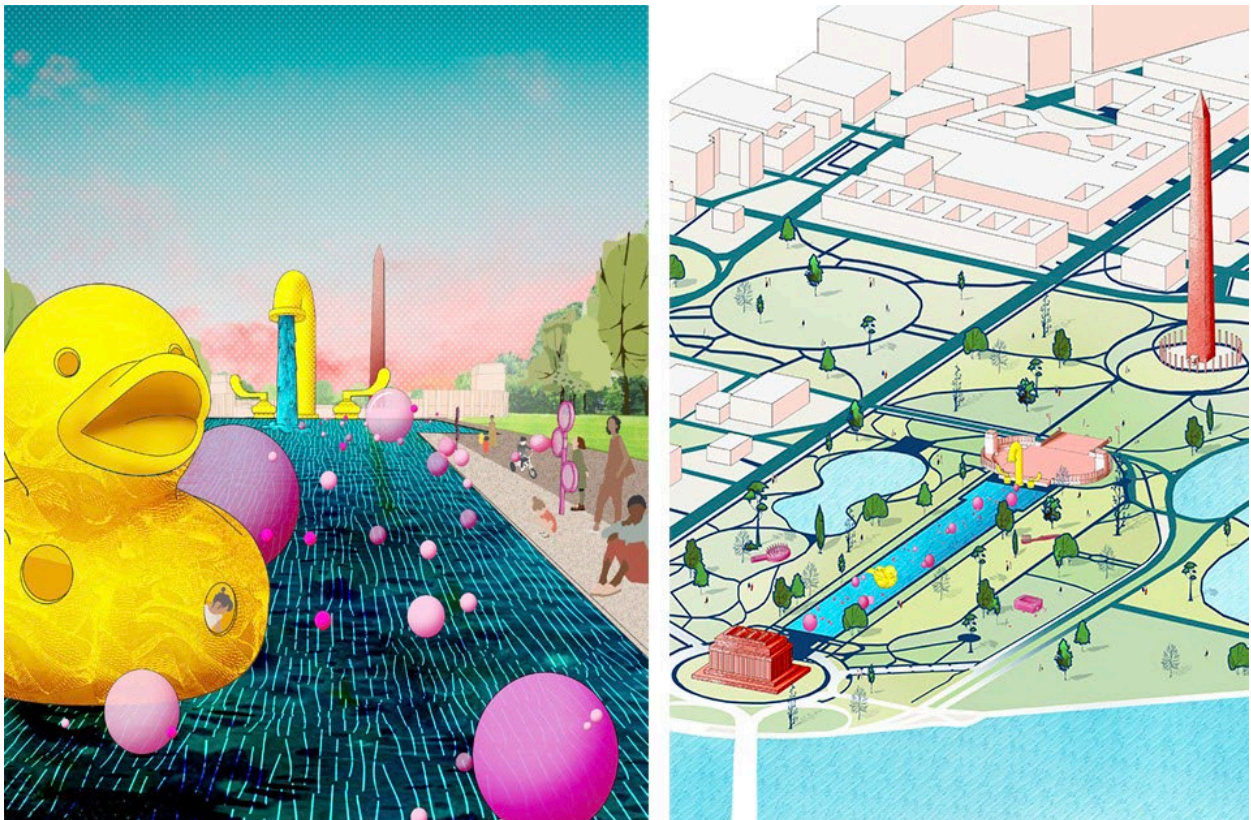

Figure 5: #NOSTALGIA This urban intervention aims to redefine beauty on the National Mall. Source: (Oklahoma State University Urban Studio student work 2020)

In *Nostalgia* (Figure 5), the urban intervention aims to redefine beauty on the National Mall by addressing several primary architectural elements: the monumental edifice, the formal geometry, and the materiality of the singular structure. Even so, the installation was characterized by mundane materials and a whimsical color scheme. A sense of familiarity and a degree of absurdity penetrate the harsh atmosphere. A vulnerability exists beyond simple absurdity in bathrooms and bath toys. Participants are invited to contribute to the atmosphere by blowing bubbles along the perimeter. In its whimsy, the giant duck provides a unique viewing platform.

The social value that urban design delivers to society is frequently discussed in terms of the equitable, sustainable, and livable city it delivers (Gehl 2010). Despite these normative aspirations, research reveals that they are difficult to achieve without a focus on a key objective, creating economic value. In the residential sector, it was usually simply 'aesthetic value,' but in the corporate sector, space needed to be 'put to work' to maximize value. Furthermore, apart from their aesthetic value, they had a 'use value' that had to be maximized to increase occupant enjoyment and attract visitors.

The clearest example of how to establish value is the commercialization of space. Commercial uses are often drawing people in, animating space, creating active façades, providing space with a purpose, helping to provide a return on investment, and cross-subsidizing public goods. The value imperative lies at the heart of city making procedure. When it is overlooked or fails, it can lead to despised, exclusionary, unsustainable, and ultimately unlivable spaces.



Figure 6: #INTERVENTION(Left) The creation of a woven fabric defines a space. #PSYCHOLOGICAL(Right) The emergence of technology allows us to exist in physical and virtual spaces simultaneously. Source: (Oklahoma State University Urban Studio student work 2020)

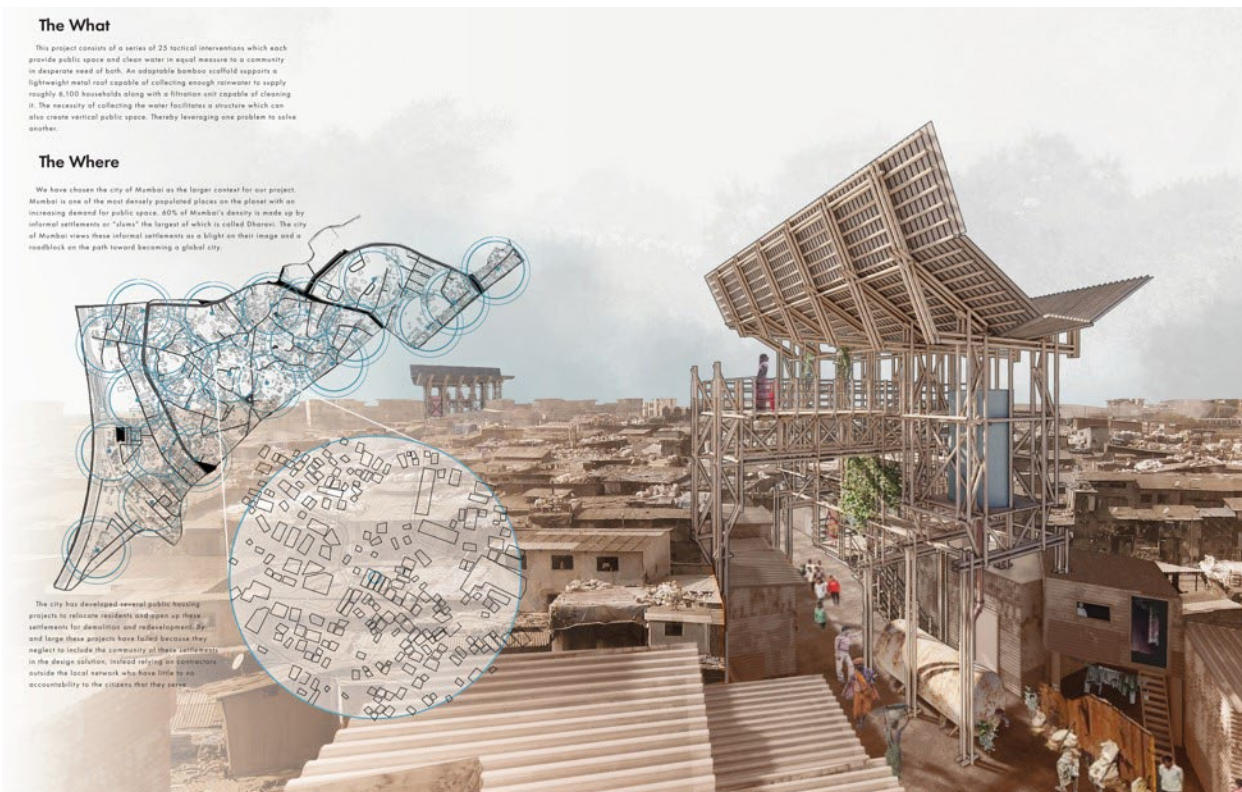

Figure 7: #SOCIALGATHERINGS Bamboo scaffolding in Dharavi retrofit to the informal city as it evolves. Source: (Oklahoma State University Urban Studio student work 2020)

The approach must be multidimensional and dynamic; we must see public spaces within the context of urban development, and analyze their significance from the perspective of officials, makers, and users of the

urban space, to see the phenomenon as a dynamic multiplicity (Madanipour 2006). Thus, these student proposals examine the changing context of cities, the role of urban design in this process of change, and the political, economic, and cultural roles it plays: *the place-making frameworks* (Carmona 2021). Many of the qualities identified by theorists and practitioners as being desirable for successful urban places or 'good' urban forms can be attributed to mainstream place-making traditions. Students generated proposals that addressed these place-making issues of value and inclusivity.

The framework of weaving was employed in *Intervention* (Figure 6). The creation of a woven fabric defines a space. Interactive Urban Fabric is intended to provide people with urban furniture that harnesses the abundance of plastic bags and upcycles them into a woven seating environment. The proposal turns attention towards the relationship between humans and the built environment. The seating exhibition invites those onto the urban rug to understand and interact with the recycled textile materials. Similarly, *Socialgatherings* (Figure 7) tells the story of frameworks in Dharavi, a bustling informal neighborhood in Mumbai where an estimated one million people live in less than one square mile. Public space is a commodity that is seldom found. An urban intervention, bamboo scaffolding, was implemented to make flexible cityscapes public spaces. The modules retrofit to the informal city as it evolves. The social infrastructure can provide attainable and culturally sensitive open space for play, community engagement, and safety.

In *Psychological* (Figure 6), the dialogue between virtual and real was explored. The emergence of technology allows us to exist in physical and virtual spaces simultaneously. Perhaps, physical interactions are no longer necessary when an immersive dialogue becomes normal. Public space has morphed from plazas and benches into electrodes and pixels. The perfect social interaction can now occur in the palm of your hand, from the comfort of wherever you need to be. The digital transformation overcomes physical constraints. *What does it mean for the future of public space? Will public spaces become irrelevant to the public?*

CONCLUSION

Urban design has been criticized for its obsession with finished products, which marginalizes its understanding as a long-term process intertwined with social and political mechanisms (Inam 2002). As an example of lacking storytelling process, the postwar planning policy and slum clearance without consultation with communities have resulted in disastrous results because there has been no coessential narrative among the players. The distortions might undermine any potential consensus (urbanism as narratives), however, if all levels of interaction are closed to rational discourse, no progress can be made. Urban interventions in public spaces are rarely analyzed to compare their outcomes with the processes by which they are delivered. It is rare for an urban design project to be reviewed after it has been completed, and there is seldom a systematic look at the entire process of creating or re-creating a place after its completion. It is only through emphasizing the process that we can make substantial strides in meaningful place making.

Through stories and storytelling, we can inform the design of places in various ways: what are the proposals telling us about the future of our society? We can engage with place stories by curating the narrative landscape of a city. In an ideal cycle, stories of place, built form, and the emerging form of a settlement can interact (Childs 2008). A physical and aesthetic vision can include independent stories that advance a phenomenon rooted in both spaces and places, while a political economic perspective advances urban design itself. Similarly, physical form influences a space's socioeconomic potential in the same way that socioeconomic context informs design decisions. As Biddulph (2012) argued, urban designers aren't just applied social scientists. They should temper their tendency to normative thinking with an awareness that the context in which they work is interpretative and highly political. This conundrum relates to how an analysis of urban design can be reconciled by integrating social science and design perspectives. This will enable us to look at the world from a different perspective, seeing the answer as a process-focused approach.

There is no single set of rules that can capture the process of urban design, nor can there be a step-by-step guide that describes it. Urban design studios and students are faced with multiple challenges that involve inductive and deductive research into a problem, as well as the specifics of location and time. However, it is possible to examine the complex interactions between various processes and elements in a place and find generic clues as to why some places succeed while others fail. As she famously asked "What kind of problem is a city?" in 1961, Jane Jacobs posed the ultimate question. The types of key issues of urban design integrated into these projects varies. However, they all emphasize the multidimensional and multilayered nature of urban design. Rather than simply focusing on the physical appearance of development, the studio sees urban design as an integrated and continuous process of shaping places through storytelling.

ACKNOWLEDGEMENTS

The urban studio was co taught with Nathan Richardson and Jared Macken. The project narratives are mainly written by Seung Ra and contributed by Jared Macken (super-drawing narrative for exhibition) and Nathan Richardson (organizing exhibition and contributed in project narrative).

REFERENCES

Biddulph, M. 2012. "The Problem with Thinking About or For Urban Design." *Journal of Urban Design* 17, no.1: 1–20.

- Bosselman, P. 2008. *Urban Transformations: Understanding City Design and Form*. Washington, Covelo, London: Island Press.
- Boyer, M.C. 1996. *The City of Collective Memory*. Cambridge, MA: MIT Press.
- Campbell, J. 2014. *The Hero's Journey: Collected Works of Joseph Campbell*. Novato, CA: New World Library.
- Carmona, M. 2021. *Public Places, Urban Spaces: The Dimensions of Urban Design*. New York and London: Routledge.
- Childs, M. 2008. "Storytelling and urban design." *Journal of Urbanism*, no.1:2: 173-186.
- Gehl, J. 2010. *Cities for People*. Washington, DC: Island Press.
- Hayden, D. 1995. *The Power of Place*. Cambridge, MA: MIT Press.
- Inam, A. 2002. "Meaningful Urban Design: Teleological/Catalytic/Relevant." *Journal of Urban Design* 7, no.1: 35–58.
- Jacobs, A. 1985. *Looking at Cities*. Cambridge, MA: Harvard University Press.
- Jacobs, Jane. 1961. *The Death and Life of Great American Cities*. New York, NY: Random House.
- Kashef, M. 2008. "Architects and Planners' Approaches to Urban Form and Design in the Toronto Region: A Comparative Analysis." *Geoforum* 39, no.1: 414– 437.
- Knox, P. 2011. *Cities and Design*. London: Routledge.
- Madanipour, A. 1997. "Ambiguities of Urban Design." *The Town Planning Review* 68, no. 3: 363–83.
- Madanipour, A. 2006. "Roles and Challenges of Urban Design," *Journal of Urban Design* 11, no. 2: 173-193.
- Mumford, L. 1961. *The City in History: Its origins, Its transformations, and Its prospects*. New York: Harcourt, Brace and World.
- Olds, K. 2001. *Globalization and Urban Change*. Oxford: Oxford University Press.
- Salama, A.M., O'Reily, W., and Noschis, K.2002. *Architectural Education Today*. Lausanne: Comportements.
- Sassen, S. 2002. *Global Networks, Linked Cities*. London: Routledge.
- United Nations. 2001. "Cities in a Globalizing World: Global Report on Human Settlements." London: United Nations Centre for Human Settlements, Earthscan. <https://unhabitat.org/cities-in-a-globalizing-world-global-report-on-human-settlements-2001>

SOLEIL: Combining Housing Affordability and Sustainability to Add a New Standard for Neighborhood Compatibility

Michael Garrison¹, Gabrielle Patracolla¹, Noah Heerdin¹, Julia Manion¹, Madison Bryan¹

¹School of Architecture, The University of Texas at Austin

ABSTRACT: While economic and social policy models have failed to move the public demand to build more affordable housing in Austin, Texas, urgent environmental, sustainability and climate change realities may finally demonstrate how it is in everyone's self-interest to build more affordable urban Zero Net Energy (ZNE) housing now. Residents of Austin's older urban neighborhoods have been reluctant to accept zoning changes that would allow large numbers of urban middle density housing units, fearing the higher densities would not be compatible with the character of existing single-family detached (SFD) scaled neighborhoods. SOLEIL Homes presents a ZNE middle density housing model that allows existing neighborhood residents to visualize a modest middle density increase (32-units per acre), ZNE energy efficiency, and affordability to maintain diversity and design compatibility with the character of SFD scaled urban neighborhoods. The SOLEIL factory-built modular housing model lowers construction costs by 20% and the middle density allows more housing units to share raw land costs. Through its green building design, evaporative cooling rain gardens and enhanced energy conservation features, SOLEIL achieves a low Energy Use Intensity (EUI) ZNE Ready rate of 7.9 kBtu/ft²-year, and with the addition of a 5.14 KW per unit PV system, the SOLEIL units achieve a Zero Net Energy home classification. SOLEIL units achieve neighborhood design compatibility and energy efficiency at a sales price affordable to residents with an income of less than 80% of Austin's annual median family income (MFI). By extending ZNE sustainable housing to include the affordable and moderate workforce housing markets, enough urban units could be built by the end of this decade to meet Austin's affordable housing demand and help forge a pathway to reduce the city's carbon footprint CO₂e/year by 50% by 2030.

KEYWORDS: Climate Change Mitigation, Housing Affordability, Middle Density, ZNE

INTRODUCTION

The United Nations Paris climate agreement set a target of limiting the global average temperature increase to less than 3.6° Fahrenheit (2° Celsius) above pre-industrial levels by 2050 to avoid the worst impacts of climate change.¹ In response, the City of Austin, Texas (COA) revised its Climate Protection Plan with a new Climate Equity Plan that sets a target to become a net-zero community wide CO₂e/year emissions by 2040.² In Austin the electricity and natural gas used to power residential buildings and the transportation fuels used to power vehicles traveling between home and work account for 83% of Austin's Community Greenhouse Gas Emissions (10.8 million metric tons of CO₂e/year in 2022). Austin's Climate Equity Plan requires a 50% reduction in the city's community greenhouse gas emissions by the end of this decade. To achieve a change of this magnitude will require significant revision to COA policies on how and where housing is built and for all its existing housing stock to become 25% more energy efficient in less than ten years. The next step is to add 100,000 new ZNE housing units within the next seven years and for 80% of these housing units to be built within Austin's urban neighborhoods. Since two-thirds of the city's housing market is for moderate and affordable units, it is imperative that affordable middle density ZNE housing models compatible with the scale of Austin's urban neighborhoods be constructed in large numbers to achieve Austin's climate change mitigation goals.

1.0 SOLEIL MIDDLE DENSITY HOUSING REDUCES RAW LAND COSTS

Since middle density zoning provides for a greater number of housing units to share land costs, it directly addresses high urban land costs as one of the primary drivers of rising housing costs. Additionally, because middle density only adds a modest increase of energy and water efficient housing units, utility infrastructure demands can be met without drastically increasing the utility infrastructure capacity of existing urban single-family detached scaled neighborhoods. A sample 19,500 ft² site in Central East Austin's Blackland Neighborhood, comprised of three adjoining lots zoned single family (SF-3) is used as a case study analysis to develop the SOLEIL Homes model.³ Located in a historically black urban neighborhood now experiencing gentrification, the site is in a half-block transition zone bordering neighborhood streets lined with single-family detached houses to the south and denser four-story Vertical Mixed Use zoned housing along a core transit corridor to the north. A middle density overlay zone district is proposed for the half-block site as a transition housing density zone. The overlay zone would allow housing densities up to 32-dwelling units per acre, a maximum height of 34-feet, a maximum building area to site area ratio of one to one, a maximum building coverage area to site area ratio of 50% and a maximum impervious surface site coverage of 70%. When the site

impervious coverage ratio exceeds the current SF-3 allowable of 45% ⁴ a green water infrastructure storm water system is required to assure that storm water flow will not exceed the flow currently existing from the site.



Figure 1: SOLEIL 14-unit middle density housing model proposed for a ½ block transition zone in between denser Vertical Mixed Use zoning housing along core transit corridors and SFD houses in the East Austin Blackland urban neighborhood. (Garrison 2021)

To address Blackland Neighborhood concerns about the design compatibility building scale of middle density in their single family detached (SFD) scaled neighborhood, SOLEIL provided a physical model that allowed residents to visualize a middle density scale design. The SOLEIL model design limits building heights along neighborhood streets to two-stories in height and breaks up the massing of the project using deep balconies and front porches that sit back 15 feet from the street. The elevated front lawns and xeriscape landscaping provide privacy for street-facing row homes without building privacy fencing. Rather than attempt a fake historical reproduction of the Swiss farmhouses or the bungalow style of Blackland’s earlier times, the SOLEIL homes achieve design compatibility by using domestic gable roof forms similar in size to the older houses in the neighborhood, and with their 14-foot-wide front porches they are aesthetically compatible with the scale and character of the existing Blackland neighborhood. Based on the physical model, the neighborhood association found the proposed middle density to be in keeping with the character of their neighborhood.

The middle density overlay zoning allowed 14 SOLEIL housing units, averaging 1,200 ft² in size, to be built on the 19,500 ft² site zoned for three SF-3 lots. The SOLEIL Housing model was then used as an economic, sustainability and design compatibility comparison to the three two-story SFD and the two two-story Accessory Dwelling Units that were built on the site under SF-3 zoning in 2022-2023.

The Travis County Central Tax Appraisal District in 2020 ⁵ assessed the property value for the three lots in Blackland at \$425,000 for each lot. When raw land prices are this expensive, it pushes the sales price of a home built on the site up to the luxury class level. A developer typically would like to keep the raw land costs below 20-25% ⁶ of the home sales price. For example, one SFD house built on the site in 2022 is a 3-bedroom, 2-bath, 2,245-square-foot home with a market sales value of \$1,271,000. ⁷ The raw land cost represents 33% of the home sales price. The \$1 million+ house is too expensive for existing neighborhood residents and twice the square footage of typical Blackland houses. Neighbors labeled the house a “McMansion” and opposed its development. As an economic alternative, the raw land cost for the 14 SOLEIL homes is \$91,400 per unit. This allows the developer to build smaller 1,200 ft² housing units with an affordable ⁸ market sales price of \$360,000 each. Their raw land costs are 25% of the home sales price. More units sharing the land lowers the land cost per unit.

2.0 SOLEIL’S PREFABRICATED MODULAR HOUSING LOWERS HOME CONSTRUCTION COSTS

Local building code compliant prefabrication is a process in which a modular home is constructed off-site, under controlled indoor plant conditions and then shipped to a site where modules are assembled to form a multifamily housing project. Modular construction is also a type of building construction in which a selected unit or module, such as a rectangle or other subcomponent, is used repeatedly in an assembly line construction process. Factory-built modular construction can reduce costs by approximately 20% through benefits that include bulk purchasing of building

materials, better controlled indoor work conditions, more experienced factory workmanship, assembly line efficiency, and reduced construction times.

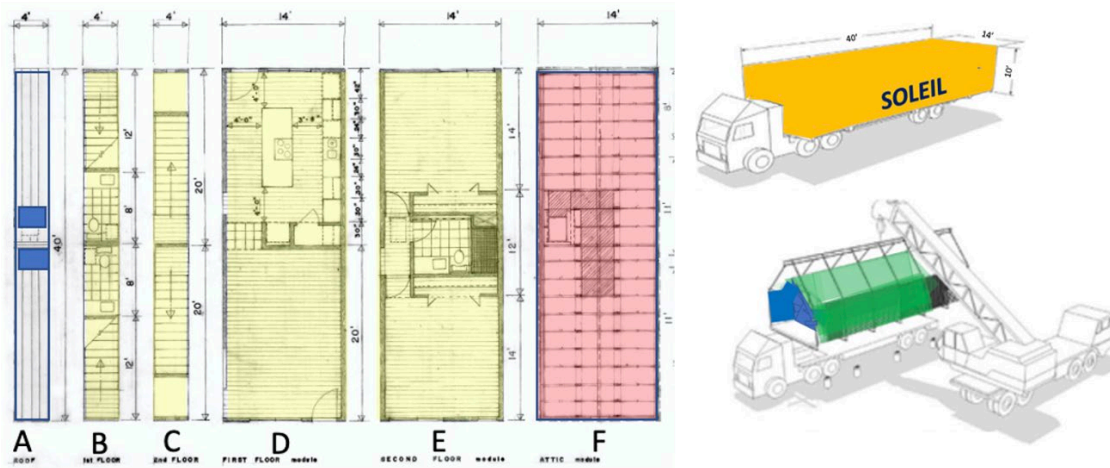

Figure 2: SOLEIL row houses prefabricated factory-built housing modules shipped to the site and stacked together. (Garrison 2021)



Figure 3: SOLEIL 1st floor and 2nd floor modules stacked and connected to stairway module on site to form 1-bedroom, 2-bedroom or 3-bedroom row house floor plans.(Garrison 2021)

The modules are constructed in a factory, trucked to the site where they are unloaded using a crane and then placed on a concrete perimeter beam foundation and stacked together to form row houses. The modules arrive at the site with fully finished interiors, MEP systems, windows, doors, cabinets, kitchens, bathrooms, and interior finishes. The row houses are put together by connecting the stacked modules to stairway modules, and the entire project is assembled on site in just a few days. The SOLEIL module costs were based on 2022 prices quoted by Oak Creek Modular Homes in Fort Worth, Texas.⁹ While the SOLEIL design is different than the standard Oak Creek modular home design, the company will build custom modules when the number is significant enough to justify the set-up costs. SOLEIL meets this requirement building 28-14'W x 40'L x 11'H home modules, 14- 4'W x 40'L x 11'H stairway modules and 10- 14'W x 40'L x 8'H @45° sloped roof modules. An Oak Creek standard modular home similar in size to a SOLEIL row house costs \$126,562 (July 2022 dollars). Because the SOLEIL project includes more expensive materials, finish upgrades, electrical and appliance upgrades, the SOLEIL units are slightly more expensive at \$134,000 per modular row house unit delivered and assembled on site. On-site construction costs another \$50,000 per unit for site prep and finish out work including site grading, perimeter concrete pier foundations, under floor bladder cisterns, exterior rainscreen FRP siding, galvalume roofing, rain garden courtyards, pervious paving, living fencing, a community garden roof deck located above the SOLEIL flats, a roof deck shading pergola to support PV panels, utility infrastructure systems, exterior lighting, and xeriscape landscaping. Quality materials and finishes are used to assure SOLEIL will meet highest quality standard construction (moderate income market) at an “all in” base cost of \$184,000 (\$154/ft²).

3.0 SOLEIL’S ENERGY-EFFICIENT DESIGN FEATURES LOWER HOUSEHOLD ENERGY OPERATIONAL USE COSTS

Enhanced energy conservation features are incorporated into the SOLEIL Homes design to meet the requirements of a U.S. Department of Energy (DOE) ZNE READY home certification. These features include: 1) a microclimatic site design featuring evaporate cooling, shading and solar induced stack ventilation; 2) specifying Austin Energy Green

Building (AEGB) program multi-family five-star green building measures (10) which is like the DOE ZNE Ready Home (ZERH) rating ¹¹; and 3) incorporating Passive House super insulation energy conservation standards. ¹²



Figure 5: East-West and North-South Central Courtyards and GSI rain gardens. (Garrison 2021)

Microclimate is defined as the regional climate modified by local site conditions. The proximity of SOLEIL buildings provides for reciprocal building shading and creates courtyards. By placing the housing units at the perimeter of the site around a courtyard and by locating the PV panels as a shading awning above the roof of the SOLEIL flats, the PV panels are out of the solar shadow of surrounding buildings and trees throughout the year. Microclimate courtyards are used as both a green stormwater infrastructure (GSI) control system and for the climate modifying aspects of adjacent vegetation. Plant transpiration creates evaporative cooling in the courtyards. Plants shade the ground and leaves transpire moisture, which cools the air when the moisture evaporates. The daily maximum surface temperature at a given location is dependent on the amount of **radiant energy** converted to sensible heat. Rainwater harvesting available for irrigating the rain garden plants and their subsequent moisture evaporation increases latent heating by adding water vapor to the **atmosphere**. As a result, relatively little energy remains to heat the air, and the sensible heating of the air near the ground is minimized (PY Tan, 2018). Daily maximum temperatures are not as high in the evaporative cooling microclimates of the rain garden courtyards reducing localized temperatures by as much as 8-15°F and reducing adjacent building thermal loads by approximately 15%. ¹³ When temperatures soar to triple digits, the accompanying relative humidity drops down to the 30% levels and that is when evaporative cooling works best. Rainwater harvested from SOLEIL's galvalume roofs during spring months is stored in bladder cisterns located in the underfloor crawl spaces of the row houses. The 25,000-gallon total capacity of the combined cisterns will meet the irrigation needs of the rain gardens and xeriscape landscaping during summer droughts of up to 50 continuous days without any measurable rainfall. The rainwater cisterns along with low water use plumbing fixtures and appliances reduce SOLEIL's water use to less than 30 gallons per capita day. ¹⁴

Austin, Texas is classified as a sub-humid climate located in zone 2A defined by the International Energy Conservation Code (IECC). The residential annual energy use benchmark for an average Austin home built to 2015 IECC code standards is 13,801 kWh/year, ¹⁵ which equates to an Energy Use intensity (EUI) of 23.9 kBtu/ft²-year, (13,801 kWh x 3.412 Btu/kWh /1,865 ft², the average home size in Austin). Newer homes in Austin built since the 2015 IECC code tend to average 12,000 kWh/year or within a range of 13-20% more energy efficient than the 2015 IECC code as builders preparing for the enforcement of the 2021 IECC code, now tend to include more Austin Energy Green Building (AEGB) 1-star features in their standard construction practice. ¹⁶ These features include, minimum R-13 exterior wall insulation, R-30 ceiling insulation, window U-value less than .40 and a solar heat gain coefficient (SHGC) of less than .25, along with a minimum HVAC Seasonal Energy Efficiency Rating (SEER) of 14 or above. A 2023 AEGB 1-star+ certified home has an average annual electrical use of approximately 9,600 kWh/year which equates to an EUI of 17.56 kBtu/ft²-year. To achieve a 5-star AEGB rating Austin home builders must add additional green building measures and energy conservation features that reduce the home's annual electrical use by a minimum of 55% to 5,400 kWh/year which equates to an EUI of 9.88 kBtu/ft²-year. Reducing a home's annual electrical use by 55% below the benchmark code home is the minimum rating to qualify for a DOE ZERH certification. ¹⁷ The AEGB 5-star and the ZERH features include, R-19 wall insulation, bridging wall board insulation, R-49 ceiling insulation, window U-value less than .25 and a SHGC of .20 or less, improved hot water heating efficiency and a minimum HVAC SEER of 15 or above as well as energy-star rated lighting and appliances.

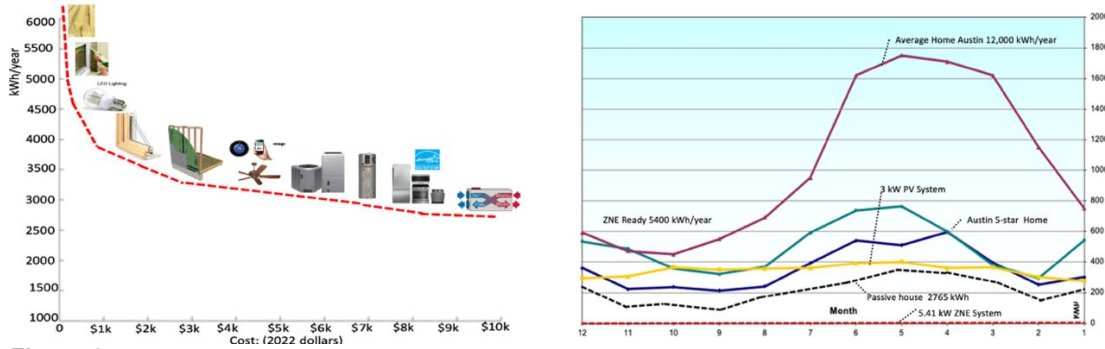

Figure 6: Reducing SOLEIL's annual electrical use to achieve a DOE ZERH certification. (Garrison 2021)

Before SOLEIL Homes are sized for a roof-top solar photovoltaic (PV) power system to become ZNE homes, they should consider even more energy conservation measures to lower the housing project per unit power load to reduce the number of required PV panels to make the power system more economical.¹⁸ Therefore, SOLEIL adopted Passive House super insulation standards to reduce total annual electrical use by 77% below the 2015 IECC code Austin benchmark home. The SOLEIL Homes built to the Passive House standards reduced the annual electrical load to 2,765 kWh/year which is an EUI of 7.9 kBtu/ft²-year. (For a 2-bedroom, 1- and ½-bath, 1,200 ft² SOLEIL attached row house unit). PHI and PHIUS certified measures include, R-23 wall insulation, R-57 ceiling insulation, window U-value .14-.17 or less and a SHGC of .2 or less, low e-3 heat mirror windows, responsive exterior window shading, heat-pump water heating, a minimum HVAC SEER of 16 or more, LEED lighting, high energy-star rated fixtures and appliances, well-sealed exterior building envelope with .22 air changes per hour along with an Energy Recovery Ventilator (ERV) to assure adequate amounts of interior fresh air and a smart energy management system thermostat. Austin low-rise residential and multifamily building permits require IECC Manual J and S HVAC sizing calculations.¹⁹ When these calculations are applied to a SOLEIL row house (Passive House standards), the peak HVAC load is calculated at 1,800 Btu/hour (or 1 ton of HVAC per 800 ft² of floor area). Each SOLEIL housing unit has its own 16- SEER air source heat pump heating and cooling system and heat pump domestic hot water system. During hot summer conditions, the air source heat pump will supply cool forced air to dehumidify and cool air to maintain interior comfort at 75°F. The cooling load and the heating load were calculated using peak design high and low outdoor temperatures of a 110°F outdoor summer high temperature and a 10°F outdoor winter low temperature. The simulation estimated a peak thermal load of 17,899 Btu/hour summer and 10,800 Btu/hour winter. Given the summer dominant cooling load, a 1.5-ton, 16-SEER air source heat pump for cooling and heating is specified for each SOLEIL housing unit.

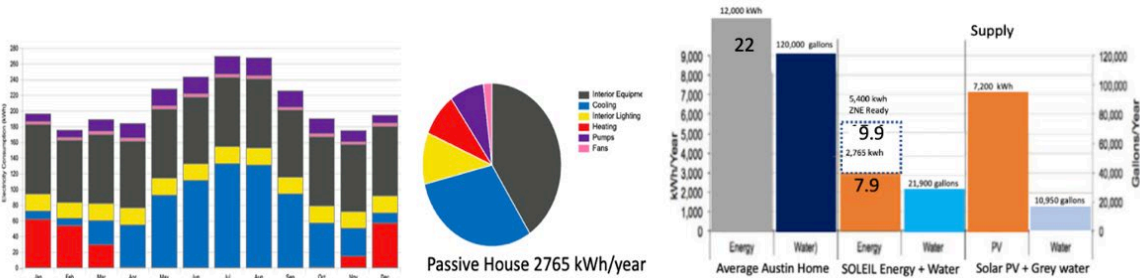

Figure 7: SOLEIL Passive House EUI of 7.9 kBtu/ft²-year and a 1.5-ton air-source heat pump HVAC per housing unit. (Garrison 2021)

4.0 SOLEIL ZERO NET ENERGY PV SOLAR POWER SYSTEMS

To achieve a zero-net-energy operational power performance, the SOLEIL housing units' photovoltaic panels were added to the project. SunWatts Mono Sol XL solar PV Monocrystalline C-Si panels with 20% efficiency, 450 watts, 23.5 ft²/panel) were added in two locations: On the Poquito St. row house south-facing roofs, 64-PV panels are fixed mounted at a tilt angle of 45 degrees and at an azimuth angle of 190-degrees. Sunwatts inverter efficiency is 98% and across the courtyard an additional 80-PV Sunwatts panels are mounted on the roof pergola above the SOLEIL flats. They are fixed mounted at a tilt angle of 3-degrees and a 190-degree azimuth angle. In combination the panels provide a 72kW PV power system.²⁰

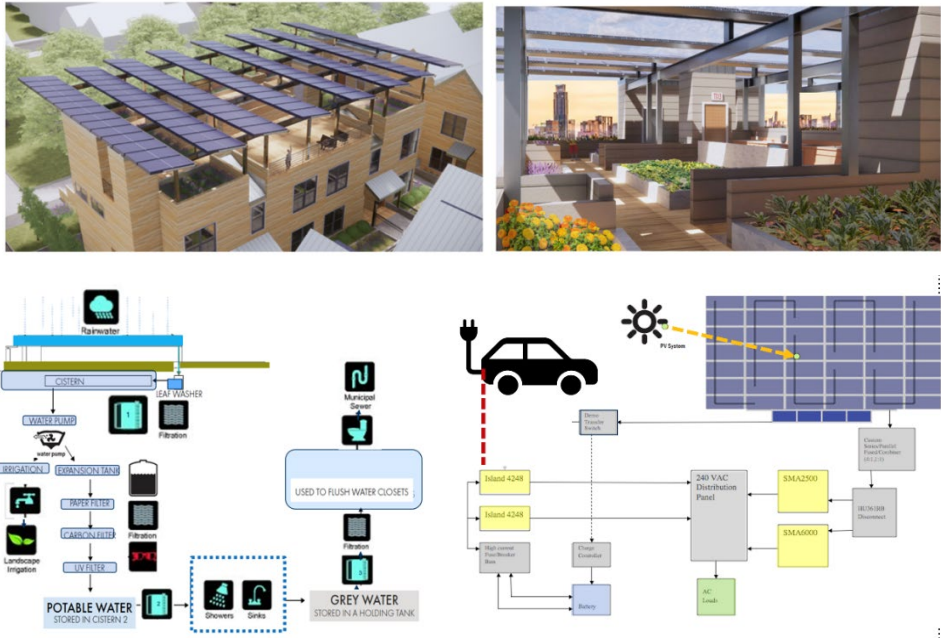

Figure 7: SOLEIL 72 kW (5.14kW per unit) AE Community Solar PV power system. (Garrison 2021)

The SOLEIL (Passive House Standards) is estimated to require only 61PV panels to become a ZNE housing project. Because the SOLEIL Community Solar design provides 160 PV panels, they will provide more electricity than the housing project needs during a typical summer day. The excess power is sent back into the electrical grid where it can be used by other customers. At night the housing units pull power from the electrical grid. If the housing units use less energy than they produce, under a Community Solar lease agreement Austin Energy would pay the SOLEIL residents at a rate of \$0.03 per kWh for their excess power. On an annual basis if the housing project supplies more power to the electrical grid than it uses it is considered a zero net energy project.²¹ The estimated cost of SOLEIL’s PV panels is \$0.81/Watt-dc x 72 kW PV system equals \$58,320 and after the maximum AE PV rebate of \$35,000 equals \$23,320 cost plus installation and inverter costs to the owner. This up-front solar PV cost is too expensive for affordable home buyers, but Austin Energy offers a Community Solar program for affordable multifamily housing without any out-of-pocket expenses to the residents. SOLEIL is planned to use the Community Solar Program option and therefore no costs for the solar system are included in the ZNE housing construction budget.

5.0 SOLEIL ZNE HOMES AFFORDABILITY

An Austin housing market survey identified two first-home buyer groups as the primary market for new middle density homes in urban East Austin²² including, 1) younger tech-savvy environmentally conscious singles and couples looking for housing close to downtown and its urban amenities and, 2) younger black home buyers who would like to live in an older historically black East Austin neighborhood. While the market survey found location was most important to both homebuyer groups, equally important was value. These first-time homebuyers are willing to pay a little more for energy and water-efficient housing. How much more? Additional costs for green building features should not exceed the amount of savings generated from lower utility bills within a timeframe ranging from 5-10 years. For each SOLEIL unit AEGB 1-star green building home features add approximately \$1,420 (\$1.18/ft²) but lowers annual electrical use by almost 20% with a 2.8-LCC (Life Cycle Cost) year payback. The AEGB 5-star or ZERH certified features add an additional \$3,744 (\$3.12/ft²) but reduce the annual electrical load by 55% with a 4.2-LCC year payback. Passive house standards add \$6,436 (\$5.36/ft²) but reduce the thermal load by an estimated 77% with a 6.8-LCC year payback. The total green building and energy conservation upgrades add \$11,600 to the sales price of a SOLEIL housing unit but pay for themselves in energy savings in less than ten years. The sales price of a SOLEIL housing unit is equal to, the raw land costs (\$91,400) + construction costs (\$184,000) + enhanced energy efficiency upgrade costs (\$11,600) + soft costs including, marketing, sales, overhead, fees, etc. (\$15,000), COA zoning and permit fees exempted for affordable housing + developer’s fee and investor equity return (\$50,000 per unit) equals a sales price of \$360,000 per unit (\$300/ft²). At a sales price of \$360k every SOLEIL unit qualifies as COA affordable housing for homebuyers who make less than 80% of Austin’s annual MFI. Although the SOLEIL units would be initially affordable, if only a few projects like SOLEIL are built, investors will quickly buy the units and then flip the units (reselling them) to other buyers at much higher prices. If the demand for middle density urban housing remains high and the inventory remains low, achieving affordable urban housing in Austin will remain a challenge. However, if large numbers of affordable middle density ZNE housing units were built in every Austin urban neighborhood, using ½ block overlay middle density housing transition zoning districts, market supply could rapidly increase to meet market demand, and affordable home prices would likely stabilize. When affordable housing units are developed in partnership with a non-profit neighborhood

community design corporation (CDC) using land trusts, lower income residents can receive assistance in reducing the financial impacts of rising property taxes and HOA assessments.

6.0 LINKING AFFORDABILITY AND SUSTAINABILITY

Because two-thirds of Austin's housing market is for moderate income buyers (below 135% of Austin annual MFI) and lower income buyers (below 80% of Austin annual MFI), and if Austin residents can reach a consensus on enacting housing transition zoning in Austin's urban neighborhoods to allow large numbers of ZNE middle density housing to be built to meet market demands, then significant climate change mitigation can be achieved to meet Austin's goal of becoming a net-zero greenhouse gas emissions community by 2040.

The Austin Energy fuel mix used to generate electrical power impacts the conversion rate of kWh used to measure the carbon fuel emissions emitted to generate electrical power. In 2021 AE's electrical power generation fuel mix (coal, hydro, gas, wind, solar, nuclear) was 72% from non-carbon fuels and by 2030 it is scheduled to be 93% non-carbon. In 2021 the AE fuel mix customer carbon rate was .739 pounds CO₂e/kWh. By applying the AE fuel mix rate to an average Austin Home's annual electrical use (12,000 kWh/year X .739 metric tons of CO₂e/kWh) divided by 2,204.6 lbs./metric ton equals 4.6 metric tons CO₂e/year. A SOLEIL row house (passive house standards) contributes only .92 metric tons CO₂e/year and a SOLEIL ZNE row house with zero-net operational energy consumption use would eliminate 4.6 metric tons of CO₂e/year. Embodied energy (EEH) use should be added to the household operational use along with household waste and household transportation emissions too define the household carbon footprint. The embodied material carbon emissions (MCE) are the (upstream) carbon emissions contribution for mining, manufacturing, transportation, and construction of the building materials used to build a home. By applying the volume and weight of each material and its embodied energy content provided by a Carbon Calculator website,²³ the initial embodied energy of each SOLEIL housing unit was estimated at 17.9 metric tons CO₂e, which is a 40% reduction below the average U.S. townhouse embodied energy contribution (E.I.A.) estimated at 29.9 metric tons of CO₂e. SOLEIL Homes are built using an extensive amount of wood-based building materials, recycled and reclaimed materials and low embodied energy building materials and finishes. The estimated SOLEIL row house 17.9 metric tons CO₂e embodied energy emissions equate to a rate of 31.8 lbs. of CO₂e/ft², which is well below AE's recommended maximum embodied carbon emissions rate for buildings of 100 lbs. of CO₂e/ft². The EEH emissions spread over a 30-year LCC time frame and ongoing maintenance and material replacement embodied energy costs were estimated to add approximately 1.2 metric tons CO₂e/year.

Waste management in Austin represents 3% (327,000 metric tons) of Austin's community carbon dioxide equivalent footprint annually. The City of Austin Resource Recovery Plan is committed to a zero-waste goal to reduce the amount of trash sent to landfills by 90% by the year 2040. The diversion rate at the end of fiscal year 2021 was 41.96%. This diversion through recycling and reductions in per capita and construction solid waste levels reduced Austin's waste management carbon footprint by 137,209 metric tons of CO₂e/year.

Where Austin residents live and how they get around has an important impact on carbon emissions. In Austin, per capita vehicle miles traveled (VMT) per day has been steadily increasing for decades, mirroring suburban population growth. In 2021, Austin's average per capita transportation related CO₂e emissions was 4.14 metric tons CO₂e/year. Seventy-four percent of Austin's transportation-related emissions came from single-occupancy private cars and trucks mostly commuting to and from work. Suburban residents living in lower-density sprawling developments have a greater dependency on carbon-intensive automobiles to access their daily needs in contrast to their Austin's urban neighbors. The SOLEIL Homes project is in an older urban neighborhood just 150 feet from an urban transit stop and within walking distance to neighborhood retail, restaurants, and other urban amenities. The urban location and the SOLEIL Homes shared electric zip-car program are projected to reduce SOLEIL Homes per capita transportation emissions to 2.07 metric tons CO₂e/year. If 100,000 new SOLEIL-like ZNE units (averaging 2 occupants per unit) were built within Austin's urban neighborhoods by 2030 (when at that time all new buildings must be ZNE), Austin could reduce transportation emissions by 414,000 metric tons CO₂e/year. And if all of Austin's 1,000,000 urban residents adopted a similar transportation policy the savings could reach 2,070,000 metric tons CO₂e/year.

Adding 100,000 new ZNE affordable housing units by 2030 would not only meet Austin's affordable housing demand, but it would also save 580,000 metric tons of carbon emissions per year over Austin's current average benchmark home. This would be in addition to the savings achieved by reducing all of Austin's existing 467,291 residential units and 50,451 commercial buildings energy use annually by 25%, an estimated savings of (1,250,000) + ZNE homes (580,000) equals 1,830,000 metric tons CO₂e/year. And by adding waste management (137,209) + transportation (2,070,000) equals a total reduction in carbon dioxide equivalent emissions of 4,037,209 metric tons of CO₂e/year. To achieve Austin's goal of reducing its 2021 community carbon footprint of 10.8 million metric tons of CO₂e/year by 50% by 2030, Austin will need to reduce its industrial, refrigerants and natural gas carbon footprint by 25% (650,000 metric tons CO₂e/year). Austin must then add carbon sequestration programs that will sequester carbon emissions of 712,791 metric tons CO₂e/year. Austin's goal of being a net-zero carbon emissions community by 2040 is optimistic but by linking affordability, sustainability, and neighborhood compatibility together in new housing policies on how and where housing is built demonstrates how neighborhood compatible, affordable ZNE middle density housing is the most scalable pathway to reduce Austin's carbon footprint by 50% by 2030.

REFERENCES

PY Tan, Wong N H, Tan CL, Jusuf SK, Change MF, Chaim ZQ. A method to partition the relative effects of evaporative cooling and shading on air temperature within vegetation canopy, Journal of Urban Ecology, 2018. 4–11

ENDNOTES

- ¹UNFCCC The Paris Climate Agreement, Articles 1-29, 2015., accessed November 15, 2022, https://unfccc.int/files/meetings/paris_nov_2015/application/pdf/paris_agreement_english.pdf
- ²austintexas.gov, Austin Climate Equity Plan, 2021, accessed October 3, 2022, <https://www.austintexas.gov/page/austin-climate-equity-plan>
- ³UTSOA University of Texas at Austin, U.S. Department of Energy, 2021 Solar Decathlon Challenge Competition, Final Report to the National Renewable Energy Lab, 2022, https://issuu.com/piper23/docs/soleil_draft_v2-doc-nov_22
- ⁴ austintexas.gov, Green Storm Water Infrastructure (GSI), accessed August, 28, 2022, <https://www.austintexas.gov/edims/document.cfm?id=390764>
- ⁵Travis Central District 2020 Tax Appraisals: <https://traviscad.org/propertysearch>, accessed May 28, 2022
- ⁶ NAHB.org, Cost of constructing a home, accessed January 02, 2020, <https://www.nahb.org/-/media/8F04D7F6EAA34DBF8867D7C3385D2977.ashx>
- ⁷ Zillow.com, 2004 East 22nd Street, Austin, Texas, accessed November 15, 2022, https://www.zillow.com/homedetails/2004-E-22nd-St-Austin-TX-78722/29390911_zpid/
- ⁸ austintexas.gov, 2021 Area Median Family Income for Travis County, Texas, accessed, April 3, 2021, https://www.austintexas.gov/sites/default/files/files/Housing_%26_Planning/Affordable%20Housing/FINAL%20MF1%20Chart%20Effective%206-01-2021.pdf
- ⁹ oakcreekhomes.com, Gold Spur 5616, accessed November 14, 2022, <https://oakcreekhomes.com/floorplans/gold-spur-5616/>
- ¹⁰ austinenergy.com, Austin Energy Green Building Program :2016 multifamily rating guidebook: https://austinenergy.com/wcm/connect/b7e92936-2182-4ba7-8efe-98b197f27e7c/AEGB_2016_MF_Rating_Guidebook.pdf?MOD=AJPERES&CVID=mfr8fvG&CVID=lvEy-MH
- ¹¹energy.gov, Zero Energy Ready Home Program, <https://www.energy.gov/eere/buildings/zero-energy-ready-home-program>
- ¹² passivehouse.org. Passive House certification criteria, https://passivehouseinternational.org/index.php?page_id=150
- ¹³ H J Krishna, The Texas Manual on Rainwater Harvesting third edition, Texas Water Development Board TWDB: Austin, Texas 2005.
- ¹⁴ austintexas.gov, Austin Water: Multi-Family Residential & Commercial Onsite Water Reuse. 2018
- ¹⁵ resnet.us, <https://www.resnet.us/articles/state-of-texas-adopts-energy-rating-index-option-to-energy-code/>
- ¹⁶ energy.gov, U.S. DOE: Zero Net Energy Ready requirements, accessed August 28, 2022 <https://www.energy.gov/eere/buildings/doe-zero-energy-ready-home-program-requirements> May 29, 2022
- ¹⁷ energy.gov, An Assessment of Energy Technologies and Research Opportunities: Chapter 5, Increasing efficiency of Buildings Systems and Technologies, EPA Energy Efficiency Program Best Practices, https://www.epa.gov/sites/default/files/2015-08/documents/napee_chap6.pdf, Accessed July 9, 2022
- ¹⁸ hersindex.com, Understanding the HERS Index Score, accessed November 15, 2022, <https://www.hersindex.com/know-your-homes-hers-index-score/hers-index-understanding-the-hers-score/>
- ¹⁹ epa.gov, U.S. Median Energy Use Intensity (EUI) by Property Type, Accessed July 13, 2022. <https://portfoliomanager.energystar.gov/pdf/reference/US%20National%20Median%20Table.pdf>
- ²⁰ sunwatts.com, <https://sunwatts.com/450-watt-phono-solar-mono-xl-m4-solar-panel/> <https://sunwatts.com/solar-calculator/>. Accessed February 8, 2022
- ²¹ austinenergy.com, Austin Community Solar Program: Multifamily shared solar, Accessed May 27, 2022 <https://austinenergy.com/ae/green-power/solar-solutions/for-your-multifamily/mf-shared-solar>.
- ²² austintexas.gov. Root Policy, City of Austin comprehensive Housing Market Analysis, https://www.austintexas.gov/sites/default/files/files/Housing/Austin%20HMA_final.pdftesla.com,
- ²³ 8billiontrees.com, Carbon Calculator for building materials, accessed, Feb 16, 2023 <https://8billiontrees.com/carbon-offsets-credits/carbon-footprint-of-building-materials>

Sustainable Development and Affordable Housing in Kingston, Jamaica: Integrating Research and Design

Phoebe Crisman¹

¹University of Virginia, Charlottesville, VA

ABSTRACT: Our shared future depends on creating healthy and equitable conditions for all life. The intersecting challenges of climate change, rapid urbanization, lack of sustainable urban development and affordable housing, and the growth of informal settlements are prevalent in Small Island Developing States. The UN-Habitat's *World Cities Report 2020* found that 59.6% of Jamaica's urban population live in 'slum' areas. The health and well-being of all citizens is severely compromised without integrated, resilient urban planning and infrastructure. Jamaica is particularly vulnerable to climate crises and environmental resilience strategies are needed to guide affordable housing design. While there is substantial knowledge about informal settlements and affordable housing elsewhere, the current realities in Kingston are distinct and in need of further research.

Participating in the U.S. State Department's Diplomacy Lab, our University of Virginia team partnered with the U.S. Embassy in Kingston and several Jamaican Government agencies to research and design plans for two Kingston communities. We examined relevant academic literature and international case studies, analyzed conditions in Kingston, and synthesized our findings on climate change resilience, land use planning, public infrastructure and utilities, colonial history and current vulnerabilities, cultural and spatial practices, design for safety, and housing policies and finances. We employed ethical, systems thinking methods that holistically integrated environmental, economic, and equity issues within housing policy and design. That research guided the design of sustainable, low-income housing for two distinct urban conditions: an existing informal settlement and a redevelopment district. Our findings show that both require community participation, equitable and sustainable design, collaborative and innovative financing, and institutional capacity-building to make positive change. With a transdisciplinary approach and strong communication pathways, the Government of Jamaica can create a home for all Jamaicans.

KEYWORDS: Sustainable Development, Affordable Housing, Urban Resilience, Rapid Urbanization

INTRODUCTION

As part of the U.S. Department of State's Diplomacy Lab, Professor Phoebe Crisman and University of Virginia undergraduate student researchers partnered with the U.S. Embassy in Kingston and several agencies within the Government of Jamaica to examine the intertwined challenges of sustainable development, lack of affordable housing, and the growth of informal settlements largely due to rapid urbanization. The *World Cities Report 2020* found that 59.6% of Jamaica's urban population live in 'slum' areas (UN-Habitat 2020). Embassy staff noted that "various efforts by successive governments have fallen short of meeting the growing demand for affordable housing among low-income and marginalized communities," which produce informal settlements that "have become breeding grounds for criminal activity and contributed to the incidence of violence and insecurity on the island" (US Department of State 2021). Accompanied by lack of integrated, resilient urban planning and infrastructure, the health and well-being of Jamaican citizens is severely compromised.

The research team examined relevant academic literature and international case studies, analyzed environmental, economic, and social conditions in Kingston, and developed recommendations for sustainable urban development and affordable housing. We produced a 115-page report that is summarized in this paper (Crisman 2021). Section 1.0 provides an overview of seven challenges to sustainable urban development in Jamaica. 1.1 examines climate change and the associated threats to infrastructure, resilience, and justice that impact urban housing. 1.2 analyzes land use planning and determines that the Government of Jamaica must prioritize sustainable land-use development to achieve affordable housing. Studying Jamaica's public infrastructure, 1.3 finds that a lack of affordable housing prevents the equitable and sustainable distribution of public infrastructure, including access, reliability, and regularization of utilities, and recommends the expansion of renewable energy, rainwater collection, and stormwater management. Section 1.4 explores Jamaican history and politics—concentrating on the legacy of colonialism and its implications for the contemporary housing crisis, and the problematic political model found in urban communities. 1.5 examines how understanding Jamaican cultural and spatial housing norms can ensure place-appropriate design and long-term success. 1.6 finds that new affordable housing must be designed to mitigate violence in urban communities. Section 1.7 analyzes current conditions and policies in Kingston for both informal settlements and affordable housing.

Section 2.0 applies these findings in two types of low-income housing conditions in Kingston: the existing informal housing settlement of Standpipe and redevelopment in Allman Town. These examples model how the research findings can be translated to other Jamaican communities. The following recommendations aim to increase the quality and provision of sustainable and affordable housing through a holistic, systems framework (Meadows 2008) that integrates environmental, economic, and equity issues within housing policy and design.

1.0 INTERTWINED SUSTAINABILITY CHALLENGES IN KINGSTON

1.1. Climate Change: Impacts on Infrastructure, Resilience and Justice

Understanding both the historical climate and climate change projections is crucial to improve resiliency. Jamaica's tropical rainforest climate is influenced by the surrounding oceans, the El Niño Southern Oscillation, northeast trade winds, and orographic features in the central and northern part of the country. There is little variation in the annual range of mean monthly temperatures that hover around 24C to 27C. Rainfall follows a bimodal cycle with the dry season from December to March and the rainy season from April to November, which coincides with the North Atlantic hurricane season that often causes extreme rainfall, excessive flooding, and intense damage to the country's infrastructure (Bender 2010). Jamaica's climate is already changing. Warmer temperatures, more frequent and intense storms and storm surge, less annual precipitation but more intense rain events, and rising sea levels are projected (Nurse 2017). Longer periods of drought, produced by higher temperatures and less rainfall, will exacerbate existing infrastructural problems (Carby 2021). Rainwater collection is now essential to supplement potable and agricultural water supplies and reduce current and future water stress. The 22.5 billion cubic meters of rain falling annually on the island can be harvested as part of a system of decentralized rainwater harvesting infrastructures, both urban and rural, that can help to offset the 126 million Cubic meter shortfall estimated by the Government of Jamaica (Haughton 2021). Sea-level rise will damage coastal settlements, reduce the well-being of humans and other species, and weaken the economy and the tourism sector. Building resilience within Jamaica and Kingston is urgent and essential. Plans must provide equity for the most vulnerable communities, including those living in informal settlements.

The impacts of severe weather events and climate change are disproportionate. While the tourism industry and families with high incomes may have the financial capacity to recover from hurricanes, floods, and droughts without assistance, the lives of lower-income individuals can effectively be destroyed. Approximately one billion people live in informal settlements globally, mostly in urban areas of low and middle-income countries (Satterthwaite 2020). The negative effects of climate change on informal settlements are exacerbated by the lack of adequate infrastructure (e.g., paved roads, drainage networks, piped water) and public services critical to resilience, such as healthcare, education, and access to emergency services. Projected global population growth will likely result in more informal settlements if governments do not enact policies to increase affordable housing that provides a healthier, safer alternative. Jamaica is already suffering from the adverse effects of climate change and climate resilience policies are urgently needed. Furthermore, the damages from natural disasters and the consequences of climate change are worsened by the long history of poor land use practices throughout Kingston. To ensure sustainable development, climate change and its impacts must play a critical role in all future land-use plans for the city.

1.2. Sustainable Land Use Planning

Jamaican independence in 1962 led to rapid urbanization and overpopulation in many cities. Inadequate and poorly maintained infrastructure, as well as newly built informal settlements, strained under the process and still contribute to environmental degradation, growing urban sprawl, and dilapidated housing (Mullings 2018). For example, Kingston lacks a cohesive, long-term, and multidisciplinary sustainability plan and implementation strategy. It is crucial that Kingston improve sustainable land management to create resiliency and health benefits for individuals and the larger community. To address this challenge, our team developed several research questions: How can city zoning and transportation planning produce sustainable land use in Kingston? How can green spaces and infrastructure improve the quality and resilience of affordable housing? And how can community-based green spaces, such as parks, gardens, and streetscapes, be integrated into frameworks for affordable housing in Kingston?

In response, we analysed Kingston's current land use through the lens of urban ecology, land conservation, zoning and density, transportation, and housing. We examined examples of planning projects and methods that guide sustainable land use and urban design in cities and island nations with similar climates, topography, and community aspects. For instance, the Caribbean Aqua Terrestrial Solutions Programme worked in eight Caribbean countries using Participatory Three-dimensional Modelling (P3DM) to help communities develop their adaptive capacity through spatial planning. This case study and others offered lessons that Kingston can adapt to its unique geographical and cultural situation. Our analysis addressed several United Nations Sustainable Development goals for Jamaica: sustainable cities and communities, industry innovation and infrastructure, and good health and well-being. Infrastructure and transportation improvements should be structured to meet affordable housing needs while prioritizing safety and resilience. There are opportunities to simultaneously build green infrastructure projects and increase urban tree coverage in Kingston. Together with sustainable land use planning, public infrastructure improvements and utilities provision can address the challenges of rapid urbanization and climate change in Jamaica.

1.3. Sustainable Public Utility Systems and Renewable Energy

Public infrastructure has a massive impact on the environment and human health and well-being. Current service delivery methods harm the environment in many ways, such as depleting water resources and generating emissions from energy production. Climate change will damage infrastructure and further disrupt services. Without stable access to water and electricity, people lack abilities that are essential to health and community connection: proper access to hygiene, operating essential appliances and communication devices, and being able to study or work after dark. Kingston's informal settlements typically lack formal access and connection to reliable power, water, sanitation, communication, and transportation services (Rufin 2015). Residents often connect informally and illegally to water and electric lines, but utility providers do not receive payment and lose revenue needed to continue operations. Establishing formal utility services benefits both parties. How can Jamaica appropriately develop better-quality and more sustainable public utilities to serve all residents, and specifically low-income and informal settlements?

Both water and electric utility services in Jamaica are vulnerable to extreme weather, reduced rainfall and drought, and higher temperatures resulting from climate change. Eighty-four percent of Jamaica's usable water supply is underground, which is becoming depleted by use and already inadequate (US Army Corps of Engineers 2001). Jamaica's main source of energy is fossil fuels that create import dependencies and centralized energy generation. There is currently no alternative method of energy generation when extreme weather conditions cause disruptions. With the goals of creating more sustainable public infrastructure and expanding access to low-income and informal housing, we recommended new technologies and policies for water and energy efficiency, decarbonization, and renewable energy production. A focus on affordability and sustainability will ensure that all Jamaicans have access to the services they need to be healthy and thrive, while minimizing emissions and pollution impacts into the future. Informal settlements without land tenure need resources that can provide basic physical safety and comfort, and public infrastructural improvements help connect residents to the land that sustains them.

1.4. Jamaica's Colonial Legacy and Current Affordable Housing Challenges

Developing viable housing strategies requires an understanding of the history of Jamaica and its people. We identified how aspects of four major periods in Jamaica's history contributed to Jamaica's housing crisis: 1.) indigenous history and knowledge; 2.) pre-independence and European colonialism; 3.) early-independence; and 4.) current political culture and foreign affairs. We studied how the Arawak, the island's original inhabitants, influenced modern Jamaican culture and the integration of nature into physical spaces for leisure and community. For instance, various trees have cultural significance to Jamaica that stem from Indigenous traditions (Keegan and Carlson 2008). Learning from these practices can produce environmental and health-related benefits, while acknowledging the people who inhabited this land before they were decimated by Spanish colonists. The island was claimed for Spain by Christopher Columbus in 1494, settled by the Spanish, and after 1655 transformed by the British into a slave-worked sugar plantation colony. Slave rebellions were common in Jamaica and early power dynamics in race and class relations were mimicked in the early independent political structure of Jamaica (Jaffe 2015).

Slavery was abolished in 1838, but the British continued to uphold their idea of a proper structure of society based on "whiteness, wealth and education" (Hall 2021). The British maintained control of freed slaves by drawing divisions in gender, class, and race. The 1850s and early 1860s saw increased poverty and unemployment among the Black population with the exodus from plantations to "squatting" (Tindigarukayo 2004). Several anti-squatting laws were passed to repossess lands that were illegally claimed by Black Jamaicans and the British enforced arbitrary taxation, high land rents, and denial for land for ex-slaves. Squatting was suppressed by 1900 and the Crown Colony redistributed land to agrarian capitalists (Goffe 2017). Jamaica gained independence in 1962, but British colonialism "left behind a divided system of unequal gender, race, sex and class; it is so deeply entrenched that it ensures that violence in Jamaica is an everyday norm" (Lemonius 2017). With changes in the political sphere, urban spaces became areas of vulnerability and violence, where the poor Black population faced continued challenges inherited from the colonial system. Without adequate industrialization and consistent employment, Kingston's lower-class Black population were confined to dense, crowded, and poor-quality urban housing. It is estimated that from 1960 to 1961, the number of squatters increased from 3,000 to 20,000 (Clarke 2006).

The Jamaican Labour Party (JLP) took power post-independence and political antagonism, clientelism, and violence ensued as opposing parties engaged in "ghetto politics." Garrison communities emerged as "a totalitarian social space in which the options of the residents are largely controlled" (Clarke 2006). The Jamaican state used tactics inherited from the colonial system toward the urban working-poor and unemployed. The fragility and vulnerability of a new nation-state made it particularly vulnerable to foreign influence and global economic forces. Gangs have turned to the growing drug war for financial support, as neoliberalism and structural adjustment policies diminish state assistance. Jamaica experienced "deregulation of import controls, public sector retrenchment, reduction and removal of subsidies, tighter monetary and fiscal policy, deregulation of the financial sector, and privatization of publicly-owned enterprises" (Handa 1997). By the 21st century, "almost half the Jamaican annual budget was being spent on servicing the national debt...leaving inadequate amounts available to maintain and develop the priority areas of education, health, transport and public works, with almost nothing going into housing" (Clarke and Howard 2006). The fragility of Jamaica as a new nation-state fostered foreign influence, from political assistance provided by the U.S. during the Cold War to the global phenomenon of neoliberalism. Many parts of Jamaica's history contribute to the housing crisis today.

1.5. Housing Norms: Cultural and Spatial Practices

Researching the cultural practices and customs of Jamaica is essential to create housing recommendations that are culturally appropriate for a specific community. We examined family structures and kinship, spatial segregation, religious structures, community resilience, relationships with nature, and housing design. For instance, the concept of home does not begin at the door, but rather at the gate outside the property (Nelson 2021). The front yard and/or porch function as a social space to gather and are important architectural elements. Simply including a front porch in the design of new housing, for example, provides vital places for residents to connect and socialize with one another. Considering the large role of the built environment in residents’ daily lives, housing structures offer an incredible opportunity to improve upon the public health, safety and inclusivity of a given community. Designing a neighborhood with the intent to support interpersonal bonds will consequently benefit larger issues of isolation, polarization, and crime.

1.6. Crime and the Affordable Housing Crisis

Jamaica has experienced a steady increase in the frequency and severity of crime over the past ten years. A spike in murder, assault, and robbery stops many tourists from visiting Jamaica and has led to decreased tourism revenue. Despite Government reforms, the number of murders and other violent crimes in Jamaica is one of the highest globally (UN Office on Drugs and Crime 2007). The Government attributes these alarmingly high crime rates to unemployment, poverty, weak family structure, income inequality, and a corrupt police system in their country. Crime Prevention Through Environmental Design (CPTED) is one strategy that can help. CPTED uses design principles within buildings and communities to prevent and deter violent crime, vandalism, and theft while concurrently reducing fear of crime and improving community members’ overall well-being. CPTED is also known as Design out Crime (DOC) and Defensible Space and Crime Prevention Through Urban Development (CPT-UD). New affordable housing can address severe crime through the eight core principles of CPTED: territoriality, natural surveillance, image and milieu, access control, social cohesion, community culture, connectivity, and threshold capacity. Some CPTED principles offer aesthetic improvement and community well-being benefits, but CPTED must be integral into the entire urban planning process to be effective (Johnson 2014).

Beyond design, Jamaica needs to enact a series of comprehensive reforms and programs to effectively reduce high levels of crime. Some approaches seek to improve society more broadly, such as education reform and good urban design; others more directly relate to crime, such as gun control, drug policy reform, and police reform. A community-centered approach to citizen agency is more effective than relying solely on retroactive punitive tactics (Moloney 2013). From a housing standpoint, regularizing informal settlements will improve stability for families and reduce some of the root causes of crime. Creating well-designed, equitable, affordable housing and cohesive neighborhoods can lower the prevalence of crime in Kingston, Jamaica.

1.7. Best Practices for Jamaica’s Affordable Housing and Informal Settlement Crisis

Historically, the main drivers of Jamaica’s housing crisis have been rapid urbanization, high construction costs, limited economic opportunities, poor coordination between stakeholders, the growing number of informal settlements, and the lack of long-term housing affordability and support from government programs (Tindigarukayo 2002). These complex and intertwined issues are not unique to Jamaica, but they all stem from and center around the problem of affordability. While the complexities of housing affordability cannot be solved overnight, Table 1 outlines five clear steps the Government of Jamaica can take before initiating new affordable housing policies and programs.

Table 1: Five Recommendations for Initiating New Housing Policies and Programs. Source: (Crisman 2021)

1. Standardize affordable housing metrics and definitions.
2. Shift the roles of current stakeholders and major players.
3. Integrate all pillars of socioeconomic planning.
4. Create new policy levers and programs. <ul style="list-style-type: none"> • Community Land Trust model • Regularization of informal settlements • Sustainable Development Goals framework
5. Implement new sources of funding and financial incentives. <ul style="list-style-type: none"> • Sustainable Return on Investment • Cost-benefit Analysis of infrastructure, materials & sustainability • NatureVest schemes • Doha Amendment • National industry diversification

Jamaica could learn from themes that emerged while we examined the strengths and weaknesses of affordable housing policy in other Caribbean and Latin American countries. Relocation efforts that move communities to new housing are mostly unsuccessful because of the social and economic ramifications tied to relocation (Office of Evaluation and

Oversight 2017). Upgrading existing housing stock and infrastructure is a more effective way to provide affordable housing, and Jamaica should consider several mechanisms through which to achieve this. Additionally, there is a lack of suitable, well-serviced land for housing expansion in many Caribbean countries. Overcoming this barrier requires integrated and inspired environmental planning and urban and architectural design.

The national vision statement in Jamaica’s *Vision 2030 Plan* asserts “Jamaica, the place of choice to live, work, raise families, and do business” (Planning Institute of Jamaica 2009). To achieve that vision, Jamaicans need housing that is affordable, sustainable, and secure. The Government of Jamaica must take on the challenge of affordable housing and create a structured, detailed framework for addressing the issue. Through proper foresight, planning and coordination of stakeholders and funding, the vision of Jamaica as a vibrant, livable, sustainable, and equitable nation can finally be achieved.

2.0 STRATEGIES FOR TWO TYPES OF HOUSING IN KINGSTON

The second research phase proposed affordable housing strategies for two common types of urban conditions in Kingston: 1.) existing informal settlements, and 2.) redevelopment areas for new affordable housing. In both case studies, there are excellent opportunities to incorporate sustainable design, community participation, and data-driven action to enhance the overall resilience of these communities.

2.1. Existing Informal Settlements: Standpipe Case Study

Informal settlements are proliferating in Kingston and their problems of poor living conditions, high crime rates, and lack of tenure concern decision-makers and designers. Working in Kingston’s long-standing informal settlement of Standpipe, we conducted a situational analysis, examined precedents to identify best practices that can be translated to the Jamaican context, and then developed recommendations for revitalizing this informal settlement and similar places in Kingston. Table 2 outlines ten recommendations for informal settlement regularization that are grounded in the fundamental principles of community participation, sustainable and equitable design approaches, collaborative and innovative financing, and institutional capacity building.

Table 2: Ten Recommendations for Informal Settlement Regularization. Source: (Crisman 2021)

<p>1. Experiment with varying forms of sustainable and purposeful community engagement.</p> <ul style="list-style-type: none"> • Implement thorough and thoughtful local surveying. • Host regular and open community meetings. • Hire and compensate community liaisons and representatives. • Establish local and accessible relational and informational offices. • Include residents in decision-making processes and ask for feedback as projects progress. • Consult community stakeholders to prevent delays in decision-making due to conflicting agendas.
<p>2. Build institutional capacity and stakeholder relationships.</p> <ul style="list-style-type: none"> • Partner with local NGOs and universities to streamline the upgrading process. • Communicate with the new land titling working group between the Ministry of Housing, Urban Renewal, Environment & Climate Change, and the Ministry of Economic Growth & Job Creation to ensure perspectives from the Standpipe community are heard.
<p>3. Plan and conduct a climate change vulnerability assessment.</p>
<p>4. Take a holistic approach to incremental housing upgrading policies. Complement with policies that improve social services and infrastructure for maximum effectiveness.</p>
<p>5. Use a combination of public financing and more collaborative, innovative financing approaches to overcome institutional constraints facing housing upgrading projects.</p>
<p>6. Expand and continue the regularization of electric utilities with the assistance of the Jamaican Public Service Company. Offer prepaid electricity plans and energy management classes to every household in the community.</p>
<p>7. Formalize solid waste management services to prevent waste from accumulating in Sandy Gully and local streets.</p>
<p>8. Use green infrastructure best practices to redesign and restore Sandy Gully to effectively convey and filter stormwater while providing a green amenity to the community.</p>
<p>9. Provide financial incentives such as tax credits to firms who improve infrastructure in Standpipe.</p>
<p>10. Introduce Crime Prevention Through Environmental Design (CPTED) principles while upgrading housing structures to concurrently address safety and livability concerns.</p>

2.2. New Affordable Housing Redevelopment: Allman Town Case Study

This case study applies best practices for relocation and new affordable and sustainable housing construction in Kingston. Adjacent to the National Heroes Park, Allman Town is located within the Government Oval development of the larger Government Campus Project. We examined the Environmental Impact Assessment created for the Jamaican Houses of Parliament Project, considered the implications of relocating a portion of the community, examined successful housing initiatives, and developed best practices. Our recommendations are grounded in four guiding principles: community participation, sustainable and equitable development/design, innovative financing methods, and institutional capacity. Many specific actions are contained within this larger framework. Table 3 aligns each principle with components of the new affordable housing development process.

Table 3: Four Guiding Principles for New Affordable Housing Development. Source: (Crisman 2021)

<p>Community Participation</p> <p>Host community meetings and workshops.</p> <p>Elect community representatives.</p> <ul style="list-style-type: none"> - Ensure their review of building designs. <p>Establish community construction contracts.</p> <ul style="list-style-type: none"> - Allow residents to express dissatisfaction with implementation results and explicitly secure their expectations. <p>Create offices in intervention zones to facilitate committee interaction.</p> <ul style="list-style-type: none"> - Offer childcare to include more women in community meetings. - Choose meeting times that do not interfere with work and family responsibilities to maximize participation. <p>Create regulations that do not penalize residents for informal activity, such as selling goods within the neighborhood.</p> <p>Incorporate education and skill building along with incentives to earn certifications or credits for loans.</p> <p>Provide decision-making opportunities and power for residents when surveying for planned policy development initiatives.</p>	<p>Institutional Capacity</p> <p>Increase data and accessibility.</p> <ul style="list-style-type: none"> - Partner with NGOs. - Partner with universities to establish housing research working groups. - Enhance spatial planning data collection such as Geographic Information System (GIS) Mapping. - Improve user experience design on Government of Jamaica sites and housing finance resources. <p>Streamline stakeholder organization.</p> <ul style="list-style-type: none"> - Ensure consistency in housing standards and architectural design. - Facilitate ease of communication between groups and clearly defined roles. <p>Ensure data-informed implementation plans.</p> <ul style="list-style-type: none"> - Conduct development plans that follow urban spatial planning data and environmental data.
<p>Innovative Financing</p> <p>Earmark interest earned from residents' deposits for communal utilities and maintenance fees.</p> <p>Direct the capital from cleared land sold to private developers to new construction elsewhere.</p> <p>Engage in socially and sustainably responsible partnerships with investors.</p> <p>Explore funding sources from conservation finance and sustainable investing funds.</p>	<p>Sustainable & Equitable Development/Design</p> <p>Implement incremental housing.</p> <p>Incorporate mixed-use zoning.</p> <p>Install renewable energy systems.</p> <p>Use sustainable and local building materials.</p> <p>Incorporate culturally significant art and design principles into planned development initiatives.</p> <p>Ensure variability and customizability within new designs for diverse income levels and family sizes.</p> <p>Prioritize green space for microclimate and garden areas to encourage food independence.</p>

3.0 NEXT STEPS

Our shared future depends on creating healthy and equitable living conditions for all species. Jamaica can model how to envision and realize a sustainable future for Small Island Developing States (United Nations 2021). The island of Jamaica is particularly vulnerable to climate crises and an ethical, holistic approach to intertwined environment, economy, and equity considerations must be at the forefront of housing discussions. Informed by interdisciplinary research and a systems approach depicted in Figure 1, the Diplomacy Lab team developed sustainable strategies for the revitalization and new construction of affordable housing in Kingston and other Jamaican cities. As demonstrated in the Standpipe and Allman Town case studies, positive change requires a combination of community participation; equitable and sustainable design; collaborative, innovative financing; and institutional capacity-building.

Engaging and educating residents about broader sustainability strategies is essential to change behaviors and ensure that communities remain affordable and resilient in the long run. Integrating community members into the envisioning and decision-making process from start to finish will generate deeper commitment and enthusiasm for Government initiatives. Additionally, better stakeholder relationships combined with sustainable infrastructure strategies will help to mitigate crime and improve overall health and well-being. With strong communication pathways and an intersectional approach, the Government of Jamaica can create a home for all Jamaicans.

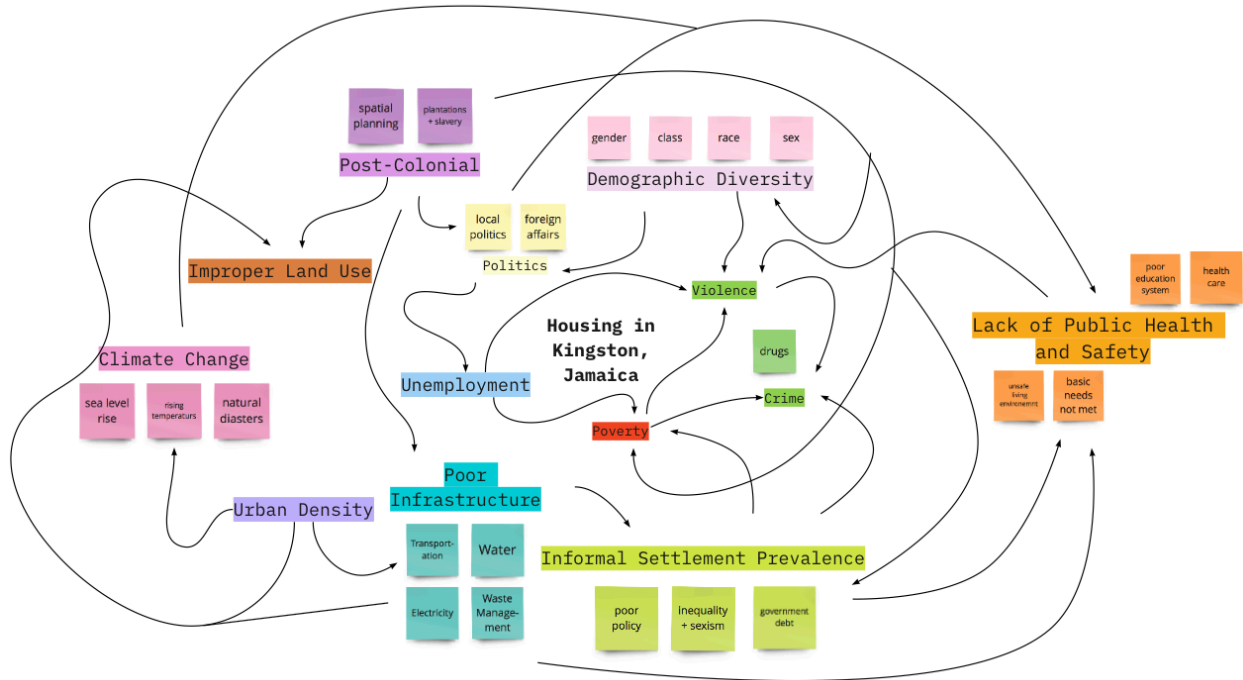

Figure 1: Systems Diagram depicting Complex Housing Factors in Jamaica. Source: (Crisman 2021)

ACKNOWLEDGEMENTS

This research would not have been possible without the participation of the following individuals who graciously and wholeheartedly contributed their time and expertise to the Diplomacy Lab process.

- Gordon Steenberg, Political-Economic Associate, U.S. Embassy in Jamaica
- Joe James, Economic Officer, U.S. Embassy in Jamaica
- Elvis James, Political/Economic Specialist, U.S. Embassy in Jamaica
- Charles Emrich, Office of Technical Assistance, U.S. Treasury Department
- Katherine Marinari, U.S. Department of Housing and Urban Development
- Nakia McMorris, Senior Manager, Community Development, Housing Authority of Jamaica
- Dr. Earl Bailey, University of Technology, Jamaica; University of the West Indies at Mona, Jamaica
- Loy Malcolm, Deputy General Manager, Urban Development Corporation
- Zaneta Scott, Ministry of Housing, Urban Renewal, Environment & Climate Change
- The Hon. Fayval Williams, Minister of Education, Youth & Information, and Member of Parliament
- The Hon. Parnel Charles Jr, Minister for Housing, Urban Renewal, Environment & Climate Change
- University of Virginia Global Environments + Sustainability Capstone Seminar Research Team:
- Tara Boyd, Yewon Choi, Shelby Curry, Scott Danforth, Satori Greene, Liv Gwilliam, Addie Klimek, Amelia Lindsey, Jasmyn Noel, Macie O'Connor, Madison Parse, Caroline Pittard, Sabrina Sampson, Lea Taylor, Gracie Tilman, Skylar Wampler, Alicia Zheng, Yuki Zheng

REFERENCES

Bender, M. et al. 2010. "Modeled Impact of Anthropogenic Warming on the Frequency of Intense Atlantic Hurricanes," *Science* 327, no. 5964.

Carby, B. 2021. "Effect of Climate Change on Jamaican Infrastructure," University of the West Indies, Mona.

Clarke, C. 2006. "Politics, Violence, Drugs in Kingston, Jamaica." *Bulletin of Latin American Research* 25, 3 (June): 420-440.

Clarke, C. and Howard, D. 2006. "Contradictory Socio-Economic Consequences of Structural Adjustment in Kingston, Jamaica." *The Geographical Journal* 172, no. 2: 106-29.

Crisman, P. 2021. *Strategies for Sustainable Development + Affordable Housing in Kingston, Jamaica*. Charlottesville, VA: University of Virginia.

Hall, D. 2021. "The Colonial Legacy in Jamaica." *New World Journal*.

Goffe, R. 2017. "Capture and Abandon: Social Reproduction and Informal Land Tenure in Jamaica." *CUNY Academic Works*. City University of New York.

Lemonius, M. 2017. "Deviously Ingenious": British Colonialism in Jamaica." *Peace Research* 49, no. 2: 79-103.

- Handa, S. and King, D. 1997. "Structural Adjustment Policies, Income Distribution and Poverty: A Review of the Jamaican Experience." *World Development* 25, no. 6 (June): 915–30.
- Houghton, S. 2015. *Jamaica's Water Insecurity*. Rice University: Baker Institute for Public Policy.
- Jaffe, R. 2015. "From Maroons to Dons: Sovereignty, Violence and Law in Jamaica." *Critique of Anthropology* 35, no. 1 (March 1): 47–63.
- Johnson, D. et.al. 2014. "Developing and Maintaining Sustainable Communities: Managing the Output Focus of Crime Prevention through Environmental Design (CPTED)." *Caribbean Urban Forum* (May): 14-17.
- Keegan, W. and Carlson, L. 2008. *Talking Taino: Caribbean Natural History from a Native Perspective*. Tuscaloosa: University of Alabama Press.
- Meadows, D. 2008. *Thinking in Systems: A Primer*. White River Junction, VT: Chelsea Green Publishing.
- Moloney, K. 2013. "Governing without Collaboration: State and Civil Society Relations in Jamaica." *International Public Management Review* 14, no. 1.
- Mullings, J. et.al. 2018. *Urban Renewal and Sustainable Development in Jamaica: Progress, Challenges and New Directions. An Overview of Urban and Regional Planning*. IntechOpen.
- Nelson, L. 2021. Interview with the University of Virginia Diplomacy Lab research team (March 31).
- Nurse, L. 2017. "Climate Change Impacts and Adaptation for Coastal Transport Infrastructure in Caribbean SIDS," UNCTAD National Workshop Jamaica.
- Office of Evaluation and Oversight. 2017. "Comparative Project Evaluation of IDB Support to Low-Income Housing Programs in Four Caribbean Countries." Inter-American Development Bank.
- Planning Institute of Jamaica. 2009. *Vision 2030 Jamaica National Development Plan*. Kingston, Jamaica: Planning Institute of Jamaica.
- Rufin, C. 2015. "Politics of Utility Service Provision in Brazil's Favelas." Suffolk University: Sawyer Business School, (April 25).
- Satterthwaite, D, et.al. 2020. "Building Resilience to Climate Change in Informal Settlements." *One Earth* 2, no. 2 (February 21): 143–56.
- Tindigarukayo, J. 2002. "The Squatter Problem in Jamaica." *Social and Economic Studies* 51, no. 4: 95–125.
- Tindigarukayo, J. 2004. "A Program for Housing the Poor in Jamaica." University of the West Indies (June 24).
- United Nations. 2021. "About Small Island Developing States." Accessed May 4, 2021. <http://www.un.org/ohrlls/content/about-small-island-developing-states>.
- UN-Habitat. 2020. *World Cities Report 2020*.
- UN and World Bank. 2007. *Crime, Violence, and Development: Trends, Costs, and Policy Options in the Caribbean*. A Joint Report by the United Nations Office on Drugs and Crime and the Latin America and the Caribbean Region of the World Bank.
- U.S. Army Corps of Engineers. 2001. "Water Resources Assessment of Jamaica." U.S. Southern Command (February).
- US Department of State. 2021. "Diplomacy Lab." Accessed May 1, 2021, <https://www.state.gov/diplomacy-lab>.

Towards a Community-Led Design Studio: Cultivating Relationships and Stewarding Projects

Julia W. Robinson¹, Timothy Griffin², Jaycie Thomsen³
Savannah L. Steele¹, Michael Chaney⁴, Jamil Ford⁵

¹School of Architecture, University of Minnesota, Minneapolis, MN

²Minnesota Design Center, University of Minnesota, Minneapolis, MN

³Northside Safety NET Environmental Initiative, Minneapolis, MN

⁴Project Sweetie Pie, Minneapolis, MN

⁵Mobilize Design and Architecture, Minneapolis, MN

ABSTRACT: In its second year, an urban design studio works with community members on neighborhood design, in an area grappling with a complex history of displacement, violence, racism and redlining resulting in sustained poverty, inequitable wealth accumulation and inequitable public investment. The studio goal is to catalyze a paradigm shift in urban design towards equitable design. The studio embraces a community-led, long-term approach to developing and implementing sustainable and just urban plans that reflect the values, concerns, priorities and ideas of residents, youth, businesspeople and community organizations. The project is a partnership between the university/college/school of architecture and several community organizations.

In response to the student evaluations of and community participant reactions to the 2021 studio community engagement approach, the research team aimed to design a community-led process centered on sustainability and equity for the 2022 studio. The studio engaged in a variety of methods to recruit participants, to develop appropriate pedagogy, to develop community co-design methods, and to work with community organizations. This paper describes and evaluates the successes and limitations of 2022 project, presenting proposed approaches for 2023.

KEYWORDS: Community engagement, Community-led, Participatory design, Design studio, Urban Design

INTRODUCTION

The fall 2022 design studio, *Investing in North Minneapolis* is the second year of a four-year design research project that seeks to co-create sustainable and just urban designs with the community that reflect its values, concerns, and priorities. In contrast to existing urban design practices driven by city professionals and developers, this project aims to foreground a grass roots urban design approach. The 2022 studio methodology builds on the findings from undergraduate studios on urban design in fall 2021 (Robinson et al, 2022, investinginnorthmpls@info), and on work preventing of youth involvement with the justice system in 2018-2021 (Robinson and Price, 2021, designforyouth@info).

The project is organized around North 26th Avenue, which connects Theodore Wirth Park to the west to the Mississippi River to the east. Minneapolis is a culturally diverse neighborhood, and home to various migrant and immigrant groups both international and from within the United States. As a result of displacement, natural disasters, violence, racism, and redlining, and inequitable public investment, the economic disparities between this neighborhood and nearby white areas of the city are extreme. The studio goal is to catalyze a paradigm shift in urban design towards equitable design. by co-creating designs with community participants that develop existing and new sustainable community structures to serve all incomes and enable wealth-building as a part of developing the civic commons (American Planning Association, 2022, Minneapolis Parks Foundation 2023).

1.0 STUDIO FALL 2021

In 2021, in addition to an architecture faculty member, and a community engagement research expert from the University of Minnesota, the research team consisted of a leader of a neighborhood group, a local businessman, and a developer. Funding was provided by the developer and the neighborhood group to support recruitment and stipends for community participants and youth interns. The community recruiter identified 10 community participants, and one intern. During the semester, an alliance with a community gardening organization led to another five community participants for the last half of the semester. Students were concerned to have more age diversity since most of the participants were estimated to be over 50 years of age. Responding to the students' concern, an alliance with a housing organization for post-high school youth generated five young adults in their twenties who joined one review and another of whom also attended a second review.

Due to the pandemic, community meetings and project reviews took place using Zoom. The one-and-a-half-hour community meetings did not include professionals other than team members, while reviews were four hours, and included BIPOC professionals, university researchers and instructors, and community members who chose to join, usually three or four from each group, divided into two review teams. While successful for reviews, this did not work well for community meetings designed to incorporate a Geodesign approach that uses GIS maps to develop and share designs (Steinitz 2012). Remote meetings did not allow manipulation of design elements, so co-design was not possible. Design ideas were presented and responded to, leading instead to community-informed design. Furthermore, while a Geodesign approach typically includes several types of community group, this group was exclusively residents. Additionally, the community participants did not appreciate large scale design representations on a map or bird's eye perspective, which led us to develop urban design projects that addressed residents' concerns for their neighborhood, without a comprehensive mapped urban plan typical of a Geodesign project.

The student projects in fall of 2021 included three urban scale projects addressing street design, three projects addressing housing (2 middle housing projects and one project for young adults homeless, coming out of foster care or coming out of detention), two projects addressing after school programs, one project addressing business development, two projects addressing food and agriculture and one project addressing development along the river (investinginnorthmpls@info).

1.1 Evaluation of the 2021 project -Community Research

Project Team member Timothy Griffin took the opportunity to evaluate the project as a part of a methodology class for his PhD studies. He looked at the experience of the predominantly Black community members interacting with the predominantly white University of Minnesota undergraduate architectural design class that focused on Northside Minneapolis community design issues, needs, and opportunities. The research method consisted of interviews with four North Minneapolis community members who participated in the studio, questioning their experience participating in this conversation, asking 1) how the final student projects reflected community issues, needs, and opportunities (in the student work); 2) if student ideas were helpful in furthering the North Minneapolis agenda; and 3) if and how the student-community relationship as it changed over the course of the semester.

The research findings and recommendations were helpful in adjusting the studio 2022 syllabus. There was a strong desire to have students, presenters, and teachers of color more involved in the future. Community issues, needs and opportunities were nicely represented in student work and student projects reflected community comments and illustrated ideas for a community agenda. These exhibits of student work were seen as potentially creating a catalogue for community members and organizations to advocate specific development projects and redevelopment policies. A recent example is the 2022 announcement of the NEON (Northside Economic Opportunity Network) Food Hall, which inspired the design of a 2021 student project now shown on the project website.

While there was too short a time to build a true relationship between students and community members, there was time for a respectful introduction of students and community participants. They advocated for relationship between community members and the University-based research team to be developed with more time in the community through additional class, research, and social engagement. North Minneapolis community wealth and overall wellbeing could improve with ongoing interaction with students and access to university resources to propose and support community development. Over time, a stronger community co-design tradition could emerge for University of Minnesota students and other institutions and organizations with more diverse student and practicing professional populations, such as Metropolitan State University and Dunwoody College of Technology, American Institute of Architects Minnesota (AIA-MN) National Organization of Minority Architects (NOMA) chapter and collaborating with community resident groups including youth and elders.

Finally, the University of Minnesota's anchor institution role in North Minneapolis could learn from the current effort to map the University of Minnesota's engagement footprint to deliver more inclusive and better outcomes for design students and North Minneapolis residents and organizations. The participant experience was positive and worthwhile. The community participant interviewees (s have) indicated a willingness to continue and recruit others for future class engagements. Additionally, the candidate pool of professional designers from previously excluded groups could be increased by early exposure and skill building for youth participants.

1.2 Evaluation of the 2021 project -Student Course Evaluations

The 2021 studio students' assessment included many comments and suggestions. The students were disappointed in the lack of age diversity of the community participants and with the one-and-a-half-hour length of the Zoom meetings (employed to substitute for in-person meetings and scheduled to fit participants schedules). They were appreciative of the limited opportunity to work with the young people that was able to be arranged, but felt it was insufficient. Additionally, although happy with the project reviews, especially the two that took place in person, students found that the Zoom format of the community meetings limited constructive interaction with community members. In a previous studio some of the students had engaged in informal interviews with community members, and during the semester had sought to talk informally in the street with people in the neighborhood. They were angry and dissatisfied with the

instructor's prohibition due to the pandemic being in full force, shooting taking place in the neighborhood, and concern about participating in extractive practices in this exceedingly well-studied neighborhood.

2.0 STUDIO FALL 2022

2.1 Approach

The 2022 studio goals were to deepen community engagement through relationships with community organizations and individuals, and to develop urban design methods that supported co-design and community-leadership. We committed to a three-to-five-year project. We also sought to foster connection between design students and community members to encourage collaboration. Students were asked to relate to the work as design stewards rather than design owners, and to see their work as a continuation of the research and design from previous studios.

Rather than start fresh, students were asked to review research and design work from the earlier studios and to address that work in their research and projects. We instructed students to view their projects in the context of earlier studio work and community ideas.

We held all instruction and community engagement in-person in response to the feedback from the fall 2021 studio that desired deeper relationships. The studio shifted from bi-weekly virtual meetings to weekly in person design sessions with youth interns and bi-weekly reviews with community member. This was possible due to the reduction of pandemic threat.

We took a multi-pronged approach to community engagement. Our project exhibits many of the justice approaches described by Cruz and Forman, including decolonizing knowledge, confronting inequality, and curating new urban pedagogies (2022). Perhaps most importantly, our approach collaboratively designs *with* the user, recognizing and employing user expert knowledge (Hoffman 2014:15-18). Also, the project aims to change the existing sequence of city planning from an unjust process that is generated by the city, to one that originates in the neighborhood. The normal planning process is controlled by the city, may include some citizen participation, but prioritizes economics of scale that benefit large white-owned developers. In contrast, our process originates in the neighborhood with an economic approach and scale that will directly benefit the neighborhood. This requires a leadership strategy and pedagogy that develops collaboration with local individuals and organizations so that the design studio's role is to manifest the neighborhood ideas in the form of urban plans and specific projects. That is why the project is several years in length, as developing relationships within the neighborhood, and creating designs that represent neighborhood goals and aspirations requires an investment of time in the place.

To achieve these larger goals in the context of the design studio and responding to the critical responses to the first year, we instituted several changes for 2022. First, the studio included six North Minneapolis youth interns from Northside Safety NET's Environmental Initiative program who worked with the university students during the fifteen-week semester. Additionally, in-person community engagement included five project reviews in class, two co-design events, participation in various community events, local tours, and interviews of community members by students. Weekly studio workshops with interns, bi-weekly reviews, and Saturday co-design events were held at Farview Park in the project area, to increase accessibility and comfort for interns and community members. Farview Park is considered a safe, welcoming community space, not associated with the university. The 2021 studio site was too far from the study area and had a history that induced negative community feelings. We will continue to use the city park community center for future studios and project exhibits.

To expand BIPOC leadership and representation that reflects the North Minneapolis community, the research team expanded to include a co-instructor, youth interns, and a community organizer from the neighborhood. Further, the class invited BIPOC presenters, professional reviewers, and community members.

2.2 Collaboration with Interns

To shift from community-informed design to community-led design we partnered with Michael Chaney and Project Sweetie Pie. This relationship that engendered collaboration with the five Northside Safety NET youth interns that brought a consistent youth perspective. Northside Safety NET is a multi-year internship program for North Minneapolis high school youth focused on green career exploration and leadership development. Prior to their participation in this studio, the interns participated in training focused on various environmental topic areas, like sustainable land care, forestry, and renewable energy. Furthermore, the interns worked closely with community members and organizations, like Project Sweetie Pie, to better understand the environmental context in North Minneapolis.

In "Stage 2" of the internship program, which coincided with the university's fall semester, Northside Safety NET interns worked with the graduate students at Farview Park one day a week for one and a half hours. They also participated in the two six-hour community co-design events. During the studio time, interns generated ideas with the students and provided feedback on their work (see Figures 1 & 2). The goal was to develop sustainable, community-based designs by blending the interns' experience of their community and expertise on environmental issues with the design expertise of the students.



Figures 1 & 2: Interns and Students Brain-storming at first Wednesday class (Left), Photo by Anukriti Misra. Intern Modeling Rain Garden Entry at 2nd Co-Design (Right), Photo by Julia Robinson.

The integration of the Northside Safety NET interns from Environmental Initiative as community and sustainability experts proved critical to the design of this research approach. Students and university instructors participated in a two-hour training session to learn about best collaboration practices before the first meeting. The interns co-created design solutions in real time rather than community members informing the designs as in past studios. Their contributions as community and sustainability experts and as co-makers of designs enriched the proposals creating genuine co-authorship. The interns' participation on reviews alongside BIPOC professionals exposed them to the academic design process, as did visits to Rapson Hall at the University of Minnesota, once in the middle of the semester, and once at the final review (the end of the semester).

The studio benefited from the interns' feedback, but their involvement provided bi-directional value. Not only did the interns learn about the design process and architecture as a career, but they also gained confidence and developed the skills necessary to communicate their experiences to reach a tangible outcome.

That said, there were still challenges integrating the Northside Safety NET interns into the studio. As high school students, the Northside Safety NET interns were only able to join the last 1-1/2 hours of the studio after school on Wednesdays. Given the priority placed on community empowerment within the design process, it was also a challenge to provide appropriate time for communication between the interns, graduate students, community members and other participants and to facilitate relationship building ahead of design iteration.

We plan to expand collaboration with the Environmental Initiative interns, by changing the class time to start and end a half hour later on Wednesdays, and increasing the number of interns and adding another half hour of interaction. We expect the size of the studio class to increase as well.

2.3 Studio Pedagogy

The approach to student work and assignments was different in 2022, partly because we were instructing graduate students, but largely because we wanted to be cognizant of the distinction between teaching a typical urban design studio and using the studio to investigate community co-design methods. We emphasized hand-drawing and rough model-making to encourage our non-professional partners, both interns and other community members to join with us as designers and feel comfortable to develop their own skills. The project assignments, rather than prescribing outcomes the project assignments provided a container for creative content development.

Another concept fundamental to our studio was equity. We used the Just City values as a starting point, and the studio was influenced by projects on the Just City website (2022). As mentioned above, we defined the student role as steward of their project rather than author, and envisioned projects as connected to past and future research and design.

At the very beginning of the semester, we had two ungraded assignments. The first was to create a just studio arrangement. Using the Just City values as compared to the normal "first come, first served" studio desk arrangement, we charged the eight students to come up with an arrangement of desks and other studio furniture that would advantage every student. Then we asked them to complete the "Where I'm From" exercise from the Just City website as a way to become familiar with the values.

For our first project, in what in previous years had been separate exercises in precedent analysis and GIS mapping of neighborhood resources, became a single first exercise that asked students to critically explore precedents and research from the four previous studios that had worked in North Minneapolis, and the one previous year that focused on urban design. The purpose of the work was to develop a description of our study site at three scales, 1) urban, 2) neighborhood and 3) architecture and urban landscape. This work preceded the first Co-Design Event, where it was presented to community to start a conversation about the community assets and needs.



Figures 3, 4 & 5: Drawings studying early designs for landscape proposal (Left), Photo by Emily Sanchez. Exploratory models explain project & generate discussion at a review (Middle), Photo by Julia Robinson. Sketch models explore play space between house & alley (Right), Photo by Marshall King.

The subsequent exercise, which we revised as students showed their work, asked students to interpret their findings and make some proposals for the neighborhood based on what they had learned from the first Co-Design meeting. The project “What is Important about North Minneapolis & Design Options” included the creation of a cognitive map, and a hand drawn eye-level perspective of their proposals. The first project review was held just before the second Co-Design event and gave students the opportunity to field test their ideas and ways to generate co-design (Figure 3). At this point, the students and interns had worked together two afternoons, and both groups were getting the hang of how to co-design together. The first review became a co-design event with reviewers including interns working on the projects.

Having learned from fall 2021 experience that the community members were more interested in urban design projects than urban design plans, in 2022 students were asked to develop urban designs at a landscape or architectural scale. While encouraged to link their designs to a neighborhood urban design, urban plans were not required of students. Additionally, in response to community interest in seeing immediate changes to the neighborhood, students were asked to develop small projects that could be implemented in the spring or summer.

The third exercise, Urban Design Proposal: Program and Site, asked students to develop a project proposal that addressed issues of concern to the community participants. Students were again encouraged to build upon past student work, but also to base their proposals in research about the neighborhood and precedent projects. There were three phases: programming, site analysis and proposal-making. Students again were encouraged to diagram, draw, and make models, both physical and digital. They used sketch models to explore different design alternatives and expressions (Figures 4 & 5). On Wednesdays they worked with the interns on developing the ideas and getting feedback on their applicability.

At the co-design events and in class various small projects were proposed, and some were lightly developed. As the end of the semester approached, a list of possible projects was compiled by the students and the two best ideas were chosen to pursue. One afternoon was designated for the interns and students to work on these together, with the goal of applying for project funding for construction in spring or summer.

The final project was to develop the students’ proposals as a buildable design. A list of possible deliverables was developed that included material at the three scales, and the requirement that projects be linked to research that supported their benefits to the community in terms of equity and sustainability. They were also asked to include experiential drawings at eye level that incorporated humans and activities. But students were given freedom to choose representations that showed their projects most effectively. The one requirement was for each student to design a summary board for their project in a format for exhibition of their work, to be shown in the community over the summer, and on the project website.

2.4 Relationship with Community Organizations

The 2021 students’ desires to talk with community members, and our awareness of the importance of collaborating with community organizations led us to contact thirty-nine local organizations over the summer. We sought to have them guide the design process by developing Community Liaisons that would recommend community participants and people willing to be interviewed, as well as providing advice on the organization of the community design events. Of this group, two community organizations became part of our research team, nine organizations participated in one or more liaison meetings, and representatives of seven joined in reviews or co-design events.

We had hoped for leadership of the Co-Design process from several of the organizations in the form of a group of Community Liaisons. In the end only the two organizations that joined the research team formally affiliated with the project, although representatives of seven organizations (ten people) attended one or more Co-Design events or reviews. Those that participated, had interests that coincided with ours, largely in connection with the site we had

selected. However, many additional local organizations publicized our community design events, which demonstrated the potential for developing more relationships in the future.

Additionally, about ten Individual community members participated in both reviews and Co-Design Events, some from past years, some responding to publicity, as well as some community professionals. Combining students, interns, team members and community members, the Co-Design and Reviews were attended by between 21 and 28 total participants, with community members (including interns) comprising 50% of Co-Design events and 30- 40% of reviews. This next year we hope to further develop our relationships with community organizations and recruit more community participants through them, and directly through publicity.

Part of our relationship development with the community in summer and fall of 2022 was participating in community events. The summer exhibition of work from the previous fall was presented at a city-wide green summit (as well as at three community sites including the park center where we met all fall) helped to identify potentially interested people and organizations, as did a workshop with a local Green Zone taskforce.

In the fall students and faculty participated in several community events. In this third-year studio of our graduate program, in the 6th week, classes are canceled, and students travel. We took the opportunity to travel at home to deepen the relationship with the neighborhood. Prior to the travel week, we had tables at two or three fall community events. During and after our travel-at-home week we volunteered at a Project Sweetie Pie community garden, and at a community meal.

2.5 Community Engagement

In 2022, community engagement took place in-person at project reviews (Figure 6) and at Co-Design events (Figure 7). Community members who had worked with studios in previous years were invited to participate in reviews alongside professionals, although this year, there was no budget for participation, so people volunteered their time. Community attendance at co-design events was generated by publicity (press releases to news organizations and community organizations and by social media), and again was voluntary.



Figures 6 & 7: Design Review #1(Left), Photo by Emily Sanche. Co-Design Event #2 (Right), Photo by Lizzie Cai.

Our engagement plan changed the character of reviews from evaluations of student work to co-design opportunities. We substituted the seven Zoom community participation meetings with five in-person reviews with community members and professionals, and two community-wide design events. In the end we had to cancel one review (due to participant burnout) so had four reviews, only one of which, the mid-term, was a traditional jury review. The others were round robin reviews in which the seven student projects were presented at individual tables in our meeting room, and reviewers and interns joined in a discussion with, and engaged in design with the students. Students developed questions and models that offered opportunities to draw, to use cardboard and clay for community members, interns and professionals to propose and respond to the work. Many reviewers used the provided forms to comment on the student work.

The Co-design community events were structured to provide background information in the morning, to have two community speakers participate in a discussion at lunch, and, to provide ideas and design input in the afternoon. After lunch at Co-Design event #1, participants voiced and drew their ideas for the community needs, and at Co-Design event #2, like reviews, participants responded to the student work with drawings, models and discussion. People who participated at the Co-Design Events were invited to the last three Wednesday project reviews.

Interaction with community members was essential to the work in the studio. The reviews and co-design events buzzed with activity and discussion. Although we would have liked to have more participants, those who worked with us were very generous with their time, expertise and candor. In addition to those who participated in the reviews and Co-Design events, students interviewed community members with expertise related to their projects. These contacts came from the organizations we had developed relationships with, from contacts provided by research team members and community participants, and from internet research.

In the end, many people interacted with the project to create a total of upwards of 50 community members and professionals. They contributed in a great variety of ways from serving as reviewers, co-design participants, organizers of volunteer events, speakers, participants in organization meetings, mentors and interviewees.

2.6 Stewarded Work

The range of projects reflected the diverse interests of the students resulting in 6 projects stewarded by individuals, and one project by a team. Issues addressed include mental health for young Black women (Figure 8) , peacemaking to reduce street violence (Figure 9), using vacated properties to develop live-work residences (Figure 10), developing 26th Avenue to create neighborhood identities, providing access to the river for fishing and celebration, developing co-housing in existing city blocks, and renovating a vacant middle school to create job training and housing for older youth coming out of foster care or detention.



Figures 8, 9 & 10: Wellness Center(Left), by Logan Schaub & Emily Sanchez. Peace-Keeping Hub (Middle), by Anukriti Misra. Wealth Woven (Right),by Julia Freidrichsen.

The three small projects revolved around 26th Avenue, one promoting connection to the river, the other developing trash receptacles, and the third a rain garden for Farview Park. One small project was selected for implementation, creating wayfinding to local resources for outdoor recreation.

2.7 Exhibition & Website

As in 2021, the student work will be shown in an exhibition to be developed in the spring and mounted in several community locations over the summer. The website and community exhibits are a way to publicize the idea of the Northside public commons, including investments in parks, institutions, connections and wealth building endeavors. The project website will be redesigned to integrate the additional research and student projects with past work, so that it can continue to serve as a repository for potential North Minneapolis investments.

CONCLUSION

Working with the interns greatly enhanced the 2022 project. Focusing on building and landscape scale, we developed tools for active engagement with the interns that applied to co-design with the community as well. Some of these were: providing questionnaires that encouraged people to answer in words or images (Figure 8) models designed allowed participants to try out different design options (Figure 5), and provision of hands-on materials that participants could use to model their ideas (Figure 9).



Figures 11 & 12: Pages with questions used to elicit words and drawings (Left), Photo by Emily Sanchez. Models made by community participants to show their design ideas (Right), Photo by Julia Robinson.

Defining the relationship to student projects as one of stewardship allowed students to see their projects as a shared design while also taking responsibility toward it. The students listened, as well as adopting and creating new

approaches and new ideas that engaged with community values. The concept of building on past projects was supported in that students willingly examined and borrowed ideas from earlier projects, although no student decided to start from and develop a previous project.

The community participation was highly valued by the students, who took full advantage of the opportunities to ask questions and develop designs together. Identifying a wide set of organizations generated a great variety of expertise, design ideas and design goals for the students to address. Some participants had very specific projects they wanted the students to pursue (such as developing a music venue, creating a connection to a bike path, or developing the

26th Avenue corridor), while others were interested in addressing broader issues (e.g., neighborhood safety, support of the arts, growing healthy food, support of mental health, developing green space). The instructors encouraged students to develop new projects that manifest designs for the broader issues, concerned that taking up particular already-existing community projects might favor one part of the community over another.

In both 2021 and 2022 we had an average of 10 community participants at our meetings. In 2021 we had consistent community participation with the people recruited by our community liaison, no doubt due to the stipends we were able to provide to participants, but no regular participation by young people. This year we provided stipends to the interns but had to ask community members to volunteer their time. We believe participants should be given stipends, if at all possible, to support the time and expertise they are contributing to the project. Community participation will be increased if we can provide stipends to all. Therefore, we are seeking funds to support stipends for all community participants next year.

The best way to generate participation is through relationship building. For the future we would like to have more leadership from the community so that an even broader spectrum of people is involved. The project focus on community members is different from the Geodesign approach which promotes discussion between sectors like developers and government. Our goal is that the people that live and work in the community should envision their own future and then present their ideas to those responsible for building them, rather than compromise the ideas at the start with so-called realistic obstacles that may not be obstacles if seen in a different light.

Community leadership for this project is a long-term goal that we will work toward by continuing to engage with community organizations and individuals and by participating in community events. Already, the research team includes more community members to organize the project, which brings interns, individual community participants and students to steward North Minneapolis investments.

ACKNOWLEDGEMENTS

The authors acknowledge the important role played by interns and community members in advancing this work. Funding support for the Investing in North Minneapolis project came from the University of Minnesota (School of Architecture, Center for Urban & Regional Affairs, and Imagine Fund), from United Properties, and from the Minneapolis Jordan Area Community Council. Additional support came from Project Sweetie Pie and the Minneapolis Park & Recreation Board.

REFERENCES

- American Planning Association, 2022. Reimagining the Civic Commons," <https://www.planning.org/blog/blogpost/9139712/>
- Cruz, T. and F. Forman, 2022. *Spatializing Justice: Building Blocks*. Cambridge MA: MIT Press.
- Just City Website, 2022. Memphis, TN: Just City. <https://www.justcity.org/>
- Griffin, T. 2022. "Understanding Community Participant Experience in the Northside Connections Engagement with University of Minnesota Architecture Students" unpublished paper, Minneapolis MN: College of Design, University of Minnesota.
- Hoffman, S, 2014. *Architecture is Participation: Die Baupiloten Methods and Projects*. Berlin: JOVIS Verlag GmbH.
- Minneapolis Parks Foundation. 2023. "Reimagining the Civic Commons," <http://mplsparksfoundation.org/Initiative/reimagining-the-civic-commons>
- Robinson, J., J. Breuer, M. Ackerman, (with R. Houlihan, R. Gay, N. Schroeder & A. Slattery). 2022. "Investing in North Minneapolis". Minneapolis MN: School of Architecture, College of Design, University of Minnesota, investinginnorthmpls@info
- Robinson, J. W., T. Griffin, J. Ford, C. Spann & B. Champeau. 2022. "Neighborhood Design with Community Engagement," *Resilient City: ARCC-EAAE 2022 International Conference, Proceedings, Miami*, 531-538
- Robinson, J. W., and A. Price. 2021. "Expanding Youth Opportunity Studio: Design Research Engaging Community Participants," *Performative Environments: Proceedings of the Architectural Research Centers Consortium (ARCC) 2021 International Conference (Virtual)*, Tucson
- Robinson, J., N. Suchy & J. Breuer (with R. Kadidlo, R. Mohammed, N. Rivera, and Y. Zhao) 2021c. designforyouth@info. Minneapolis MN: School of Architecture, College of Design, University of Minnesota.
- Steinitz, C. 2012. *A Framework for Geodesign: Changing Geography by Design*. Redlands, CA: Esri Press.

Troublesome Creeks: An Atlas of Appalachia in the Anthropocene

Jeff Fugate¹, Brent Sturlaugson²

¹University of Kentucky, Lexington, KY

²Morgan State University, Baltimore, MD

ABSTRACT: *Troublesome Creeks: An Atlas of Appalachia in the Anthropocene* documents established and emerging relationships with water affecting small towns and cities in Central Appalachia through representations of both tangible and intangible phenomena. Driven by a convergence of global economic trends, societal shifts, and climate-related weather events, population loss in small Appalachian communities has created a dynamic urban environment of adaptive uses, settlement patterns, and resilience strategies intertwined with economic transition and societal change. The atlas serves as a visual index of these events as a way of promoting broader accessibility to the issues and encouraging further design thinking at urban and architectural scales. This paper examines the intersection of recent weather events, a legacy of surface mining, two decades of research on so-called “shrinking cities,” and the methodology of an atlas for revealing a sense of radical possibility.

This research illustrates responsive patterns of settlement after a generation of population decline and emerging climate threats. Now facing the fifth of what has been four tumultuous decades, the region is experiencing significant transition, which has the potential for creating a more environmentally sensitive and socio-economically just future. To illustrate these changes, *Troublesome Creeks* consists of a series of maps, animations, and data visualizations that document demographic changes alongside environmental and infrastructural features through the frame of watersheds. The atlas also illustrates emerging settlement patterns and opportunities for new urban design approaches. In addition to public education, the atlas serves as foundational research for Studio Appalachia, an ongoing multidisciplinary design studio that works with communities to co-design more equitable and resilient environments.

KEYWORDS: Depopulation, Climate Change, Post-Industrial Landscapes, Appalachia, Atlas

INTRODUCTION

Central Appalachia, and particularly the Cumberland Plateau, is home to hundreds of creeks, many with fantastic names. Places like Stinky Creek, Greasy Creek, and the eponymous Troublesome Creek suggest an ongoing and tenuous relationship between people and water (Caudill 1980, Stone 1974). Flooding has been part of the landscape since humans first settled in bluff shelters approximately 12,000 years ago. Yet, like so many things in the Anthropocene, thousands of years of experience does not serve as a reliable prediction for what is to come.

1.0 BACKGROUND

1.1 Complex Terrain

On the evening of July 25, 2022, a line of trailing thunderstorms formed along a stationary front across southern Kentucky. By July 30, at least 39 were dead, many more missing, and thirteen counties were staring down catastrophic damage from flash floods that wiped out entire hillsides and communities. The National Weather Service reported that within a narrow band, 14-16 inches of rain fell in a five-day period, which was “historically unheard of.” The NWS report continues, “There is less than a 1 in 1,000 chance of that amount of rain falling in any given year over a 4-day period.” (NWS 2022) Many locations saw 6-10 inches of rain in a period of 24 hours. Anecdotes abound trying to describe the magnitude of what these communities experienced. One of the most acute stories is that of a flood gauge on the North Fork of the Kentucky River in Whitesburg, KY that failed once the river reached 21 feet above flood stage. The previous record was 14.7 feet, sixty-five years prior.

While it may be tempting to assign the misfortune of Southeast Kentucky to a once-in-a-millennium weather anomaly, this is the ninth major weather disaster declared in Kentucky over a three-and-a-half-year period. Casual observations by residents in the region attest that the 500-year flood seems to happen every five years. Confirming these observations, consensus climate projections project that the Central Appalachian region will experience increased extreme rain events in the coming century (EPA 2017). Moreover, rising air temperatures increase the amounts of water vapor in the atmosphere, which in turn results in heavier rainfall events.

Meteorologists talk about the impact of “complex terrain” on flooding conditions, typically in terms of topography. In Central Appalachia, the idea of “complex terrain” becomes even more complex, as the region has experienced monumental changes in the physical landscape as a result of surface mining.

1.2 Topography: Ancient and Anthropocene

The Cumberland Plateau as a geologic formation began as a shallow seabed during the Mississippian and Pennsylvanian geologic periods (approximately 350 million years ago). Horizontal layers of sand, animal shells, and other sediment became layers of shale, sandstone, coal, and limestone. Slowly lifted 2000 feet above sea level, rainfall eroded streambeds into the plateau, eventually carving hills and river valleys through layers of sedimentary rock. Every drop of rain that falls over the Cumberlands eventually finds its way to the Cumberland, Kentucky, Big Sandy, and Licking Rivers via hundreds of creeks, streams, and tributaries, and in recent years, many of these waterways have seen more volume than ever before, drastically impacting the built and natural environment.

Water is the orienting pattern for settlement in the Central Appalachia, and gridded infrastructure occurs only in small town centers and seldom more than a few blocks (e.g. Figure 1). Roads, rail, and rivers are often lined up next to each other in the valleys, which offer the closest semblance to level ground as can be found in this hilly region. Towns seldom follow a true grid pattern, instead tending to be more linear and meandering along the river or creek nestled between ridges.

Residential settlement is often along a dead-end road up the holler (a regional term for what geologists would call a draw) alongside the headwater creek coming off the mountain. Many homes are accessed by bridges across the creek. In the recent floods, over 200 private bridges were too damaged to safely cross, leaving residents stranded.

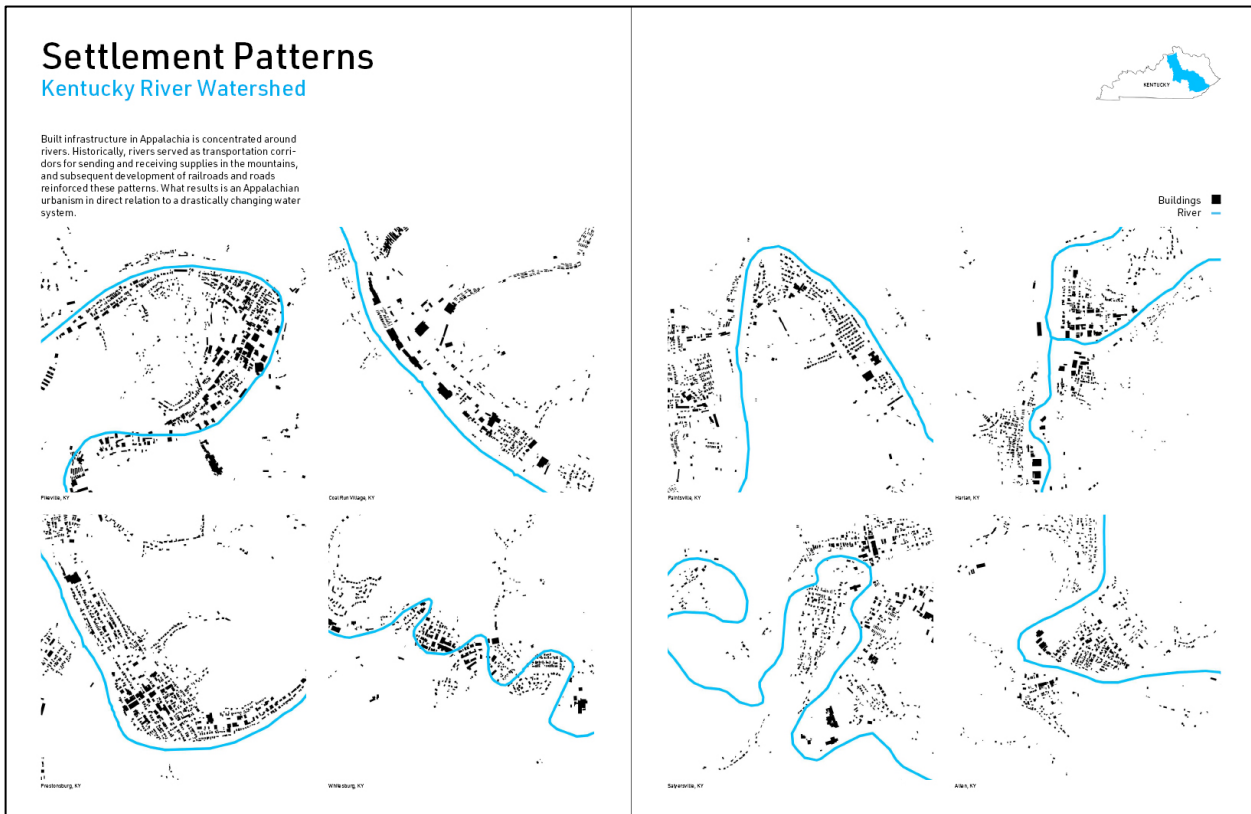

Figure 1: Sample spread from *Troublesome Creeks* atlas showing built infrastructure in relation to rivers. (Authors 2022)

Eastern Kentucky has multiple seams of coal that have been mined in some capacity since the late 18th century. Twenty years after the Civil War, annual coal production in Kentucky broke the million-ton mark and accelerated in the early twentieth century with industrialization and transportation improvements in the region. Coal seams were exclusively mined through underground processes until the 1940s when mechanized excavation equipment was deployed for surface mining operations. During the 1960s and 1970s, surface mining overtook underground mining as the primary source of production in Central Appalachia (KEEC 2017).

In the 1980s a new form of surface mining known as mountaintop removal (MTR) was widely deployed in the region (Figure 2). MTR deploys explosives and excavation to literally remove hundreds of feet of elevation from mountaintops to access hard-to-reach seams of coal. The overburden, as the resulting rubble is called, is relocated into adjacent

streambeds and valleys—as deep as 600 feet at places. The result is what Jedidiah Britton-Purdy describes as “a massive levelling, both downward and upward, of the topography of the region (Britton-Purdy 2016).”

The aftermath of surface mining is arguably the most disruptive of all human activity on the natural landscape (Ross, et.al. 2016). In addition to the topological changes, the resulting rocky flat land is devoid of topsoil, heavily compacted, and often alkaline. Trees cannot take root, leaving formerly wooded hillsides as fields of scrubgrasses that do little to slow runoff. Meanwhile, the overburden disrupts headwater streams that naturally regulate the region’s hydrology.

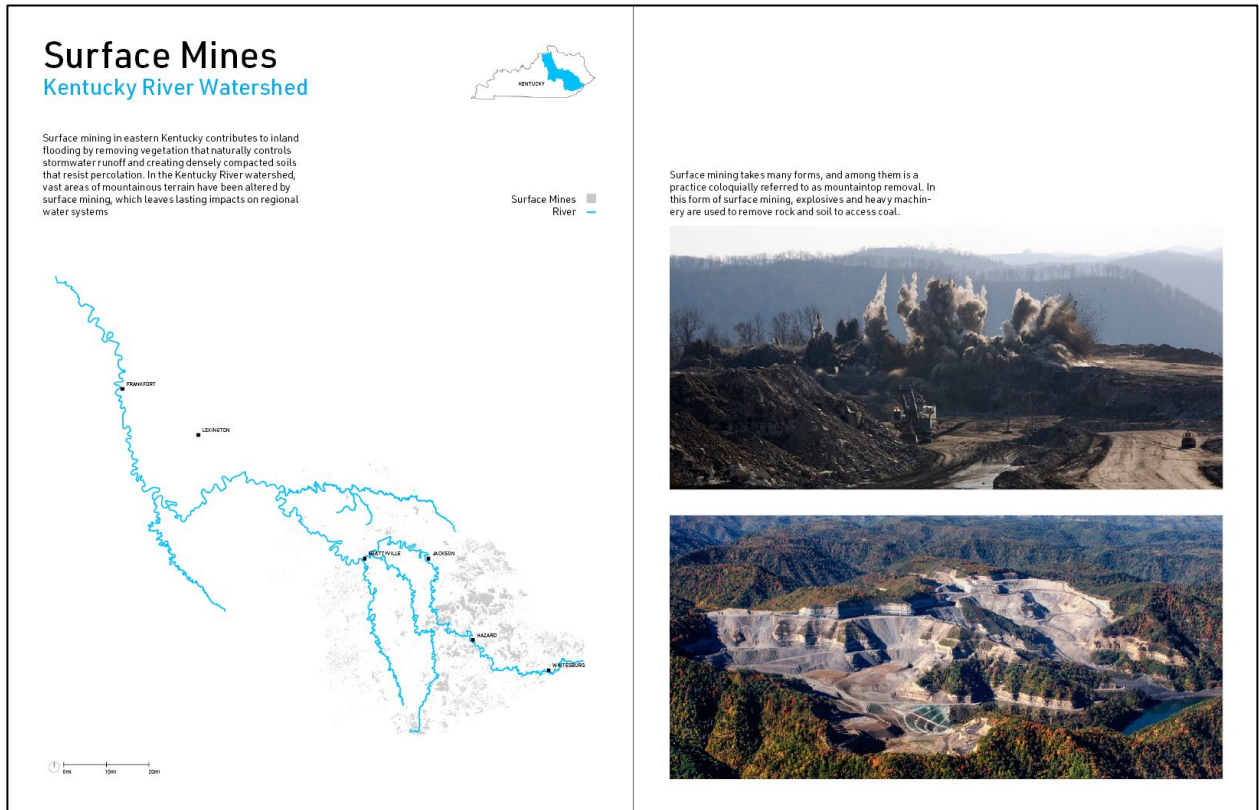

Figure 2: Sample spread from *Troublesome Creeks* atlas showing extent of surface mining in the Kentucky River watershed. (Authors 2022)

1.3 Post-Industrialization

Central Appalachia has a direct connection to the same deindustrialization cycle that resulted in significant population decline in North American Rust Belt cities. The Eastern Kentucky Coal Field generates bituminous coal, which was the preferred fuel for steam locomotives and later for steel production. Today, most Kentucky coal is used for energy production. As coal rightly falls out of favor for electricity generation, there is not a self-evident emerging market. Meanwhile, Appalachian coal deposits are significantly depleted, absent new technology (KEEC 2017).

Central Appalachia is part of a global phenomenon of post-industrial shrinkage, archived in the *Shrinking Cities Project*, led by Phillip Oswalt. Oswalt articulated that not all places shrink for the same reasons, but did generalize four categories of causation: destruction through disaster; loss (including depleted natural resources and unemployment); shifting population; and demographic change (Oswalt et.al. 2006).

Oswalt, among others, has articulated that contemporary design and planning have scarce tools available to them to address an emerging post-industrial landscape brought about by the Anthropocene (Oswalt 2005, Lynch 1972). Both neoliberal and socialist policies are premised on growth. Architecture has long defined itself by the creation of the new, even within the premise of “renovation.” A design agenda for shrinking cities demands something different. Per Oswalt:

Shrinking Cities question existing social practices, values, and models and this call for a fundamental cultural reflection and reevaluation: Is urbanism conceivable without destiny? Can slowness itself represent quality? What role does property play in the use of space? Can unused spaces and materials be used in different ways? Are there informal practices that can be read as positive models for action? How do mentalities and identity crises influence urban space? (Oswalt 2005, 15)

Perhaps the most challenging aspect of shrinking cities is that it undercuts expertise and technocratic solutions. A flood appears to be an engineering solution consisting of seemingly self-evident conclusions that these communities should just move, surround themselves with floodwalls, or disband altogether. Such technocratic approaches too often disenfranchise communities, reinforcing a political perspective that government does not serve their interests, and they

are on their own. Furthermore, the region's political leadership has been reluctant to discuss the underlying cause of the disaster—climate change—due to the historical role of fossil fuels in the economy.

How might we begin to answer the questions posed by Oswalt as it pertains to Central Appalachia?

Narratives describing the socio-economic challenges of Appalachia proliferate in national media and have shaped a misaligned popular perception. Along with the tribal lands of the Upper Midwest and Southwest and the Black Belt of the Deep South, many Appalachian counties remain the poorest in the nation, a legacy of extractive industries. What is less commonly known, both nationally and regionally, is the re-emerging vitality of many Appalachian towns—new restaurants, breweries, coffeehouses, arts centers, and even population growth in some communities. However, catastrophic flooding in recent years laid bare the emerging threat of climate change to communities often left out of conversations about climate resilience and adaptation. While floods are a way of life to some extent in all mountainous regions, the frequency and severity of flooding has demonstratively increased, threatening a nascent transition to a post-coal economy in the region.

It is our assessment that climate resiliency in Appalachian Kentucky cannot be articulated from afar and certainly not without engaging the robust social, cultural, and intellectual capital found in the community. The stakes are too high to resort to combative positioning. One method for laying the groundwork for community co-creation is through compiling and visualizing information in a critical manner accessible to those outside of the design community.

2.0 METHODOLOGY

2.1 The Atlas as Critical Method

The changes brought about by widespread socio-economic and climatic shifts amount to a regionally scaled design brief that affects the vast majority of built infrastructure in Appalachia. A design brief of this magnitude requires more than a site plan of existing conditions or a list of programmatic requirements. As populations and environments shift in communities around the world, the atlas has seen a recent resurgence. Originally created as a navigational aid to further colonialist ambitions, the atlas now serves as a tool for understanding dramatic social, economic, and environmental change.

In a recent essay, media scholar Shannon Mattern examines these new atlases and poses a critical question:

How might the atlas—obviously not a new media form but certainly one that can be reimagined for the Anthropocene—serve today to capture and preserve the world's 'vanishing' (or intentionally 'vanished') landforms, life-forms, and languages before they, too, disappear? (Mattern 2022)

In addition to using the atlas as a tool for reimagining the built environment in the Anthropocene, others have further experimented with the format. Designer Joost Grootens creates atlases that serve as a contemporary stock-taking at both metropolitan and global scales (Grootens 2004). At the metropolitan scale, Rebecca Solnit goes beyond stock-taking to unearth the many hidden layers that shape urban life (Solnit 2019). At the regional scale, the *Third Coast Atlas* and *Many Norths* reframe the geographical imagination around built infrastructure (Ibanez et al. 2017; Shepard and White 2017), and in a related effort, a series of cultural atlases question regional identity (Banis and Shobe 2015, Hatfield et al. 2018, Shobe et al. 2021). The resurgence of atlases portends a radical reimagining of the built environment in light of a drastically changing climate. In Appalachia, *Troublesome Creeks* contributes to this reimagining by confronting the increasingly impactful role of water in shaping the built environment.

2.2 Atlas Content

While the diverse communities of Appalachia continue to demonstrate great resilience in the face of catastrophic climate change, the increasing frequency and intensity of flooding has shown the built environment to be quite vulnerable. Moreover, the vulnerability is not experienced evenly among these communities, most severely impacting those with access to the fewest resources. In order for communities in Appalachia to adapt equitably to the changing climate, the built environment must reframe its relationship to water. To this end, *Troublesome Creeks* frames the built environment in Appalachia through a hydrological lens. Rather than focusing on county lines, the most prominent political boundary of the region, the atlas takes as its organizational device the river valleys where most of the historic settlement patterns are concentrated.

Each section of the atlas is defined by a watershed. Within these watersheds is a series of maps that depict tangible features, including building and transportation infrastructure, water and water infrastructure, and land surface cover. Each watershed also includes maps of intangible features that include population change, median age, and median household income. These tangible and intangible features are shown in more detail through a series of highlighted areas within each watershed, where a spatial analysis of historic flood events shows which communities have experienced the greatest impacts.

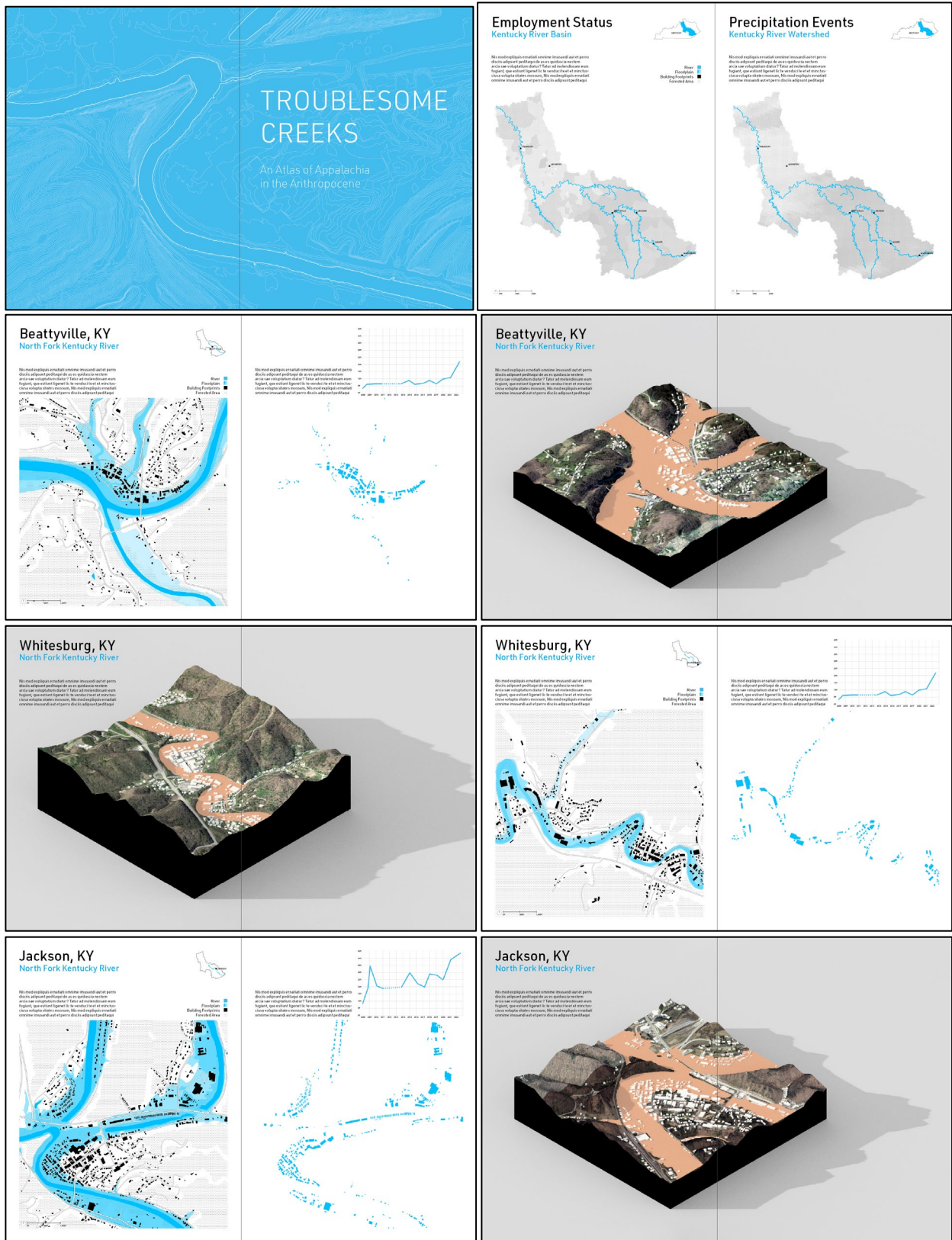

Figure 3: Preview of *Troublesome Creeks* atlas showing multilevel data visualizations and spatial analysis.(Authors 2022)

CONCLUSION

Troublesome Creeks aligns the spatial imagination of Appalachia with the growing power of water to impact these spaces. The atlas shifts the representation of geographic space from the intangible boundaries that govern political

activity to the very real hydrological boundaries that increasingly affect everyday life. By reframing the perception of these spaces, *Troublesome Creeks* serves as a tool for planning and design that works with, not against, water. However, as with all planning and design efforts, there exists an opportunity to either deepen existing social inequities or reverse course and actively work toward justice. In this way, the atlas assembles visual representations of the communities most acutely affected by climate change, and those least equipped to recover from its catastrophic effects. At the same time, *Troublesome Creeks* points toward a future in which living with water in Appalachia no longer invokes fear or trepidation, but rather, a renewed sense of radical possibility.

REFERENCES

- Banis, David and Hunter Shobe. 2015. *Portlandness: A Cultural Atlas*. Seattle, WA: Sasquatch Books.
- Britton-Purdy, Jedidiah. 2016 "The Violent Remaking of Appalachia". *The Atlantic*. March 21, 2016.
- Caudill, Harry M. 1980. "Oral Traditions Behind Some Kentucky Mountain Place Names." *The Register of the Kentucky Historical Society* 78, no. 3 (1980): 197–207. <http://www.jstor.org/stable/23378758>.
- Environmental Protection Agency. 2016. "What Climate Change means for Kentucky" U.S. Environmental Protection Agency. <https://19january2017snapshot.epa.gov/sites/production/files/2016-09/documents/climate-change-ky.pdf>
- Grootens, Joost and Arjen Van Susteren. 2004. *Metropolitan World Atlas*. Rotterdam: 010 Uitgeverij.
- Hatfield, Tera, et al. 2018. *Seattleness: A Cultural Atlas*. Seattle, WA: Sasquatch Books
- Hoyt, Lorlene, and André Leroux. 2007. *Voices from Forgotten Cities: Innovative Revitalization Coalitions in America's Older Small Cities*. Policy Link, 2007. <https://www.policylink.org/resources-tools/voices-from-forgotten-cities-innovative-revitalization-coalitions-in-americas-older-small-cities>
- Ibanez, Daniel, et al., eds. 2017. *Third Coast Atlas: Prelude to a Plan*. New York: Actar.
- Kentucky Energy and Environment Cabinet and Kentucky Coal Association. 2017. "Kentucky Coal Facts: 17th Edition" Department for Energy Development and Independence. [https://eec.ky.gov/Energy/Coal%20Facts%20%20Annual%20Editions/Kentucky%20Coal%20Facts%20-%2017th%20Edition%20\(2017\).pdf](https://eec.ky.gov/Energy/Coal%20Facts%20%20Annual%20Editions/Kentucky%20Coal%20Facts%20-%2017th%20Edition%20(2017).pdf)
- Lynch, Kevin. 1972. *What Time Is This Place?* Cambridge: MIT Press.
- Mattern, Shannon. 2022. "Terra Perdita: Mapping Lost Landscapes," *Avery Review* 55 (January 2022)
- National Park Service. (undated) "Geology and History of the Cumberland Plateau." U.S. Department of Interior. <https://www.nps.gov/biso/planyourvisit/upload/webgeo.pdf>
- National Weather Service. 2022. "Historic July 26th-July 30th, 2022 Eastern Kentucky Flooding" U.S. Department of Commerce (2022) <https://www.weather.gov/jkl/July2022Flooding>
- Oswalt, Philipp; Tim Rieniets, ed. Grafik: 1 kilo (Firm) and Kulturstiftung des Bundes. 2006. *Atlas of Shrinking Cities*. Ostfildern Maidstone: Hatje Cantz; Amalgamated Book Services.
- Oswalt, Philipp. 2005. "Introduction." In *Shrinking Cities*. Vol. 1, edited by Philipp Oswalt, 12-17. Ostfildern-Ruit [Germany]: Hatje Cantz.
- Oswalt, Philipp. 2005. "Introduction." In *Shrinking Cities*. Vol. 2, edited by Philipp Oswalt, 13-18. Ostfildern-Ruit [Germany]: Hatje Cantz.
- Ross, Matthew R. V., Brian L. McGlynn, and Emily S. Bernhardt. 2016. "Deep Impact: Effects of Mountaintop Mining on Surface Topography, Bedrock Structure, and Downstream Waters" *Environmental Science & Technology* 50 (4), 2064-2074. DOI: 10.1021/acs.est.5b04532 <https://pubs-acsc-org.ezproxy.uky.edu/doi/full/10.1021/acs.est.5b04532>
- Ryan, Brent D. 2012. "'The Burden Has Passed': Urban Design After Urban Renewal." In *Design After Decline: How America Rebuilds Shrinking Cities*, 1–36. University of Pennsylvania Press, 2012. <http://www.jstor.org/stable/j.ctt3fxbxm.4>.
- Sheppard, Lola and Mason White, eds. 2017. *Many Norths: Spatial Practice in a Polar Territory*. New York: Actar.
- Shobe, Hunter, David Banis, and Zuriel van Belle. 2021. *Upper Left Cities: A Cultural Atlas of San Francisco, Portland, and Seattle*. Seattle: Sasquatch Books.
- Solnit, Rebecca, Joshua Jelly-Schapiro, and Rebecca Snedeker. 2019. *Infinite Cities: A Trilogy of Atlases—San Francisco, New Orleans, New York*. Berkeley: University of California Press.
- Stone, May. 1974. "Origin of Names of Places and Streams In Some Eastern Kentucky Counties." *Appalachian Heritage* 2, no. 4 (1974): 30-34. doi:10.1353/aph.1974.0069.
- U.S. Army Corps of Engineers Institute for Water Resources. 2017. "Ohio River Basin: Formulating climate change mitigation/adaptation strategies through regional collaboration with the ORB Alliance" U.S. Army Corps of Engineers. <https://usace.contentdm.oclc.org/digital/collection/p266001coll1/id/5108/>

ARCC 2023 RESEARCH PAPERS
Health & Well-being Track

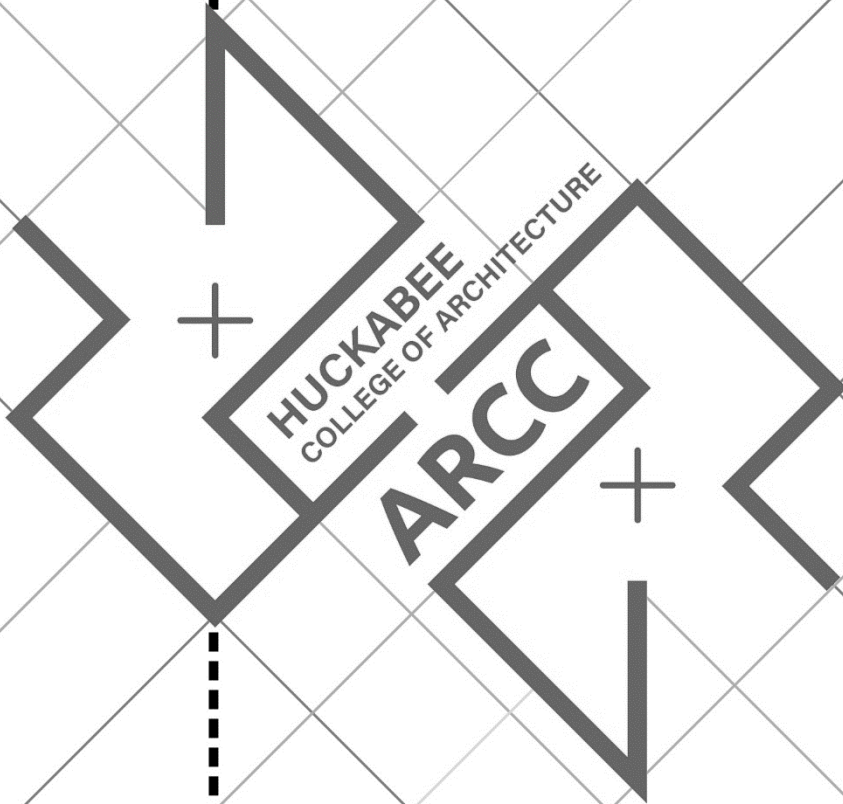

A Biology-Architecture Collaboration: Integrating Biological Concepts with a Bio-Inspired Design Process

Mary Guzowski¹, Emilie Snell-Rood², William Weber¹, Dimitri Smirnoff³

¹School of Architecture, University of Minnesota, Minneapolis, MN

² Department of Biology, University of Minnesota, Minneapolis, MN

³ Department of Curriculum and Instruction, University of Minnesota, Minneapolis, MN

ABSTRACT: This paper explores a collaboration between architecture and biology educators to integrate core concepts of biology with a bio-inspired architectural design process. Bio-inspired design looks to biology for inspiration to expand design thinking, methods, and strategies. Given today's ever-increasing ecological challenges, designers can benefit from the expertise of biologists and the biological lessons of other species. In this paper, a six-step design process adapted from engineering is integrated with core concepts of biology, including the ideas of function, biodiversity, and evolution. This integrated process explores how the concept of function serves as a bridge between human challenges and different areas of biology, while simultaneously helping to overcome the limits of simply copying biological traits. Tools are offered to explore biodiversity and the tree of life for biological models that can inform design ideas, stressing the importance of sampling different parts of the tree, as diverse organisms often solve a given problem in different ways. Bio-inspired design shifts the perception of architecture being an object toward exploring architecture as an action. This concept is described in this paper as "biologizing". The integration of the biological concepts with the adapted six-step design process is illustrated through an example conceptual design of a cold-climate, south-facing building envelope. The findings of the study illustrate biological and design lessons for educators and practitioners, as well as the next steps for bio-inspired design research and education.

KEYWORDS: Architectural Education, Bio-Inspired Design, Biomimetic Design, Sustainable Design

INTRODUCTION

This paper investigates a design-research collaboration between evolutionary biology, curriculum instruction, and architectural design at the University of Minnesota to enhance and test a six-step bio-inspired design process integrated with core concepts of evolutionary biology. It brings evolutionary biologists' expertise into the architectural design process to increase the range and depth of biological knowledge and to ground designers in accurate biological concepts and methods to translate into architectural design. Given today's ever-increasing ecological challenges, designers can benefit from the expertise of biologists and the biological lessons of other species. A significant body of research has been developed on bio-inspired and biomimetic design processes encompassing diverse disciplines, such as robotics, product design, biology, and architecture (Fayemi et al. 2016, 2017; Graeff et al. 2019; Cruz et al. 2020; Dixit and Stefanska 2023). This research builds on the analogy-based approach to design with biological systems as a source of inspiration (e.g., Fu et al. 2014). The research discussed in this paper investigates:

- 1) Why and how core biological concepts (e.g., function, biodiversity, and evolution) can enhance a bio-inspired design process,
- 2) How a six-step design process could integrate with the core biological concepts, and
- 3) How biological models can be abstracted and translated into architectural design.

The paper discusses the process and outcomes of testing the integrated concepts with the six-step bio-inspired process for the conceptual design of a cold-climate south-facing building envelope.

1.0 FRAMING THE PROBLEM: BIOLOGY - ARCHITECTURE INTERFACE

Bio-inspired design frameworks – such as biomimetic, biomorphic, biophilic, bioclimatic, and others – look to biological models, processes, and systems for strategies to expand design thinking in response to the ecological challenges of our day (Bhushan 2009; Fayemi et al. 2016, 2017; Snell-Rood and Smirnoff 2023, in review). While biologically based design frameworks have sought inspiration from biology, they often rely on approaches from design processes more than on concepts from biology. In contrast, the approach discussed in this paper integrates three core biological concepts with a six-step *Bio-Inspired Design Process* that was adapted from a *Biomimetic Process* developed by engineers Pierre Emanuel Fayemi et al. (2017). The design process has been reframed from "biomimetic" (mimicking biology) to "bio-inspired" (drawing design inspiration from biology) to provide greater flexibility to designers in translating biological frameworks beyond biomimetic design (Fish and Beneski 2013) - a concept described here as "biologizing" (Baumeister et al. 2014; Brownell and Swackhamer 2015). The six-step process represents a sequence of iterative design explorations that guide a practitioner as they integrate the human design space and the biological space (Figure 1). The core concepts from biology include biological function, biodiversity across the tree of life, and evolution. The integrated concepts and six-

step design process enable designers to translate the design challenge more accurately into biological terms, deepen the biological accuracy, and structure the translation of biological strategies into design concepts.

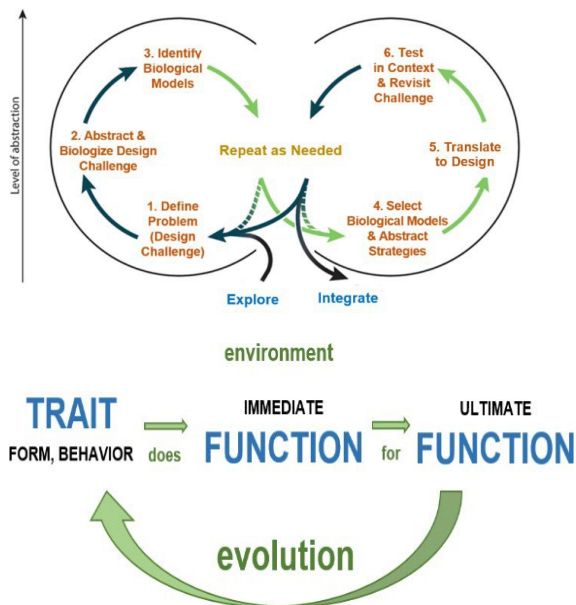

Figure 1: Left: Six-step bio-inspired design process. Adapted from Fayemi et al, 2017. Source: (Authors 2022)

Figure 2: Right: Schematic of core concepts in evolutionary biology that inform a bio-inspired design process. Source: (Authors 2022).

2.0 THREE CORE BIOLOGICAL CONCEPTS FOR THE BIO-INSPIRED DESIGN PROCESS

2.1. Overview of Core Biological Concepts

The six-step design process is enhanced by the integration of core concepts from biology to enable designers to use biological strategies, processes, or systems more effectively. The concept of function serves as a bridge between human challenges and different areas of biology (Vincent and Mann 2022; Baumeister et al. 2014; Roth-Nebelsick 2022). Tools are used to explore the tree of life for models that can inform design ideas, stressing the importance of sampling different parts of the tree as diverse organisms often solve a given problem in different ways (Penick et al 2022). Finally, we illustrate how a problem can be distilled to key environmental challenges that allow exploration of different geographic regions for ideas. We argue that the diverse challenges of a bio-inspired design process can be overcome by incorporating more biology – and collaborations with biologists – into the design process (Graeff et al. 2019). Here, we start by introducing core concepts from evolutionary biology and ecology as a first step (Snell-Rood and Smirnov 2023, in review). We do not suggest that architects become biologists, but rather focus on key concepts that bridge biology and architecture, while acknowledging the limits of this process.

Biology provides a staggering range of traits and behaviors that we can draw on for inspiration. Traits are physical parts of an organism that contribute to how they perform in their environment, such as a bright feather attracting a mate, or a sharp spine defending against a predator. Behavior considers how an organism's traits are put into action to deal with their environment, for instance a beak cracking a seed, or a sweat gland releasing perspiration. Over time, traits and behaviors evolve in response to interactions with the environment.

With over 1.5 million described species among a likely 10 million species on earth, we have many traits to look at for inspiration. Through evolution by natural selection, biological systems adapt to their environments as trait variants that do well are amplified, while those traits that perform poorly tend to disappear. How do we search the millions of biological traits on earth for inspiration? The concept of function provides an essential connection between biology and architecture. Function in biology can refer to what a trait is immediately doing for an organism. However, function can also refer to the contribution of that trait to the organism's survival and reproduction – a beak is cracking a seed to obtain nutrients to grow and reproduce (Wouters 2005). This ultimate or longer-term function explains how that trait came into existence over evolutionary time and can contrast with the trait's immediate function, which is often what we are trying to “analogize” and translate in bio-inspired design (Figure 2)

While evolutionary processes can produce a wide array of adaptations that solve environmental challenges in creative ways, these processes are limited by available variation. In other words, “what comes before” may bias “what comes after”. This means that traits are not necessarily optimized and are generally only incrementally better than what came just before, as we see in the larger concept of evolution by natural selection (Fish and Beneski 2014). Fortunately, as designers, architects are not limited by the same processes: biology can be a source for creative ideas, but designers

can pick and choose across systems, species, and traits for design concepts. The most effective way to increase this pool of inspiration is to sample for ideas widely across the tree of life and the globe. Doing so increases the chances of finding organisms that accomplish the same function, but in different ways, some of which may be appropriate for the desired application (Penick et al. 2022). As discussed below, we encourage designers to consider biodiversity in terms of species that represent different branches of the tree of life, and that represent different geographic areas across the globe. Evolution has been moving along independently in separate branches and separate locations, increasing the chances that the designer will end up with a diversity of ideas (Hund et al. 2023).

3.0 TRANSLATING CORE BIOLOGICAL CONCEPTS TO ARCHITECTURAL CONCEPTS

We can draw parallels from core concepts of biology to make analogies with design challenges in architecture. In a design process, we might focus on an object or process that is analogous to a biological trait. We can consider the immediate function of this object or trait - what is being performed by an organism's trait that solves a challenge the organism faces in navigating its environment. This biological concept encourages designers to shift from focusing on the "object" (a shading device, for example) to the function of what the object is "doing" (mediating heat or light). Immediate function can be viewed through different lenses, including the *function* of the physical form and shape (building massing, section, details), a *process* (generate electricity, provide ventilation, harvest sunlight for heat); a *material attribute* (absorb heat, reflect light, insulate); or *behavior* (foster an occupant's seasonal interaction with the building, respond to changing luminous conditions, connect to nature). After considering the immediate function of a trait or design element, we might consider its ultimate function (Wouters 2005) – the purpose of a design feature or element in relation to physical, social, cultural, and environmental contexts – such as the building users, program, structure, or systems. This is analogous to thinking about the ultimate function of a biological trait in terms of how it contributes to survival, reproduction or fitness, and thus its long-term persistence (e.g., architectural shelter, protection from the elements, life safety, etc.).

There are also parallels between the concepts of environment, evolution, and diversity in biology and in architecture. Many of the same biotic and abiotic forces that influence how organisms perform in their environment also apply to buildings, with such performance being highly dependent on variations over space and time. Such variations in the environment create diverse selections for different versions of a trait or feature, leading to the emergence of different architectural traits or design elements over time. Diversity in biology captures the millions of species on earth, their patterns of relatedness, and a consideration of how their forms and behaviors have evolved in response to their environments. Diversity in architecture includes variation in building elements and structures to deal with local environmental challenges, including selection pressures based on human and cultural preferences in what is considered aesthetically pleasing, novel, or trendy. From an architectural approach, evolution could focus on a progressive generative process relying on feedback within a system to select a "best fit solution" stemming from intentional or accidental means. It could also consider the chronological and spatial interconnections between humans and other species and living systems. Such evolutionary design will engage with dynamic environmental, social, and cultural conditions, leading to design solutions for adaptation, flexibility, and transformation at any scale (site, envelope, rooms, details); as well as addressing the needs of various users and spatial configurations in time.

4.0 A BIO-INSPIRED DESIGN PROCESS FOR CONCEPTUAL DESIGN

The integrated concepts and bio-inspired design processes discussed above were tested on the conceptual design of a cold-climate, south-facing building envelope. The envelope example explored how biological lessons might inform design responses to the dynamic and changing thermal conditions for seasonal heating (seasonal cooling to be considered in the future). Example conceptual envelope design outcomes are included to illustrate the biologically-integrated design process and will be further developed and tested with explicit design and sustainability performance criteria in subsequent studies.

4.1. Step 1: Define the Problem (Design Challenge) - Function

The first step in the *Bio-Inspired Process* is to clarify the problem and design challenge. It is useful to develop a variety of possible design questions and to subdivide the exploration into a series of related investigations targeting different issues and scales. This step identifies the challenge(s), scale(s) of inquiry, and building or construction functional issue(s) the design is going to address. An exploration of function is essential in determining the scope of this step.

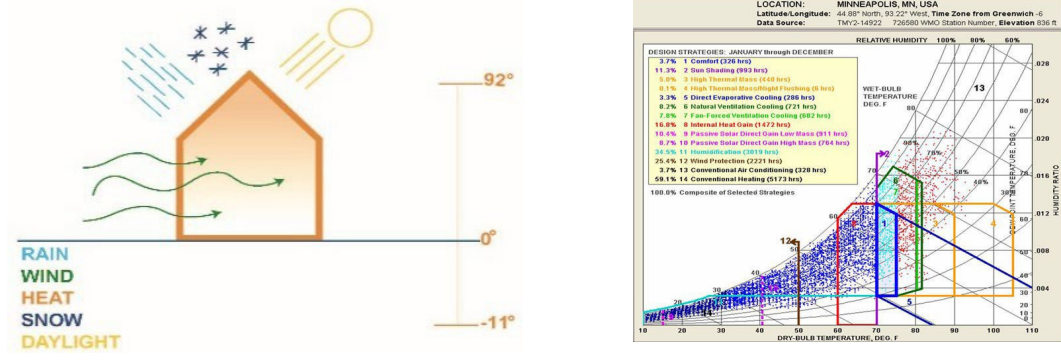

Figure 3: Step 1 Example: Left: Design challenges for cold climate design: extreme seasonal temperatures, humidity, precipitation, wind, solar radiation, daylight. Source: (D. Banker, Research Assistant 2022) Right: Minneapolis psychrometric chart (Source: Climate Consultant).

In the example, for the design of a cold-climate, south-facing building envelope in Minneapolis, the identified design challenge focused on how the envelope could respond to the dynamic and dramatically changing seasons and environmental forces (extreme seasonal temperature change, humidity, solar radiation, moisture, precipitation, winds, etc.) (Figure 3). Although the environmental conditions are dynamic, it is common that cold-climate envelopes in Minnesota are predominantly static (with non-operable windows in most commercial and institutional buildings). We asked specifically: How might the envelope design mediate between the dynamic exterior forces and dynamic interior conditions for specific envelope functions (seasonal change for heating, cooling, ventilation, lighting, views, privacy, connection to site, etc.) and performance metrics (energy, carbon, comfort, program activities, etc.)? The following steps were used to define the design challenge:

4.1.1. Step 1 Example: Define the Design Challenge for a Cold-Climate South-Facing Building Envelope

- *Identify the problem:* What are the design challenges of a cold-climate building envelope? How does the envelope respond to extreme environmental conditions?
- *Explore parallel questions (broad and narrow):* The broader questions can be narrowed into more targeted questions: How does the envelope regulate temperatures (heat, cold, humidity, light, dynamic conditions, etc.)?

4.2. Step 2: Abstract and Biologize the Design Challenge - Function

In the next step of the bio-inspired design process, we take aspects of the problem analysis and “biologize” the design challenge (Baumeister et al., 2014), seeking analogies from the discipline of biology. For instance, if we are interested in exploring lighting options, we might want to investigate how a light bulb might translate to biology. To facilitate this, we select verbs associated with how light moves through the environment (such as illuminate, reflect, absorb, or refract) to facilitate the search process for biological analogies. As another example, if we are interested in how to design a building envelope to deal with mold, we might think of verbs such as: inhibit growth, repel moisture, or kill microbes. Biologizing the problem is the first step in using function as a bridge between design and biology. It’s helpful to expand this list of biologized verbs into as many different functional search terms as possible. These search terms can then be used to identify potential biological models for design. Questions related to function are essential to consider during the abstraction and biologizing process. For the building envelope example, we narrowed the focus to how the envelope “regulates temperature” during the winter months.

4.2.1 Step 2 Example: Abstract & Biologize the Envelope Question

- *Select one question to narrow the design focus:* How does the envelope regulate temperature in winter?
- *Identify “functional priorities” and abstract the design challenge:* What does an envelope need to do in winter? Translate envelope elements to the function they perform (shift from nouns to verbs: cladding=shelters; vapor barriers=block, shading=filters, glazing=admits, insulation=resists, etc.; Figure 4).

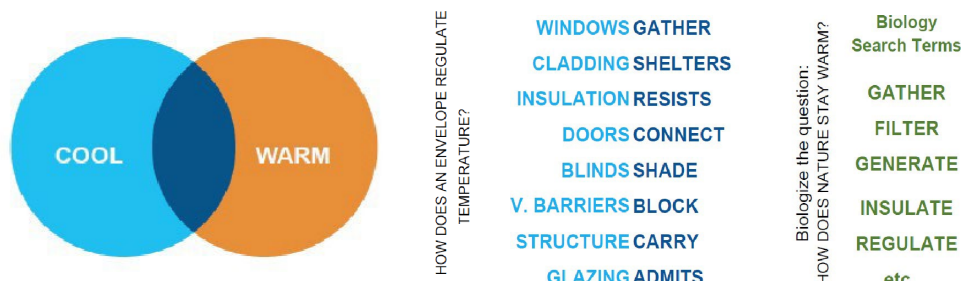

Figure 4: Step 2 Example: Abstracting and biologizing the envelope question. Source: (Authors 2022)

- *Biologize the Question:* How do organisms stay warm?

- **Generate related biology “search terms” (verbs) using the Biomimicry Taxonomy** (Biomimicry Institute 2008).
 - **Abstract the design issue:** Develop phrases that distill the biological lesson for the design process to prompt new thinking. The “abstracted design principle” should: 1) contain the most essential information, 2) be biologically accurate, and 3) use terminology that is relevant and recognizable for an architect (Baumeister et al. 2014).
 - **Consider different biological lenses to generate functional search terms:** 1) **Form:** How do organisms in nature absorb, gather, or reflect heat? 2) **Process:** How do organisms in produce or regulate heat? 3) **System:** How do organisms in nature manage heat at a system or ecological scale? and 4) **Material:** What materials are used to gather, generate, regulate heat?
- **Organize the Biological Search Terms for the next step:**
 - **Question:** How do organisms stay warm in nature?
 - **Search Terms:** How do organisms in nature manage, respond to, produce, capture, filter, absorb heat, etc.?

4.3. Step 3: Identify Potential Biological Models - Function & Biodiversity

Once we have a list of biological functions, we can start to move into the biological space, finding organisms that do analogous things in their own environment. There are a few ways to start exploring biological models. First, we can make use of existing bio-inspired design databases, like *AskNature*, which have a curated database of *biological traits*, classified by *functional terminology* useful for design (Figure 5) (Biomimicry Institute 2022). We can branch out further by delving into the biology literature, using databases such as *Web of Science* or *Google Scholar*. Here, search terms that include typical jargon of the field can be useful. For instance, the term “beak morphology” will yield more hits than “beak shape”. This is where collaborations with biologists can be a great benefit, as they can help identify the types of systems, traits, environments, and appropriate terminology to search for biological ideas.

At this step in the process, it is beneficial to identify a wide range of biological models to increase the chance of finding a good match to the design challenge. First, look at how diverse organisms accomplish the same function. If unrelated organisms have evolved the same function, but followed different evolutionary paths, there is a good chance that how they accomplish this function – the underlying mechanism – varies in some way, which can provide diverse ideas for design.

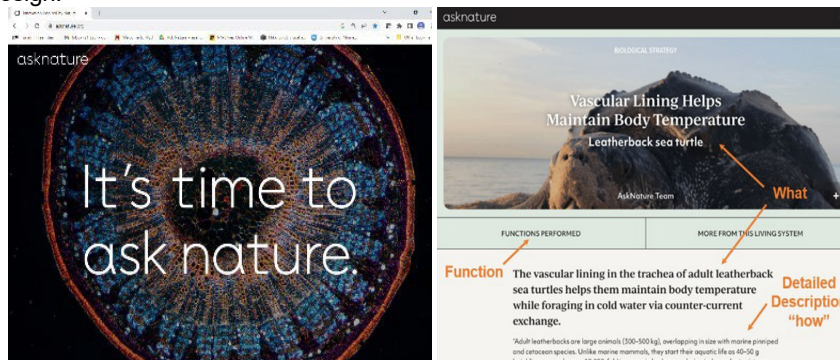

Figure 5: Left: Step 3 Example: *AskNature*: How leatherback sea turtles stay warm. Source: (Biomimicry Institute 2022)

Figure 6: Right: Tree of life showing relationships of animals that have adapted to cold environments, or not. In the “bird branch,” some ducks and penguins thrive in cold environments. In the insect branch, some Icelandic midges, and high-altitude bees can fly in freezing conditions. In the plant branch, species survive winter by going dormant, or reducing activity. Source: (Vivera Design, Adapted by Authors 2022)



Consider that an apparent function might fulfill a different ultimate function (see Figure 2; Snell-Rood and Smirnov 2023, in review). For instance, temperature regulation is a secondary function for butterfly wings, which have evolved scales that absorb sunlight, but do so to release pheromones more than to warm the organism (Krishna et al 2020). An architectural parallel might be how temperature, solar radiation, and light are interrelated.

To increase the biological diversity of possible design models, search across the tree of life as broadly as possible (Figure 6). The further apart a pair of species on the tree of life, the more likely that a given function is met through different mechanisms, which will provide the designer with the broadest possible set of biological traits that might be translated to the design. *Wikipedia* has a handy bar on the right-hand side of organism entries that shows current classification and *iNaturalist* is another valuable resource.

Finally, consider the environmental context, or ecology, of the desired functions – what abiotic and biotic variables are relevant to the design challenge and what other geographic areas or ecosystems experience such conditions? For instance, in dealing with cold temperatures, consider not only Arctic environments, but also alpine environments, or night-time temperature swings in deserts. Within each type of biome or ecosystem, there are independent replicates across the globe with distinct biological communities that can provide lessons for design (for notes on process in the classroom, see Hund et al. 2023, Snell-Rood and Smirnov 2023, in review).

For the envelope example, we used a variety of temperature-related search words related to “how nature stays warm”, including: How does nature regulate temperature, gather heat, generate heat, capture heat, absorb heat, etc. (Figure 5). The biologists helped in selecting a range of potentially relevant models to consider in subsequent steps:

4.3.1. Step 3 Example: Identify Biological Models Related to Envelope Functions and Biodiversity

- *Carry forward the biologized question:* How do organisms stay warm in nature?
- *Use AskNature and “biological search terms” to find biological models:* Explore biological models for the identified functional search terms (e.g., gather, reflect, generate heat, etc.). Explore the search for different functions and traits across the tree of life (evolutionary time) and for different biomes (evolutionary space).
- *Document many biological models:* Organize select biological models using screen captures images, words, etc.

4.4. Step 4: Select Biological Models & Abstract Biological Strategies - Function, Biodiversity & Evolution

After generating a list of possible biological systems to consider with respect to the design challenge, the next step is to move from the list of design criteria and identified biological models to the ones that are most appropriate for more detailed study and application (Figure 7). The first step is to consider whether any are a better match to the challenge. This may be a question of scale, materials, or the fit of the analogy. For instance, physical properties often play out differently at nano scales versus macro scales and moving from one scale to another is not possible – in which case a different biological system that matches the scale of the application (e.g., nano to nano or macro to macro). In other cases, the physical properties of the materials need to match, for instance, when filtering air in an application, some aspects of water filtration may apply, but looking at air filtration may be more relevant to the design inquiry.



Figure 7: Left: Step 4 Example: Selection of biological models and narrowing of models based on design criteria (how nature regulates temperature to stay warm). Source: (D. Banker, Research Assistant 2022)

Figure 8: Right: Step 4 Example: Six biological models to study in detail based on design criteria. Source: (D. Banker, 2022)

The next step is to consider the range of functions that apply to a biological system and determine how these may relate to tradeoffs associated with the traits that support the functions. Most biological traits do more than one thing for the organism. A butterfly wing may absorb light and heat to rapidly waft pheromones to attract a mate, but it also repels water and permits flying. In some cases, evolutionary selection in one context may constrain how selection in another context operates and the trait may not be “optimized” for the function a designer is most interested in. For instance, the heat-absorbing function of the butterfly wing would presumably be of more interest to the designer than would the dispersion of pheromones (Snell-Rood and Smirnoff 2023, in review).

Once the biological systems being studied for inspiration have been narrowed, the next step is to delve deeper into the biological literature. In many of the biological sciences, researchers work to generate a mechanistic model, or working hypothesis, that relates “trait form to function”. In other words – can we draw a diagram of how the trait works (Table 1)? In many cases, we understand how a biological trait works, and it’s just a matter of finding it in the literature. For instance, the basic model for a bird beak crushing a seed is a lever system imposed on a bird skull. Other adaptations in terms of internal beak structure or skull shape are often layered on top of this basic understanding. Here, the designer might draw a diagram of a lever system that is moderated by other adaptations in the system and use this as the abstraction for the biological strategy. In some cases, it may be obvious that a trait is related to some function of interest, but as we learn more, we realize that it is not completely understood just how that trait works. In this case, the abstraction of the biological strategy may currently be a “best guess” or simply in need of more study, in which case the designer may opt to move on to a new system, or perhaps partner with a biologist to study the trait in more detail

In the envelope example, Figures 7 and 8 illustrate the process of moving from “many to one” for the biological model. The biological traits and mechanisms used to stay warm were studied for six species and eventually narrowed to one species (the emperor penguin). The biologists selected the top six models and recommended the emperor penguin because the problem (dealing with cold) and the scale (macro versus nano) match the design challenge. In addition, multiple adaptations in the penguin to an extremely cold climate are well understood and studied sufficiently to provide the detail necessary to abstract biological traits of the penguin into design strategies.

The biological mechanisms and traits that provided warmth were further researched. In addition to function and biodiversity, evolution was considered in how the biological traits respond to varying environmental and behavioral conditions. A detailed investigation of the feathers and wings of the emperor penguin was developed and translated into conceptual design ideas. Table 1 provides an example of the process used to clarify the functions, traits, and mechanisms used by the emperor penguin’s feathers and wings to stay warm. Based on these strategies, envelope design concepts were developed. The steps below describe the process used to curate and abstract the biological strategies for design.

4.4. Step 4 Example: Curate and Abstract the Biological Strategies to Inform Design

● *Evaluate the strategies of select biological models based on design criteria and function, biodiversity, and evolution:* Evaluate the biological models from Step 4 based on the identified design challenge and problem (staying warm). Identify the biological traits and mechanisms to achieve the function (staying warm). Consider functions across different species in the tree of life (evolutionary time) and different biomes (evolutionary space).

● *Select and organize biological models for design:* Select the most relevant biological models from Step 4 and translate into the design process (example Table 1). Consider different biological lenses (form, process, system, and materials). Use diagrams, sketches, narrative texts, or other means to identify and organize the biological strategies to inform and translate into conceptual design scenarios in the next step (Figure 9).

Table 1: Step 4 Example: Curation and abstraction of the mechanisms of the emperor penguin’s feathers and wings. Source (Authors 2022)

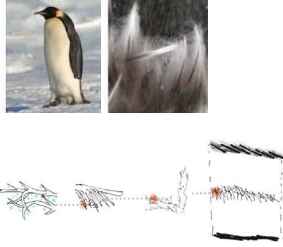
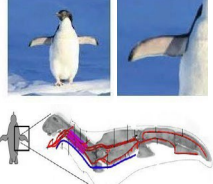
Biological Model	Biological Mechanism: How the trait works to accomplish the function	Diagrams	Envelope Design Translation
<p>EMPEROR PENGUIN TRAIT: FEATHERS</p> <p>FUNCTION: Protect from temperature</p>	<p>AskNature: https://asknature.org/strategy/feathers-trap-air-to-provide-warmth/ Dynamic feathers: regains loft after compression. Short stiff feathers evenly packed across surface. Outer “pennaceous” (vane region) and “downy” inner after-feather. Moveable: muscle attached to compress under water or make feathers erect on land. Overlapping vanes (like overlapping tiles) Deeper insulating layer: “barbules” with “cilia”; attachment to neighboring barbules – move in one direction; mechanisms interact; “still air space”. “After feathers” trap air.</p>	 <p>https://asknature.org/strategy/feathers-trap-air-to-provide-warmth/</p>	<p>Cold Climate Envelope Concepts Winter (stay warm) Key ideas: adjustability; compression-expansion (cellular layers that change for different functions for light, temperature, heat-cool, etc.); interlocking layers, tiles, air; dynamic movement of “cladding”. Layers outside and inside envelope; seasonal tuning.</p>
<p>EMPEROR PENGUIN TRAIT: WINGS</p> <p>vascular system – heat exchange</p> <p>FUNCTION: Protect from temperature</p>	<p>AskNature: https://asknature.org/strategy/wings-reduce-heat-loss/ Flipper: humeral arterial plexus, vascular countercurrent heat exchanger (CCHE). Water below core body temperature; hypothermia threat; avoid by flow of heat along the wing. Brachial artery splits into two arteries. Each humeral artery is associate with two or more veins to form a countercurrent heat exchanger (CCHE). https://royalsocietypublishing.org/doi/10.1098/rsbl.2010.0993</p>	 <p>https://fossilpenguins.wordpress.com/2010/12/01/penguins-</p>	<p>Cold Climate Envelope Concepts Winter (stay warm) Key ideas: heat-cold heat exchange (passive or active; air and/or hydronic system) Passive: double envelope (gather expel heat). Active: Hydronic systems; integrate heating and cooling.</p>

4.5. Step 5: Translate to Design - Function, Biodiversity & Evolution

Working from the understanding developed in the exploration of biological models, the next step is to develop conceptual design diagrams that address the design challenge. The design solutions will vary based on the types of traits selected while moving from biology to design application. It is necessary to consider the translation of biological traits related to form, process, system, and material from a variety of perspectives, asking the question: How are these traits architectural? For example, a form-based trait will influence the design configuration and massing. A system-based trait will consider the larger context defined by relationships amongst the components. A material-based trait will inform the physical matter such as structure and details.

In the cold-climate, south-facing envelope example, the penguin feathers informed exploration of multi-functional adjustable louvers (feathers) combined with a double envelope integrated with passive and active heating and cooling systems (wing heat exchanger) (Figure 9). Concepts of iterative change (evolution), time, seasons, and dynamic response to environmental conditions were considered for passive solar heating and daylighting performance and comfort in winter. The steps below describe the biology-architecture translation process.

4.5.1. Step 5 Example: Translate Biological Models into Conceptual Design Strategies

- *Translate functions, traits, and mechanisms for design based on criteria:* What are the essential biological functions or traits to translate from biology into design? Consider form, process, system, and material translations.
 - What biological attributes need to be translated (essential, accurate, relevant)?
 - Be careful not to limit the design exploration by literal translation or what already exists. Explore new design models.
- *Bio-inspired design charette:* Create iterative concept designs using images, sketches, diagrams, and notes. Revisit essential biological concepts in the scenarios to expand design thinking and translations.

4.6. Step 6: Test in Context, Repeat as Needed, Integrate - Function, Biodiversity & Evolution

The sixth step revisits the original design challenge to clarify the design intentions and to refine design criteria to evaluate conceptual design scenarios. Develop a prototype and use it to refine, through iterations and explorations, the relationships and impacts across scales. Consider how the solutions interact with real world conditions, as well as how the solutions impact other design issues. The iterative design process can be repeated as needed with parallel questions (how nature cools in summer) and other related issues (envelope design for lighting, moisture, energy performance, etc.). Conceptual design scenarios can be further developed through the lens of select design and performance metrics.

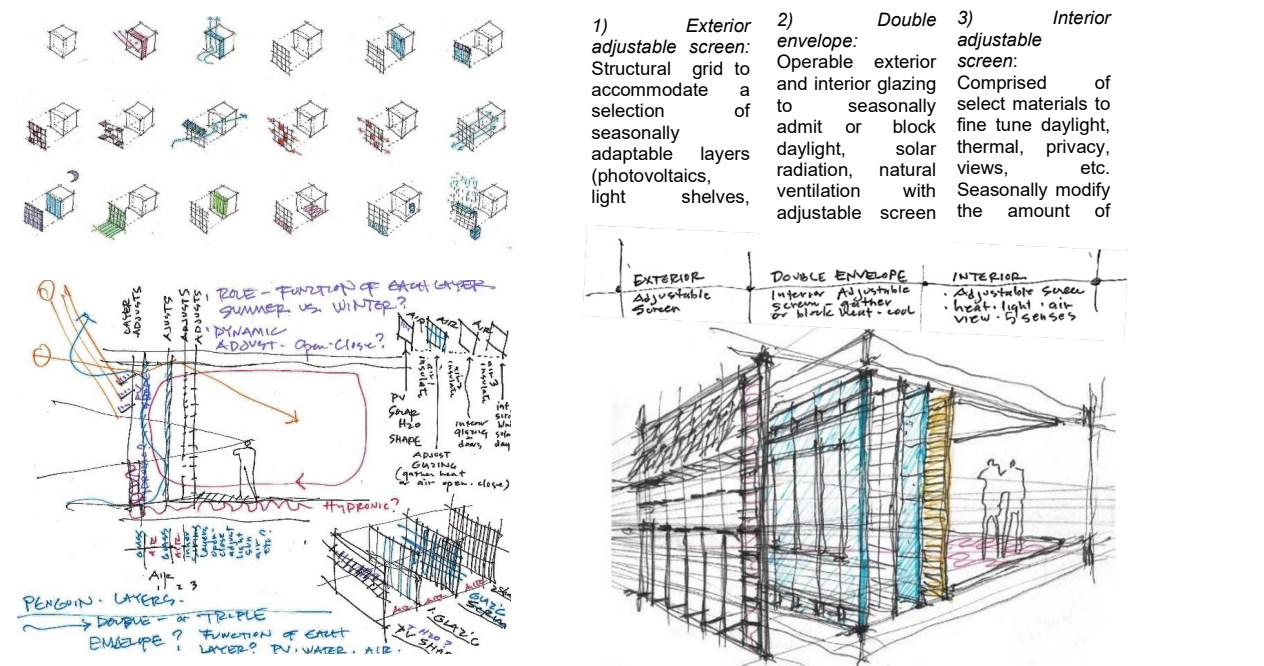

Figure 9: Left: Step 5 Example: Translating conceptual design ideas from the emperor penguin’s feather and wing attributes to a cold-climate south-facing building envelope. Source: (Authors 2022)

Figure 10: Right: Step 6 Example: Conceptual design for a cold-climate south-facing building envelope based on the emperor penguin feathers (three adjustable grids) and wings (heat exchange with passive double envelope and active hydronic system). Three layers are described above. Source: (Authors 2022)

In the cold-climate, south-facing envelope example, the attributes of the penguin feathers and the vascular system of the wings informed a layered and integrated passive-active hybrid approach to the conceptual design (see Figure 10 and following discussion).

First, the feathers inspired the concept of three adjustable louvered structures from outside to inside (Figure 10):

1) An exterior adjustable screen (to provide a range of functions that might include integrated shading, solar control, lightshelves, photovoltaics, rainscreen, active solar collectors, rain collection, etc.), 2) A double envelope with operable interior and exterior glazing with an adjustable interior screen (to further modify material attributes seasonally or diurnally to absorb or reject heat, light, air, etc.), and 3) An interior adjustable screen (to fine tune views, sound, sensory experiences, privacy, biophilic connections, etc.).

Second, the penguin wings and vascular system (heat exchanger) informed the conceptual development of a double envelope for seasonal passive heating and cooling integrated with active hydronic solar heating (Figure 10). Developing and testing this concept design requires further exploration of seasonal strategies for staying cool, including the integration of natural ventilation, solar control, and daylighting with passive and active strategies for winter. The designer would then repeat the bio-inspired design process, for instance studying how birds stay cool during the summer in part by holding their feathers in ways to trap less air or incorporating butterfly-wing-inspired structural materials that would absorb more warmth during the winter. The steps below illustrate the conceptual design process.

4.6.1. Step 6 Example: Revisit Design Challenge

- *Evaluate conceptual designs based on design criteria:* Identify most-promising design scenarios based on design criteria. Further develop scenarios based on design and performance criteria across time and seasons.
- *Revisit larger questions (broad vs narrow):* Repeat iterative process for parallel questions and integrate: How does nature stay cool, how does nature illuminate, stay dry, respond to dynamic conditions, etc.?
- *Repeat parallel design iterations:* Determine which design concepts to develop and integrate across seasons and/or other design considerations.
- *Select scenarios for evaluation:* Move forward with select scenarios to evaluate using qualitative and quantitative design criteria, assessment tools, and metrics.

CONCLUSIONS

This six-step bio-inspired design process, with integrated biological concepts from evolutionary biology and ecology, can inform architectural design thinking in the following ways:

1. *Expand Design Perspective:* The collaboration with biologists, and the integration of biological models from the emperor penguin's feathers and wings opened unexpected ways of thinking about three seasonably adjustable layered screens (multiple functions) and integration with a double envelope (passive and active heat exchange). As architect Jim Lutz, design advisor stated: "I have never thought of design in this way and in what I can learn from other species." The concepts and six-step process are useful in challenging and expanding how to abstract and translate specific biological strategies based on design criteria. The biological concepts connect the design exploration to tangible biological phenomena.
2. *Practice Design Humility:* The Biomimicry Institute's *AskNature* tool and curation of biological models (species selection) with biologists revealed brilliant and awe-inspiring strategies that other species use to stay warm. Exploring biologically diverse models and different biomes illustrates that there are many approaches to the same problem or design challenge. Introduction to and exploration of the tree of life reminds designers that humans are just one of many species.
3. *Employ a Tangible Process:* The six-step process provides an organized structure to move back and forth between the design and the biological realms. As an iterative process, parallel questions need to be investigated and integrated. This bio-inspired design process asks designers to shift from seeing architecture as an "object" to exploring architecture as a "verb" and a "process": what is the design element doing and what is its function (program, performance, experiential, aesthetic, time, seasons, adaptability, etc.).
4. *Next Steps:* The first phase of design research explored collaboration with biologists, integration of select biological principles, and testing with a simplified bio-inspired design process. The next step of the research will include testing the conceptual design process with students in architecture and biology during the coming academic year. Future studies will develop evaluation criteria and processes to assess design scenarios, including: 1) Evaluation of the performance related to the design challenge (regulation of temperature based on bioclimate; diurnal and seasonal thermal comfort; user control, satisfaction, etc.), 2) Criteria and performance metrics for sustainability and resilience (bio-inspired is not necessarily sustainable), and 3) Biological effectiveness (this may be a question of scale, materials, or the fit of the analogy). Finally, does the proposal represent the essential principles and attributes of the biological model?

ACKNOWLEDGEMENTS

The team gratefully acknowledges the *John Templeton Foundation* for support of this research initiative. Funding from the *Imagine Fund* at the University of Minnesota supported participation by research assistants Daniel Banker and Silver Li to develop select graphics and support the team in testing the conceptual bio-inspired design process. Jim Lutz, architect and architectural educator, contributed as a design advisor.

REFERENCES

- Baumeister, D., Tocke, R., Dwyer, J., Ritter, S., and Benyus, J. 2014. Biomimicry Resource Handbook. A Seed of Best Practices. Montana: Biomimicry Institute, 100-116.
- Bhushan, B., Biomimetics: Lessons from Nature - An Overview. *Philosophical Transactions of the Royal Society A*, 2009. 367: 1445-1486.
- Biomimicry Institute. 2022. AskNature: Innovation Inspired by Nature. Biomimicry Institute, <https://biomimicry.org/>. Emperor Penguin Wings: AskNature: <https://asknature.org/strategy/wings-reduce-heat-loss/>; Emperor Penguin Feathers: <https://asknature.org/strategy/feathers-trap-air-to-provide-warmth/>.
- . 2008. Biomimicry Taxonomy. Biomimicry Institute, <https://asknature.org/resource/biomimicry-taxonomy/>.
- Brownell, B. and Swackhamer, M. 2015. *Hypernatural: Architecture's New Relationship with Nature*. Princeton Architectural Press.
- Cruz, E., Hubert, T., Chancoco, G., Naim, O., Chayaamor-Heil, N., Cornette, R., Menezo, C., Badarnah, L., Raskin, K.; and Aujard, F. 2021. Design processes and multi-regulation of biomimetic building skins: A comparative analysis. *Energy and Buildings*, Volume 246, <https://doi.org/10.1016/j.enbuild.2021.101616>.
- Dixit, S. and Stefanska, A. 2023. Bio-logic, A Review on the Biomimetic Application in Architectural and Structural Design. *Ain Shams Engineering Journal*. Volume 14, Issue 1, 2023, 101822, ISSN 2090-4479, <https://doi.org/10.1016/j.asej.2022.101822>.
- Fayemi, P.E., Wanick, K., Zollfrank, C., Manazana, N., and Aoussat, A. 2017. Biomimetics: Process, Tools, and Practice. *Bioinspiration & Biomimetics*, Volume 12, Number 1.
- Fish, F.E. and Beneski, J.T. 2014. Evolution and Bio-Inspired Design: Natural Limitations. *Biologically Inspired Design*. Springer. p. 287-312.
- Fu, K., Moreno, D., Yang, M., and Wood, K.L. 2014. Bio-Inspired Design: An Overview Investigating Open Questions From the Broader Field of Design-by-Analogy. *ASME. J. Mech. Des.* 136: 111102.
- Graeff, E., Maranzana, N., and Aoussat, A. 2019. Biomimetics, where are the biologists? *Journal of Engineering Design*, 30: 289-310.
- . 2019. Engineers' and Biologists' Roles during Biomimetic Design Processes, Towards a Methodological Symbiosis. *Proceedings of the Design Society: International Conference on Engineering Design*, 1(1), 319-328. doi:10.1017/dsi.2019.35.
- Hund, AK, Stretch, E., Smirnov, D., Roehrig, GH., and Snell-Rood, EC. 2023. Broadening the Taxonomic Breadth of Organisms in the Bio-Inspired Design Process. *Biomimetics* 8:48
- Krishna, A., Nie, X., Warren, A. D., Llorente-Bousquets, J. E., Briscoe, A. D., and Lee, J. 2020. Infrared Optical and Thermal Properties of Microstructures in Butterfly Wings. *Proceedings of the National Academy of Sciences*, 117(3), 1566-1572.
- Google Scholar. 2022. <https://scholar.google.com/>. iNaturalist. 2023. <https://www.inaturalist.org/>.
- Penick, CA., Cope, G., Morankar, S., Mistry, Y., Grishin, A., Chawla, N., and Bhate, D. 2022. The Comparative Approach to Bio-Inspired Design: Integrating Biodiversity and Biologists into the Design Process. *Integrative and Comparative Biology*, 62: 1153–1163.
- Roth-Nebelsick, A. 2022. How much biology is in the product? Role and relevance of biological evolution and function for bio-inspired design. *Theory in BioSciences* 141, 233–247.
- Snell-Rood, EC and Smirnov, D. 2023 in review. Biology for Biomimetics I: function as an interdisciplinary bridge in bio-inspired design. *Bioinspiration and Biomimetics*.
- Vincent, JFV and Mann, DL. 2002. Systematic technology transfer from biology to engineering. *Phil. Trans. R. Soc. A*. 360, 159–173.
- Web of Science. 2023. <https://clarivate.com/webofsciencelibrary/solutions/web-of-science/>. Wikipedia. 2023. Organism Classifications. <https://en.wikipedia.org/wiki/Wikipedia:Classification>. Wouters, A., 2005. The Function Debate in Philosophy. *Acta Biotheoretica*, 53: 1

A Pilot Study on Indoor Air Quality in a Naturally Ventilated Classroom in Eugene, Oregon, During the Covid-19 Pandemic

Maria C. Coronado¹, Alison Kwok¹

¹University of Oregon Institution, Eugene, OR

ABSTRACT: Indoor air quality in schools impacts children's academic performance and health. With Covid-19, schools were pushed to change how they operated and ventilated their classrooms. As a result, school districts and facility managers created protocols to improve their facilities to provide adequate indoor air quality (IAQ) for the health and safety of their students. This paper uses a post-occupancy evaluation method in a pilot study assessing the air quality of one naturally ventilated school classroom in Eugene, Oregon, during one week of spring in 2022. While the school had protocols for ventilation put in place, we measured carbon dioxide, indoor and outdoor particulate matter (PM), temperature, and relative humidity along with occupancy and user behaviors related to window and door operation. Particulate matter 2.5 $\mu\text{g}/\text{m}^3$ (respirable) and 10 $\mu\text{g}/\text{m}^3$ (inhalable) concentrations reached moderate levels during cleaning periods when the students were not present. Carbon dioxide concentrations remained below 800 ppm and corresponded with lower air changes per hour (ACH) than those recommended during the pandemic. Since outdoor air quality was relatively ideal during the study period, occupancy levels, adaptive behaviors and activities were the major influences on indoor air quality. Informal conversations with teachers and principals allowed for an understanding of the general attitudes about classroom conditions, protocols, and policies by facility management and leadership. The study was intended as a pilot to develop and verify methods for a more extensive, expanded study into schools with different ventilation systems and other climates. Future iterations of the study will include multiple classrooms and more than one measurement station. The study was limited by a small sample size and measuring period (one week) of a mild weather season, which did not allow to reach generalizable conclusions. This study provides an understanding of environmental quality, safety, and health in the school community.

KEYWORDS: Indoor Air Quality, Schools, Classrooms, Ventilation, Particulate Matter

INTRODUCTION

Schools constitute the second place where children spend more time after their homes. Therefore, they are important contributors to children's health and well-being. This is relevant, as research has shown that children are more vulnerable than adults to poor indoor air quality (IAQ) because they are more sensitive to cold, heat and moisture, and breath more air per weight than adults (Sadrizadeh et al. 2022). In addition, ventilation plays a role in children's academic performance. For instance, a meta-analysis found evidence that students in classrooms with higher ventilation rates and lower CO₂ concentrations perform better on standardized tests and performance tasks by as much as 15% (Fisk 2017). However, before the pandemic multiple research studies found that classrooms usually did not meet the minimum ventilation rates specified by the existing IAQ standards, and did not provide adequate air quality to students (Daisey, Angell, and Apte 2003; Shendell et al. 2004; Wargocki and Wyon 2013).

Ventilation is also important to dilute air pollutants. Multiple pollutants of chemical and biological origin have been identified in schools, including particulate matter, fungi, pollen, bacteria, viruses, mites, NO₂, CO, and VOCs (Mendell and Heath 2005; Sadrizadeh et al. 2022). These pollutants have been correlated with an array of health symptoms in children (Marcotte 2017; Daisey, Angell, and Apte 2003), and measures of school absenteeism (Mendell and Heath 2005), but more research is necessary to understand their direct physiological impacts within given levels of exposure in school settings.

During the Covid-19 pandemic, increasing ventilation rates was one of the main strategies to prevent the spread of the virus and to create safer environments. To do this, many school districts prioritized upgrading their ventilation and filtration systems and/or installed new windows in their schools. In 2020, the U.S. Government Accountability Office (GAO) estimated that in about 41% of public school districts, at least half the schools needed to upgrade their HVAC systems (U.S. Government Accountability Office 2020). In fact, the top challenge for schools to implement the recommended IAQ measures during the pandemic was that their HVAC systems were not designed to handle such high ventilation rates (The Center for Green Schools and ASHRAE 2021). For schools that could enhance ventilation, increases in energy demands resulting from intensifying outdoor air intake in HVAC systems became a common tradeoff (The Center for Green Schools and ASHRAE 2022). Also, in naturally ventilated schools operating during the

pandemic, there was an additional circumstance with decreased thermal comfort, especially during the winter months (Alonso et al. 2021; Miranda et al. 2022).

Multiple guidelines were developed during the pandemic to assess indoor air quality in schools. In the U.S., some of the most salient recommendations came from the Centers for Disease Control and Prevention (CDC), American Society of Heating Refrigeration and Air Conditioning Engineers (ASHRAE), Harvard's T.H. Chan School of Public Health, the Center for Green Schools, and the National Academies of Sciences, among others, shortly after the pandemic started. These guidelines used CO₂ concentrations as a proxy to assess ventilation and provided recommendations to evaluate and improve ventilation and filtration inside school buildings. Later, in February 2022, ASHRAE released its position document on indoor CO₂. In this document, they clarified some of the existing misconceptions about CO₂ concentrations and their relationship with ventilation rates. Previous studies often used 1000 ppm and 700 ppm as direct indicators of adequate ventilation in classrooms. However, these values are not included in the current ANSI/ASHRAE Standard 62.1-2022, Ventilation and Acceptable Indoor Air Quality, because their use has often been misinterpreted. These values are linked to building occupants' perception of human body odor, not ventilation needs. Using CO₂ as an indicator of the outdoor ventilation needs of a space requires the inclusion of other considerations such as the space type, occupant density, and occupant characteristics like age, body mass, and activity levels (ASHRAE 2022).

Particulate matter (PM) is also a significant concern for student and teacher health. PM is a mixture of different pollutants of chemical and biological origin that can infiltrate the respiratory system. Particles of less than 2.5 µg/ m³ (respirable) can infiltrate the gas-exchange region of the lungs, while particles of less than 10 µg/ m³ (inhalable) can be hazardous when deposited in the respiratory tract (Morakinyo et al. 2016). In school facilities, PM may come from indoor or outdoor sources. Indoor sources may include chalkboard dust, resuspended dust from children's activity, cleaning, and combustion sources for heating, while outdoor sources may include traffic, wildfires, or industrial emissions. Outdoor sources are usually more problematic in urban areas (Sadrizadeh et al. 2022). The potential health effects of PM are highly related to the level of exposure and the surface area, size, mass, and composition of the particles, which determines their toxicity (Morakinyo et al. 2016). For example, previous studies reported reduced lung function, asthma, and other pulmonary diseases in children and adults exposed to high levels of endotoxins present in PM (Morakinyo et al. 2016). Similarly, other studies have found links between PM_{2.5} exposure with symptoms of conjunctivitis, hay fever, itchy rash, and sensitization to outdoor allergens in children (Sadrizadeh et al. 2022).

The Air Quality Index (AQI) is one of the U.S. Environmental Protection Agency's (EPA) tools for com for communicating daily air quality. The AQI is directly related to health, as its purpose is to inform people about the air quality so that they can take steps to protect their health. The AQI reports mean values for exposures to multiple pollutants, including O₃, CO, SO₂, and NO₂, in addition to PM_{2.5} and PM₁₀. For PM, the index considers concentrations and periods of exposure of 24 hours. These times may be modified if the air quality changes rapidly during a critical event, like a wildfire (United States Environmental Protection Agency 2018).

This study was developed at the end of the pandemic during a week of class in the Spring of 2022. The study aimed to characterize and evaluate the indoor air quality performance of a fully naturally ventilated classroom in Eugene, Oregon, with all the school ventilation protocols put in place. The pilot included physical measurements of CO₂ and PM concentrations and additional environmental parameters such as indoor and outdoor temperature and relative humidity. In addition, classroom occupancy and window and door operations were recorded to correlate the indoor environmental conditions with users' behaviors.

1.0 METHODOLOGY

1.1 The setting

The pilot study was conducted in an elementary school classroom in Eugene, Oregon, in the spring of 2022. The classroom dimensions were 8.4 m (27.5 ft) wide x 12.2 m (40 ft) long x 3.3 m (11 ft) tall, with 3.3 m (11 ft) x 3.3 m (11 ft) bathrooms in the back of the classroom. The classroom had hard-tile flooring in the back half portion of the classroom and carpet in the front half. Under maximum occupancy, the classroom had 23 students and a teacher.

Conversations with the teacher and the school administration helped to determine classroom occupancy and usage. The teacher arrived at the classroom around 8:00 am each day. Then, students entered the classroom at 8:15 am and left at 2:50 pm. Recess periods occurred from 9:45 am to 10:00 am and 11:45 am to 12:05 pm and were held outside the classrooms, except during critical air events like wildfires. Classrooms were not always occupied during class periods as students had specialty classes in other classrooms or additional periods of outdoor work. While students were in their specialty classes, teachers stayed inside the classroom working. After the students left, the teacher stayed in the classroom until 5:30 pm, working alone. When the teacher left, the classroom remained unoccupied until the evening. Then, the custodian entered the classroom to clean and vacuum the floors for about 15 minutes between 7:00 and 8:00 pm. In addition, every Friday afternoon, a group of volunteer parents helped to thoroughly clean and sanitize the classroom.

The classroom was entirely naturally ventilated and had a ductless mini-split unit in the back for heating and cooling. The classroom had windows and doors on opposite sides that led directly to outdoor spaces. The east side of the

classroom led directly to a garden and had 7 fixed windows plus 3 operable awning windows and 1 door. The west wall contained 5 windows and the front door, which was the main entrance to the classroom, leading to an open courtyard. On this side, only the middle window was an operable single-hung window. All windows on the west wall of the classroom were built during the pandemic, including the operable window to create cross-ventilation inside the classroom and increase the ventilation in the room.

During the study period, the school had ventilation protocols put in place. After the teacher arrived in the classroom, she placed a fan in the single-hung window and turned it on to exhaust the indoor air and create a cross-ventilation flow. The teacher would also open all awning windows and crack open the garden door. This setting stayed constant all day, so the main adaptation for indoor air came from opening and closing the front door during the day. At the end of their workday, the teacher turned off and removed the fan from the window, closed all windows and doors, and left the classroom. During the study, all students were wearing masks all through the day.

1.2. Physical measurements and occupancy logs

During the study period, a sensor station was placed near the teacher's desk in the front of the classroom. Sensors were calibrated according to the manufacturer's recommendations prior to the start of the study. Indoor environmental parameter readings were collected every 5 minutes for a week. Measurements included readings of indoor and outdoor particulate matter (PM) at 2.5 $\mu\text{g}/\text{m}^3$ and 10 $\mu\text{g}/\text{m}^3$ and indoor CO_2 , temperature, and relative humidity. Outdoor CO_2 measurements were taken using a handheld sensor near the school on the last day of the study, and then averaged and taken as constant for the ventilation calculations. All outdoor readings were collected from an existing Purple Air sensor one block from the school. Table 1 summarizes the sensors and measurements used in the study.

Table 1: Sensors and measurements used for the study.

Sensor	Measurement	Precision
HOBO MX1102 logger	CO_2 CO_2 (ppm)	0 to -5000 ppm. ± 50 ppm $\pm 5\%$ of reading at 25°C (77°F), < 90% RH (non-condensing) and 1,013 mbar
	Temperature (°C or °F)	0° to 50°C (32° to 122°F). $\pm 0.21^\circ\text{C}$ from 0° to 50°C ($\pm 0.38^\circ\text{F}$ from 32° to 122°F)
	Relative humidity (%)	1% to 90% R.H. (non-condensing). $\pm 2\%$ from 20% to 80% typical
Dylos air quality monitor DC1700 – PM	$\text{PM}_{2.5}$ and PM_{10}	Particle concentration (>0.5 μm , >2.5 μm) or mass concentration in $\text{PM}_{2.5}$ / PM_{10} ($\mu\text{g}/\text{m}^3$)
TSI 9565 plus 982 IAQ probe	CO_2 (ppm)	0 to 5000 ppm CO_2 $\pm 3\%$ of reading or ± 50 ppm CO_2 , whichever is greater.
Purple Air outdoor sensor	$\text{PM}_{2.5}$ and PM_{10}	Counting efficiency 50% at 0.3 μm & 98% at $\geq 0.5\mu\text{m}$. Effective range ($\text{PM}_{2.5}$ standard): 0 to 500 $\mu\text{g}/\text{m}^3$

In addition to physical sensing, a camera was directed at the windows and doors of the classroom. The camera was configured to take a picture when it detected movement. This allowed for a detailed recording of the window status (open or closed) and detailed tracking of the classroom occupancy without interfering with the classes. These records were complemented by conversations with the teacher to trace classroom occupancy patterns.

2.0 RESULTS

2.1. Indoor/outdoor air relationships

Indoor and outdoor levels of particulate matter, CO_2 , temperature, and relative humidity were recorded during the study period. Since the classroom is naturally ventilated, we expected significant correlations between indoor and outdoor environmental parameters. Indoor temperatures had an average of 19.3 °C (66.7 °F) and a 50.5% relative humidity, while the mean outdoor temperature was 16.4 °C (61.5 °F) with 56.82% relative humidity.

To understand the relationships between indoor and outdoor air quality variables, a correlation analysis was used. Since PM and CO_2 measurements did not meet the normality assumption, we used Spearman's rank-order correlations to assess these relationships. Since outdoor CO_2 was measured and averaged into a constant value of 425 ppm, it was not included in the correlations. Table 2 shows the correlation coefficients between indoor and outdoor measurements for relevant air parameters. As expected, all indoor and outdoor parameters were significantly correlated between themselves at the $p < 0.01$ level. However, indoor PM_{10} and $\text{PM}_{2.5}$ concentrations did not correlate significantly with outdoor PM_{10} or outdoor $\text{PM}_{2.5}$, implying additional PM sources inside the classroom.

Indoor $\text{PM}_{2.5}$ had a maximum concentration of 99 $\mu\text{g}/\text{m}^3$ and an average of 7.89 $\mu\text{g}/\text{m}^3$. This average concentration is in the "good" category for the pollutant-specific sub-indices in the Air Quality Index (AQI) of the Environmental Protection Agency (EPA) (United States Environmental Protection Agency 2018). Outdoor $\text{PM}_{2.5}$ had an average concentration of 1.85 $\mu\text{g}/\text{m}^3$ and a maximum of 11.54 $\mu\text{g}/\text{m}^3$, implying that indoor $\text{PM}_{2.5}$ levels were higher than outdoor levels during the study period. Similarly, indoor PM_{10} concentrations had an average of 28.40 $\mu\text{g}/\text{m}^3$ and a maximum of 1227.9 $\mu\text{g}/\text{m}^3$, while outdoor PM_{10} concentrations reached a max value of 15.53 $\mu\text{g}/\text{m}^3$ and had an average concentration of 2.3 $\mu\text{g}/\text{m}^3$. These average concentrations also fall into the "good" category of the AQI for PM_{10} and show a similar trend, where indoor PM concentrations are higher than outdoor ones. Indoor CO_2 concentrations reached a maximum value of 778 ppm during the study period and an average of 520.68 ppm.

Table 2 Correlations between measured indoor and outdoor environmental parameters. Means and standard deviations (in parentheses) are displayed on the main diagonal.

		Indoor			Outdoor	
		CO ₂ (ppm)	PM _{2.5} (µg/ m ³)	PM ₁₀ (µg / m ³)	PM _{2.5} (µg / m ³)	PM ₁₀ (µg/ m ³)
Indoor	CO ₂ (ppm)	520.68 (50.276)				
	PM _{2.5} (µg/ m ³)	0.227**	7.888 (7.392)			
	PM ₁₀ (µg/ m ³)	0.250**	0.918**	28.399 (65.21)		
Outdoor	PM _{2.5} (µg/ m ³)	0.144**	-0.032	0.033	1.854 (2.327)	
	PM ₁₀ (µg/ m ³)	0.169**	-0.034	0.024	0.988**	2.307 (2.656)

**Indicates significance at the p < 0.01 level.

2.2. Influences of occupancy and behavior on indoor air quality

To understand the relationships between occupancy and the measured indoor air parameters, five different types of occupancy were characterized during the study according to the number of occupants in the classroom and their activities. Table 3 shows the different types of occupancy recorded during the study period. Particulate matter and CO₂ concentrations fluctuated throughout the day and were closely related to occupancy. A visual inspection of the boxplots showing PM and CO₂ concentrations in different occupancy types revealed that the distributions were not similar (Figures 1-3). Therefore, Kruskal-Wallis non-parametric tests were carried out to examine the differences between the occupancy type and the indoor PM and CO₂.

The test showed significant differences in PM_{2.5} concentrations under different occupancy types $\chi^2(4) = 460.24, p < .001$. Pairwise comparisons were performed using a Bonferroni correction for multiple comparisons. Adjusted p-values are presented. PM_{2.5} concentrations in unoccupied conditions (mean rank = 414.42) were significantly different from all occupancy types: low (mean rank = 768.64, p < 0.001), high (mean rank = 896.78, p < 0.001), clean (mean rank = 927.11, p < 0.001) and high cleaning (mean rank = 996.63, p < 0.001). Therefore, PM values were significantly lower when the classroom was empty than in all other occupancy types. In addition, cleaning and high cleaning periods had the highest mean ranks, implying that this is when the highest PM_{2.5} concentrations generally occurred.

Table 3 Typical occupancy types and activities related to each occupancy type during the study.

Occupancy Type	Occupancy description	Activity
Unoccupied	No occupants	NA
Low	1 adult	Reading, writing, sitting.
High	23 children and 1 adult	Classes, reading, writing. Usually sitting on desks or on the floor.
Cleaning	1 adult	Vacuuming, walking.
High cleaning	8 adults	Cleaning and disinfecting the classroom. Moving furniture.

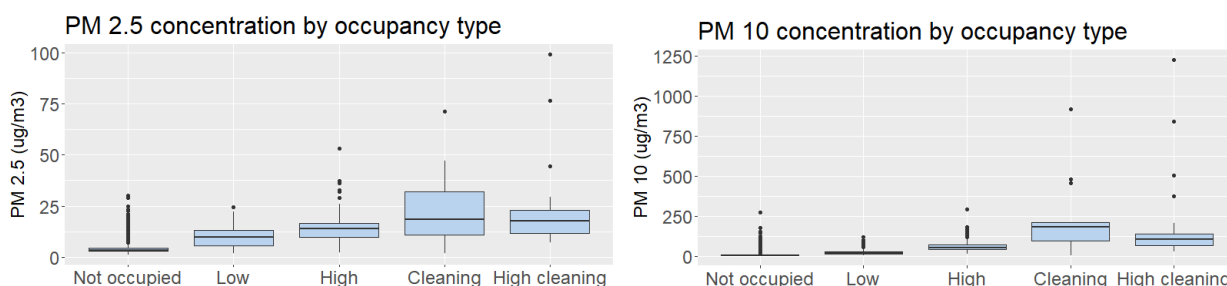

Figures 1 & 2: PM_{2.5} and PM₁₀ concentrations in µg/ m³ by occupancy type. Source: (Maria Coronado 2022)

Following the same design, a Kruskal-Wallis test was run for PM₁₀ concentrations for all occupancy types, and significant differences were found between occupancy types $\chi^2(4) = 574.51, p < .001$. Following pairwise comparisons using Bonferroni revealed a similar trend to the one found with PM_{2.5}. Significant differences in PM₁₀ concentrations occurred between unoccupied conditions (mean rank = 401.36) and all other occupancy conditions. The mean ranks for each occupancy condition are as follows: low (mean rank = 740.65, p < 0.001), high (mean rank = 973.54, p < 0.001), clean (mean rank = 993.43, p < 0.001), and high cleaning (mean rank = 1067.25, p < 0.001). All mean ranks were higher than the mean rank in unoccupied conditions, implying that PM₁₀ concentrations were generally higher when the classroom was occupied. Notably, the highest mean ranks occurred during cleaning and high cleaning periods.

Indoor CO₂ is usually used to indicate occupancy, but its concentrations vary depending on activity levels and occupant characteristics (ASHRAE Board of Directors 2022). Therefore, a Kruskal-Wallis test was run to determine if there were

significant differences in CO₂ concentrations between the 5 occupancy types. The distributions of CO₂ concentrations were statistically significantly different between groups, $\chi^2(4) = 357.78$, $p < .001$. Post hoc analysis revealed that CO₂ concentrations in all occupancy types were significantly different from high occupancy conditions (mean rank = 988.16) ($p < 0.001$). Statistically significant differences also occurred in CO₂ concentrations between low occupancy (mean rank = 375.90) ($p < 0.001$) and unoccupied (mean rank = 532.72) and high cleaning conditions (mean rank = 672.79). In contrast, no significant differences were found between unoccupied and cleaning or high cleaning conditions. In addition, the low occupancy mean rank was the lowest among all occupancy types, implying that an additional factor was causing a decrease in CO₂ concentrations under low occupancy (Figure 3).

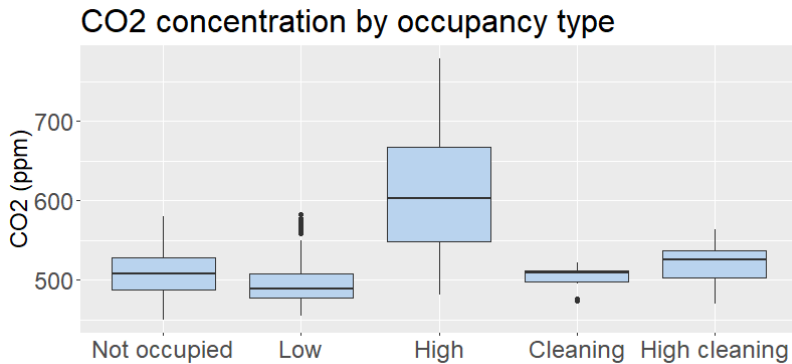
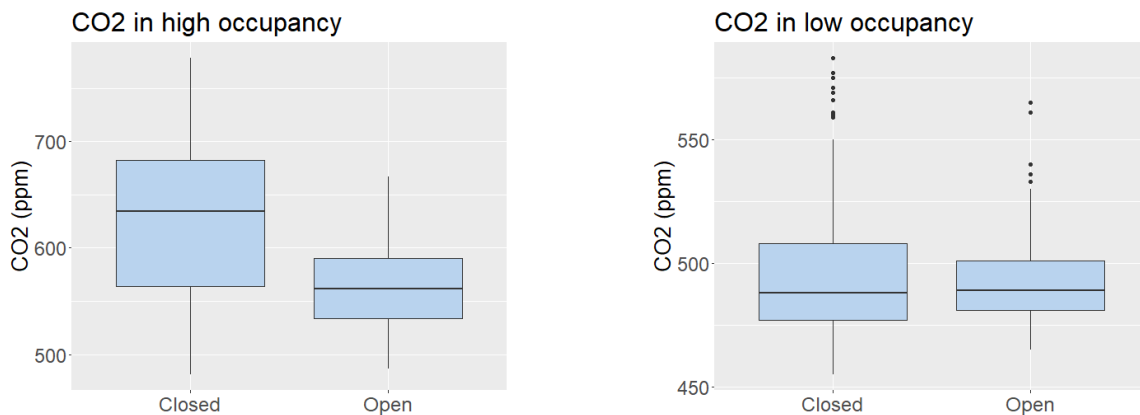

Figure 3. CO₂ concentrations in ppm by occupancy type. Source: (Maria Coronado 2022)

To further investigate the influences of behavioral adaptations on CO₂ concentrations, Mann-Whitney tests were carried out to compare CO₂ concentrations with the front door open and closed, as this condition changed multiple times during the day. Opening and closing windows was discarded, as they were in the same position during all the periods when the classroom was occupied. In addition, since the door was never closed during cleaning or high cleaning periods, these comparisons are not presented here. Average CO₂ concentrations with the door open during high occupancy were 565 ppm and 625 ppm with the door closed.

Distributions of CO₂ concentrations were not similar, as assessed by visual inspection, so only mean ranks are compared here. In high occupancy, CO₂ concentrations were significantly different with the door open (mean rank = 53.12), and the door closed (mean rank = 96.69), $U = 1368.500$, $z = -5.212$, $p < 0.01$ (Figure 4). In low occupancy, there was no significant difference between the distributions of CO₂ concentrations when the door was opened compared to when the door was closed (Figure 5). Therefore, opening the door had a significant influence when the classroom was in full occupancy.



Figures 4 & 5: CO₂ concentrations in ppm with the front door open and closed during high and low occupancy. Source: (Maria Coronado 2022)

2.3. Indoor air quality according to pandemic recommendations

To test whether the indoor CO₂ levels of the classroom complied with recommendations developed during the pandemic. The ventilation rates were estimated using the 5-step guide to checking ventilation rates in classrooms developed by the TH Chan School of Public Health (Allen et al. 2020). The selected procedure is meant to work with any type of ventilation system and only requires a CO₂ monitor. This procedure renders an estimation of the indoor

CO₂ concentration for a desired ventilation rate, which can then be compared with the on-site measured CO₂ concentrations.

For this analysis, only the concentrations measured during high occupancy were included, as these are the ones that are of interest. The outdoor CO₂ concentration used was 425 ppm, which is slightly higher than the usual value of 400 ppm, as mentioned by the guide. The per-person CO₂ generation rate for children was 0.0066 and 0.013 for adults. The estimated CO₂ concentration targets for the classroom were 3 ACH (697 ppm), 4 ACH (629 ppm), 5 ACH (588 ppm), and 6 ACH (561 ppm). During the pandemic, 6 ACH were considered “ideal,” 5 ACH “excellent,” 4 ACH “good,” and 3 ACH the “bare minimum.” The average CO₂ concentration measured during the study period was 521 ppm, and during high occupancy, it was 608 ppm, which would place the classroom between 4 and 5 ACH at different moments. With the door open, the mean CO₂ concentration during high occupancy was (565 ppm), which is close to the 6 ACH ideal.

Carbon dioxide concentrations fluctuated during the day. Figure 6 shows the frequency of CO₂ concentrations measured during high occupancy periods, and the estimated targets for different ACH calculated with the TH Chan guide. When comparing the actual CO₂ concentrations with the estimates during high occupancy periods, the classroom was above 3 ACH 88.1 % of the time, above 4 ACH in 59% of the readings, above 5 ACH 42.26% of the time, and only above 6 ACH in 30.3% of the readings.

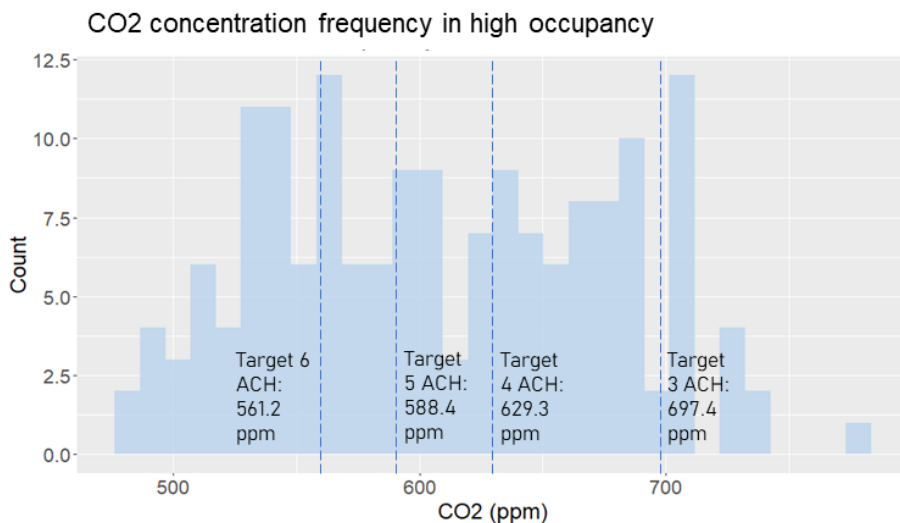

Figure 6: Frequencies of CO₂ concentrations in high occupancy. Source: (Maria Coronado 2022)

3.0 DISCUSSION

The measurements revealed that despite being entirely naturally ventilated, the PM concentrations inside the classroom were not correlated with outdoor values. Instead, variations in PM depended on the activity inside the classroom. In this case, the periods when the custodian or a group of volunteer parents sanitized and helped deep clean the classroom registered higher PM concentrations for brief periods of time. Nonetheless, the mean air quality of the classroom remained under good conditions according to the air quality index of the EPA for PM_{2.5} and PM₁₀. Other studies have shown that high outdoor pollutants are the leading cause of adverse IAQ (Raysoni et al. 2011). For example, in other studies, road traffic or outdoor pollution has been highly correlated with poor indoor air quality (Mendoza, Benney, and Boll 2021). In this study, outdoor PM levels were benign, so increases in indoor PM levels were mainly dependent on classroom cleaning activity. Replication of the study and measurements over more extended periods, including critical, seasonal events such as wildfires or in denser urban locations, could provide a broader range of situations to understand the performance of the building under different outdoor PM concentrations.

For CO₂ levels, it was not the activity but the number of occupants and their adaptive behaviors that drove the differences in concentrations. As expected, during high occupancy periods, CO₂ concentrations were higher. Nonetheless, during low occupancy periods, CO₂ concentrations were lower than when the classroom was empty. One possible explanation for this is that during low occupancy, all windows remained open, and the fan was turned on, continuing to flush CO₂ outside the classroom. In contrast, most unoccupied periods represented late afternoon and nighttime when the windows and doors were closed, and the fan was turned off. Therefore, the CO₂ was confined to the classroom until the teacher returned in the morning. Opening all windows and doors without occupants inside the classroom at the end of the day or before classes may be a good strategy to start the day with CO₂ concentrations matching outdoor values.

Assessing the differences in CO₂ concentrations in high occupancies with the front door open or closed showed the effects of adaptive behaviors in classroom ventilation. With the door open, the CO₂ concentrations were significantly

lower than when the door was closed, reaching mean CO₂ concentrations close to the recommended 6 ACH. Since natural ventilation fluctuates throughout the day, it is not possible to always ensure consistent ventilation rates. Classroom ventilation could be complemented with portable air cleaners with HEPA filters to increase safety when ventilation is low (Allen et al. 2020). The results of this study show how adaptive behaviors and ventilation protocols are key in maintaining an adequate indoor air quality in naturally ventilated indoor spaces. The results also show that on average, and during mild seasons like the spring, natural ventilation might be able to provide adequate ventilation rates for classrooms.

The study showed how the common assumption of maintaining classroom CO₂ levels below 1000 ppm or 700 ppm does not guarantee adequate ventilation. This value is based on the perception of human body odor and has no relation with ventilation requirements. Instead, ventilation requirements depend on space type, occupant density, and occupant characteristics (ASHRAE 2022). Therefore, a simple visual inspection of a CO₂ monitor in a classroom should not be taken as a definite measure of adequate ventilation. On the contrary, an estimation of ventilation rates with data on occupancy and activity type would provide a better estimate.

3.1. Limitations and future research

The pilot study was limited to one classroom, which did not allow for comparisons with similar spaces or other behavioral patterns. In the future, multiple classrooms could provide a wider range of data and allow for generalizable conclusions. Nonetheless, gathering data for a week allowed for understanding how the classroom worked under different occupancy conditions occurring only once a day or once a week. More extended measurement periods might provide more information on how activities, occupants, and environmental parameters change from season to season or during critical events like wildfires. In addition, it was not possible to assess the effects of window opening and closing on CO₂ concentrations since the school protocols did not allow for closing the windows while the classroom was occupied. The study also showed that in some cases, it is not the students or the teachers who control the classroom environment but the facility managers and the school administration through school-wide policy and protocols. Including other populations in this kind of research opens new opportunities, as they might provide critical information for understanding classroom performance.

Other limitations arose from the methodology and should be addressed in future iterations of the study. Only one CO₂ and one PM sensor were used and placed in one station in the front of the classroom. Since the classroom was naturally ventilated, CO₂ and PM concentrations might have differed from other parts of the room. Previous studies have shown that CO₂ has uneven distributions in naturally ventilated classrooms, and multiple sensors may help identify these differences (Zhang, Ding, and Bluysen 2022). Doing this might provide better information on the classroom's ventilation rates and give an idea of which classroom areas are better mixed than others. For instance, sensors placed next to students' desks might provide a better idea of the air quality that students are breathing. Nonetheless, sensor placement might be challenging and create distractions for the students. Therefore, planning ahead and devising a non-intrusive sensor station will be critical in future versions of the study.

This study was performed during the spring; therefore, it was possible to keep windows and doors open while the teacher was inside the classroom. As schools maintain their operation during winter and summer months, continuing these behaviors may bring thermal comfort and energy use tradeoffs, as was the case for many schools during the pandemic. In addition, now that the Covid-19 pandemic has abated, it is likely that some of the protocols, behavioral patterns, and adaptations recorded during this study will rapidly change. Therefore, repeating this study in other seasons and/or climates might give better insights into how environmental parameters, behavioral adaptations, and school protocols (or their absence) affect indoor air quality in classrooms.

Finally, this study was limited to assessing only a naturally ventilated classroom. The classroom reached CO₂ concentrations close to the 6 ACH recommendation with the door open. Future studies comparing the indoor air quality of naturally and mechanically ventilated classrooms may provide insights into how occupant behaviors and school practices modify the indoor air quality of classrooms with different ventilation types. In mechanically ventilated classrooms, the air is often recirculated, which may increase indoor CO₂ and PM concentrations. During the pandemic, many schools had to make great efforts to reach higher ventilation rates than what their HVAC systems provided (The Center for Green Schools and ASHRAE 2022). Therefore, assessing the IAQ of classrooms with different ventilation types may illustrate the advantages and disadvantages of each type in school facilities.

CONCLUSION

This paper presented a pilot study assessing the indoor air quality conditions of one naturally ventilated classroom in Eugene, Oregon, for a week during the spring of 2022, at the end of the Covid-19 pandemic. The study used indoor and outdoor PM and CO₂ measurements paired with recordings of occupancy and window and door opening and closing. Five occupancy types were characterized based on the number and type of occupants and their activities. In addition, informal conversations with teachers and administrative staff allowed for a general understanding of school protocols during the study period.

The results showed correlations between occupancy types and activities in the classroom with PM_{2.5} and PM₁₀ concentrations. In contrast, no correlations were found between indoor and outdoor PM values. According to the EPA Air Quality Index, all PM values showed good indoor and outdoor air quality conditions during the measurement period. Spikes in PM concentrations only occurred when the classroom was being cleaned and was the most impactful activity type generating additional PM concentrations in the air. Indoor CO₂ concentration depended on the number of occupants in the space and was modified by their behavioral adaptations. For example, during periods of high occupancy, CO₂ readings reached their maximum values and significantly decreased when the front door was open. In addition, CO₂ concentrations in low occupancy were lower than those in unoccupied conditions, as CO₂ remained trapped inside the classroom when the classroom was not in use.

Estimated ventilation rates evidenced the common misconception that directly measuring CO₂ in a space directly indicates adequate ventilation. When considering multiple parameters, the target ventilation rate required a lower CO₂ concentration than commonly referenced values such as 1000 ppm or 700 ppm. School protocols mandating window opening and portable fans to exhaust the air from a classroom were helpful strategies to maintain adequate ventilation rates but could not always reach the 6 ACH recommended during the pandemic. The fluctuations in ventilation rates portrayed the limitations of naturally ventilated classrooms, as ventilation fluctuated during the day. It is necessary to refine the methodology presented here and expand the study to understand better the influences of school operation protocols, behavior, and occupancy on classroom indoor air quality.

REFERENCES

- Allen, Joseph, Jack Spengler, Emily Jones, and Jose Cedeno-Laurent. 2020. *5-Step Guide to Checking Ventilation Rates in Classrooms*. Place: www.ForHealth.org.
- Alonso, Alicia, Jesús Llanos, Rocío Escandón, and Juan J. Sendra. 2021. *Effects of the COVID-19 Pandemic on Indoor Air Quality and Thermal Comfort of Primary Schools in Winter in a Mediterranean Climate*. Place: *Sustainability* 2021, Vol. 13, Page 2699 13 (5): 2699.
- ASHRAE. 2022. *ASHRAE Position Document on Indoor Carbon Dioxide*. Place: <https://www.ashrae.org>
- Daisey, J. M., W. J. Angell, and M. G. Apte. 2003. *Indoor Air Quality, Ventilation and Health Symptoms in Schools: An Analysis of Existing Information*. Place: *Indoor Air* 13 (1): 53–64.
- Fisk, W. J. 2017. *The Ventilation Problem in Schools: Literature Review*. Place: *Indoor Air* 27 (6): 1039–51.
- Marcotte, Dave E. 2017. *Something in the Air? Air Quality and Children's Educational Outcomes*. Place: *Economics of Education Review* 56: 141–51.
- Mendell, M. J., and G. A. Heath. 2005. *Do Indoor Pollutants and Thermal Conditions in Schools Influence Student Performance? A Critical Review of the Literature*. Place: *Indoor Air* 15 (1): 27–52.
- Mendoza, Daniel L., Tabitha M. Benney, and Sarah Boll. 2021. *Long-Term Analysis of the Relationships between Indoor and Outdoor Fine Particulate Pollution: A Case Study Using Research Grade Sensors*. Place: *Science of The Total Environment* 776 (July): 145778.
- Miranda, M.T., P. Romero, V. Valero-Amaro, J.I. Arranz, and I. Montero. 2022. *Ventilation Conditions and Their Influence on Thermal Comfort in Examination Classrooms in Times of COVID-19. A Case Study in a Spanish Area with Mediterranean Climate*. Place: *International Journal of Hygiene and Environmental Health* 240 (March): 113910.
- Morakinyo, Oyewale Mayowa, Matlou Ingrid Mokgobu, Murembiwa Stanley Mukhola, and Raymond Paul Hunter. 2016. *Health Outcomes of Exposure to Biological and Chemical Components of Inhalable and Respirable Particulate Matter*. Place: *International Journal of Environmental Research and Public Health* 13 (6): 1–22.
- Raysoni, Amit U., Jeremy A. Sarnat, Stefanie Ebel Sarnat, José Humberto Garcia, Fernando Holguin, Silvia Flores Luvano, and Wen Whai Li. 2011. *Binational School-Based Monitoring of Traffic-Related Air Pollutants in El Paso, Texas (USA) and Ciudad Juárez, Chihuahua (México)*. Place: *Environmental Pollution* 159 (10): 2476–86.
- Sadrizadeh, Sasan, Runming Yao, Feng Yuan, Hazim Awbi, William Bahnfleth, Yang Bi, Guangyu Cao, et al. 2022. *Indoor Air Quality and Health in Schools: A Critical Review for Developing the Roadmap for the Future School Environment*. Place: *Journal of Building Engineering* 57 (October).
- Shendell, D. G., R. Prill, W. J. Fisk, M. G. Apte, D. Blake, and D. Faulkner. 2004. *Associations between Classroom CO₂ Concentrations and Student Attendance in Washington and Idaho*. Place: *Indoor Air* 14 (5): 333–41.
- The Center for Green Schools, and ASHRAE. 2021. *Preparation in the Pandemic: How Schools Implemented Air Quality Measures to Protect Occupants from COVID-19*. Place: <https://www.usgbc.org/resources>
- The Center for Green Schools, and ASHRAE. 2022. *Managing Air Quality during the Pandemic: How K-12 Schools Addressed Air Quality in the Second Year of Covid-19*. Place: <https://www.usgbc.org/resources>
- U.S. Government Accountability Office. 2020. *K-12 Education: School Districts Frequently Identified Multiple Building Systems Needing Updates or Replacement*. June: 1–94. Place: <https://www.gao.gov/products/gao-20-494>
- United States Environmental Protection Agency. 2018. *Technical Assistance Document for the Reporting of Daily Air Quality – the Air Quality Index (AQI)*. Place: Environmental Protection, 22. <https://www.airnow.gov/publications/air-quality-index/technical-assistance-document-for-reporting-the-daily-aqi/>
- Wargocki, Pawel, and David P. Wyon. 2013. *Providing Better Thermal and Air Quality Conditions in School Classrooms Would Be Cost-Effective*. Place: *Building and Environment* 59 (January): 581–89.
- Zhang, Dadi, Er Ding, and Philomena M. Bluyssen. 2022. *Guidance to Assess Ventilation Performance of a Classroom Based on CO₂ Monitoring*. Place: *Indoor and Built Environment*, no. January: 1420326X2110587.

Accessible Public Space: Spatializing Adolescent Girls' Fears on the Urban Fringe of Hyderabad, India

Lyndsey Deaton¹

¹Clemson University, Clemson, SC

ABSTRACT: Building on the work of Kevin Lynch and Louise Chawla, this research investigates accessible public space by exposing the gendered spatialities in Ishaan Nagar, a dispossessed community that has been informally resettled beyond the urban fringe of Hyderabad, India. The context of dispossession has rarely been studied in relation to children's environments and this work seeks to contribute the discourse by revealing transferrable findings about the significance of gender in these communities. I ask questions such as how do adolescent girls decide where to go in a community with "no place to play" and how does the experience of dispossession shape their routes and spatial patterns outside of the home and school?

After recording the community's oral history of dispossession, I applied an inductive research methodology and qualitative methods to answer these questions. Over a period of two years, living on the fringe of Hyderabad and collaborating with Ishaan Nagar, I collected and analyzed over 136 photographs taken and 11 maps made by teen residents, 100 hours of site observations, and 50 hours of audio recordings with teens, community advocates, and government officials.

This work has led to preliminary conclusions suggesting that adolescent girls' fears dictate their spatialities. In my paper, I expand upon the political and social factors that have led to these fears, my methods, and discuss the impacts of the architecture on adolescent girls' socialization and social reproduction. This work was sponsored by the Sasakawa Young Leaders Fellowship Foundation and received in-kind support from the Hyderabad Urban Lab.

KEYWORDS: Child-Environment, Community Health, Sustainable Development Goals, Public Space, Gender

INTRODUCTION

The United Nations' Sustainable Development Goal 11: Sustainable Cities and Communities includes requirements to support children's welfare through better environmental design. Their Child-Friendly Cities program provides detailed requirements and assessment tools to ensure cities, especially public spaces, are accessible to children. Child-environment scholars agree that public space is critical for adolescents in the lowest-income communities as it offers space for independence, identity-formation, and watching others. Specifically, adolescents (aged 12-16) are physiologically developing their frontal lobes, which forms their identity and deep perceptions of the world around them.

In *Growing Up Global*, Cindi Katz (2004) examined the processes of development and global change through the perspective of children's lives in two seemingly disparate places: New York City and a village in northern Sudan. Using an ethnographic approach, she worked with a small number of adolescents concentrating on their work and play. Katz was able to draw unsuspected connections between these geographies along the lines of the capitalist system. Katz's approach was not exclusive to her field of anthropology. Prominent architects such as Lynch (1977) and Chawla (2002) have also used multi-sited trans-national case studies with adolescents to tease out the impacts of urbanization. Following their lead, I used a case study model to investigate how adolescents use public space in the dispossessed community of Ishaan Nagar. Highlighting the voices of girls in these communities, this paper shows how dispossession has gendered consequences that lead to spatialities of inhibition.

1.0 SPATIALIZING DISPOSSESSION

Cyberabad is a large development composed of a series of Special Economic Zones for Information Technology and Financial Services companies on the periphery of Hyderabad, India. It was planned to leapfrog Hyderabad into the professional services sector following the design precedents of Malaysia's Cyber Corridors and San Francisco's Silicon Valley through the neoliberal redistribution of municipal and state resources. In the process of progress, however, the government dispossessed seventeen informal communities (villages) of their land (Das 2015, p. 15). While it is clear that India's informal urban villages are prone to unsafe and hazardous conditions, I argue that erasure has dangerous social and environmental consequences.

The construction of Information Technology campuses in HITEC City/Cyberabad predates the support fabric (e.g., residential communities, social services, and commercial centers), which resulted in rapid, unplanned growth. The

Multi-National Corporation campuses have the privileged status of Special Economic Zone, which enables them to circumvent municipal taxes. As the city has metastasized, it could not keep up with developmental needs, and smaller, grassroots development projects (e.g., thousands of illegal two-to-four-story apartment buildings) have sprung up to address the housing demand. Funding for public spaces, utilities, and services has been heavily strained, because both of these property types, the Special Economic Zones and the informal apartment buildings, contribute to the city's tax base. However, when state resources are scarce, not all city residents are treated equally. The Special Economic Zones continue to receive the benefits of improved stormwater and transportation infrastructure, high-speed dedicated utilities, and privatized public spaces while the surrounding informal, low-income communities struggle to make do with dirt roads that flood every monsoon season, intermittent utilities, and fee-based access to public spaces. For example, the Shri Kotia Vijayabhaskara Reddy Botanical Gardens, which is the only public park in Cyberabad for open access (versus a pocket park or neighborhood park), charges an entry fee of 15 rupees per person, making it inaccessible to the poor as described by some of the adolescents I worked with.

Hyderabad 2020 (the city's Master Plan) identified pre-existing villages "underneath" the development plans for the Cyberabad Metropolitan Area (Hyderabad 2030).¹ I went to each of the eight locations, which were indicated on a map through hatching, and only found evidence of three rapidly gentrifying villages (Gachibowli, Madhapur, and Kothaguda) and one village that was nearly encroached on all sides (Nanakramguda). After persistent inquiries about the whereabouts of the other four villages, local contacts revealed the location of one village (Ishaan Nagar) that had been informally displaced to the urban fringe in a manner that I liken to attempted erasure. The government erased the remaining three villages, and their names remain unknown to me.

The leaders of Ishaan Nagar had serious reservations about participating in the study because repeated displacement by politicians and official figures instilled in them a strong sense of vulnerability. Their community leaders initially voiced concerns that this study would reveal their location and open them up to challenges about their community's legitimacy. At the end of our meeting, we decided it was too risky to include Ishaan Nagar in the study. However, a few weeks later, I received a call from Charvi, the head of the women's group, requesting we discuss the matter further in person. This time, two other leaders were present. Their fears were the same, but something new was also expressed—anger over their story not being told. The leaders heatedly made their case that they have been constantly shifted, because the government operates as if they do not exist. In this second conversation, their fears of being another "erased village" were outweighed by their determination to be heard and to be recognized. We worked together to develop protocols to ensure their community's identity would not be revealed while their voice was represented.

2.0 ISHAAN NAGAR CASE STUDY

This paper engages a subset of data, the Ishaan Nagar case study, from a larger ethnographic research project that includes work with three dispossessed villages on the urban fringe of Hyderabad. Many of the findings about adolescent's access to public space within and around these dispossessed communities are transferrable but the autophotography data from the Ishaan Nagar case study elucidates girl's perspectives. While this paper highlights some of the Ishaan Nagar data such as the six interviews with community representatives (elders) and 11 interviews with teens and the 136 photographs they took, the findings were inextricably informed by concurrent and iterative interviews with 26-teenage residents across the three communities and interviews with 14 community representatives, four government officials, three building professionals, and three related non-profit representatives in the child-services sector. Their voices will be integrated when they color the interpretation of data, the selection of play spaces, and the development of themes.

On the methods of photovoice, social scientists established it in the 1970s according to Balomenou and Garrod (2016). The technique involves giving participants cameras to take photographs that represent a particular theme. The researcher analyzes images through qualitative techniques, such as discourse analysis, or quantitative techniques, such as frequency-based content analysis (Chambers 2012). The maps could also be used as prompts in interviews. Balomenou and Garrod argue that incorporating photovoice into a mixed-methods research design enables findings to be triangulated and allows for greater confidence in the finding's validity (Balomenou and Garrod 2016). Dodman notes that the autonomy the method gives to participants is a strength (2003). Stedman et al. add, "It also empowers participants to express concepts and feeling that would not ordinarily be possible using verbal interview techniques" (2004). Other benefits include the reliance on visual media by offsetting the monopoly of data that relies on words and the reflexive nature of the method (Dakin 2003). Furthermore, photovoice is a common method used in child and youth studies (Dodman 2003).

Following the first phase interview, I provided participants with a single-use, point-and-shoot camera and asked them to take photographs of hangouts over a one-week period. I trained the participants on how to use the camera and guided them through the exercise of photovoice. At the end of the photovoice period, either a research assistant or I collected the used camera from each participant and developed the film. I conducted preliminary qualitative and frequency-based content analysis using the photographs. I combined these results with the first phase interview transcripts to develop interview questions for the second phase interviews. Some of the participants needed more time to complete the exercise or more motivation. Before the second phase interviews, I gave the participants the developed photos and asked to identify each location on a map of the community. Then, I gave them a worksheet and asked to

write a caption for each photograph. Our instructions described the captions as a short statement or description of the place in the photo that they might put on social media. The caption exercise helped me to understand why the space in the image was important and what my focus should be on; this process was a way to calibrate the adolescents' perspectives. After analyzing the interviews with teenage residents, I identified four possible "public play spaces".² My research team and I conducted four site observation sessions in one-hour blocks (reported in 15-minute increments) using behavior mapping to document patterns of use in each space (four hours/site spread out between morning/afternoon and weekday/weekend).³ Behavior mapping is an objective observation method.

2.1. The Process of Dispossession (Again and Again and Again)

Ishaan Nagar is an example of displacement and resettlement. Through iterative interviews with the members of the Gram Sabha (a non-official town sub-group, such as a village), a women's group, informal conversations with the parents of participating children, GIS data, aerial photographs, and archival data I was able to trace and substantiate the community's spatial history. The core of the present-day community has a multi-generational history back to the land that is now an SEZ for an Information Technology multinational corporation in the Financial District of Hyderabad. When the land was grabbed for the SEZ in the late 1990s, politicians and city officials shifted the community further out of the urban periphery but conflicts with existing communities as well as more land grabs meant multiple shifts. Presently, the community has rebuilt itself adjacent to the Outer Ring Road on former agricultural fields seven miles away from their origination site. Due to credible concerns of retaliation, no identifiable photos of this community are provided, and effort has been made to remove distinguishable details.

The community is difficult to access unless you know where you are going. It is not noticeable from the raised Outer Ring Road, but the heavy trucks and traffic can be heard from any point in Ishaan Nagar. The low profile of one- and two- floor houses, as well as a few small trees and significant amount of dust, aid in cloaking the community. Mostly, it is composed of single-family detached, *pucca* and *kuccha* houses laid out in lots on a planned grid with dirt roads in-between.⁴ There are four *kirana* stores, a dairy kiosk, two primary schools (one government and one private), a small hotel, a lady's tailor, and a closed clinic (or perhaps never opened). Due to the questionable legitimacy of the community, the municipality would not provide any demographic information. My team conducted a field survey and found 843 occupied houses. Considering the average single-family size is five people (approximately the national average), I estimate the population as about 4,200 residents.

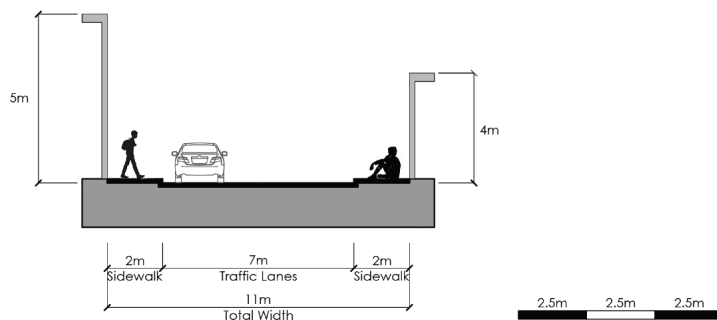

Figure 1: The residential streets were between 3-5m wide (Source: John Gonzales with author edits 2021).

A group of strategic-minded women in the community have come together to form a Dwakra Mahilalu (Women's Self-Help Group) that has tangibly influenced the development of the community by mobilizing capital through monthly collections. Through their savings program, they have paid for paving two roads and digging a water well. While the community falls under a Gram Panchayat (smallest level of local official council, often for a small town), this Dwakra Mahilalu was the most locally respected and integrated body in the community. Our research team worked with these women to carry out the research protocol by providing updates at their meetings. The leader of the Dwakra Mahilalu, Charvi, was an original resident and held esteem with both the women and the men of the community as the main business proprietor and as, possibly, the only woman who could read and write in the village. Charvi owned the dairy kiosk and the hotel.

Multiple interviews with Charvi and two others, Saanvi, and Prakash, who are ward members on the Gram Sabha, were the foundation of the oral history of the community.⁵ The original community consisted of predominantly Vaddera Caste people (considered semi tribal⁶) whose traditional occupation was stone cutting/stone-quarriers but also some Lambada Caste people (classified as a Scheduled Tribe) who were construction laborers. Historically, the Vaddera people were nomadic and traveled for their livelihood by cutting the endemic boulders around Hyderabad for development. But, as the nation modernized, their way of life did too. They settled in the 1980's on land presently identified as the Financial District but still retained their livelihood in the stone-cutting trades. The villagers never held *patta* for this site but felt secure to construct homes and develop livelihoods as the land was designated for charity by the local Waqf Board. Land managed by the Waqf Board has been donated and identified under Islamic law to remain for charitable purposes, such as for use by low-income groups, indefinitely.

However, the development scale at which the various projects for Cyberabad were undertaken justified importing new construction technology and tools with which the Vaddera were unfamiliar. Their hand-labor was quickly replaced with heavy machinery and construction crews from the northern and eastern states who were willing to work longer hours for less compensation. The new development took away their livelihood but also grabbed the land they lived on too. The municipality under Chief Minister Naidu transitioned the Waqf land to the Telangana State Industrial Infrastructure Corporation who then developed it into SEZs for multinational corporations. The community protested but without *patta* and/or designation as a Schedule Tribe (with restrictions on displacement), they were not able to file a court case.

They were given an eviction notice in early 2000. Their first shift was to another village about four miles from their original site. However, the people of that village were not receptive and fought against the Vaddera's proximate resettlement.⁷ After a year or so the Vaddera community shifted a second time. They settled on an abandoned industrial site six miles from their original site. However, the owner of the private property discovered their occupation and initiated actions against them forcing them to shift a third time, about seven miles from their original site. After staying for a few years, the area was identified by the government as the route for the Outer Ring Road (tollway). Again, without *patta*, they had no recourse. Through constant campaigning to the local panchayat (elected official) and to the municipal government, when they shifted a fourth time, it was to land adjacent their site on the Outer Ring Road and they were given *patta* for 60 square meters of land per family. Charvi noted that in the original agreement the government would provide materials for constructing houses, but these resources were commandeered by local politicians who sold the materials or used them to build their own houses.

The area of land provided was located too far from the city to support their traditional way of life and it was not enough area to support agricultural subsistence, so the people became dependent on service jobs within the city. Ishaan Nagar has no access to public transportation and the villagers have limited options to access service-based livelihoods. The Dwakra Mahilalu organized a system of ride sharing for villagers who need to access the city by securing a monthly payment plan. Some of the women have managed to secure employment as housekeepers in the financial district and some men as auto drivers through this system, while others send family members off to live on construction sites for manual labor and remit money.

Their tenure security still feels precarious, and many residents have shown hesitation to invest in their homes and the community. Because they are "outsiders" (lower caste and many considered migrants) they have not been identified as a "revenue village" or "revenue habitation" even though they have been at this site for nearly 15 years. Without one of these designations, they have no way to collect the provisions and entitlements given by the State and Central Government through the Anganwaadi Center system (providing support to young children). After so much struggle and the continued challenges of livelihood, many original residents have sold their *patta* and returned to their ancestral village or to an informal community with closer proximity to livelihoods.

2.2. A Lack of Accessible Public Space in Ishaan Nagar

When asked about their childhood experiences, the village elders, and the women of the Dwakra Mahilalu were mostly confused by the question and possibly uncomfortable. As in many communities with scarce resources, teenage girls are "married off" at a very young age. Many of the women described marrying around the age of 16. Their pre-teen and teenage years were spent on domestic work inside their paternal family home and after marriage they were spent on domestic work in their husband's home. Some women had attended primary school but only Charvi had attended secondary school. Questions about how they "played" as teenage girls were difficult to translate. On the other hand, adult men answered the question easily. For example, Prakash from the Gram Sabha told us that his teenage years were filled with playing outdoors – climbing the foothills, hunting small animals, and playing cricket - but he also took up much needed work for his family around the age of 16.



Figure 2: Ishaan Nagar is located along the new Outer Ring Road between agricultural fields and completely removed from the urban context; I identified four spaces for behavior observations. (Source: Subik Shrestha & Author, 2020).

While the women remembered domestic childhoods dominated by themes of labor, they also reflected on their access to public space. They spoke of going to the open street market for food and of walking unescorted to the temple in the mornings. These moments outside of the house and in public spaces afforded them a sense of independence and a chance to engage with other girls in their community. These same women responded with concern when they I asked where their children play in Ishaan Nagar. “They don’t” was the most popular answer. The community is remotely located and surrounded by spacious agricultural fields. There is no market, no shops, and the only temple is commandeered with parking spaces. Their perspectives were reinforced with findings from the iterative interview process with the teens suggesting very few spaces held promise as public hang-out spaces. The adolescents suggested the street in front of their houses was the only space outside of their house and school that they were able to hang out without fear. Some boys added that a vacant field behind the community was a popular spot. In my investigation, I also studied the temple grounds and the shoulder of the nearby Outer Ring Road (as indicated in Figure 2) to observe and map user behavior. I selected the spaces for diversity of themes, locations, and space types.

3.0 SPATIALITIES OF INHIBITION

The street in front of the house was the only “genderless” public space where adolescents hung out regularly. In the other spaces, few children played and when any, always young boys. The conundrum of Ishaan Nagar is the contrast of adolescents claiming that there is no place to play while from an architectural lens there are many open and undeveloped spaces. However, a deeper analysis reveals a few reasons for adolescents feeling that these open spaces are not accessible spaces for play, and they largely center on fears.

The first is a low sense of community cohesion that results in parents being very protective of their children. In other communities that I worked with the geography was organized largely by caste and historical relationships; families lived near cousins and extended families from the same ancestral village. However, due to the location of Ishaan Nagar directly off the Outer Ring Road, the constant shifting of the Vaddera community, and the many original residents selling their *patta* to outsiders have all resulted in a complex and diverse human geography in which families do not inherently trust many of their neighbors. Stories of human trafficking, fighting and riots, drinking in the streets and theft abounded - always about “those people” living down the street or related to the Outer Ring Road. Parental fear evolved into strict rules that governed children’s landscapes, especially for teenage girls. It was not just the parents who were scared; children were inhibited on their own, too. Many reported that they didn’t have parental rules but felt uncomfortable to go out of sight of their house. The third reason is architectural; open spaces were “too open,” no shade, no place to sit, no equipment to play on. When children are comfortable, they will make anything into a play space such as the vacant lot. In interviews, the adolescents of Ishaan Nagar were generally uncomfortable to leave their street citing concerns with the lack of amenities in the peripheral open spaces. However, when combined with fears, their concern for amenities began to make sense – “anything” can happen in spaces that are not clearly defined by fences, benches, and paths; their skin will darken in spaces without shade (negatively affecting standards of beauty for young girls), etc. The interviews with adolescent girls in Ishaan Nagar and especially the photovoice exercise revealed spatialities of inhibition. As shown in Figures 3, 4, and 5, when girls were asked to take pictures of where they hang out, they took pictures inside, behind high walls, with guarded entrances. In the following sections, I describe two adolescent girls’ perspectives based on their interviews and photovoice and then use behavior mapping to test transferability across the community.



Figures 3, 4, & 5: Photovoice from girls in Ishaan Nagar (Source: enrolled study participants 2019).

3.1. Reethika’s Perspective

Reethika was very soft spoken but not shy. She wanted to be a seamstress and didn’t find school useful. She was helping her mom in the courtyard both times that we met her. She moved to a much smaller within Ishaan Nagar during our interview process. The second house had a shared outdoor space in front and Reethika and her mom only rented one small room. There was no kitchen and no bathroom. Her mom complained to us that they had been renting the other house for some time but then one day the landlord came and said that he had enough money to build a proper house, so he evicted them. They had to leave the same day. Her husband had abandoned them, so she was upset about moving her things so quickly without help. She said they bulldozed their prior residence a week later. Her tenancy was off record so there was nothing she could do to protest it.

Reethika's mom stopped the first interview because she didn't understand why we were interested in Reethika's perspective... "what will a kid know about it? I suggest you ask me the questions." But after we explained the project (again) she let us continue. The second time we visited the new house and the mother brought out a large mat for us to sit on in the courtyard. The mother sat near us but was completely uninterested in the conversation and mostly peeled corn while we talked. Reethika was not really interested in the questions but was more interested in the mapping exercise. She didn't understand the maps, so we helped her through them. My research assistants thought that Reethika was hiding things about her experience in Ishaan Nagar. Since she was uncomfortable, we did not push her to answer but this limited our understanding of her experience.

Reethika moved to Ishaan Nagar four years prior from Nizamabad. She liked her old community better. She said there were good roads there and trees that she could sit under and talk. She went to school when she lived in Nizamabad. She dropped out of school in 5th grade, around the time her family moved to Ishaan Nagar, because she had an "appendix problem" and "forgot everything" after she healed. Her daily routine was to bathe and then work at home for about two hours before going to play for about four hours and then return to work. She played with her five local friends just in front of the house on the street. They liked to walk around and go to the shops and buy snacks like chocolates and biscuits. They walked casually, talking, and strolling on the roads here and there. She played in the street because "there is no other place." She didn't like the dirt roads and she didn't like that there was no ground to play. There were no streetlights, and she didn't like that. She added that there was no running water in the community and that her mother had to buy the water from a tanker. She added that the drainage system was bad too and there wasn't a proper *nahani* trap (floor trap for the bathroom).

She said that sometimes people drank in the evenings but that was why the kids just played near or inside of their houses. They played hide and seek and running games. However, in her second interview she gave more explanation about the accessibility and comfort of the spaces she played. She felt unsafe at night. In the mornings she went wherever she wanted to but not at night. She also added that she never goes anywhere alone because she feels unsafe. In the mapping exercise, she said that the field behind the community was a "boys' space." She also told us that once, she played near the temple but was scolded by youths who said that it "was only for boys," so she hasn't been back since. She also pointed out an area to the south of the community where the dogs scared her... and said that she conformed her routes to go around street dogs but that limited her to just two streets. She showed us an area near the highway where she hung out with her friends in the early hours of the morning.

3.2 Smija's Perspective

Smija was shy. She was a teenager that spent most of her time boarding at the hostel and was rarely home. Her house was small and on a dirt road. It had a small broken step and broken gate. The house faced south and in plan had a narrow hall that fed to two or three rooms. Smija said she felt more comfortable to give the interview at her neighbor's house, so we did. I speculated based on her behavior that the reason she didn't want to do the interview was because of issues at home and she didn't want to get caught saying something that her father would overhear (as she spoke of domestic violence in the community perpetrated by the adult men in a way that hinted at her own experiences).

Smija had been going for three years to the hostel called MJP Telangana Welfare Residential Educational Institutions Society, which was located 27 km or a 90-minute drive from Ishaan Nagar. While she left for the hostel after Diwali and we were never able to get access to the hostel for the second interview, her first interview was insightful. She was born and raised in Ishaan Nagar. She preferred the hostel because both of her parents work so she was left home alone a lot. She recalled when she was a day-scholar at the local school that she had a friend who lived in Kollur (2 km up the highway) and she walked there once alone to play with her friend and was scolded by her mother:

Why are you roaming? Are you big now? Girls should not go alone. Here, boys and youth are not nice.

In the hostel, she lived in a single-room dormitory with 40 other girls on a regimented schedule. Wake up at 5:00 am for exercise, 6:00 am free time, 7:00 am breakfast of milk and ragi malt (porridge) and so on throughout the day, every day of the week. She was on the volleyball team, and they won first prize at the zonal level. She was not allowed to leave the hostel without written permission. Her parents visited her a few times when she started, but now they only come to fetch her for holidays. She had a lot of friends in the hostel and there was a ground. When viewing aerial imagery of her hostel, there is a ground surrounded by trees in the courtyard and a medium park across the street.

She said that there was "no place to play games and no equipment to play on" within Ishaan Nagar. She only stayed at home and watched movies on her phone or listened to Telugu songs. She added that there were "only boys here" so she didn't like to be outside. She wanted to improve Ishaan Nagar by prohibiting alcohol. She said that on Sundays, "They will drink, and they will fight with each other's wives. I don't like that." Specifically, the ground on the back side of the community (open field) was only for boys. There were only small children to play with; most of the kids her age attended boarding school. She explained:

Most of the girls do not come outside. They stay in the home only. So many teenagers stay in hostels and only come back to Ishaan Nagar during holidays. The community is empty.

3.3 Behavior Mapping

Through behavior mapping, I assessed four public spaces that regularly came up during interviews with teens. The *kirana* store (number one in Figure 2) was in a converted house on the corner of one paved and one dirt street. It offered a justification for sitting. From this location, our team was able to view children playing just outside their homes. The streets were filled with children in the early morning and again from after school until just before dusk. Monday through Saturday, the children were dropped off at the bus stop next to the Outer Ring Road and walked as a group down the lane to their house. After checking in with parents and having a snack, many returned to play in the street. Young children ran excitedly up and down the street with secret agendas while teenagers walked or sat and talked with friends. Some lucky children had bikes and would take turns riding while their friends ran behind. At sunset, as the children returned home, adults assumed their place on the street. Women would gather and talk and prepare food on their stoop while men would walk the streets leading to less sounds of youthful laughter but a continued ambiance of safety. As the evening shifted into night and service workers returned from the financial district, some on the street retreated to their homes while others remained on the street drinking homemade alcohol and smoking, shifting the ambiance to a distinctly hostile tone. Massey's concept of "spatiality" is clear at this site where temporality dictates drastically different environments on the same streetscape (Massey 2005: 10-11).

The second site for observation was the barren agricultural field overgrown with grasses and shrubbery just past the hard, western boundary of the community used by some as a ground (number two in Figure 2). It was fenced with four formal gates that opened between the community and the fields without supporting roads. In interviews, both girls and boys told of male teenagers that "hung-out" in the fields. Girls would never go there without a male escort because of fears about what could happen to them or be said about them if they were in such a place unsupervised. The tall grasses inhibited formal games like kabaddi and cricket but were perfect for constructing small and secret "forts." Walking through the field, I found traces of toys, books, blankets, wrappers of candies and salty snacks. Observations and mapping revealed distinct territories within the field. The northern entrance was for women of the village to relieve themselves and was strictly guarded and off-limits although not materially partitioned.⁸ The middle entrances were used by the teenage boys to come and go on foot. The southern entrance was used by adult males, often on two-wheelers, who ventured much farther into the fields and out of sight beyond.

The third site, the temple ground (number 3 in Figure 2), was not regularly mentioned by the children but was traditionally a space of gathering. I questioned why it was not used as most children complained of the lack of open space in Ishaan Nagar. Through the observations and behavior mapping, I found that the openness of the space was dangerous in a similar way to the fields – there were limited "eyes on the street." The temple was small and located on a vacant block surrounded by dirt streets to the north, east, and south and a dirt ally on the west. The block had a natural slope, but some earthwork left the southern side infilled about five feet above the dirt road below and inhibited visual access to the homes on the south side. The alley was framed by a continuous wall with little fenestration composed of the back of the east-side houses. The houses on the north-end of the quad were also oriented to side streets, leaving solid walls to face the temple ground. The home orientations and earthwork meant that only the houses on the east side faced the temple ground but two of those were wrapped with exterior courtyard walls. During the observation period, a differently abled teenage boy came alone and flew his kite near the temple. Moments later, an older teenage boy came by, bullied him, and took his kite. No adults or other children were present to intervene, and this was known by both children.⁹ The victim returned home while the bully continued to play with the kite for some time until he discarded it and walked to another destination. The ground was empty for the remaining afternoon. While the ground is a great community asset for gathering families and staging tents and food on holidays like Diwali, it is too private for children to feel safe and indeed, to be safe.

The final space observed was near the bus stop on the main access road to the Outer Ring Road (number 4 in Figure 2). Some children mentioned lingering here while waiting for the bus and two teenage girls admitted to the thrill of walking along the road together alone. The observations revealed a less thriving public space. The area was an oblong-shaped dirt lot on a hillside. It was used for some mobile tiffin vendors and for auto and truck drivers to park and nap. Each day, hundreds of trucks passed this site (mostly carrying construction materials to and from the financial district). While some villagers would walk as a family along the service road into the neighboring town or through the Outer Ring Road under pass to an adjacent village, our research team never witnessed any children playing in this area.

The agricultural fields, temple, and the bus stop were dangerous spaces for children and infrequently used. The temple at Ishaan Nagar had potential as a "pocket" public space but failed to focus the architecture or layouts of the homes, instead the homes were most commonly oriented away from the ground and toward the side street. Even with scarce resources, many houses constructed plinths or extra steps for families to sit on and watch as their children played suggesting a hierarchy in which the residential side street has become the dominant form of public space in practice. The wealthier families embellished their houses with plumbing, with a second story, and with courtyard walls that enhanced their security but also extended their children's landscape for safe play. I noticed that the girls who lived in houses with courtyards more often spoke of active play such as dancing, *kho kho*, and *kabaddi* while the girls who lived in houses without courtyards (and without access to them) spoke more about sedentary indoor activities such as reading, homework, and helping to prepare food.

CONCLUSION

The price of progress in Cyberabad is dispossession of low-income and Schedule/Backward caste communities from urban areas to cheaper undeveloped land. As described through the Ishaan Nagar case study, displacement and resettlement come at a high cost to adolescent girls. Their spatialities are highly sensitive to predation leading to over 16 unique fears identified through interviews. In these barren landscapes where open spaces abound, the architecture of the community and the lack of urbanity means that these spaces are not accessible to adolescent girls.

Adolescent girls in Ishaan Nagar rarely go outside of their home and when they do, they hang out directly in front of their house during daylight hours and when their parents are nearby. This is in sharp contrast to the interview with boys who play near the temple, who have developed a make-shift ground in a nearby open field, and who trapse along the highway. This research signals that dispossession shapes adolescents' spatialities with divergent impacts on gender.

ACKNOWLEDGEMENTS

To the communities that invited this work and the research assistants who made this work contextually appropriate and fun for the kids – Santhosh Tekumal, Ayesha Ateekh, Soniya Agarwal, Ramya Mudapaka, Sanjana Bandaru, Sekhar Ankani, and Prakash Gadipe. To Subik Shrestha and John Gonzales for their support in developing graphics. To the Sasakwa Young Leaders Fellowship Fund (SYLFF) for making this fieldwork possible. Thank you.

REFERENCES

- Balomenou, N. and Garrod, B. 2016. "A Review of Participant-Generated Image Methods in the Social Sciences," in *Journal of Mixed Methods Research* 10 (4): pp. 335-351.
- Chambers, D. 2012. "The [in]discipline of visual tourism research," in T. Rakick & D. Chambers (Eds.), *An introduction to visual research methods in tourism*. London: Routledge. pp 33-50.
- Chawla, L., (ed.) 2002. *Growing up in an Urbanising World*. London: Earthscan.
- Dakin, S. (2003). "There's more to landscape than meets the eye: Towards inclusive landscape assessment in resource and environmental management," in *Canadian Geographer* pp.47: pp. 185-200.
- Das, D. 2015. "Making of high-tech Hyderabad: Mapping neoliberal networks and splintering effects," in *Singapore Journal of Tropical Geography* (36): pp. 231-248.
- Dodman, D. (2003). "Shooting in the city: An autophotographic exploration of the urban environment in Kingston, Jamaica," in *Area* 35: pp. 293-304.
- Katz, C. 2004. *Growing Up Global: Economic restructuring and children's everyday lives*. Minneapolis: University of Minneapolis Press.
- Lynch, K. 1977. *Growing Up in Cities: Studies of the Spatial Environment of Adolescence in Cracow, Melbourne, Mexico City, Salta, Toluca, and Warszawa*. Cambridge: MIT Press.
- Massey, D. 2005. *For Space*. London: Sage, pp. 10-11.

ENDNOTES

¹ I use the term "underneath" because the plans showed a hatched area where villages (are/were) but did not impact the streets, zoning, or utilities. It was as if the 2020 Plan was overlaid on the existing map with minimal relationship.

² The spaces included streets with shops, alleys between houses, abandoned lots, pastureland, and temple grounds.

³ For safety reasons the research team was not able to be present in the communities after 7 pm or before 7 am. From personal experience and interview findings, there is a rich night life to these spaces as adults return from work. This is an important aspect to understand the dual work of these community spaces that are public in practice.

⁴ The Hindi terms *pucca* and *kuccha* are typical ways of categorizing housing in India largely referring to the quality and materials used in construction. A "pucca" house refers to a solid house while a "kuccha" house refers to a flimsy house.

⁵ Charvi, Saanvi, and Prakash. (2019) Interview with Santhosh Tekumal, Prakash Gadipe, and Lyndsey Deaton on October 5; Charvi (2019) Interview with Ramya Mudapaka, Sekhar Ankani, and Lyndsey Deaton on October 11; Charvi (2019) Interview with Santhosh Tekumal, Ayesha Ateekh, and Lyndsey Deaton on November 17.

⁶ The Vadderas have been campaigning the central government for classification as Scheduled Tribes. For the latest information see *Vaddera Times: The Voice of Vadderas* (2020) accessed at <https://vadderatimes.com/>; and, VSSS (2020) accessed at <https://www.vsss.info/en/vice-president-blogs/vaddera-caste-name-or-social-group>

⁷ As explained by VSSS (Ibid), "the stone cutting Vaddars are considered the principal criminals, and by going about under the pretense of mending grindstones they obtain much useful information as to the houses to be looted of parties of travelers to be attached..." "child labor is common among them..." "they are considered a menial caste."

⁸ The community did not have running water or septic lines. Some residents (I came to know of only 3) had paid to have private septic tanks installed and charged Rs. 2 for neighbors to use the latrine. However, this was typically only done for adult males. Village women still took to the open fields during the early hours of the morning.

⁹ I wrote “no adults” because I excluded myself, the translator, and the community escort as we would not normally be present. While we did not make attempts to conceal ourselves neither did we draw attention to ourselves. We observed the space from a street corner. However, that this scene played out as we observed, speaks to the assumed lack of bystanders regularly present on the site. Ethically, I practice child safeguarding and engage as these principles dictate.

Analyzing Effective Variables to Explain the Ratio Preferences among Autistic and Non-Autistic Children

Pariya Sheykhmaleki¹, Seyed Abbas Agha Yazdanfar²

¹Department of Design, Texas Tech University, Lubbock, TX

² School of Architecture and Environmental Design, the Iran University of Science and Technology, Tehran, Iran

ABSTRACT: *Purpose:* Despite the prevalent use of the golden ratio in the environment design for autistic users, there is no experimental research that explains their desired space ratio. This study aims to find the desired ratio in the learning environment, like an occupational therapy room for autistic users, while considering effective variables on their choices.

Methodology: Based on McAllister's (2012) study, a scale model inspired by a dollhouse has been chosen to work and play with autistic children directly and find their desired space ratio. Meanwhile, the furniture configuration and the access type in the environment could also define the ratio for interviewees. Accordingly, the scale model was designed with six different scale rooms containing three ratios and two spatial access types represented by the furniture arrangement. 50 autistic children of different ages, genders, and disorders in the moderate and medium spectrum have been randomly sampled. Then, they were asked to choose their desired ratio by playing with the scale model and putting the doll in their preferred room. This study also included 50 non-autistic children as a control group with different genders and defined ages.

Result: After interviewing both groups, the chi-square test with Cramer's V calculation analyzed the result to find the statistically significant correlation between control variables, among which two independent variables had a statistically significant correlation with the chosen ratio for all the interviewees. First, being autistic significantly impacted their desired ratio choice as autistic children went for a ratio of 2:5, and no autistic ones had a high tendency toward the golden ratio (1:1.6). The chi-square test also showed that the access type in the scale model was the effective variable for both groups when choosing their desired ratio. *Conclusion:* The access type of the room with its furniture configuration impacted how users perceived the room's ratio, as well as being autistic or non-autistic users.

KEYWORDS: Autism Design; Autistic Children; Non-autistic Children; Ratio.

INTRODUCTION

Regarding the drastic increase in the number of diagnosed autistic children in this century, much attention has been directed toward providing appropriate design for autistic users, not only in early childhood to get an education but also in adulthood to be independent. The question raised how a designed environment can be effective. Autistic users are usually characterized by sensory disorders and sensory sensitivity, i.e., hypersensitivity and hyposensitivity in their sensory systems, problems in communication skills, ignoring eye contact, and lack of interest in participating in conversations (McAllister & Maguire 2012; Mostafa 2008). It has been observed that they respond to sensory information in an unusual way that sometimes may lead to torturing themselves. Environment design can play a vital role in controlling sensory information for autistic users and help their cognitive system to perceive the environment much better (Sheykhmaleki *et al.* 2021).

Although direct impacts of environmental features, e.g. thermal comfort, on human satisfaction (Mansourimajoumerd *et al.* 2023, 2020; Hoes *et al.*, 2009) has always been an issue for designers, other indirect design strategies can play a vital role in user comfort, specifically vulnerable ones like autistic users. In the last two decades, many designers and researchers have been trying to manifest environmental design guidelines for autistic users to alleviate their tensions in space. Magda Mostafa (2008), the pioneer of architecture for autism, concluded her research in the Autism ASPECTS Design Index for varied functional environments, e.g., home or school. In 2016, she addressed spatial organization and discussed the importance of sequences and order in environment design. Gaines *et al.* (2016) highlighted the importance of order in space design in their book. This strategy is regarded as helpful for autistic children to perceive their environment appropriately (Paron-Wildes 2013). Meanwhile, Humphreys (2005) claimed directly that the proportion and ratio in the environment design is one of the crucial variables affecting autistic people's cognitions. Among all the given strategies related to the importance of the proportion and ratio affecting autistic children, there was no experimental study to support which ratio is desirable, how it can be effective, and which variables impact their orientation toward that ratio.

1.0 RATIO, AUTISM, AND EFFECTIVE STRATEGIES

Ever since the environmental design for autistic users has become significantly correlated to their sensory stimulations and their response toward surroundings, many appropriate design strategies have been studied and categorized for autistic users to alleviate their environmental sensitivity. One of these effective strategies for autistic children's needs in the environmental space is the structure of the physical space (Owen & McCann 2013). This general strategy is defined by many sub-strategies like the space ratio (Humphreys 2005), defining the proportion of a room in length to width. The space ratio is one of the effective sub-strategies in environmental design for autistic users. Meanwhile, Kaye and Murray (1982) addressed that the furniture arrangement in the space design can significantly impact the ratio perception of a space. Considering the space ratio for autistic users, the furniture arrangement should also be considered.

Despite the importance of this strategy, designers still do not know the best ratio for autistic users, while the golden ratio, the desired ratio for human beings ever since ancient Greece (Humphreys 2005) has been addressed for autism design. On the other hand, generalizing this ratio to all humankind, like autistic users, may be arguable in research fields and design applications. Although Beaver (2011), like Humphreys (2005), as a professional designer in the industry, believed that spaces with a 3 to 5 ratio (golden ratio) are suitable even for autistic users and tried to apply this ratio in their design, no experimental study has supported this ratio in the space for autistic individuals. But the ratio alone cannot be significant in its perception. The furniture configuration and access type in the space can also influence the perception of the ratio (Kaye & Murray 1982). Thus, this study aimed to determine the desired ratio for autistic users in a learning environment, e.g., an occupational therapy room, under the shadow of other effective variables like demographic variables or the furniture arrangement in a room. Since it is only possible to consider some ratios and space furniture arrangements with access types, we should first focus on which ratios and space arrangements should be studied.

The repetitive ratios in nature have always resonated with delight in human perception (Khandelwal & Sahni 2005). Although the golden ratio has been well-reputed since ancient Greece in varied fields, e.g., nature, the other natural ratios have been less considered; they are still repetitive and can be studied through nature, e.g., solar planets and the ratio between the orbital distances or ratio between the flower petal rhythm (Rawat 2015). Some frequently repeated ratios were considered as follows: the golden ratio (1:1.6), the ratios of (1:2), (1:3), (2:5), (3:8), (5:13), and finally (1:13) (Howell *et al.* 2010). The ratio of (1:2) was too close to (1:1.6), and (2:5) could also be perceived as (3:8) or (5:13). Considering similar ratios in a study might mislead this experiment because the difference could not be felt. Besides, the (1:3) ratio was lengthy and can cause an acoustic issue in a designed environment. Therefore, the ratio options had to be narrowed down to (1:1), the golden ratio (1:1.6), and (2:5).

The furniture arrangement layout in a room was studied through all the designed spaces for autistic users. Five pioneer autism designers, McAllister and Maguire (2012), Mostafa (2014), Yates (2016), Altenmüller-Lewis (2017), and Gaines *et al.* (2016), were chosen to consider their designed layout in our study. The access type between the functional zones in the room and the arrangement of the furniture, as well as the sequence of space zones with different stimulation levels, were studied in each of these samples. Based on their design layout for the sequences between varied zones and the furniture arrangement, the room layout of this study was designed. Finally, two primary access types with furniture configuration were obtained: Radial and linear access types. These two-access types can arrange the furniture in a room, either central-wise or linear-wise.

In this study, the research question sought the desired ratio for autistic users; however, measuring design strategy for autistic children is challenging. Although designers are always considered great illustrators in place-making and graphic representation, some obstacles exist in designing for autistic users. Not only do we have limited research in designing an environment for autism (McAllister & MaGuire 2012), but it is also challenging to know how autistic people perceive their environment to choose an appropriate study method (Nagib & Williams 2017). Concerning autism cognition disorder, for this study, the 3D scale model with a qualitative approach was used in which autistic children could understand the context of the architectural space with varied ratios and access types, and it became possible to work with them directly.

2.0 RESEARCH METHOD

This study modeled McAllister's (2012) research method. He first studied design strategies for autistic users in a classroom to design a scale model of a classroom and then asked teachers to participate in the designed scale model and modify it to create an appropriate educational environment for autistic children. In this study, we used the same method to determine the desired ratios of autistic users and whether other variables significantly affect their choices. The scale model rooms had this feature to be observed all in one glance to be compared by children. On the other hand, this project aimed to find other variables associated with autistic children's approach toward their desired ratio. Therefore, the scale model was the best approach for this study to find the significance. Accordingly, the designed scale models inspired by a dollhouse shaped the experimental approach as a descriptive-analytical method. The considered scale model examined three ratios (1:1, 1:1.6, 2:5) and two additional access types (Radial and Linear) by providing six scale room options to find the desired ratios for autistic users and measure the significance of each

variable on their decision. Although McAllister interviewed first-hand caregivers to modify the classroom design, autistic users had to participate in the current study to measure their desired ratio. At the same time, their first-hand caregivers also cooperated in the process. The non-autistic users were also considered a control group to measure the effectiveness of variables in this group.

To design the scale model, three main phases were established to make sure that this scale model is understandable to an autistic child and has validity:

Phase I. Conducting a comprehensive literature review to categorize effective strategies in the room design for autistic individuals and applying them to the scale model design;

Phase II. Completion of the scale model with occupational therapists in four steps: (the manner of objectification of different zones in each room, the scale model size, the color of the scale model, the material of the scale model, and doll type);

Phase III. Defining the scale model.

2.1. Phase I. The Literature Review

After reviewing 42 studies concluding on environmental design strategies for autistic users, 15 different methods were obtained, listed in the following: controlling visual and tactile stimulations (related to sensory sensitivity), providing predictable space function, perceptible space, and organized space along with the spatial sequence was effective and selective strategies. Other strategies were not effective or could not be considered in the scale model.

Regarding all the gained design strategies, the scale model had to be designed with: minimal visual information to control visual stimulation, the appropriate material that does not stimulate autistic children when getting the scale model, defining the space zones clearly, and considering sequences for the space zones in each room (sequences from high stimulation to low stimulation). This fundamental data guided this research to upgrade the scale model design with some experienced occupational therapists.

2.2. Phase II. Consulting with Occupational Therapists

As occupational therapists with many years of expertise in working with autistic children know the autistic children's cognition process and how they perceive the environment, an occupational therapist should cooperate in designing the scale model. Besides, designing a comprehensible and imaginable scale model was far beyond designing an actual room to consider all autism design strategies. Accordingly, four main factors had to be considered for the scale model design: illustrating varied space zones being comprehensible as an actual room, the scale model size, color, and doll and scale model material.

2.2.1. The legibility and comprehensibility

The functions of the occupational therapy room inspired the room design in the scale model. Three main zones were defined in the interior design, being arranged from low stimulation to high stimulation, locating the high stimulus zone in front of the main entrance while deferring the calm space far from the entrance and crowded place. To avoid additional visual information in the scale model that may lead to visual stimulation, additional furniture or partitions should be disregarded by considering minimized design elements for each zone. The first space was considered a play area with high tension in front of the room's main entrance. The colored powder was used for this zone to visually stimulate and objectify stress in space (Figure 1, area in the red box). The second space was the therapy or educational zone, where the occupational therapist and child worked together. The table with some chairs around could symbolize this zone (Figure 1, site in the yellow box). To evoke calm or escape space as the last zone in this room sequence, a bed was considered to resemble calmness (Figure 1, area in the green box). The furniture with the least details and colors had to be chosen to be understandable with the least visual stimulations. Finally, colored patches were suggested to visualize the access type (linear and radial forms) between the furniture in the room. Pieces of colored paper with carpet hatches were used (Figure 1 – zone in the blue box), so the child could understand the access much better.

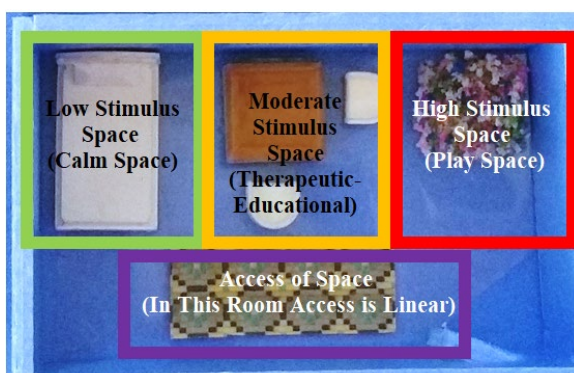

Figure 1. Space design of scaled rooms. (Author, 2020)

The Scale Parameter

Since McAllister's (2012) methodology considered scaled rooms to study autistic children, This study imitated this methodology and used a scale model. A suitable scale had to be considered so that all young interviewees could understand and use it appropriately. After preparing a few scale models and consulting with the occupational therapist, a 1:50 scale was selected as a suitable scale to design the rooms. This scale led autistic children to put the scale rooms on their legs, observe all the rooms together, and experience the room sample with their hands.

2.2.2 The Color Study

Since most autistic children suffer from visual stimulation (Sheykhmaleki *et al.* 2021), the color of the scale model could be not only effective in the autistic children's selection but also challenging to cooperate during the interview. Based on Feisner & Reed (2013), blue, red, and yellow are primary colors, and orange, green, and purple are complementary colors. The spicy colors might increase tension and distraction in hyper-visual-sensitive autistic children (Gaines *et al.* 2016). Therefore, the occupational therapist suggested that three shades of purple, orange, and red had to be eliminated from the offered options. On the other hand, three blue, green, and yellow colors had to be readily available for children's varied desires. Before the interview, Children or first-hand caregivers were asked to identify their favorite color among the colors prepared. Then, the chosen color was put in front of the interviewee to play.

2.2.3 Materials

Lastly, the scale model and doll-type material were also crucial for autistic users. Some autistic children have tactile sensitivity that the scale model material could stimulate them. The foam was chosen among all the possible materials for the scale model. The foam caused no danger for the child (in the event of aggressive reactions to the scale model) since it was lightweight and flexible. Furthermore, foam is durable and can be reconstructed easily in case of damage. The idea of an edible doll was one of the preferred options, so it would have been safe if a child swallowed the doll. However, as many autistic children had specific dietary restrictions, the soft plastic doll was used.

2.3 Phase III. Defining the scale model

This study aimed to find the effective variables on autistic children's behavior toward ratio. Except for demographic variables related to the interviewees, e.g., gender, age, and the type of sensitivity, we needed to measure two other variables (the ratio and the access type) while other variables were controlled. Concerning three scores for the ratio variable and two scores for the access type, six different rooms created the whole scale model. All these six rooms were designed with the same features except for the ratio and access type varying across all rooms. As for balance, all the rooms had the same width, and the room length changed to create varied ratios. Dimensions of the rooms in the 1:50 scale were: 3.5cmx3.5cm (1:1), 3.5cmx5.6cm (1.6:1), and 3.5cmx8.75cm (5:2). Doors with the exact dimensions and fixed locations were used while the windows were not in the same size. Windows cover the same walls with the same proportional area in each room (1:9). Furniture was also the same and put in the sequences from high-stress to low-stress space. Figure 5 shows the overall view of the scale model.

**Figure 2.** The overview of the scale model. (Author, 2020)

The procedure of interviewing had to be designed carefully to make sure the child perceived the scale model completely, and their response showed their desired ratio. Accordingly, the scale model and the doll were introduced to the child before the interview. The child had enough time to play with the rooms and touch the doll to get familiarized. Different rooms and functions were explained to the child through a game with the doll. This process was critical for autistic children to ensure they perceived the scale model as rooms. After this step, the child was asked to choose the best room for the doll (Figure 2). Then, the child's performance and reactions were observed precisely, and the child was interviewed twice to ensure that the child's decision was their preference.

Regarding the severity of each autistic child and their sensory sensitivities, the interviewing at each time for each child could take 30 minutes to 1 hour, depending on the therapist's approval regarding their perception of the scale model. The six scale model options were labeled and defined for the data analysis. Figure 3 shows each labeled room with a different ratio and access type:

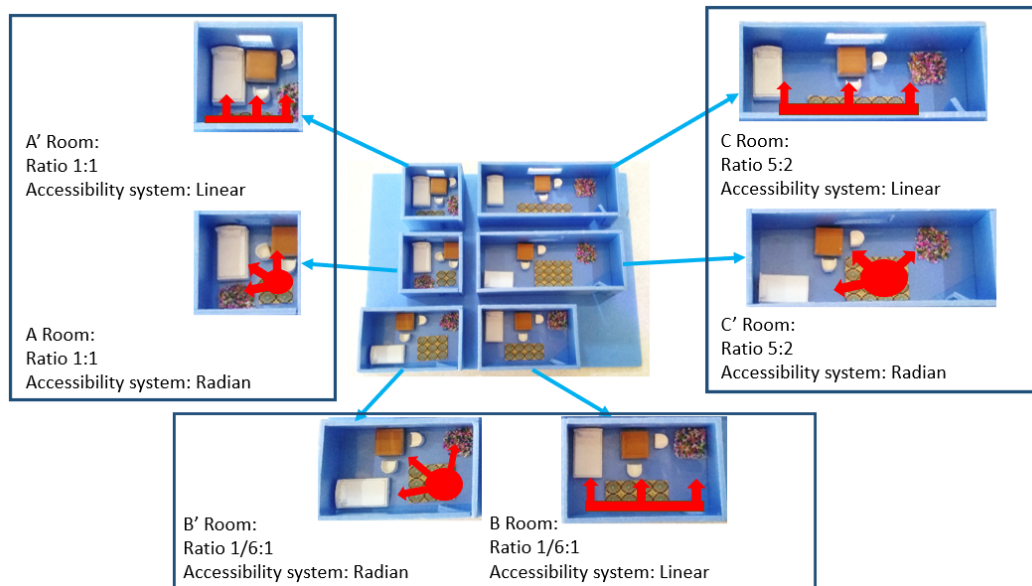

Figure 3. Explanation of each option's structure. (Author, 2020)

To increase the validity of the research, non-autistic children were also used as a control group. Based on Healey (2014), 100 cases had to be selected to meet the required assumptions for hypothesis testing and generalizability. Hair et al. (2018) also noticed that the least number of 20 cases for each independent variable is sufficient to meet the required assumption for statistical analysis. Regarding two independent variables, 50 autistic and 50 non-autistic children were observed to meet both views. The demographic information two groups were as follows:

Since this study was conducted in Iran, the research ethics certification was approved by Payame Noor University in Iran with the code of IR.PNU.REC.1399.084. As The random sampling method was almost impossible to choose autistic children and even non-autistic children, this study chose the snowball non-probable sampling method, in which the first case opted for a charitable organization in Tehran, Iran. The non-autistic children also opted in the same procedures. The age distribution of 50 autistic children was as follows: 4 to 10 years (54%), 10 to 15 years (20%), and 15 to 20 years (26%), of which 66% were male and 34% female and no intersex case was observed. These children fell into two categories of mild (46%) and moderate autism (54%), and according to the scale model conditions, it was impossible to perform the test with children with acute autism. Gaines *et al.* (2016) also classified autistic children into six sensory categories: visual, auditory, tactile, olfaction, vestibular sensitivity, and proprioception. Each category is divided into two categories hyper-sensitive and hypo-sensitive. Due to the measurement limitations, it was not possible to examine the factor of "proprioception," thus the dispersion of interviewees in the other five categories is as follows in figure 4:

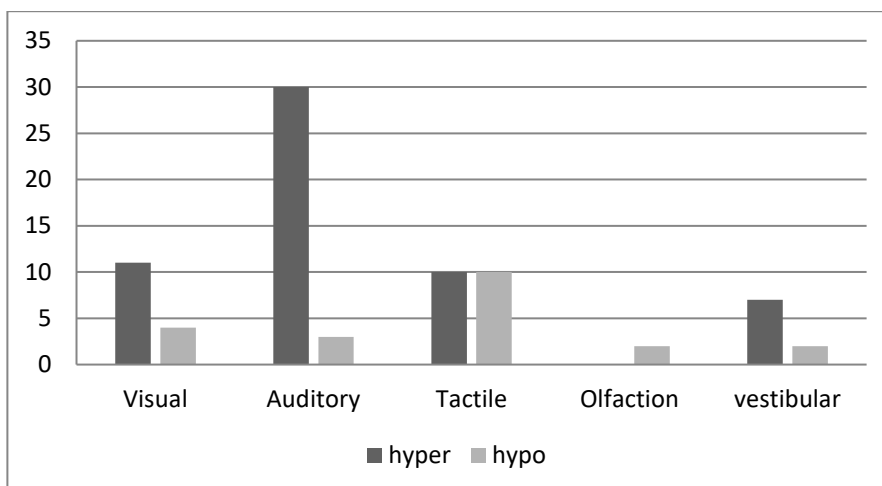

Figure 4. Dispersion of autistic children in sensory sensitivity categories.

The control group included non-autistic individuals with good cognition skills but not too developed in logical perception to mislead the study result by their analytical abilities. Piaget (2003) considered children 2 to 7 years old as being in a “preoperational stage” where they begin to learn symbolically and use imagination in games while their analytical skills have not sharpened yet. This led the article to choose non-autistic children (n=50) aged 4 to 7 years, of which 28% and 72% were 4-5 and 6-7 years old, respectively. 56% of non-autistic participants were female, 44% were male, and no intersex case was reported.

3.0 RESULT

After interviewing 50 autistic and 50 non-autistic children with the designated scale model, the frequency of their responses was measured by the time that interviewees chose each room (option). Their overall response of both groups to the scale model showed that most autistic children (64%) were inclined to a 2:5 ratio, while most non-autistic children (50%) were into a golden ratio (1:1.6); however, the effect of each variable on each group should be considered separately to see which variables were effective in their attitude toward the ratios. Accordingly, their responses were categorized based on five dependent variables (gender, age, being autistic, access type, and the sensory sensitivity for autistic children) to see each correlation with the ratio as an independent variable. Considering the nominal level of measurement, the chi-square test was chosen as a measure of association between categorical variables in a non-parametric study. This statistical test measured the statistically significant effect of each independent variable (gender, age, access type, autistic children's sensory sensitivity type, and being autistic) on the variation of the independent variable, the ratio. Accordingly, five tests were conducted (Table 1) to measure autistic children's attitudes toward the ratio; these tests were also conducted for non-autistic children. Since the strength of this association was also important in this study, Cramer's V was chosen to see how strong the relationship between the two variables was.

Table1. the chi-square and Cramer's v association test result of independent variables on autistic and non-autistic ratio preference.

Independent Variable	The chi-square test	The Cramer's V
Age (for autistic participants)	0	0
Age (for non-autistic participants)	3.51	0.26
Gender (for autistic participants)	2.56	0.23
Gender (for non-autistic participants)	1	0.14
The access type (for autistic participants)	5.33	0.32
The access type (for non-autistic participants)	10.82	0.46
Sensory sensitivity of autistic children	3.95	0.28
Being autistic	17.3	0.42

The significant relation of each dependent variable with the independent variable, ratio, was measured by the chi-square test with alpha 0.1 (marginal error) followed by the Cramer's V calculation to measure the strength of the correlation (Table.1). If the Chi-square test fell in the margin error, then the null hypothesis, i.e., the considered independent variable is not statistically effective in the considered group to choose the ratio, would be rejected. That independent variable would play a statistically important role in the ratios to be selected. Meanwhile, the Cramer's V test ranges from 0 to 1, and the closer it is to 1, the stronger the correlation and the effect size of that variable.

The result suggested that the effect size of age and gender for both autistic and non-autistic populations, and also the sensory sensitivity in autistic children on the ratio preferences, were not significant, and it failed to reject the null hypothesis. Whereas the access type and being autistic had a statistically significant association with the opted ratio, and the effect size shows a strong association between them. In other words, the access type with the furniture arrangement in the designed room and autism disorder were the two main effective variables impacting the final chosen desired ratio in all the sample of population. Although the overall result suggested that autistic children were most interested in the ratio 2:5 and most non-autistic children opted golden ratio, the access type defined in each room significantly impacted the interviewee's approach to opt for their desired ratio.

DISCUSSION AND CONCLUSION

The result suggested that autistic and non-autistic children have different tendencies for ratio. Among all the examined variables being influential in their decision toward the desired ratio, autism was significantly effective in their final approach to the ratio, as well as the access type of the space affecting the ratio preference of both groups. Meanwhile, the rest of the considered variables, such as age, gender, and the type of autistic children's sensory sensitivity, were ineffective. In other words, autistic children, regardless of their sensory sensitivity, behaved differently in choosing their

desired ratio compared to non-autistic ones. Meanwhile, the access type and the furniture arrangement of the interior design of the room have a significant association with the ratio tendency among autistic and non-autistic children. Although autistic and non-autistic people had different approaches in their ratio decision, it seems that the access type in the space had the same effect on their decision. Since both groups appealed to the radial access type in their different ratio selections, this variable affected their decision in the same direction; however, the reason for choosing this type of access in the space might be different between these two groups.

RESEARCH LIMITATION

When it comes to considering the limitation of this research, first and for most, it should be regarded that the aim of this study is not generalizing data to an actual 1:1 scale; instead, conducting a research study to alter the general perspective about the ratio for autistic users; it showed the different approaches of autistic and non-autistic sample group and effective variables on their tendency toward it. Furthermore, this research was not defined for causal study or generalizability. Instead, it aimed to find whether other variables had a statistically significant relation with ratio preferences among autistic and non-autistic children. Therefore, this research was not designated to support internal or external validity to provide generalizability.

In this study, the scale model was designed on the 1:50 scale to provide all the possible options together in front of the child and let them compare all options together and find the difference in rooms just by the proportion with two different access types; however, it might not be the best research design to make sure whether the autistic children with all sensory difficulties perceived the scale model as an actual room and find whether it is their desired proportion. Accordingly, it is highly suggested that not rely on this result to be interpreted as design code, but an actual scale of this study is required to support this result.

REFERENCES

- Altenmüller-Lewis, Ulrike. "Designing schools for students on the spectrum." *The Design Journal* 20, no. sup1 (2017): S2215-S2229. <https://doi.org/10.1080/14606925.2017.1352738>
- Beaver, Christopher. "Designing environments for children and adults on the autism spectrum." *Good Autism Practice (GAP)* 12, no. 1 (2011): 7-11.
- Feisner, Edith Anderson, and Ronald Reed. *Color studies*. A&C Black, 2013.
- Gaines, Kristi, Angela Bourne, Michelle Pearson, and Mesha Kleibrink. *Designing for autism spectrum disorders*. Routledge, 2016.
- Hair, Joseph F. *Multivariate data analysis*. Cengage Learning (2009).
- Healey, Joseph F. *Statistics: A tool for social research*. In *Paper Knowledge*. Cengage Learning, 2014.
- Howell, Bryan, Chai-Chi Teng, Dennis Eggett, Bryan Sparks, Nathan Shirley, Ryan Whitaker, and Jessica George. "Two color proportion in nature." (2010).
- Humphreys, Simon. "Autism and architecture." *Autism London Bulletin* (2005): 7-8.
- Kaye, Stuart M., and Michael A. Murray. "Evaluations of an architectural space as a function of variations in furniture arrangement, furniture density, and windows." *Human Factors* 24, no. 5 (1982): 609-618. <https://doi.org/10.1177/001872088202400511>
- Khandelwal, Richie, and Sahil Sahni. "Patterns in nature." *Pardeep Research Group, Thematic Unit of Excellence (TUE)* (2005):1-24.
- Mansourimajoumerd, Parinaz, Hassan Bazazzadeh, Mohammadjavad Mahdavinejad, and Sepideh Nik Nia. "Energy Efficiency and Building's Envelope: An Integrated Approach to High-Performance Architecture." In *Urban and Transit Planning: City Planning: Urbanization and Circular Development*, pp. 25-33. Cham: Springer International Publishing, 2023.
- Mansourimajoumerd, Parinaz, Mohammadjavad Mahdavinejad, Sepideh Niknia, and Mehdi Shirvani. "Comprehensive Strategies for Optimization e_Energy System in Different Climate Zone." In *The 4th International Conference on Architecture, Arts and Applications* [www. iconfaaa. com](http://www.iconfaaa.com). 2020.
- McAllister, Keith, and Barry Maguire. "Design considerations for the autism spectrum disorder-friendly Key Stage 1 classroom." *Support for learning* 27, no. 3 (2012): 103-112. <https://doi.org/10.1111/j.1467-9604.2012.01525.x>
- McAllister, Keith, and Barry Maguire. "A design model: the Autism Spectrum Disorder Classroom Design Kit." *British Journal of Special Education* 39, no. 4 (2012): 201-208. <https://doi.org/10.1111/1467-8578.12006>
- Mostafa, Magda. "An architecture for autism: Concepts of design intervention for the autistic user." *International Journal of Architectural Research* 2, no. 1 (2008): 189-211.
- Mostafa, Magda. "Architecture for autism: application of the autism ASPECTSS™ design index to home environments." *The International Journal of the Constructed Environment* 4, no. 2 (2014): 25.
- Nagib, Wasan, and Allison Williams. "Toward an autism-friendly home environment." *Housing Studies* 32, no. 2 (2017): 140-167. <https://doi.org/10.1080/02673037.2016.1181719>
- Owen, Ceridwen, and Damhnat McCann. "Picturing home: self-directed photography as a lens to explore the home environment in the care of children with Autism Spectrum Disorder." In *7th Australasian Housing Researchers' Conference, Fremantle, Western Australia, February*. 2013.
- Paron-Wildes, A. J. *Interior Design for Autism from Birth to Early Childhood*. John Wiley & Sons, 2013.
- Piaget, Jean. "Part I: Cognitive Development in Children--Piaget Development and Learning." *Journal of research in science teaching* 40 (2003).
- Rawat, A. "10 Facts On Leonardo Fibonacci And The Fibonacci Sequence." *Learnodo Newtoni0140*. (2015). <https://learnodo-newtonic.com/fibonacci-facts>

HEALTH & WELL-BEING

Sheykhmaleki, Pariya, Seyed Abbas Agha Yazdanfar, Sanaz Litkouhi, Masoumeh Nazarian, and Andrew David Freeman Price. "Prioritising public spaces architectural strategies for autistic users." *Archnet-IJAR: International Journal of Architectural Research* 15, no. 3 (2021): 555-570.. <https://doi.org/10.1108/ARCH-07-2020-0142>

Yates, Michelle Kathleen. "Building better schools: A new model for autism inclusion in Seattle." ProQuest Dissertations and Theses, 2016

Cool to be Cool: Impact of Cool Roof Coating on the Thermal Performance of Slum Houses in Dhaka

Zainab Faruqui Ali¹, Emmat Ara Khanam Ema¹, Mohammad Zillur Rahman¹

¹Department of Architecture, BRAC University, Dhaka, Bangladesh

ABSTRACT: Bangladesh has a tropical warm-humid climate with significant solar radiation and high humidity. Dhaka, the capital has 22 million people, and about 40% of the population live in low-income settlements or slums. The roofs and the walls of the houses are usually made of corrugated iron sheets which have high thermal conductivity, and are inappropriate as a building material. Both direct and indirect incoming heat are intense making indoors hot. The houses have little or no natural ventilation. As a result, many residents suffer from poor physical and mental health.

A simple passive cooling technique was used to make the indoors of some these houses cooler and comfortable. A cool roof paint coating with specific reflectivity and emissivity was applied to the roofs, and the impact on indoor temperature and the resultant effect on the residents were observed. Such roof coatings have been applied in many countries, and some cities have made such application mandatory for large buildings. For Bangladesh, this is a pioneering and much needed action-research conducted on the houses that have hot and uncomfortable indoors.

The research monitored thermal performance of a number of houses which were painted with the special coating and resultant thermal behavior of the houses. Thermal performance was recorded by taking hourly data of air temperature and relative humidity simultaneously of inside and outside the painted houses ('Treatment') by electronic data loggers. Inside and outside surface temperature of the roofs were also measured. For comparison, simultaneous data were recorded of a neighboring house which was not coated ('Control'). For every 2 treatment houses, there was a control house. The data was recorded for 10 days, 5 days before (pre-paint) and 5 days after (post-paint) the coating. Questionnaire survey was conducted on thermal comfort sensation and health conditions. The results show that after painting, internal surface temperature of roof is decreased by an average of 5°-6°C and indoor air temperature is reduced by 3°-4°C. The conclusions are drawn from the synthesis of the related information, analysis of the thermal data, and observations of the researchers on the environmental consequences of the plan, section, materials and details of the houses.

The most successful part of the research was that the houses were much cooler after the coating, and it can be stated that over the years, there will be a positive impact on the overall health of the residents. This will again reduce the use of electricity for cooling. Secondly, the researchers being academics, there was direct and instantaneous input of the knowledge in their teaching. This action research also included coating two factory roofs, and the results have influenced many commercial factories to show interest in such application for energy efficiency. Lastly, the findings of the research were placed with the related ministries of the government, who have shown positive responses. There is a possibility of the coating to be incorporated in the policy in terms of metal roofs and buildings with large roof areas to have cool roof paint.

KEYWORDS: Cool roof coating, Air temperature, Passive cooling, Energy efficiency, Thermal comfort

INTRODUCTION

Along with climate change, the urban heat island effect is evolving into a significant issue that endangers a pleasant urban environment (Uddin, Islam and Shahid 2021). The relationship between the urban heat island effect's spatial distribution and temperature reveals a tendency for the temperature to drop from the city's center to its periphery (Uddin, Islam and Shahid 2021). As a result, the ecology and natural environment in metropolitan regions are severely impacted and have lost their vital balance. Urban heat issues already affect three billion people (or 48% of the world's population) directly, and since the number of people living in urban areas is predicted to increase to five billion by 2030, more people will become subject to these issues (World Urbanization Prospects, 2004). Large cities experience this prominent phenomenon known as urban heat island, which is characterized by a higher temperature or heat content than the nearby rural areas (UHI) (Tariq 2022). Therefore, regions where residential and commercial facilities are concentrated should make special efforts to mitigate the heat island impact.

Among the many strategies for controlling and reducing heat to some extent in cities, the cool roof system has recently gained recognition. By developing proper guidelines, such as cool roof regulations that encourage the reduction of greenhouse gas emissions and building energy use in response to heatwaves, the Bangladesh Ministry of Environment, Forest and Climate Change, and local governments are also supporting climate change mitigation.

This study is part of an international competition titled Million Cool Roofs Challenge (MCR), and a collaborative team of the Department of Architecture and the School of Public Health of Brac University was a finalist among the ten such

finalists selected from proposals submitted from all over the world. This action-research sought to evaluate the impact of a cool roof system on temperature reduction using empirical data collected over the span of a year from 100 houses in Karail slum, Dhaka, Bangladesh. Particularly, the metal roofs of the houses in the Karail slum had the cool roof system installed. This study examined how the applied cool roof system changed the surface temperature of the roof and internal temperature of the houses in the test models, and provided policy implications for improving the urban thermal environment.

1.0 BACKGROUND

The cool roof system has received a lot of attention since, unlike other roofs, it not only protects the roof from moisture but also contributes to lowering cooling costs due to the cool roof's high reflectivity impact (Gao, XU, Yang, Tang, Zhou, GE, XU, Levinson 2014). Urban thermal management, particularly the mitigation of urban heat islands, is further aided by its widespread application to urban areas (Georgescu, Morefield, Bierwagen and Weaver 2014; Millstein and Menon 2011; Rosenfeld, Romm and Pomerantz 1998). The use of cool roofs in smart city plans and eco-friendly remodeling initiatives has recently gained attention in an effort to lower the temperature inside the city (Santamouris 2012; Salamanca, Georgescu, Mahalov, Moustouai and Martilli 2016). The cool roof system is already being utilized in both developed and developing countries.

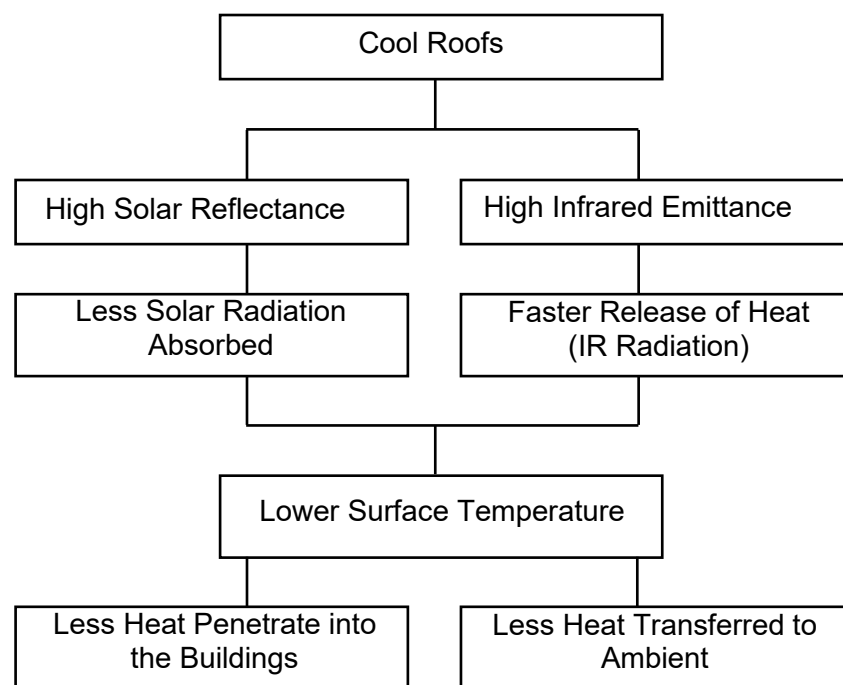

Figure 1: Schematic depiction of the concept underlying cool roofs. Source: (Green, Ledo Gomis, Synnefa, Haddad, Paolini, Cooper, Adams, Eckermann, Johnson, Kokogiannakis, Ma, Kosasih, and Santamouris. 2018).

Figure 1 details the characteristics of a cool roof paint application. Recently in a few states in neighboring India have applied this coating for roofs of large buildings which have resulted in significant savings in cooling the indoors, and this is encouraging other states to adopt the technology. This is being done by government as well as private initiatives (Jina 2016; Rallapalli and Gupta 2020). In Bangladesh, only a handful of building roofs have applied locally produced exterior wall paint of white color, but the cooling effect was not that significant.

For this action-research, this application is also related to indoor thermal comfort assessment where the cool roof coating was working as a passive cooling strategy. In order to compare the final outcome, a Treated building (with cool roof coating) and a Control building (without cool roof coating) were monitored at the same time during different seasons.

2.0 METHODOLOGY

The research aimed the low-income communities whose houses, because of the materials used i.e., corrugated iron sheet, which is very inappropriate as a building material, and are at close proximities, have higher indoor temperatures (Ali and Mallick 2003). Being able to reduce temperatures would contribute to comfort and hence higher productivity.

2.1. Selection of Houses

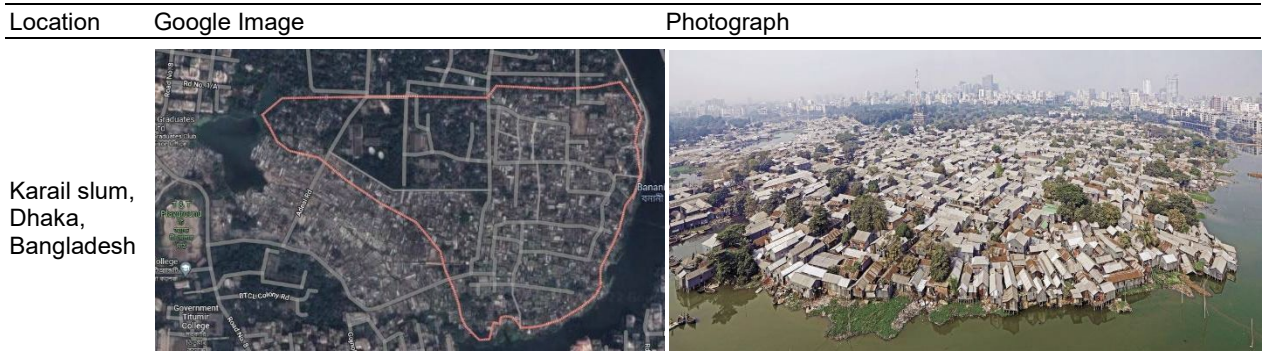

Figure 2: Houses selected for cool roof action-research (view of Karail slum, Dhaka). Source: Google

Houses were selected from the largest slum in Dhaka – Karail. All of these 100 to 120 square feet houses had corrugated iron roofs and almost all had corrugated iron walls as well except for partition walls that were of brick (Fig 2). Each house had multiple rooms for different families with little or no ventilation. Access alleyways were narrow, about 3 feet in width. Because of extensive use of corrugated iron, the area itself is hotter than its surroundings and along with hotter indoors and density of population, a suitable place for this work.

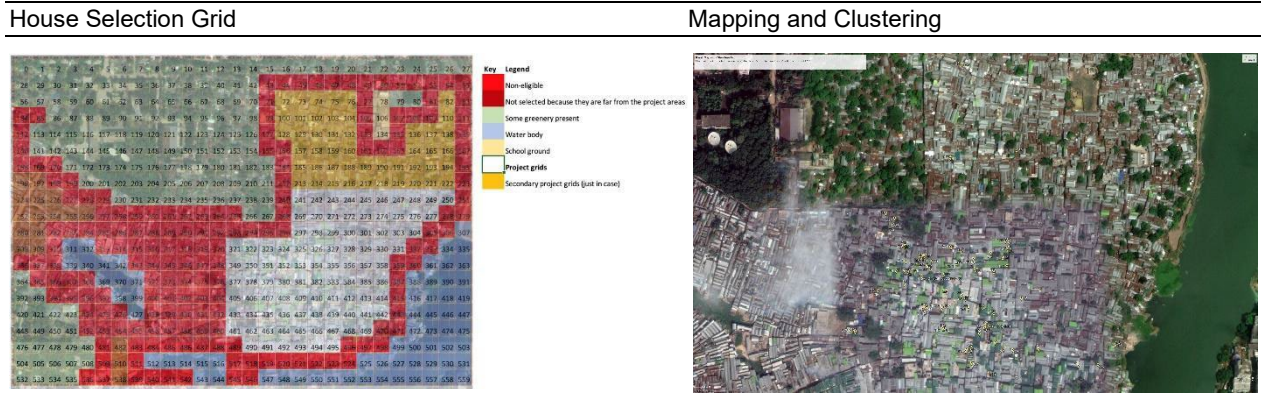

Figure 3: House selection grid and final mapping with house number. Source: Authors & Google

Houses with good conditions of the roofs and accessibility were generally selected for Treatment and as Control buildings (Fig 3, 4, 5). From these, further selection was random. Listing of houses started following these criteria, but unfortunately half way into this work the pandemic struck, the country went under lockdown for an extended period of time. The work stopped in March 2020, and then started again in July 2020.



Figure 4: External and internal views of the houses. Source: Authors

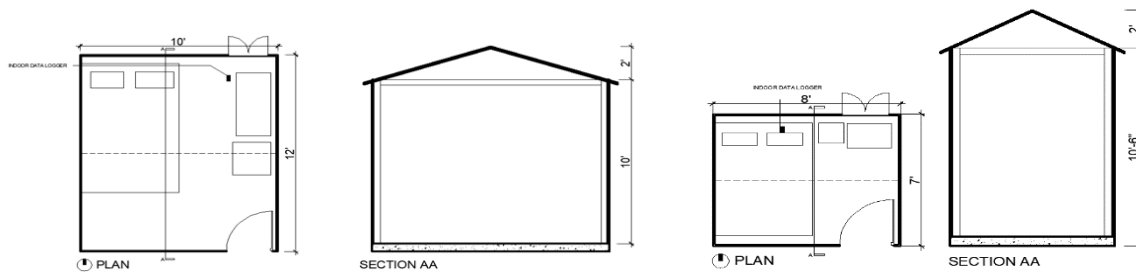

Figure 5: Plans and sections of typical houses. Source: Authors

2.2. Engaging community

Meetings and discussions were held to make the community aware of the benefits of cool roofs, how long would the research work take, and its components such as measuring houses for drawings, paint application, data logger installation, questionnaire survey, etc. Assurance was given that if any damages occurred will be repaired. Community people, being already aware of the work of Brac (the largest non-government organization in the world) which has been working for years in upgrading the lives of slum dwellers, agreed to cooperate. Painters, unemployed during the pandemic were engaged, which was helpful for them. Volunteers, mostly college students were recruited to help in the survey. Young community leaders were recruited to supervise over the safety of the data loggers.

2.3. Method of cool roof paint application

Paint samples from three top companies in the country were sent to a lab in the USA for testing to see if they meet the required reflectivity and emissivity standards specified by the MCR Challenge. As none of these samples met the criteria, a paint was selected from India that had already met the specific standards.

As a pilot run, a sample house roof was painted with the local paint basically to assess what is involved in the process of paint application and installing data loggers, and how difficulties could be overcome.

The actual application was very difficult as the houses were adjoining each other, there were no alleyways between them to install formwork or even placing a ladder, and the only way to paint the roofs was to access the roofs from other roofs. Walking on the roofs was risky since the roof sheet was very thin. Each roof had to be cleaned of dust and thoroughly washed with water before painting could commence. A primer was then applied, and after 5-6 hours two coats of paint (successively applied after each coat was dry) were applied by hand with brushes (Fig 6). Electric spray could not be applied as the roofs were small and power supply was erratic and not dependable.



Figure 6: Cool roof coating application. Source: Authors

2.4 Logger installation

Electronic data loggers (HOBO) were installed both outside and inside the Control and Treatment houses. Data loggers collected air temperature, surface temperature and relative humidity both indoors and outdoors. Because of rain, the rooftop one was housed in an aerated box (Fig 7).

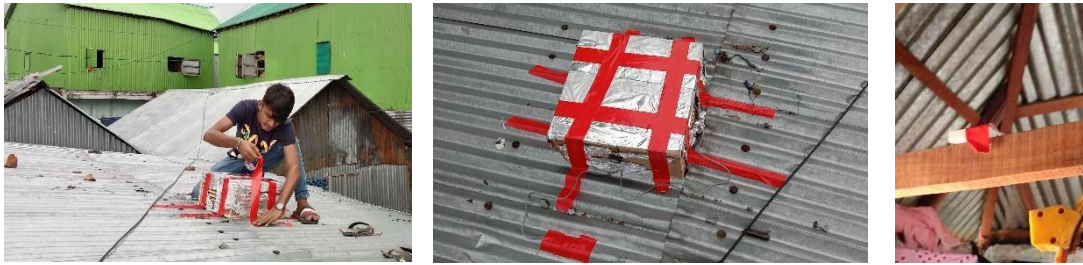

Figure 7: Data logger installation. Source: Authors

2.5 Data collection

Data was collected on 100 houses during summer, monsoon and winter seasons. The data was recorded for 10 days, 5 days before (pre-paint) and 5 days after (post-paint) the coating. For every two Treatment houses, there was one Control house for comparison of data to study the thermal behavior. Simultaneous data were collected on Treatment and Control houses before and after application of paint. Data was collected of Treatment houses during Pre-paint and Post-paint condition. Questionnaire survey was conducted among residents on thermal comfort and health conditions.

3.0 RESULTS

Typical results show decrease both in surface temperature of the roof and indoor air temperature in the Treatment house compared to the Control house. Similar results are observed between Pre-paint and Post-paint conditions of the Treatment house.

3.1. Data analysis of Control and Treatment buildings

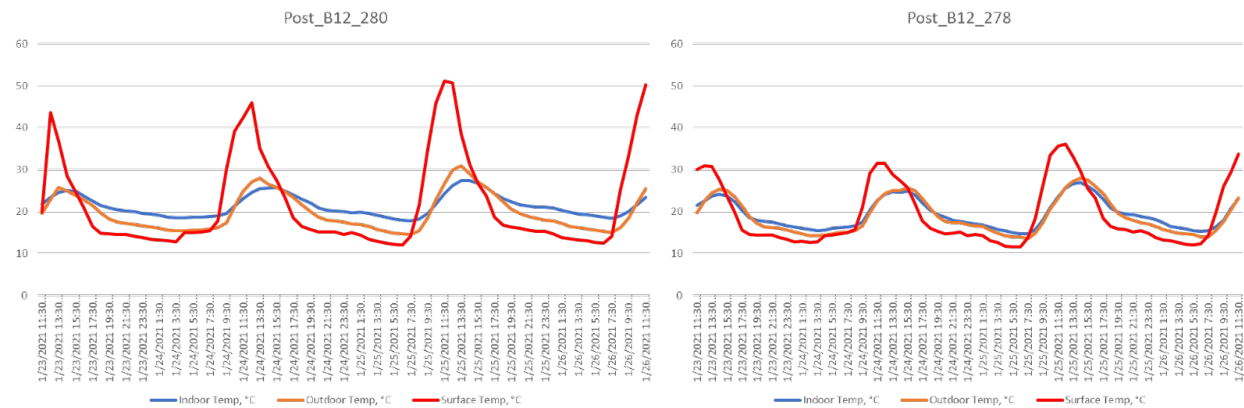

Figure 8: Comparison between Control & Treatment buildings in post-paint period. Source: Authors

Compared to the Control house, Treatment house shows reduction in roof surface temperature of 15°C at peak period. Reduction in indoor temperature between Treatment and Control is 5°C during peak period (Fig 8).

3.2. Data analysis of Pre-paint and Post-paint conditions of Treatment building

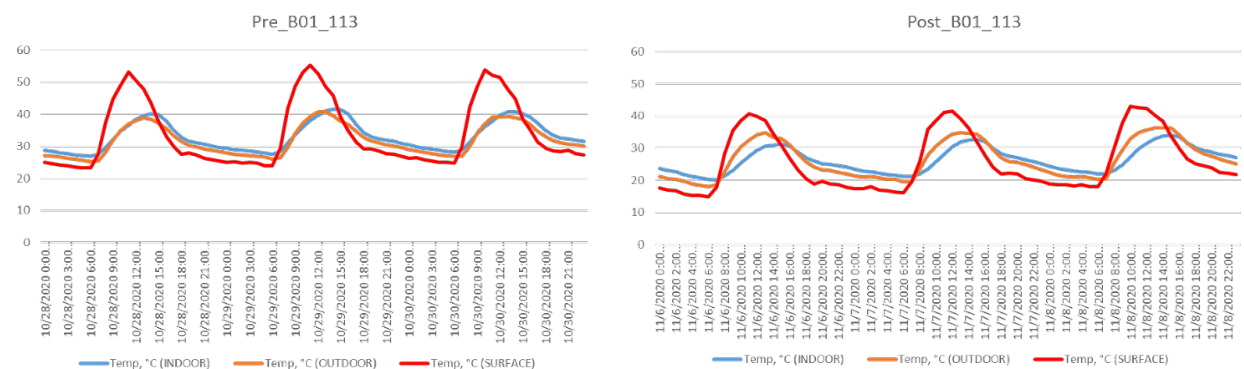

Figure 9: Comparison between Pre-paint and Post-paint period of Treatment house. Source: Authors

Roof surface temperature is reduced by 4.45°C at peak period after application of cool roof paint of the treatment house. Indoor air temperature is higher than outdoor air temperature during peak period before painting. After painting it is lower than the outdoor by 5.01°C. Indoor temperatures are higher prior to painting since the house has metal roof and walls and heat are radiated inside, this reduction is significant due to painting in October since at that time it is quite warm and humid in Dhaka (Fig 9).

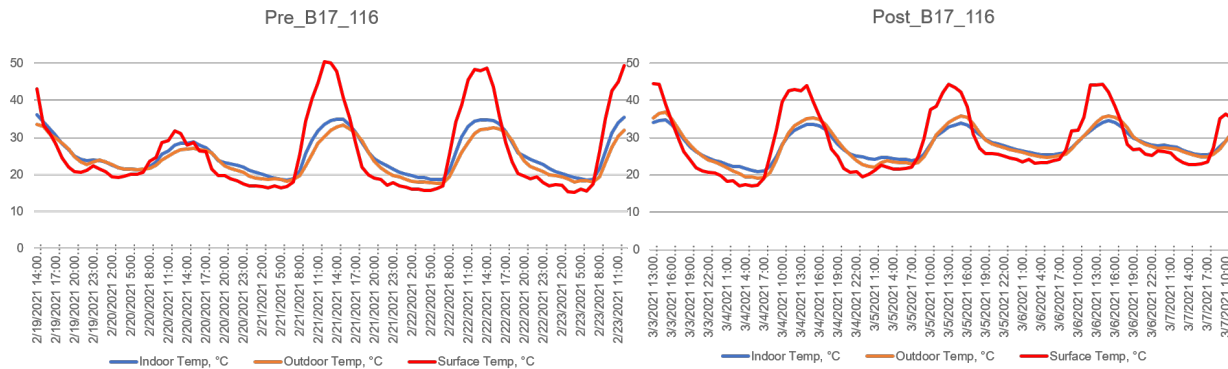

Figure 10: Comparison between Pre-paint and Post-paint period of Treatment house. Source: Authors

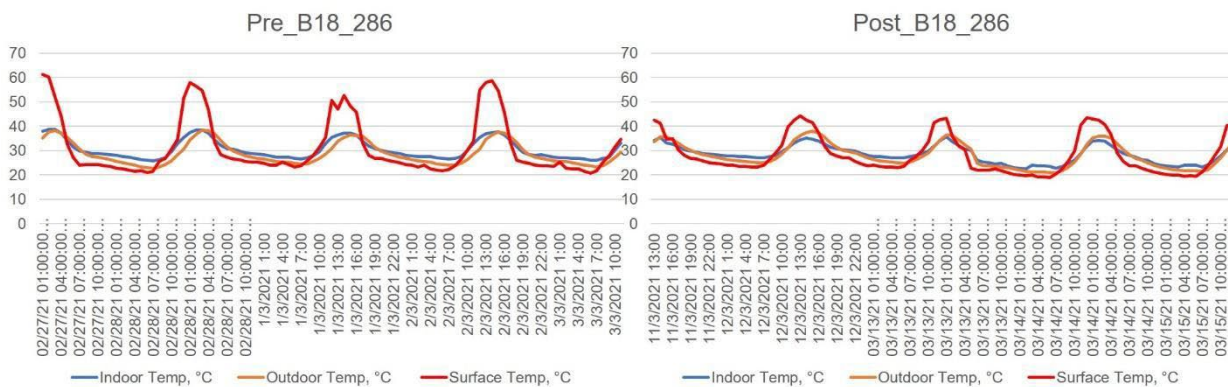

Figure 11: Comparison between Pre-paint and Post-paint period of Treatment house. Source: Authors

End of February and early March are quite hot in Dhaka with hardly any cloud cover and hence, direct solar radiation. The micro-climate around the slum buildings with metal roofs and walls is quite stressful. The performance of the houses shown in figures 10 and 11 have higher daytime indoor temperatures than outdoors in pre-paint condition and after painting, indoor temperatures are lower during the day in both. This is a significant finding as the indoor temperatures are reduced from being higher than the outdoors to being lower as a result of the applied paint (Fig 10).

CONCLUSIONS and DISCUSSIONS

From the measurements and data analysis following conclusions are drawn:

Reduction in surface temperatures of the roofs due to the specific reflectivity and emissivity of the coatings result in cooler surroundings and heat stress of the houses is reduced.

Indoor temperatures in the houses are reduced at peak periods bringing them to closer to or sometimes within comfort conditions. Most cases, except for a few, showed reduction in indoor temperatures. A reduction, therefore in welcome for most of the year. In the few cases where the indoor temperatures were higher than the outdoors during some periods, it would be desirable in the winter months, but summer would be stressful. In the long run, comfort conditions brought about by cool roof would have positive effect on physical and mental health of the residents. Again, after the application of cool roof, saving electricity by using existing indoor electric fans for shorter periods and at lower speeds would save money to a certain extent.

There were various factors at play here. All houses are not oriented the same, some roofs get sun more than others, due to orientation and also location of adjoining houses. All have metal roofs, and walls are usually of metal. Some also

get reflected radiation from adjacent metal walls since the buildings are very close to each other. Micro-climate was an influencing issue and the overall micro-climate shows improvement with painting.

The researchers being academics, there was direct input of the knowledge of the cool roof applications in their teaching. This action research also included painting two factory roofs, which influenced other factories in such application for energy efficiency. The findings of the research were placed with the related ministries of the government, who have shown positive responses in terms of adopting this method in the policies.

ACKNOWLEDGEMENTS

Special thanks to the research team members of the Department of Architecture and JPG School of Public Health at Brac University, Community leaders and volunteers of Karail, and Brac.

REFERENCES

- Ali, Z F. and Mallick, F H. 2003. *Comfort in High Density Housing: The Case of Corrugated Iron Walls and Roofs*. Proceedings of the PLEA conference on Rethinking Development, 2004. Santiago, Chile.
- Gao, Y., Xu, J., Yang, S., Tang, X., Zhou, Q., Ge, J. and Levinson, R. 2014. *Cool roofs in China: Policy review, building simulations, and proof-of-concept experiments*. Journal: Energy Policy, ISSN: 0301- 4215.
- Georgescu, M., Morefield, P.E., Bierwagen, B.G. and Weaver, C.P. 2014. *Urban adaptation can roll back warming of emerging megapolitan regions*. Proc. Natl. Acad. Sci. USA 2014, 111, 2909–2914.
- Green, A., Ledo Gomis, L., Synnefa, A., Haddad, S., Paolini, R., Cooper, Paul., Adams, Jamie., Eckermann, Mark A., Johnson, Greg., Kokogiannakis, Georgios., Ma, Zhenjun., Kosasih, Buyung. and Santamouris, Mattheos. 2018. *Driving Increased Utilisation of Cool Roofs on Large-Footprint Buildings - Final Report*. Faculty of Engineering and Information Sciences - Papers: Part B. 4508.
- Jina, A. 2016. *Cool roofing Solutions for Reducing Heat Stress in Delhi Slums*. Research Project: Epic India+University of Chicago.
- Millstein, D. and Menon, S. 2011. *Regional climate consequences of large-scale cool roof and photovoltaic array deployment*. Journal: IOP Publishing, Environ. Res. Lett. 6 (2011), 034001.
- Rosenfeld, A.H., Akbari, H., Romm, J.J. and Pomerantz, M. 1998. *Cool communities: Strategies for heat island mitigation and smog reduction*. Journal: ELSEVIER, Energy Building. 28, 51–62.
- Rallapalli, H. and Gupta, J. 2020. *Cool Roof Initiatives in India: An evaluation of existing conditions and lessons to be learnt from global best practices*. AEGAEUM Journal: ISSN NO: 0776- 3808.
- Santamouris, M. 2012. *Cooling the cities—A review of reflective and green roof mitigation technologies to fight heat island and improve comfort in urban environments*. Journal: ELSEVIER, Sol. Energy 2014, 103, 682–703.
- Salamanca, F., Georgescu, M., Mahalov, A., Moustou, M. and Martilli, A. 2016. *Citywide Impacts of Cool Roof and Rooftop Solar Photovoltaic Deployment on Near-Surface Air Temperature and Cooling Energy Demand*. Journal: Springer, Bound. -Layer Meteorol. 2016, 161, 203–222.
- Tariq, T. 2022. *Urban Heat Island Phenomena in Dhaka, Bangladesh*. Conference: ARCC-EAAE 2022 International Conference: Resilient City: Physical, Social, and Economic Perspectives
- Uddin, S., Khan, N., Islam, T., Kamruzzaman, M. and Shahid, S. 2021. *Changes in Urbanization and Urban Heat Island Effect in Dhaka City*. Journal: Springer

Design Science Research Toward Integrated Production of Design Artifacts and Knowledge in Outpatient Clinic Cases

Jinoh Park¹

¹University of Arkansas, Fayetteville, AR

ABSTRACT: This project develops a framework for applying Design Science Research (DSR) to Interior Architecture and Design with two healthcare design cases. DSR is a problem-solving paradigm that seeks to enhance human knowledge via the creation of innovative artifacts. This research aims to lay the foundation for encouraging scientific research in Interior Architecture and Design by conceptualizing a DSR methodology framework based on the previously developed design projects at the professional level. With the main research question “how can the existing DSR framework be applied to Interior Architecture and Design?,” this research conducted an exploratory case study with four phases: a) Conceptual DSRM Process Model in Interior Architecture and Design, b) Design Cases, c) Possible Research Entry Points, and d) Other Considerations. As a result of the phases, the research obtained: a) matched the EBD process with the DSRM process, b) sorted results from the two healthcare design cases using the matched process, c) extracted research entry points from the sorted results, and d) identified two items for consideration through the reviews of two healthcare design cases with the matched process. By combining the results, the author proposed a conceptual DSRM Process Model in Interior Architecture and Design with the two following research tasks: a) establishing a review method for the demonstration and evaluation process for the unbuilt project and b) a case study completing the entire cycle of the DSRM Process Model.

KEYWORDS: Design Science Research, DRS, Interior Architecture and Design

INTRODUCTION

This research explores the possibility of developing a framework for implementing Design Science Research (DRS) in Interior Architecture and Design by developing an outpatient behavioral health clinic design case. DSR is a paradigm for solving problems that aims to enhance human knowledge by creating innovative artifacts (Brocke, Hevner, and Maedche, 2020; Peffers et al., 2007) conceptualized a DSR framework for Information Systems Research and demonstrated the DSR framework with four case studies. In the context of the paper, the DRS framework presents two characteristics. The first is that “Design artifacts” and “Design knowledge” can be produced simultaneously or independently. This incorporates the principles, practices, and procedures necessary for conducting research. Secondly, it includes processes of evaluation and communication for one to occur. Design artifacts can be considered scientific results if they follow established scientific frameworks. As another way of putting it, design knowledge can be extracted from the design process and artifacts if regarded as data production processes. As a result, for a social science project, DSR offers the benefit of collecting data on your own design project and drawing conclusions. Also, it implies that individual creations that have been left only as creations can be a result of research that contributes to the Body of Knowledge. Despite these advantages, these approaches are rarely observed in Architecture, much less in Interior Architecture and Design. As of November 2022, as a result of a search on Scienedirect with the keyword “design science research in Interior Architecture and Design,” including the phrase “Design Science Research” in title, abstract, or keywords, six articles came out, of which only one article dealt with the built environment, especially in the energy management in airport architecture (Uysal and Sogut, 2017). The study used the DSR methodology in its process. According to the results of the same search in Taylor and Francis Online, the only articles found applied design science research methodology to construction management (Gravina da Rocha, Korb, and Sacks, 2022). The ARCC proceedings do not contain any research conducted using a design science methodology. There is one study that references a design science methodology (van Aken and Romme, 2012) in order to describe the evidence-based design that develops prescriptive knowledge and solutions (Engineer 2020). The other study mentions “design science” (Cline, 2013). Considering the lack of research that fully realizes the advantages of the DSR mentioned above, and especially that there are no instances in which the DSR has been applied to interior architecture and design, therefore, it is necessary to initiate research to examine how the benefits of the DSR can be applied to Interior Architecture and Design. This research aims to lay the foundation for the application of DSR in Interior Architecture and Design. Aligning with the research objective, the research questions how can the existing DSR framework be applied to Interior Architecture and Design?

1.0 METHODOLOGY

1.1 Research Design

In order to address the research question, this study starts by referring to the paper mentioned above (Peffer et al., 2007). In order to establish a DSR process model, the authors listed elements in a) common design process elements and b) the conceptual framework of DSR in the field of Information Science, which can be derived from previously published references and then categorize them into each step of the DSR process model (Figure 1). Then, they validated the model by applying the model to four cases studies already published. During this process, they demonstrated how the Design Science Research Methodology (DSRM) is adhered to in motivating, developing, designing, demonstrating, evaluating, and communicating the artifact.

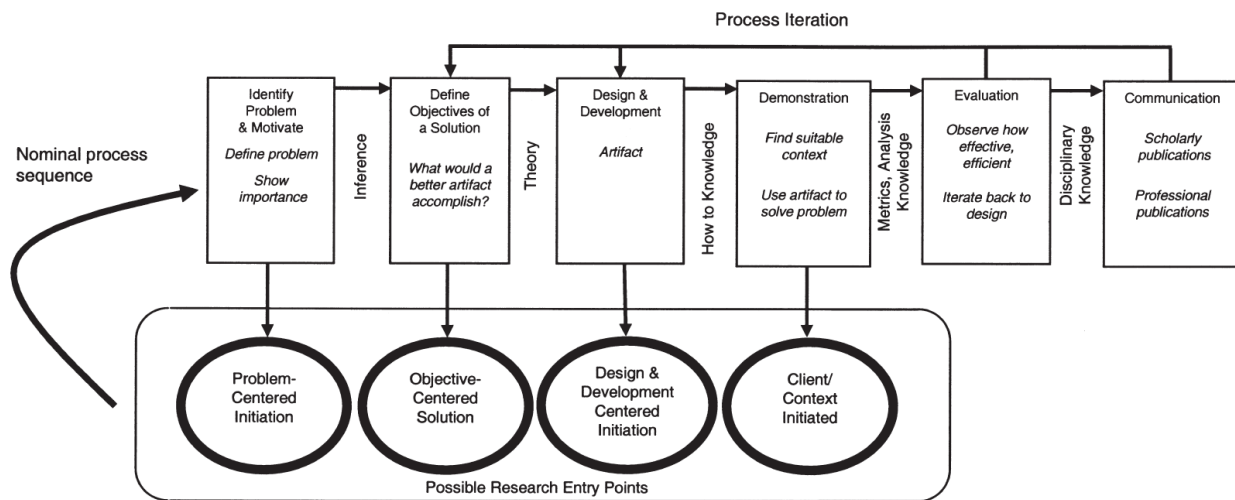

Figure 1: DSRM Process Model. (Peffer et al. 2007)

By referencing the paper above, this research conducts an exploratory case study (Yin, 2017) addressing how to apply DSRM into Interior Architecture and Design. Under the main research question, this research addresses sub research questions: a) In what form might a DSRM Process be implemented in the field of Interior Architecture and Design? b) In applying the developed DSRM Process Model to design cases, what kind of academic knowledge can be produced or questioned? c) In light of all the above processes, is it possible to apply DSR to the field of interior architecture and design? and, d) as a final question, what results and considerations have been exposed or derived from this process that were not included in the above discussion? To answer these questions, this research consists of four phases: a) Conceptual DSRM Process Model in Interior Architecture and Design, b) Design Cases, c) Possible Research Entry Points, and d) Other Considerations.

1.2. Conceptual DSRM Process Model in Interior Architecture and Design

The author establishes an initiative conceptual DSRM Process Model by comparing the existing DSRM Process model (Figure 1) with the common design process in Interior Architecture and Design. In the course of searching for the common design processes, it has been discovered that there are a variety of definitions and elements. Among the searched common design processes, this research utilizes only the evidence-based design framework in order to avoid any potential controversy surrounding the terminology "common design process." The evidence-based design has been established through peer-reviewed publications, especially in Healthcare design practices and principles, including its published framework (Nussbaumer, 2009). One of the ARCC proceeding studies mentioned above (Engineer, 2020) described evidence-based design by referring to design science methodology (van Aken and Romme 2012). As a result of taking into consideration these conditions, the evidence-based design framework (Table 1) and its elements are matched with the DSRM Process model (Figure 1) so as to form a concept model for DSRM Process in Interior Architecture and Design.

1.3. Design Cases in Healthcare Design

The author searched for cases in healthcare design that employed the evidence-based design approach (Table 1) to demonstrate the conceptual model developed in 1.2 above. There are numerous articles that present design knowledge and focus on areas of academic research importance. Additionally, in practice, fragmentary prototypes or wholistic design results were often presented, which applied evidence-based design results. Nevertheless, it was difficult to find case study articles or professional practices that presented not only a part of the evidence-based design process, such as research-value areas or designed outputs, but also the process of the evidence-based design behind the final outputs. The lack of applicable cases led, in the end, to the use of healthcare projects designed by the author, especially those in which the above evidence-based design process was applied (Table 1), as design cases in healthcare design. One case is a medicalized wellness clinic in Seoul, Korea, specialized in non-surgical aesthetic procedures,

mindfulness-focused procedures, and preventive medical services, which is built in 2020 (Park and Kim, 2022). The other case is a behavioral healthcare clinic in Bentonville, Arkansas, based on the program brief documentation of the International Interior Design Association (IIDA) 2022 Student Design Competition¹ which is open to the public and specifies the program contents of the primary care behavioral health clinic for children and adolescents, which is unbuilt and developed in 2022. The design cases are applied to the conceptual model developed to classify and organize the results according to the nominal process sequence of the conceptual model.

Table 1: Design Process with Scope of Services. (Nussbaumer, 2009)

Design Process Phases	Programming		Schematic (Concept) Development	Design Development	Contract Documentation	Contract Administration	
	Initial contact with client	Programming			Implementation Take action		
Scope of services and/or tasks	Recognize problem	Define problem	Continue to analyze facts	Select and refine	Bidding process	Order/ construction	Evaluate
	Commit to project	State the goals and objectives Gather information: the facts	Generate ideas and brainstorm	Develop drawings, details, specifications	Construction drawings	Ordering process	Create punch list during walking through
	Accept the project	Interview clients, use surveys, questionnaires, conduct observations, etc.	Sketching of ideas, plans, details, etc.		Specifications written	Construction	After approximately three months, conduct POE
	Contract written	Research to develop a strong evidence base	Develop preliminary plans			Supervision	
	Retainer obtained	Analyze facts Organize the information and develop program requirements Continue to analyze facts					
	Analysis			Synthesis			

1.4. Possible Research Entry Points

The author identifies possible research entry points from the classified and organized outputs in each phase of the nominal process sequence. Each design case has a set of contextualized outputs according to various contexts such as the site, scale, client needs, project goals, etc. The findings from the cases are mainly subjective as a result of the characteristics derived from the contextualized outputs (design artifacts). Identifying possible research entry points can be achieved by systematically eliminating each contextual element from the design artifacts. As an example, when the scale of the design cases is eliminated, namely clinics in healthcare facilities less than 10,000 square feet, one possible research entry point is what design elements are generalizable across a wide range of healthcare facilities, such as medium (up to 50k square feet) and large (up to 50k square feet). By identifying possible research entry points, the subjective design artifacts can be utilized to prepare conducting scientific knowledge production. Through this process, the subjective design artifacts can be utilized to prepare for conducting scientific knowledge production by identifying possible research entry points. At the end of the process, this research summarizes the contributions that can be achieved through these design cases themselves and identified possible research entry points.

1.5. Other Considerations

In the last phase of the study, other noteworthy items arising from the application of the conceptual model to the design cases are listed. Moreover, the research collects other significant items that were not mentioned and considered during the above processes. In light of the listed and collected significant items, the conceptual model will be updated as needed. Through the above process, we explore the possibility of applying DSRM to the Interior Architecture and Design field.

2.0 FINDINGS

2.1. Conceptual DSRM Process Model in Interior Architecture and Design

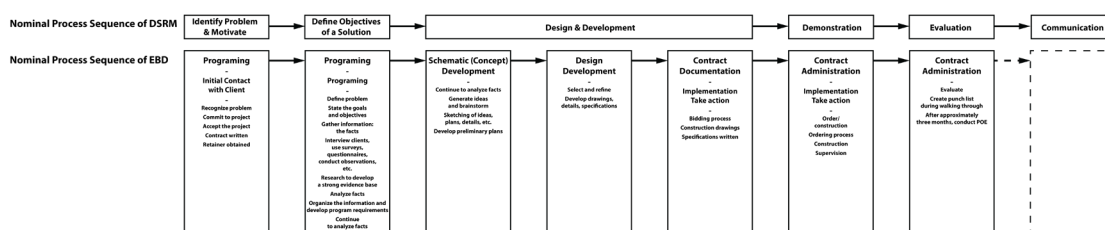

Figure 2: Nominal Process Sequence of DSRM and EBD. (Author own work)

Using the nominal sequence process of DSRM (Figure 1), the contents of Evidence-based Design (EBD) could be expressed as a seven-step nominal process sequence (Figure 2). In the nominal sequence of EBD, the "Design & Development," which appeared as the third and single step, was subdivided into three steps: "Schematic (Concept) Development," "Design Development," and "Contract Documentation." Also, EBD's Nominal sequence process does not have a step matching "Communication" in DSRM.

2.2. Two Healthcare Clinics

According to the nominal process sequence of the EBD (Figure 2), the design artifacts of two design cases are as follows (Table 2).

Table 2: Types of Design Artifacts from Design Cases.

Nominal Process Sequence	Programming - Initial contact with client	Programming - Programming	Schematic (Concept) Development	Design Development	Contract Documentation - Implementation Take action	Contract Administration - Implementation Take action	Contract Administration
<i>Design Artifacts from Case 1</i>	Recognize problem	Define problem	Continue to analyze facts	Select and refine	Bidding-process	Order/ construction	Evaluate
	Commit to project	State the goals and objectives	Generate ideas and brainstorm	Develop drawings , details, specifications	Construction drawings	Ordering process	Create punch list during walking through
	Accept the project	Gather information: the facts	Sketching of ideas, plans, details, etc.		Specifications written	Construction	After approximately three months, conduct POE
	Contract written	Interview clients, use surveys, questionnaires, conduct observations, etc.	Research to develop a strong evidence base			Supervision	
	Retainer obtained	Analyze facts	Develop preliminary plans				
		Organize the information and develop program requirements					
		Continue to analyze facts					
<i>Design Artifacts from Case 2</i>	Recognize problem	Define problem	Continue to analyze facts	Select and refine	Bidding-process	Order/ construction	Evaluate
	Commit to project	State the goals and objectives	Generate ideas and brainstorm	Develop drawings , details, specifications	Construction drawings	Ordering process	Create punch list during walking through
	Accept the project	Gather information: the facts	Sketching of ideas, plans, details, etc.		Specifications written	Construction	After approximately three months, conduct POE
	Contract written	Interview clients, use surveys, questionnaires, conduct observations, etc.	Research to develop a strong evidence base			Supervision	
	Retainer obtained	Analyze facts	Develop preliminary plans				
		Organize the information and develop program requirements					
		Continue to analyze facts					

Although two healthcare clinics focused on mental health, there are fundamental differences between the two projects: a built project (Case 1) with a real client and businessmen targeted clinic in Korea and an unbuilt project (Case 2) with a virtual client and adolescents targeted clinic in the U.S. Despite going through similar processes, the above fundamental difference led to different decisions in the first and second steps, "Programming-Initial contact with client" and "Programming-Programming". For example, Upon discovering spatial features in a general service provision sequence in clinics through a precedent study (Figure 3), the decision-making applied to the two design cases differed significantly. In detail, Case 1 established a goal to avoid being "subject to observation" in order to respect the privacy of adults, whereas Case 2 kept the "subject to observation" in order to ensure the safety of adolescents.

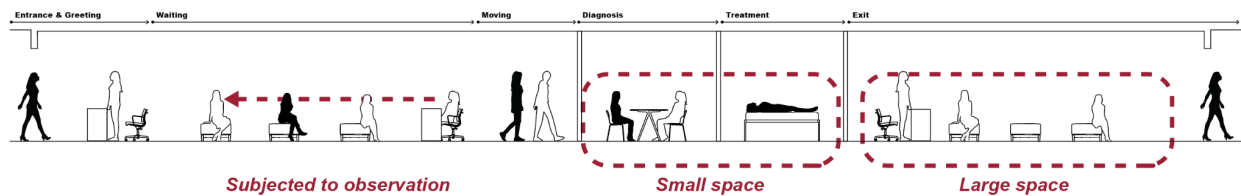

Figure 3: General Service Provision Sequence. (Park and Kim 2022)

As opposed to that, the author (designer)'s work went through the same process in all three stages of design & development from 3 to 5. Despite only minor differences in scale and level of detail, the results included diagrams, physical and digital models, architectural drawing plans, and a set of construction specifications. In some cases, the same design elements were used in both projects. The patient areas used only wall-mounted or indirect lighting rather

than ceiling lights or other objects that feel uncontrollable and unreachable (Figure 4). Even if they do not directly interact with the objects in their spaces, patients can perceive that none are out of reach and control. The final steps in the contract administration were to sort the results from Case 1, which was a built project.

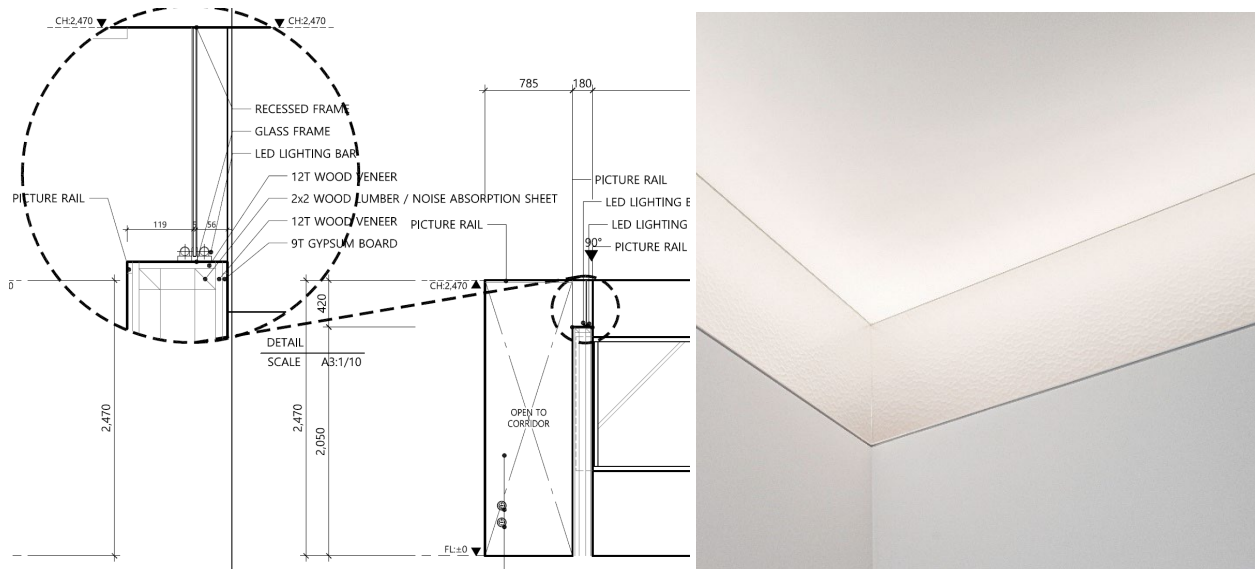

Figure 4: Indirect Lighting Detail Drawing and Picture. (Author own work)

2.3. Research Entry Points

To begin with, when the research entry points in Figure 1 are matched to the nominal process sequence in Figure 2, the research entry points of the EBD are shown in Figure 5.

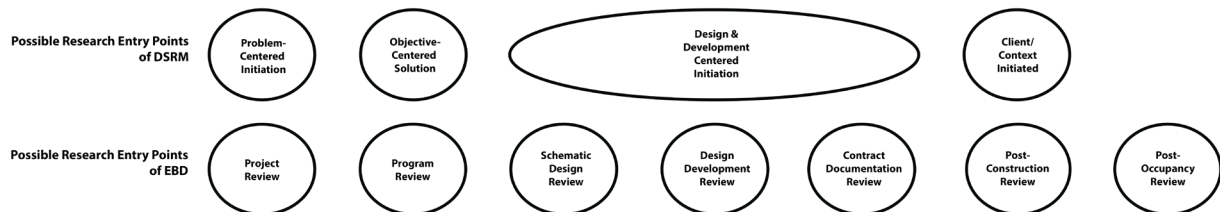

Figure 5: Possible Research Entry Points of DSRM and EBD. (Author own work)

Based on the matched research entry points above, it appears that there are several possible research entry points that can be derived from the cases. Firstly, the points for built and unbuilt projects should be separated in the project review. The one points for the built project (Case 1) are "which designer should be hired to implement the project?" from the client's perspective and "what conditions must be met to accept the project offer?" from the designer's perspective. The other point for the unbuilt project (Case 2) is a series of questions: "does interior architecture and design offer a solution to the problem?," "would another discipline be a better approach to resolution?," and "are there any alternative disciplines?" When all the answers to the above questions are obtained, we can talk about the significance of the Interior Architecture and Design approach to the problem. As part of the second program review stage, it was possible to research which methods already exist or what factors need to be addressed in order to determine a more appropriate direction for the program. In the two design cases, only clinic-scale data was collected to discover the general service provision sequence (Figure 3). For future practice, "what is the sequence of service provision at the scale of a medium or large hospital?" and "what steps from these sequences could be incorporated into clinic-scale healthcare facilities to improve the delivery of healthcare?" would be worthwhile to investigate further. It is not easy to find a new research entry point for any of the three stages of the design review process, from the third to the fifth. This is particularly true for the Interior Architecture and Design discipline, which typically conducts design reviews. If we change this approach slightly, "what sectors can use the design elements found in these two cases?" "what are the benefits of using advanced technologies in the design cases, such as a generative design process?" and "in order to create a better design, what perspectives can be considered in addition to the traditional design approach?" could be worth research entry points. A sixth step is "Post-construction review," which is, in general, the process of comparing the construction documentation with a shop drawing set that records the actual construction details to identify areas that might require improvement in the future. This is the process of reviewing the implementation of the

design intention on the construction site. It is difficult to capture a new research entry point from the designer's perspective since this is also one of the existing Building Performance Criteria (Fisher 2018). In spite of this, Case 1, constructed in an old building, can serve as an entry point for research as a case study, in which variables caused by the old building are documented as well as subsequent design changes and responses. "Post-occupancy evaluation" refers to the process of obtaining feedback from actual users of the built environment after the project is completed. This is an essential step in a virtuous cycle of EBD. According to those design cases, there was no problem in Case 1, which is a built project, but this could not be accomplished in Case 2, which is an unbuilt project. This point in mind, the author considers the "development of a methodology for pre-occupancy evaluation through VR or XR devices for an unbuilt project" as an appropriate research entry approach.

2.4. Considerable Items from the Case Reviews

During the review of the design cases in accordance with the initial DSRM process model, two items were identified that need to be discussed. First item includes a series of questions: 1) what procedure should be followed when applying the DSRM to both built and unbuilt projects, 2) can the same procedure be applied to both types of projects, and 3) which type of project might be more suitable for the use of DSRM? The second item is to consider how to integrate the knowledge produced by the existing building performance criteria and what differentiation can have from each stage of evaluation mentioned in the criteria. First of all, in the case of a built project, the results of all seven stages extracted above could be summarized (2.2); however, it is unclear whether it is possible to prove logical decision-making in all processes and whether all the processes and evidence of decision-making can be disclosed; based on the contract condition, some critical intellectual property should not be disclosed in this case. In the case of the unbuilt project, data could be produced and processes could be carried out for the first five of the seven processes (2.2); but since it is not a built project, demonstrations and evaluations are not possible; an alternative review procedure is required that is competitive with the conceptualized demonstration and evaluation processes. In spite of this, the probability of being influenced by the opinions of other clients or stakeholders in the previous five phases is relatively low compared to built projects, so the logic of decisions will likely remain clear at each stage, and all process data and evidence will likely be disclosed.

Second, it is necessary to consider how existing building performance criteria (Fisher 2018) can be incorporated into the DSRM, as well as how the DSRM can differentiate from the various stages of evaluation outlined in the building performance criteria. As indicated in the existing Building Performance Criteria, each step is reviewed and evaluated separately: 1) market/needs analysis, 2) effectiveness review, 3) program review, 4) design review, 5) post-construction evaluation, and 6) post-occupancy evaluation. In spite of the fact that the building performance evaluation mentioned "Feedback into the next building cycle" and other following research draws a connection between reviews and evaluations as linear processes, the design case reviews conducted under the DSRM process provided opportunities for evaluating and improving the entire process. For example, incorporating the questions (2.3) from above, given the foreseeable problems in the context of old buildings, it is important to take into account not only preliminary details in construction documentation and plans but also construction laws, regulations, or precedent studies to assist with the foreseeable problems. In detail, if the range of demolition and expansion according to the change in building use was changed, or if the possibility of layout change possible through partial beam removal and reinforcement was more diverse, it was deemed possible for a different design to emerge. This part is viewed as an idea that can be discovered when the entire project review elements are integrated rather than by focusing on each stage independently.

3.0 DISCUSSION

3.1. Bridging the Gap between Academia and Practice

Following the above processes, the author summarizes the obtained results: 1) matched the EBD process with the DSRM process, 2) sorted results from the two healthcare design cases using the matched process, 3) extracted research entry points from the sorted results, and 4) identified two items for consideration through the reviews of two healthcare design cases with the matched process. According to the results, this study has a limitation with respect to the number of cases and the sector, which are only two cases within the healthcare industry. In spite of this, by making an unprecedented effort, it proved possible to utilize previously scattered data in a new way. In light of the finding, the limitation, and the possibility described above, we can discuss how academic people, who have a background in practice and are able to design an entire project at the professional level, might be able to contribute to narrowing the gap between academia and practice through two steps. Achieving completion of the first stage requires academic researchers who are free from personal preferences or opinions of stakeholders to 1) implement professional project-level unbuilt projects in accordance with the matched process (2.1), 2) sort the results of each process, and 3) identify research entry points based on the sorted results. The second stage consists of addressing the research entry points both individually and in entirety, synthesizing the addressed knowledge, and iterating the first stage. It is possible to comprehensively determine how the integrated knowledge is applied to the project at the practical level, what is the basis for it, and finally what the next research direction will be if the results and processes for all of the two sequential stages of the above are recorded. As the academic people have been trained to utilize existing materials and to document the process as an academic article, they will be able to play a significant role for both academia and practice if they synthesize scattered materials, such as literacy review reports published by HKS's CADRE, for actual projects and record the process of implementation for professional-level design cases. Consequently, academia has a significant role to play in bridging the gap between academia and practice. In order to achieve this goal, it is necessary

to develop the above-mentioned alternative review procedure which is competitive with the conceptualized demonstration and evaluation processes at the level of the built project. In this regard, the author initiated a study on the use of virtual reality and augmented reality devices as a pre-occupancy evaluation method.

3.2. Other Uses in Academia

The above process resulted in derivative results that can be utilized in academia. A further benefit of organizing the results of each process and documenting the basis of the design decision made during the process was that it could be used as teaching material. In particular, the author has used the documented process of organizing the above two cases in the research methodology, human factor, and design studio courses. In addition, in the course of this documentation, the built project case was published as a case study research article (Park and Kim, 2022). In addition, using the published case study article, research collaboration opportunities are obtained, researchers in the field of policy and guidelines are being prepared for research on proposals, and, in addition, the topic of follow-up research to apply DSRM to interior architecture and design was able to be determined.

CONCLUSION

This study proposes the following conceptual DSRM Process Model in Interior Architecture and Design, combining all of the above processes (Figure 6). In spite of its limitations, such as the limited number of cases, sectors, and the absence of complete cases, this study has significant meaning in that it provides a set of research entry points and organizes the research cycle based on the design artifacts which is the design cases in healthcare interior architecture and design.

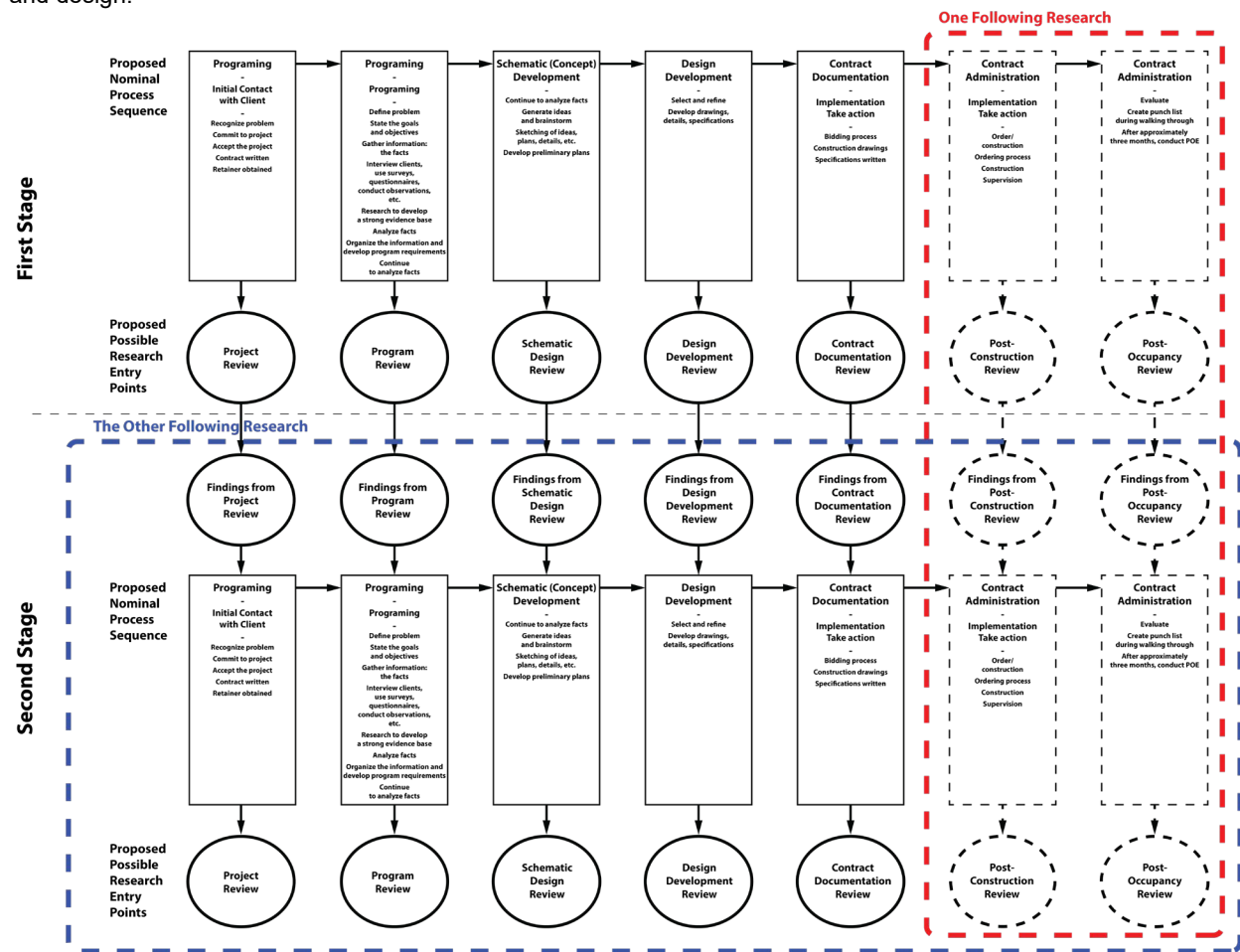

Figure 6: Proposed DSRM Process Model in Interior Architecture and Design. (Author own work)

In order to improve the model, the following two research studies are required. The first research is to establish a review method for the demonstration and evaluation process for the unbuilt project (round rectangle with red dashes). Then, the second research is to conduct a case study that completes the complete cycle (round rectangle with blue dashes). Upon completion of all the above following research, a more complete DSRM Process Model can be developed. Moreover, as well as making cases for various sectors, the author has been working on a) a workplace project that supports the hybrid working condition of working mothers and b) a zero-waste food hub project that supports minority

populations. In accordance with the research team's plans, the perfection of this model should gradually increase. Therefore, a DSRM process model that integrates research and practice is expected to be developed regardless of the sectors.

ACKNOWLEDGEMENTS

This paper was supported by the author's initiative fund from the University of Arkansas.

REFERENCES

- Brocke, J., Hevner, A., and Maedche, A. 2020. *Introduction to Design Science Research*. In Design Science Research. Cases. Progress in IS, edited by A. vom Brocke, J., Hevner, A., Maedche, 1–13. https://doi.org/10.1007/978-3-030-46781-4_1.
- Cline, T. J. 2013. *Re-visioning Design Education: A Third Culture Epistemology*. Proceedings of the 2013 Architectural Research Centers Consortium Spring Research Conference, March 27 – 30, 2013 http://arcc-arch.org/wp-content/uploads/2014/12/ARCC2013_UNCC%20Conference%20Proceedings.pdf
- Engineer A. 2020. *New Synergies between Research, Practice, and Education for Health and Wellbeing Outcomes in the Built Environment*. Proceedings of 2020 Architectural Research Centers Consortium - European Association for Architectural Education (ARCC-EAAE) International Conference, November 11-14, 2020 <http://www.arcc-arch.org/wp-content/uploads/2022/08/Download-2020-Proceedings-Volume-Two.pdf>
- Fisher, T. 2018. *Building Performance Evaluation: From Delivery Process to Life Cycle Phases*. Edited by Wolfgang F. E. Preiser, Andrea E. Hardy, and Ulrich Schramm. 2nd ed. Cham: Springer International Publishing AG. <https://doi.org/10.1007/978-3-319-56862-1>.
- Gravina da Rocha, C., Korb, S., and Sacks, R. 2022. *Work Structuring and Product Design for Customized Repetitive Projects*. Construction Management and Economics 40 (7–8): 526–47. <https://doi.org/10.1080/01446193.2021.1936100>.
- Nussbaumer, L. L. 2009. *Evidence-Based Design for Interior Designers (1st ed.)*. Fairchild Books.
- Park, J. and Kim, D. 2022. *A Case Study of Medicalized Wellness Clinic Design Process and Result in the Context of an Emerging Wellness Service Market*. DRS 2022 Conference. <https://doi.org/10.21606/drs.2022.309>
- Peppers, K., Tuunanen, T., Rothenberger, M., and Chatterjee, S. 2007. *A Design Science Research Methodology for Information Systems Research*. Journal of Management Information Systems 24 (3): 45–77. <https://doi.org/10.2753/MIS0742-1222240302>.
- Uysal, M. and Sogut, M. 2017. *An Integrated Research for Architecture-Based Energy Management in Sustainable Airports*. Energy 140 (December): 1387–97. <https://doi.org/10.1016/j.energy.2017.05.199>.
- van Aken, J., and Romme, A. 2012. *A Design Science Approach to Evidence-Based Management*. In The Oxford Handbook of Evidence-Based Management. Oxford University Press. <https://doi.org/10.1093/oxfordhb/9780199763986.013.0003>.
- Yin, R. 2017. *Case Study Research: Design and Methods*. 6th ed. SAGE Publications.

ENDNOTES

- ¹ <https://iida.org/competition/2022-student-design-competition>

Exposure to Particle Matter and Carbon Dioxide in a Naturally Ventilated Athletic Facility during the COVID-19 Pandemic

Panos Karaiskos¹, Layla Iskandar¹, Antonio Martinez-Molina², Miltiadis Alamaniotis¹

¹University of Texas at San Antonio, San Antonio, TX

²Drexel University, Philadelphia, PA

ABSTRACT: During the gradual return to the *new normality* after the COVID-19 pandemic, offices, businesses, and fitness centers have taken precautions to minimize the spread through close contact, and indirectly via contaminated objects. Evidence has shown that inhalation of infected aerosol particles such as Particle Matter (PM) can also transmit the virus, among other contaminants, therefore, PM concentrations should be kept low in order to mitigate the risk of airborne virus transmission. Past research has shown cases of lower PM concentrations in facilities with mechanical ventilation compared to naturally ventilated buildings. Furthermore, deep exhalation, associated with exercise, has been shown to increase PM concentrations by 400-600%. Among workout facilities, cross-training gyms are becoming increasingly popular worldwide. These facilities are generally not equipped with HVAC systems, relying solely on natural ventilation to create a comfortable and healthy indoor environment. The unique building type of a cross-training gymnasium has received little or no research attention at all compared to conventional fitness centers, commonly using mechanical systems. This study investigates the Indoor Air Quality (IAQ) of a naturally ventilated cross-training gym during the COVID-19 pandemic using four adapted natural ventilation scenarios. For this purpose, the indoor and outdoor temperature, relative humidity, air velocity, carbon dioxide (CO₂), and PM (PM_{2.5}-PM_{10.0}) levels were monitored for a period of 3 months. Additionally, 291 surveys on indoor environmental subjective opinions were collected and compared with the measured IAQ results. Results show significant CO₂ and PM concentration rises (particularly PM_{2.5}) that were highly impacted by occupancy levels. The CO₂ and PM levels exceeded the recommended standards by 45% and 60% respectively. The natural ventilation methods were therefore found insufficient to minimize the potential risk of COVID-19 transmission. These findings will provide a critical knowledge on how to operate any naturally ventilated building to create a healthier built indoor environment.

KEYWORDS: Particle Matter, Indoor Air Quality, Covid-19, Athletic Facilities, Natural Ventilation.

INTRODUCTION

The indoor air quality (IAQ) and the thermal comfort in sport facilities has been a subject of multiple studies (Revel and Arnesano 2014; Rajagopalan and Luther 2013). To begin with, indoor thermal conditions of athletic facilities are critical for athletes to reach high performance and high environmental satisfaction during their training (Huang et al. 2021). Furthermore, the IAQ of fitness centers is mostly affected by multiple variables such as the building type, the level of maintenance, the ventilation strategies, the indoor activities, and even the cleaning products being used to disinfect the areas (Huang et al. 2021; Cincinelli and Martellini 2017). Generally, IAQ literature focuses on the effects of outdoor and indoor air contaminants on the athletes (Carlisle and Sharp 2001; Mullins, 2018 ; Reche et al. 2020). Specifically, the human activity and the amount of people per surface area in closed spaces is often associated with the Carbon Dioxide (CO₂) concentrations (Seppänen et al. 1999). The production rate of CO₂ is mainly contingent on the number of people in the room and their metabolic levels (Lawrence et al., n.d.). It is common to see case studies where the recommended limit level for CO₂ is shown to be exceeded, for example, in published research papers of Zitnik et al. (Žitnik et al. 2016), and Andrade et al. (Andrade et al. 2018). Additionally, another study investigating eleven fitness centers with mechanical and natural ventilation systems, shows that at large, ventilation levels were inefficient (Ramos, Wolterbeek, and Almeida 2014). Besides CO₂, studies investigating human exposure to multiple other air contaminants have revealed the primary pollutants to be Particle Matter (PM_{2.5} - PM₁₀), staphylococci, nitrogen dioxide (NO₂), carbon monoxide (CO) and disinfection by-products (CHCl₃, NCl₃) (Salonen, Salthammer, and Morawska 2020).

At the present time of this study, because of the COVID-19 pandemic, the monitoring of Particle Matter (PM) is exceptionally relevant as there is mounting evidence that COVID-19 can also be transmitted by inhalation of infected saliva aerosol particles. Specifically, small aerosol particles have been found to carry the virus (van Doremalen et al. 2020; Asadi et al. 2020; Morawska and Cao 2020). Furthermore, when performing athletic activities, the higher speed of the inhaled air has been shown to transport contaminants deeper into the respiratory tract and the normal nose filtration of particles is not effective as most of the air is inhaled through the mouth (Ramos, Wolterbeek, and Almeida 2014; Carlisle and Sharp 2001; Andrade and Dominski 2018a;). Additionally, deep exhalation, associated with high

intensity exercise, has been shown to lead to a 400-600% increase in aerosol particle concentrations (Johnson and Morawska 2009). Based on the above-mentioned publications, keeping PM concentration levels under the recommended limits is critical to athletes' and occupants' health in general. While gyms and athletic facilities overall are becoming increasingly popular (ihrsa.org), the new building typology of a *cross-training* gym is currently unrepresented by the IAQ scientific literature. Cross-training is defined as an exercise protocol that utilizes several modes of training to develop a specific component of fitness (healthline.com). With an increasing number of cross-training enthusiasts (such as CrossFit® (Crossfit.com), the number of this type of cross-training gyms has reached to 14,000 locations worldwide and the number of athletes in those facilities have also increased dramatically in the past years reaching to 5 million (Crossfit.com.). However, unlike traditional gyms and other types of fitness centers, such as pools and arenas (Alves et al. 2013; Stathopoulou et al. 2008; Tolis, Panaras, and Bartzis 2018), there is relatively little published research about air quality and exposure to different pollutants in these cross-training facilities. Furthermore, the unique ventilation methods of these spaces usually consist of natural ventilation accompanied with floor or ceiling fans. This is exceptionally relevant since PM concentrations have been found to be much lower in facilities with mechanical ventilation compared to facilities with natural ventilation. Specifically, the largest concentrations were found in rooms for group activities (Slezakova et al. 2018). This fact makes this kind of research projects very relevant nowadays. The aim of this study is to provide insight on the IAQ in relation to natural ventilation and air cleaning measures of a cross-training gym located in San Antonio, Texas. The study focuses on the concentration levels of CO₂ and PM. The results indicate that the natural ventilation methods practiced by the cross-training facility management were unable to mitigate the significant rise of PM (PM_{2.5} – PM₁₀), and CO₂ concentrations in multiple occasions. The findings of this study will provide valuable data for designing safer and smarter ventilation protocols for naturally ventilated athletic facilities.

1.0 METHODOLOGY

1.1 Description of the athletic facility

The case study is a cross-training facility in San Antonio, Texas (Figures 1,2). The floor area of the gym is 4,197 ft² (390 m²) and the height of the ceiling is 16.4ft (5m) on the lowest level and 19.7ft (6m) on the highest level, yielding a total area volume of 75750ft³ (2145 m³). The gym is using natural ventilation in combination with 2 large ceiling fans and 2 large floor fans. The two garage-type doors d₁ and d₂ (Figure 3) that are used for natural ventilation are 9.8ft (3m) wide and 9.8ft (3m) tall each and are situated diametrically in the North and South facades of the building. The third door, d₃, is 2.9ft (0.9m) wide, 7.2ft (2.2m) tall and is placed on the west side of the building. There are no further openings or mechanical ventilation installed on the building.



Figure 2. Location, and exterior and interior views of the athletic facility (San Antonio, TX). Source:(Google maps, author 2022)

1.2. Monitoring campaign

The measured parameters were indoor and outdoor temperature(T), relative humidity(RH), carbon dioxide (CO₂) and Particulate Matter (PM_{0.3}, PM_{0.5}, PM₁, PM_{2.5}, PM₅, PM₁₀). Four different logging sensor types were used in the monitoring campaign (Table 1): indoor temperature and relative humidity data was measured with a total of fifteen HOBO® model MX1101 and fifteen HOBO® model U-12-001, which were strategically placed in the gym to create a three-dimensional grid (Figure 4).

Table 1 : Characteristics of the monitoring devices.

Measured Physical Variables	Brand & Model	Measuring Range	Precision	Response
<i>Indoor Air Temperature</i>	HOBO MX1101	32 to 158 °F (0 to 70 °C)	±0.38°F (±0.21 °C)	60 s
<i>Indoor Relative Humidity</i>	HOBO MX1101	1% to 90%	±2.0%	20 s
<i>Outdoor Air Temperature</i>	HOBO MX 2301A	32 to 158 °F (0 to 70 °C)	±0.38° °F (±0.25 °C)	60 s
<i>Outdoor Relative Humidity</i>	HOBO MX 2301A	0 to 100%	±2.5%	30 s
<i>Carbon Dioxide</i>	HOBO® model MX1102A	0 to 5000 ppm	±50ppm	60s

Particulate Matter	WolfSense® model PC-3500	0-10,000,000 particles/ft ³	0.3µm- 25.0µm	60s
--------------------	--------------------------	----------------------------------------	---------------	-----

Outdoor temperature and relative humidity were measured and logged with two HOBO® model MX 2301A. Additionally, CO₂ levels were measured and logged using three HOBO® model MX1102A. Finally, PM levels were logged using a WolfSense® model PC-3500. All devices were calibrated according to the manufacturer's specifications. The indoor T and RH sensors were placed in a grid form at two different elevations at 4.9ft(1.5m) and 13ft(4m), respectively. The outdoor T and RH sensors were protected from direct solar radiation and rain. The indoor CO₂ sensors were placed in three locations around the gym at heights of approximately 4.9ft (1.5m). The PM sensor was situated at an elevation of 4.9ft (1.5m) as well, and at a minimum distance of 4.9ft (1.5m) from all walls to minimize the particle dispersion effects on the readings (Jin et al. 2013). The gym equipment consisted of stationary cardio machines and stationary weightlifting and calisthenics stations.

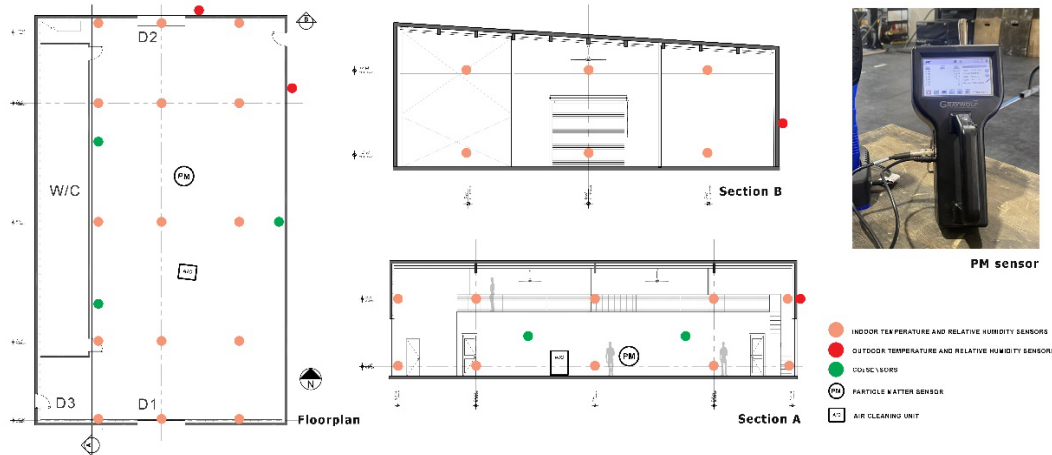

Figure 3: Sensor placement floor plan, longitudinal and transversal sections, and picture of PM sensor. Source: (Author 2022)

1.3. Air filtration unit

An air filtration unit model MedifyAir® MA-112 was also installed in the gym for the monitoring campaign (Figure 4). To ensure sufficient air circulation the unit was placed in a 1.6ft (50cm) distance from all furniture and equipment according to the manufacturer's requirements. The air filter consisted of 3 layers of cleaning components: a pre-filter, an H13 HEPA filter, and an activated carbon filter. The air filtration unit has an air inlet at the sides and air outlet for the filtered air at the top, at approximately 2.3ft (71cm). The Clean Air Delivery Rate (CADR) output for the unit is at 33,500ft³ (950 m³) per hour. In accordance with the manufacturer specifications, the HEPA filter can remove up to 99.9% of particles down to 0.1 microns as well as PM_{2.5} particles. The certified H13 HEPA filter fitted in the filtration unit does not produce ozone (O₃) and other contaminant by-products. This unit was selected for its square foot coverage range, capable of covering the 4,197 ft² gymnasium area of this study. Specifically, the standard air filtration coverage for this unit is 5000 ft² in 60m (<https://medifyair.com/> n.d.).

1.4. Thermal Comfort Survey

Thermal comfort, also known as human comfort, was also assessed, and considered during the IAQ monitoring period. In the case of this cross-training facility, after the end of each workout session, each participating athlete completed a questionnaire with their demographic data and their personal assessment of the air quality as well as the comfort levels at the gym during their workout. The questionnaire was also used to monitor the subject's designated workout area inside the gym. Based on the parameters for measuring thermal comfort described by the ASHRAE 55 ("Thermal Environmental Conditions for Human Occupancy" 2014), the questionnaire aimed at obtaining the necessary data needed to apply Fanger's method. The amateur athletes submitted a total of 291 questionnaires.

This survey included questions about:

- Thermal Sensation Vote (TSV) regarding the indoor thermal ambient, based on the ASHRAE 55's seven-point sensation scale ("Thermal Environmental Conditions for Human Occupancy" 2014)
- subject's physical symptoms during and after their workouts (if any),
- subject's thermal perception of indoor relative humidity and air quality through a series of simplified questions.

1.5. Ventilation Scenarios

The monitoring process, as well as the subjective survey data collection, were launched in November 2021 and continued until January 2022 for a total duration of 90 days, out of which 4 days are selected for further analysis in this study. Each of the focused 4 days represents a unique ventilation scenario that was implemented during that date of

the monitoring process (Table 2). These 4 unique ventilation scenarios were selected to assess the ventilation methods most commonly practiced by the gym management of this study. All the IAQ loggers installed in the building were configured to record data in 5-minute intervals and they were calibrated before the launch of the study to minimize data discrepancies. Furthermore, the monitoring process was continuous throughout all daily gym activities and overnight when the facility was closed, to capture the worst- and best-case scenarios of each day. The gym owners and management team offered their facilities for this study in return for the air quality assessment report. The gym members were informed via email prior to participating in the study. The participation in the study was voluntary. As mentioned above, a total of 291 surveys were collected by the athletes which participated in the experiment during the 3-month monitoring process. The gym members performed commonly practiced cross-training workouts that consisted of a combination of cardio and weightlifting exercises in sessions of 60 minutes. Multiple 60-minute workouts were performed every day during the open hours of the gym by different teams of athletes. The occupancy level during these workout sessions was also monitored at an hourly rate. In between workouts the gym area remained unoccupied. The four focused ventilation scenarios, each of which was implemented for 24 hours, are listed in Table 2. The parameters used for these scenarios are: North door open or closed, South door open or closed, fans on or off, air filtration unit on or off.

Table 2: Four experimental ventilation days/scenarios.

Scenario	South Door	North Door	Fans	Air Filtration Unit	Date
1	Open	Open	On	On	16-Nov-2021
2	Open	Closed	On	Off	22-Nov-2021
3	Closed	Closed	Off	Off	3-Jan-22
4	Closed	Closed	On	On	11-Jan-22

2.0 RESULTS

2.1. Temperature and relative humidity

Figure 5 displays the measured hourly-averaged temperature and relative humidity data obtained by the 30 indoor and 2 outdoor sensors. These graphs are showing each ventilation scenarios described in Table 2.

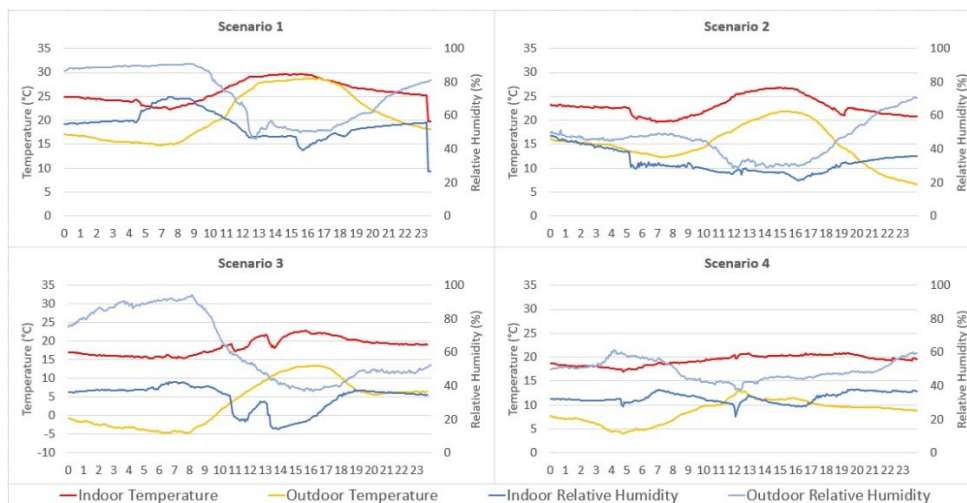

Figure 4: Hourly indoor and outdoor temperature, and relative humidity levels for the 4 scenarios. Source: (Author 2022)

Temperature data (Figure 5) show a clear pattern of indoor temperatures being significantly higher than the outdoor temperatures in all ventilation scenarios. Additionally, the relative humidity data also displays a clear trend, showing indoor levels remaining lower than the outdoor relative humidity during all 4 scenarios. Furthermore, indoor relative humidity tends to remain fairly stable compared to the outdoor relative humidity which fluctuates at a greater rate. A drop in indoor temperature and a simultaneous rise in relative humidity is observed in scenario 3, at 12:00pm. At that time a cross-training class of 13 people was ongoing. No other similar pattern is apparent in the rest of the scenarios, which indicates that the occupancy effect on the temperature and the humidity indoors is insubstantial.

2.2. Carbon Dioxide

Figure 6 displays the measured CO₂ concentrations by the MX1102A (results averaged between the three MX1102A loggers), with measurements taken in 5-min intervals for each of the four 24h scenarios. Each line of the graphs

represents one scenario out of the four days of the experiment. The red line of 1,000ppm represents the recommended decision point for the determination of adequate amounts of outdoor air by the National Institute for occupational Safety & Health (NIOSH) (National Institute for Occupational Safety and Health 1987). During scenario 1, the CO₂ concentrations remain between 400ppm and 600ppm for most of the day. The levels and the fluctuations of CO₂ levels for scenario 1 are overall insignificant and indicate adequate ventilation levels. Looking at scenario 2, during which only the South door was open, the CO₂ concentrations remained between 400ppm and 800ppm for the vast majority of the day. The highest concentrations measured in scenario 2 were at 1:00pm right after the end of a class consisting of 11 athletes. Following with scenario 3, with both doors closed, the CO₂ concentrations in this case reached above the limit of 1,000ppm and remained above the limit for multiple hours. Specifically, during the hours of uninterrupted cross-training classes (5:00-9:30am) the CO₂ levels are accumulating and remain above the limit. After the end of the 9:30am class, the CO₂ levels drop rapidly since there is no activity until noon. The CO₂ is again increasing during the 12:00-1:00pm class, however, in this case the single 1-hour interval class (with 13 athletes) was insufficient to raise the CO₂ levels above 1,000ppm. Finally, for scenario 4 with both doors closed, the CO₂ concentration reached levels above 1,000ppm in multiple occasions as well. The CO₂ concentrations reached 1,441ppm at 7:30pm during which time the gym was occupied by 11 athletes. Additionally, significant concentration drops are observed during which the CO₂ levels drop below 1,000ppm, reaching recommended values. The drops are observed “in between classes” from 10:30am until 12:00pm and from 13:30pm until 3:30pm while the gym remained unoccupied.

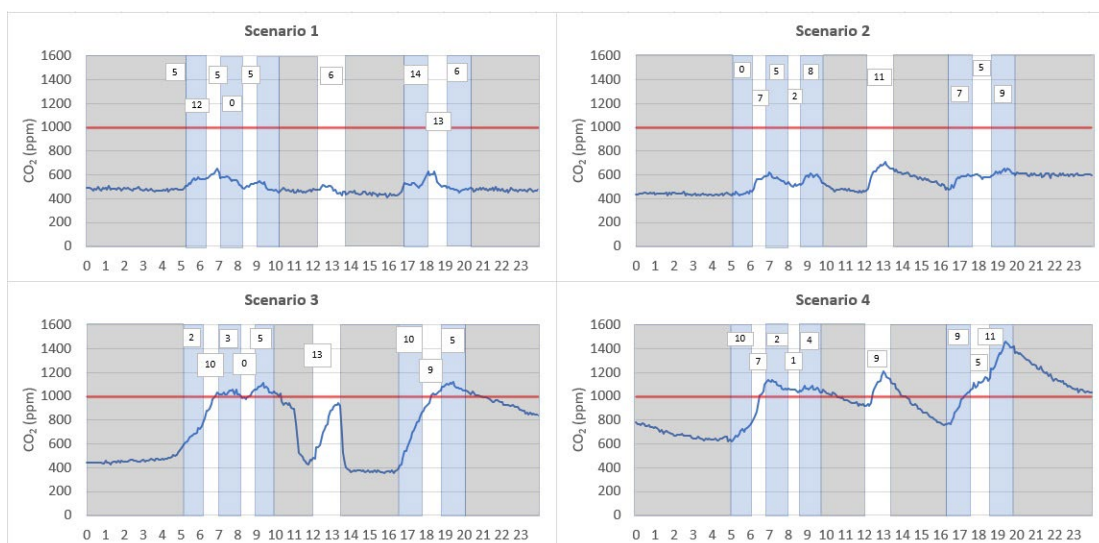

Figure 5: Hourly CO₂ concentration levels during the four analyzed scenarios relative to the recommended limit of 1000ppm. Source: (Author 2022)

2.3. Particulate matter

This section presents the measured levels of PM concentrations in two parts. First the results are presented in a 24-h Time-Weighted Average (TWA) for the concentration levels to be directly comparable with the available national regulations (“National Ambient Air Quality Standards (NAAQS),” n.d.; <https://ww2.arb.ca.gov/> n.d.). In the second part, the results are further analyzed and presented in 5-minute intervals for each scenario.

2.3.1 Particulate matter analyzed in 24-hour timeframe

Figure 7 displays the measured particulate matter concentrations for the different scenarios. The data is represented in 24-hour TWA for each set-up. The left graph of figure 7 displays the concentrations for PM₁₀ and PM₅ (PM₅ are embodied in PM₁₀). The red line here, represents the National Ambient Air Quality Standard (NAAQS) TWA limit of 150 µg/m³ (“National Ambient Air Quality Standards (NAAQS),” n.d.) for PM₁₀. The second graph of figure 7 displays combined the concentrations for PM_{2.5}, PM₁, PM_{0.5} and PM_{0.3} (PM₁, PM_{0.5} and PM_{0.3} are embodied in PM_{2.5}). The red line in this case represents the 24-hour TWA limit of 35 µg/m³ issued by NAAQS for PM_{2.5} (“National Ambient Air Quality Standards (NAAQS),” n.d.).

1. For scenario 1 (both doors open) the PM concentrations were relatively low for both PM₁₀(58.7 µg/m³) and PM_{2.5}(25.3 µg/m³). None of the NAAQS limits were exceeded.
2. Moving on with Scenario 2, (only South door open) the NAAQS limit was exceeded for PM_{2.5} reaching 45.6 µg/m³ however it did not exceed the PM₁₀ limit. This dichotomy between PM_{2.5} and PM₁₀ is also displayed in scenarios 3 and 4, and it is indicating that the commonly practiced natural ventilation strategies for this facility are not fully successful.
3. For scenario 3 (Doors closed) the PM limits for both PM₁₀ and PM_{2.5} were exceeded for that day. For PM₁₀, the concentrations reached a level slightly above the national regulation (154.3 µg/m³). In the case of PM_{2.5}, the levels of 64.6 µg/m³ are close to double of the NAAQS limit.

- Finally, for the last graph for scenario 4 (doors closed) the same pattern is displayed: PM_{2.5} concentrations remain at high levels for the day (62.6 µg/m³) while PM₁₀ concentrations remain well under the regulation limit, at 117.9 µg/m³.

To sum up, the PM_{2.5} NAAQS limit was exceeded in 3 out of the 4 scenarios while the PM₁₀ NAAQS limit was exceeded only in 1 scenario.

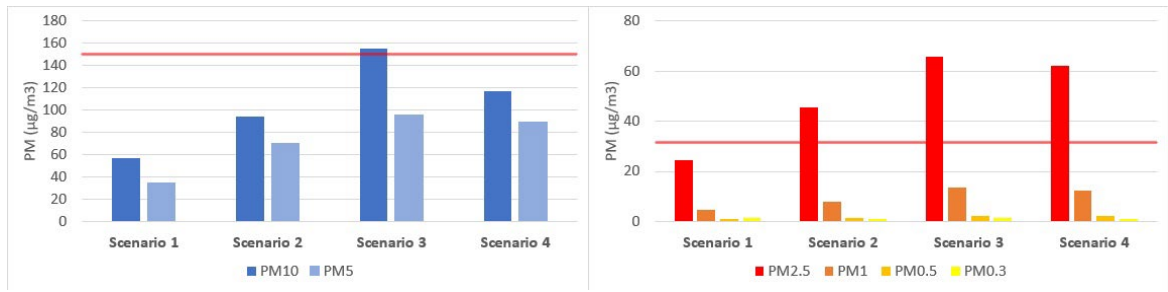

Figure 6: Particulate matter(PM₁₀, PM₅, PM_{2.5}, PM₁, PM_{0.5} and PM_{0.3}) 24-h TWA for the four scenarios relative to the national recommended limits. Source: (Author 2022)

2.3.2 Particulate matter results analyzed in 5-minute timeframe

Figure 8 displays the same measured PM concentrations, however, the data in this case is presented in 5-minute intervals for each scenario. The blue and white areas represent the occupied hours during which gym classes were ongoing. The occupancy level is specified at the top of each class timeframe. The gray fragments represent unoccupied hours during which the gym was closed and/or empty. This real time analysis of the particle concentration levels was found appropriate to study the potential correlation of PM spikes with the hourly occupancy level despite the lack of national legislation recommendations for PM concentrations in this timeframe. The PM profiles in figure 8 clearly show a daily regular pattern of higher concentrations when the athletic facility is occupied by athletes. The increase in PM readings was systematically observed in the daytime hours (05:00-09:30am, 12:00-1:00pm, 4:30-7:30pm) characterized by higher human occupancy. The measured concentration peaks for scenario 1 and scenario 2 are in the range of 500-600 µg/m³. Additionally, the peaks for scenario 3 reach above 5,000 µg/m³, a 10-fold increase from scenarios 1 and 2. Finally, for scenario 4 the peak concentrations reached levels above 900 µg/m³. This great variability of PM concentrations observed in the 5-minute interval timeframe is showcasing instances of significantly compromised IAQ, undetected by the original 24-h analysis and the 24-h TWA national regulations for PM.

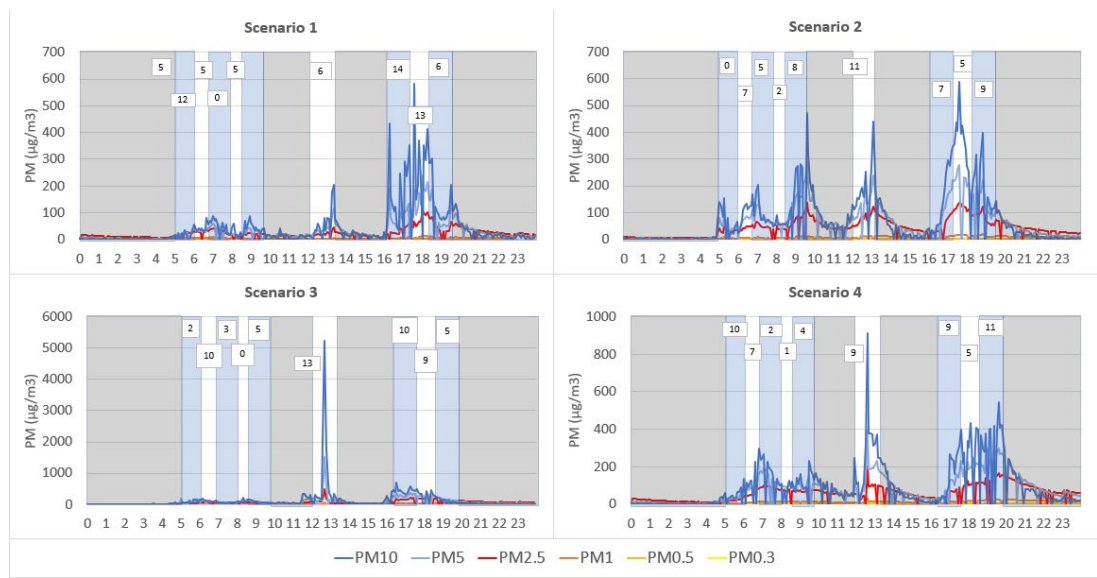

Figure 7: Particulate matter 5-minute interval graphs and hourly occupancy levels for the four scenarios. Source: (Author 2022)

2.4. Questionnaire results

Figure 9 presents the qualitative results of the questionnaire study, in which 291 surveys were submitted. Out of the 291 subjects, 152 were male and 139 were female. Most of the athletes were between the ages of 31 and 40 followed by the 18-30 and 41-50 age range. The perception of temperature was mostly neutral and slightly cool or slightly warm.

Only two athletes reported feeling “hot” and only five athletes reported feeling “cold”. The humidity perception of the subjects was also mostly normal and dry. Twenty-seven subjects reported “very dry”, however only 3 subjects reported “very humid” perception of indoor humidity. Furthermore, the IAQ perception results were mostly “Very satisfied” and “slightly satisfied” while 11 athletes reported “Slightly unsatisfied” and only 1 athlete reported “Very unsatisfied”. Finally, out of the 291 subjects, 35 reported physical symptoms after their workout. The most common physical symptoms reported by the athletes were “Dry mouth” and “dry eyes”, followed by the less common “asthma”, “congestion”, and “headache”. Reports of symptoms were more prevalent during scenario 4 (both doors closed) with 30% of the athletes that participated in the study reporting physical symptoms that day. For scenarios 1, 2 and 3, 10%, 23% and 6% reported physical symptoms respectively.

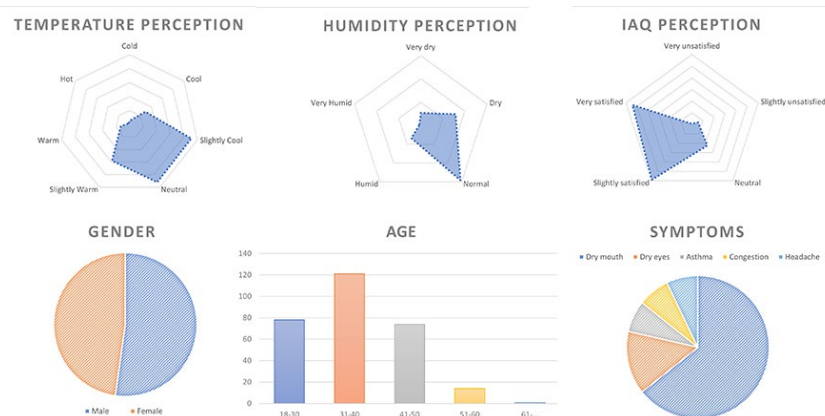

Figure 8: Questionnaire campaign results, showcasing demographic, and comfort level data. Source: (Author 2022)

CONCLUSIONS

This paper conducted an extensive monitoring campaign to measure the concentrations of CO₂ and of a wide range of PM in a naturally ventilated cross-training gym during 4 unique and controlled ventilation scenarios. Multiple cases with compromised IAQ were identified. The high concentrations of CO₂, PM_{2.5} and PM₁₀ that were observed during the monitoring process indicate that the athletic facility had inefficient ventilation which led to sub-optimal air quality, particularly prevalent during the coldest days of the monitoring process (scenarios 3 and 4), when natural ventilation was minimal. The CO₂ and PM levels exceeded the national standard limits by 45% and 60% respectively in the worst-case scenarios that were observed. More specifically, the 24-hour average national limit of PM concentrations was exceeded in scenario 3 for PM₁₀ and in all 4 scenarios for PM_{2.5}. A pattern was identified of PM_{2.5} concentration levels exceeding the national limit at an increased rate compared to PM₁₀ levels. This contrast between PM_{2.5} and PM₁₀ is indicating that different levels/methods of natural ventilation are necessary to adequately lower the concentrations of each of the PM size categories. However, considering the California CAAQS regulations for PM₁₀ concentrations, that antithesis is no longer significant. The 5-minute PM profiles clearly confirm a daily regular pattern of higher concentrations during specific hours (05:00-09:30am, 12:00-13:00pm and 4:30-7:30pm) characterized by higher human occupancy. The biggest increase in PM concentration was observed in scenario 3, during which the concentration peak was at the range of 5,000 µg/m³ from background levels varying from 100 to 700 µg/m³. The great variability of PM concentration in the 5-minute interval timeframe indicates a potential need for additional regulations that take into account the rapid PM concentration spikes which can have a negative effect on occupant comfort and health.

Finally, in the subject of CO₂, the suggested limit was exceeded in scenarios 3 and 4 following a similar pattern with PM concentrations. Furthermore, the data indicated a correlation between the CO₂ concentration peaks and the increased discomfort reported by the athletes via the questionnaire study. This was, however, not the case with the measured PM concentration peaks. This antithesis reveals that relatively high PM concentration levels might not be as easily detected by the human senses, in which case, the importance of indoor air quality monitoring with a focus on PM is pronounced.

ACKNOWLEDGEMENTS

The authors gratefully acknowledge all gym members and gym management team that supported and collaborated in this study.

REFERENCES

- Alves, Célia A., Ana I. Calvo, Amaya Castro, Roberto Fraile, Margarita Evtugina, and Enow F. Bate-Epey. 2013. "Indoor Air Quality in Two University Sports Facilities." *Aerosol and Air Quality Research* 13 (6): 1723–30. <https://doi.org/10.4209/aaqr.2013.02.0045>.

- Andrade, Alexandro, and Fábio Hech Dominski. 2018. "Indoor Air Quality of Environments Used for Physical Exercise and Sports Practice: Systematic Review." *Journal of Environmental Management*. Academic Press. <https://doi.org/10.1016/j.jenvman.2017.11.001>.
- Andrade, Alexandro, Fábio Hech Dominski, Marcelo Luiz Pereira, Carla Maria de Liz, and Giorgio Buonanno. 2018. "Infection Risk in Gyms during Physical Exercise." *Environmental Science and Pollution Research* 25 (20): 19675–86. <https://doi.org/10.1007/s11356-018-1822-8>.
- Asadi, Sima, Nicole Bouvier, Anthony S. Wexler, and William D. Ristenpart. 2020. "The Coronavirus Pandemic and Aerosols: Does COVID-19 Transmit via Expiratory Particles?" *Aerosol Science and Technology*. Taylor and Francis Inc. <https://doi.org/10.1080/02786826.2020.1749229>.
- Carlisle, A. J., and N. C.C. Sharp. 2001. "Exercise and Outdoor Ambient Air Pollution." *British Journal of Sports Medicine*. <https://doi.org/10.1136/bjsm.35.4.214>.
- Cincinelli, Alessandra, and Tania Martellini. 2017. "Indoor Air Quality and Health." *International Journal of Environmental Research and Public Health*. MDPI. <https://doi.org/10.3390/ijerph14111286>.
- Crossfit.com. n.d. "Crossfit Statistics." Accessed June 18, 2022. <https://www.crossfit.com/>.
- healthline.com. 2021. "Cross-Training Is Effective for All Athletes." Healthline.Com. December 3, 2021. <https://www.healthline.com/health/fitness/cross-training>.
- Doremalen, Neeltje van, Trenton Bushmaker, Dylan H. Morris, Myndi G. Holbrook, Amandine Gamble, Brandi N. Williamson, Azaibi Tamin, et al. 2020. "Aerosol and Surface Stability of SARS-CoV-2 as Compared with SARS-CoV-1." *New England Journal of Medicine* 382 (16): 1564–67. <https://doi.org/10.1056/nejmc2004973>.
- <https://medifyair.com/>. n.d. "MA-112 Air Purifier." Accessed October 23, 2022. <https://medifyair.com/products/ma-112>.
- <https://ww2.arb.ca.gov/>. n.d. "Inhalable Particulate Matter and Health (PM2.5 and PM10)." Accessed June 12, 2022. <https://ww2.arb.ca.gov/resources/inhalable-particulate-matter-and-health>.
- Huang, Chongyun, Jiabin Que, Qianni Liu, and Yufeng Zhang. 2021. "On the Gym Air Temperature Supporting Exercise and Comfort." *Building and Environment* 206 (December). <https://doi.org/10.1016/j.buildenv.2021.108313>.
- ihrsa.org. n.d. "Total U.S. Health Club Membership by Year." (18pt Space). Accessed June 18, 2022. <https://www.ihrsa.org/about/media-center/#>.
- Jin, Hanhui, Chao He, Lin Lu, and Jianren Fan. 2013. "Numerical Investigation of the Wall Effect on Airborne Particle Dispersion in a Test Chamber." *Aerosol and Air Quality Research* 13 (2): 786–94. <https://doi.org/10.4209/aaqr.2012.04.0106>.
- Johnson, Graham R, and Lidia Morawska. 2009. "The Mechanism of Breath Aerosol Formation." *Journal of Aerosol Medicine and Pulmonary Drug Delivery*. Vol. 22. <http://eprints.qut.edu.au/>.
- Lawrence, Ernest Orlando, Michael G Apte, William J Fisk, and Joan M Daisey. n.d. "Preprint Associations Between Indoor CO2 Concentrations and Sick Building Syndrome Symptoms in US Office Buildings: An Analysis of the 1994–1996 BASE Study Data."
- Morawska, Lidia, and Junji Cao. 2020. "Airborne Transmission of SARS-CoV-2: The World Should Face the Reality." *Environment International*. Elsevier Ltd. <https://doi.org/10.1016/j.envint.2020.105730>.
- Mullins, Jamie T. n.d. 2018. "Title: Ambient Air Pollution and Human Performance: Contemporaneous and Acclimatization Effects of Ozone Exposure on Athletic Performance."
- "National Ambient Air Quality Standards (NAAQS)." n.d. <http://epa.gov/air/criteria.html>.
- National Institute for Occupational Safety and Health. 1987. "Guidance for Indoor Air Quality Investigations."
- Rajagopalan, Priyadarsini, and Mark B. Luther. 2013. "Thermal and Ventilation Performance of a Naturally Ventilated Sports Hall within an Aquatic Centre." *Energy and Buildings* 58: 111–22. <https://doi.org/10.1016/j.enbuild.2012.11.022>.
- Ramos, C. A., H. T. Wolterbeek, and S. M. Almeida. 2014. "Exposure to Indoor Air Pollutants during Physical Activity in Fitness Centers." *Building and Environment* 82 (December): 349–60. <https://doi.org/10.1016/j.buildenv.2014.08.026>.
- Reche, Cristina, Mar Viana, Barend L. van Drooge, Francisco Javier Fernández, Miguel Escribano, Gemma Castañón-Vinyals, Mark Nieuwenhuijsen, Paolo Emilio Adami, and Stéphane Bermon. 2020. "Athletes' Exposure to Air Pollution during World Athletics Relays: A Pilot Study." *Science of the Total Environment* 717 (May). <https://doi.org/10.1016/j.scitotenv.2020.137161>.
- Revel, G. M., and M. Arnesano. 2014. "Measuring Overall Thermal Comfort to Balance Energy Use in Sports Facilities." *Measurement: Journal of the International Measurement Confederation* 55: 382–93. <https://doi.org/10.1016/j.measurement.2014.05.027>.
- Salonen, Heidi, Tunga Salthammer, and Lidia Morawska. 2020. "Human Exposure to Air Contaminants in Sports Environments." *Indoor Air*. Blackwell Munksgaard. <https://doi.org/10.1111/ina.12718>.
- Seppänen, O A, Seppänen, W J Fisk, and M J Mendell. 1999. "Association of Ventilation Rates and CO 2 Concentrations with Health and Other Responses in Commercial and Institutional Buildings."
- Slezakova, Klara, Cátia Peixoto, Marta Oliveira, Cristina Delerue-Matos, Maria do Carmo Pereira, and Simone Morais. 2018. "Indoor Particulate Pollution in Fitness Centres with Emphasis on Ultrafine Particles." *Environmental Pollution* 233 (February): 180–93. <https://doi.org/10.1016/j.envpol.2017.10.050>.
- Stathopoulou, O. I., V. D. Assimakopoulos, H. A. Flocas, and C. G. Helmis. 2008. "An Experimental Study of Air Quality inside Large Athletic Halls." *Building and Environment* 43 (5): 834–48. <https://doi.org/10.1016/j.buildenv.2007.01.026>.
- "Thermal Environmental Conditions for Human Occupancy." 2014. www.ashrae.org.

- Tolis, Evangelos I., Giorgos Panaras, and John G. Bartzis. 2018. "A Comprehensive Air Quality Investigation at an Aquatic Centre: Indoor/Outdoor Comparisons." *Environmental Science and Pollution Research* 25 (17): 16710–19. <https://doi.org/10.1007/s11356-018-1882-9>.
- Žitnik, M., K. Bučar, B. Hiti, Z. Barba, Z. Rupnik, A. Založnik, E. Žitnik, L. Rodriguez, I. Mihevc, and J. Žibert. 2016. "Exercise-Induced Effects on a Gym Atmosphere." *Indoor Air* 26 (3): 468–77. <https://doi.org/10.1111/ina.12226>.

IEQ Factors in Learning: A Case Study of the Impact of Acoustics on Students with Autism Spectrum Disorder (ASD) in a South-Central School in United States

Michael Lekan-Kehinde¹, Abimbola Asojo¹, Bonnie Sanborn²

¹ University of Minnesota, Saint Paul, MN

²DLR Group, Chicago, IL

ABSTRACT: Acoustics is one of the major factors that impact language acquisition, concentration, information retention, and general comfort within the environment needed for preparing children for adult life. Autism Spectrum Disorder (ASD) is a neurodevelopmental condition which could be complex, multifactorial, and pervasive and is widely described under an umbrella term as Neurodiversity. Neurodiversity, while initially coined to describe individuals with ASD, describes anyone with a different brain process. As the understanding of cognitive and neurosciences increases, the number of people identified as neurodiverse is nearly 30% of the global population. The study involved a mixed methods approach using literature review, case study, simulation, and analysis of a school in the south-central part of the United States. This research first examined the available guidelines and standards for learning spaces with good acoustical quality. Next, we conducted a case study of a space designed and renovated to meet this guideline, and finally, made performance threshold and material specification recommendations for improvement to ensure better inclusion of students with ASD.

The information from this study identified that, unlike neurotypical students, the physical performance of space with respect to acoustic quality has not provided clear design guidelines and suitability to meet the needs of students with ASD as they are vastly different and respond to current acoustical guidelines differently. The results describe the current solution used to ensure acoustic suitability for students with ASD and the limitations student with ASD encounter in spaces. This research makes design and material recommendations for improving learning spaces and concludes with an increased need for an integrated understanding of acoustics by all players in the design field.

KEYWORDS: Autism Spectrum Disorder (ASD), Learning, Neurodiverse, Materials, Children, Learning Spaces, Indoor Environmental Quality (IEQ).

INTRODUCTION

Research has indicated that individuals with autism have reported frustration, annoyance, and physical discomfort as frequent outcomes of non-conducive learning environments due to sound/noise, lighting, air quality, and temperature among other Indoor Environmental Quality (IEQ) factors (Kanakri et al. 2016). While the impact of the indoor environment is universal, neurodiverse students experience the impact differently. Research has further suggested that repetitive behavior is an important marker of physiological distress caused by discomfort from IEQ factors in the environment. (Kanakri et al. 2016). This study investigates the relationship between Acoustics, one of the Indoor Environmental Quality [IEQ] factors, and autism spectrum disorder (ASD) students' perception of their K-12 learning space. The research studies the impact of Acoustical Performance on (ASD) students in a set of selected learning spaces in a K-12 school by considering their learning activities and relating them to the accepted performance threshold and material selection criteria for neurotypical students.

1.0 BACKGROUND

1.1 Autism

Autism is a neurodevelopmental condition typically defined by characteristics such as delayed verbal and social skills, restrictive and repetitive motor movement (Figure 1). They are theorized to occur due to failure of "theory of mind", the "mirror neuron system", "weak central coherence" or imbalances of "empathizing and sympathizing,". Individuals with autism sensory input modulate sensory input differently than others and some research has related longer response time to attention-shifting stimuli. Also, students with autism have been observed to engage in repetitive actions that do not have an apparent function. These behaviors are labeled Restrictive and Repetitive Behaviors (RR) and are associated with the sensitivity of either hyposensitivity or hypercreativity of autistic students to stimuli (Kanakri et al. 2016).



Figure 1: Why is Autism called autism spectrum disorder? (Carmen B. Pingree Autism Center of Learning n.d.)

1.2. Acoustics and Learning

The complexity of sound in learning was explained by Scannell et al. (2015) with at least five factors. The first factor is the physical attributes of sound i.e., the decibel level, frequency, and reverberation. Low-frequency sounds for example have been considered more annoying than higher-frequency sounds at equal sound pressure levels. Secondly, the effects of sound on learning vary by individual characteristics such as gender and personality as some learners are more sensitive to noise and have difficulty screening it out than others. Thirdly, the type of task and noise from irrelevant speech was found to impair proofreading performance but did not affect other cognitive tasks like reading comprehension and simple arithmetic. Fourthly, the situational factors. This refers to the sound in an acoustical environment during learning and recall. An example is the movement of a chair, table, or furniture within learning spaces or students making unexpected sounds. Lastly, noise during learning appears to be more detrimental than noise during subsequent performance leading to an increased need for concentration during reading than during leisure or eating (Scannell et al. 2015).

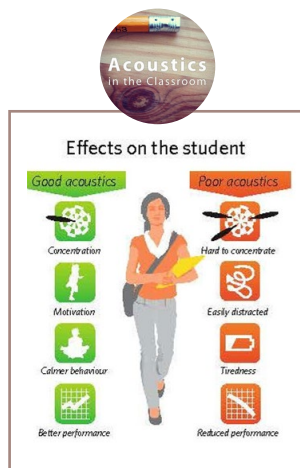

Figure 2: Effect of Acoustics on Students (Saint-Gobain Ecophon n.d.)

Several studies have shown that poor acoustics inside classrooms negatively affect both teaching and learning processes (Figure 2) and have identified that the acoustical properties of a learning space should allow a minimum of 90% of useful information leaving a speaker to reach the ears of a listener (Mark 2020). A review of seven articles by Leggett, Dodd, and Donn (2015) showed a statistically significant association between acoustics and learning performance. Poor acoustically performing learning spaces were identified to result in students' lower performance (Ackley, Donn, and Thomas 2017)). Some of the research done by comparing reading test scores of students in two schools in different locations indicated that students in the second location which was in a flight path of a major airport were found to have a significantly worse student performance than in the first location in a quiet neighborhood. In Sweden, another test of reading comprehension was done by experimentation consisting of 12 -14 years old students which compared prerecorded noise from aircraft, road traffic, train, or verbal communication to that of quiet conditions. The study indicated students exposed to prerecorded noise performed significantly worse than in quiet conditions. On the other hand, verbal and noise coming from trains did not interfere the reading comprehension (Cheryan et al. 2014). This review further identifies sound/noise level (Figure 3) in learning spaces as one of the great concerns of teachers as a study by Ackley, Donn, and Thomas (1017) identifies teachers' opinions on how noise impairs learning,

performance and causes discomfort. Also identifying the decrease in the efficiency of students' learning process, reverberation time was also defined by Mark as one of the most common and generally identified challenges of learning spaces (Ackley, Donn, and Thomas 2017 & Mark 2020). The research further identified the impact of poor acoustic properties in affecting the quality of teaching, learning, and performance and concluded that there is a limited number of studies showing the acoustical challenges experienced in learning spaces. Thereby instigating the need for an intensified effort to identify, study and develop studies that provide more insight into the acoustical performance of spaces and how it relates to learning, especially for the neurodiverse population.

1.3. Acoustics and Wellbeing of students with Autism

Acoustics have been identified to have an implication on well-being as they can lead to psychological stress (Scannell et al., 2015) and responses including a spike in blood pressure and heart rate (Luscombe 2016), concentration disturbance, difficulty with perception and rest (Kanakri et al. 2016), and emotional responses such as annoyance and anger. Research has identified that an increase in noise levels and poor acoustics may make students feel more annoyed than students in a good acoustic learning space. This conclusion was identified through a number of studies that compared schools in industrial or traffic noise areas with those of quieter neighborhoods, which showed a significant increase in student annoyance. (Klatte et al. 2010). Wellbeing related outcomes could therefore serve as indicators of environmental quality because of what Scannell et al. (2015) call patronage (describes the usage of a space) and habitability (describes the convenience or conducive nature) of a space. Also, well-being interacts with other factors such as productivity, performance, interpersonal relations, organizational commitment, and other outcomes (Scannell et al. 2015).

Individuals with autism have reported frustration, annoyance, and physical discomfort as frequent outcomes of non-conducive learning environments due to sound/noise, lighting, air quality, temperature, etc. While the impact of persistent and loud noise is universal, neurodiverse students experience the impact differently. Research further suggests that repetitive behavior is an important marker of physiological distress caused by noise in the environment. (Kanakri et al. 2016)

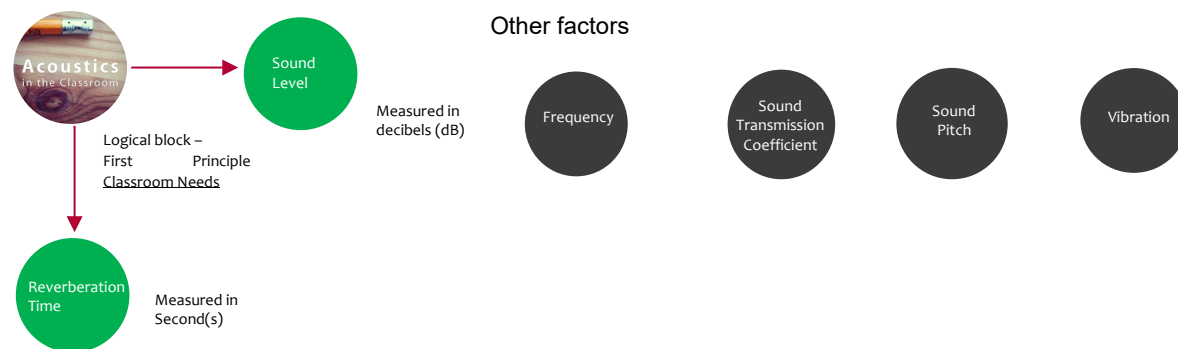

Figure 3: Acoustics in Classroom (Author 2022)

Sound Level - High sound level has been associated with an increased level of annoyance and even more so if the source of the noise is visible, speech-related, or intermittent (as opposed to continuous). Noise annoyance manifests physiologically as a stress response (Scannell et al. 2015)

Reverberation- Reverberation in learning spaces has been associated with negative outcomes for well-being. Classrooms with longer Reverberation Time (RTs) have also been reported to increase the annoyance of students and have negative implications for social outcomes, as it lowers students' ratings of social relationships with peers and teachers. Also, it was identified as important to teachers' well-being as teachers with longer RTs (0.59 -0.73) experience lower job satisfaction, reduced energy level, and an increased desire to leave their job. (Scannell et al. 2015)

1.4. Learning Environment

There have been several definitions of the learning environment. Valtonen et al. (2020) defined such an environment using five different perspectives, which can be used to contemplate the different elements of the environment: physical spaces, teaching and learning approaches, social and collaborative aspects supporting learning, technologies used, and contextual learning spaces outside the campus. However, Hansen et al (2018) define learning environments as, the combination of the physical environment [the classrooms]; the learning activities which take place in this environment during school hours, and the behavior of the students which affects or might affect these activities (Hansen et al. 2018). The USDHHS Early Childhood Learning and Knowledge Center defined a learning environment as nurturing spaces that support the development of all young children. They include classrooms, play areas, areas for caregiving routines, and outdoor areas. They further defined that Learning environments are well-organized and managed settings (ECLKC 2021). Learning activities are therefore usually in Groups or traditional teaching styles. The group activities are practical while traditional activities are whole-class activities. Leggett, Dodd, and Donn (2015) also

identify this testing scenario for learning activities to include testing for a signal-to-noise ratio of the group and whole class teaching and recommended the signal-to-noise ratio at student's ear should not exceed 15 dB for group activities or whole class teaching.

2.0 STUDY METHOD

2.1. Previous Studies

Previous literature has highlighted the importance of the learning environment, the types of learning activities in the learning area, and the impact of acoustics on children's growth and development. Emphasis on the higher degree of impact on neurodiverse children due to sensory processing and behavior. A few studies have further highlighted the impact of acoustics on the well-being of students with autism (Kanakri et al. 2016). A lack of design improvement and a uniform approach to using materials were also factors considered in creating a more conducive environment for students with autism. Architects and designers have debated the neurotypical approach defined by immersing individuals with autism in a typical environment as possible with the consideration that this would enable them to handle it, while the sensory design theory approach alters the environment to be sensory considerate of individuals with perceptual and integration differences (Kanakri et al. 2016).

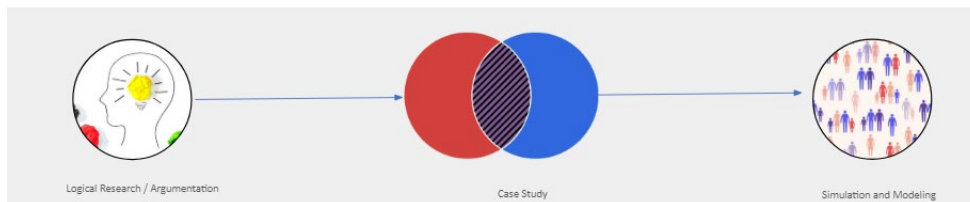

Figure 4: Study Method (Author 2022)

This study seeks to understand whether the neurotypical environment is suitable for neurodiverse students. The research evaluates the acoustical performance of one renovated K-12 learning space through case studies and expert interviews to understand how suitable the current learning environment is. This study suggests threshold recommendations and materials specification improve the acoustical performance of this learning space and model/test/simulate the impact of these recommendations on students with autism spectrum disorder.

2.2. Present Study

Locating Research Participant/ Location

The focus of the research was to provide solutions to some of the industry challenges faced by students with autism in the learning environment through a case study approach. This was done through a consortium firm, DLR Group, and the University of Minnesota. This guided the study location and building selected for this study; emails stating the criteria were sent through the firm advisor, organization-wide, and advisory gotten from the K-12 focused team of DLR Group in selecting K-12 school for this study.

Approach

The study seeks to examine a case study of a K-12 school in the Southwestern part of the United States that was designed to meet the ANSI metric for sound level and reverberation time. The school was approached through its district for approval to study students with autism. However, the school district advised the timing as a barrier to conducting the research study. The research study was therefore conducted through the available plans and acoustical data available through the consortium firm, DLR Group in which the researcher worked as a Research Fellow during the period of this research.

2.3. Simulation of Building A and Building B

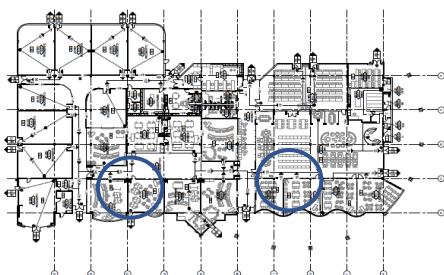

Figure 5: Floor Plan (Author 2022)

The selection of this building among the four considered from the approached district and designed by a consortium firm was done based on a few criteria a) the building designed to accommodate autism spectrum disorder students or special needs education activities, b) the available public and private information on the building is shared in conducting this case study by the designing firm.

Though Building A and Building B can be considered a single building they are separated in function. Therefore, one space each was considered in Building A and Building B section of the building. Building B and Building A is used as a learning academy of 200 students accommodating mixed grades and serves to encourage social interaction and provide informal study spaces. The interior of the building was redesigned from an existing structure with a request by the client to ensure the media center fits that of the student's common media center for both study and traditional use, the introduction of daylighting to all spaces to ensure better lighting of spaces.

The first space considered was the *Junior Education Classroom* in Building B section of the building with an area of 977 sq. ft. The building was simulated based on the current condition by exporting the Revit model through the simplification of geometry to DXF. The simplified geometric was imported to Enhanced Acoustic Simulator for Engineers (EASE), an Acoustic Analysis software where the acoustic model was created and then utilized Analysis Utility for Room Acoustics (AURA) to analyze the data and for visualization below. The conformance testing was done based on the ANSI standard for acoustic conformance testing which included the location of three source sound speakers at five microphone locations in the defined listening area (Figure 6a).

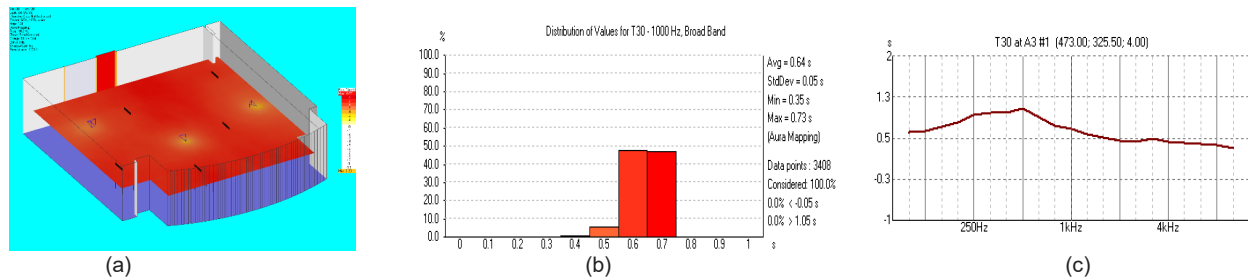

Figure 6: (a) & (b) Simulation in Conformance to ANSI standard in the Junior Education Classroom - Building B Section & Reverberation Distribution around the junior Education Classroom (Authors 2022) (c) Average reverberation at mid-band frequencies in the Junior Education Classroom (Authors 2022)

The result of the simulation with a concrete floor with thin carpet, smooth concrete columns, standard 2 layers of gypsum finish wall, standard marker board folding partitions, ceiling soffits, and Rockfon arctic acoustic ceiling gave an average unoccupied reverberation time of 0.64 sec with a standard deviation of 0.05 at T30 frequencies. (See Table 1)

Table 1: Typical and Recommended Material Specification for specific building components

Typical Room Materials		Absorption Coefficients							
		125 Hz	250 Hz	500 Hz	1000 Hz	2000 Hz	4000 Hz	8000 Hz	NRC
1.0	Floors - Concrete with Thin Carpet	0.03	0.15	0.25	0.33	0.35	0.40	0.40	0.33
2.0	Columns - Smooth Concrete	0.01	0.01	0.02	0.02	0.02	0.05	0.06	0.03
3.0	Standard Walls - 2 Layers Gypsum Finish	0.28	0.12	0.10	0.07	0.13	0.09	0.10	0.10
4.0	Standard Folding Partition - Marker Board	0.12	0.28	0.19	0.18	0.19	0.15	0.16	0.18
5.0	Doors - Standard Wood Door	0.15	0.11	0.10	0.07	0.06	0.07	0.06	0.08
6.0	Ceiling Soffits - 1 Layer Gypsum Finish	0.55	0.14	0.08	0.04	0.12	0.11	0.10	0.09
7.0	Acoustics Ceiling Tile - Rockfon Artic	0.74	0.72	0.61	0.75	0.83	0.90	1.00	0.77
Recommended Treatment Materials		Absorption Coefficients							
		125 Hz	250 Hz	500 Hz	1000 Hz	2000 Hz	4000 Hz	8000 Hz	NRC
4.1	Wall Treatment - 2" Fsoorb A mounted	0.18	0.61	1.00	1.00	1.00	1.00	1.00	1.00
6.1	Window Treatment - Wenger Retractable Acoustic Curtain	0.07	0.31	0.60	0.75	0.73	0.70	0.70	0.70
8.0	Ceiling Replacement - Rockfon Tropic	0.79	0.94	0.75	0.92	1.00	1.00	1.00	0.92

Table 2: Typical and Recommended Material Specification impact for classroom

Building and Space Number	The frequency at T30 (seconds)								
	125 Hz	250 Hz	500 Hz	1000 Hz	2000 Hz	4000 Hz	8000 Hz	average unoccupied	standard deviation
Building B 4120 - Existing Conditions	0.63	0.92	1.03	0.66	0.44	0.44	0.36	0.64	0.05
Building B 4120 - Recommended Treatment	0.67	0.65	0.66	0.51	0.35	0.34	0.29	0.41	0.03

However, with 2 major modifications to the materials for the space i.e., the Wall and Window treatment to 2" Fsofb A mounted Wall treatment and Wenger Retractable Acoustic Curtain to all windows in the space while a replacement of Rockfon Tropic Ceiling was simulated. The average unoccupied reverberation time of 0.41 as shown in Figure 7 with a standard deviation of 0.03 at T30 frequencies (See Table 2).

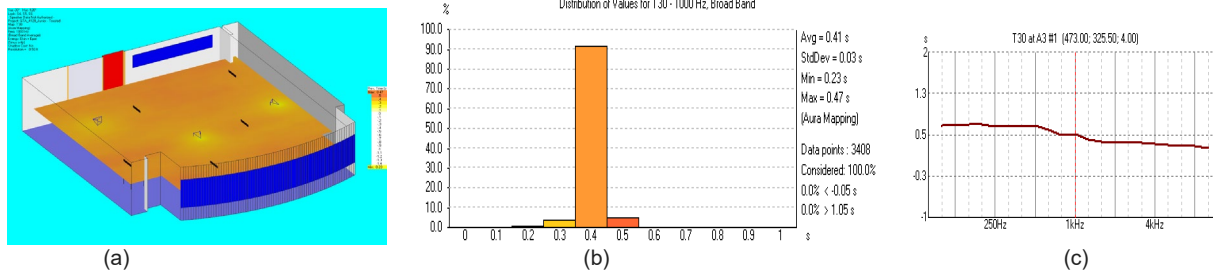

Figure 7: (a) & (b) Treated Simulation of the Junior Education Classroom (Building B) & Reverberation Distribution around the classroom due to the treatment. (c) Reverberation distribution measurements around Classroom due to treatment (Authors, 2022)

The second space considered was the Makerspace in Building A section of the building with an area of 579 sq. ft. The conformance testing was done based on the ANSI standard for acoustic conformance testing which included the location of three source sound speakers at five microphone locations in the defined listening area.

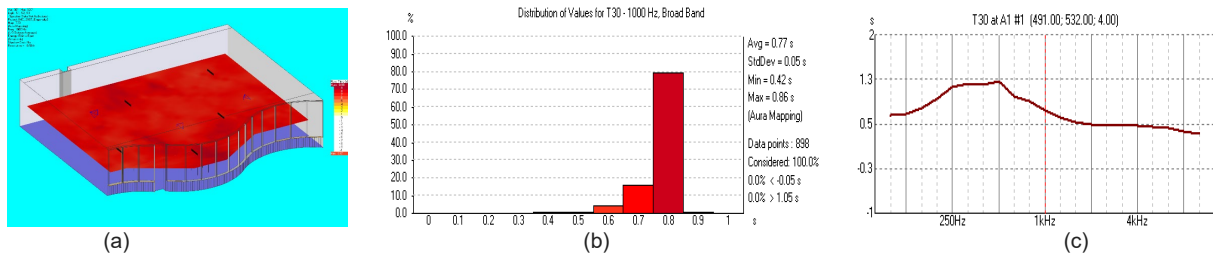

Figure 8: (a) & (b) Simulation in Conformance to ANSI standard in the Makerspace room – Building A Section & Reverberation Distribution around Makerspace Classroom (c) Average reverberation at mid-band frequencies in the Makerspace (Authors 2022)

The result of the simulation with a concrete floor with thin carpet, smooth concrete columns, standard 2 layers of gypsum finish wall, standard maker board folding partitions, ceiling soffits, and Rockfon arctic acoustic ceiling gave an average unoccupied reverberation time of 0.64 sec with a standard deviation of 0.05 at T30 frequencies. (See Table 3)

Table 3: Typical and Recommended Material Specification for specific building components

Typical Room Materials		Absorption Coefficients							
		125 Hz	250 Hz	500 Hz	1000 Hz	2000 Hz	4000 Hz	8000 Hz	NRC
1.0	Floors - Concrete with Thin Carpet	0.03	0.15	0.25	0.33	0.35	0.40	0.40	0.33
2.0	Columns - Smooth Concrete	0.01	0.01	0.02	0.02	0.02	0.05	0.06	0.03
3.0	Standard Walls - 2 Layers Gypsum Finish	0.28	0.12	0.10	0.07	0.13	0.09	0.10	0.10
4.0	Block Wall - Course Unpainted Brick	0.16	0.13	0.15	0.11	0.13	0.14	0.15	0.13
5.0	Glass Walls and Windows - Heavy Glass	0.18	0.06	0.04	0.03	0.02	0.02	0.02	0.03
6.0	Window and Glass Wall Casements – Aluminum	0.05	0.10	0.10	0.10	0.07	0.02	0.10	0.07
7.0	Ceiling Soffits - 1 Layer Gypsum Finish	0.55	0.14	0.08	0.04	0.12	0.11	0.10	0.09
8.0	Acoustics Ceiling Tile - Rockfon Artic	0.74	0.72	0.61	0.75	0.83	0.90	1.00	0.77

Recommended Treatment Materials		Absorption Coefficients							
		125 Hz	250 Hz	500 Hz	1000 Hz	2000 Hz	4000 Hz	8000 Hz	NRC
4.1	Wall Treatment - 2" Fsorb A mounted	0.18	0.61	1.00	1.00	1.00	1.00	1.00	1.00
6.1	Window Treatment - Wenger Retractable Acoustic Curtain	0.07	0.31	0.60	0.75	0.73	0.70	0.70	0.70
8.0	Ceiling Replacement - Rockfon Tropic	0.79	0.94	0.75	0.92	1.00	1.00	1.00	0.92

Table 4: Typical and Recommended Material Specification

Building and Space Number	The frequency at T30 (seconds)								
	125 Hz	250 Hz	500 Hz	1000 Hz	2000 Hz	4000 Hz	8000 Hz	average unoccupied	standard deviation
Building A 2107 - Existing Conditions	0.67	1.12	1.22	0.73	0.49	0.48	0.36	0.77	0.05
Building A 2107 - Recommended Treatment	0.70	0.74	0.63	0.42	0.30	0.31	0.29	0.42	0.03

However, 2 major modifications to the materials for the space i.e., the Wall and Window treatment to 2" Fsorb A mounted Wall treatment and Wenger Retractable Acoustic Curtain to all windows in the space while a replacement of Rockfon Tropic ceiling was simulated. The average unoccupied reverberation time of 0.41 as shown in Figure 9 with a standard deviation of 0.03 at T30 frequencies (See Table 4)

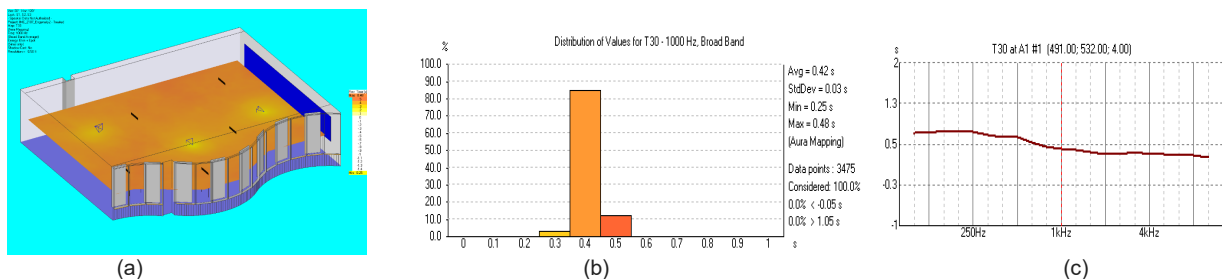

Figure 9: (a) & (b) Treated Simulation of the Makerspace room - Building A & Reverberation Distribution around the classroom after treatment (c) Treated average reverberation at mid-band frequencies of Makerspace room (Authors 2022)

2.4. Recommendation

The purpose of this research is to understand the suitability of the current ANSI acoustical guideline for a student with autism spectrum disorder by providing recommendations through an iterative process of understanding the acoustical learning needs of students with ASD. It created a simulation of the recommended improvement and acoustical

performance thresholds through alternative material specification in learning spaces. In selecting recommended material improvements for the space, sustainability and red listing of harmful materials by the International Living Future Institute (ILFI) were considered. There is therefore a need for a similar approach to determine materials that might hamper the learning experience of ASD students. Designers need to redefine learning spaces to ensure a larger percentage of spaces are a smaller environment that provides better accommodation for students with ASD, incorporating more daylighting into spaces. Redefining large spaces may require spaces that accommodate large amounts of people at once which directly correlates to an increased level of sound for communication be developed into smaller concept spaces that can still ensure inclusiveness to students with ASD

Lastly, there is a need for further advisory, sensitization, and training of the parents, educators, and fellow students on the uniqueness of people with ASD, and how to provide help to them in the learning spaces, especially in communications. Teachers most especially should be taught how to understand the learning space they instruct in changing their cadence to fit either small spaces, medium spaces, or large spaces, to ensure speech intelligibility.

CONCLUSION

These recommendations present crucial implications for practice. This study highlights the need for a more integrated understanding of acoustics by players in the building design field, including interior designers, lighting designers, and product manufacturers. Each discipline makes decisions that play a role in ensuring inclusive learning spaces for students with ASD. This study also highlights the importance of the Noise Reduction Coefficient (NRC) of materials across the full frequency band, rather than just a single number metric used in material selection; designers should request more information about acoustic performance from manufacturers when presented with a single number NRC. Likewise, design teams should take into cognizance the sound implication of building systems such as the mechanical, electrical, and lighting systems within the building to reduce the background noise.

ACKNOWLEDGEMENTS

Special thanks to Dr. Amy Elser and Dr. Jason Wolff, University of Minnesota; Dr. Lily Wang University of Nebraska – Lincoln; Melinda Rogers, Trailblazer Speech; and the DLR Group team members that contributed to the research; Logan Pippitt, David Manley, Anat Grant, Kaylene Campbell, Jill Maltby-Abbott, Dr. Helen Ho, and B Sanborn.

REFERENCES

- Ackley, Aniebietabasi, Michael Donn, and Geoff Thomas. 2017. "The Influence of Indoor Environmental Quality in Schools A Systematic Literature Review." *The Next 50 Years, (51st International Conference of the Architectural Science Association (ANZAScA))*, no. December.
- Carmen B. Pingree Autism Center of Learning. n.d. "Why Is Autism Called Autism Spectrum Disorder?" Accessed December 4, 2022. <https://carmenbpingree.com/blog/what-is-autism-spectrum-disorder/>.
- Cheryan, Sapna, Sianna A. Ziegler, Victoria C. Plaut, and Andrew N. Meltzoff. 2014. "Designing Classrooms to Maximize Student Achievement." *https://doi-org.Ezp2.Lib.Umn.Edu/10.1177/2372732214548677* 1 (1): 4–12. <https://doi.org/10.1177/2372732214548677>.
- ECLKC. 2021. "Learning Environments | ECLKC." 2021. <https://eclkc.ohs.acf.hhs.gov/learning-environments>.
- Hansen, Ellen Kathrine, Stine Maria Lourcing Nielsen, Diana Georgieva, and Kathrine Marie Schledermann. 2018. "The Impact of Dynamic Lighting in Classrooms. A Review on Methods." In *Lecture Notes of the Institute for Computer Sciences, Social-Informatics and Telecommunications Engineering, LNICST*, 229:479–89. Springer Verlag. https://doi.org/10.1007/978-3-319-76908-0_46.
- Kanakri, Shireen M., Mardelle Shepley, Louis G. Tassinary, James W. Varni, and Haitham M. Fawaz. 2016. "An Observational Study of Classroom Acoustical Design and Repetitive Behaviors in Children With Autism." *https://doi-org.Ezp2.Lib.Umn.Edu/10.1177/0013916516669389* 49 (8): 847–73. <https://doi.org/10.1177/0013916516669389>.
- Klatte, Maria, Jürgen Hellbrück, Jochen Seidel, and Philip Leistner. 2010. "Effects of Classroom Acoustics on Performance and Well-Being in Elementary School Children: A Field Study." *Environment and Behavior* 42 (5). <https://doi.org/10.1177/0013916509336813>.
- Leggett, Sarah, George Dodd, and Michael Donn. 2015. "The Acoustic Performance of Modern Learning Environments Vs . Single Cell Classrooms," no. December. <https://doi.org/10.3850/978-981-09-7961-4>.
- Luscombe, Jeremy Luscombe i. 2016. "Acoustics Affect Productivity and Well Being." 2016. <https://information.insulationinstitute.org/blog/noise-affects-productivity-and-well-being>.
- Mark, Irwin. 2020. "Acoustics and Learning | How Do They Improve Learning? | Resonics." 2020. <https://resonics.co.uk/how-acoustics-improve-learning/>.
- Saint-Gobain Ecophon. n.d. "Influence of Acoustics in the Classroom." Accessed December 5, 2022. www.ecophon.com.
- Scannell, Leila, Murray Hodgson, Jorge Garcia, and Moreno Villarreal. 2015. "The Role of Acoustics in the Perceived Suitability of , and Well-Being in Informal Learning Spaces," no. January. <https://doi.org/10.1177/0013916514567127>.
- Valtonen, Teemu, Ulla Leppänen, Mareena Hyypiä, Anna Kokko, Jyri Manninen, Henriikka Vartiainen, Erkkö Sointu, and Laura Hirsto. 2020. "Learning Environments Preferred by University Students: A Shift toward Informal and Flexible Learning Environments." *Learning Environments Research* 24:3 24 (3): 371–88. <https://doi.org/10.1007/S10984-020-09339-6>.

Impact of Vegetated Infrastructure to Mitigate the Urban Heat Island Effect in Dhaka, Bangladesh

Tasneem Tariq^{1,2}, Ute Poerschke¹, Lisa Domenica Iulo¹

¹ Pennsylvania State University, State College, PA, United States of America
² Bangladesh University of Engineering and Technology (BUET), Dhaka, Bangladesh

ABSTRACT: Climate change has a strong negative impact on Bangladesh, though this country has an insignificant carbon footprint. With rapid urbanization, Dhaka City, the capital of Bangladesh, is progressively falling short of sustaining outdoor life due to the Urban Heat Island (UHI) effect, which is one of the most documented phenomena of urban climate change. The urban temperature inside and around Dhaka is about 2.5°C to 7.5°C higher than its surrounding rural temperature. This leads to an increased urban energy demand and decreased quality of life for the residents of the city. The city possesses only 0.12 acres of greenery and open areas per thousand population, while the National Recreation and Park Association (NRPA) recommends devoting a range between 6.25 and 10.5 acres of total open space per thousand population. A comfortable outdoor temperature can also lead to a comfortable indoor environment, which reduces the energy load of the city. Therefore, this paper investigates the impact of adding vegetated infrastructures in the city to reduce the UHI effect in Dhaka. For this study, Purbachal, a developing residential area of Dhaka was selected and through ENVI-met software simulation, the impact of adding vegetated infrastructures on the outdoor air temperature was observed by adding vegetated infrastructures on three levels: at street level, on green roofs and in green walls on the buildings. It analyzes which type of intervention can reduce the UHI effect and to which extent. This research reveals that the intervention with urban trees and grass is most effective in mitigating the UHI effect as it reduces the mean air temperature most efficiently during both day and night times as compared to green roofs and green facades. Based on the findings, recommendations have been generated for the tropical city to re-establish outdoor life in Dhaka, where urban spaces will be comfortable.

KEYWORDS: UHI effect, Mitigation, Vegetated infrastructure, ENVI-met simulation, thermal comfort

INTRODUCTION

Climate-related risks were found to be generally higher at low latitudes and for disadvantaged people and communities (Buis 2019). This is severely impacting the quality of life for the people of Bangladesh, a developing country in the Global South. A thermally comfortable outdoor environment also has a positive influence on the indoor climate, leading to lower energy use for space conditioning (Erell 2008). The demand for comfort conditions in buildings is significantly increased because of exposure to uncomfortable outdoor temperatures in Bangladesh (Ahmed 2003). Therefore, creating a thermally comfortable microclimate in the urban environment is of utmost importance. Cities which are covered with large areas of materials such as concrete and asphalt that magnify heat from the sun more than less developed suburbs, an impact known as Urban Heat Island (UHI) effect. Studies found that, in the last 100 years, the average temperature in Dhaka has increased by 0.5°C, and in the next 50 years temperatures in the city are expected to increase by another 1.5–2 °C (Dhaka Power Distribution Company 2015). Thermally comfortable outdoor urban spaces should be revived for environmental, social, and cultural reasons. Ensuring an acceptable standard in the quality of urban life in the present dynamic urban environment is a great challenge for architects, urban designers, planners, and policy makers (Ahmed 2003). Several mitigation measures have been proposed to reduce the increased warming of urban areas around the world. Among these measures, the use of vegetated infrastructures has possibly the most potential for mitigation, though it should be noted that the effectiveness of using vegetated infrastructure is dependent on local climatic conditions (Givoni 1998, Jusuf et al. 2015, Memon et al. 2010). This research is based on Dhaka, the capital of Bangladesh, a location in the tropical monsoon climate zone. It is one of the fastest-growing mega cities in the world located at 23.24°N, 90.23°E and 8.8 m above sea level. To explore better opportunities, huge number of people are migrating to Dhaka every day. To accommodate this large population, the city is growing both horizontally and vertically and the green spaces are getting decreased. Therefore, it is highly important to assess the effects of vegetated infrastructures on the outdoor microclimate in the city. In this study, the microclimate climate is assessed by considering the most influential environmental parameters, air temperature. An evaluation of the urban heat mitigation capacity by vegetated infrastructures at road level, roof level, and building surface level has been analyzed to provide some recommendations on the proposed greenspace distribution in Purbachal (23.8458° N, 90.4974° E), which is the biggest (24.9 sqkm) planned township in the country.

1.0 PROBLEM STATEMENT

Favorable microclimates in cities have a significant impact on the urban life of the people (Nikolopoulou and Steemers 2003) (Gaitani, Mihalakakou, and Santamouris 2007). Outdoor spaces in a city that are thermally comfortable have an increasing social and economic benefit as they attract more local residents, vendors, office workers, etc., and increase social interaction (Nikolopoulou, Baker, and Steemers 2001). Thermally comfortable outdoor spaces in different parts of the city often turn into public gathering places thereby fostering a high-quality urban life. Rapid urban population growth due to the high flow of migrated population towards cities is one of the main reasons for unplanned urban expansion in developing countries (Siddique, 2014). Cities, which are covered with large heat-holding capacity surfaces and structures, such as, concrete and asphalt, stay warmer and release more heat than suburbs and surrounding country. According to NASA, most land regions will see more hot days, especially in the tropics (Buis 2019). Therefore, the UHI effect should be mitigated in Bangladesh for two major factors. First, it will make the outdoor environment comfortable, which has a great impact on the health and performance of the people. Second, as outdoor hostile environment also increases the energy load of the indoor spaces of the city, mitigation of UHI effect will reduce the energy demand of Dhaka. In addition, these mitigation strategies can be applied to other warm-humid regions, which will eventually aid to reduce the overall temperature rise and climate change of the world.

Traditionally, several social and economic activities, like crop processing, cooking, eating, sewing, gossiping and even schooling, have taken place in the outdoor spaces in Bangladesh (Islam 2002). A comfortable outdoor microclimate even seems to be a prerequisite for Dhaka city to ensure socio-cultural integration. Parks and green spaces of Dhaka City are now converted into urban habitats. In the past, several studies have been carried out on trend of climate change in climatic parameters over Bangladesh. Chowdhury and Debsharma (1992) and Mia (2003) pointed out that temperature has risen by using historical data of some selected meteorological station. Thus, the UHI effect is getting worse in Dhaka with the time (Mridha 2002 and Hossain and Nooruddin 1993). The rising temperatures is currently a growing environmental concern for Dhaka. The temperature trends during last 60 years (1950-2010), based on observed data of BMD (2011), where both the maximum and minimum temperatures follow upward trends, making the average day temperature rising. The monthly mean maximum and minimum temperature profile in Dhaka city also show upward trends, for four-time spans; 1950-1980, 1981-1990, 1991-2000, and 2001-2011 BMD (2012). It is evident that the annual average temperature of Dhaka is increasing with time. Though people in these regions tend to tolerate both higher temperatures with higher levels of relative humidity (Mallick 1994), the UHI effects have a considerable effect on the occupant's thermal comfort perception and performance and well-being. According to the World Bank (2000), the risk associated to human health in tropical developing countries is one of the salient risks of climate change. Therefore, it is very important to observe the climate and UHI effect in Dhaka. Dhaka possesses only 0.12 acres of vegetated and open areas per thousand people. According to the National Recreation and Park Association (NRPA) recommendations, a range between 6.25 and 10.5 acres of total open space per thousand members of the population is needed (NRPA, 2000). The overheated outdoor environment has contributed to a growing preference for a lower comfort temperature indoor and thus put an immense pressure on the energy demand in the city (Ahmed, 2003). To control the progressive energy demand, it is required to control the outdoor microclimatic conditions by reducing the UHI effect in the Dhaka City. Urban trees and greenery can have direct and indirect effects by shading and ambient cooling (Cameron 2014, Sharmin et al. 2012). Having trees at the road island, green roof on top of buildings and green façade are recently getting popular in Dhaka. This research analyzed the impact of these green interventions on UHI mitigation in Dhaka. Therefore, research questions of the study are: Can the addition of vegetated infrastructures aid to mitigate the UHI effect in Dhaka? Which type of interventions work most effectively to reduce the UHI effect?

2.0 METHODOLOGY

The new planned residential area, Purbachal, was selected to observe the impact of vegetated infrastructures to mitigate the UHI effect in Dhaka, Bangladesh. To observe the future environmental conditions of Purbachal through computer simulations, if development occurs according to the current master plan, where only 6.6% have been reserved as urban green and open spaces, a small section of 121.6m by 68.7m with 12 building plots has been selected. In case 01, no intervention was done in the selected area. In case 02, trees and grasses have been added at the street level. In case 03, green roofs have been created in all buildings and in case 04, one green facade has been added in all buildings and in case 05, all these green interventions have been added together (Figure 1). Modelling simulations were performed using the computational fluid dynamics (CFD) and microclimate model of ENVI-met. ENVI-met is a prognostic non-hydrostatic model for the simulation of surface-plant-air interactions, which is composed by a 3D main model and in addition a one-dimensional atmospheric boundary layer (ABL) model, which can extend from the ground surface up to 2500 m (Gatto et al., 2020). ENVI-met can simulate the microclimate in urban environment and assist for the environmental planning of new towns (Langer et al., 2012). The "Leonardo Module," included in ENVI-met (V4.4.5 Summer20, 64 bit), renders visual images based on the numerical output file from ENVI-met simulation and the output is visualized by Leonardo. The respective impacts of these green interventions have been simulated and observed on air temperature, one of the most important environmental parameters. The impacts have been observed at on July, since it is the most critical month for Dhaka with the highest relative humidity and air temperature. These findings have helped to identify the effectiveness of selected green interventions in mitigating UHI effect and to generate some recommendations for the future growth of the Dhaka City.

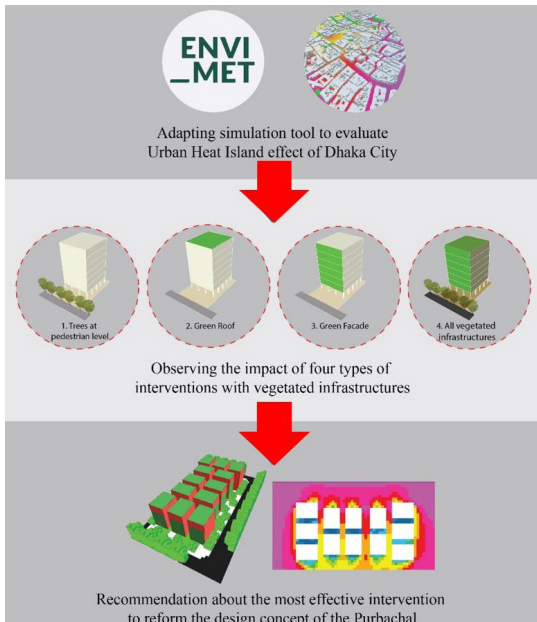

Figure 1: Research Methodology. Source: (Author 2022)

3.0 SIMULATION, ANALYSIS AND DISCUSSION

For this study, the 3D simulation area (computational domain) of the Purbachal (Latitude 23.85°N, 90.50°E) was modelled with a computation grid dimension of 121.59 m (x direction) × 73.30 m (y direction), with a vertical height of 64 m. The areas, which include buildings and vegetations were meshed with a grid resolution of 2 m × 2 m × 2 m, except for the lowest five cells (close to the ground) whose vertical resolution was 0.4 m. To improve model accuracy and stability, 3 nesting grids were employed. The Initial and boundary conditions used in ENVI-met simulations were air temperature: 28°C-35°C, relative humidity 79%- 84%, wind speed 3m/s, wind direction 135°, roughness length 0.1 (BMD, 2022). These environmental data was used in ENVI-guide for the month of July 2025 to predict the future air temperature at 1.4 m level, after the potential urban development, as per the current masterplan and existing FAR (Floor Area Ratio) rules of Dhaka City (Figure 2).

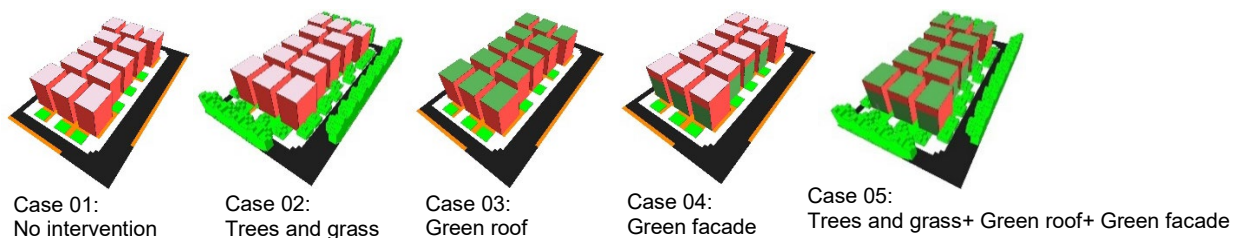

Figure 2: Types of green interventions applied in this research. Source: (Author 2022)

For Case 01 (No intervention), the street, pavement, soil, future buildings were considered to create the base case scenario. For Case 02 (Urban trees and grass), forty-three (43) 3D plants and grass were placed in the road islands on the south, east and west roads, pavement, and open spaces of the plot in the selected area. For Case 03 (Green roof), the entire model was converted to individual segments and then all the segments of the roof were modelled as default green roof (without air gap) with [01NADS] greens with mixed substrate, in all the buildings. For Case 04 (Green facade), the entire model was converted to individual segments and then equal number of segments same as the roof were modelled as default green facade (without air gap) with [01NADS] greens with mixed substrate, in all the buildings. Case 05 (Combined interventions of Urban trees and grass, Green roof, and Green facade), forty-three (43) trees and grass, Green roof with green with mixed substrate (without airgap) and Green facade with green with mixed substrate (without airgap) were implemented together to observe the combines effects of all vegetated infrastructures. For all cases, the simulations are repeated to identify the resultant air temperature at 1.4 m level as affected by the interventions. From the simulation results the effectiveness of these green interventions to mitigate the UHI effect of Dhaka City has been identified. The first column of Table 1 shows the air temperature of the selected area without vegetation. The second, third, fourth and fifth column show the estimated air temperature of the same area for Case 02 (Urban Trees, Case 03 (Green Roof), Case 04 (Green Facade) and Case 05 (Combined all green interventions) every two hours in a single day (15 July 2025).





Table 1: ENVI-met maps of Mean Air Temperature, AT (°C). Source: (Author 2022)

Time	Case 01 No intervention	Case 02 Trees+ Grass	Case 03 Green Roof	Case 04 Green Facade	Case 05 Combined
8:00					
<i>Mean:</i>	30.2013	29.84628	30.19378	30.18847	29.84604
10:00					
<i>Mean:</i>	32.5859	32.02156	32.55496	32.56258	31.99636
12:00					
<i>Mean:</i>	34.35889	33.66288	34.3339	34.35534	33.64944
14:00					
<i>Mean:</i>	35.3276	34.4991	35.30463	35.31845	34.49063
16:00					
<i>Mean:</i>	35.42683	34.6991	35.40285	35.39744	34.67899
18:00					
<i>Mean:</i>	33.5724	33.31217	33.56166	33.56687	33.31578
20:00					
<i>Mean:</i>	32.4259	32.29351	32.42111	32.43755	32.30839
22:00					
<i>Mean:</i>	31.4454	31.34993	31.442	31.46069	31.36705
00:00					
<i>Mean:</i>	30.4755	30.38971	30.47255	30.49227	30.4076
2:00					
<i>Mean:</i>	29.5049	29.42667	29.49796	29.52271	29.44471
4:00					
<i>Mean:</i>	28.5207	28.43652	28.51815	28.5389	28.45435
6:00					
<i>Mean:</i>	29.1017	29.04242	29.09894	29.12113	29.06092

4.0 FINDINGS AND DISCUSSION

From the simulation results, the effectiveness of the four types of interventions- 1) planting trees and grass at ground level, 2) creating green roofs, 3) building green walls and 4) combining all the three interventions- to mitigate the UHI effect of Dhaka City has been identified with the aid of Leonardo. The changing patterns of the main environmental factor, air temperature (AT) on every two hours have been observed to identify the impact of the applied green interventions. Table 1 shows the mean value of AT for in every 2 hours for all five cases. Each mean value represents the average of 1585 values, which gives an overall idea of the AT of that time period. In Table 2, grey color cells indicate air temperature without any intervention (Case 01). All the green and orange colored cells show the air temperature reduction and increasement respectively with green interventions (Case 02-Case 05) as compared with Case 01.

Table 2: Mean Air Temperature, AT (°C) for five cases. Source: (Author 2022)

Time	Case 01	Case 02	Case 03	Case 04	Case 05
	 No Intervention	 Urban tree+grass	 Green roof	 Green facade	 All vegetated infrastructures
8:00	30.201	29.846	30.194	30.188	29.846
10:00	32.586	32.022	32.555	32.563	31.996
12:00	34.359	33.663	34.334	34.355	33.649
14:00	35.328	34.499	35.305	35.318	34.491
16:00	35.427	34.699	35.403	35.397	34.679
18:00	33.572	33.312	33.562	33.567	33.316
20:00	32.426	32.294	32.421	32.438	32.308
22:00	31.445	31.350	31.442	31.461	31.367
0:00	30.475	30.390	30.473	30.492	30.408
2:00	29.505	29.427	29.498	29.523	29.445
4:00	28.521	28.437	28.518	28.539	28.454
6:00	29.102	29.042	29.099	29.121	29.061

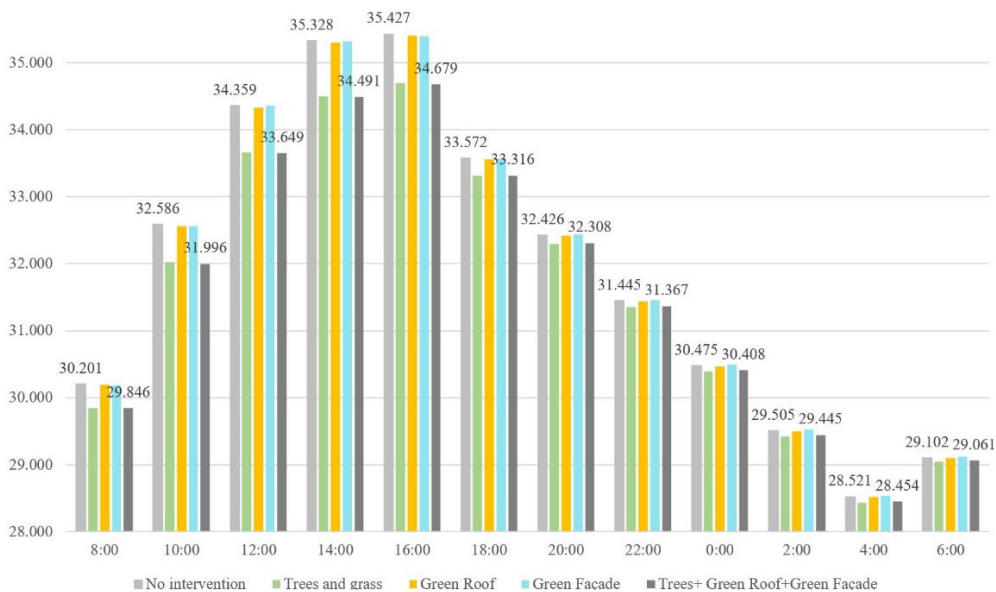

Figure 3: Comparative analysis of impact of different green interventions on mean air temperature at 1.4 m. Source: (Author 2022)

From Table 1, Table 2, and Figure 3, the changing pattern of air temperature (AT) in a day has been identified. In Case 01, without any intervention, mean AT reached up to 35.427°C at 16:00 and goes down up to 28.521°C at 4:00. In Case 02, the maximum mean AT is about 34.699°C at 16:00, which is 0.728°C lower than that of without vegetation (Figure 5). In this case, the minimum mean AT is about 28.437°C at 4:00, which is 0.084°C lower than that of without vegetation (Table 2 and Figure 5). For Case 03 (Green roof), the maximum mean air temperature is about 35.403°C at 16:00, which is 0.024°C lower than that of without vegetation (Table 2). Therefore, the maximum AT is slightly reduced due to the presence of green roof. Again, for this case, minimum mean AT is about 28.51815°C at 4:00, which is 0.00255°C

lower than that of without vegetation. In Case 04 (Green facade), the maximum mean air temperature is about 35.3974°C at 16:00, which is 0.0296°C lower than that of without vegetation. Therefore, the maximum air temperature is slightly reduced due to the presence of green façade during daytime. The minimum mean air temperature is about 28.5389°C at 4:00, which is 0.0179°C higher than that of without vegetation. Surprisingly, green facade increases mean air temperature during nighttime (20:00-6:00) and not able to contribute to night-time cooling of the city. The maximum mean AT in case 05 is 34.679°C at 16:00, which is about 0.748°C lower than that no of vegetation. In this case, the minimum mean air temperature is about 28.454°C at 4:00, which is 0.067°C lower than that of without vegetation.

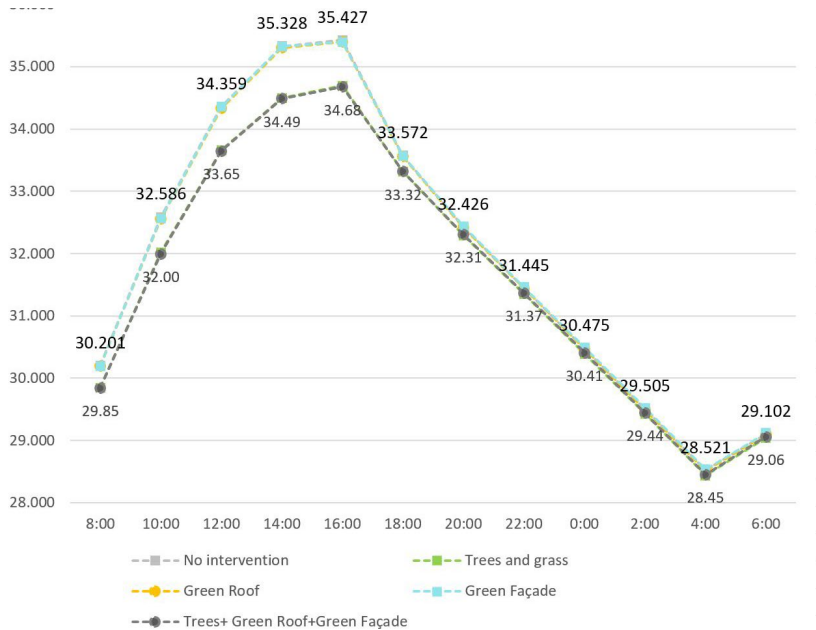

Figure 4: Impact on mean air temperature for four types of green interventions. Source: (Author 2022)

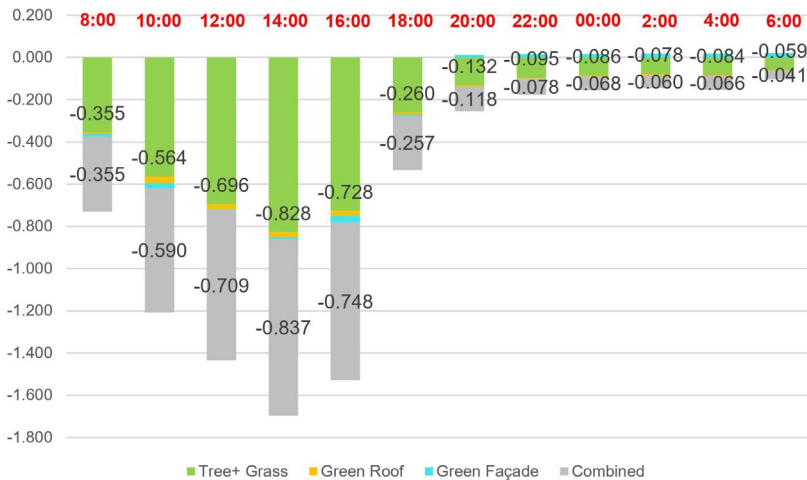

Figure 5: Capacity of Mean air temperature (°C) reduction at a single time. Source: (Author 2022)

From Table 2, Figure 3, and Figure 4, it can be stated that, in all cases, mean AT is highest in the case of without intervention (Case 01). Interestingly, almost in all cases (except for green façade from 20:00-6:00), the mean air temperature is decreasing for the addition of vegetated infrastructures. The combined green interventions (Case 05) can reduce the highest amount of air temperature (0.748°C) during the most critical time (16:00) of the day. Therefore, this study shows having all green infrastructures together will be an excellent way to mitigate the UHI effect in Dhaka. Several design guidelines can be generated to introduce vegetated infrastructures at all levels in tropical cities. Comparing the effects of Case 02, Case 03, and Case 04, during the most critical time (16:00) of the day, maximum AT (0.728°C) is reduced by the presence of urban trees and grass at ground level (Case 02). Trees and grass also show the most effective results in reducing outdoor mean air temperature during 24 hours of a day, whereas the Green roof (Case 03) and Green facade (Case 04) were less effective than trees.

Table 3, Figure 5, and Figure 6 show that the combination of all green infrastructures shows the highest UHI mitigation during 14:00, which is 2.37% reduction of the initial mean AT. Again, urban trees can reduce 1.18%- 2.35% of the initial mean AT during 8:00 to 16:00. Therefore, trees are highly effective in mitigating UHI effects during daytime. Green roof can reduce from 0.01-0.09% of the initial AT. By Green façade, the mean AT is reduced from 0.01-0.08% during 8:00-18:00 and increased from 0.04-0.07% during 20:00-6:00

Table 3: Reduction of Mean Air Temperature for four types of green interventions. Source: (Author 2022)

Time	Case 02		Case 03		Case 04		Case 05	
	Urban Tree+ grass		Green roof		Green facade		Combined vegetated infrastructures	
	AT reduction (°C)	% of the initial AT (%)	AT reduction (°C)	% of the initial AT (%)	AT reduction (°C)	% of the initial AT (%)	AT reduction (°C)	% of the initial AT (%)
8:00	0.35	1.18%	0.01	0.02%	0.01	0.04%	0.36	1.18%
10:00	0.56	1.73%	0.03	0.09%	0.02	0.07%	0.59	1.81%
12:00	0.70	2.03%	0.02	0.07%	0.00	0.01%	0.71	2.06%
14:00	0.83	2.35%	0.02	0.06%	0.01	0.03%	0.84	2.37%
16:00	0.73	2.05%	0.02	0.07%	0.03	0.08%	0.75	2.11%
18:00	0.26	0.78%	0.01	0.03%	0.01	0.02%	0.26	0.76%
20:00	0.13	0.41%	0.00	0.01%	-0.01	-0.04%	0.12	0.36%
22:00	0.10	0.30%	0.00	0.01%	-0.02	-0.05%	0.08	0.25%
0:00	0.09	0.28%	0.00	0.01%	-0.02	-0.06%	0.07	0.22%
2:00	0.08	0.26%	0.01	0.02%	-0.02	-0.06%	0.06	0.20%
4:00	0.08	0.30%	0.00	0.01%	-0.02	-0.06%	0.07	0.23%
6:00	0.06	0.20%	0.00	0.01%	-0.02	-0.07%	0.04	0.14%

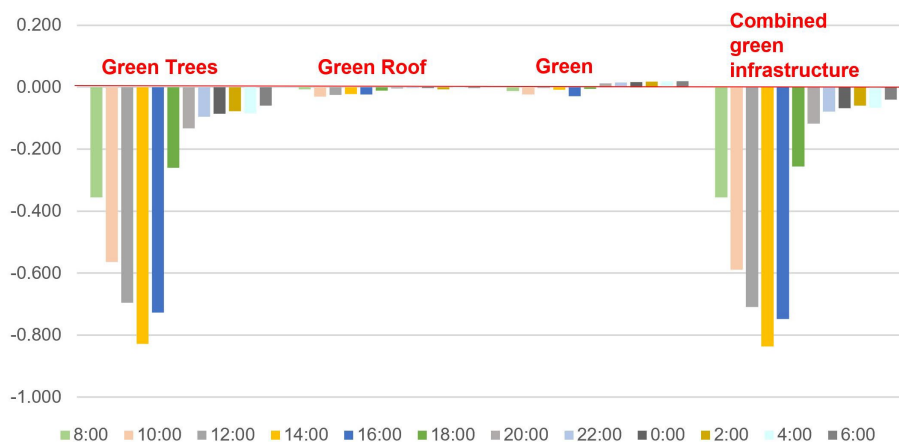

Figure 6: Mean AT reduction by different green interventions at different times of the day. Source: (Author 2022)

Therefore, it can be recommended to plan interventions at the street level of the city by planting trees and ground cover on the road islands, walkways, and open spaces of the residential plots, which have been identified as the most effective UHI mitigation strategy for Purbachal, Dhaka, during daytime in the most critical month of the year. Green trees and grass are highly beneficial to mitigate the UHI effects for the tropical climate. Without any huge amount of infrastructural, load calculation and maintenance cost, urban trees can reduce the air temperature up to 0.828°C during 14:00. Trees show the highest potential during the daytime, as they can create shadows and minimize the amount of received solar radiation on roads and surfaces during that time. As daytime heat management is the highest concern of a tropical city, urban trees and grass can be introduced as the most effective tool to mitigate the UHI effects.

CONCLUSION

Urban microclimate can be controlled through a careful arrangement of green parks, vegetations, waterbodies and urban blocks with mutual shading. Dhaka is one of the fastest growing mega cities in the world, oversaturated by population and resulting in large scale developments to accommodate the huge influx of migrants. Very little research has been conducted in this field on Dhaka since this is still a quite new concept among the local urban planners and climatologists. Ahmed (2003) has worked on approaches to bioclimatic urban design with special reference to Dhaka where he studied influence of greenery on urban microclimate in this context and revealed that trees are quite effective for creating cooling effect through shading, particularly east-west elongated canyons. Planting of vegetation in urban

areas is one of the main strategies to mitigate the UHI effect since vegetation plays a significant role in regulating urban climate. Plants can create an 'oasis effect' and mitigate the urban warming at both macro and micro-level through evapo-transpiration (Wong 2004). It is highly recommended to increase the percentage of the green spaces and vegetated surfaces to mitigate the UHI effects of Dhaka. From this research, it can be recommended to plant trees at road level in Dhaka City to mitigate the UHI effects as it is one of the most effective ways to lower the maximum air temperature, which is also applicable to other countries with similar climates and conditions. Similarly, green roof and green façade can be installed to reduce the UHI effects to some extent. There are some limitations of this study, such as, the three green interventions may not have the same volume or percentage of vegetation increase. Again, only one environmental parameter, air temperature, is considered here, whereas similar analysis can be done with other parameters like, relative humidity, mean air temperature, air speed and direction to have a more comprehensive understanding. In conclusion, this paper indicates that there is urgent need for the city authority to implement measures to monitor and mitigate the UHI effects in Dhaka city by implementing different types of vegetated infrastructures. As a next step of this research, multiple approaches, and data such as, the use of GIS and Remote Sensing techniques, ground-based temperature measurements and geostatistical analysis, can be incorporated for further studies.

ACKNOWLEDGEMENTS

This research is supported by the Department of Architecture, Pennsylvania State University. Software and equipment for this study is provided by Ecology + Design (E+D) and Hamer Center for Community Design.

REFERENCES

- Ahmed, K. S. 2003. *Comfort in urban spaces: Defining the boundaries of outdoor thermal comfort for the tropical urban environments*. Energy and Buildings, 35(1), 103–110.
- Bangladesh Meteorological Department, Climate Division, Agargoan, Dhaka, 2011
- Bangladesh Meteorological Department, Climate Division, Agargoan, Dhaka, 2012.
- BMD, 2022. *Bangladesh Weather Data*. Bangladesh Meteorological Department, 2022. Asian Disaster Preparedness Center (ADPC), Thailand with the support from the Ministry of Foreign Affairs of Norway. <http://bmd.wospace.org/team/homex.php>
- Buis, A. 2019. *A Degree of Concern: Why Global Temperatures Matter. Climate Change: Vital Signs of the Planet*. <https://climate.nasa.gov/news/2865/a-degree-of-concern-why-global-temperatures-matter>, accessed on 20 April 2022.
- Cameron R.W.F. E., Taylor J. R., Emmett M. 2014. *What's 'cool' in the world of green façades? How plant choice influences the cooling properties of green walls*. Build. Environ. 73 (2014) 198–207.
- Chowdhury, M.H. K. and Debsharma, S.K. 1992. Climate change in Bangladesh – A statistical review, Report on IOC-UNEP Workshop on Impacts of Sea Level Rise due to Global Warming, NOAMI, 16-19 November 1992, Bangladesh.
- Dhaka Power Distribution Company Limited. 2015. Annual Report 2015. Retrieved from https://dpdc.org.bd/assets/ar/anl_rpt14_15.pdf.pdf.
- Erell, E. 2008. *The application of urban climate research in the design of cities*. Advances in Building Energy Research, 2(1), 95–121. <http://doi.org/10.3763/aber.2008.0204>
- Gaitani, N., G. Mihalakakou, and M. Santamouris. 2007. *On the Use of Bioclimatic Architecture Principles in Order to Improve Thermal Comfort Conditions in Outdoor Spaces*. Building and Environment, 42 (1): 317–24.
- Gatto, E., Buccolieri, R., Aarrevaara, E., Ippolito, F., Emmanuel, R., Perronace, L., & Santiago, J. L. 2020. *Impact of Urban Vegetation on Outdoor Thermal Comfort: Comparison between a Mediterranean City (Lecce, Italy) and a Northern European City (Lahti, Finland)*. Forests, 11(2), 228. <https://doi.org/10.3390/f11020228>
- Givoni, B. 1998. *Climate considerations in building and urban design*. New York, NY: Van Nostrand Reinhold.
- Hossain, M.E., and Nooruddin, M. 1993. *Global Solar Radiation on Horizontal Surface in Dhaka*. International Technical Conference on Tropical Urban Climates, Dhaka.
- Islam, S. T. 2002. *Greening and Fading the Dhaka City: Past, Present and Future Perspectives*, Unpublished Project Report. Dhaka: The Asiatic Society of Bangladesh.
- Jusuf, S. K., Wong, N. H. & Chong, Z. M. A. 2015. *The impact of increasing urban air temperatures on urban planning and building energy consumption in tropical climates*. In S. Lehmann (Ed.), *Low carbon cities: Transforming urban systems* (pp. 308–330). New York, NY: Routledge.
- Langer, I., Sahar, S., & Cubasch, U. 2012. *Using the ENVI-MET program to simulate the micro climate in new Town HASHTGERD*. <https://doi.org/10.13140/2.1.1739.2005>
- Mallick, F. H. 1994. *Thermal Comfort for Urban Housing in Bangladesh*, PhD Thesis (Unpublished), EESP, Architecture Association, London, 1994.
- Memon, R. A. & Leung, D. Y. 2010. *Impacts of environmental factors on urban heating*. Journal of Environmental Sciences, 22(12), 1903–09.
- Mia, N.M. 2003. *Variations of temperature of Bangladesh*. In Proceedings of SAARC Seminars on Climate Variability in the South Asian Region and its Impacts, SMRC, Dhaka, Bangladesh.
- Mridha, A. M. M. H. 2002. *A study of thermal performance of operable roof insulation, with special reference to Dhaka*, Master's thesis (unpublished), Bangladesh University of Engineering and Technology, Dhaka, Bangladesh.
- NRPA. 2000. *National Recreation and Park Association* (NRPA), <https://www.nrpa.org/>, accessed on 10 November 2021.
- Nikolopoulou, Marialena, Nick Baker, and Koen Steemers. 2001. *Thermal Comfort in Outdoor Urban Spaces: Understanding the Human Parameter*. Solar Energy, 70 (3): 227–35. [https://doi.org/10.1016/S0038-092X\(00\)00093-1](https://doi.org/10.1016/S0038-092X(00)00093-1).
- Nikolopoulou, Marialena, and Koen Steemers. 2003. *Thermal Comfort and Psychological Adaptation as a Guide for Designing Urban Spaces*. Energy and Buildings, Special issue on urban research, 35 (1): 95–101. [https://doi.org/10.1016/S0378-7788\(02\)00084-1](https://doi.org/10.1016/S0378-7788(02)00084-1).
- Sharmin, T., Kabir, S. and Rahaman, M. M. 2012. *A study of thermal comfort in outdoor urban spaces in respect to increasing building height in Dhaka*. AIUB Journal of Science and Engineering 11 (1). <https://dora.dmu.ac.uk/handle/2086/16630>
- Siddique, A. B. 2014. *Rooppur plant lacks proper assessment*. Dhaka Tribune. Retrieved from <http://archive.dhakatribune.com/environment/2014/feb/16/environmentalists-rooppur-plant-lacks-proper-assessment>. Accessed on 12 August 2010.

World Bank. 2000. Bangladesh: *Climate Change and Sustainable Development*. Report No. 21104-BD", Rura Development Unit, South Asia Region, The World Bank (WB), Dhaka, pp. 95.

Wong N. H., 2004. *Study of urban heat island in Singapore*. Research report, National University of Singapore.

Logic Models as Conceptual Frameworks for Design

Schaeffer Somers¹, Christine J. Le¹

¹University of Virginia, Charlottesville, VA

ABSTRACT: The disciplines that shape the built environment, architecture, landscape architecture, and urban planning share a goal of imagining and producing healthy places to live, work, and age. However, these disciplines are taught and practiced without a shared framework to determine and assess long-term health outcomes. To reap the health benefits of environmental design, practitioners and educators need tools to understand the complexity of relationships between health and the built environment and methods for considering evidence in design decisions. One tool that has potential to address this need is the practice of Health Impact Assessment (HIA), which applies evidence and collaborative research methods to evaluate and improve the health outcomes of projects, programs, and policies. The use and scholarship of HIA has been limited to the disciplines of public health and urban planning, however, it can be readily adapted by other fields including architecture. HIA is a systematic methodology for assembling evidence based on primary and secondary research to help stakeholders formulate recommendations to mitigate negative health impacts and enhance positive ones. The practice of HIA uses a tool borrowed from program planning and evaluation called a logic model, which is a diagram of causal relationships leading to health outcomes. The logic model is typically relegated to establish the scope of the HIA; however, it has the potential to play a more generative role in the design process, bridging the gap between basic research and design. This paper proposes adapting the logic model as a tool for translating research into programming, design, evaluation, and monitoring health outcomes of projects in architecture. Case study analysis and work from an interdisciplinary course in public health and architecture demonstrates the potential of using logic models to conceptualize projects from the earliest stage of development to support integrative and collaborative research methods in design.

KEYWORDS: Logic Model, Health Impact, Conceptual Framework

INTRODUCTION

Health-related scientific research has long been a source of inspiration for architects and has informed the design of projects that aspire to promote human health. Florence Nightingale was an early pioneer in translating empirical evidence into conceptual models for the design of spaces that prevent disease and heal patients. Nightingale's treatise, *Notes on Nursing*, called for exposing patients to natural light, fresh air, exterior views, and sanitary materials and the impact of these principles can be seen in the polemics and work of many modern architects in the 20th century. The definition of health has evolved from the absence of disease to include an understanding of environmental and social determinants of health. The recognition of an epidemic of obesity in the U.S. in the latter half of the 20th century helped renew interest in interdisciplinary research among scholars in public health and urban planning. The resultant narrative that community design is producing obesogenic environments that shape sedentary health behaviors has produced a range of responses to promote active living. Another research theme links health disparities and life expectancy to where people live, which reflects the role of the social determinants of health (McGovern et al 2014). The redlining of neighborhoods is a clear example this dynamic which contributes to systemic racism and health disparities that differentially impact communities of color in the U.S. A survey of critical issues at the intersection of health and the built environment includes obesity and related noncommunicable diseases, housing, social inequities, aging populations, urbanization, hazardous chemical exposure, energy poverty, water shortages and excesses, natural disasters, climate change, stress, and infectious diseases (Dannenberg et al 2018). The problems faced by society and by the design professions demand new ways of working that are grounded in science, data, and community knowledge.

1.0 EVIDENCE-BASED PRACTICES

1.1 Evidence-Based Design

Evidence-based practice includes the review, analysis, and application of the best available scientific data to inform practice, which began in the field of medicine. The National Institutes of Health (NIH) promotes the training of basic, clinical, and population scientists in translational research programs to facilitate the flow of information from the lab bench to patient bedside to the community. The challenge of bringing scientific research into the practice and education of architecture is similar to medical practice in that it requires bridging a divide between a traditional practice of architecture that relies on formal education, standards of practice, and general professional knowledge, and an emerging mandate to integrate scientific research from diverse and related fields of study. The study by Roger Ulrich,

“View through a window may influence surgery recovery,” has proven to be a catalyst in the evidence-based design movement because it produced evidence of measurable health benefits based on environmental exposure that could be used as evidence for a set of design decisions. The study found that patients with views of trees (Figure 1) had improved health outcomes including faster recovery time and reduced pain medication compared to the patients who had views of a brick wall of the hospital (Ulrich 1984). Although the evidence-based design approach is typically referenced and taught in the subfield of healthcare architecture, it has broader applications to all design disciplines.

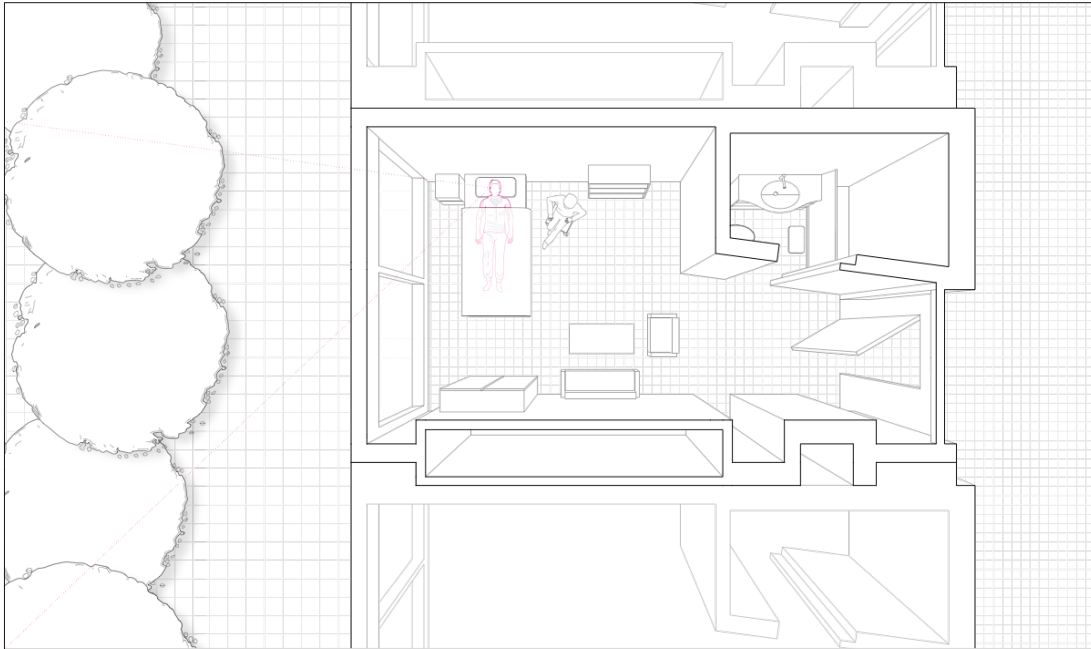

Figure 1: Visualization of the Ulrich study, “View through a window may influence surgery recovery.” Source: Somers and Karen Chen, 2019

Healthcare architecture is not alone in seeking basic and applied research in education and practice inspired by the clinical model of evidence-based practice. In the field of urban planning, there has been a growing role for research-generated evidence to inform decision making to reinforce the conventional practice and education of the profession (Krizel et al 2009). The need to consider community health concerns systematically and rigorously in urban planning processes has led to a search for evidence-based methods and tools borrowed from health. One tool that has gained traction in the field of urban planning is Health Impact Assessment or HIA, which has been deployed in a range of permutations from the participatory to the more technical (Slotterback et al 2011).

1.2 Health Impact Assessment

HIA seeks to apply the best available evidence to identify and consider the potential health outcomes of decisions that inform policymaking and proposed plans, programs, and projects. As such it represents an important tool to support an evidence-based practice of design and planning the built environment. The National Research Council of the National Academies defines HIA as:

“a systematic process that uses an array of data sources and analytic methods and considers input from stakeholders to determine the potential effects of a proposed policy, plan, program, or project on the health of a population and the distribution of the effects within the population. HIA provides recommendations on monitoring and managing those effects” (National Research Council 2011).

HIA considers evidence from community-based, participatory methods as well as secondary research and literature review. Assessments utilize quantitative methods such as geospatial analysis of health indicators and qualitative research methods including community-based participatory research.

HIA has been used extensively in Australia, New Zealand, Europe and to a more limited extent in the U.S. HIA is promoted by the Centers for Disease Control (CDC), Robert Wood Johnson Foundation (RWJF), and the Pew Charitable Trusts. As practiced in the U.S., HIA is a voluntary process applied by local and state level stakeholders to fill the gap in the regulatory implementation of Environmental Impact Assessment, which in practice does not consider the full range human health issues with particular emphasis on the social determinants of health. In the context of the built environment, HIA has been successfully applied to neighborhood zoning changes, transit-oriented development, and affordable housing as a few examples of projects.

The types of HIA range from a Desktop and Rapid forms of HIA, which focus on existing research and requires the least amount of resources and capacity, to Intermediate and Comprehensive HIAs, which require a higher level of time investment, access to subject area expertise, and community engagement (Harris 2007). The HIA for rehabilitating Native American housing referenced in Figure 2 is an example of a comprehensive type HIA funded by the Health Impact Project, a joint initiative of the RWJF and Pew Charitable Trusts. The HIA assessed the health impact of the community development work of an Enterprise Rose Architectural Fellow working with a Native American tribe in New Mexico. The practice standards for HIA require that the scoping phase of the project include “a systematic consideration of potential pathways that could reasonably link the decision and/or proposed activity to health, whether direct, indirect, or cumulative” (Bhatia R et al. 2014). The process of considering these “health pathways” is through an adaptation of an analytical tool called a logic model, which is used in the field of program planning and evaluation.

1.3 Logic Models

A logic model is a visual representation of a “theory of change” of how a given input will perform over time to produce distal outcomes. The logic model defines the input of the planned work necessary to implement a program, policy, or project. The input of planned work can be defined as the required resources and activities to produce the intended outcomes to be evaluated (WKKF 2004). There are many ways of framing and representing evaluation information, but the form that has the most utility for designers is a tree diagram that traces the causal connections as links between inputs and outputs. Beginning with the initial input, successive outputs in the form immediate, intermediate, and distal health outcomes can be delineated and organized as a network of cause-and-effect relationships. An input leads to more than one output typically and each output becomes a potential input for another logical relationship in the diagram.

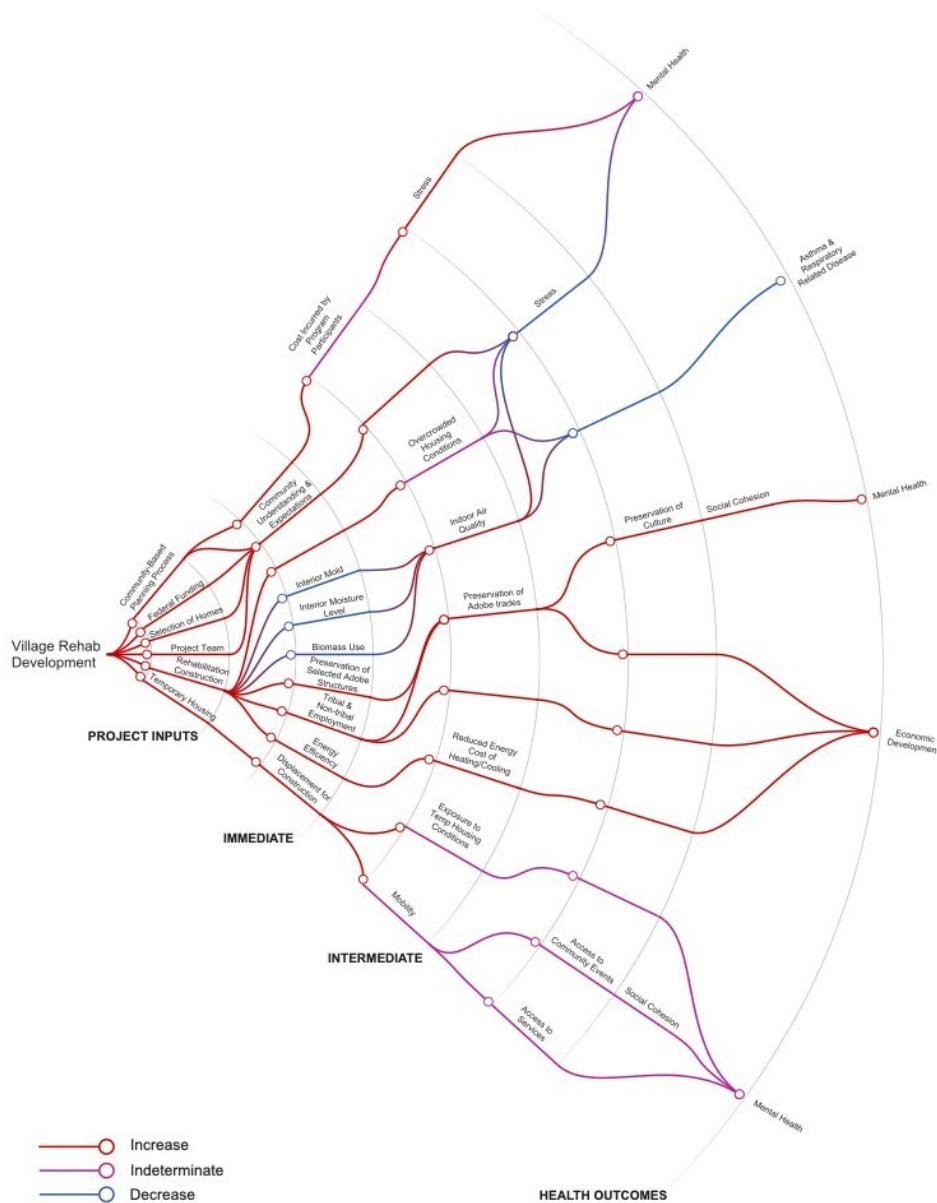

Figure 2: Logic model of a Native American housing rehabilitation project. Source: (Somers 2020)

The logic model as a diagram has directionality radiating outward from the initial input that represents the arrow of time. A second form of directionality occurs in identifying and representing the relative or quantitative changes in the parameters or measures of the change. Translating this to health, the measures can be thought of as health indicators and the relational outputs as health outcomes. In the context of HIA practice the distal health outcomes measure changes population level health, so it is typical to see references to morbidity and mortality as outcomes depending on the social-ecological context of the project. In the context of HIA, the input of the logic model is not typically unpacked into resources and activities but reflects the decision points being assessed. The terms, “health pathway diagram” and “causal models,” are used to describe this adaptation in HIA practice guides and reinforce the concept of causal pathways leading to future health outcomes (Bhatia and Human Impact Partners 2011).

2.0 APPLICATIONS OF LOGIC MODELS IN DESIGN

2.1 A Tool for Transdisciplinary and Systems Thinking

The process of starting a logic model is similar to mind mapping in that it begins with a sketch based on the disciplinary knowledge of the practitioners who are engaged in the process. Because a single input can lead to multiple causal outputs, the logic model can easily lead to a wide range of health outcomes such as chronic disease, mental health, changes in culture, and economic impacts as demonstrated in the diagram in Figure 2. Linking two components with an arrow implies that there is evidence for a causal relationship. The complexity and range of the model can quickly transcend the expertise of the practitioner and transgress multiple boundaries of scientific or professional knowledge. These limits can be overcome by engaging team members representing different fields to transcend their respective disciplinary perspectives, which is a key characteristic of transdisciplinary thinking.¹ “To achieve the level of conceptual and practical progress needed to improve human health, collaborative research must transcend individual disciplinary perspectives and develop a new process of collaboration” (Rosenfeld 1991, 1344). Similarly, systems thinking is concerned with synthesizing new knowledge, building networks and relationships across traditional boundaries of disciplines and fields, and developing models and projections using a range of analytic approaches to improve strategic planning (Leischow 2008). A key aspect of this approach is that researchers work together to synthesize a shared conceptual framework that integrates discipline-specific theories, paradigms, and methodologies. The logic model can serve as this conceptual model in evidence-based practices including architecture and allied disciplines seeking to solve complex problems that require transdisciplinary collaboration and systems thinking.

3.0 APPLICATIONS OF LOGIC MODELS IN EVIDENCE-BASED DESIGN

3.1 Case Study Analysis

HIA is concerned with the impact evaluation of decisions to be made in the future, however, the impact of completed programs and events can be useful in case study analysis of precedents for design and planning. Sections 3.1 and 3.2 present the work of a university course that explores health and the built environment. The course is taught through a combination of lectures and project-based learning and draws both undergraduate and graduate students from science, public health, architecture, urban planning, and interdisciplinary degree programs. Students chose a precedent project to analyze using concept mapping of project elements, ecological systems theory², and logic models. One example is a graduate level project analyzing the planning, policy, design, and health outcomes of the Wendell O. Pruitt Homes and William Igoe Apartments, known together as the Pruitt-Igoe housing project, in St. Louis, Missouri. The research focused on the intersections of the built environment, public health, and social science and particularly how instability, violence, and disinvestment impacted the health outcomes of the housing tenants. The causal pathways of restrictive family policies, disinvestment and degradation of the housing environments, and perceptions and stigma of violence inform a complex understanding that is represented in the form of a series of logic models, one of which is presented in Figure 3.

One of the objectives of the course is for students to learn to develop, iterate, and prioritize research questions and conduct a literature search and review to generate findings. The logic model is instrumental in the process since each causal link is subject to a query to identify the evidence that supports the relationship. Literature review plays an essential role in addressing both knowledge gaps and finding evidence to support knowledge of the researchers and uncover new insights and perspectives. The primary source of scholarly literature in biomedical research is PubMed, which is a public resource developed and maintained by the National Center for Biotechnology Information (NCBI), at the U.S. National Library of Medicine (NLM), located at the National Institutes of Health (NIH). Literature in PubMed is organized in a controlled vocabulary of MeSH (Medical Subject Headings) terms, which designers can use to develop a conceptual understanding of biomedical knowledge outside of their discipline. Web of Science is another important research tool that provides access to literature in social sciences and psychology, which are critical to understanding social and cognitive impacts. This type of literature review is best described as an integrative literature review, which is used in “evaluating the strength of the scientific evidence, identifying gaps in current research, identifying the need for future research, bridging between related areas of work, identifying central issues in an area, generating a research question, identifying a theoretical or conceptual framework, and exploring which research methods have been used successfully” (Russell 2005). Since research studies are typically based on a narrowly defined population, a key learning objective is assessing whether the findings can be generalized to the project’s population. Students produce an annotated bibliography in addition to diagrams that constitutes the evidence base for group project work.

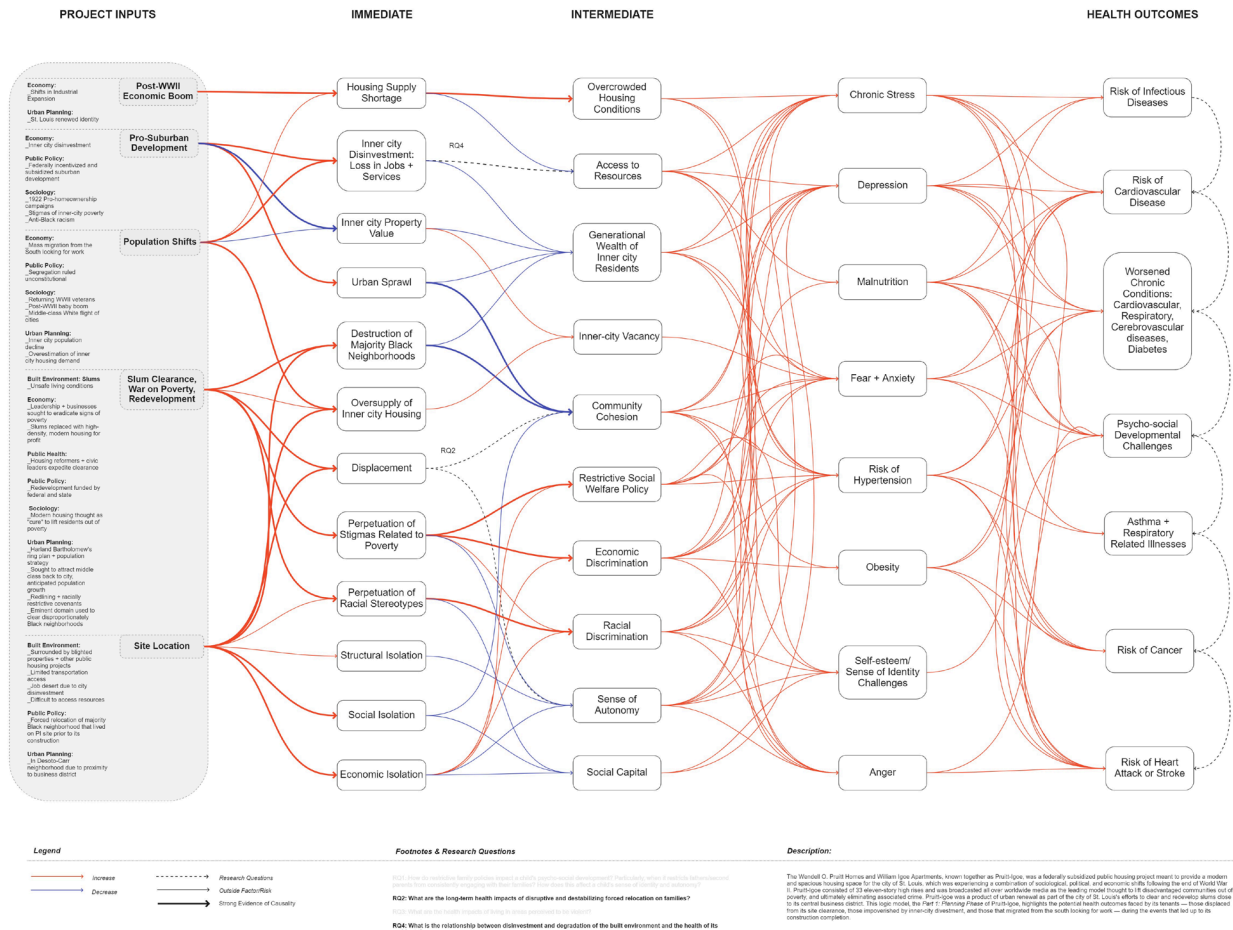

Figure 3: Logic model of the Pruitt-Igoe Housing Project, Part 1: Planning/Pre-Construction. Source: Christine Le, 2022

3.2 Architectural Programming

The prompt for the group project is to propose an intervention in the built environment that leverages the case study research. Students choose from the instructor’s project abstracts or propose their own. The goal of the project is to develop a brief for an open design competition or a speculative request for proposal. The primary means of communicating the goals of the project and how it will perform is through a logic model identified as a “design logic model” to reflect its generative role in design. The group completing the Pruitt-Igoe case study project developed a comprehensive program for the former site of Charlottesville’s Vinegar Hill community that had been the target of urban renewal and the erasure of an African American commercial district and neighborhood in 1964. One of the major interventions of the program is creating affordable, mixed income housing that prioritizes bringing the displaced residents of Vinegar Hill and their descendants back to their former neighborhood as a form of reparation after being forcibly displaced from their homes into public housing. Components of the program were selected based on community feedback, literature review of healthy housing models, zoning, land use, and housing finance limitations, and local housing supply pressures. Figure 4 represents the design logic model generated in their collaborative research and presentation of their project. The downstream column of distal outputs represents the predicted health outcomes of the project’s programmatic inputs. However, they could also be framed as the goals of the new project and the logic model provides the systems thinking and supporting evidence.

The typical color coding of the causal links in the practice of the course is red represents increasing directionality of a parameter and blue represents decreasing. Purple represents the mixing of the two colors which signals that the direction of the impact is indeterminate. Another convention developed in the context of teaching this approach is to use line weights to represent the relative strength or quantity of evidence in the connection. A thick line type represents higher levels of evidence, a thin line represents lower levels, and a dashed line is used to identify speculation and gaps in knowledge that should be addressed with additional research. The density of lines becomes a graphic challenge for the diagrams, which are hand drawn using online diagramming tools. Figure 3 represents a radial tree diagram produced with a parametric script. Cluster dendograms and other form of compact information visualization can be used to deal with even more complex logic models and large projects (Bostock 2017). Another strategy used in the course is to isolate discrete sections of the diagram, which are identified as “health pathways” invoking the HIA terminology.

3.3 Project Evaluation & Accreditation

Each immediate, intermediate, and distal input/output component of a logic model are measurable parameters, which suggests the potential of the logic model approach to generate a set of measures that can be used in existing evaluation methods of sustainable and green building design. The US Green Building Council (USGBC) rating system, Leadership in Energy and Environmental Design™ (LEED) promotes criteria to achieve a set of evolving outcomes related to building performance. The credit for Integrative Process in the LEED Building Design & Construction system incentivizes comprehensive approaches to the design of building systems to find synergies that can achieve higher levels of building performance, human comfort, and environmental benefits. USGBC references the American National Standards Institute (ANSI) Consensus National Standard Guide-Design and Construction of Sustainable Buildings and Communities, which identifies requirements for the design and construction industries to engage in a process of identifying interrelationships and synergies between systems and components including technical and living systems to achieve high levels of building performance, human performance, and environmental benefits (USGBC 2023).

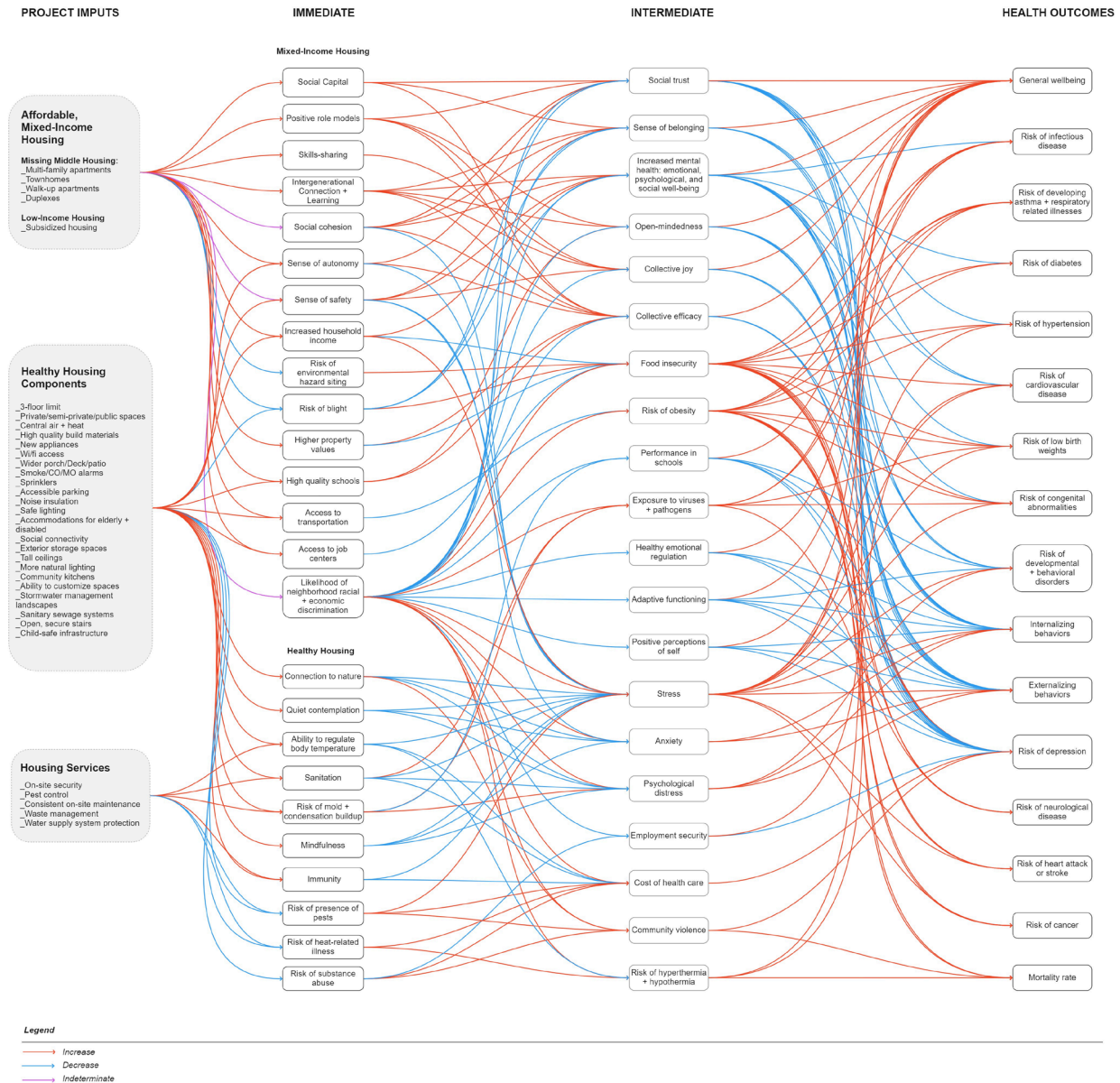

Figure 4: Design logic model for the proposed affordable, mixed-income housing program of Vinegar Hill. Source: Christine Le, 2022

The Delos company has created an alternative accreditation system called the WELL Building Standard™ (WELL), which seeks to certify environments through a similar rating system as LEED organized around seven categories of health (IWBI 2019). One goal of accreditation is to integrate Evidence-Based Design into the standards to obviate the need for open-ended research methods and make health-based outcomes more accessible to project teams that lack experience in public health and scientific research. However, the logic modeling approach adds value to the planning

and evaluation of projects that use performative measures to evaluate health outcomes. Undertaken as a collaborative process, the modeling approach can assist designers in translating knowledge and concepts between related fields in an integrative design project.

A partnership of the RWJF and USGBC resulted in a new pilot credit for Integrative Process for Health Promotion to support “high performance, cost-effective and health-promoting outcomes through an early analysis of the interrelationships among building systems” and to “facilitate a systematic consideration of the impact that project design and construction have on health and wellbeing including physical, mental, and social impacts” (USGBC 2023). This credit incentivizes collaborative processes modeled on HIA without having to meet the practice standards of HIA. The logic model could be an important tool in developing and demonstrating that a systematic analysis has been performed.

CONCLUSION

As the evidence grows that the built environment has direct and indirect effects on the health and well-being of human populations, so too does the awareness that architects must address health holistically and comprehensively in the design of the built environment at all scales. Scientific research will play a critical role in the development of integrative designs, which changes the expectations of how architects think, communicate, and collaborate with other disciplines. Evidence-based practices of design seek out the best available scientific data and expertise to inform ideation and decision making in design. The logic model is an existing tool of impact evaluation and monitoring of public health programs that can serve the aims of evidence-based design research and practice. The process of synthesizing, testing, and iterating a logic model encourages systems thinking and collaboration that transcends disciplinary silos. Conceptual models like a logic model are never perfect representations of reality because scientific knowledge is always changing, however, it provides a visual medium for mapping hidden and complex relationships. It contributes to a long history of diagramming as a working method of architectural conceptualization. The work presented here demonstrates the utility of logic models to enhance case study analysis of completed work and architectural programming of new projects. The origin of the tool in program planning evaluation is directly transferrable to established methods of post occupancy evaluation, building commissioning, and green building accreditation through standards like USGBC LEED and WELL Building. By extending the scope of evaluation to population level health outcomes, the logic model approach can help build the case for the investment in program elements that are causally linked to health outcomes that have long term health and economic benefits. At a minimum, however, logic modeling the process can reveal the potential unintended consequences of design decisions and highlight opportunities to mitigate negative health impacts and enhance positive impacts before final decisions are made, which aligns with the practice of HIA. Architects engaged in integrative or evidence-based design practices need tools and resources to help develop transdisciplinary solutions to the array of existential problems that face our species, and the logic model is ideally positioned to play a supporting role.

REFERENCES

- Bhatia, R. 2011. *Health Impact Assessment: A Guide for Practice*. Oakland: Human Impact Partners. <https://humanimpact.org/wp-content/uploads/2011/01/HIA-Guide-for-Practice.pdf>
- Bhatia, R., Farhang, L., Heller, J., Lee, M., Orenstein, M., Richardson, M., and Wernham, A. 2014. “Standards for the Scoping Step,” in *Minimum Elements and Practice Standards for Health Impact Assessment, Version 3*. The North American HIA Practice Standards Working Group. <https://humanimpact.org/wp-content/uploads/2014/09/HIA-Practice-Standards-September-2014.pdf>
- Bostock, M. 2017. “Radial Tidy Tree.” Observable. <https://observablehq.com/@d3/radial-tidy-tree>.
- Centers for Disease Control and Prevention. 2022. “The Social-Ecological Model: A Framework for Prevention.” *Centers for Disease Control and Prevention*. <https://www.cdc.gov/violenceprevention/about/social-ecologicalmodel.html>.
- Dannenberg, A. L., and H. Burpee. 2018. “Architecture for Health Is Not Just for Healthcare Architects.” *HERD: Health Environments Research & Design Journal* 11, no. 2: 8–12. <https://doi.org/10.1177/1937586718772955>.
- Harris, P., B. Harris-Roxas, E. Harris, and L. Kemp. 2007. *Health Impact Assessment: A Practical Guide*. Sydney: Centre for Health Equity Training, Research and Evaluation (CHETRE). Sydney: University of New South Wales Research Centre for Primary Health Care and Equity.
- Human Impact Partners. 2011. *A Health Impact Assessment Toolkit: A Handbook to Conducting HIA, 3rd Edition*. Oakland: Human Impact Partners.
- International WELL Building Institute. n.d. “Features.” *WELL Standard*. <https://standard.wellcertified.com/features>.
- Krizel, K., A. Forsyth, and C. Slotterback. 2009. “Is There a Role for Evidence-Based Practice in Urban Planning and Policy?” *Planning Theory & Practice* 10, no. 4: 459–478. <https://doi.org/10.1080/14649350903417241>.
- Leischow, S. J., A. Best, W. M. Trochim, P. I. Clark, R. S. Gallagher, S. E. Marcus, and E. Matthews. 2008. “Systems Thinking to Improve the Public’s Health.” *American Journal of Preventive Medicine* 35, 2 Suppl.: 196. <https://doi.org/10.1016/j.amepre.2008.05.014>.
- McGovern, L., Miller, G., and Jughes-Cromwick, P. 2014. “Health Policy Brief: The Relative Contribution of Multiple Determinants to Health Outcomes,” *Health Affairs*. <https://doi.org/10.1377/hpb20140821.404487>.
- National Research Council. 2011. *Improving Health in the United States: The Role of Health Impact Assessment*. Washington, DC: The National Academies Press. <https://doi.org/10.17226/13229>.
- Nightingale, F. 1982. *Notes on Nursing; and, Notes on Hospitals*. Birmingham: Classics of Medicine Library.

- Rosenfield, P. 1992. "The potential of transdisciplinary research for sustaining and extending linkages between the health and social sciences." *Social Science & Medicine* 35, no. 11: 1343-1357. [https://doi.org/10.1016/0277-9536\(92\)90038-R](https://doi.org/10.1016/0277-9536(92)90038-R).
- Russell, C.L. 2005. "An overview of the integrative research review." *Progress in Transplantation* 15, no. 1, 8-13. <https://doi.org/10.1177/152692480501500102>.
- Slotterback, C., Forsyth, A., Krizek, Johnson, K., and Pennucci, A. 2011. "Testing three health impact assessment tools in planning: A process evaluation," *Environmental Impact Assessment Review* 31, 2: 144-153. <https://doi.org/10.1016/j.eiar.2010.01.005>.
- Somers, S. "Design Logics: A Diagrammatic Approach to Research and Representation of Health Pathways in the Built Environment." *108th ACSA Annual Meeting Proceedings, Open*. <https://doi.org/10.35483/ACSA.AM.108.65>
- The Pew Charitable Trusts. n.d. "Health Impact Project." *Robert Wood Johnson Foundation and The Pew Charitable Trusts*. <https://www.pewtrusts.org/en/projects/health-impact-project/>.
- Ulrich, R.S. 1984. "View through a Window May Influence Recovery from Surgery." *Science* 224, no. 4647 (1984): 420–21. <https://doi.org/10.1126/science.6143402>.
- U.S. Green Building Council. n.d. "Integrative Process for Health Promotion." *U.S. Green Building Council*. <https://www.usgbc.org/credits/new-construction-core-and-shell-schools-new-construction-retail-new-construction-healthc-106>.
- W.K. Kellogg Foundation. 2004. "Introduction to Logic Models" in *W.K. Kellogg Foundation Logic Model Development Guide*. <https://wkkf.issuelab.org/resource/logic-model-development-guide.html>
- World Health Organization. n.d. "Health Impact Assessment (HIA) Tools and Methods." *World Health Organization*. <https://www-who-int.proxy1.library.virginia.edu/tools/health-impact-assessments>.

ENDNOTE

¹ Transdisciplinary research in medicine is the "process in which team members representing different fields work together over extended periods to develop shared conceptual and methodologic frameworks that not only integrate but also transcend their respective disciplinary perspectives" (Rosenfield 1992).

² The course situates the social-ecological model of public health and prevention (CDC 2022) as an adaptation of Bronfenbrenner's ecological systems theory.

Potential Benefits of Vegetative Shading on Architecture Energy Efficiency

Rosa McDonald¹, Wayne Place¹, Traci Rose Rider¹

¹North Carolina State University, Raleigh, NC

ABSTRACT:

Natural light has the positive potential to:

- Bring us joy by providing a sense of connection to the cycles of nature.
- Make building occupants productive by stimulating alertness during working hours.
- Enhance human health by regulating our circadian rhythms.
- Illuminate building interiors, thereby offsetting lighting electricity consumption making buildings more energy-efficient and reducing the generation of greenhouse gasses.

Natural light has the negative potential to admit excessive quantities of beam sunlight, thereby:

- Thermally overloading buildings during the cooling season, increasing cooling electricity consumption and the generation of greenhouse gasses.
- Causing thermal discomfort and glare for the building occupants.

On the east- and west-facing facades of buildings conventional static shading techniques have been ineffective in regulating the negative impacts of sunlight. Vegetation has the potential to shade buildings and filter light in a manner that does not cause glare nor thermally overload the building. It also has the potential to calm and please building occupants. Unfortunately, there are very few rigorous, quantitative studies assessing the potential of vegetative shading, and few qualitative studies assessing the biophilic benefits of using vegetation in this way. The subject is complex and difficult to quantify. The mixed-methods research enterprise described in this paper outlines a set of strategies and methods of assessment in five phases for the exploration of vegetative shading. This paper, summarizing the research in Phase 1, describes the initial experiment of light and thermal-radiation transmittance of common plant species for vegetative shading and initial simulations of vegetative shading impacts on energy consumption in a prototype building. Future papers will address the remaining phases of this integrated research plan, which frames and explores vegetative shading through a visual design toolkit, more in-depth experiments and energy simulations, a survey instrument, and phenomenological interviews.

KEYWORDS: Daylight, Vegetation, Shading, Experiment, Energy Simulation

INTRODUCTION

Existing research suggests that natural light has the positive potential to provide a sense of joy and wellbeing (Stigsdotter, 2004), provide a sense of connection to the cycles of nature, create a sense of happiness and productivity in building occupants by stimulating alertness during working hours (Browning et al., 2014), enhance occupant health by regulating circadian rhythm, and illuminate building interiors, thereby offsetting lighting electricity consumption to make buildings more energy-efficient and reduce the generation of greenhouse gasses.

Contrarily, natural light has the negative potential to admit excessive quantities of beam sunlight, thereby thermally overloading our buildings during the cooling season, increasing cooling electricity consumption and the generation of greenhouse gasses, and causing thermal discomfort and glare for the building occupants.

For many building orientations, especially east- and west-facing facades, conventional shading devices and strategies have been very ineffective in regulating the negative impacts of sunlight on the building. Vegetation has the potential to shade buildings and filter light in a manner that does not cause glare and does not thermally overload the building. It also has substantial potential for calming and pleasing the human occupants of the building (Browning et al., 2014). Unfortunately, there are very few rigorous, quantitative studies assessing the potential of vegetative shading, and few qualitative studies assessing the biophilic benefits of using vegetation in this way. The subject is complex and difficult to quantify. The mixed-methods research enterprise described in this paper outlines a set of strategies and methods of assessment for the exploration of vegetative shading.

The primary focus of Phase 1 was to answer the question “Is vegetation inside the east- and west-facing facades a viable solution for shading?” In order to answer this question, four sub-questions were identified:

1. What types of plants would be best for this application?
2. How much visible light do plant leaves shade?
3. How much solar radiation do plant leaves shade?
4. How much energy can shading with plants save?

To explore these questions Phase 1 consists of initial experiments of light and thermal-radiation transmittance of common plant species for vegetative shading, and initial energy simulations of vegetative shading impacts on heating energy, cooling electricity, and lighting electricity consumption in a prototype building.

1.0 LITERATURE REVIEW

A review of literature illustrates the existing challenges of shading on the east and west facades of buildings, describes what visible light and thermal radiation transmission are, and illustrates the potential for vegetation as shading on the east and west facades to manage daylight and thermal radiation transmission that enters the building.

1.1 Challenges of shading on the east and west

While there is overwhelming evidence and agreement on the effectiveness of conventional static shading techniques on the south-facing facade of buildings, there is limited data on the effectiveness of the shading techniques on east- and west-facing facades because few studies have focused specifically on those orientations. Furthermore, of the sources that address this topic, there is disagreement across those sources on the effectiveness of shading techniques on the east- and west-facing facades, and which techniques are most effective where (Olgay and Olgay, 1957; AIA, 1981; Ching and Adams, 2001; ASHRAE, 2011; Kamal, 2011; Alshamrani and Mujeeb, 2016).

Because in the northern hemisphere the sun rises in the east and sets in the west, the low angle of the sun before midday and after midday can cause visual discomfort for building occupants. Additionally, around the summer solstice the sun is in the sky for longer hours which can cause thermal discomfort because of the increased heat entering the building facade for more time. Specifically on the east and west sides of buildings sunlight can impact visual and thermal comfort for 6-8 hours each summer day. For these reasons effective solar control strategies are needed not only on the south-facing facades of buildings but also on the east- and west-facing facades.

Existing literature notes that dynamic shading techniques are more effective on east- and west-facing facades of buildings, but many projects cannot afford initial and/or maintenance costs for these devices (Aldakheel and Aoul, 2017; Farouk and Elsharkawy, 2020). In response to this financial limitation, authoritative sources recommend either using the less effective conventional static shading techniques or to decrease the amount of glazing on the east and west facades (ASHRAE, 2011). But evidence suggests that people prefer having windows for access to daylight and views to nature, which improves health and well-being (Browning, et. al, 2014; Stigsdotter, 2004; Ulrich, 1984; International WELL Building Institute, 2020), so decreasing glazing amount is also not an ideal solution.

1.2. Visible light and solar radiation transmittance

Visible daylight is electromagnetic radiation from the sun that falls within the narrow range of 400 and 700 nanometers (Bruce et al., 2003). It is within this narrow band of the electromagnetic spectrum that humans are able to see their environments. Total available daylight consists of direct rays of the sun, rays scattered by the atmosphere, and rays reflected off exterior or interior surfaces (Hammer, 1992) (Figure 1). All light rays contributing to the total can impact the illumination of interior spaces. Literature suggests that in most situations using more daylight to illuminate building interiors allows for less electric lighting to be used, thus daylighting can reduce the electric lighting consumption of buildings (ASHRAE, 2011).

According to McCullagh (1978) “radiation is the process by which heat is transferred from one object to another” (p. 7). Using this logic, solar radiation is the process by which heat is transferred from the sun to the planet, and then to building envelopes (Boodley and Newman, 2009). Heat from the sun travels through the solar system and the atmosphere as waves. When solar radiation waves come into contact with glazing of building envelopes 92-96% of the solar radiation is transmitted through the glazing, 4-8% is reflected back into the environment, and any solar radiation remaining may be absorbed by the glazing (Boodley and Newman, 2009) (Figure 1). The vast majority of solar radiation is transmitted through the glazing into the building interior, effectively increasing the heat, and thus the temperature, inside the building. This increase in temperature directly impacts the electric cooling consumption of the building to decrease the interior temperature, and indirectly increases the heating energy consumption, as heating, ventilation, and cooling (HVAC) systems reheat air before distributing it throughout the building (ASHRAE, 2011).

1.3. Potential of vegetation for shading

Two studies, “Microclimate land surface temperatures across urban land use/land cover forms” (Ali et al., 2017) and “Ecosystem services and valuation of urban forests in China” (Jim and Chen, 2008), showed that shading by leaves and evapotranspiration produces microclimates that are cooler than surrounding areas without vegetation. Several articles cite potential energy savings by implementing vertical greening systems on facades of buildings. Perini et al. (2011) states that plants function “as a solar filter and prevent the absorption of heat radiation of building materials extensively.” Moreover, Pérez et al. (2014) conclude that vertical greening systems “provide great potential in reducing energy consumption in buildings.” Papadakis et al. (2001) illustrated through an experimental investigation that “plants constitute an excellent passive system for solar control of buildings offering significant advantages over conventional artificial sunscreens.” While these findings have been documented for exterior systems, evidence quantifying the performance of vegetation as shading on the interior of buildings is sparse. These articles provide a foundation for exploring this application in interior systems.

When answering subquestion 1, *What types of plants would be best for the application of shading within the building envelope?* the ideal plants to be selected were identified by starting at the top of the Plant Kingdom and considering three essential plant qualities.

Quality 1: Plant Structure. Vascular plants have structural stems that support the leaf tissue, such as trees, shrubs, and vines. Non-vascular plants do not have structural stems to support the leaf tissue, and thus require a surface to attach to, such as moss. For the purpose of utilizing vegetation within the building envelope for shading, vascular plants with a structural stem are the best choice because they provide their own structure to reach for sunlight and therefore shade the interior space.

Quality 2: Plant Behavior. Some vascular plants lose their leaves and some do not. Deciduous plants lose their leaves when the temperature decreases, typically seasonally, and grows them back when the temperature increases again. Semi-deciduous or semi-evergreen plants also lose their leaves for a season, but for a much shorter timeframe than deciduous plants. Evergreen plants, as the name suggests, maintain their leaves throughout the year. Although evergreen plants do not lose all their leaves at once during a dormant period, they do lose leaves periodically, which are immediately replenished with a new leaf. For the purpose of utilizing vegetation within the building envelope for shading, evergreen plants are the best choice because they remain colorful and vibrant all year long in appropriate conditions. Deciduous and semi-deciduous plants would lose their leaves in mass which would require additional maintenance for the building owner and would not be as aesthetically pleasing as evergreen plants when they lose their leaves.

Quality 3: Leaf Shape. There are two general leaf shapes for evergreen plants. First is needle-shaped leaves, also referred to as scale or blade-like leaves, such as the types of leaves Pine Trees have. The overall form of each leaf is thin and narrow. Second is broadleaves, which are generally flat and relatively wide. For the purpose of utilizing vegetation within the building envelope for shading, broadleaves are the best choice. Due to the shape and size of each individual leaf, broadleaves provide the most surface area for shading. Needle-shaped leaves are narrow and do not provide as much surface area per leaf. In addition, many plants with needle-shaped leaves grow in cold climates, and are therefore not suitable for an interior space with a warm temperature.

Considering these three qualities, the plant type selected for the purpose of shading within the building envelope is tropical plants that are vascular, evergreen, and broadleaf.

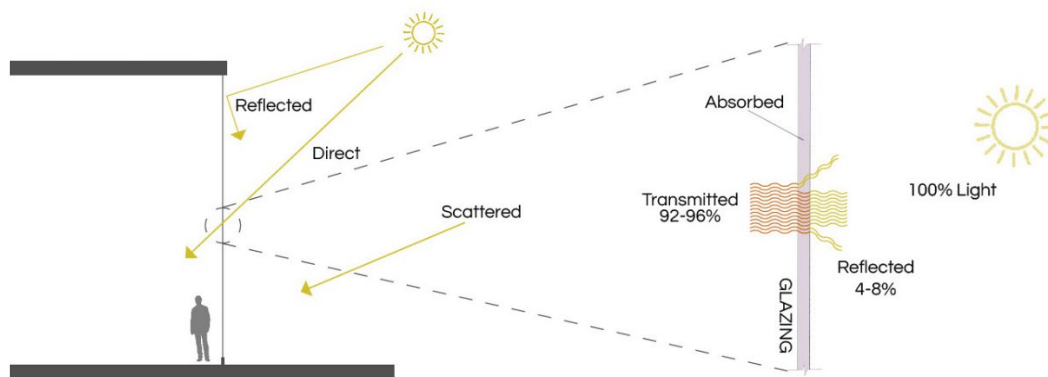

Figure 1: Visible light and solar radiation transmission. Source: (Author 2021)

2.0 METHODS AND RESULTS

Groat and Wang (2013) note that experimental and simulation methodologies are commonly combined in environmental technology research because simulation can be used to further investigate findings from the experiment at a larger scale and over a longer period of time. In this sequence of combined methods an experiment is used to explore subquestions 2 and 3, *How much visible light do plant leaves shade?* and *How much solar radiation do plant leaves shade?*, while simulation is used to explore subquestion 4, *How much energy can shading with plants save?*

2.1. Experiment: Light and solar radiation transmission

The intention of the experiment was to quantify the shading efficacy of plants by measuring how much visible light and solar radiation is transmitted through leaves of different plant species commonly used in building interiors.

The experiment was carried out on December 23, 2019 in an open field in Durham, North Carolina, at 36 degree latitude. Data collection commenced at 2:00 PM and concluded at 3:15 PM. The weather was sunny with clear skies. The high temperature for the day was 13.9°C and the low was -2.2°C. Four vascular, evergreen, broadleaf tropical plants were selected as variables for the experiment - Rubber Tree, Golden Pothos, Arrowhead, and Jade Plant (Figure 2).

The density of vegetation is variable and organic, and the quantification of that density is difficult to calculate and verify. Therefore it was determined that the simplest way to quantify the shading efficacy of vegetation is by first measuring the shading efficacy of a single layer of leaves from an individual plant. A *plant plate* was created for each of the four plant species selected for the experiment. Each *plant plate* consisted of several leaves from a single plant trimmed into

four-sided polygons and adhered flat onto a 30.5-cm x 30.5-cm by 0.5-cm thick piece of acrylic plastic. The trimmed leaves were formed into a 21.6-cm x 21.6-cm square. The leaves were adhered to the acrylic using Gorilla Glue Gel, and allowed to dry for approximately one hour. Gorilla Glue Gel was the preferred adhesive because it dries quickly and clear, not blocking light and solar radiation during the data collection. The leaves were adhered to the acrylic the morning of the experiment to ensure that leaves remained green and were still filled with chlorophyll during data collection (Figure 2).

The final *plant plates* are illustrated in Figure 2. Some plants consisted of leaves with different color tones, therefore an effort was made to mix the various color tones when arranging the leaves, particularly for the Arrowhead and Golden Pothos. In addition, an effort was made to limit the amount of overlap of trimmed leaves to maintain the “single layer” of leaves, while simultaneously preventing gaps between the individual leaves.

Four primary pieces of equipment were utilized for the experiment: an apparatus, a Precision Spectral Pyranometer (PSP), a spectrometer, and a data logger. The PSP measures the global solar radiation, or the solar radiation admitted by all available daylight (sunlight, scattered light, and reflected light). The spectrometer measures visible light, or short wavelengths within the visible spectrum for humans. The data logger stores data from the pyranometer and spectrometer in specific units, and transmits this data to a computer.

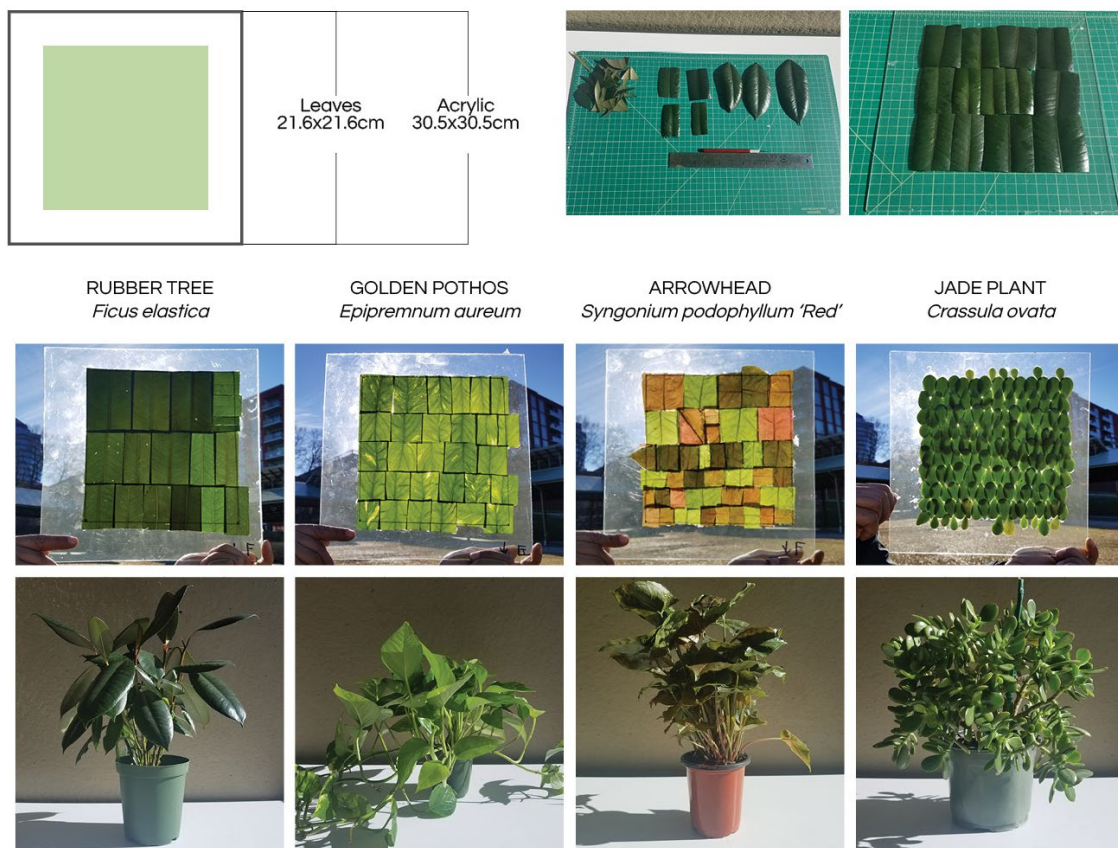

Figure 2: Tropical plant species selected for experiment and plant plates. Source: (Author 2018)

The experiment apparatus held the plant plates, PSP, and spectrometer during the data collection. The apparatus was constructed from plywood with all exposed surfaces painted flat black to prevent the reflecting and bouncing of light, thereby preventing the possibility of obscuring the data readings (Figure 3). The apparatus had two 28-cm x 28-cm apertures in the sun-ward plane. Behind each aperture was a 15.2-cm deep chamber holding a PSP and spectrometer to collect measurements. The *plant plates* were placed in front of the left aperture and a 30.5-cm x 30.5-cm by 0.5-cm thick piece of acrylic was placed in front of the right aperture as the control. The plant plates and control rested on a shelf located under the apertures. The leaves of the plant plates completely covered the left aperture, only allowing visible light and solar radiation to enter the chamber through the “layer” of leaves. The apparatus included a hinged arm to support itself in an upright position and that allowed it to tilt at the sun’s altitude. There were no obstructions blocking the sensors from the direct rays of the sun other than the *plant plates* and the control.

Four sets of data were collected, one for each plant plate. The visible light and solar radiation transmitted through each plant plate was measured for five minutes and data was recorded in 30 second intervals. Values for each plant were

regularized and averaged for comparison. To regularize the data, the measurements from the four different plant data sets were compared and made equal proportionally based on the measurements of the control. This step was to negate any change in visible light or solar radiation due to cloud cover during the time of the readings.

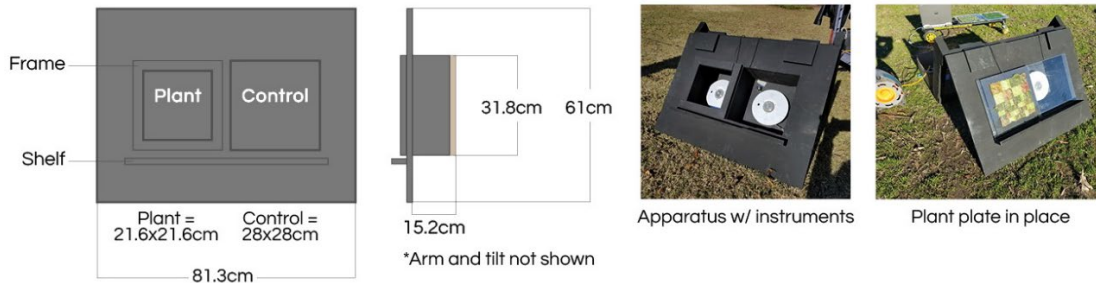

Figure 3: Experiment apparatus, dimensions and holding instruments and plant plates. Source: (Author 2018)

2.1.1. Experiment results

With 30-second intervals, there were ten data points per *plant plate* over the five minutes. After the data points were regularized, all ten data points were averaged to obtain the final amount of visible light and solar radiation transmitted through a “layer” of leaves. To determine the shading efficacy of a “layer” of leaves this value must be subtracted from 100%.

With the available sunlight representing 100% of visible light and solar radiation, the results of the experiment illustrated that a single “layer” of leaves reduces visible light transmission by 97-99% and reduces solar radiation transmission by 87-94%. The deduction in light and solar radiation transmission is profound, and it is the selection of plants and their qualities that allow control over this (Figure 4).

The plant with the leaves most effective for blocking visible light and solar radiation was the Jade Plant. Although this plant had the leaf with the smallest surface area, the Jade Plant is a succulent and contains a significant amount of water per leaf. Water is a great absorber of solar radiation, and it is suspected that the absorbing quality of the water in the Jade Plant leaf played a part in the reduction of solar radiation and visible light able to pass through the *plant plate*. The plant with the leaves least effective for blocking solar radiation and visible light was the Arrowhead Plant.

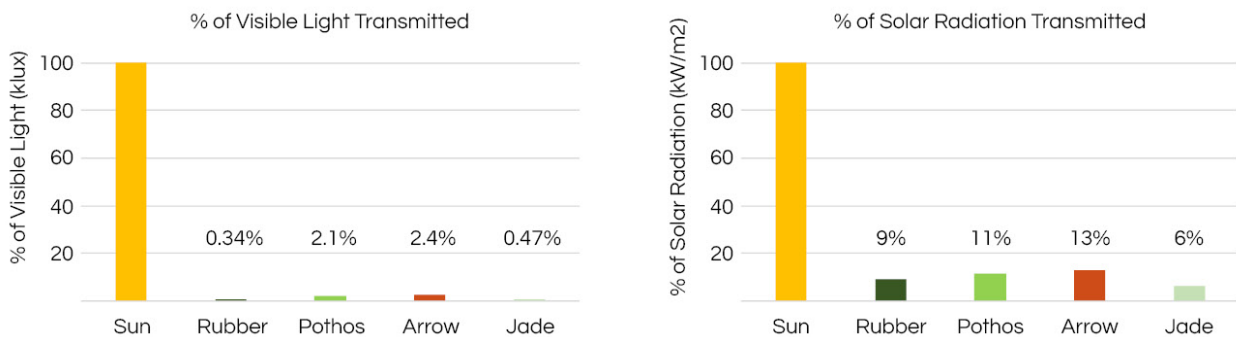

Figure 4: Visible light and solar radiation transmission of plant plates for four common tropical plants. Source: (Author 2019)

2.2. Energy Model Simulation

A simulation was used to answer subquestion 4: *How much energy can shading with plants save?*

2.2.1. Building Typology: Airport Terminals

Airport terminals was the building typology selected to further explore the use of vegetation as shading within interior spaces. Master plans for airports are typically designed without consideration of the ideal cardinal directions for glazing and before architects are brought onboard to design the terminal buildings. Thus architects are unable to optimize the orientation of airport buildings for ideal solar radiation management, and must rely on other means of managing daylight. Furthermore, occupants do not prefer to inhabit spaces without views to the outside. These two constraints lead to the use of large expanses of glazing in all cardinal directions to maximize useful daylight for illumination and for views to the outside, which can result in significant uncontrolled solar radiation entering the building interiors.

Additionally, airport regulations prevent the growing of vegetation for shading on the outside of buildings, such as trees, green walls, or green roofs, because they provide habitats for birds and other wildlife that can present a danger or additional maintenance for aircrafts when taking off or landing. This lack of vegetation near airports causes the sites to have high solar exposure, effectively creating a heat island. Therefore airports present an excellent opportunity to

explore the use of vegetation as shading within the building envelope. Vegetation within the airport building envelope introduces plants as shading to the site in a way that does not create a hazard to the aircrafts while reducing the effects of the solar radiation on the site.

In the last decade many airports, such as Changi International Airport in Singapore, O'Hare International Airport in Chicago, and Edmonton International Airport in Alberta, have begun bringing vegetation within the airport envelope. While these vegetated spaces have been praised in the media, they unfortunately do not provide any shading or energy improvement to the space (Figure 5). Contrarily, the introduction of vegetation in these airports could increase the cooling load in some regions due to the increased humidity from watering the plants and evapotranspiration. The use of vegetation as shading in airports presents the opportunity to create a green, healthy space for passengers to enjoy and recreate while also decreasing the cooling load.

Across the United States and globally there is tremendous variation in airport configurations, but all airports include four zones within the building envelope: Terminal, Security, Concourse, and Gates. The terminal is the zone of the airport which contains the passenger check-in, ticket retrieval, and baggage handling. It was selected as the zone of interest for the simulation because all international US airports have this zone, and it is generally a similar scale across airports because of the number of passengers it needs to accommodate for check-in and baggage claim. The terminal often has large expanses of glazing to allow for natural daylighting, but also for views in and out of the space, making it susceptible to high amounts of solar heat gain. In addition, a 2016 study by Nigel Dolby Consulting estimated that passengers spend about 15% of their time at the airport in the terminal (Atkins and Weinland, 2017). The consistent scale, large amount of glazing, and significant times spent in the zone makes it a strong candidate for the initial exploration of using vegetation for shading within the building envelope.



Figure 5: Airport designs with incorporated vegetation: Changi, O'Hare, Edmonton International Airports. Source: (McDonald 2019)

2.2.2. Simulation Model Design

To explore the performance of vegetation as shading, energy models were developed and annual energy consumption was simulated in three different climates. The two variables of interest for the simulation were the three diverse climates and the four geometries of the vegetated shading spaces along the terminal buildings. Therefore, four models and a control were developed that were identical except for the geometries of the vegetated shading spaces.

Because the primary benefit of using vegetation for shading would be the decreased cooling load, three cities in the United States with high cooling loads were selected to explore this through energy model simulations. Phoenix, Arizona, with IECC Climate 2A, was selected as the hot and dry climate. Houston, Texas, with IECC Climate 2B, was selected as the hot and humid climate, and Washington DC, with IECC Climate Zone 4A, was selected as the mixed and humid climate (US Department of Energy). Climate information was obtained through TMY3 files accessible through the Energy Plus website (n.d.) for Phoenix Sky Harbor International Airport, Bush Intercontinental Airport for Houston, and Ronald Reagan Washington National Airport for Washington DC.

Each model consisted of a terminal building with the long axis extending east to west, with two vegetated shading spaces (VSS) along the east and west facades, one of each end (Figure 6). The dimensions of the terminal building was 244-m by 61-m, totaling 14,864 square meters, and 18-m tall. From a review of several international airports in the United States these dimensions were among those exhibited in a large selection of terminals. The dimensions of each VSS was 61-m by 18-m, totaling 2,230 square meters each terminal building. The height of each VSS varied based on the geometry.

The four geometries explored for the vegetated shading spaces were derived from select recommended geometries for solar greenhouses from Food and Heat Producing Solar Greenhouse by Yanda and Fisher (1980, p. 30).

- Geometry A was selected because its form allows the angle of the glazing to coincide with the sun's angle, maximizing the daylight and solar radiation that is able to enter the space. For each climate's latitude the angle of incidence was calculated and used as the angle of the glazing.
- Geometry B was selected because Yanda and Fisher (1980) described it as being a good selection for a greenhouse on the east and west facades. The additional height of glazing increases the amount of light and solar radiation able to enter the space, making up for some of the light and solar radiation that is lost due to

the space being positioned on the east and west. For each climate's latitude the angle of incidence was calculated and used as the angle of the glazing.

- Geometry C was selected because Yanda and Fisher (1980) described it as having good solar exposure all year, so it also has the potential to maximize the light and solar radiation that is able to enter the space.
- Geometry D is an alternative version of a geometry recommended by Yanda and Fisher (1980). It was selected because it has good solar exposure all year, similar to Geometry C, and it benefits from the additional height of glazing, similar to Geometry B. Geometry D allows larger vegetation such as trees.

The terminal building dimensions, materials, HVAC system and settings, and schedules for occupancy, activity, lights, and equipment were the same across all models. Additionally, the VSS were modeled with the same materials and schedules. No HVAC system was included to service the VSS. Only the terminal building with VSS were modeled; no other airport zones were modeled or included in the calculations.

To represent the vegetation in the energy simulations, a shading material with a transmissivity of 13 percent was created, which was the highest percentage of transmissivity from the Light Transmission Experiment in section 2.2. Sixteen 6-m by 6-m layers of the shading material were staggered inside of each VSS in an arrangement that imitates the way that trees would be staggered throughout a space for shading.

An annual energy simulation was conducted for each model, including a control with no VSS, using the OpenStudio interface and the Energy Plus platform. For each model the simulation was repeated in all three climatic locations.

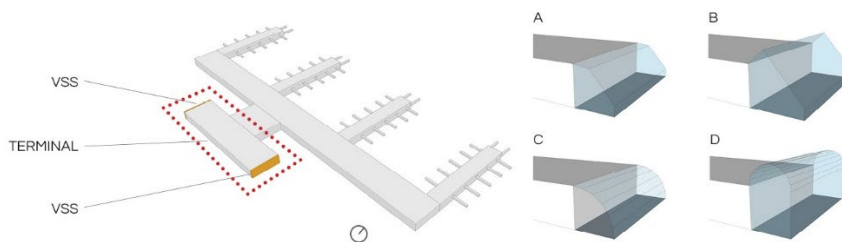

Figure 6: Terminal building with VSS on east and west facades. Four VSS geometries. Source: (Author 2019)

2.2.3. Simulation Results

The results from the energy model simulation were significant. Every model, regardless of climate or VSS geometry, had a reduction in energy consumption of at least 16% (Figure 7).

The most energy reduction occurred in Phoenix, the hot and dry climate, where the cooling load is very high because of the high temperatures and solar heat gain. The location with the next most energy reduction was Washington, DC, the mixed and humid climate. While the cooling demand in Washington, DC is not as much Phoenix, Washington, DC is less humid than Houston, so the VSS were able to decrease the cooling demand more because it was not also combating high humidity. Although cumulatively the least energy reduction occurred in Houston, the models still indicate a significant decrease in energy consumption compared to the control, a terminal building without a VSS.

Across the four models, geometry A performed the best in all locations. Although the angle of incidence maximizes the solar radiation able to enter the VSS, there is less surface area of glazing for heat to enter or exit the space. This reduces the cooling and heating energy consumption compared to the other geometries with more surface area of glazing. Geometry C performed the next best in all locations, likely for the same reason of having a smaller surface area of glazing compared to geometries B and D. Geometries B and D performed the worst, likely due to the increased surface area of the glazing.

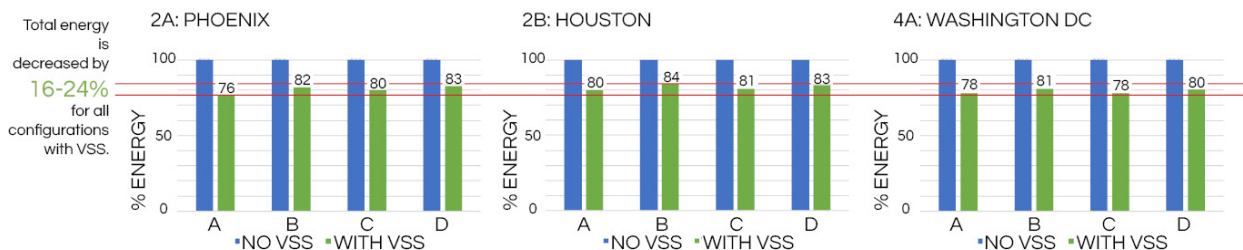

Figure 7: Energy model simulation results with VSS on east and west facades of airport terminal building. Source: (Author 2019)

CONCLUSION

The objective of this research was to investigate the question *Is vegetation inside the east- and west-facing facades a viable solution for shading?* It was determined that the vegetation type best suited for this application was tropical plants because they are self-supporting, maintain their foliage, and have broad leaves that can provide more surface area to shade the interior spaces efficiently.

The experimental results were significant, indicating that all four tropical plants commonly found indoors have the potential to greatly reduce visible light and solar radiation transmission when used for shading. The data results suggest that east and west facing facades shaded by vegetation would not be a good light source for a working surface, but would offer thermal benefits and have the potential to offer psychological benefits. One limitation of the experiment is that it tested a single “layer” of leaves. Vegetation can grow several layers in depth, having both volume and scale. Future research should explore plants in their true dimensions, as well as in groupings, to more accurately measure how visible light and solar radiation is filtered.

The results of the energy model simulation was also significant, indicating that in all three climates VSS have a strong potential to reduce energy consumption of airport terminal buildings. Although these findings align with results in existing literature illustrating that vegetation can create cooler microclimates, reduce surface temperatures of building facades, and decrease energy consumption, these findings are among the first that explore the use of vegetation as shading on the *interior* spaces of buildings, which opens up a new niche in the built environment for this application. A more detailed look at the specific hourly or daily data points from the energy models is needed to determine what area of energy demand was reduced the most. The results are also a reminder that an increased surface area of glazing beyond what is necessary could negate some of the shading and cooling benefits of the VSS, thus there must be a balance between the scale of VSS and the amount of glazing enclosing the space.

Similar to the experiment, a limitation of the simulation is the model or representation of the vegetation. Energy modeling software is currently limited in the available functions to simulate a living biological organism that not only blocks light and solar radiation, but also releases and absorbs gases and moisture. Future research should explore the development of a more accurate representation of vegetation that captures its dynamic qualities as a living organism.

Future phases of this research agenda will use a mixed methods approach. A mixed methods study is a systematic integration of quantitative and qualitative methods (and thus epistemologies), along with more than one kind of technique for collecting, analyzing, and representing human phenomena, into a single study (Johnson et al., 2007). Using this approach allows for obtaining a fuller, deeper, and more holistic understanding of complex phenomena. The following are descriptions of the subsequent phases.

- Phase 2: Use initial results, interior landscape design principles, and passive solar design principles to explore this concept through an evidence-based design-driven approach. Develop a catalog of potential designs and interchangeable components into a first-generation version of a visual design toolkit for vegetative shading.
- Phase 3: More in-depth experiments and energy simulations on light and thermal-radiation transmittance of candidate plant species for vegetative shading, exploring both types of vegetation and the distribution of that vegetation in space.
- Phase 4: Use a survey instrument to study human responses to vegetative shading environments.
- Phase 5: Use qualitative, semi-structured interviews to more deeply explore perception and biophilic impacts of vegetative shading environments. Interviews intend to expand on findings from previous phases for a more holistic understanding of the phenomena.

This research lays the foundation for a novel approach to shading with vegetation in building interiors. Phase 1 has begun to fill the gap in knowledge about the shading efficacy of different plant species, across diverse climates, and in different spatial geometries. Phases 2-5 will build on this foundation to develop a unified index that integrates different aspects of vegetative shading for building design. This research offers the potential for effective shading on the east and west facades of building typologies that cannot be easily shaded by vegetation such as airports, tall buildings, and buildings in dense city grids. Furthermore, a primary goal of this research agenda is to make vegetative shading available to not only benefit the environment by reducing heat island, cooling loads, and greenhouse gases, but also for the health and well-being of building occupants.

REFERENCES

- Aldakheel, J.A., & Aoul, K.T. 2017. *Building applications, opportunities and challenges of active shading systems: A state-of-the-art review*. *Energies*, 10(10), 1-32.
- Ali, S. 2017. *Microclimate land surface temperatures across urban land use/ land cover forms*. *Global Journal of Environmental Science and Management*. 3. 10.22034/gjesm.2017.03.03.001.
- Alshamrani, O., & Mujeebu, M.A. 2016. *Effects of shading strategy and orientation on energy performance of school building*. *Journal of Architecture and Planning*, 28(1), 129-141.
- American Society of Heating, Refrigerating, and Air-Conditioning Engineers [ASHRAE]...[et al.]. 2011. *Advanced energy design guide for small to medium office buildings: Achieving 50% energy savings toward a net zero energy building*. Atlanta, GA: ASHRAE.
- Atkins, R., & Weinland, D. 2017. *Time spent in the airport*. *Financial Times*. Retrieved from <https://www.ft.com/content/5628f254-778e-11e7-90c0-90a9d1bc9691>
- Boodley, J.W., & Newman, S.E. 2009. *The commercial greenhouse (3rd ed.)*. Clifton Park, NY: Delmar.
- Browning, W.D., Ryan, C.O., Clancy, J.O. 2014. *14 Patterns of biophilic design*. New York: Terrapin Bright Green LLC.
- Bruce, V., Georgeson, M.A., Green, P.R., & Georgeson, M.A. 2003. *Visual perception: Physiology, psychology and ecology*. ProQuest Ebook Central <https://ebookcentral.proquest.com>
- Ching, F.D., & Adams, C. 2001. *Building construction illustrated*. New York: Wiley & Sons, Inc.

- Energy Plus*. (n.d.). Retrieved April 25, 2021, from <https://energyplus.net/>
- Farouk, H., & Elsharkawy, H. 2020. *To what extent can solar control be effective in enhancing indoor comfort in a fully glazed office building?* IOP Conf. Series: Earth and Environmental Science, 588, 1-9.
- Groat, L., & Wang, D. (2013). *Architectural research methods (2nd ed.)*. New York, NY: Wiley.
- Hammer, N. 1992. *Interior landscape design*. New York, NY: McGraw-Hill Architectural & Scientific Publications, Inc.
- US Department of Energy. *IECC Climate Zone Map*. Retrieved from <https://basel.pnnl.gov/images/iecc-climate-zone-map>
- International WELL Building Institute. (2020). *The WELL Building Standard v2*. Retrieved from <https://v2.wellcertified.com/en/wellv2/concepts>
- Jim, C.Y. & Chen, W.Y. 2009. *Ecosystem services and valuation of urban forests in China*. *Cities*, 26(4),187-194.
- Johnson, R., Onwuegbuzie, A., & Turner, L. (2007). *Toward a definition of mixed methods research*. *Journal of Mixed Methods Research*, 1, 112-133.
- Kamal, M.A. 2011. *Shading of buildings*. *Architecture + Design*, 28(3), 90-98.
- McCullagh, J. (Ed). 1978. *The solar greenhouse book*. Emmaus, PA: Rodale Press, Inc.
- McDonald, R. M. (2019). *Organic infrastructure: Vegetation as an alternative shading method* [Unpublished master's thesis]. North Carolina State University.
- Olgyay, A., & Olgyay, V. 1957. *Solar control & shading devices*. New Jersey: Princeton University Press.
- Papadakis, G., Tsamis, P., & Kyritsis, S. 2001. *An experimental investigation of the effect of shading with plants for solar control of buildings*. *Energy and Buildings*, 33(8), 831-836.
- Perini, K., Ottele, M., Fraaij, A.L.A., Haas, E.M., Raiteri, R. 2011. *Vertical greening systems and the effect on air flow and temperature on the building envelope*. *Building and Environment*, 46(11), 2287-2294.
- Perez, G., Coma, J., Martorell, I., Cabeza, L.F. 2014. *Vertical Greenery Systems (VGS) for energy saving in buildings: A review*. *Renewable and Sustainable Energy Reviews*, 39, 139-165.
- Stigsdotter, U.A. 2004. *A Garden at your workplace may reduce stress*. *Journal of Design & Health* 13, 147-157.
- The American Institute of Architects [AIA]. 1981. *The Architect's Handbook of Energy Practice: Shading and Sun Control*. New York: The American Institute of Architects.
- Ulrich, R.S. 1984. *View through a window may influence recovery from surgery*. *Science*, 224(4647), 420-421.
- Yanda, B. & Fisher, R. 1980. *The food and heat producing solar greenhouse*. Santa Fe, NM: John Muir Publications, Inc.

The Benefits of Biophilic Architecture in Interior Spaces: Applications on Schools.

Ebtehal Bahnasy¹

¹University of Minnesota, Minneapolis, MN

ABSTRACT: People spend most of their time indoors on a daily basis, making it more difficult to connect with nature in urbanized areas. Connection to nature has been shown to offer numerous benefits, including improved health, less stress, and a desire to safeguard the environment. Interior space design can contribute to a sense of connection with nature, and user behavior in the built environment has a significant environmental influence. This study looks at how biophilic design components can influence occupants' sense of connectivity to nature (CTN) and, as a result, encourage pro-environmental behavior (PEB). The study employs a combination of approaches to determine the influence of design features as a design intervention on PEB users. To begin, a quantitative meta-analysis of published studies is carried out to determine the extent of the influence of various design interventions and their outcomes. A qualitative study using local schools as a case study complements this quantitative investigation. The research attempts to understand the problems and potential of developing biophilic schools by interviewing design specialists and persons in administrative positions who were involved in school designs. The findings of both investigations are examined to give designers and architects recommendations for school design guidelines. Students in local schools can benefit from the implementation of the recommendations, which cover PEB, physical and mental well-being, academic performance, and more.

KEYWORDS: Biophilic design, pro-environmental behavior, connectedness with nature, meta-analysis.

INTRODUCTION

Our cities have become places designed by modernist fads and economics, with little regard for health, well-being, love of life, or the more intuitive humanistic designs of our history (Söderlund and Newman 2017). Modern lives have built psychological and physical barriers between humans and the natural world in much of the developed world (Jones 2013). Direct encounters with nature have become increasingly infrequent, and many people now experience the natural world through indirect or vicarious means (Schultz 2002).

Many environmental problems are caused by human conduct, which can be mitigated by encouraging pro-environmental behavior (PEB) (Gardner and Stern 1996). Stern (2000) defines environmental behavior as "activity that impacts the structure and dynamics of ecosystems or the biosphere itself or changes the availability of materials or energy from the environment." Environmentally friendly activities are those that reduce or eliminate harmful effects on the natural environment (Kollmuss and Agyeman 2002).

To protect environmental quality, researchers have determined that behavior modification is required (Leeming et al, 1993). It is undeniable that how people interact with buildings, such as opening and closing windows and blinds, turning lights on and off, and modifying thermostat settings, has an impact on their energy efficiency. These modifications cater to the users' thermal and visual comfort needs. According to Xu et al. (2017), the key to a complete knowledge of occupant behaviors and the potential for energy efficiency at the community level is to integrate the physical and social sciences.

1.0 STUDY DESIGN

This study looks at how biophilic design features can influence one's sense of connectivity to nature (CTN) and, as a result, encourage pro-environmental behavior (PEB). The study's objectives are to identify what design interventions have been tested and measure their efficacy, to understand their impact with a focus on schools, and to generate design recommendations for local schools.

For two key reasons, schools are chosen as the study environment. First, changing one's conduct at a young age can have a long-term impact, and youngsters are more open to new ideas. Because elementary school students spend the entire academic year in the same classroom, they have more opportunities to be exposed to design interventions. Designing semi-open and open areas that are livable all year becomes more difficult, especially in cold climates. Second, a survey of existing biophilia projects reveals that workstations and residential units are readily available. Despite being mentioned and explored in academic literature, biophilic schools are more difficult to locate. The study adds to the existing literature and provides actionable recommendations for new and existing schools.

2.0 LITERATURE REVIEW

2.1. Biophilic design

The term "biophilic design" refers to a design concept that blends the natural world with the built environment in order to promote physical and emotional well-being (Grzywa 2015). Söderlund and Newman (2017) define biophilic design as a set of concepts, features, and practices for cities to retain the required daily dose of nature. Architecture that incorporates and mimics features of nature might be more aesthetically pleasant and healing. (Mangone et al. 2017). Biophilic design has been described as a creative process that tries to conserve and increase our connection with the forces and faces of nature, a core organizing element of all works of architecture, according to researchers (Rosenblatt Naderi 2009). It's also been defined as a long-term design strategy aimed at achieving positive transformation in users by integrating and connecting people and nature (Lee and Park 2018). Kellert (2008) described biophilia as the "missing link" in sustainable design, stating that it strives to lessen the harm caused by the built environment while also making it more appealing, fun, and healthy. The reason for this is that people's environmental preferences are linked to the natural environment's aesthetic qualities (Berto et al, 2018). Exposure to green environments has been proved to have physical and psychological benefits to individuals (Hand et al. 2017).

Psychological restoration by optimizing attention and recuperating from stress, ecological restoration, and biocultural restoration by re-establishing people's connection to nature should all be goals of restorative environments (Mangone et al. 2017). S. Kellert (2008) defined six biophilic design components and 70 biophilic design qualities in his book *Biophilic Design: "The Theory, Science, and Practice of Bringing Buildings to Life"* (Rosenblatt Naderi 2009). Contributing authors divided user experience into three categories: nature in space, natural analogs, and nature of space (Browning et al. 2014). Browning et al. (2014) recently published study that deconstructs 14 biophilic design patterns, including design considerations and psychological effects on users. The experiment presented in this paper is guided by Browning et al. (2014). Kellert later reduced his seventy design qualities to twenty-four, which were organized into three categories: direct experience of nature, indirect experience of nature, and experience of space and place (Kellert and Calabrese 2015).

Biophilic design has been shown to reduce workplace stress, improve school performance, aid inpatient rehabilitation, and enhance community togetherness, among other health and well-being concerns (Browning et al. 2014). Landscape architects can utilize biophilic design to support public health goals, infrastructure resilience, ecosystem function, and cultural aesthetics when it is introduced early in the design process (Browning, Ryan and Clancy 2014).

2.2. Pro-environmental behavior

Many factors, such as biophilic architecture and interior design features, can influence pro-environmental behavior. Behavioral interventions must be developed, administered, and assessed in a systematic manner in order to be effective. The difficulty is to comprehend the aspects that influence environmental sustainability in order to facilitate PEB. Stern (2000) identified four types of environmental behavior-influencing causal variables. They include attitudinal elements (such as norms, beliefs, and values), contextual forces, personal capacities, and each subject's habits and routines. Environmental knowledge is a broad grasp of the human-natural connection. People with more environmental knowledge are more conscious of the environmental concerns that influence their society and are better equipped to deal with environmental crises, either individually or collectively. The majority of studies show a link between environmental awareness and PEB (Kirk 2010).

3.0 RESEARCH METHODOLOGY

There are two processes in the research methodology. The first is a quantitative review of studies that looked into the impact of biophilic design in interior spaces. The goal of the quantitative study is to determine the efficacy of various design interventions and which ones are the most beneficial. Subgroup analysis is used to list and evaluate the various design interventions used in the studies that are included. A qualitative analysis using a series of interviews is the second step. Interviews with design experts who worked on projects in local schools have been scheduled. The interviews were conducted to see what design interventions were prioritized in school designs based on their personal experiences. Another goal is to determine what obstacles and hurdles they experience in implementing these design innovations. Both investigations produce recommendations for policy changes based on the knowledge gained from the quantitative study and the needs analysis gained from the qualitative study.

3.1. Quantitative study design

The quantitative analysis aims to review published articles in the field of research and to understand which design interventions were proven to yield the most positive outcomes. The online tool MetaMar is used to conduct the meta-analysis. A list of requirements is used to decide whether a reference can be included in the study.

Two search strings were conducted and examined. The university's library website and the MDPI database were searched using identical search strategies. The first search string aimed to understand the overlap and duplication of articles that emerge when one of the keywords changes to specify design intervention. Surprisingly, no duplicates were found. Additionally, the majority of the articles were excluded for being irrelevant to the study. Therefore, a second more detailed search was conducted. The second search was more specific and yielded a wider range of relevant articles and studies. It included the keywords "Biophilic design" and "quantitative" and "connectedness with nature" and "Pro-environmental behavior". The number of studies retrieved from the databases and the number of included and excluded papers are listed in the data retrieval graph (Figure 1).

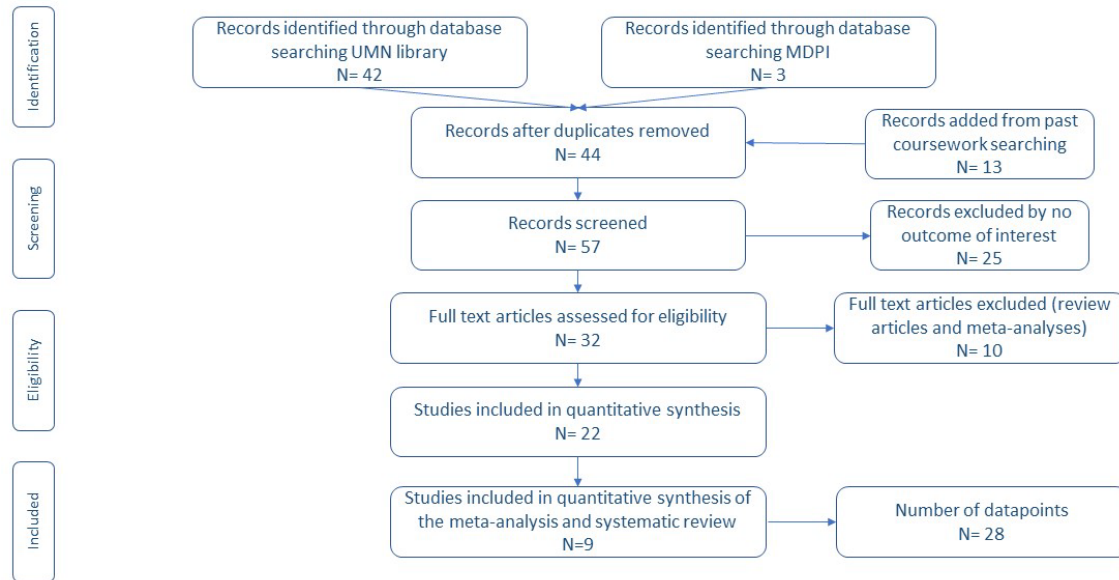

Figure 1: Data retrieval graph. (By Author)

3.2. Inclusion criteria

The included studies are selected upon a few conditions. First, they are quantitative ones that include data about a control and a treatment group, to extract Mean and Standard Deviation. Second, studies must take into consideration the design of the surrounding environment (interior, exterior, parks, zoo, ...etc.) Studies that are purely focused on psychology and social sciences are excluded since interventions are not related to the design field. The location, participants' backgrounds, and design intervention can vary as the meta-analysis considers these factors when generating the results. Additionally, all building typologies are included; focus on schools stem from the qualitative study. Finally, study outcomes can vary, as the subgroup analysis classifies the different outcomes.

3.3. Qualitative study design

Supported by the literature review, interviews are conducted to get a better understanding of the needs and challenges faced during the design of local schools. The interviewees are identified based on their expertise in the design field, and recommendations of colleagues and fellow researchers. The study was exempt from IRB since it is not considered human research. The interviewees are asked if the online meeting can be recorded for research purposes. The semi structured interviews typically start by introducing biophilic design patterns (Table 1). Afterwards, the questions listed below are asked:

1. Based on your experience, are biophilic design principles currently being prioritized in school design? Why?
2. Why are efforts focused on these elements more than others?
3. What positive outcomes come out of these interventions?
4. How are these outcomes being measured or evaluated?
5. What elements do you think are missing and should be prioritized?
6. What are the challenges that designers face when implementing these interventions?
7. What changes or improvements do you hope to see in policies and design guidelines?

Table 1: 15 Patterns of Biophilic design. (Browning et. Al 2020).

<i>NATURE IN THE SPACE</i>	<i>NATURAL ANALOGUES</i>	<i>NATURE OF THE SPACE</i>
Visual Connection with Nature	Biomorphic Forms and Patterns	Prospect
Non-Visual Connection with Nature	Material Connection to Nature	Refuge
Non-Rhythmic Sensory Stimuli	Complexity and Order	Mystery
Thermal and Air Flow Variability		Risk/Peril
Presence of Water		Awe
Dynamic and Diffuse Light		
Connection with Natural Systems		

4.0 ANALYSIS AND OUTCOMES

4.1. Quantitative study

The outcome of the analysis includes a breakdown of the body of qualitative studies in the studied research area as shown in The Forrest plot (Figure 2). The plot shows the effect size of each datapoint in reference to a 95% Confidence Interval (CI), as well as the pooled effect size. Another outcome is a calculated effect size of the most impactful design interventions and the positive outcomes they yield, described here as subgroup analysis (Figure 3). Next, the analysis tests heterogeneity (Table 2) to ensure that the outcomes reflect different groups of participants. A high heterogeneity means that the studies are not related, and that the effect sizes are almost random. Finally, the study checks for publication bias (Figure 4) and takes into account the number of participants and the acceptance or rejection of hypotheses in published studies. The learnings are listed here:

- The study field is mostly qualitative, many quantitative studies focus on a qualitative description of the results.
- However, for a metanalysis, it is necessary to have access to the data to perform the statistical test.
- An ideal situation would be performing a metanalysis as a part of a research lab or group, in collaboration with more researchers and including ongoing studies.
- This study serves as a prototype that is reproducible when more data is available.
- Indirect nature experiences that promote environmental education have a positive impact on the users. This includes talking about nature, reading about it and watching nature videos.
- This indicated the importance of school curriculum to support sustainability education in addition to their design.

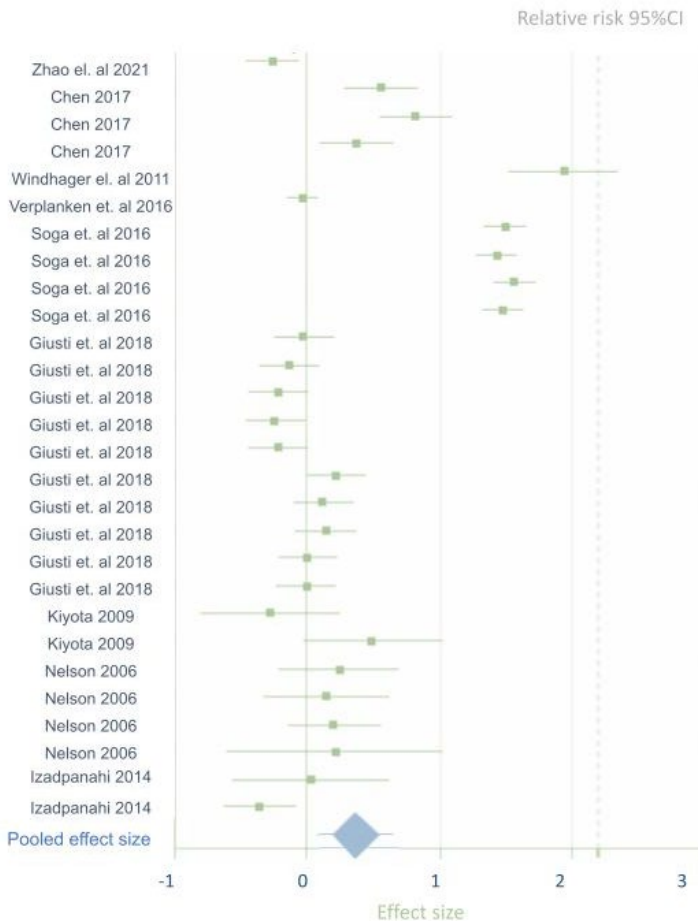

Figure 2: The Forrest plot. (By Author). Software: MetaMar.

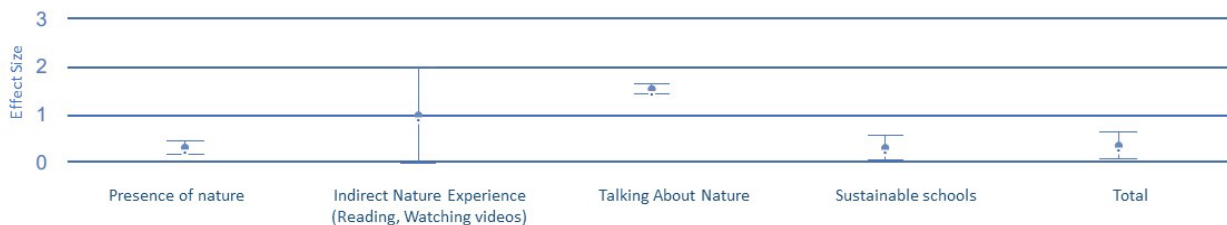

Figure 3: Subgroup analysis.(By Author). Software: MetaMar.

Table 2: Effect size calculation and Heterogeneity test. (By Author). Software: MetaMar.

Subgroups	Number of studies	Hedges's g	p value	Heterogeneity %
Presence of nature	21	0.30	0.000014	81.13
Indirect Nature Experience (Reading, Watching videos)	3	0.98	0.053	99.30
Talking About Nature	2	1.53	0.005	0.0
Sustainable schools	2	0.30	0.021	2.52
Total	28	0.34	0.014	97.53

95%CI	[0.068,0.629]
z score	2.435

Cohen’s d is the difference between two groups in terms of standard deviations, Hedges g is Cohen’s d after adjustment for small sample bias.

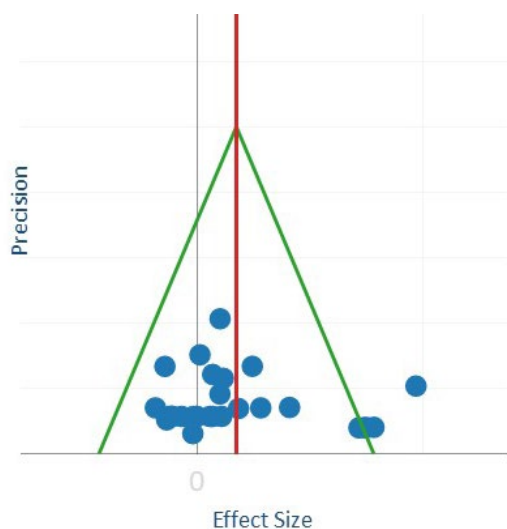

Figure 4: Check for publication bias. (By Author). Software: MetaMar.

4.2. Qualitative study

Open coding and thematic analysis (Figures 4 and 5) are used to categorize the emerging themes and patterns from the different interviews. The results of the quantitative study are being reported in light of these themes. For instance, the issues of maintenance and safety were brought up in all interviews so far. Therefore, the outcomes of the meta-analysis and the design recommendations are formulated around these issues, to better fit the local needs and challenges. To this point, a preliminary outcome is that PEB is not the priority in school design. This means that the recommendations should be drafted to meet other outcomes, with PEB being a secondary one.

The learnings are listed here:

- Suggestions for the design guidelines of local schools need to be focused on experience, as well as performance-based design decisions. Achieving that performance depends on the case study, and the contextual factors.
- The benefits of biophilia in schools need to be measurable and supported with precedents.
- Pro-environmental behavior is harder to measure as it requires lengthened exposure, therefore, it can be a secondary benefit.
- Sustainability education is critical for environments to perform as designed.
- The role of teachers and building operators is critical to creating a positive change in behavior.



Figure 5: Thematic analysis: Challenges of implementing Biophilic interventions in schools. (By Author).

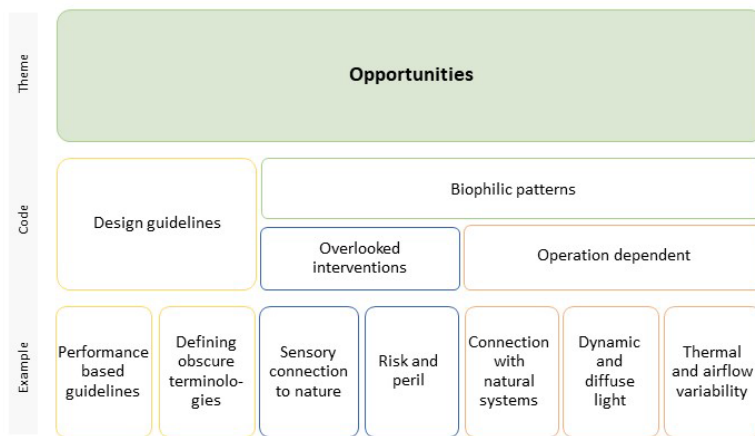

Figure 6: Thematic analysis: Opportunities of implementing Biophilic interventions in schools. (By Author).

4.3. Design and policy recommendations

Knowledge gained from both studies is used to propose strategic design and policy recommendations (Table 3). The first column is listing the themes and code that emerged from the qualitative analysis. Next, in the second column, biophilic design interventions are matched with these codes. Finally, information gained from the interviews and the systematic method analysis is used to propose changes to the existing documents in order to reflect the needs and challenges to design biophilic schools. The implementation of these recommendations can facilitate decision making processes between clients, architects, and designers, and provide actionable items for facility managers.

There are several challenges and limitations to the quantitative study. First, the study is only focusing on articles that have been published whereas other experiments that were not published would provide a valuable level of information. However, there is no way to access these articles. Second, the quantitative analysis requires data about a treatment group and a control group in the form of three values which are the number of participants, mean and standard deviation. Most of the studies retrieved from databases lacked this level of detail. Therefore, the researchers interpreted some of the values when possible, and in other cases the studies had to be excluded from the meta-analysis. The quality and accuracy of the outcome is dependent on the information that is fed into the quantitative analysis tool.

Table 3: Design and policy recommendations. by author.

<i>Category: Driven from Qualitative Analysis Themes</i>	<i>Corresponding Biophilic Design Interventions</i>	<i>Design and policy recommendations: Driven from Quantitative analysis subgroups</i>
Common Interventions at Schools	- Visual Connection with Nature - Refuge - Material Connection with Nature	Listing benefits and anticipated outcomes of these interventions, as well as ways to measure them.
Need for Definitions and Precedents	- Non-rhythmic Sensory Stimuli - Biomorphc Forms and Patterns - Complexity and Order	Include definitions of the interventions in the guidelines as well as case studies and a list of benefits and anticipated outcomes.
Safety Concerns	- Presence of Water - Risk/ Peril	Suggesting versions of these patterns that are suitable for schools, supported by precedents.
Operational Dependent Interventions	- Access to Thermal and Airflow Variability - Dynamic and Diffuse Light	Educating facility managers and building operators of the role of different building elements and how to leverage them.
Uncommon Interventions at Schools	- Non-visual Connection with Nature - Mystery	Include case studies of the interventions in the guidelines and exemplary recommendations.
Site Dependent Interventions	- Prospect - Connection with Natural Systems	Providing suggestions for restrictive site locations to include these patterns in alternative ways.

CONCLUSION

The quantitative study, on the other hand, is constrained by the quality of published studies and the availability of full-text publications and extra information. As part of a research lab or group, having access to a variety of active studies would be excellent. Furthermore, incorporating research before the results are known decreases the potential of bias. The meta-analysis becomes a prospective rather than a retrospective investigation. This study serves as a prototype as well as a search and analysis process that can be duplicated once more studies and values are available.

When seeking to influence human behavior in behavioral sciences, numerous external elements must be considered. Students' backgrounds and behavior at home, which might affect children's adaptation to new behaviors, as well as the environment and climate in which they are growing, are examples of such elements. There are four types of causative variables that influence environmental behavior (Stern 2000). They include attitudinal elements (such as norms, beliefs, and values), contextual forces, personal capacities, and each subject's habits and routines. In addition, schools are adjusting to the pandemic in a variety of ways, including hybrid systems and small-group instruction. The research contribution to practice includes developing a set of recommendations that are appropriate for cold climates, which will help kids feel more connected to nature. This study's application may have a favorable impact on user behavior, reducing negative environmental impact. Furthermore, the study contributes to the literature by updating current meta-analyses and testing research at a local school to contribute to the literature through a case study.

Future studies should investigate learning outdoors in natural environments and developing curriculum methods to encourage pro-environmental behavior.

ACKNOWLEDGEMENTS

I would like to extend my gratitude to Sungduck Lee and Jonee Kulman Brigham for their mentorship and vital contribution to the project. Special thanks to the director of the Master of Science in Research Practices program Malini Srivastava for her continued guidance and support.

REFERENCES

- Berto, R., Barbiero, G., Barbiero, P., & Senes, G. (2018). *An Individual's Connection to Nature Can Affect Perceived Restorativeness of Natural Environments. Some Observations about Biophilia*. Behavioral Sciences, 8(3), 34.
- Browning, William D., and Catherine O. Ryan. (2020). *Nature inside: a biophilic design guide*. Routledge.
- Browning, W., Ryan, C., & Clancy, J. (2014). *14 Patterns of Biophilic Design*. Terrapin Bright Green, LLC, 1–60.
- Chen, Y., (2017). *The impact of biophilic design on health and wellbeing of residents through raising environmental awareness and nature connectedness*. PhD diss., University of Georgia.
- Izadpanahi, P., and Elkadi, H. (2014). *The Catalyst Role of School Architecture in Enhancing Children's Environmental Behavior*. In Proceedings of the 30th International PLEA Conference: Sustainable Habitat for Developing Societies, choosing the way forward, pp. 464-475. CEPT University Press.
- Gardner, G. T., & Stern, P. C. (1996). *Environmental problems and human behavior*. In *Environmental problems and human behavior*. Allyn & Bacon.

- Giusti, M., Svane, U., Raymond, C., Beery, T., (2018). *A framework to assess where and how children connect to nature*. *Frontiers in psychology* : 2283
- Grzywa, A. (2015). *Designing to Engage Users in Sustainable Buildings*. University of Maryland.
- Hand, K. L., Freeman, C., Seddon, P. J., Recio, M. R., Stein, A., & van Heezik, Y. (2017). *The importance of urban gardens in supporting children's biophilia*. *Proceedings of the National Academy of Sciences*, 114(2), 274–279.
- Jones, D. R. (2013). "*The biophilic university*": A de-familiarizing organizational metaphor for ecological sustainability? *Journal of Cleaner Production*, 48, 148–165.
- Kellert, S. (2008). *Biophilic Design: The Theory, Science and Practice of Bringing Buildings to Life*.
- Kellert, S., & Calabrese, E. (2015). *The practice of Biophilic architecture*. Retrieved from www.biophilic-design.com
- Kirk, J. L. (2010). *Sustainable Environments and Pro-Environmental Behavior*. University of Nebraska at Lincoln.
- Kiyota, E., (2009). *People-nature interactions: The therapeutic role of nature in elderly residents' everyday experience in a long term care facility*. The University of Wisconsin-Milwaukee.
- Kollmuss, A., & Agyeman, J. (2002). *Mind the Gap: Why do people act environmentally and what are the barriers to pro-environmental behavior?* *Environmental Education Research*.
- Lee, H. C., Park, S.J. (2018). *Assessment of importance and characteristics of biophilic design patterns in a children's library*. *Sustainability* 10, no. 4 : 987.
- Leeming, F. C., Dwyer, W. O., Porter, B. E., & Cobern, M. K. (1993). *Outcome research in environmental education: A critical review*. *Journal of Environmental Education*.
- Mangone, G., Capaldi, C. A., van Allen, Z. M., & Luscuere, P. G. (2017). *Bringing nature to work: Preferences and perceptions of constructed indoor and natural outdoor workspaces*. *Urban Forestry and Urban Greening*, 23, 1–12.
- Nelson, Reese F. (2006). *Mitigating stress in college students by enhancing testing center environments through passive interaction with plants*. University of Idaho.
- Rosenblatt Naderi, J. (2009). *Book review: Biophilic Design: The Theory, Science and Practice of Bringing Buildings to Life*. *Landscape and Urban Planning*, 93, 262–265.
- Schultz, P. W. (2002). *Inclusion with Nature: The Psychology Of Human-Nature Relations BT - Psychology of Sustainable Development*. In P. Schmuck & W. P. Schultz (Eds.) (pp. 61– 78). Boston, MA: Springer US.
- Soga, M., Gaston, K., Yamaura, Y., Kurisu, K., Hanaki K., (2016). *Both direct and vicarious experiences of nature affect children's willingness to conserve biodiversity*. *International journal of environmental research and public health* 13, no. 6: 529.
- Söderlund, J., & Newman, P. (2017). *Improving Mental Health in Prisons Through Biophilic Design*. *Prison Journal*, 97(6), 750–772.
- Stern, P. C. (2000). *New Environmental Theories: Toward a Coherent Theory of Environmentally Significant Behavior*. *Journal of Social Issues*.
- Verplanken, B., Roy, D. (2016). *Empowering interventions to promote sustainable lifestyles: Testing the habit discontinuity hypothesis in a field experiment*. *Journal of Environmental Psychology* 45, 127-134
- Windhager, S., Atzwanger, K., Bookstein F., Schaefer, K. (2011). *Fish in a mall aquarium—An ethological investigation of biophilia*. *Landscape and Urban Planning* 99, no. 1: 23-30.
- Xu, X., Maki, A., Chen, C. fei, Dong, B., & Day, J. K. (2017). *Investigating willingness to save energy and communication about energy use in the American workplace with the attitude behavior-context model*. *Energy Research and Social Science*, 32, 13–22.
- Zhao, S., and Patuano A. (2018). *International chinese students in the uk: Association between use of green spaces and lower stress levels*. *Sustainability* 14, no. 1: 89.

The Impact of Spatial Light Patterns on Older Adults' Perception and Preference of the Indoor Environment

Nasrin Golshany¹, Ihab Elzeyadi¹

¹ University of Oregon, Eugene, OR

ABSTRACT: Architectural lighting quality is one of the significant indoor environmental qualities that could potentially play an important role in improving the living environment for older adults. Elderly residents in assisted living facilities spend 90% of their time in indoor spaces, where poor quality and quantity of light are responsible for falls, injuries, and physical and psychological problems impacting their daily activities. Studies have shown that qualitative aspects of lighting design such as lighting arrangement, distribution, and general spatial light patterns are as important as quantitative attributes such as light intensity and spectrum on human outcomes. However, there are not enough studies investigating the impact of spatial light patterns on elderly outcomes, especially their perception and preference.

This study aims to show whether spatial patterns of light can impact *subjective impressions such as perception*, mood, and preference of older adults. We used a mix of quantitative and qualitative methods starting from the multiple sorting task techniques (Q-sort) in a survey to compare participants' perceptions and preferences under different lighting conditions. A total number of 60 participants were recruited (39 females and 21 males) from residents of an assisted living facility, to answer the survey including Qsort questions. The questions include familiar-looking pictures of interior spaces based on 6 spatial patterns that evaluate the older adults' stress and visual preference.

The findings demonstrated a statistically significant relationship between different spatial patterns (uniform/non-uniform, central/perimeter, and direct/indirect) and elderly peoples' subjective impressions. This study revealed that the aging population prefers uniform lighting over nonuniform lighting and indirect light over direct light. The results also indicated that older adults might perceive non-uniform lighting as a more relaxed environment while uniform lighting reinforces the sense of formal settings associated with higher stress levels.

KEYWORDS: human-centric lighting, visual preference, spatial pattern, Older-adults environments, cognitive function

INTRODUCTION

The older adult population is growing very fast; by 2030, 20% of the US population will be 65 or older (Brawley, E. C. 2006; Regnier, V., 2003). Age-related changes in visual, biological, and somatosensory systems result in severe problems in physical performance (Makino et al., 2017), balance control, risk of falls (Figueiro et al, 2011), biological clock (Hofman and Swaab, 2006) and, cognitive abilities (Murman, 2015). Physiological changes and perception and cognitive impairment as a normal consequence of the aging process impact the normal life of the aging population and negatively impact their daily task performance (Birren, 1959).

Lighting as one of the significant attributes of the physical environment that impacts both visual and non-visual outcomes of humans can play an important role in improving the living environment and promoting quality of life for older adults (Lu, Park, & Ahrentzen, 2019). Environmental lighting affects people's ability in understanding visual information in the environment. An integrated lighting system that improves visual perception of the environment can play an important role in providing a safe and healthy environment for older adults. Environmental lighting is a vehicle that can alter and modify the information content of the visual field and consequently impact the behavior and sensation of well-being (Flynn et al., 1973). According to the literature, different light patterns act as environmental cues that affect human behavior and impressions in some noticeable and similar ways. Lighting design for elderly settings, however, has not received much attention in environmental design research.

Illuminance, an important quantitative attribute of lighting, has been shown to have a significant impact on individuals' alertness, vitality, and task performance (Phipps-Nelson et al., 2003; Rürger et al., 2003). Figueroa et al. (2011) showed that 650 lux at the cornea was the most efficient illumination in comparison to night light providing 0.015 lux for preventing falls and injuries in older adults. Sino et al., (2010) results showed higher illuminances (>2500 lx) can provide a safer environment for older adults. There are some studies revealed there is a correlation between the low intensity of light and abnormal gait patterns and postural sway. These studies indicate elderlies have better mobility at 100 lumens in comparison to 5 lumens (Paul & Liu, 2012). Yamadera, et al (2000) indicated that 3000 lux bright light therapy from 9 to 11 am can improve circadian rhythm and cognitive state in

the early stage of Alzheimer's disease. Riemersma et al, (2008) also argued a whole-day bright light therapy (1000 lux) improves some cognitive and non-cognitive symptoms of dementia. There is firm evidence in the literature that the temporal pattern of electric light in the indoor environment that follows the same natural pattern of daylight, provides a better non-visual outcome for humans, especially for elderly people (Figueiro, 2008). Studies investigating the impact of the light spectrum on visual outcomes have mainly focused on the wavelength and CCT of light. Ellis et al. (2013) showed that full diurnal changing color spectrum and light intensity enhance psychological outcomes and improve

limited mobility. Most of the studies provide evidence that a higher level of CCT of the light source can significantly increase task performance among the elderly population. Yamagishi et al. (2008); Janosik & Marczak, (2016); Chiang et al. (2016); and Wang et al. (2020) findings revealed that elderly perform better under CCT 5000, 6500, 6000, and 6500 K respectively. Kuijsters et al. (2015) argued cozy ambient lighting with lower CCT (2700 k) and lower illuminance (120 lux) are more helpful in reducing a high arousing negative mood state (i.e., anxiety) than the neutral ambience (3400k, 150 lux) while activating ambient lighting with higher CCT (4000k) and higher illuminance (325 lux) increase the physiological arousal of sad elderly more than the neutral ambience.

Literature shows previous studies have almost addressed the gap regarding light level variables and temporal pattern, while there are not sufficient studies that investigate the qualitative aspect of lighting design such as the spatial pattern of light on older adults' mood, preference, and perception. The main goal of this study is to investigate the impact of different spatial patterns of light on the perceptions, moods, and, preferences of older adults. The research question that is specifically addressed is, "Are there any consistent and shared patterns of subjective impressions among the aging population under exposure to the different spatial patterns of light in an environment?"

1.0 LIGHT AND HUMAN OUTCOMES

1.1. Human-centric Lighting

Human-centric lighting is a new approach in the field of lighting design that not only impacts physiological outcomes such as sleep quality, alertness, and stress but also influence the occupant's impression, mood, and behavior (Boyce, P., 2016). Lighting in an environment is a consequence of four main attributes, temporal pattern (i.e., the timing and duration of exposure), light level (i.e., the quantity of light in radiometric and photometric units), light spectrum (SPD) (i.e., spectral power distribution that governs color quality), and spatial patterns (i.e., the luminance distribution of the three-dimensional light field) (Houser et al., 2020). While the first three attributes have attracted a lot of attention in the literature there is a lack of evidence as to how spatial patterns of light might impact the subjective impression perceived by the occupants.

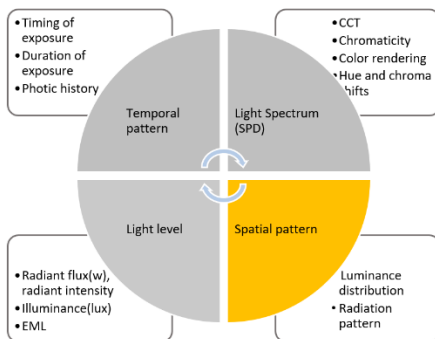

Figure 1: Human-centric lighting components according to (Houser et al., 2020)

The spatial pattern of light refers to the spatial distribution of light in the three-dimensional light field and it depends on many parameters of light and environment. The number of light resources, their spatial Arrangement, direction, and height are the four main attributes of spatial patterns that impact users' subjective impressions (Flynn et al., 1979, Castilla et al., 2018).

1.2. Spatial Light patterns and Behavioural Impressions (Flynn's Theory)

In the 1970s, John Flynn published a series of articles (Flynn & JE, F., 1977; Flynn et al., 1979; Flynn et al., 1973); conducted fundamental research about the role of the distribution of light and the resulting patterns of the light on human perception and subjective impressions. Flynn's theory indicated that changes in lighting stimulus can change human responses in terms of the impressions that are reinforced. Flynn et al. (1979) used multidimensional scaling to anticipate the impact of various lighting conditions on human responses. These scales include evaluative impressions, perceptual clarity, spatial complexity, speciousness, and formality (Figure 2). Flynn in this study used four main lighting modes to design the 6 lighting arrangements in a room and asked participants to rate the lighting modes according to multidimensional scaling (Figure 2). These four lighting modes are the basic attributes that designers consider when they are creating an environment for different purposes: bright/dim, uniform/non-uniform, central / perimeter, and warm/cool. According to Flynn's studies uniformity, centrality, and direction in the light arrangement are the three key aspects of the spatial pattern of light in an environment (Figure 2)

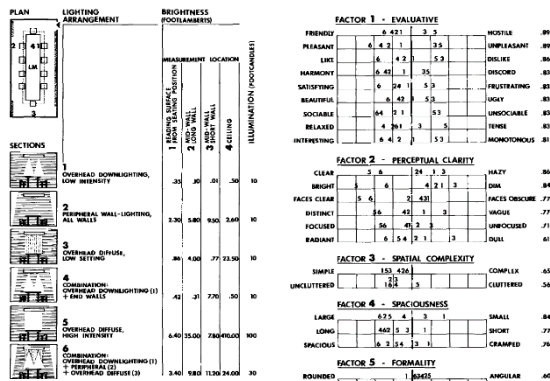

Figure 2: (left) Different spatial light patterns and Semantic Differential (SD) rating scales used in Flynn et al. (1979). (right) Spatial light patterns components (Created by Authors)

1.2.1 Uniformity

Luminaires in a space can be arranged in two different ways: Uniform and Non-uniform. In a uniform arrangement, lighting fixtures are located at a maximum height of the room with uniform spacing and without considering the furniture position in the room to illuminate the space evenly. However, in a nonuniform lighting arrangement, light fixtures are installed unequally at the highest level close to the ceiling. The positioning of each lighting fixture depends on the place of furniture, architectural elements, workstation, and the tasks that are being conducted in the space.

1.2.2 Centrality

Central lighting pattern refers to a lighting arrangement that mainly focuses on illuminating the horizontal surfaces (central, overhead), while peripheral lighting pattern will mainly focus on vertical surfaces.

1.2.3. Direction

Lighting direction is one of the critical attributes in providing different spatial patterns of light. Light in a space can be directed in different ways: Direct Lighting, Semi-Direct Lighting, General Lighting, Semi-Indirect Lighting, and Indirect Lighting. Direct lighting which is more proper for task lighting radiates 90 to 100 percent of light to the work surface. Although this type of radiation provides a brighter space, it also causes glare and unfavorable shadows. In semi-direct lighting, 60 to 90 percent of radiation reaches the working surface, while in semi-indirect lighting, 60 to 90 percent of light radiation will be directed toward the ceiling and only 30 to 40 percent of light reaches the working surface. Indirect lighting also is a type of lighting direction that 90 to 100 percent of light illuminates the ceiling and creates diffuse and even lighting in the space.

1.3. Spatial Light Patterns and Perception

“The perception Function is in charge of representing and discriminating objects based on their visual features, thus it integrates the input of visual processing with feedback from monitoring and memory systems.” (González-Casillas et al, 2018). González-Casillas, A., and his colleagues presented a model that describes the process of visual recognition and perception in the human brain. This modular modeling approach by integrating the biological and neuroscientific evidence describes the process of perception and cognition in the human brain which occurs in V1, V2, V4, and ITC. According to this Theory, the way that we perceive the surrounding environment is significantly related to the way that visual stimuli from the environment reach the retina in our eyes (González-Casillas et al, 2018).

Flynn et al. (1973) and Flynn et al. (1979) for the first time studied the impact of the spatial light pattern on different subjective impressions of humans. They found that uniform lighting provides a clearer and more understandable environment while non-uniform lighting mode reinforces a sense of relaxation. Hawkes et al. (1979) argued that brightness and interest are two main attributes of light that impact the human perception of an environment. Brightness is representing the intensity of light while interest refers to the uniformity of light in the space. In another study *Stokkermans and his colleagues explore the impact of the positioning of the light* (symmetrically, left-right, and front-back) and the number of lights on human perception of the atmosphere. They found that luminaires close to walls created a less uniform atmosphere in the space (*Stokkermans et al., 2018*). Flynn’s studies revealed that the central arrangement of light on horizontal surfaces provides more visual clarity, while peripheral uniform lightings make the space more spacious, and peripheral nonuniform lighting creates a more relaxed and private space (Flynn et al., 1973; Flynn et al., 1979). The results of a study in a university setting indicate that positioning and centrality of the light in classrooms should be modified according to the tasks and activities of students in each space because each lighting pattern might reinforce a different impression (*Castilla et al, 2018*). In another study, Fostervold and Nersveen also found that direct lighting can reduce job stress severity while there is no other correlation between the direction of light and the cognitive performance of office workers (Fostervold & Nersveen, 2008). Some evidence shows that uniform lighting reinforces the impression of spaciousness while nonuniform lighting can evoke a feeling of relaxation and improve task performance (Flynn et al., 1979; Bartholomew, R., 1975).

Previous studies also have shown that there is a more significant relationship between the direction of light and perception, satisfaction, visual health, and general visual outcomes in comparison to non-visual outcomes such as cognitive performance and productivity in office workers (Yearout & Konz, 1989; Hedge et al,1995).

1.4. Spatial Light Patterns and Visual Preference

There are not adequate research studies available that examine the impact of spatial light patterns on human visual preference. In a recent study, different affective impressions (Surprising-amazing; Clear-efficient; Cheerful-colorful; Uniform; Intense brilliant, and Warm-cozy) of university students were evaluated under different spatial patterns and luminous environments. The results show each lighting condition feat best for a specific task. For example, lighting condition with Clear-efficient, Intense-brilliant, and Uniform pattern feats are best for writing-reding tasks, while students prefer their Reflecting-discussing tasks in a lighting condition that provide a Warmer-cozier atmosphere (Castilla et al., 2018). There are some pieces of evidence in the literature indicating that people prefer indirect lighting more than direct lighting. These studies indicate that office workers prefer indirect lighting or a combination of direct and indirect lighting more than direct lighting, while the direction of light does not impact their cognitive performance and productivity (Yearout & Konz, 1989; Katzev,1992; Hedge et al,1995).

The literature shows the number of studies investigating the impact of the spatial light pattern on human perception is very limited and most of the studies have been conducted in office spaces. Therefore, there is a critical need to understand how the uniformity, centrality, and direction of light in space might impact older adults’ perceptions and preferences.

2.0 METHODS OF THE STUDY

While in most studies lighting evaluations are based on detailed photometric measures, this kind of assessment does not consider the role of the “human” component in lighting quality. For the first time, Flynn (1973) tested the usefulness of subjective qualitative assessment in lighting research to study the impact of various lighting decisions on human subjective impressions. This study used the survey method and questionnaire data to extend the results of Flynn et al (1973) by investigating the impact of different spatial patterns of light based on the same lighting modes on older adults’ perceptions and preferences. The survey design utilizes the q-sort technique to evaluate occupants’ preferences and behavioral attitudes. Q-methodology is an inverted technique of factor analysis (R-method), this technique is a scientific approach in human subjectivity studies (Stephenson, W, 1953).

2.1. Research Design

In this study, we simulated six different lighting spatial patterns that provided various visual characters without changing the physical attributes of the room. The q-sort technique was used to test older adults’ attitudes towards six different lighting scenes of living spaces (A, B, C, D, E, F) of assisted living facilities. These lighting scenes were simulated according to a proposed spatial pattern framework that was designed by the authors in a previous study (Golshany& Elzeyadi, 2022). After a comprehensive content analysis, the most common typologies of assisted living facilities’ living rooms were identified and modified according to an assisted living facility in Eugene, Oregon. Six main spatial patterns of light according to Flynn’s theory (Flynn et al, 1979) were implemented in this typology of room in Autodesk 3ds Max software, while light intensity and spectrum were controlled to eliminate some of the fundamental confounding variables (Figure 3). Each lighting scene is a combination of different lighting modes including Image A (Uniform, Central, Direct), Image B (Uniform, Peripheral, Indirect), Image C (Uniform, Central, Indirect), image D (Nonuniform, Peripheral, Direct/indirect), image E (Nonuniform, Peripheral, Indirect), and image F (Nonuniform, Central/Peripheral, Direct/indirect).











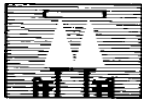
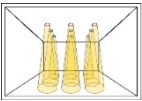

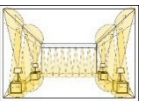
	Spatial pattern framework	The final lighting design scenes	Flynn’s lighting modes	Spatial pattern framework	The final lighting design scenes
Uniform, Central, Direct 		A 	Nonuniform, Peripheral, Direct/indirect 		D 
Uniform, Peripheral, Indirect 		B 	Nonuniform, Peripheral, Indirect 		E 
Uniform, Central, Indirect 		C 	Nonuniform, Central/Peripheral, Direct/indirect 		F 

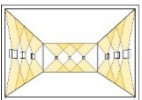
Figure 3: Different lighting design senses were used in the online survey simulated based on Flynn et al (1979) (Created by Authors).

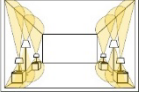
2.2. participants

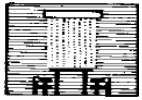
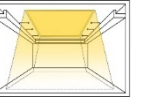
Following an IRB-approved protocol, participants for the experiment were recruited through an in-person presentation to residents of an assisted Senior living facility in US PNW. The facility has 176 residents who are living in independent and assisted living spaces. A total number of 74 residents aged 60 to 90 and above participated in the survey. Only 60 participants (39 female, 21 male) were eligible to answer the survey question according to their mental, physical, and visual condition. The researcher met the interested participants in the facility and instructed the participants regarding the details of the study and asked them to approve and sign the informed consent form.

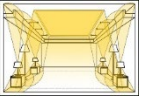
Participants were asked to rate their cognitive performance, physical health, mental health, and visual condition in questions that were administered using a 5-point response scale (poor, fair, good, very good, excellent). Exclusion criteria were any evidence of moderate to major cognitive impairment, blindness or severe eye disease, severe depression and agitation, and physical impairment. Participants who had poor conditions in any of these criteria were excluded from the study and were not able to continue the survey questions. At the end of the survey, participants could elect to write their names to enter into a separate drawing for one of the three \$25 Amazon gift cards. The entry into this drawing did not compromise their anonymity and is not linked to their responses in any possible way.

2.3. Study Setting

The participants answered the Q-sort test questions through Laptops that were provided by the researcher. The screen brightness for all the participants was set at the highest intensity to allow better visibility. Participants were seated in the living room of the facility when answering the survey questions (Figure 4).



Figure 4: Older adults answering the online surveys in the living room of the assisted living facility (Golshany & Elzeyadi, 2022)

The room's lighting condition was set to a similar condition for all the participants. A qualitative multiple-sorting task technique (Q-sort) was used to assess the visual perception and preference of the participants. The online Q-sort test includes familiar-looking pictures of interior spaces which have been simulated based on 6 spatial patterns. In a question regarding stress, the participants were asked to categorize the images into 3 main groups including most, least, and moderate stressful images, and then ranked them in each category according to the level of stress they are perceiving in each environment. Another Q-sort question that assessed the visual preference of the participants asked the participants to categorize and rank the images in 3 categories including the most, least, and moderately preferred lighting scene (Figure 5)



Instruction:

- Drag the lighting environment represented in **letters (A, B, C, ...)** from left to the box on right.
- The box on right represents your **preference level** of 6 lighting environments.
- you can only put **two lighting environments** in each category.
- Once you sort them, please **rank them in order**.

Items	Most preferred	Moderate preferred	Least preferred
Image A			
Image B			
Image C			
Image D			
Image E			
Image F			

Figure 5: Q-sort question assessing the visual preference of the participants (Golshany & Elzeyadi, 2022)

3.0 RESULTS

3.1. Visual preference

Questionnaire data from the 60 participants were analyzed to investigate differences in visual preference and the correlation between spatial light patterns and the visual preference of older adults among the 6 spatial light patterns. The differences were investigated using box plots, and the Friedman test, whereas the relationships were examined using Kendall's coefficients.

The Friedman test, an extension of the Wilcoxon signed rank test, is a nonparametric alternative to repeated measures ANOVA is appropriate for more than two correlated sample designs that are not normally distributed (Zimmerman & Zumbo, 1993). The result of the analysis indicates that there is a significant effect of the type of spatial pattern of light on the people's visual preference for the different lighting scenes (P=.004). The Size of the effect is 0.058 which is relatively a small effect size (0.2= small effect size, 0.5= Medium, 0.8= Large). (Table 1)

Table 1: Summary of related samples Kendall's coefficient for visual preference

Summary	
Total N	60
Kendall's W	.058
Test Statistic	17.377
Degree Of Freedom	5
Asymptotic Sig.(2-sided test)	.004

The mean ranks represent the average of the ranks for all observations within each sample. By comparing the mean rank between different lighting patterns, it is evident that participants preferred B over C, C over D, D over F, F over A, and A over E (Figure 6).

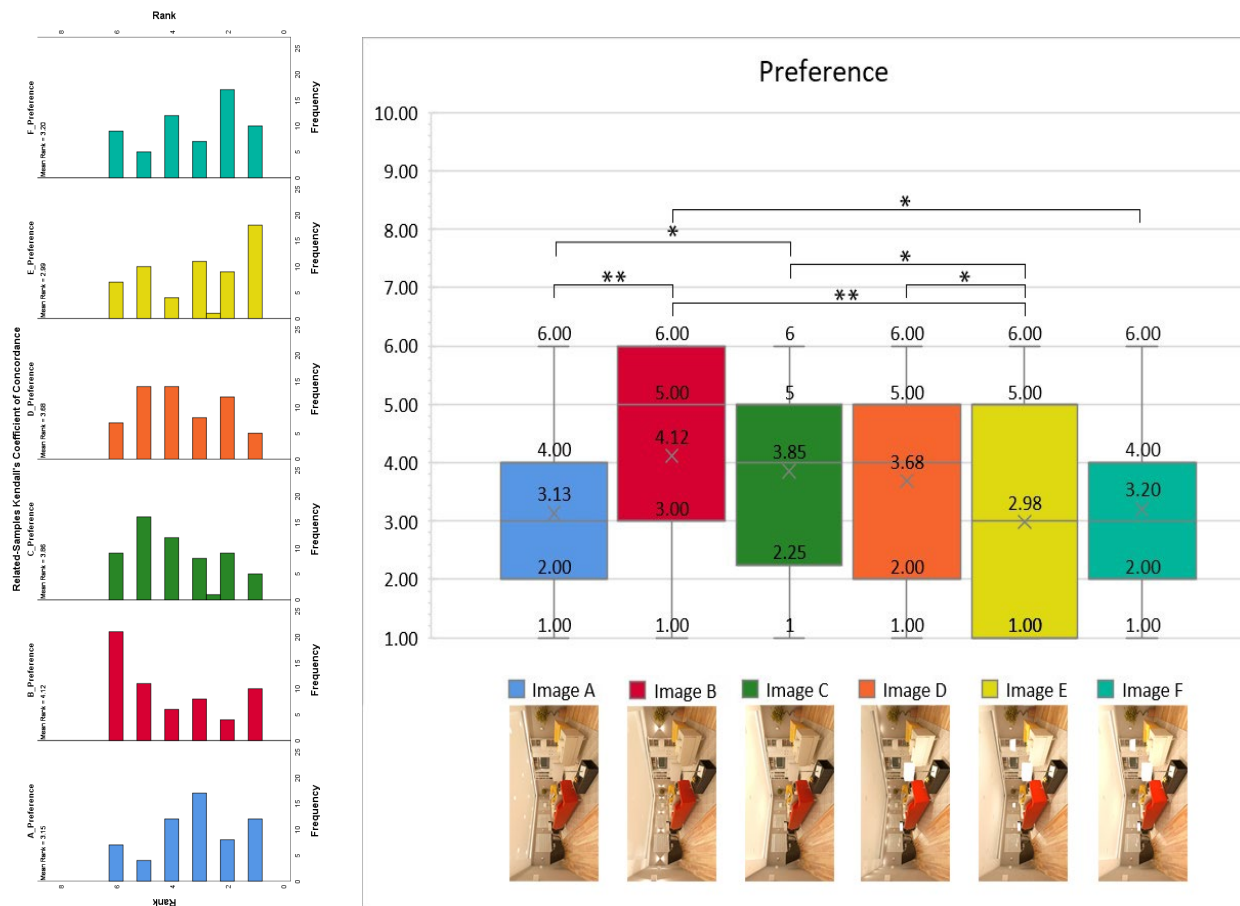

Figure 6: The Friedman test results of visual preference (* represents p<0.05, ** represents p<0.01) (Created by Authors).

To better understand if there are any significant differences in visual preference between different lighting patterns we also conducted a pairwise comparison. The results indicate that there is a statistically significant difference between D and E, C and E, B and E, C and A, B and A, and B and F (D>E, C>E, B>E, C>A, B>A, B>F)

This comparison reveals that older adults prefer uniform over nonuniform, and indirect over direct while there is no significant difference between the peripheral and central arrangement in older adults' visual preference.

3.2 Stressfulness

Data were analyzed to compare the stressfulness of the various light patterns. To examine the differences in stressfulness among the different lighting patterns, the Friedman test was used, as a Shapiro-Wilk test confirmed that the data are not normally distributed. The result of the analysis indicates that there is a significant effect of the type of spatial pattern of light on the relaxation or stress level that people perceive in the environment (P=.000). The Size of the effect is 0.126 which is relatively a small effect size (0.2= small effect size, 0.5= Medium, 0.8= Large). (Table 2)

Table 2: Summary of related samples Kendall's coefficient for stressfulness

Summary

Total N	60
Kendall's W	.126
Test Statistic	37.738
Degree Of Freedom	5
Asymptotic Sig.(2-sided test)	.000

The mean rank comparison indicates that C is the most stressful pattern while E is the least stressful pattern for the older adult participants (C>A>B>F>D>E). The analysis indicates that patterns E (Nonuniform, peripheral, indirect) and D (Nonuniform, Peripheral, Direct/indirect) are significantly less stressful than patterns A, C, and B. C pattern (Uniform, central, indirect) is the most stressful pattern among all lighting patterns and it is significantly more stressful than F, D, and E patterns with 0.01, 0.000, and 0.000 P values respectively. The results indicate that relaxation implies non-uniform lighting while uniformity in the spatial pattern of light contributes to a more stressful impression in the environment. It also shows that having more peripheral light, especially on the walls induces a sense of relaxation in the environment (Figure 7).

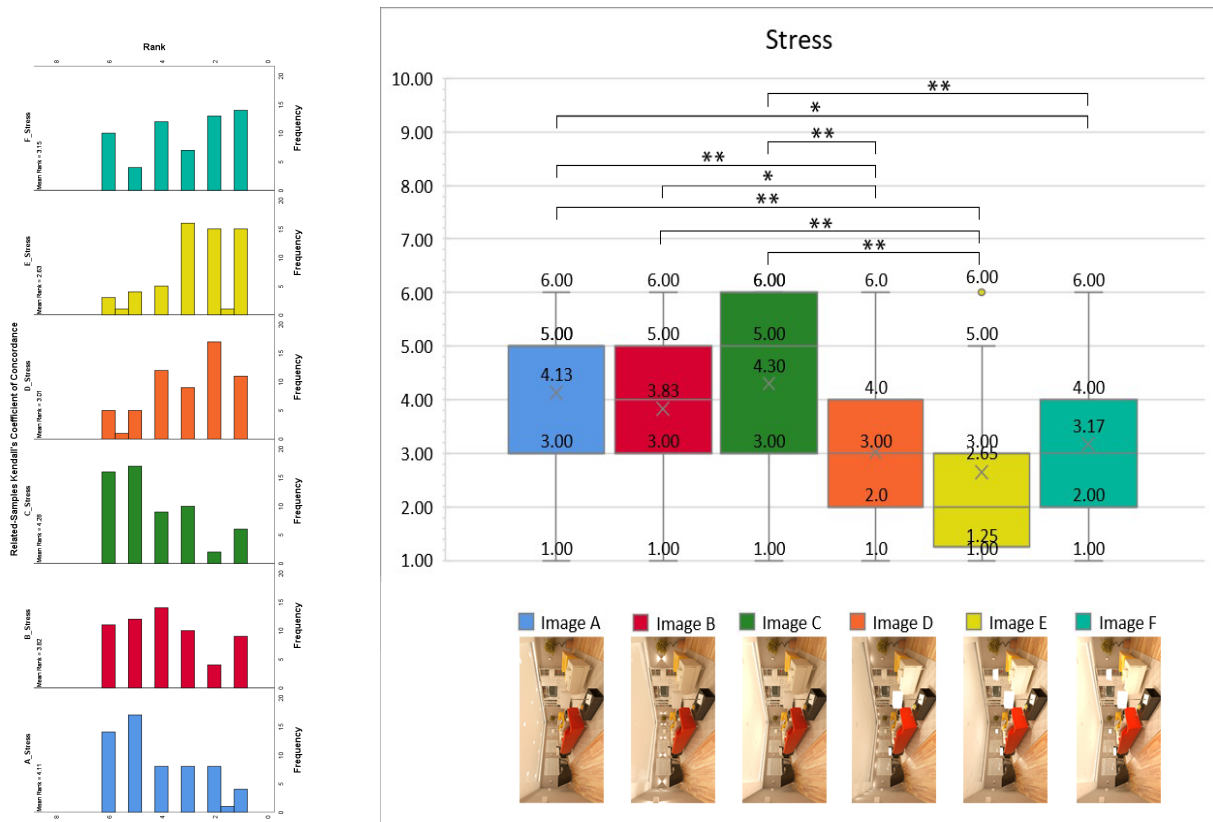

Figure 7: The Friedman test results of Stressfulness (* represents p<0.05, ** represents p<0.01) (Created by Authors).

CONCLUSION

This study is an important first step toward understanding the impact of spatial patterns of light on older adult residents' performance. To address this question, we first needed to look into the relationship between lighting patterns and human perception. To do so this study defined six different lighting patterns with different lighting positioning and we showed these lighting patterns to older residents of assisted living facilities to explore how these lighting might impact their perception of the environment in terms of their preferences and stress level.

It was hypothesized that the experience of that lighting scene is to some extent a shared experience between different occupants who had a similar perception of the environment. Furthermore, this paper tends to sustain Flynn's theory on the aging population that lighting can act as a vehicle that impacts the information data of the visual field and also alter mood, behavior, well-being, and subjective impression.

The findings of this study revealed that different spatial patterns of light can significantly impact older adults' impression of the environment including visual preference and stress level. We found that adults prefer uniform lighting over nonuniform lighting, and indirect light over direct light while there were no significant differences between the peripheral and central arrangement in older adults' visual preference. The other significant finding of this study was that non-uniform lighting causes a more relaxed impression while uniform lighting increases the sense of stress that people perceive in an environment. The results also indicated that more peripheral lighting especially on the walls reinforces a sense of relaxation in the environment. This study also had some limitations. First of all, the sampling size of the study is very small (60 participants) which makes it harder to generalize the finding. In addition, only 30 percent of assisted living facility population are men while women make up 70% of the population. This imbalance of population also impacted our sampling in the experiment (39 females and 21 males). Another limitation of this study is that obtaining depth information from images with complex scenes presented on a laptop screen is a challenging task for the aging population. This problem might be solved by taking advantage of virtual reality (VR) technology that provides this opportunity for older adults to obtain depth information by being immersed in the virtual environment.

The findings seem to encourage further work to not only investigate the impact of lighting patterns on other older adults' outcomes such as cognitive performance but also to conduct the experiment in a situation where human outcomes measurements are more objective and practical. The finding of this study can be combined with the results of previous studies regarding the light level, light spectrum, and temporal patterns of light to provide a more integrative framework of lighting design in assisted living facilities for providing a healthier and more efficient environment.

REFERENCES

- Bartholomew, R. (1975). Lighting in the classroom.
- Birren, J. E. (1959). Handbook of aging and the individual.
- Boyce, P. (2016). Exploring human-centric lighting.
- Brawley, L. R., Jung, M. E., & Glazebrook, K. (2006). Physical activity and mental health. *Active Living Coalitions for Older Adults Research Update*, 11, 1-7.
- Castilla, N., Llinares, C., Bisegna, F., & Blanca-Giménez, V. (2018). Affective evaluation of the luminous environment in university classrooms. *Journal of Environmental Psychology*, 58, 52-62.
- Chiang, C. H., Gong, S. J., Zhan, T. S., Cheng, K. C., & Chu, S. Y. (2016). White light-emitting diodes with high color rendering index and tunable color temperature fabricated using separated phosphor layer structure. *IEEE Electron Device Letters*, 37(7), 898-901.
- Ellis, E. V., Gonzalez, E. W., Kratzer, D. A., McEachron, D. L., & Yeutter, G. (2013). Auto-tuning daylight with LEDs: Sustainable lighting for health and wellbeing. In *ARCC conference repository*.
- Figueiro, M. G., Plitnick, B., Rea, M. S., Gras, L. Z., & Rea, M. S. (2011). Lighting and perceptual cues: effects on gait measures of older adults at high and low risk for falls. *BMC geriatrics*, 11(1), 1-10.
- Flynn, J. E., & F., J. E. (1977). A study of subjective responses to low energy and nonuniform lighting systems.
- Flynn, J. E., Hendrick, C., Spencer, T., & Martyniuk, O. (1979). A guide to methodology procedures for measuring subjective impressions in lighting. *Journal of the Illuminating Engineering Society*, 8(2), 95-110.
- Flynn, J. E., Spencer, T. J., Martyniuk, O., & Hendrick, C. (1973). Interim study of procedures for investigating the effect of light on impression and behavior. *Journal of the Illuminating Engineering Society*, 3(1), 87-94.
- Fostervold, K. I., & Nersveen, J. (2008). Proportions of direct and indirect indoor lighting—The effect on health, well-being and cognitive performance of office workers. *Lighting Research & Technology*, 40(3), 175-200.
- Golshany, N., Elzeyadi, E., (2022). Exploring the Impacts of Human-Centric Lighting Spatial Patterns on Elderly Residents Cognitive Performance – A Meta-Analysis, Architectural Research Centers Consortium (ARCC), Miami, Florida.
- González-Casillas, A., Parra, L., Martín, L., Avila-Contreras, C., Ramirez-Pedraza, R., Vargas, N., ... & Ramos, F. (2018). Towards a model of visual recognition based on neurosciences. *Procedia computer science*, 145, 214-231.
- Hedge, A., Sims Jr, W. R., & Becker, F. D. (1995). Effects of lensed-indirect and parabolic lighting on the satisfaction, visual health, and productivity of office workers. *Ergonomics*, 38(2), 260-290.
- Houser, K. W., Boyce, P. R., Zeitzer, J. M., & Herf, M. (2020). Human-centric lighting: Myth, magic, or metaphor. *Lighting Research & Technology*, 1477153520958448.
- Hofman, M. A., & Swaab, D. F. (2006). Living by the clock: the circadian pacemaker in older people. *Aging research reviews*, 5(1), 33-51.
- Kuijsters, A., Redi, J., de Ruyter, B., & Heynderickx, I. (2015). Lighting to make you feel better: Improving the mood of elderly people with affective ambiance. *PLoS one*, 10(7), e0132732.

- Janosik, E., & Marczak, W. (2016). The effect of warm and cool lighting on visual performance of elderly workers. *Zeszyty Naukowe Politechniki Poznańskiej. Organizacja i Zarządzanie*, (70), 51-67.
- Lu, X., Park, N. K., & Ahrentzen, S. (2019). Lighting effects on older adults' visual and nonvisual performance: A systematic review. *Journal of Housing for the Elderly*, 33(3), 298-324.
- Makino, K., Makizako, H., Doi, T., Tsutsumimoto, K., Hotta, R., Nakakubo, S., ... & Shimada, H. (2017). Fear of falling and gait parameters in older adults with and without fall history. *Geriatrics & gerontology international*
- Murman, D. L. (2015, August). The impact of age on cognition. In *Seminars in hearing* (Vol. 36, No. 03, pp. 111-121). Thieme Medical Publishers.
- Paul, S., & Liu, Y. (2012). Inadequate light levels and their effect on falls and daily activities of community dwelling older adults: a review of literature. *New Zealand Journal of Occupational Therapy*, 59(2), 39-42.
- Phipps-Nelson, J., Redman, J. R., Schlangen, L. J., & Rajaratnam, S. M. (2009). Blue light exposure reduces objective measures of sleepiness during prolonged nighttime performance testing. *Chronobiology International*, 26(5), 891-912.
- Regnier, V. (2003). *Design for assisted living: Guidelines for housing the physically and mentally frail*. John Wiley & Sons.
- Riemersma-van Der Lek, R. F., Swaab, D. F., Twisk, J., Hol, E. M., Hoogendijk, W. J., & Van Someren, E. J. (2008). Effect of bright light and melatonin on cognitive and noncognitive function in elderly residents of group care facilities: a randomized controlled trial. *Jama*, 299(22), 2642-2655.
- Rüger, M., Gordijn, M. C., Beersma, D. G., de Vries, B., & Daan, S. (2003). Acute and phase-shifting effects of ocular and extraocular light in human circadian physiology. *Journal of biological rhythms*, 18(5), 409-419
- Stokkermans, M., Vogels, I. M. L. C., de Kort, Y., & Heynderickx, I. (2018). Relation between the perceived atmosphere of a lit environment and perceptual attributes of light. *Lighting Research & Technology*, 50(8), 1164-1178.
- Stephenson, W. (1953). The study of behavior; Q-technique and its methodology.
- Yamadera, H., Ito, T., Suzuki, H., Asayama, K., Ito, R., & Endo, S. (2000). Effects of bright light on cognitive and sleep-wake (circadian) rhythm disturbances in Alzheimer-type dementia. *Psychiatry and Clinical Neurosciences*, 54(3), 352-353.
- Wang, A., Duncan, S. E., Whalley, N. W., & O'Keefe, S. F. (2020). Interaction effect of LED color temperatures and light-protective additive packaging on photo-oxidation in milk displayed in retail dairy case. *Food chemistry*, 323, 126699.
- Yamagishi, M., Yamaba, K., Kubo, C., Nokura, K., & Nagata, M. (2008). Effects of LED lighting characteristics on visual performance of elderly people. *Gerontechnology*, 7(2), 243.
- Yearout, R., & Konz, S. (1989). Visual display unit workstation lighting. *International Journal of Industrial Ergonomics*, 3, 265-273.
- Zimmerman, D. W., & Zumbo, B. D. (1993). The relative power of the Wilcoxon test, the Friedman test, and repeated-measures ANOVA on ranks. *The Journal of Experimental Education*, 62(1), 75-86.

The Impact of Space Function and Window View on Perceived Indoor Environmental Quality and Privacy

Anupam Satumane¹, Siobhan Rockcastle¹

¹Baker Lighting Lab, University of Oregon, Eugene, OR

ABSTRACT: Windows in the built environment serve many important functions like ventilation, daylight, views, and a connection to the outdoor environment. They also benefit the health and wellbeing of building users by providing relief from monotony, boredom, claustrophobia, and stress recovery. The impacts of view type and view quality on building occupants have been well documented. Views to natural environments are more desirable than urban environments while providing faster stress recovery. Although windows provide a wide range of benefits to building users, they also create an opportunity for visual intrusion, resulting in a threat to user's privacy. To maintain the desired level of privacy, users are known to operate window shading devices, resulting in the partial or complete loss of access to daylight and views. Precedent studies have identified space function as a strong variable that affects building users need and perception of privacy. Therefore, it is critical to study the influence of space function and view content on a users' perception of privacy and their preference towards obstruction or connection to the outdoors. This study uses an online survey with computer-generated panoramic images of virtual architectural spaces and subjective questions to investigate the influence of environmental variables such as space function and view type on perceptions of privacy, relative importance of view, and view preference. A total of four images were presented to a sample of 150 participants, the images were created to reflect two space function variables 'Hotel room' and 'Waiting room' and two view variables 'Forest' and 'Urban'. The results demonstrate that space function has a statistically significant impact on the perceived importance for privacy. Furthermore, participants agreed that Forest views were preferable to Urban views, but the degree of consensus was impacted by space use type, revealing the importance of considering space function and privacy needs in view-preference studies.

KEYWORDS: View Preference, Occupant satisfaction, Perceived privacy, Window views, Space function

INTRODUCTION

Traditionally, windows in the built environment have provided building users with ventilation, daylight, views, and a connection to the outdoor environment; therefore, directly influencing their health and wellbeing (Farley and Veitch 2001). Precedent studies have found daylight to be beneficial to the emotional, psychological, and physiological health of building users (Boubekri, Hull, and Boyer 1991). Whereas, access to views of nature provide psychological and social benefits (Tregenza and Wilson, 2013; Waite-Chuah, 2012) such as a reduction in perceived claustrophobia, monotony, and boredom. Windows also provide opportunities for a change in focus (Collins 1975). A study investigating the effects of windowless environments on work attitudes found the absence of windows in the workplace to be directly related to job dissatisfaction, perception of isolation, depression, tension, and claustrophobia in employees (Finnegan and Solomon, 1981; Sundstrom, Sundstrom, and Eric, 1986). Daylight also impacts the non-visual systems in humans (Veitch et al, 2004; Veitch, 2001), with exposure helping to regulate the circadian cycle. The periodic exposure to light and dark are essential to entraining circadian rhythms (Rosenthal and Sack, n.d.) and are necessary for the health and wellbeing of individuals. This evidence highlights the importance of windows; the access they provide to daylight and views; which in turn influence the psychological health, physiological health, and satisfaction of building occupants.

The building occupant's desire for views and its influences on human behavior have been widely investigated (Talbot and Kaplan, 1991; Tang and Brown 2006; Collins, 1975; Aries, Veitch, and Newsham, 2010; Collins, 1976; Ulrich, 1984; Veitch et al., 2001). When compared to windowless environments, precedent studies have found that spaces with windows are generally preferred regardless of view quality and occupants still prefer some degree of connection to the outdoors (Collins 1975). Views and visual access to the outdoor environment provide occupants with important information about the weather and time of day (Collins 1975); with views to natural environments being more desirable and efficient at providing stress recovery than urban scenes (Heerwagen and Heerwagen, 1986; Ulrich, 1979, 1981; Ulrich and Simons, 1986; Ulrich et al. 1991).

Building users often manipulate window blinds to control the amount of sunlight that enters a space, prevent glare, and/or to mediate thermal comfort. However, precedent studies have found the desire for view can increase an occupant's tolerance of visual and thermal discomfort (Chauvel et al., 1982; Tuaycharoen and Tregenza, 2007; Inoue et al., 1988; Inkarojrit, 2005). While it is widely accepted that building occupants value windows for their access to daylight and view (Inoue et al., 1988; Inkarojrit, 2005), the visual intrusions that it comes with can compromise an occupant's perception of privacy, especially in spaces where anonymity is preferred. The concept of 'privacy' is fundamental in society and has been identified as a basic human need (Doyal 1997) and yet, past research has discussed the difficulty in providing a universal definition of the word (Karst, 1967; Schuster, 1976, 1976b; Burgoon,

1982; Bauer, 1994), as the concept is complex, dynamic and has a wide range of factors affecting it. Altman (1975) defines privacy as an achieved end state or an ideal end state which provides the perfect level of interaction with others. This can be further classified into 'desired privacy' and 'achieved privacy'.

'Desired privacy' is defined as the ideal state that offers the desired level of interaction with others based on the contact preferred at any point in time (Leino-Kilpi et al. 2001). Whereas 'achieved privacy' is defined as the real degree of contact that is a product of interaction with others (Leino-Kilpi et al. 2001). The 'desired privacy' of a building occupant is therefore a product of 'individual preference' and 'space function'. On the other hand, 'achieved privacy' is a product of internal factors such as the number of people occupying the space and external factors such as visual connection to the outdoors. Intuition suggests that for any given space, when the 'desired privacy' of occupant does not match the 'achieved privacy' of the environment, it can negatively impact occupant satisfaction. View and privacy must therefore work together to achieve occupant satisfaction.

This paper builds on the research by Satumane and Rockcastle (2021), which investigated the factors that influence building occupant's preferred window shading type and degree of occlusion. That study revealed a significant relationship between space function and occlusion preference, which suggests that a building occupant's desire for privacy can mediate their desire for view. This paper expands that work to explore the impact of space use on ratings of privacy and view quality.

1.0 RESEARCH METHODOLOGY

This study uses an online survey (through Qualtrics) with computer-generated panoramic images of virtual architectural spaces to ask subjective questions about the influence of space function and window view content on perceptions of privacy and view quality. Participants (n=150) were recruited on campus using posters and announcement within large lectures. The participants could access the survey using a QR code. After completing the survey, participants were compensated with a \$5 Amazon gift code which was emailed to their @oregon.edu address. No personally identifiable information was recorded. This study was approved by the Institutional Review Board (IRB) of the University of Oregon. Spaces were digitally modelled to represent two different space functions: a typical 'Hotel room' and a typical 'Waiting room' and two different window view types 'Forest view' and 'Urban view'. The two space functions were selected to represent two levels of expected privacy, high-privacy for the 'Hotel room' and low-privacy for the 'Waiting room' as seen in figure 1. The degree of privacy was derived from the typical occupancy of the two spaces, the Hotel room is designed for an occupancy ranging from 1-2 closely related individuals, whereas the Waiting room is designed for an occupancy ranging from 1-6 unrelated individuals.

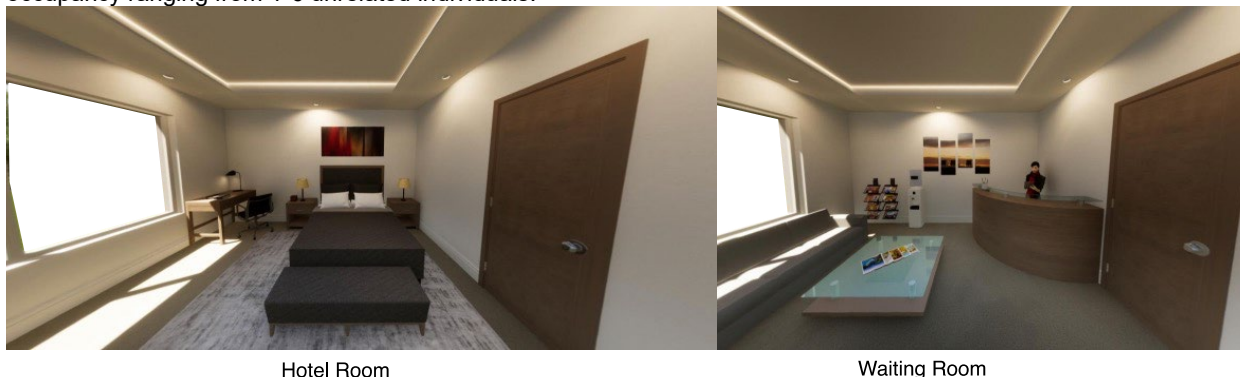

Figure 1: Space function variables: virtual indoor environments representing a 'Hotel room' and 'Waiting room'. Source: Authors

Each space (Hotel and Waiting room) was then rendered with one of two window views, one of an 'Urban view' and one of a 'Forest view' as seen in figure 2. The 'Urban view' was designed to represent a moderately dense urban environment, with a view of a wooden bench, planter box, sidewalks, and people (standing/walking) in the foreground and a road with buildings in the background. The 'Forest view' was designed with a view of a wooden bench, and planter box in the foreground and a lawn surrounded by a dense tree cover in the background. The immediate foreground of the view was kept consistent between both view types with the wooden bench and planter box seen in both view types. Although, both views were designed to have consistent intermediary layer proportions between the foreground, background and sky, they were not designed to be 'high quality' views.



Figure 2: Outdoor view variables: Window views representing a typical 'Forest view' and 'Urban view'. Source: Authors

Four panoramic images were then created (1) Hotel room with a Forest view (2) Hotel room with an Urban view (3) Waiting room with a Forest view (4) Waiting room with an Urban view. The survey introduced each image on a separate page with a text description of the space function as follows:

1. *Waiting room:* A typical Waiting room where people wait for their appointments. Often occupied by 2 to 4 people and a receptionist.
2. *Hotel room:* A typical Hotel room with an attached bath that you would occupy for a short duration of time. Typically used by the hotel guest.

The participants were then asked to share their level of agreement to 3 statements about the virtual scene while viewing the image and text description using a 5-point Likert scale:

- (1) Considering the function of the space, 'Privacy from the outdoors is important'.
- (2) Considering the function of the space, 'Having a view is important'
- (3) 'I find the view to be desirable',

The Likert scale associated with each statement ranged from 1 to 5 (1=strongly disagree, 2= disagree, 3= Neutral, 4= agree and 5= strongly agree). The word 'Neutral' was selected to represent the midpoint of the Likert scale as it efficiently indicates that the participant doesn't agree or disagree with the presented statement. This process was repeated for the remaining three images (presented in random order to avoid order bias). After data collection, the data was first examined to determine if it was normally distributed. The test of normalcy was done to decide the right statistical tests to be used to prove/disprove the various hypotheses. As the data was found to be non-normally distributed the Wilcoxon signed-rank test for paired samples was selected to do the comparative statistical analysis. In addition to the results from the Wilcoxon signed-rank test, box and whisker plots were used to examine the distribution of the participants responses.

2.0 DATA ANALYSIS

2.1 Importance of privacy in relation to space function

To understand how an occupant's perception of privacy is affected by space function, we first present the results of question 1 ('Considering the function of this space, privacy from the outdoors is important'). Occupant responses were recorded using a 5-point bipolar Likert scale and then converted to a numerical 'Privacy Score' (PS), where 1 indicated a low level of importance for privacy and 5 indicated a high level of importance for privacy. The PS values were then grouped according to space function and the distribution of PS values were plotted as in figure 3.

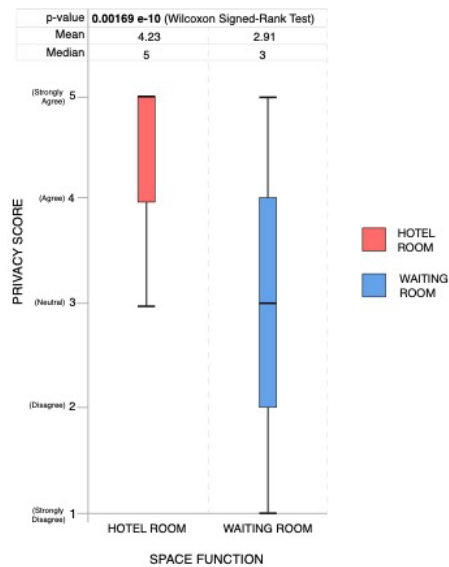

Figure 3: Privacy Score (PS) distribution for Hotel room and Waiting room space functions and Wilcoxon Signed-Rank test results. Source: Authors

The analysis in figure 3 reveals that the PS for Hotel room are tightly distributed in comparison to the Waiting room which is more widely distributed; which is indicative of greater consensus for the importance of privacy in Hotel rooms than Waiting rooms. The high PS of 4.23 indicates that privacy from the outdoors was considered very important in Hotel rooms, whereas the low PS of 2.91 indicates less importance for privacy in the Waiting room. This evidence demonstrates the strong influence of space function on an occupant's perceived importance of privacy. It also reveals the degree of privacy expected by people in building spaces differ based on space function and is an important factor that needs to be considered in the design of indoor environments.

To understand the statistical difference between the PS distributions for both the space functions a Wilcoxon signed-rank test for paired samples were done to test the null hypothesis: that the medians of the two samples are equal. The results disproved the null hypothesis with a p-value of $0.00169 e^{-10}$ which indicates that there is a significant statistical difference in the PS of Hotel room and Waiting room. The statistically significant difference in PS for Hotel room and Waiting room clearly demonstrates the strong influence of space function on the occupant's perception of privacy. The higher PS for the space function with a 'high privacy' requirement and the lower PS for the space function with the 'low privacy' requirement validates the initial hypothesis that occupants desire higher levels of privacy in Hotel room and lower levels of privacy in Waiting room, regardless of view content.

2.2 Importance of view in relation to space function

To investigate the relationship between space function and an occupant's perceived importance of view, participants were asked to rate their agreement with question 2 (Considering the function of the space, 'Having a view is important'). Their responses were recorded using a 5-point Likert scale and then converted to a numerical 'View Score' (VS) and plotted in figure 4.

The analysis presented in figure 4 reveals that the mean VS for the Hotel room (3.92) was higher than the Waiting room (3.72). A Wilcoxon signed-rank test disproved the null hypothesis with a p-value of 0.01557, proving the significance in this difference and demonstrating the influence of space function on the perceived importance of having a view, regardless of view content.

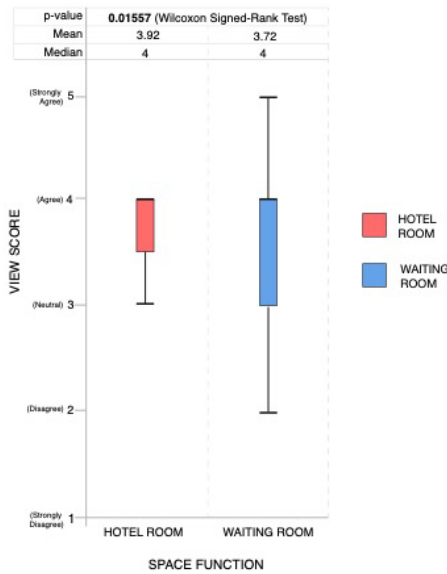

Figure 4: View Score (VS) distribution for Hotel room and Waiting room space functions and Wilcoxon Signed-Rank test results. Source: Authors

2.3 View preference between Urban and Forest view

This final section presents the responses to question 3: 'I find the view to be desirable'. Same as the previous two questions, participant responses were recorded using a 5-point Likert scale and then converted to a numerical 'View preference score' (VPS). The VPS of Hotel room and Waiting room space function were combined and regrouped based on view type and the distribution of VPS scores were plotted as seen in figure 5.

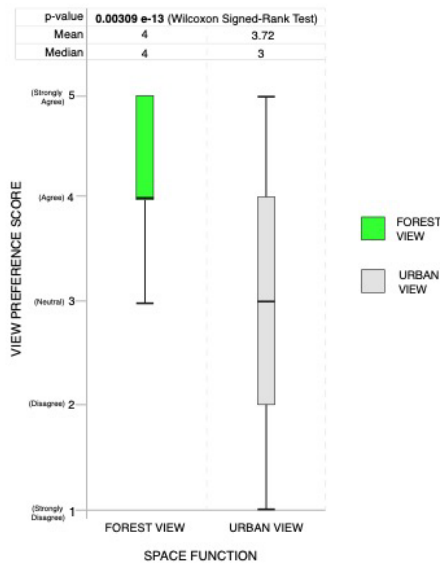

Figure 5: View Preference Score (VPS) distribution for Forest view and Urban view and Wilcoxon Signed-Rank test results. Source: Authors

A quick look at the VPS distribution of Forest view revealed that the scores are tightly distributed with an Sd of 0.83, and a mean score of 4. The high mean VPS for the Forest view suggests that participants found the Forest view desirable, and the tight distribution is indicative of the consensus between participants. Comparatively, the VPS distribution of the Urban view appears to be more widely spread with an Sd of 1.211 and a mean of 3.72. The lower mean VPS of the Urban view suggests that participants did not find it as desirable as the Forest view. A Wilcoxon signed-rank test for paired samples disproved the null hypothesis with a p-value of 0.00309 e⁻¹³ proving the significant statistical difference in the VPS between Forest view and Urban view.

2.4 View preference by space function

After the overview of view preference by view type, a deeper analysis of the VPS scores was done to identify the influence of space function on view preference. The VPS of Forest view and Urban view were separated and regrouped based on the space function. The VPS distribution of Forest view and Urban view for Hotel room and Waiting room space functions were plotted and compared as seen in figure 6.

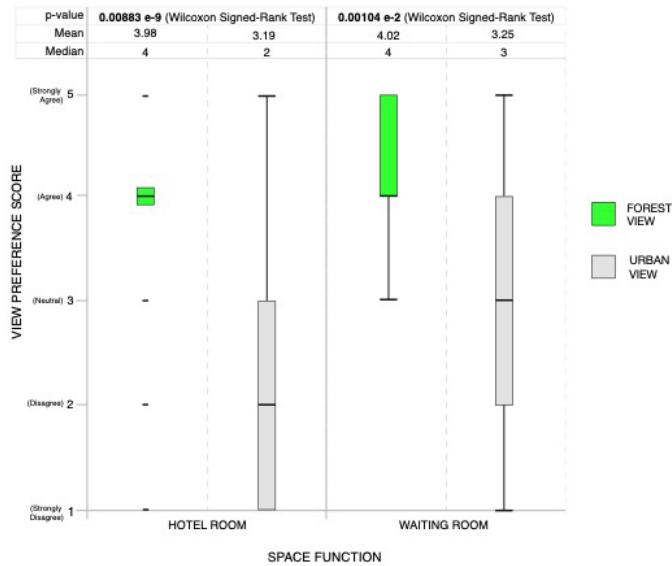

Figure 6: View Preference Score (VPS) distribution for Hotel room with Forest view, Hotel room with Urban view, Waiting room with Forest view, and Waiting room with Urban view and Wilcoxon Signed-Rank test results. Source: Authors

A quick look at the VPS distributions in figure 6 reveals that the scores for Forest view are tightly packed for Hotel room when compared to Waiting room. This difference in distributions indicates that there is greater consensus among participants about the desirability of Forest view in Hotel room than in Waiting room. Additionally, the low VPS for Urban view in Hotel room reflects their low desirability in Hotel room, however the higher VPS scores in Waiting room indicate a higher desirability for Urban views in Waiting rooms.

The VPS of Forest view and Urban view were slightly higher for Waiting room than Hotel room. This suggests that both views were considered more desirable in Waiting room than Hotel rooms. The slight increase in VPS scores for both view types in Waiting rooms could be an indication of the occupants' greater openness towards views for this space function, which is unrestricted by privacy concerns. The greater difference in VPS of Forest view and Urban view in Hotel room than Waiting room indicate that the participants favoured the Forest view over the Urban view, whereas the decrease in VPS for both view types (when compared to the Waiting room) indicates that there may be slightly less value placed on view quality for this space function. Considering all the evidence presented, the influence of space function on occupant view preference can be clearly established.

CONCLUSION

The results from this study reveal that contextual factors such as space function and view type (content) impact the way indoor environments are perceived. The first stage of data analysis revealed that participants found the importance of privacy higher in the Hotel room than in the Waiting room. This indicates that people perceive the Hotel room as a more private space and expect a certain degree of privacy from the outdoor environment. On the other hand, the Waiting room is perceived as a shared space where privacy has lower importance and there is a greater variability in the degree of privacy expected in this space. Space function as a variable was found to have a statistically significant impact on the test subject's perceived importance for privacy while also influencing the degree of privacy expected in the space.

The second stage of data analysis found that participants rated the importance of views slightly higher in Hotel room than that in Waiting room. Moreover, there was greater consensus regarding the importance of views in Hotel room than in Waiting room. Overall, space function as a variable was found to have a statistically significant impact on the participant's perceived importance for view.

The third stage of data analysis examined the subject's view preference between Urban view and Forest view. The subjects rated the Forest view to be more desirable than the Urban view, with greater consensus for the Forest view ratings than Urban view ratings. This result show that participants largely agree on Forest views being highly desirable, but, lack consensus on the desirability of Urban views. This phenomenon was examined in greater detail when the desirability of views were broken down per space function. It was generally observed that both view types received higher importance ratings in Waiting room than Hotel room which could be an indication of the occupants' greater openness towards views in the Waiting room space function where privacy concerns are low.

The findings from this study provide strong evidence to suggest that variables such as space function and view type have a direct impact on the participant's desire for view, the expectation of privacy, perceived privacy, and overall satisfaction with the indoor environment. The discrepancy between expected privacy and achieved privacy in a building space usually results in occupant dissatisfaction and the need to modify the indoor environment to achieve the desired level of privacy and view. The modifications made to the environment such as partial/complete closure of window blinds

could result in the negative impact on the occupants psychological and physiological health, restrict access to views and the connection to the outdoor environment. The existing body of knowledge has proved that window views and daylight are critical to health and wellbeing of occupants and the closure of window shading devices for the need of privacy negates their benefits. Therefore, variables such as space function and view type must be carefully considered while designing built spaces.

The results from this study also highlight the incompatibility of studying occupant view preference in isolation and urges the consideration of contextual and environmental variables in future studies. The authors acknowledge that the presence of people in the Urban view scenario may be a confounding factor while comparing the perception of privacy in-between the two types of views. However, the presence of people in the Urban view was essential to authentically represent a typical urban scene. The presence of people in the Waiting room may also be a confounding factor while comparing the perception of privacy in-between the two types of space functions. However, the presence of people in the Waiting room was needed to realistically recreate a typical Waiting room scene that is moderately occupied.

REFERENCES

- Altman, Irwin. 1975. *The environment and social behavior: privacy, personal space, territory, and crowding*.
- Aries, Myriam BC, Jennifer A. Veitch, and Guy R. Newsham. 2010. "Windows, view, and office characteristics predict physical and psychological discomfort." *Journal of Environmental Psychology* 30, no. 4 (2010): 533-541.
- Bauer, I. 1994. "Patients' Privacy. *Developments in Nursing and Health Care*." Avebury. Brookfield.
- Boubekri, Mohamed, Robert B Hull, and Lester L Boyer. 1991. "Impact of Window Size and Sunlight Penetration on Office Workers' Mood and Satisfaction: A Novel Way of Assessing Sunlight." *Environment and Behavior* 23 (4): 474-93.
- Burgoon, Judee K. 1982. "Privacy and communication." *Annals of the International Communication Association* 6, no. 1 (1982): 206-249.
- Chauvel, P., J. B. Collins, R. Dogniaux, and J. Longmore. 1982. "Glare from windows: current views of the problem." *Lighting Research & Technology* 14, no. 1 (1982): 31-46.
- Collins, Belinda L. 1976. "Review of the psychological reaction to windows." *Lighting Research & Technology* 8, no. 2 (1976): 80-88.
- Collins, Belinda Lowenhaupt. 1975. "Windows and People: A Literature Survey: Psychological Reaction to Environments with and without Windows."
- Doyal, Len. 1997. "Human need and the right of patients to privacy." *J. Contemp. Health L. & Pol'y* 14 (1997): 1.
- Farley, Kelly MJ, and Jennifer Ann Veitch. 2001. *A Room with a View: A Review of Windows on Work and Well-Being*. Institute for Research in Construction, National Research Council Canada.
- Finnegan, Mary C, and Linda Zener Solomon. 1981. "Work Attitudes in Windowed vs. Windowless Environments." *The Journal of Social Psychology* 115 (2): 291-92.
- Heerwagen, J. H., and D. R. Heerwagen. 1986. "Lighting and psychological comfort." *Lighting Design and Application* 16, no. 4 (1986): 47-51.
- Inkarojrit, Vorapat. 2005. *Balancing comfort: occupants' control of window blinds in private offices*. University of California, Berkeley.
- Inoue, T., T. Kawase, T. Ibamoto, S. Takakusa, and Y. Matsuo. 1988. "The development of an optimal control system for window shading devices based on investigations in office buildings." *ASHRAE transactions* 94 (1988): 1034-1049.
- Karst, Kenneth L. 1967. "Privacy and Freedom Book Reviews." *Cornell Law Review* 53 (4): 744-46.
- Leino-Kilpi, H., M. Välimäki, T. Dassen, M. Gasull, C. Lemonidou, A. Scott, and M. Arndt. 2001. "Privacy: A Review of the Literature." *International Journal of Nursing Studies* 38 (6): 663-71.
- Rosenthal, N. E., and D. A. Sack. 1985. "Carpenter, CJ, Parry, BL, Mendelson." *WB, and Wehr, TA. Antidepressant effects of light in seasonal affective disorder. American Journal of Psychiatry* 142: 163-170.
- Satumane, Anupam, and Siobhan Rockcastle. 2021. "A Pilot Study on the Contextual and Environmental Factors Influencing Window Shading Preference."
- Schuster, E. A. 1976. "Privacy and the Hospitalization Experience." *Communicating Nursing Research* 7 (January): 153-71.
- Schuster, Eleanor A. 1976. "Privacy, the patient and hospitalization." *Social Science & Medicine* (1967) 10, no. 5 (1976): 245-248.
- Sundstrom, Eric, Mary Graehl Sundstrom, and Sundstrom Eric. 1986. *Work places: The psychology of the physical environment in offices and factories*.
- Talbot, Janet Frey, and Rachel Kaplan. 1991. "The benefits of nearby nature for elderly apartment residents." *The International Journal of Aging and Human Development* 33, no. 2 (1991): 119-130.
- Tang, Joyce W., and Robert D. Brown. 2006. "The effect of viewing a landscape on physiological health of elderly women." *Journal of Housing for the Elderly* 19, no. 3-4 (2006): 187-202.
- Tregenza, Peter, and Michael Wilson. 2013. *Daylighting: Architecture and Lighting Design*. Routledge.
- Tuaycharoen, N., and P. R. Tregenza. 2007. "View and discomfort glare from windows." *Lighting Research & Technology* 39, no. 2 (2007): 185-200.
- Ulrich, Roger S. 1981. "Natural versus urban scenes: Some psychophysiological effects." *Environment and behavior* 13, no. 5 (1981): 523-556.
- Ulrich, Roger S. 1984. "View through a window may influence recovery from surgery." *Science* 224, no. 4647 (1984): 420-421.

- Ulrich, Roger S. 1979. "Visual landscapes and psychological well-being." *Landscape research* 4, no. 1 (1979): 17-23.
- Ulrich, Roger S., and Robert F. Simons. 1986. "Recovery from stress during exposure to everyday outdoor environments." In *Proceedings of EDRA*, vol. 17, pp. 115-122.
- Ulrich, Roger S., Robert F. Simons, Barbara D. Losito, Evelyn Fiorito, Mark A. Miles, and Michael Zelson. 1991. "Stress recovery during exposure to natural and urban environments." *Journal of environmental psychology* 11, no. 3 (1991): 201-230.
- Veitch, J. A., G. Van den Beld, G. Brainard, and J. E. Roberts. 2004. "Ocular lighting effects on human physiology and behaviour." CIE Publication 158 (2004).
- Veitch, Jennifer A. 2001. "Lighting quality contributions from biopsychological processes." *Journal of the Illuminating Engineering Society* 30, no. 1 (2001): 3-16.
- Waite-Chuah, Sheila. 2012. "Living in the Comfort Zone: At What Cost?" *Sustainability: The Journal of Record* 5 (6): 386-90.

The Influence of Birth Room Spatial Qualities on Staff Behaviors and their Association with Women's Satisfaction Using Mixed Research Method

Rafah Altaweli¹, Pravin Bhiwapurkar¹

¹University of Cincinnati, Cincinnati, OH

ABSTRACT: Space Syntax (SS) is a research program investigating the relationship between human societies and space through the lens of a structural system theory. The growth in environment-behavior studies using SS in healthcare facility design has enhanced medical settings and the performance and well-being of healthcare providers. However, its impact in birth wards (BWs) and women's satisfaction is less known, especially in Saudi Arabia. Since most births occur in healthcare facilities, the configuration of the birth environment has become medicalized, supporting procedural practices that promote unnecessary interventions and hind women's control over birth. The SS uses various analyses to examine layout configurations providing spatial measures for spaces, which can predict staff behaviors, such as movement, patient visits, response time, and communication. This study answers three questions "how are labor/birth rooms (LBRs) integrated, visible, and connected to the ward system? What kind of staff behaviors do they promote? And does women's satisfaction with childbirth correlate to LBRs' spatial measures?". **METHOD:** A case study-mixed methods research was employed using SS analysis and a satisfaction questionnaire. The relationship between spatial measures and women's satisfaction was examined in three BWs in Saudi Arabia. One-way ANOVA was used to compare the women's satisfaction across hospitals, and nonparametric Kendall correlation coefficients were calculated to show the relationships between the spatial measures and satisfaction. **FINDINGS:** The research found that when women's rooms were visible, isolated, and at a shallow depth, they were more satisfied with their experiences. Significant reverse correlations between integration values with overall satisfaction, $p \leq .0001$, and satisfaction with LBR, $p \leq .0001$. Significant reverses correlations between step depths with satisfaction with services, $p \leq .0001$. Visibility value has a significant positive correlation with women's satisfaction with communication $p \leq .0001$. **CONCLUSION:** These findings propose that staff movement and room entries influenced women negatively, while fast response and communication had a positive influence.

KEYWORDS: Birth Rooms, Spatial Analysis, Space Syntax, Integration, Visibility, Step Depth, Women's Satisfaction, Healthcare and Facilities Design, Role of Research in Practice.

INTRODUCTION

Space Syntax (SS) research focuses on how human societies use space to organize themselves; understanding configured space itself, particularly its critical developmental processes and social meaning, is a related theme in SS research (Bafna 2003). According to the literature, there is a link between satisfaction with the childbirth experience and staff behavior and performance, as demonstrated by social and procedural practices (Setola et al. 2019). The most influential factors in the literature on women's satisfaction with childbirth experiences are the quality of provided care, type of care, staff visits, communication, and use of interventions (Altaweli and Bhiwapurkar 2022). These relationships, however, were not related to spatial measures or women's satisfaction. Using the SS theory and methods in other healthcare facilities, such as medical-surgical units (MSUs) and multi-bed wards, researchers discovered a link between staff behaviors like movement, entry into patient rooms, and communication and spatial configurations (Haq and Luo 2012). In MSUs, the integration value and connectivity value of public corridors positively correlate with staff and visitors' movement (Peponis, Zimring, and Choi 1990; Lu and Bozovic-Stamenovic 2009), while the mean depth of it negatively correlates with the speed of exploring spaces (Haq 1999).

Additionally, in MSUs, the visibility value of beds negatively correlates with staff movement (Seo, Choi, and Zimring 2011); integration value and visual connectivity positively correlate to staff entry to patient rooms (Hendrich et al. 2009; Heo et al. 2009); and accessibility and visibility values associate to staff communication (Trzpcuc and Martin 2010; Joseph, Wingle, and Zamani 2017). Besides, the design of wards' configuration is associated with staff efficiency and patient satisfaction- the radial layout is found to be better than the double and single-corridor designs, and the double-corridor plan is better than the single-corridor design (Lu 2010; Lu and Zimring 2012). Visibility and integration of beds correlate with patients' feeling of security, depending on their privacy preferences (Alalouch and Aspinall 2007; Alalouch, Aspinall, and Smith 2009).

Applying measures found in studying other healthcare spaces on birth spaces may improve the healthcare providers' experiences and well-being. However, it may negatively impact women's childbirth experiences, as their preferences

and expectations during childbirth differ from those of a patient (Cheyne and Duff 2019). Many researchers called for the need to use the same methodology to examine birth spaces, considering the complexity of the birth space generated from their impact on multiple users simultaneously (Shah and Setola 2019). This study is the initial step in understanding how the spatial measures of the birth environment correlate to staff behaviors and women's satisfaction with childbirth. It examines three spatial values of LBRs: integration, step depth, and visibility, and analyzes how they relate to staff movement, entry to LBRs, and communication in three sites in Jeddah, Saudi Arabia, and correlates the results to women's satisfaction.

1.0 METHOD

This paper is part of a more extensive deductively driven design of a CS-MMR that the ethical committees of the Institutional Review Board (IRB) approved at 'the University of Cincinnati, the Saudi ministry of health, and the three hospitals. The study includes qualitative interviews with mothers, a satisfaction questionnaire, and the SS analysis of the labor/birth wards. This paper only uses the SS analyses and the satisfaction questionnaire.

1.1. STUDY SETTING

This study examines the environment-behavior relationship at three representative labor/birth wards in hospitals in Jeddah, Saudi Arabia. Hospital A represents a standard of a government hospital type with 12 LBRs and offers free access to all nationals. Hospital B represents other government hospitals with 1 labor room and 7 birth rooms, and limited accessibility to citizens. Hospital C represents the private sector with 6 LBRs and offers paid services and a unique layout. In addition, the three hospitals are among the two highest birth rates in 2021 (Ministry of Health (MOH) 2021). The floor plans were collected from the management department of each hospital.

1.2. SPACE SYNTAX ANALYSES

This study uses the SS method to examine three spatial measurements of the LBRs: (1) integration value (i.e., the closeness of the LBR to all other spaces in the ward layout), (2) step depth value (i.e., number of steps depth needed to connect to LBRs from an origin point), and (3) visibility value (i.e., the visual connectivity of the LBRs from other spaces in the ward layout). The floor plan of each ward was redrawn in a simplified version using AutoCAD. The simplified floor plans were saved as DXF files containing walls and windows, while doors are excluded or left open for analysis. Then, each simplified drawing was imported separately into the SS's advanced DepthMapX software (Turner 2004; UCL Space Syntax 2022). The software was used to run the spatial analysis using "convex space", and "tile" as spatial units. The "convex space" was used for integration and step depth analysis and the "tile" used for the Visibility Graph Analysis (VGA). Each of these analyses generates numerical values, that can be extracted by hovering over a space, color-coded graphs, and table of spatial values. The visual graphs display the spatial values with a range of high and low values from warm (red) to cool (blue) colors. The numerical and visual data utilized the SS theory and the existing literature to compare the spatial values and their impact on staff behaviors.

1.3. EVALUATION OF SATISFACTION

Women were recruited using a snowballing technique that used a link and a barcode directed to the satisfaction questionnaire sent to women by healthcare providers practicing Doulas and social media platforms to recruit women who had given birth within the previous three years at one of the three hospitals examined. 86 women completed the self-administered online questionnaire, 18 from hospital A, 20 from hospital B, and 48 from hospital C. All Saudi women had experienced vaginal childbirth in one of those wards. It was important for the sample to present one culture as the environment-behavior relationship highly influenced by the culture (Rapoport 2005). The questionnaire evaluates women's satisfaction with the childbirth experience. It collects demographic information, such as age, nationality, birth type, care type, level of education, employment status, and other factors. It evaluates satisfaction through four questions: (1) How do you rate your satisfaction with the overall childbirth experience? (2) What is your evaluation of the LBR? (3) What is your evaluation of the health services provided? and (4) What is your evaluation of the efficiency of communication with the staff? Using the 10-point Likert scale, 10 being very satisfied and 0 not satisfied. Using SPSS software, a coefficient at a 95% significance interval was used for both tests; One-way ANOVA was used to compare the women's satisfaction across hospitals, and a two-tailed nonparametric Kendall correlation was employed to show the relationships between women's satisfaction (i.e., overall satisfaction, satisfaction with the physical room, services provided, and communication) and the mean spatial measures for each hospital (i.e., mean integration, mean depth, mean visibility).

2.0 FINDINGS

The findings are presented in two parts:(1) SS analyses and their predicted impact on staff behaviors, and (2) the correlation between women's satisfaction and SS measures.

2.1. SS analyses and their predicted impact on staff behaviors

This part includes three subsections. Each subsection presents one spatial analysis, comparing the spatial measures for LBRs across the three hospitals and predicting their impact on staff behaviors based on the existing literature.

2.1.1. Integration of labor/birth rooms

Across the whole sample, the integration values of LBRs range between [~ 0.75 and ~ 1.84], with a total mean value of [~ 1.26] (see Table 1). The total mean of the spatial measures is taken as the ideal comparison value. The LBRs' mean integration for hospitals A and C are smaller than the total mean recorded at [~ 1.12] and [~ 0.87], respectively. In comparison, the LBRs' mean integration is higher than the total mean in hospital B at [~ 1.74]. That indicates that LBRs at hospital B are closely connected to all other spaces in the ward layout, compared to the rooms at hospitals A and C.

Table 3: Integration values of labor/birth rooms at hospitals A, B, and C. Source: (Author 2023)

Labor/birth room	Integration value		
	Hospital A	Hospital B	Hospital C
1	~ 1.16	~ 1.77	~ 0.75
2	~ 1.16	~ 1.77	~ 0.78
3	~ 1.16	~ 1.77	~ 1.11
4	~ 1.16	~ 1.84	~ 0.90
5	~ 1.16	~ 1.67	~ 0.86
6	~ 1.16	~ 1.67	~ 0.79
7	~ 1.1	~ 1.72	-
8	~ 1.1	Labor room ~ 1.74	-
9	~ 1.1	-	-
10	~ 1.1	-	-
11	~ 1.03	-	-
12	~ 1.03	-	-
Mean integration value	~ 1.12	~ 1.74	~ 0.87

The integration of the labor/birth wards' spaces is illustrated in Figure 1 in color-coded graphs. The (red) represents the "integration core" of the layout (i.e., the top 10% of most integrating spaces)- in this study, major corridors were the "integration core" in all hospitals. Rooms that have direct access to major corridors have a higher chance of being visited by staff than other rooms in spatial configuration. Figure 1 shows that all birth rooms in hospital B have direct access to the "integration core," and thus, the rooms are highly integrated into the system. The configuration of hospitals A and C have a median space between the nearby LBRs and the major corridors, which segregates the rooms from the system.

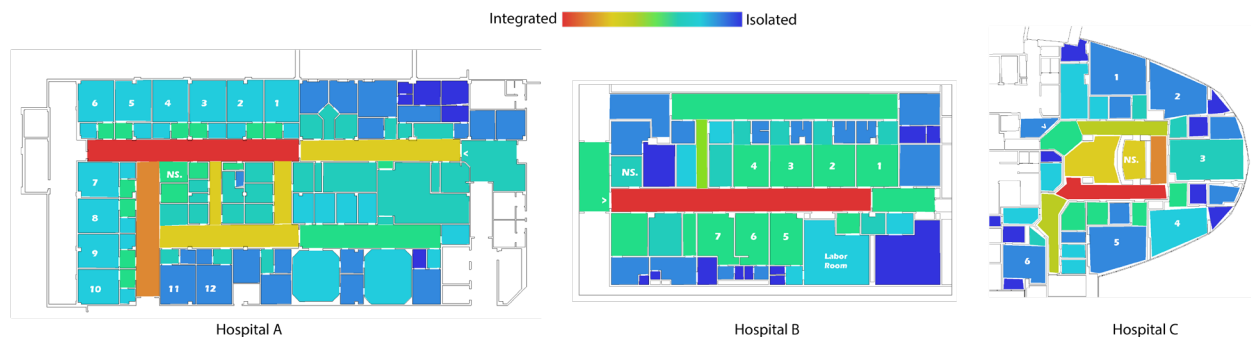

Figure 9: Color-coded graphs showing integration values of spaces within the birth/labor wards at hospitals A, B, and C, Source: (Author 2023)

The integration analysis shows that LBRs in government hospitals (i.e., hospitals A and B) in Jeddah have a lower integration value than the private hospital (i.e., hospital C). Hospitals A and B are standard double-corridor designs with/without a divider space to get to the LBRs. In contrast, hospital C is a radial design, mainly with a divider space to get to most of the LBRs. It seems that integration values of LBRs are higher in double-corridor designs with/without divider spaces. Hospital B layout, compared to hospitals A and C, is more likely to support staff movement as reported in the literature (Peponis, Zimring, and Choi 1990; Lu and Bozovic-Stamenovic 2009) while increasing the number of entries to LBRs (Hendrich et al. 2009).

2.1.2. Step depths of labor/birth rooms

Staff enter the labor/birth ward from the entry point (EP), physician's office, or nurse station (NS). This study examined the step depth to LBRs from the farthest point (i.e., EP) and the shortest point (i.e., NS). The total mean depth value of LBRs across the sample is [4.81] and [3.08] from the EP and the NS, respectively. The maximum depth from the EP was recorded at [8] steps and the minimum depth at [2] steps, while the maximum from the NS was at [4] steps and the minimum at [2] steps (Table 2).

Table 4: Step depth values of labor/birth rooms at hospitals A, B, and C/ two origin points: (EP) and (NS). Source: (Author 2023)

Labor/birth room	Hospital A		Hospital B		Hospital C	
	EP	NS	EP	NS	EP	NS
1	6	4	2	2	4	3
2	6	4	2	2	4	3
3	6	4	2	2	4	3
4	6	4	2	2	5	3
5	6	4	2	2	5	3
6	6	4	2	2	6	4
7	7	3	2	2	-	-
8	7	3	3	3	-	-
9	7	3	-	-	-	-
10	7	3	-	-	-	-
11	8	4	-	-	-	-
12	8	4	-	-	-	-
Mean step depth value	6.67	3.67	2.13	2.13	4.67	3.17

Taking the total mean depth as the value differentiates shallow system and deep system. Table 2 shows that hospital B's LBRs have a mean of [2.13] step depth from both origin points, which is lower than the total mean, indicating that the ward system is shallow at hospital B. At the same time, LBRs at hospital C have a mean value of [4.67] from the EP, which is also lower than the total mean, indicating a shallow system from the EP, while the ward system is deep from the NS with a mean value of [3.17]. In contrast, LBRs at hospital A have mean values higher than the total mean at [6.67] and [3.67] from the EP and the NS, respectively.

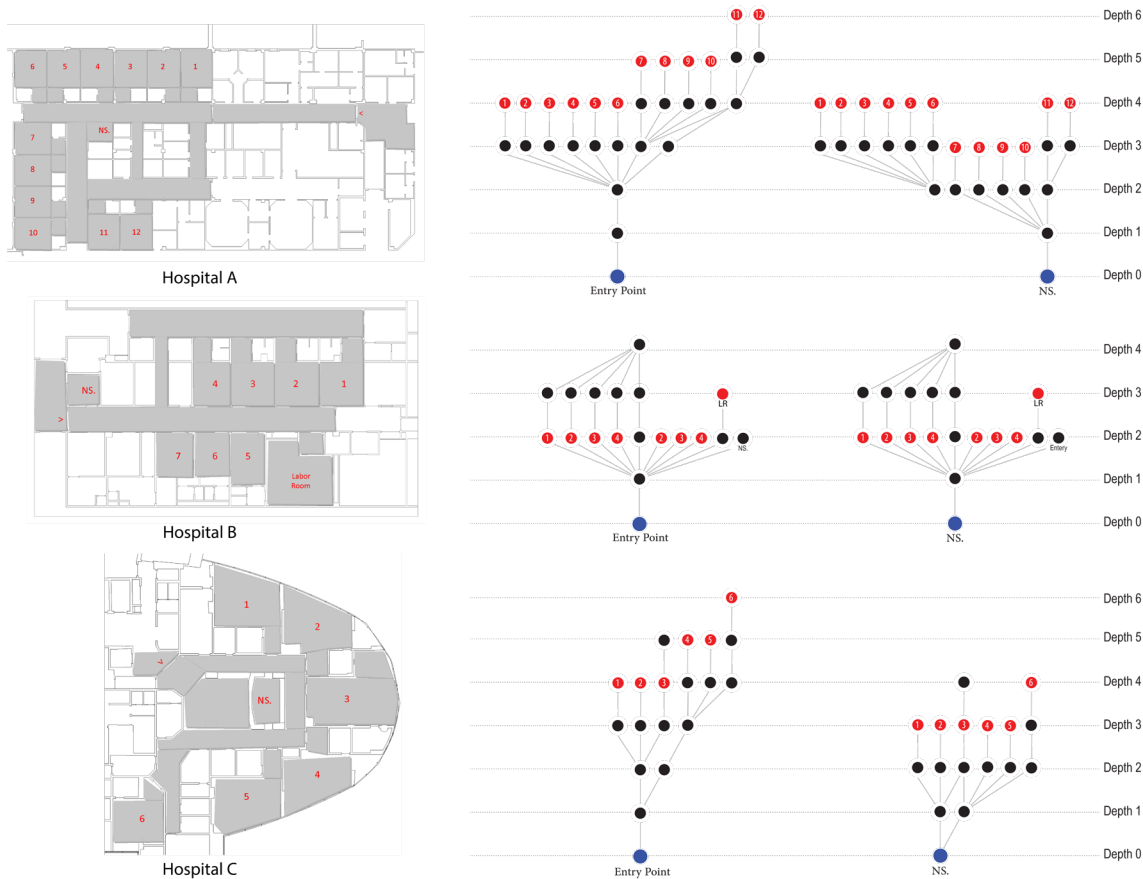

Figure 10: The step depth analysis and the justified graphs from two origin points (i.e., EP and NS) for hospitals A, B, and C. Source: (Author 2023)

Figure 2 represents the step depth of all hospitals in the form of a justified graph. Each vertical line represents a level of connection that is called "step depth." The (red) dots represent the LBRs, and the (black) dots represent the in-between spaces requiring a turn and direction change. At hospital B, all birth rooms have a secondary connection (i.e.,

[2] step depths), and the labor room has a tertiary connection (i.e., [3] step depths) from the two origin points (i.e., EP and NS). In other words, from both origin points, staff must pass two spaces to the birth rooms and three to the labor room, as shown in Figure 2. The NS at hospital A is [3] step depths connected to (4) LBRs and [4] step depths connected to (8) LBRs. At the same time, the EP is [4,5 and 6] step depths connected to (6,4 and 2) LBRs, respectively. Like hospital A and hospital C, LBRs have a tertiary connection and higher (i.e., [3 and 4] step depths) from the NS and [4, 5, and 6] step depths from the EP.

The step depth analysis shows that avoiding divider areas to LBRs and having direct access to one corridor decrease the step depth values creating a shallow system where it is easier to visit and explore all LBRs (e.g., hospital B). A shallow depth to the LBRs with low step depth values (e.g., hospital B) indicates less staff movement and more room visits (Lu and Bozovic-Stamenovic 2009; Haq 1999).

2.1.3. Visibility of labor/birth rooms

Visibility values in this study were taken from the approximate location of the beds in the LBRs, assuming doors are open. The total mean visibility value of bed locations is [284.6], with a maximum of [452] and a minimum of [216]. Table 3 shows hospitals B and C's LBRs have a mean value above the total mean recorded at [291.5] and [332.67], respectively. In comparison, LBRs at hospital A have a mean value of [229.83], which is below the total mean. This indicates that the layout of hospitals B and C provide better visual connections towards the women's birthing beds, compared to hospital A spatial configuration.

Table 5: Visibility values of labor/birth rooms at hospitals A, B, and C. Source: (Author 2023)

Labor/birth room	Visibility value		
	Hospital A	Hospital B	Hospital C
1	217	257	292
2	230	238	347
3	252	251	452
4	236	357	335
5	231	260	304
6	248	284	266
7	228	240	-
8	217	445	-
9	235	-	-
10	230	-	-
11	216	-	-
12	218	-	-
<i>Mean visibility value</i>	229.83	291.50	332.67

Figure 3 illustrates the color-coded visibility graph showing visibility distribution from high to low, ranging from warm (red) to dark (blue). Visibility means the visual connection and visual privacy of a space. Figure 3 shows that spaces with high visibility at hospitals A and B are scattered along corridors, while at hospital C the most visible areas are centered in the layout -right in front of the NS. LBRs at hospital C have the highest visibility value indicating better visual connections. Hospital B's labor room also has a high visibility value as it consists of multiple beds for women during their first stage of labor.

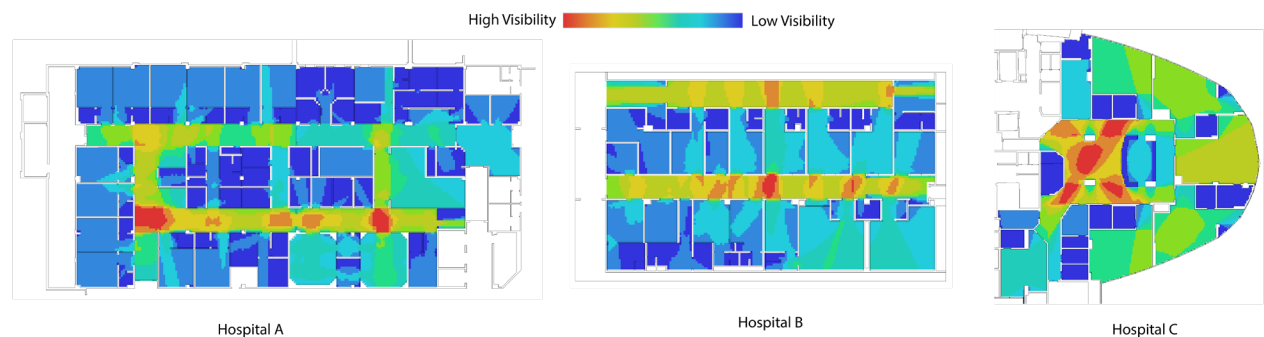

Figure 11: Color-coded graphs showing visibility values of spaces within the birth/labor wards at hospitals A, B, and C. Source: (Author 2023)

The visibility analysis shows that LBRs are more visible in a radial design compared to a double-corridor design. It also suggests that divider areas at the entry of the LBRs decrease the visual connection and increase the visual privacy of these rooms. High visibility values for the LBRs (e.g., hospitals C and B) could indicate more staff visits to LBRs (Hendrich et al. 2009; Heo et al. 2009). It also could support communication (Trzpuć and Martin 2010).

2.2. The correlation between women's satisfaction and SS measures

This part compares women's satisfaction across the three hospitals and its correlation to the spatial measures of the LBRs.

The women's satisfaction data from three hospitals are compared using one-way ANOVA. The results are presented for each of the satisfaction measures across the hospitals. A skewness measure was employed to test for the normality assumption of one-way ANOVA, which was between -.78 and -1.1. The skewness values between ±.5 are considered symmetric and normal. The values between ±1 might show moderate deviation from normality. The Levene Statistic to test for the homogeneity of variances showed that the variance for most of the dependent variables is normally distributed across the hospitals. The results are presented for each of the dependent variables.

Although there was no significant main effect of hospital type on the overall satisfaction, satisfaction with services provided, and satisfaction with communication, there was a significant main effect of hospital type on the satisfaction with LBR $F(2, 74) = 5.385, p \leq .01$. To find the differences between hospitals (simple effects), the Least Significant Difference (LSD) procedure was employed. The satisfaction with the LBR was higher in hospital C (M: 8.66, SD: 1.61) compared to hospital A (M: 7.22, SD: 2.81) and hospital B (M: 6.80, SD: 2.76) (see Figure 4).

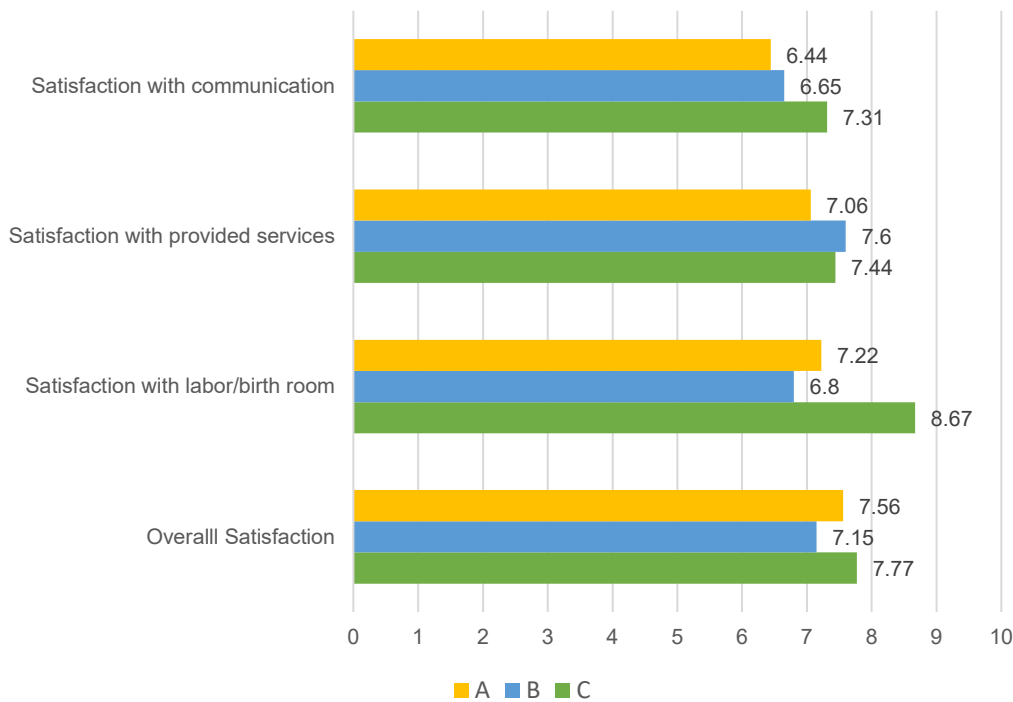

Figure 12: The means of satisfaction measures across the hospitals. Source: (Author 2023)

Independent variables include integration value, step depth value (EP), step depth value (NS), and visibility value, and dependent variables include overall satisfaction with childbirth, satisfaction with LBR, satisfaction with services provided, and satisfaction with communication, are averaged across the three hospitals. Nonparametric Kendall correlation coefficients were calculated to show the relationships between the hospital's spatial measures and childbirth satisfaction. The nonparametric correlation method was used because of the small sample size and the deviation from the normality assumption (Table 4).

Table 6: Kendall's correlation coefficients between independent variables and the satisfaction measures. Source: (Author 2023)

Variables	Overall Satisfaction	Satisfaction with labor/birth room	Satisfaction with services provided	Satisfaction with communication
Integration value	-1.000**	-1.000**	.333	-.333
Step depth value (EP)	.333	.333	-1.000**	-.333
Step depth value (NS)	.333	.333	-1.000**	-.333
Visibility value	.333	.333	.333	1.000**

As Table 4 shows, there were significant reverse correlations between the integration value with overall childbirth satisfaction, represented in Kendall's τ coefficient; $\tau(3) = -1, p \leq .0001$, and the satisfaction with LBR, $\tau(3) = -1$, 254

$p \leq .0001$. It also shows significant reverses correlations between step depth from EP and NS with satisfaction with services provided, $\text{Tau}(3) = -1$, $p \leq .0001$. Visibility value has shown a significant positive correlation only with the women's satisfaction with communication $\text{Tau}(3) = 1$, $p \leq .0001$.

3.0 DISCUSSION

The results of this study highlight that women's satisfaction with childbirth is negatively correlated to spatial measures that increase staff movement (i.e., high integration and depth values). In contrast, it is positively related to some spatial measures that speed room visits (i.e., low depth value) and enhance communication (i.e., high bed visibility). Integration of LBRs was negatively associated with women's satisfaction with childbirth experiences and, more specifically, satisfaction with the LBR. Step depth value was negatively associated with women's satisfaction with services provided. The visibility value of the LBRs' beds positively correlates with women's satisfaction with staff communication.

In healthcare facility design studies, high integration values are associated with better staff movement (Peponis, Zimring, and Choi 1990) and more staff entry to patient rooms. (Hendrich et al. 2009; Heo et al. 2009) Since staff entry significantly influences women's satisfaction with childbirth, (Altaweli and Bhiwapurkar 2022) one would expect that a positive correlation would apply in the birth space. However, this study showed an opposite correlation: LBRs positively influence women's satisfaction when segregated from other areas in the labor/birth ward. The findings of this study indicate that the privacy laboring women need in developing countries (Srivastava et al. 2015) is not necessarily visual privacy - the segregation of the LBRs provides women with privacy in the form of control over the space, (Symon et al. 2008) having fewer people entering the room and having the ability to move around. The cultural preference to cover up could also contribute to why Saudi women reported higher satisfaction levels with the service when their room was segregated from other areas in the ward layout.

Mean depth was positively related to staff movement and negatively related to staff response time. (Haq 1999) According to this study, having a lot of staff movements in the room during labor and birth reduces women's satisfaction. While a quick response time by staff, which could be encouraged by the shallow depth of LBRs, was associated with higher satisfaction with the services provided.

Some researchers have found that visibility has some association with the level of communication with staff (Trzpcuc and Martin 2010). This study confirms the relationship between the visibility of the labor/birth bed and women's satisfaction with the level of staff communication. The beds' visibility correlated with the patient's sense of security in other healthcare facilities (Alalouch and Aspinall 2007; Alalouch, Aspinall, and Smith 2009). This study also confirms this correlation in birth spaces in the Saudi culture as high visibility of the bed provides safety, and it seems to be prioritized over privacy during their childbirth experience when frequent visits seem to violate women's privacy.

The frequency of room visits influenced by high integration values was not desirable for birthing women, unlike the short response time of these visits that was encouraged by shorter depths (Haq 1999) from the EP and NS. Women's satisfaction with services correlates negatively with step depth- women are more satisfied when the LBRs are in shallow depths from EP and NS (i.e., lower step depths value), as the staff would move quickly, and response time will be shorter. Therefore, avoiding distribution areas of the LBR reduces the depth steps, thus increasing possible room visits and women's satisfaction, especially in a radial design. Therefore, a radial design without divided entries would increase women's satisfaction compared to a radial design with divided entries.

In healthcare design studies, the wards' double-corridor design was positively associated with staff efficiency and patient satisfaction. (Lu 2010; Lu and Zimring 2012) However, this study shows that, unlike patients who are in the hospital because they are unwell, the satisfaction of birthing women was positively correlated with the radial ward design with or without a divider entry area (e.g., as in hospital C).

CONCLUSION

This research is the first step toward better understanding the birth environment in isolation from other healthcare settings to improve childbirth experiences. It provided information on how the placement of LBRs within the layout of the maternity ward affects women's satisfaction, which can be used in renovation and new design. Since the environment-behavior relationship is heavily influenced by culture (Rapoport 2005), it is critical to design the birth environment to women's cultural preferences because they are the most impacted users from its physical setting (Altaweli and Bhiwapurkar 2022); thus, selecting three sites that share the same culture was critical.

Employing some spatial analyses that showed an influence on social behaviors in previous studies, such as integration, connectivity, and visibility analyses, helped identify staff behaviors at birth wards that may or may not be desirable by women at birth spaces. Therefore, this study examined the existing LBRs' spatial configuration and used the SS theory to synthesize staff behaviors while statistically correlating women's satisfaction with spatial measures. The spatial measures of LBRs influence staff movement, room visits, response time, and communication. However, these behaviors affect birthing women differently than other patients. The correlations between LBRs' spatial measures and women's satisfaction with childbirth showed that Saudi women preferred isolated LBRs closely connected to entrance and nurse stations with high bed visibility. Since culture can influence women's expectations of birth and preferences

for privacy and services, future research should include qualitative studies exploring women's preferences regarding staff behaviors, birth practices, and spatial settings.

REFERENCES

- Alalouch, Chaham, and Peter Aspinall. 2007. "Spatial Attributes of Hospital Multi-bed Wards and Preferences for Privacy." *Facilities*.
- Alalouch, Chaham, Peter Aspinall, and Harry Smith. 2009. "On Locational Preferences for Privacy in Hospital Wards." *Facilities*.
- Altaweli, Rafah, and Pravin Bhiwapurkar. 2022. "The Multi-Level Impacts of the Physical Environment on Childbirth Experience: A Critical Literature Review." In *RESILIENT CITY: Physical, Social, and Economic Perspectives*, edited by Chris Jarrett and Adil Sharag-Eldin, 675–82. The Architectural Research Centers Consortium (ARCC) in partnership with the European Association for Architectural Education (EAAE).
- Bafna, Sonit. 2003. "Space Syntax: A Brief Introduction to Its Logic and Analytical Techniques." *Environment and Behavior* 35 (1): 17–29. <https://doi.org/10.1177/0013916502238863>.
- Cheyne, Helen, and Margaret Duff. 2019. "Anatomy and Physiology of Labour and Associated Behavioural Clues." In *Squaring the Circle: Researching Normal Birth in a Technological Age*, edited by Soo Downe and Sheena Byrom, 1st ed., 32–46. London: Pinter & Martin Limited.
- Haq, Saif. 1999. "Can Space Syntax Predict Environmental Cognition."
- Haq, Saif, and Yang Luo. 2012. "Space Syntax in Healthcare Facilities Research: A Review." *HERD: Health Environments Research & Design Journal* 5 (4): 98–117.
- Hendrich, Ann, Marilyn P Chow, Sonit Bafna, Ruchi Choudhary, Yeonsook Heo, and Boguslaw A Skierczynski. 2009. "Unit-Related Factors That Affect Nursing Time with Patients: Spatial Analysis of the Time and Motion Study." *HERD: Health Environments Research & Design Journal* 2 (2): 5–20.
- Heo, Yeonsook, Ruchi Choudhary, Sonit Bafna, Ann Hendrich, and Marylyn P Chow. 2009. "A Modeling Approach for Estimating the Impact of Spatial Configuration on Nurses' Movement." In *Proceedings of the 7th International Space Syntax Symposium*, 1:41.
- Joseph, Anjali, Deborah Wingler, and Zahra Zamani. 2017. "Balancing the Human Touch with the Need for Integrating Technology in Ambulatory Surgical Environments: Barriers and Facilitators to Nursing Work and Care Team Interactions." *Journal of Interior Design* 42 (1): 39–65. <https://doi.org/10.1111/joid.12089>.
- Lu, Yi. 2010. "Measuring the Structure of Visual Fields in Nursing Units." *HERD: Health Environments Research & Design Journal* 3 (2): 48–59.
- Lu, Yi, and Ruzica Bozovic-Stamenovic. 2009. "Cultural Perspective of Wayfinding Behavior Exploring the Socio-Spatial Variable in Three Chinese Hospitals Case Studies." *ArchNet-IJAR* 3 (2).
- Lu, Yi, and Craig Zimring. 2012. "Can Intensive Care Staff See Their Patients? An Improved Visibility Analysis Methodology." *Environment and Behavior* 44 (6): 861–76.
- Ministry of Health (MOH). 2021. *Saudi Arabia Statistical Yearbook*.
- Peponis, John, Craig Zimring, and Yoon Kyung Choi. 1990. "Finding the Building in Wayfinding." *Environment and Behavior* 22 (5): 555–90.
- Rapoport, Amos. 2005. *Culture, Architecture, and Design*. Chicago: Locke Science Publishing Company.
- Seo, Hyun Bo, Young Seon Choi, and Craig Zimring. 2011. "Impact of Hospital Unit Design for Patient-Centered Care on Nurses' Behavior." *Environment and Behavior* 43 (4): 443–68. <https://doi.org/10.1177/0013916510362635>.
- Setola, Nicoletta, Eletta Naldi, Grazia Giulia Cocina, Liv Bodil Eide, Laura Iannuzzi, and Deirdre Daly. 2019. "The Impact of the Physical Environment on Intrapartum Maternity Care: Identification of Eight Crucial Building Spaces." *HERD: Health Environments Research & Design Journal* 12 (4): 67–98.
- Shah, Nell, and Nicoletta Setola. 2019. "Designing Space and Place of Birth." In *Squaring the Circle: Researching Normal Birth in a Technological Age*, edited by Soo Downe and Sheena Byrom, 1st ed., 219–30. London: Pinter & Martin Limited.
- Srivastava, Aradhana, Bilal I. Avan, Preety Rajbangshi, and Sanghita Bhattacharyya. 2015. "Determinants of Women's Satisfaction with Maternal Health Care: A Review of Literature from Developing Countries." *BMC Pregnancy and Childbirth* 15 (1): 1–12.
- Symon, Andrew, Jeanette Paul, Maggie Butchart, Val Carr, and Pat Dugard. 2008. "Maternity Unit Design Study Part 3: Environmental Comfort and Control." *British Journal of Midwifery* 16 (3): 167–72.
- Trzpcuc, Stefnee J, and Caren S Martin. 2010. "Application of Space Syntax Theory in the Study of Medical-Surgical Nursing Units in Urban Hospitals." *HERD: Health Environments Research & Design Journal* 4 (1): 34–55.
- Turner, Alasdair. 2004. "Depthmap 4 A Researcher's Handbook." <http://www.vr.ucl.ac.uk/depthmap/depthmap4.pdf>.
- UCL Space Syntax. 2022. "Building Spatial Analysis Tutorial Space Syntax – Online Training Platform." 2022. <https://www.spacesyntax.online/software-and-manuals/depthmap/building-spatial-model/>.

The Intersection of Ethics, Empathy, and Agency in Architecture Education: Using the Design Studio to Research Client Needs

Alexis Gregory¹

¹Mississippi State University, Mississippi State, MS

ABSTRACT: Architectural educators consistently straddle the line between research and design. Our responsibility is both to educate future architects and to create new knowledge with our research. My research combines both the education of future architects and the impact of the profession on the world in which we live using ethics and empathy. Now that ethics has become more important and urgent to both the professional and academic world this needs to be added to what our students are taught. Researching the extent to which empathy and ethics can be instilled in architecture education begins to pay attention to the designer, and how their knowledge, experience, and ability to use empathy and ethics impacts not only the world, but the designer themselves. This has become increasingly important not just due to the social responsibility that architects have, but also in light of the consistent concerns that have come out of the toxic nature of architecture education. Future architects who are treated poorly then mirror that behavior in their future profession to both clients and employees. This paper posits that integrating empathy and ethics into architecture education, specifically design studios, gives agency to the architecture student and builds empathy towards their clients. It instills the importance of ethics and listening to the client to produce successful architecture on many different levels. Research into the needs of the client as part of the design studio is imperative so that students can more adequately address those needs, using empathy, ethics, and agency to guide the research.

KEYWORDS: empathy, ethics, agency, design studio, education

INTRODUCTION

While considerable attention has been given to the research component, the needs of the change agent – *the designer* – has been less adequately addressed.¹ (ARCC 2022)

Architecture education has a history of high-stress studio environments, a perfectionist culture, and the disenfranchisement of female and BIPOC students. Until architecture education addresses the needs of the student, the future change agent, *the designer*, it will be impossible to teach ethics and empathy to these architects-in-training. This is necessary because the world is rapidly changing, and we must prove to the world the value of architects to help design for the future. As Sharon Sutton argues, the world will not see the value of architects if we continue to disenfranchise our female and BIPOC students and architects. (Sutton 1992) The lack of role models that reflect the wide variety of people and experiences, from BIPOC to LGBTQ people and people with disabilities, is negatively impacting architecture, especially underserved communities, which reinforces the view that architects and architecture is not a valuable part of society. (AIA 2022) Diversifying the field of architecture requires an examination of architecture education to understand why the field has not gotten more diverse and how to use ethics and empathy to help diversify architecture education and the profession.

There has been much research over the past 30 years on architecture education and the disenfranchisement of female and BIPOC students. In their 1996 article in the *Journal of Architectural Education* “Reconceptualizing Architectural Education for a More Diverse Future: Perceptions and Visions of Architectural Students” Linda Groat and Sherry Ahrentzen use research on architecture education to make recommendations on how to improve architecture education to address issues raised by architecture students at the time. (Groat and Ahrentzen 1996) The issues raised were very similar to the issues being raised by students today related to the Eurocentric white male focus of architecture education and how female and BIPOC students are treated poorly. Despite these recommendations by Groat and Ahrentzen to help the future of the profession and architecture education little has changed to address the problems the students discussed. The important research of Ernest L. Boyer and Lee D. Mitgang was also published at this time and included information on how gender and race in architecture education was a problem that needed to be addressed. They also proposed ways architecture education and the profession could improve how women and BIPOC could be engaged, but again little change has happened. (Boyer and Mitgang 1996) Boyer and Mitgang also collected data on student interest in social issues and how students felt architecture education did not incorporate or address those issues enough. Even in the early 1990s students wanted to work with their community in both their education and future careers. (Boyer and Mitgang 1996) Today students are even more engaged in social issues and want their education and the profession to use their skills to help society. The incorporation of ethics and empathy in architecture education

using service-learning and social justice will help retain students and will encourage them to stay in the profession after they graduate. A “commitment to promoting racial understanding” appeals to more diverse students and not only does this give students agency and keep them engaged in the profession, it also reinforces what Sharon Sutton noted about showing society the importance of architects in using their skills to help solve societal problems. (Vogelgesang and Astin 2007) The current student body are very optimistic on how they can help improve architecture education to also impact the profession positively and how architecture can be more ethical and empathetic in addressing topics like resiliency, environmental sustainability, collaboration, and social justice. The traditional curricula of the past is being questioned as architecture schools start to embrace social justice and more “human-centered” design that challenges the Eurocentric white male culture of architecture education. (AIA 2002)

Not only do social issues need to be incorporated into architecture education, but the Eurocentric white male model architecture education was built on needs to be deconstructed and redesigned to better incorporate the diverse ideas and history of architecture around the world. The current domination of the Eurocentric white male model encourages predatory spaces where low-income students who cannot afford such an expensive major are minimized and excluded from studio culture. This mentality that students who are limited financially and cannot afford the fastest computer or the latest software are less motivated or talented than their privileged classmates negatively impact the entire studio and disenfranchises the students who will help enrich and advance the future of architecture. (Groat and Ahrentzen 1996) Unfortunately both faculty and students reinforce this misconception and therefore incorporating ethics and empathy into architecture education can help students learn not to judge their peers, and later their future clients, based on situations they may not understand. This can also help architecture programs work to better support low-income students and first-generation students so that they can move into a more equitable place amongst their more privileged classmates. (Figure 1)

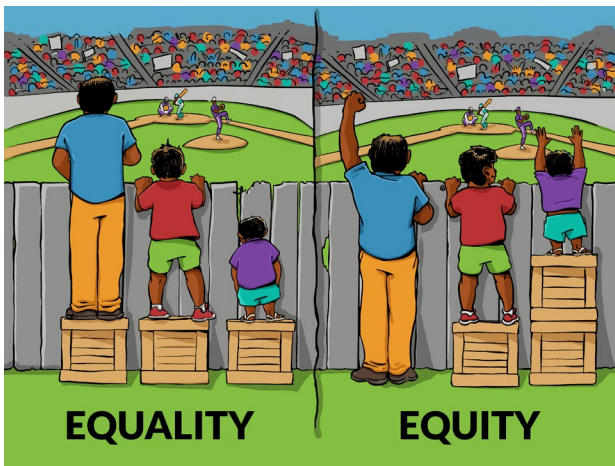

Figure 1: Equality vs. Equity. (courtesy of the Interaction Institute for Social Change | Artist: Angus Maguire)

Female and BIPOC students are also inhibited and discouraged by the toxic and inflexible environment of architecture education. (Groat and Ahrentzen 1996) Additionally, the mystery of the “Hidden Curriculum” as discussed by Thomas Dutton privileges the white male experience and Eurocentric narrative that reinforces structural racism and poverty. (Groat and Ahrentzen 1996; Dutton 1987) This creates an uncomfortable and unwelcoming atmosphere that keeps female and BIPOC students from completing their education and entering the profession. In his article “Gender and Racial Bias in Design Juries” Mark Paul Frederickson shows research supporting this unwelcoming culture by exposing how white, male classmates are treated with more deference and time than their female and BIPOC classmates. The non-white male students are given less feedback, less time to present their work, and are interrupted more by reviewers than their white, male peers. (Frederickson 1993) Because of this lower level of attention from faculty and reviewers during presentations and desk critiques BIPOC students especially feel neglected and isolated. (Dixon 1994; Frederickson 1993; Groat and Ahrentzen 1996) This unfortunately leads to a supporting of negative stereotypes that BIPOC students are not as smart and talented as their white peers. This also is reinforced when faculty do not treat students as worthy of their time which can increase the lack of confidence in students who are already being underserved. (Belluigi 2016) Confidence of students can also be impeded by a societal belief that some students are “gifted” while others are not. However, this is instead a result of students who have access to resources due to their privilege and not because they are necessarily smarter. Instead, these students are better equipped than their peers who have not had the same opportunities. (Yancy McGuire and McGuire 2015) Underserved students can be taught the same strategies and then can compete with their peers who already had that knowledge. Nevertheless, faculty still tend to believe that some students are smarter than others because of their personal experience with the “gifted” students when they were being educated throughout their lives. (Yancy McGuire and McGuire 2015) Studio then reinforces these societal biases on who is “smarter” or “better” which, in turn, is translated to the profession in the

future. This also encourages students to compete against one another and that there is one “pure” idea that is better than another making some ideas unworthy of respect or attention. (Dutton 1987)

The lack of faculty or professional mentors that look like them also impacts the confidence of BIPOC students. Furthermore, having never experienced a project or ideas in their education that they can relate to shows a lack of multicultural understanding that can hinder the confidence and agency of BIPOC students. Incorporating more multiculturalism and moving away from a Eurocentric male culture in architecture education will give more opportunities for female and BIPOC students to relate to their education and future profession. (Matthews 2002; Dutton 1987) Because diverse ideas need to be explored in architecture education faculty need to increase their cultural competency to achieve this. (Groat and Ahrentzen 1996; Ng 2019; Liao 2019; Groat 1993) Facing the white guilt that ignores and devalues the experiences and knowledge of BIPOC students and clients must be addressed and stopped to allow BIPOC students agency while increasing the cultural competency of architecture education and educators. (Miller and Harris 2018; WAI 2022) Once the cultural irrelevance of architecture and how it impacts the lives of many BIPOC students, as well as the incredibly low pay in comparison to other professions like engineering, law, and medicine, is addressed more BIPOC students will have the support of their families who currently resist their children from entering the field of architecture. (Liao 2019; Groat 1993; O'Donnell 2019) This lack of support for BIPOC students entering architecture by their families comes from the fact that there are racial disparities in household income that disadvantages BIPOC students. Black households in 2020 had a household median income lower than both Hispanic and White households (U.S. Census Bureau 2022) (Figure 2). Due to these lower median incomes many BIPOC students must work during college to afford basic necessities like housing, food, and class materials. Architecture schools tend not to take these economic issues into account when students are pressured into working more on their architecture courses, despite the needs of some students to work during school. There is a lack of understanding and empathy for these students, and they are oftentimes considered lazy because they are not able to spend as much time in studio as their faculty expect, as their more privileged classmates are able to do. (Matthews 2022; Groat and Ahrentzen 1996; Liao 1996) Also important to note is that many white architecture students have help paying for their education while BIPOC students more often must pay for those expenses on their own. (Matthews 2022) This makes the expense of architecture education for an in-state tuition for one year which can range from \$11,500 - \$21,499 cost prohibitive for many BIPOC students. This does not take into account the difference in students attending a 5-year Bachelor of Architecture program or a 4+2 Master of Architecture program, and private school tuition is even more expensive. (Liao 1996) Less merit-based financial aid and fewer scholarships as determined by universities are awarded to BIPOC students than their white peers which showcases the power institutions of higher education have over less privileged students. (WAI 2022) This privilege of having more money also segues into being able to have better portfolios with which to get a job because of access to better computers, software, and the freedom of more time to work on portfolios since there is not a need to hold a job. Unfortunately, this perpetuates a cycle of pushing less privileged students farther behind because they do not have the money or time to increase their likelihood to secure a good job upon graduation. (Matthews 2022; Liao 1996) Carla Corroto conducted research that further supports how the structure of architecture education erases female and BIPOC students in her chapter “Maintaining Their Privilege: A Framework for Assessing Minority Inclusion in Architecture Schools” in the book *20 on 20/20 Vision: Perspectives on Diversity and Design*. (Corroto 2003) Since the culture of architecture education and the culture of the profession are so related and reflected in one another this privilege is perpetuated. (AIA 2022) There is the opportunity for architecture education to positively influence the profession by educating students using ethics and empathy to reinforce the importance of collaboration and integration. (AIA 2022)

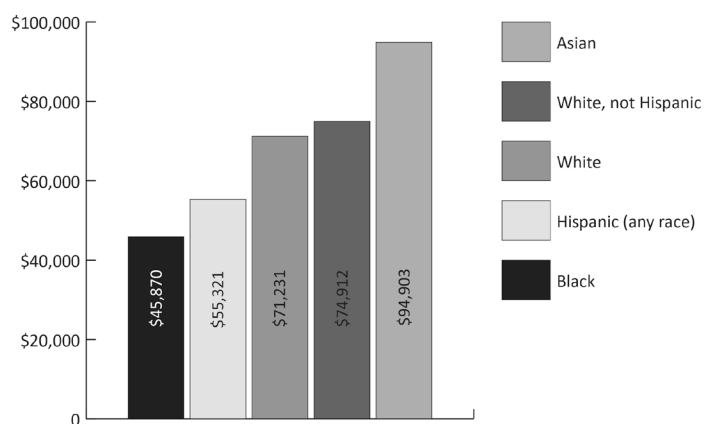

Figure 2: Median Income. (U.S. Census 2022)

This maintaining of privilege is being questioned by current students in architecture schools who think their faculty are happy with how things are and continue to teach in the way they were taught. Students are concerned that faculty who think the current educational system is sufficient to prepare students for the architectural practice of the future are not

preparing them adequately. The future profession will need to address climate change, social justice issues, and use technology to conduct this work. (AIA 2022) This is why it is so important that ethics and empathy begin to be integrated into architecture education beyond Professional Practice courses and into design studios.

Recent research by the American Institute of Architects and the production of the “Equity in Architecture Education” handbook reinforces the issues students and faculty see in the current format of architecture education. Important observations and considerations from this research support the ideas explored above:

GOVERNANCE

“Be aware of ways white supremacy is manifested.” (AIA 2022, 21)

STUDIO CULTURE

Center empathy. Offer a more human-centered focus during design studios. Balance the number of studios that are framed to result in formal geometry or technological solutions with those that place high priority on meeting social and/or human needs. (AIA 2022, 24)

FACULTY SUPPORT

Equip current faculty to continue to develop empathy with students, staff, and peers that are of different identities. Knowing that developing empathy requires encouragement, awareness, knowledge, skills, practice, and accountability. Support cross-identity mentoring. (See the *Mentorship and Sponsorship* guide.) (AIA 2022, 34)

CONSIDER

“We are all related.” Summary of a quote from a Third Year Graduate Student, Large Public PWI, American Indian (Sicangu Lakota), Female, 30 (AIA 2022, 42)

I’ve heard deans talk about how we are so stuffed with accreditation requirements, that there is no room for me to teach public-interest design to freshmen or sophomores. (Part of a quote from an Associate Professor at a Mid-Size, Public, University for 7 Years, Non-Profit Founder and Director for 30 Years, White, 60’s, He/Him/His) (AIA 2022, 46)

1.0 ETHICS AND EMPATHY IN THE DESIGN STUDIO

1.1 Methodology and Findings

Ethics in architecture education tends to be limited to professional practice courses and empathy tends not to be addressed at all. However, ethics can expand out to be integrated into design studios and empathy can be paired with ethics to engage students and give them agency in their design projects. (Fisher 2010) The author explored this by introducing empathy and ethics exercises into design studios to assist in opening the minds of students to allow them to better approach and solve issues in their future careers. These exercises included pre- and post-surveys to gauge student ideas of ethics and empathy at the beginning and end of the semester, weekly reflections asking about client interactions and topics like climate impacts and social justice in relation to the project, as well as role-playing exercises to help better understand the viewpoints of their clients. These exercises aim to prepare students and give them agency to consider on what their responses as future architects should be in reference to the challenges raised in the studio projects and how they relate to current and future challenges. The role-playing exercises came from the “Story” chapter of Daniel Pink’s book *A Whole New Mind: Why Right-Brainers Will Rule the Future* (2008). Students were asked to create protagonists, or the potential clients and users, for their projects using Pink’s exercises such as “Write a Mini-Saga”, “Riff on Opening Lines”, “Play Photo Finish”, “Ask Yourself: Who Are These People?”, and “Whip Out the Tape Recorder.” Prompted by the last three exercises specifically, students benefited by examining internalized privilege and bias. “Whip Out the Tape Recorder” was used help students get to know someone instead of assuming things about them by randomly pairing up the students to interview one another. They then used these exercises to write a short story based on what they learned about their peer’s background. This last exercise was especially important because it encourages students to empathize with others by starting to empathize with their classmates and their personal struggles.

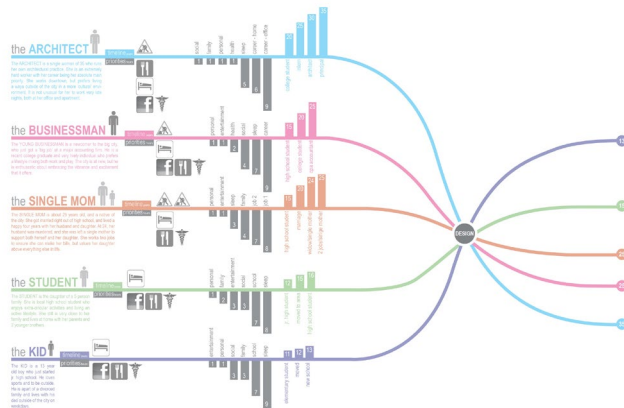

Figure 3: Protagonist Story.(Student #1)

These protagonist stories and then used as part of the conceptual design for the studio projects that allows students to design spaces for potential users they created using empathy. This information was transferred to presentation boards showing the range of users the students were considering when designing and what their needs would be (Figures 3-5). The development of the protagonists aid the students in Pallasmaa’s idea of understanding life, as discussed in “Empathetic and Embodied Imagination: Intuiting Experience and Life in Architecture.” (Pallasmaa 2015) Even imagined users, or protagonists, can help students to place themselves in the shoes of the user and use “empathetic projection” to empathize with those they are designing for. (Robinson 2015)



Figure 4: Protagonist Story.(Student #2)

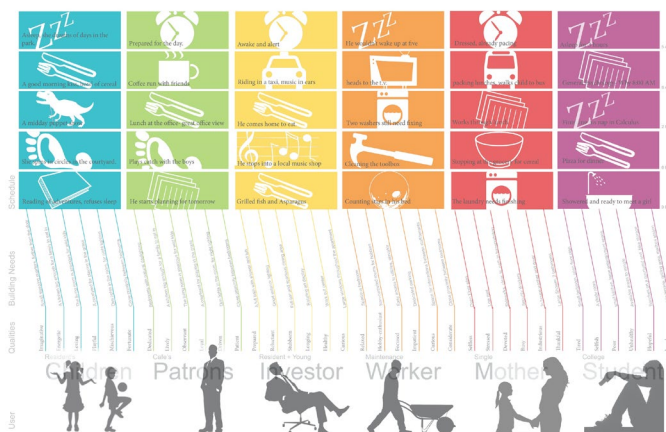

Figure 5: Protagonist Story. (Student #3)

The design studios that utilized empathy and ethics exercises were both elective studios where the students chose the topic over other topics offered, and required studios where all students worked with a community partner. The students

in the elective studios were interested in working on a service-learning project and a community partner. Therefore, they tended to be more receptive to the empathy and ethics aspects of the studios. This did not prevent the othering tendencies the students had where some felt that the studios was “giving” something to the community partner instead of working equally together. To educate students on the importance of working equally with a client like a community partner the reflections asked questions to challenge students on their views of the client-architect relationship. They were also taught about the importance of reflection and reciprocity in service-learning experiences so that they were aware of the value of the knowledge and experience community partners bring to the collaborations. The following student responses to reflection questions showcase how students begin to understand the ethical impact of working with community partners like Habitat for Humanity and the Boys and Girls Club.

Student comments praising the service-learning experience:

- I personally believe that service-learning is crucial for the architecture profession. We absolutely must learn from the communities we serve. If we do not, architecture becomes irrelevant. It becomes about create (sic) beautiful artifacts lacking contextual significance. Architecture is about spaces and individual experiences in those places.
- There is no room for the elitist views of architecture. This I feel allows us to relate architecture back to people.
- In the review we had this past Monday it was helpful to get input from (redacted). So far we were just speculating things we thought the (redacted) would need, and (redacted) thought they would be utilized well. I think moving forward with the current proposal is a good idea, yet something (redacted) stuck with me. What the children will think and how they will use it? The service-learning project allows us to effectively get feed back (sic) from our client(s) (redacted), as well as the children, be it through asking them directly or through observations, or a Post Occupancy Evaluation. Personally I think this is a great way of going about the project. Even if we were to be able to finish all the proposed work we wouldn't be able to see the full effect for quite some time. Going back to see how they use the spaces would in the end benefit me as an architect by providing me with valuable information as to how I can improve my designs for the future.

Student comments challenging the ethics of service-learning:

- I do think there is some sort of experimenting that happens, but is that a bad thing?
- I also think that the 'clients' are/should be expecting something a little different from a regular home. It is FREE. You can not (sic) argue with that.
- They are getting something that they want virtually for free. No one can argue about getting something for free. A client getting something for free is more open to ideas as opposed to a client who is paying.

Using both reflections and reciprocity made these service-learning design studios true service-learning experiences because they benefited all parties instead of just benefitting the students. The community partners gained new space for an educational garden to use for health curriculum, ideas to help fund raise and develop new housing and neighborhoods, and empowerment of the users of the projects from homeowners to children who could see the impact of architecture on their lives and communities.

Conclusion

The talent of imagining human situations is more important for an architect than the gift of fantasizing spaces. (Pallasmaa 2015)

Students want to learn how to use the skills and abilities architects have to harness empathy and design for the issues that our world is facing. However, empathy alone is not enough and should be paired with ethics to help students better understand the lived experience of others. Architects must understand life and the human form in relation to space as a part of developing empathy as examined by Pallasmaa, Mallgrave, Robinson, and Gallese in “Architecture and Empathy.” (Tidwell, 2015) Mallgrave notes that empathy allows us to be “attuned” to others using the psychological aspects of architecture. (2015) Robinson discussed the benefits of building on feeling the experience of someone else because it informs our ability to create more opportunities for actions and potential solutions to pressing issues. (2015) Additionally, Gallese observes how we experience the “other” and existence of others impacts whether we can be empathetic versus sympathetic,” which relates to understanding the human brain using the ideas raised by Mallgrave and Robinson. (2015)

Things learned from incorporating ethics and empathy in these various studios first showed that working with a community partner allows students to see the impact of their work on others. This was especially true of the underserved communities that the community partners tend to serve. Giving students agency through engaging social issues they care about and asking them what they are interested in increased their interest and commitment to the studios and community partners. Asking students to think about their own biases and backgrounds also aided in engaging the students in ways they had not been engaged before. Exercises like “Whip Out the Tape Recorder” and reflections

helped to the expectations of the students in how they should begin to think about clients for their projects by being more open-minded and trying to set their preconceived notions to the side. This also helped the students trying to set aside preconceived notions to put themselves in the shoes of the “other” to better understand the needs of their clients and the people who will experience their architectural designs.

Even though not all of the students developed empathy and an understanding of the ethics related to working with a community partner, many of them came out of the design studios with a more developed sense of ethics and empathy and the level of their privilege, or lack thereof. Many wanted to continue working with community partners as both students and future professionals. Most importantly, the students bonded with their clients and developed a strong sense of agency and ownership over the project that influenced their future development (Figures 6, and 7). Adding ethics and empathy to design studios do not just impact the students emotionally, but also academically. Students who participate in classes that include these elements are more academically engaged and successful in their studies as supported by research from Wang and Rodgers. (2006) Additionally, the othering of non-architects begins during architecture education, as Brown and Moreau Yates noted in “Seeing the World through Another Person’s Eyes”, and it is there where learning about empathy and ethics in architecture should begin. (2000)



Figure 6: Bonding with the clients' children. (Photograph by author.)



Figure 7: Playing basketball with the client. (Photograph by author.)

REFERENCES

- American Institute of Architects (AIA), “Equity in Architecture Education,” accessed November 17, 2022, <https://www.aia.org/pages/6524732-equity-in-architectural-education>.
- Architectural Research Centers Consortium (ARCC), “ARCC 2023 INTERNATIONAL CONFERENCE IN DALLAS,” accessed July 1, 2022, <http://www.arcc-arch.org/arcc-2023/>.
- Belluigi, D. “Constructions of Roles in Studio Teaching and Learning,” *The International Journal of Art & Design Education*, (2016): 35:1, 21-35, DOI: 10.1111/jade.12042.
- Boyer, E. and Mitgang, L. 1996. *Building Community: A New Future for Architecture Education and Practice*. Princeton, New Jersey: The Carnegie Foundation for the Advancement of Teaching.
- Brown, R. and Moreau-Yates, D. “Seeing the World through Another Person’s Eyes.” *Changing Architectural Education: Towards a New Professionalism*, edited by David Nicol and Simon Pilling, Spoon Press, 2000, pp. 49-57.

- Corroto, C. 2003. "Maintaining Their Privilege: A Framework for Assessing Minority Inclusion in Architecture Schools," in *20 on 20/20 Vision: Perspectives on Diversity and Design*, ed. Linda Kiisk, 102-108. Boston, MA: Boston Society of Architects.
- Dixon, J. 1994. "A White Gentleman's Profession?" *Progressive Architecture* 75 (11): 55-61.
- Dutton, T. 1987. "Design and Studio Pedagogy," *Journal of Architectural Education*, 41:1, 16-25, DOI: 10.1080/10464883.1987.10758461.
- Fisher, T. "Architecture's Ethical Moment," *Architect Magazine* 108-109, no. 11 (2019): 91-100.
- Frederickson, M. "Gender and Racial Bias in Design Juries," *Journal of Architectural Education*, 47:1, (1993): 38-48, DOI: 10.1080/10464883.1993.10734572.
- Gallese, V. "Boundaries of the Skin: John Dewey, Didier Anzieu and Architectural Possibility" in *Architecture and Empathy: A Tapio Wirkkala-Rut Bryk Design Reader*, ed. Phillip Tidwell (Finland: Tapio Wirkkala-Rut Bryk Foundation, 2015), 70.
- Groat, L. 1993. "Architecture's Resistance to Diversity: A Matter of Theory as Much as Practice," *Journal of Architectural Education*, 47:1, 3-10, DOI: 10.1080/10464883.1993.10734569.
- Groat, L. and Ahrentzen, S. 1996. "Reconceptualizing Architectural Education for a More Diverse Future: Perceptions and Visions of Architectural Students," *Journal of Architectural Education*, 49:3, 166-183, DOI: 10.1080/10464883.1996.10734679.
- Liao, A. 2019. "Practice: Increasing Diversity and Inclusion," *Architect* 108 (5): 64-72.
- Mallgrave, H. "Enculturation, Sociality, and the Built Environment" in *Architecture and Empathy: A Tapio Wirkkala-Rut Bryk Design Reader*, ed. Phillip Tidwell (Finland: Tapio Wirkkala-Rut Bryk Foundation, 2015), 33.
- Matthews, D. "A Black Architecture Education Experience," accessed January 29, 2022, <https://archinect.com/features/article/150132758/a-black-architecture-education-experience>.
- Miller, L. and Harris, V. 2018. "I Can't Be Racist – I Teach in an Urban School, and I'm a Nice White Lady!," *World Journal of Education*, 8:3, 1-11, DOI:10.5430/wje.v8n3p1.
- Ng, R. 2019. "What Will It Take?," *Journal of Architectural Education*, 73:2, 142-144, DOI: 10.1080/10464883.2019.1633189.
- O'Connell, K. "Raising the Stakes" *Architect Magazine*, November 1, 2019, accessed July 5, 2022, https://www.architectmagazine.com/aia-architect/aiafeature/raising-the-stakes_o.
- O'Donnell, K. 2019. "Why Equity Is Crucial to Your Firm's Success: The growing movement toward a more diverse profession," *Architect* 108 (8): 64-66.
- Pallasmaa, J. "Empathetic and Embodied Imagination: Intuiting Experience and Life in Architecture" in *Architecture and Empathy: A Tapio Wirkkala-Rut Bryk Design Reader*, ed. Phillip Tidwell (Finland: Tapio Wirkkala-Rut Bryk Foundation, 2015), 6.
- Pink, D. 2006. *A Whole New Mind: Why Right-Brainers Will Rule the Future*. New York, NY: Riverhead Books.
- Robinson, S. "Boundaries of the Skin: John Dewey, Didier Anzieu and Architectural Possibility" in *Architecture and Empathy: A Tapio Wirkkala-Rut Bryk Design Reader*, ed. Phillip Tidwell (Finland: Tapio Wirkkala-Rut Bryk Foundation, 2015), 48.
- Stead, N., Gusheh, M. and Rodwell, J. "Well-Being in Architectural Education: Theory-building, Reflexive Methodology, and the 'Hidden Curriculum'," *Journal of Architectural Education* 76, no. 1 (2022): 85-97.
- Sutton, S. 1992. "Power, knowledge and the art of leadership." *Progressive Architecture* 73 (5): 65-67.
- Tidwell, P. *Architecture and Empathy: A Tapio Wirkkala-Rut Bryk Design Reader*. Finland: Tapio Wirkkala-Rut Bryk Foundation, 2015.
- U.S. Census Bureau, "Table A-1. Income Summary Measures by Selected Characteristics: 2019 and 2020," accessed July 29, 2022, <https://www2.census.gov/programs-surveys/demo/tables/p60/273/tableA1.xlsx>.
- Vogelgesang, L. and Astin, A. "Comparing the Effects of Community Service and Service-Learning." *Michigan Journal of Community Service Learning* 7, no. 1 (2007): 25-34.
- WAI Architecture Think Tank, "A Manual of Anti-Racist Architecture Education," accessed January 29, 2022, https://drive.google.com/drive/folders/1yhvf_UyGFF6MPzuPf2oPLUErpcfLD6tb?usp=sharing.
- Wang, Y. and Rodgers, R. "Impact of Service-Learning and Social Justice Education on College Students' Cognitive Development." *Journal of Student Affairs Research and Practice* 43, 2 (2006): 316-37.
- Yancy McGuire, S. and McGuire, S. 2015. *Teaching Students How to Learn: Strategies You Can Incorporate Into Any Course to Improve Student Metacognition, Study Skills, and Motivation*. Sterling, Virginia: Stylus Publishing, LCC.

ENDNOTES

ⁱ Emphasis by author.

The *LivingRoom*, A Low-Cost Prototype Outdoor Classroom and Learning Garden

Benjamin L. Gunter¹ Hans C. Herrmann¹, Abbey Franovich¹, Warren C. Gallo¹, Sarah R. Lalk¹

¹Mississippi State University, Starkville, MS

ABSTRACT: While learning gardens and outdoor education have become increasingly popular throughout the last decade, there has not been a substantial increase in the research surrounding garden-based education. The existing studies about learning gardens primarily cover the benefits of garden use and the educational content typically delivered. To build better learning gardens and to have improved experiences for outdoor learning, it is important to also understand how schools physically utilize learning gardens.

This paper discusses the strengths and weaknesses of the *LivingRoom* Outdoor Classroom and Learning Garden system as a means of generating a critical comparison. The *LivingRoom* was developed through a series of collaborations between the School of Architecture and Department of Landscape Architecture at Mississippi State University. The study assesses a survey of teachers that use the *LivingRoom* system (four different use cases) to compare how learning gardens operate at a range of scales with a range of amenities. In conclusion, barriers to school garden use, and suggestions as to how the gardens may be improved are considered.

KEYWORDS: Learning by Building, Low-Cost Construction, Interdisciplinary Design, Public Health

INTRODUCTION

While learning gardens and outdoor education have become increasingly popular throughout the last decade, there has not been a substantial increase in the research surrounding garden-based education. The existing studies about learning gardens primarily cover the benefits of garden use, how teachers use the learning gardens, and what is taught in the garden. To build better learning gardens and have better experiences for outdoor learning, it is important to understand how schools use their learning gardens.

Learning gardens operate at several scales with many different amenities that provide a range of functions. Some learning gardens are large gardens, comparable to a farm or a market garden. They have many different growing methods including row crops and have plenty of amenities to help support the maintenance of the garden and to promote learning within it. Other garden programs have become successful from being small, simple, and easy to replicate. A good example of this is Big Green Project's learning gardens. The Big Green Project's learning gardens are all composed of the same benches and planters that are manufactured for it. The simplicity of the garden and the ease at which it can be duplicated has made the Big Green Project a very popular school learning garden model.

Although there is a large range of scales and amenities for learning gardens to operate at, there also exist common practices that help all gardens become successful. Funding, cooperative administration, curricula tied to state standards, willing teachers, and long-term volunteers or a full-garden coordinator all contribute to better learning gardens (Bucher, 2017). While some schools have enough support to operate a large garden, other schools may struggle to maintain a small learning garden.

The *LivingRoom* garden concept was conceptualized and initiated in 2020 by faculty and students of the Mississippi State University Department of Landscape Architecture and School of Architecture. By using simple materials and a unique design and layout, the garden seeks to reduce maintenance and to provide a flexible space for both teaching and growing. Since 2020, five gardens have been built throughout the state of Mississippi, three of which will be considered in this study and are shown in Figures. 1-3. The conceptual design approach was inspired by the Big Green Project's modular strategies in that it is easy to be recreated from a simple kit of parts. The garden features a curvilinear design and ample seating around round, galvanized, cattle troughs that have been re-adapted into planters. The organization and amenities of the *LivingRoom* learning gardens are designed to be used for a broader range of activities than just growing fruits and vegetables. The garden was designed to be used for an outdoor classroom, and to be a pleasant space for students and teachers to engage in unstructured free time.

This paper discusses the strengths and weaknesses of the *LivingRoom* learning garden by surveying the teachers and school employees that use them. By surveying schools with the *LivingRoom* learning gardens, we can see how teachers use the learning gardens, what are the barriers to school garden use, and how the gardens can be improved.



Figure 1 Galloway Elementary School LivingRoom. Photo by: (Cory Gallo 2020)



Figure 2 Partnership Middle School LivingRoom. Photo by: (Cory Gallo 2021)



Figure 3 Leland Park Middle School LivingRoom. Photo by: (Megan Bean 2022)

1.0 BACKGROUND

A substantial amount of research on the benefits children receive in nature already exists; however, there are few articles that discuss the benefits children receive by spending time in a learning garden, specifically. School gardens are being implemented at every school level. Pre-school, elementary, middle, and high school students can all benefit from learning gardens. Learning gardens are being used for a variety of purposes and to teach many different subjects. One school in California reported using their learning garden for instruction of science, mathematics, and visual and performing arts, while another school used it for nutritional education, science, and language arts (Hazzard et al, 2011).

Although gardens are used to teach a variety of different subjects, schools install them for a variety of different reasons. Kimbal Musk's Big Green Project gardens are used primarily for education, but Alice Water's learning garden at Martin Luther King Elementary is mostly to produce vegetables for nutrition education (Our History, 2021; Our Story, 2021). Teachers in Havana, Cuba installed gardens to get children involved in the community and to show them the importance of agriculture, while teachers in Philadelphia, PA installed school gardens to engage kids with natural sciences outside of the classroom. In both cases, the teachers in the study wanted to connect kids with nature and to let them develop interests on their own (Bucher, 2017).

In a study by Wagner and Fones (1999), students who were involved in a school garden program scored an average of 5.6 points higher on their science achievement test than students that did not receive any garden-based learning. Empirical evidence points repeatedly to the fact that learning gardens have a multitude of ways of adding value to a student's educational experience. Spending time in a learning garden has been shown to help children improve social skills, an emerging and critical issue post the COVID 19 pandemic. A study done by the Master Gardener Program in San Antonio found that school gardens helped children's development, parent/child/community interaction, and problem perception (Alexander, North, and Hendren, 1995). Truong, Gray, and Ward (2016) argue that through garden based-learning, students can learn how to communicate, work in groups, and interact with adults in a dynamic environment.

Furthermore, children observed in the study had almost no bad behavior. The authors go on to discuss the importance of the kids' interactions with adults within the learning garden environment. Garden-based learning can pull in many professionals and adult volunteers to interact with the children. Interacting in an informal space as opposed to a classroom is easier for children to develop both formal and informal relationships with adults. Additionally, the article also discusses that school gardens often benefit a child's self-esteem. The study observed that as the children recognized their vegetables growing and their garden project progressed to fruition, their self-esteem went up as well.

While school gardens can be very beneficial and used for many purposes, it can be very difficult to start and sustain them. A study assessing the challenges in implementing programming in school gardens identified three key problems to sustaining learning gardens: gaining support from staff, maintaining gardens – especially during the summer, and engaging parents (Burt et al, 2018). With the fifth iteration of the LivingRoom outdoor classroom and learning garden system in use, the project offers a significant test case for identifying successful and unsuccessful design, construction, and usage strategies. The ability to compare the iterations completed by the students and faculty at Mississippi State University is felt to be exceptionally helpful in identifying a regionally specific approach for other such future projects to be situated in a comparable context with similar user groups.

2.0 METHODOLOGY

A web-based survey was used and made available for a twenty-five-day period in April 2021. The survey was sent to all teachers and staff at the schools with LivingRoom learning gardens. These schools are Galloway Elementary School in Jackson, Mississippi (Figure 1), Partnership Middle School in Starkville, Mississippi (Figure 2), and Leland Park Middle School in Leland, Mississippi (Figure 3).

The survey included sixty-nine questions and took less than eight minutes to complete. Composed of four parts, the survey covered teacher demographics, garden use, garden amenity use, and overall perceptions of learning gardens. For this paper, we will only analyze the first three sections leaving the perception out of this paper. The questions were mostly yes/no questions, multiple choice, or rankings on a Likert scale. Open ended questions were kept to a minimum to make the survey easier to complete. The demographic section of the survey covered age, gender, school location, and position at the school. The garden use section asked general questions about garden use such as frequency of use, maintenance of the space, and how the space was used. The amenities section asked respondents what components of the garden were used and how effective the amenities were.

Table 1: Garden Descriptions & Usage Characteristics

Summary Chart				Example 1	Example 2
Garden	Galloway Elementary	Leland Park	Partnership Middle	Burr Elementary	MLK Middle
# of students	408	268	770	461	1,027
# of teachers	20	20	59	25	49
Area of garden (sq. ft.)	5,000	1,200	20,000	2,200	37,600
Area per students (sq. ft.)	12.25	4.47	25.97	4.77	30.61
Growing room (sq. ft.)	225	135	1,050	244	15,000
Growing room per students (sq. ft.)	0.55	0.50	1.36	.53	14.61

Seating (students)	64	50	256	25	50
Growing methods	Raised beds, Trellises	Raised beds, Trellises	Raised beds, Trellises	Raised beds	Raised beds, Row crops, Trellises, Herb and flower garden
Amenities	Storage, art, preparation table, water access, irrigation, chalk board	Storage, art, chalk board, water access	Preparation tables, water access	Pavilion, art	Greenhouse, pavilion, pond, chicken coup, kitchen, water access

3.0 RESPONSE DEMOGRAPHICS

There was an overall survey population of 99 schoolteachers and staff, and the survey had 58 responses. Only 51 responses could be used, as 7 survey responses were left incomplete by respondents who did not answer many of the questions in the survey. Of those responses, 10 are from Galloway Elementary, 33 are from Partnership Middle School, and 8 are from Leland Park Middle School. Twenty percent of the teachers are 20-30 years old, 31% are 30-40 years old, 29% are 40-50 years old, 9% are 50-60 years old, and 11% are 60-70 years old. Most survey participants (82%) are female, while 14% are male, 2% are non-binary, and 2% preferred not to say. Lastly, most of the respondents (76%) are teachers, 6% are administrators, and 18% are “other”. Respondents that answered “other” reported their positions as nurse, counselor, lead teacher/instructional coach, receptionist, and interventionist/504 coordinator (table 1).

4.0 GARDEN USE

Of the 51 respondents that took the survey, only 26 of teachers used the garden at their schools. Ninety percent of respondents from Galloway Elementary School used the garden, while only 42% of respondents from Partnership Middle School and 53% of respondents from Leland Park Middle School used the garden. Most teachers (56% overall) answered that having lesson plans associated with the gardens would make them more inclined to use them, 29% overall thought that garden training would make them use the garden more, 7% overall thought more funding would help them use the garden more, and 4% overall thought that more parental or community support would be helpful.

The LivingRoom at Galloway Elementary School is used far more than the garden at Leland Park Middle School. This could be because the garden has the most amenities, making it more useful and therefore easier to use. It could also be because it is the oldest LivingRoom learning garden and the schoolteachers and administrators have had more time to become familiar with the garden. This garden was completed in the summer of 2020 making it available for use in the early stages of the COVID 19 pandemic, a factor which may also drive numerous distinctions of usage.

Fifty-six percent of school staff that answered the survey said that lesson plans associated with the garden would assist them to use the garden more, 29% thought that garden training would help, 7% thought more funding would be helpful, and 4% wanted more community or parental consent. This confirms the study done by Hoover et al. (2021) which concluded that gardens are four times more likely to be successful if they have garden training and lesson plans available. The survey suggests that relevant lesson plans, and garden training may be more important than community support. This is significant because more studies mention lack of community support and funding as a barrier to use than lack of lesson plans or garden training for teachers.

Overall, the survey shows that teachers mostly use the garden as a space to observe and to talk about natural processes (34%) and as a space to teach a subject unrelated to the garden (29%), while only a few teachers use the garden as a space to actively grow fruits and vegetables (14%), or to take students for unstructured free time (3%). Teachers use the LivingRoom learning garden mostly for education, which aligns with the study done by Bucher (2017) that states teachers in Havana and Philadelphia use gardens to connect with and to learn about nature outside of the classroom.

At Partnership Middle School (PMS) a reason many teachers reported for not using the garden was because they thought it was only for the GROW class, a very specialized initiative within the school. This conflict between the administrations and staff is seen as a barrier to the use of learning gardens by many studies. Bucher (2017) specifies that uncooperative administrators play a large role in the dis-use of learning gardens.

Overall, 25% of PMS teachers use the LivingRoom learning garden to teach math, 25% to teach science, 15% to teach nutrition, 15% to teach history, 10% to teach English/literature and 10% to teach other subjects. These numbers are a little different than Graham and Zidenberg (2005) survey where 7% of teachers in California used learning gardens to teach science, 47% to teach nutrition, 43% to teach environmental education, 40% to teach math, and 27% to teach agricultural science. While these numbers do not align exactly, there is a trend of using the garden to mainly teach math and science related classes.

None of the respondents at Leland Park Middle School (LPMS) use the garden every day, 13% use the garden multiple times a week, 13% use the garden multiple times a month, 13% use the garden once a month, 13% use the garden a few times a term, and 50% never use the garden at all.

Fourteen percent of LPMS respondents answered that garden training would help them use the garden more, 86% of respondents thought lesson plans associated with the garden would be helpful, 0% thought more funding would be helpful, and 0% thought more community/parental support would help them use the garden more. Seventeen percent of respondents use the LivingRoom learning garden as a space to actively grow fruits and vegetables, 33% as a space to observe and talk about processes, 50% as a space to teach a subject unrelated to the garden, 0% as a space to take students for unstructured free time.

5.0 TEACHING USAGE

The LivingRoom learning garden at Galloway Elementary School seems to be the most used garden as 90% of the respondents from Galloway used the garden compared to the 42% from Partnership Middle School and 50% from Leland Park Middle School. The garden at Galloway Elementary School also has the most amenities, which makes it more conducive to a variety of learning opportunities. The art and informational graphics at Galloway were also created with education in mind, which makes it easier to organize and teach a lesson. The teachers at Galloway used the garden to teach all subjects (math, science, nutrition, English/literature, history, other). The fact that Galloway was the first garden established and is the oldest of the gardens may be one reason that it is used more than the other school gardens. The higher use of the learning garden at Galloway Elementary could also be because it is an elementary school, while the other two schools' surveys were sent to middle schools. Elementary school teachers may teach in a way that is more conducive to learning garden use.



Figure 4 Galloway Elementary School. Photo by: (Megan Bean 2019)

While the LivingRoom learning garden at Galloway Elementary School (Figure 4) has 225 square feet of garden beds with 0.55 square feet of growing room per student, only 21% of respondents use the garden to grow fruits and vegetables. The most common gardening activity that teachers perform with their class are planting, watering, and harvesting. While the round, galvanized beds work to maintain a sleek curvilinear form and to facilitate class, they may also limit the number of growing methods that can happen in the LivingRoom learning garden and may also limit the number of gardening activities and plant interactions that students can experience. This underscores the idea that the LivingRoom learning garden is more than just a garden. Most teachers at Galloway Elementary School use the garden for more than just gardening. And while the garden beds may not be the best garden beds for significant food production, their height and organization make them great for teaching.



Figure 5 Partnership Middle School (photo by Cory Gallo)

The LivingRoom learning garden at Partnership Middle School (Figure 5) has not become as successful for teaching and instruction as the garden at Galloway Elementary. Only 42% of respondents from Partnership Middle School use the learning garden. This may be because the lack of amenities and lack of administrative support. The learning garden at Partnership Middle School, while the largest in size, has the least number of amenities, compared to the other two LivingRoom learning gardens. While the gardens at Leland Park and Galloway Elementary have garden beds, benches, trellises, chalk boards and informational graphics, the garden at Partnership Middle only has garden beds, trellises, and benches, making it a less useful garden to conduct a class not pertaining to the garden.

The garden also lacks administrative support. Many teachers reported that they were told that only the sixth-grade science class (the GROW class) is the only class allowed to use the garden. Despite the lack of amenities and administrative support, teachers at Partnership Middle School use the garden to teach all subjects (math, science, nutrition, English/literature, history, other), and teachers gave positive feedback on the circular layout of the garden beds and benches that gives children good views of the garden bed.

While the LivingRoom learning garden at Partnership Middle School has the most potential for growing fruits and vegetables, hardly any of the teachers use the garden. The garden is 20,000 square feet, 1,050 square feet of which are garden beds, and there are 1.36 square feet of growing room per student (Table 1). Only 7% of survey respondents use the garden to grow fruits and vegetables. The curriculum at Partnership Middle School allows for a very even distribution of gardening activities including planting, weeding, watering, pruning, trellising, harvesting, and preparing food. While the garden at Partnership Middle School has the potential to be a great place to teach about growing fruits and vegetables, miscommunication between the administration and teachers and an inappropriate level of amenity inclusion has caused it to fall short of its potential.



Figure 6 Leland Park Middle School (photo by Megan Bean)

The LivingRoom learning garden at Leland Park Middle School shown in Figure 6 is the smallest, and newest garden. The garden is only used by half of the respondents. Half of the teachers at Leland that use the garden use it to teach about a subject that is not related to the garden and another 17% use the garden to teach about natural processes. The only subject reported being taught at Leland Park Middle is history. The garden is well equipped with a chalk board to teach, and the school administration as well as the school district's curriculum coordinator are supportive of the garden. While it seems that the Leland learning garden has ample amenities and better support than Partnership Middle School, it is not being utilized for teaching like it could. Additionally, Partnership Middle School has a class that includes the garden, while teachers at Leland have to come up with lesson plans and curricula on their own. One possible explanation is that it is located at the very back of the school where it would be very inconvenient for a teacher to take a middle school class from the front of the school to the back of the school. Another explanation is that the garden is new, and that there is no school curriculum to use for the garden, or garden training for the teachers, so many of the teachers do not know how to use the garden or are intimidated to use it.

6.0 ADDITIONAL DESIGN CONSIDERATIONS

The garden components most frequently used are the benches, planters, water access, and chalk board. The benches are one of the amenities that teachers liked the most and thought worked best in the garden. One teacher especially liked the curvilinear arrangement of the benches which facilitate a classroom atmosphere. The amenity that is used most by teachers are the benches, while the frequency of use for all other amenities varies between schools and teachers. While it was speculated that shade would be a commonly preferred amenity, when given the opportunity to suggest more amenities only one teacher asked for “shelter”.

Maintenance is another important aspect of the LivingRoom learning garden. Galloway Elementary, Partnership Middle, and Leland Park Middle all classify as “low socioeconomic” schools. This may mean that communities surrounding the schools are less likely to help the school with garden programs. Because of the potential for minimal funding or community support, it is important to note that the amenities in the garden help it function with minimal intervention. The ground surfaces at all three schools with LivingRoom learning gardens are all very durable, and do not require any maintenance. The lack of fruits and vegetables growing in the ground also greatly limits the amount of maintenance needed. Lastly, the large, raised, galvanized garden beds have irrigation and keep their aesthetic value even when overgrown.

CONCLUSION

While this study is largely inconclusive, there are some important lessons to be learned about the LivingRoom learning garden, and lessons that can be applied to all learning gardens in general. The LivingRoom learning garden provides flexibility and forgiveness through its form, amenities, and layout. Additionally, the programming and administrative support of learning school gardens is important, and one garden size does not fit all scenarios.

The LivingRoom learning garden provides teachers with a lot of flexibility. Teachers reported using the LivingRoom gardens for multiple uses (Table 1). This could be because of the garden’s form and amenities. The garden provides many amenities like benches, chalk boards, and storage to ensure that classes can do more than just grow vegetables in the space. The most notable amenity may be the benches, which allow for entire classes to be seated comfortably in the garden. This allows for good discussions about what is growing in the planters and lets teachers lead classes about discussions not related to the garden as well.

The amenities of the LivingRoom learning gardens also allow the garden to be forgiving. The space is easy to maintain with ground surfaces of asphalt, gravel, and concrete that require little maintenance. Similarly, garden beds include irrigation, making it easier to manage. Even if the space is neglected, the ground materials and raised galvanized planters, do not allow the garden to look overgrown. This is important for a garden at schools that may lack funding or community support.

Programming and administrative support are very important to a learning garden’s success. While this was already discussed in previous studies, this survey provides further evidence for this claim. The garden at the Partnership Middle School was under-used because administration discouraged teachers from using the garden. While the garden was originally intended to be used by all the school pods, the administration reportedly told teachers that only one class was supposed to be using the learning garden. While design and design intent are important, the survey suggests that unless administration is supportive, a garden will not be successful. The survey also suggests that certain programming associated with the garden, like curriculum and garden training, would also improve and increase the use of the garden for teachers.

Another lesson learned is one size does not fit all. Learning gardens can be successful at all schools if they have the correct programming and support. The Edible Schoolyard Garden is a very large garden with many amenities, and garden beds that require a lot of maintenance. However, the school has adequate school programs, and the garden is worked into the curricula well enough that it is very successful. Not all schools have the support and programming that is needed to support a large garden. Big Green Project gardens or LivingRoom learning gardens are two learning gardens that require significantly less maintenance than a garden like the Edible Schoolyard at MLK Middle. The modular gardens are set on concrete which require no maintenance and have irrigation systems built into the beds, so most of the maintenance involved in keeping up the garden is what is required to grow fruits and vegetables.

From the point of view of the design and construction team, our observations suggest the versions of the LivingRoom that are larger with multiple gathering and seating spaces and a variety of amenity types offer the best instance for learning gardens to be adopted and incorporated into regular teaching and classroom activities. As a result, the design team consults potential clients by outlining what amenities and space types the LivingRoom system can define and/or incorporate. Per the survey, seating, covered and well defined learning space(s), and amenities for storage and instruction are often highly desirable. These options have a cost associated with them so clients are asked to consider closely the activities and usage types they believe will be most necessary.

Learning gardens and outdoor classrooms, like the school buildings themselves cannot alone create learning. It is the interplay and active management of the spaces as well as programed and unprogramed but managed activities that truly make a place valuable. As designers, it is our goal to make it easy to enjoy a place and to make its use and potential undeniable whenever possible.

REFERENCES

- Alexander, J., North, M.W. and Hendren, D.K., 1995. Master gardener classroom garden project: An evaluation of the benefits to children. *Children's Environments*, pp.256-263.
- Bucher, K., 2017. Opening garden gates: Teachers making meaning of school gardens in Havana and Philadelphia. *Teaching and Teacher Education*, 63, pp.12-21.
- Burt, K.G., Burgermaster, M. and Jacquez, R., 2018. Predictors of school garden integration: Factors critical to gardening success in New York City. *Health Education & Behavior*, 45(6), pp.849-854.
- Burt, K.G., Lindel, N., Wang, J., Burgermaster, M. and Fera, J., 2019. A nationwide snapshot of the predictors of and barriers to school garden success. *Journal of Nutrition Education and Behavior*, 51(10), pp.1139-1149.
- Burt, K. and Burgermaster, M., 2017. Factors that contribute to school garden integration and success. *Journal of the Academy of Nutrition and Dietetics*, 117(10), p.A142.
- Hazzard, E.L., Moreno, E., Beall, D.L. and Zidenberg-Cherr, S., 2011. Best practices models for implementing, sustaining, and using instructional school gardens in California. *Journal of Nutrition Education and Behavior*, 43(5), pp.409-413.
- Hoover, A., Vandyousefi, S., Martin, B., Nikah, K., Cooper, M.H., Muller, A., Marty, E., Duswalt-Epstein, M., Burgermaster, M., Waugh, L. and Linkenhoker, B., 2021. Barriers, strategies, and resources to thriving school gardens. *Journal of Nutrition Education and Behavior*, 53(7), pp.591-601.
- Our History*, June 5, 2021, Retrieved from Big Green: <http://biggreen.org/about/our-history>
- Our Story*, June 6, 2021. Retrieved from Edible Schoolyard : <https://edibleschoolyard.org/about#mission>
- Wagner, L.K. and Fones, S.W., 1999. Enhancing science education experiences through garden explorations: An inquiry-based learning opportunity at the South Carolina Botanical Garden. *HortTechnology*, 9(4), pp.566-569.
- Truong, S., Gray, T. and Ward, K., 2016. " Sowing and Growing" Life Skills Through Garden-Based Learning to Reengage Disengaged Youth. *LEARNing landscapes*, 10(1), pp.361-385.

Towards an Optimal Lighting Comfort: Understanding a gender-specific indoor lighting conditions via trainee's physiological signals for optimum physical training environment

Dongwoo (Jason) Yeom¹

¹Arizona State University, Tempe, AZ

ABSTRACT: The purpose of this study is to understand the relationship between diverse indoor lighting conditions, human physiological signals, and physical training performance, and to verify the impact of indoor lighting conditions on physical training performance by gender difference. To achieve this goal, a series of human experiments were conducted to collect the participant's physiological signals in different lighting conditions, while the participant is under physical training. This study used pupil size and heart rate as the main physiological signals, and lighting and color satisfaction were surveyed as a participant's subjective response. Walking on a treadmill and hand-grip strength tests were adapted as physical training for the participants. In the experiment, the participant measured their initial heart rate, pupil size, and handgrip strength in a generic indoor lighting condition first as a control group data. Next, they were randomly assigned to one of the 8 lighting conditions, which are white, warm, blue, and red with two different lighting intensities (150 and 400 lux), and 4 male and 4 female participants were assigned per each condition. Then, they walked on a treadmill for 20 minutes, and they took a survey and measured pupil size, heart rate, and handgrip again as an experiment group data. The collected physiological signals and survey data were analyzed by multiple statistical methods, including two sample T-test and ANOVA analysis. The result demonstrated that there is a significant difference in the physical performance and physiological signals by the lighting conditions, and gender difference also affected the participant's perception of the lighting conditions as well as their physical training performance. The new findings from this study provide a new perspective on the gender difference in indoor lighting conditions for sports and it can bridge the gap between psychological and physical aspects of human activity in the indoor lighting environment.

KEYWORDS: Lighting sensation, Physiological signal, Pupil size, Heart rate, Physical training

INTRODUCTION

In the field of physical training, it was proved that the lighting intensity affects the trainee's physical training performance significantly (Drust et al. 2005). Many studies verified that the exposure to bright light can increase the alertness (Cajochen 2007; Daurat et al. 2000), and the exposure to blue light also showed similar results, such as increases of alertness (Cajochen et al. 2005; Lockley et al. 2006; Viola et al. 2008) and cognitive performance (Lehrl et al. 2007; Chellappa et al. 2011). Some studies also reported that lighting intensity affects physical training performance significantly (Kantermann et al. 2012; Knaier et al. 2017) and another study showed that there is a significant difference in preferred lighting condition between men and women for activation and relaxation (Schweitzer et al. 2016).

However, most studies were conducted on elite athletes and few studies focused on the general public and gender difference. Also, the relationship between indoor environment and human physiological responses has been studied and verified its impact on diverse human behaviors and perceptions (J. Choi, Loftness, and Aziz 2012; J.-H. Choi and Yeom 2017; Sim et al. 2016; Kim et al. 2022) in the indoor built environment domain. However, there was no study considered the combination of lighting intensity, color temperature, and color of light in sports on the indoor training environment, which limits the opportunity for better performance of the trainee as well as to create an improved training environment for the general public.

Thus, the purpose of this research is to understand the impact of indoor lighting environment on physical training performance by gender difference for the gender-specific training environment. It is important to explore the relationships between indoor lighting environment, human physiological signals, and physical performance in training, and verify its potentials of human physiological signals as a control factor to provide an optimum indoor lighting environment for specific gender.

1.0 METHODOLOGY

1.1. Experiment room and equipment

To achieve the research goal, a series of human experiments were conducted in the designated experiment space in the Design School (TDS) at Arizona State University (ASU). The experiment space was equipped with independent lighting units to change the lighting intensity, color temperature, and color of the light. The size of the experiment room

was 3.9 m (W) × 2.25 m (D) × 2.5 m (H) with one West-facing window, which was covered during the experiment to minimize potential interference by daylight. The experiment room’s HVAC system was disconnected from the building’s central system, and a portable HVAC system with two nozzles was used to maintain the indoor temperature at 22°C. To control the experimental lighting condition, a total of 12 light bulbs were installed in two rows which can control its lighting intensity, correlated color temperature (CCT), and the color of light by the remote.

Walking on a treadmill and hand-grip strength test were adapted as cardio and strength training for the participants, so a treadmill and hand dynamometer were used to measure the participant’s physical training performance. This project adapted heart rate and eye pupil size as human physiological signals. The eye tracker was used to monitor the pupil size in response to the lighting condition and a smart watch-type wearable device (E4 Wristband) was used to measure the heart rate. The indoor environmental factors, such as indoor dry bulb temperature, lighting intensity, color temperature, and relative humidity were recorded to analyze the relationship as well as to maintain a consistent experiment environment.

This study also used the survey to collect the participant’s subjective responses. The participants were asked to provide ratings for the lighting environments for their lighting sensitivity and satisfaction. The satisfaction survey was based on the Likert 7-point scale (Table 1) and the lighting sensitivity used a 5-point scale (1: not at all, 5: very sensitive). The collected data were compared with the physiological data to understand their relationships. The experiment environment for this study is in Figures 1 and 2.

Tobii Eye Tracker 4C with an upgrade kit was used to measure the participants’ pupil size and the SECONIC C-7000 Spectrometer was used to measure the lighting conditions. The sensors and data acquisition devices from Vernier Software & Technology were used to monitor indoor temperatures. The specifications of each equipment are shown in Table 2.

Table 1: Satisfaction survey questionnaires. Source: (Yeom 2023)

-3	-2	-1	0	1	2	3
Very dissatisfied	Dissatisfied	Slightly dissatisfied	Neutral	Slightly satisfied	Satisfied	Very satisfied

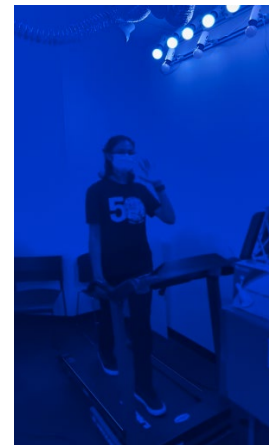
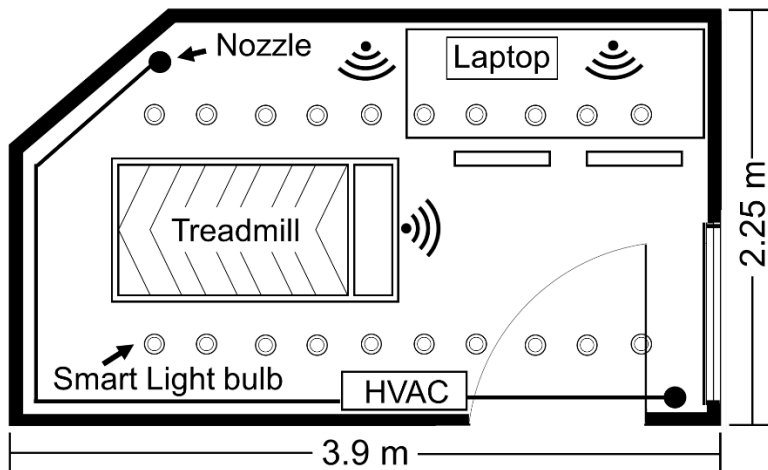

Figures 1 & 2: (Left) Experiment room floor plan and equipment location. Source:(Yeom 2023), (Right) A participant is walking on the treadmill. Source: (Yeom 2023)

Table 2: Specification of the equipment. Source: (Yeom 2023)

Sensor	Model	Specification
Eye tracker	Tobii 4C	Sampling rate: 90 Hz
Data acquisition	Lab quest mini	Resolution: 13-bit, Sampling rate: 10 kS/s
SECONIC SPECTRUM	C-7000	CCT: 1,563-100,000K, Illuminance: 1 to 200,000 lx
Smart light bulb	Jandcase BR30	12 W, 1050 lm
Dry bulb temperature	SBS-BTA	Accuracy: ± 0.5°C, Resolution: 0.03°C
Data acquisition system	Lab quest mini	Resolution: 13 bit, Sampling rate: 10kS/s

1.2. Experiment procedure

The experiment procedure was approved by the Institutional Review Board (IRB) at ASU (#STUDY00014182) and the safety and health policies, regarding COVID-19, was strictly applied in the human experiment procedure so that all participants wore the mask during the experiment. The participants were volunteer students at ASU. The participant’s

clothing was notified before the experiment, which as a short-sleeve T-shirts, short pants, regular underwear, socks, and sports shoes.

Once the participant arrived, they entered the experiment space where the lighting condition was set to the default condition (250 lux, white light). First, the participant signed the IRB consent form, and took the initial survey to check their general health conditions as well as basic demographic information, such as age, gender, body weight, height, ethnicity, etc. The research assistant helped the participant to wear the sensors, and they took the initial handgrip test as a baseline. Then, the lighting condition was changed to the experiment condition. The participant was randomly assigned to one of the 8 lighting conditions, which were blue, red, warm, and cool (white) with two different lighting intensity (150 and 400 lux). 4 male and 4 female participants were assigned per each condition to compare the gender difference. They stayed in the chair for 5 minutes to adjust their physical condition to the experiment lighting environment, while answering the first lighting survey. Then, they walked on a treadmill for 20 minutes as a cardio training and the walking speed was set at 3 mph (a little fast walking). Once they completed, the participant sat on the chair to rest while taking the 2nd lighting survey and measured pupil size, heart rate, and handgrip strength as an experiment group data. The whole experiment took about 55 minutes.

The collected physiological signals and survey data were analyzed by multiple statistical methods, including two sample T-test and Anova analysis, to understand the relationship between human physiological signals, physical performance and the lighting conditions. Microsoft Excel and Minitab were used to analyze the data, and all analysis were conducted at the 95% significance level.

2.0 RESULTS AND DISCUSSIONS

2.1. Lighting conditions and satisfactions

A total of 32 male and 32 female volunteers participated in the experiments, but due to the data collection error, 3 datasets were excluded from the analysis (Table 3). The average age of the participants was 24.5 (Max.:31, Min.: 18, SD: 2.935) and no participant reported specific health issues. In the sensitivity question, the female group (Mean.: 3.28) showed a little higher sensitivity to the light than the male group (Mean.: 3.04) with a significant p-value ($p < 0.001$).

Table 3: Participants per experiment condition (Number of participant). Source: (Yeom 2023)

Index	Experimental lighting conditions									Total
	A (Default)	B1	B2	C1	C2	R1	R2	W1	W2	
Color	Cool	Blue	Blue	Cool	Cool	Red	Red	Warm	Warm	
Lux	250	150	400	150	400	150	400	150	400	
Male	-	4	4	4	3	4	4	4	3	30
Female	-	4	4	4	4	4	4	3	4	31
Total	-	8	8	8	7	8	8	7	7	61

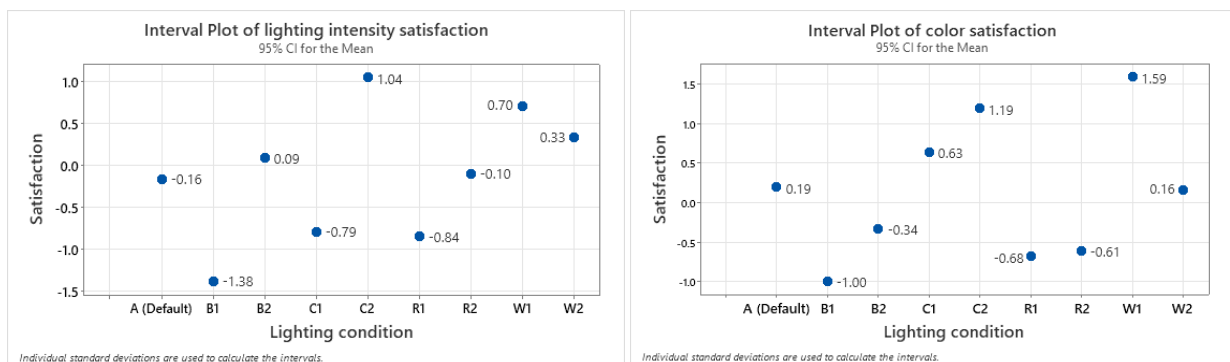

Figures 3 & 4: (Left) Lighting intensity satisfaction by lighting condition. Source: (Yeom 2023). (Right)Color satisfaction by lighting condition. Source: (Yeom 2023)

Figure 3 shows the participant's satisfaction with the lighting intensity by the experiment condition. The participants in C2 (bright cool) demonstrated the highest satisfaction, and both warm lighting conditions (W1 and W2) also showed positive satisfaction responses. However, the dark blue condition (B1) showed the lowest satisfaction among all groups, and the satisfaction in C1 and R1 also appeared negative. In all groups, the 400-lux level demonstrated significantly higher satisfaction than the one in 150 lux level, except in warm light conditions which showed the opposite result. Considering the color of the light (Figure 4), all blue and red conditions showed negative satisfaction while all cool and warm conditions demonstrated positive responses. The B1 showed the lowest satisfaction among all conditions at -1.0 and the W1 condition showed the highest satisfaction (1.59). All lighting conditions demonstrated significantly

different satisfaction between bright (400 lux) and dark (150 lux) conditions ($p < 0.01$), and bright conditions in red, blue, and cool light showed higher satisfaction than the ones in dark conditions. Thus, it can be argued that bright condition provides higher satisfaction in general, which supports the existing argument (Borisuit et al. 2015).

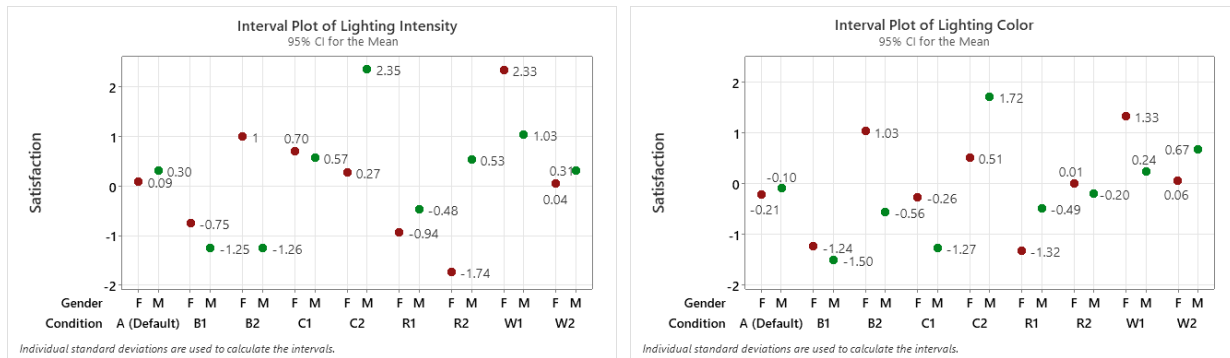

Figures 5 & 6: (Left) Lighting intensity satisfaction by lighting condition. Source: (Yeom 2023). (Right) Color satisfaction by lighting condition. Source: (Yeom 2023)

Considering the gender difference, Figure 5 and 6 demonstrates the relationships between lighting intensity, lighting color, and the participants' satisfaction by gender. Both Figures verified that there are significant differences between gender in lighting intensity and color satisfaction. In Figure 5, The lighting intensity satisfaction in B1, B2, C1, and W1 conditions appeared significantly higher in the female group, while the rest of the groups showed the opposite results ($p < 0.01$). The highest satisfaction appeared in C2 for the male group and W1 for the female group, and the lowest was in R2 (females) and B2 (males). Common lighting conditions, C1, C2, W1, and W2 showed positive satisfaction in both gender groups. The largest satisfaction difference between gender groups appeared in the bright blue condition (B2) and the smallest one was in C1. It was also interesting that the male group showed negative satisfaction in both blue light conditions (B1 and B2) while the female group showed negative responses in both red-light conditions, which demonstrates that color has a different impact on lighting intensity satisfaction by gender. In Figure 6, both genders responded with negative color satisfaction in B1 and C1, but the responses were positive in R1 but C2, W1, and W2 for both gender groups. The female group showed higher color satisfaction in B1, B2, C1, R2, and W1, and the male group's color satisfaction was higher than the one of the female groups in R1, C2, and W2. Thus, it is clear that there are significant gender differences in lighting intensity and color.

2.2. Lighting conditions and pupil sizes

The pupil size was measured as a human physiological signal to understand its relationship with diverse lighting conditions. Figure 7 shows the interval plot of the pupil size in the lighting conditions. As described in the research method, the lighting intensity was set up at 150 lux for dark condition and 450 lux for bright condition, and it is known that the pupil size is negatively correlated to the lighting intensity. The result support this by showing that every bright condition demonstrated significantly smaller pupil size than the one in dark condition ($p < 0.01$). But it is also clear that each lighting condition significantly affect the pupil size. Two sample T-test verified that the pupil size in both blue conditions appeared significantly smaller than all the other lighting conditions. The largest pupil size was the one in R1 and the smallest one was in B2 condition, which showed the contrast between two color. Cool lighting condition demonstrated the largest pupil size difference among all lighting conditions, and red and warm light showed relatively smaller difference.

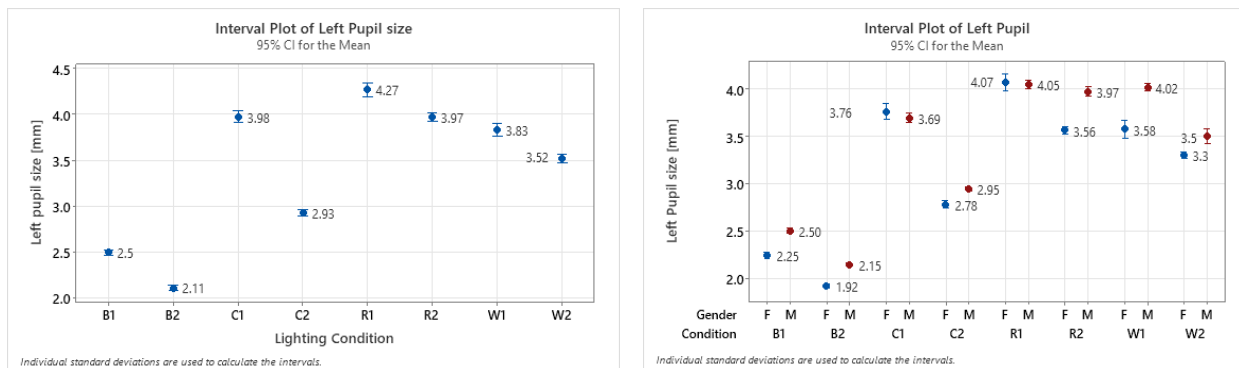

Figure 7 & 8: (Left)Pupil size by lighting condition. Source: (Yeom 2023). (Right) Pupil size by lighting condition and gender. Source: (Yeom 2023)

Figure 8 demonstrates the pupil size difference by lighting condition and gender. Although the pupil size in C1 and R1 didn't show any significant difference by two sample T-tests, all other lighting conditions generated pupil size differences

between the male and female groups. In most conditions, the pupil size in the male group was significantly larger than the one in the female group, except the one in the W2 condition, which is a similar result to the existing study (Ordifaga-Monreal et al. 2022). W1 condition showed the largest pupil size difference and C2 demonstrated the smallest pupil size difference between gender groups. This supports a similar study result that the correlated color temperature (CCT) is negatively related to pupil size (Berman et al. 2006) but also provides that the impact of the visible light spectrum (blue and red) on pupil size is significant as well as its different impact by gender. This finding verifies the potential of pupil size as a lighting environment control factor to provide a personalized indoor lighting environment for physical training.

2.3. Physical training performance and lighting conditions

This study adapted walking as a cardio training and a handgrip test as a strength training to measure the physical training performance. The handgrip test results demonstrated that the lighting conditions have a significant impact on the participant's handgrip strength (Figure 9). In general, the participants in bright lighting conditions at every color appeared to have stronger grip strength on the average than the one in dark conditions, although cool and warm light didn't show any significant difference by T-test ($p > 0.05$). The bright blue condition (B2) showed the highest average value while the dark red group demonstrated the lowest average which clearly showed the difference by the color. Considering gender (Figure 10), although there is a fundamental difference in physical strength between gender groups, it is clear that the impact of lighting conditions can be differentiated further by gender difference. The female group demonstrated a significant difference in every lighting condition ($p < 0.01$), while no lighting condition in the male group had significantly different handgrip strength results, which clearly showed the impact of the lighting condition on the strength training results and gender.

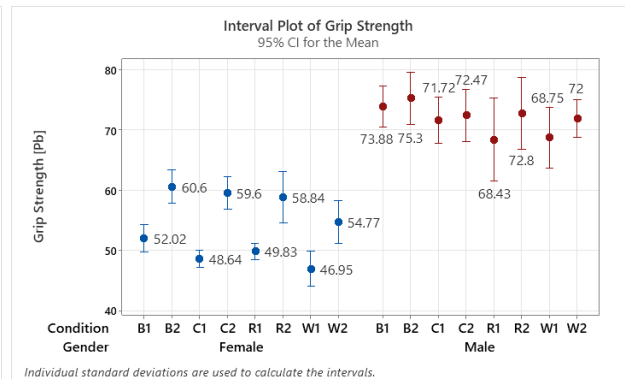
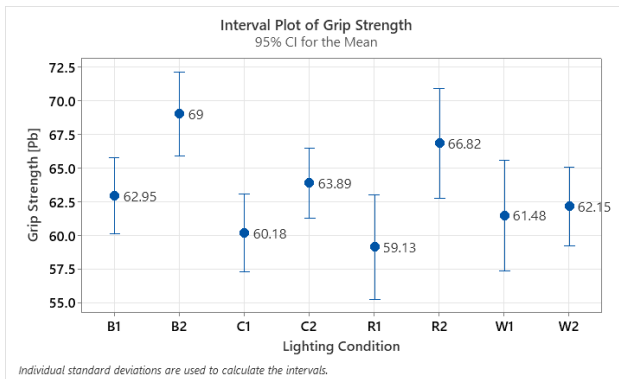

Figures 9 & 10: (Left) Handgrip strength by lighting condition. Source: (Yeom 2023). (Right) Handgrip strength by lighting condition and gender. Source: (Yeom 2023).

In the heart rate analysis result during the training (Figure 11), the cool light condition didn't show any significant difference between the dark and bright conditions, but all the other conditions demonstrated the difference with a significant p-value. Especially, the average heart rate in the B2 condition appeared the highest, showing the potential that it may maximize the training efficiency, while the W2 condition showed the lowest average heart rate. Both gender groups in the cool and blue light conditions demonstrated the higher heart rate, and the red and warm light showed relatively low heart rate (Figure 12). Although the gender didn't show a noticeable difference, it should be studied further for verification and the warm and red-light conditions may not be recommended for the cardio training environment.

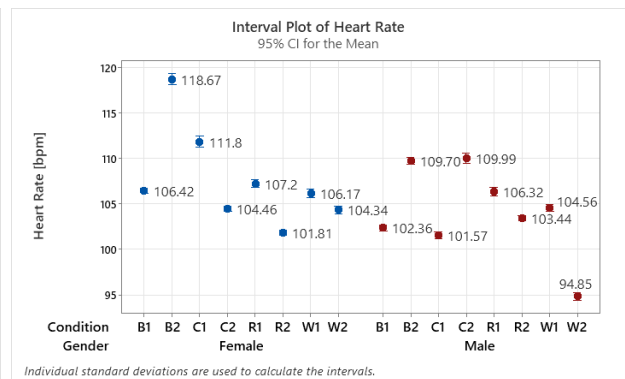
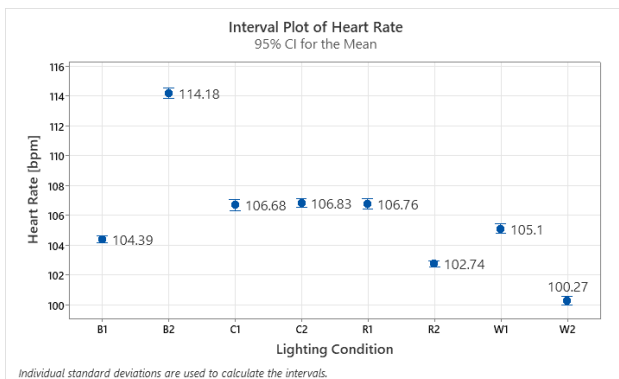

Figure 11 & 12: (Left) Heart rate by lighting condition. Source: (Yeom 2023). (Right) Heart rate by lighting condition and gender. Source: (Yeom 2023)

3.0 DISCUSSION

In this study, a series of analysis results were presented regarding multiple indoor lighting conditions, pupil size, and the trainee's cardio and muscular performance. In addition to the impact of bright light on the trainee's physical performance (Drust et al. 2005; Kantermann et al. 2012; Knaier et al. 2017), the result of this study provides additional aspect about how color and lighting intensity can affect the trainee's performance. Also, the existing study demonstrated the lighting preferences by gender difference for activation and relaxation (Schweitzer et al. 2016), and this study adds that the relationship between lighting perception, physiological difference, and physical performance can be different by gender. The result can be used to improve the efficiency of the training by providing the optimum lighting environment, especially optimized by gender. Additionally, previous studies were conducted on the athletes mostly, so the result of this study can benefit larger population by providing better understanding about optimum training environment for general public. Also, this study demonstrated that the optimum lighting environment for female and male is different which can contribute to create more inclusive indoor training environment for both genders.

Although the new findings of this study are significant, this study has some limitations which needs to be addressed in the future. The pupil size in certain lighting conditions were different between genders, however, we expect that the larger sample size will not demonstrate the gender difference in pupil size. Also, the 61 participants were large enough to establish significant analysis result, but the larger sample size would benefit the result further. Therefore, future study should be conducted in larger participant group. Also, various lighting conditions, such as CCT levels, lighting intensity, and color should be considered as an extended data. Due to the COVID-related health and safety policy, all the participants had to wear a face mask during the experiment, which may alter the cardio vascular and muscular performance, thus the experiment without the face mask are required for further validation of the result.

CONCLUSION

The purpose of this research is to understand the impact of indoor lighting environment on physical training performance by gender difference for the gender-specific training environment. In this study, it was verified that there is a significant difference in the physical performance and physiological signals by the lighting conditions, and gender difference also affected the participant's perception of the lighting conditions as well as their physical training performance. The lighting condition affected pupil size difference, handgrip strength, and heart rate during cardio exercise, which shows a potential as a lighting environment control factor for a personalized training environment. The new findings from this research provide a new perspective of gender difference in indoor lighting environment for physical training and it will bridge the gap between psychological and physical aspects of human activity in the indoor lighting environment for sports. The insight from this study will also expand the understanding of this relationship and will contribute to develop multidisciplinary research program, human-building interaction, in sports.

ACKNOWLEDGEMENTS

This study was funded by the SEED grant from the Global Sports Institute at Arizona State University. The author appreciates Dr. Jae Yong Suk (UC Davis) for his valuable input, and Clara Riess, Rutuja Landge, and Vivek Nalluri for their assistants on the experiments. The author also appreciates all the volunteer participants, especially the students at Arizona State University.

REFERENCES

- Berman, Sam M., M. Navvab, M. J. Martin, J. Sheedy, W. Tithof, and Steve A. Fotios. 2006. *A Comparison of Traditional and High Colour Temperature Lighting on the near Acuity of Elementary School Children*. *Lighting Research and Technology*. 38 (1): 41–52. <https://doi.org/10.1191/1365782806li155oa>.
- Borisuit, A., F. Linhart, J. L. Scartezzini, and M. Münch. 2015. *Effects of Realistic Office Daylighting and Electric Lighting Conditions on Visual Comfort, Alertness and Mood*. *Lighting Research and Technology*. 47 (2): 192–209. <https://doi.org/10.1177/1477153514531518>.
- Cajochen, C. 2007. *Alerting Effects of Light*. *Sleep Medicine Reviews*. 11 (6): 453-464. <https://doi.org/10.1016/j.smr.2007.07.009>.
- Cajochen, C, Münch, M., Kobiakka, S., Kräuchi, K., Steiner, R., Oelhafen, P., Orgül, S., and Wirz-Justice., A. 2005. *High Sensitivity of Human Melatonin, Alertness, Thermoregulation, and Heart Rate to Short Wavelength Light*. *Journal of Clinical Endocrinology and Metabolism* 90 (3): 1311–16. <https://doi.org/10.1210/jc.2004-0957>.
- Chellappa, S., Steiner, R., Blattner, P., Oelhafen, P., Götz, T., and Cajochen, C. 2011. *Non-Visual Effects of Light on Melatonin, Alertness and Cognitive Performance: Can Blue-Enriched Light Keep Us Alert?* *PLOS ONE*. 6 (1). <https://doi.org/10.1371/journal.pone.0016429>.
- Choi, J., and Yeom. D. 2017. *Study of Data-Driven Thermal Sensation Prediction Model as a Function of Local Body Skin Temperatures in a Built Environment*. *Building and Environment*. 121: 130-147. <https://doi.org/10.1016/j.buildenv.2017.05.004>.
- Choi, J., Loftness, V., and Aziz, A. 2012. *Post-Occupancy Evaluation of 20 Office Buildings as Basis for Future IEQ Standards and Guidelines*. *Energy and Buildings*. 46: 167–175. <https://doi.org/10.1016/j.enbuild.2011.08.009>.
- Daurat, A, Foret, J., Benoit, O., and Mauco, G. 2000. *Bright Light during Nighttime: Effects on the Circadian Regulation of Alertness and Performance*. *Neurosignals*. 9 (6): 309–318. <https://doi.org/10.1159/000014654>.
- Drust, B., Waterhouse, J., Atkinson, G., Edwards, B., and Reilly, T. 2005. *Circadian Rhythms in Sports Performance - An Update*. *Chronobiology International*. 22 (1): 21-44. <https://doi.org/10.1081/CBI-200041039>.

- Kantermann, T., Forstner, S., Halle, M., Schlangen, L., Roenneberg, T., and Schmidt-Trucksäss, A. 2012. *The Stimulating Effect of Bright Light on Physical Performance Depends on Internal Time*. PLOS ONE 7 (7). <https://doi.org/10.1371/journal.pone.0040655>.
- Kim, T., Lim, S., Yoon, S., and Yeom, D. 2022. *Pupil Size and Gender-Driven Occupant's Productivity Predictive Model for Diverse Indoor Lighting Conditions in the Office Environment*. Building and Environment. 226: 109673. <https://doi.org/10.1016/j.buildenv.2022.109673>.
- Knaier, R., Schäfer, J., Rossmeißl, A., Klenk, C., Hanssen, H., Höchsmann, C., Cajochen, C., and Schmidt-Trucksäss, A. 2017. *Effects of Bright and Blue Light on Acoustic Reaction Time and Maximum Handgrip Strength in Male Athletes: A Randomized Controlled Trial*. European Journal of Applied Physiology. 117 (8): 1689–96. <https://doi.org/10.1007/s00421-017-3659-0>.
- Lehr, S., Gerstmeyer, K., Jacob, J. H., Frieling, H., Henkel, A. W., Meyrer, R., Wiltfang, J., Kornhuber, J., and Bleich, S. 2007. *Blue Light Improves Cognitive Performance*. Journal of Neural Transmission. 114 (4): 457–460. <https://doi.org/10.1007/s00702-006-0621-4>.
- Lockley, S., Evans, E., Scheer, F., Brainard, G., Czeisler, C., and Aeschbach, D. 2006. *Short-Wavelength Sensitivity for the Direct Effects of Light on Alertness, Vigilance, and the Waking Electroencephalogram in Humans*. Sleep. 29 (2): 161–168.
- Ordíñaga-Monreal, E., Castanera-Gratacós, D., Castanera, F., Fambuena-Muedra, I., Vega, F., and Millán, M. S. 2022. *Pupil Size Differences between Female and Male Patients after Cataract Surgery*. Journal of Optometry. 15 (2): 179–185. <https://doi.org/10.1016/j.optom.2020.09.005>.
- Schweitzer, S., Schinagl, C., Djuras, G., Frühwirth, M., Hoschopf, H., Wagner, F., Schulz, B., Nemitz, W., Grote, V., Reidl, S., Pritz, P., Moser, M., and Wenzl, F. P. 2016. *Investigation of Gender- and Age-Related Preferences of Men and Women Regarding Lighting Conditions for Activation and Relaxation*. Fifteenth International Conference on Solid State Lighting and LED-Based Illumination Systems, 9954:99540L. <https://doi.org/10.1117/12.2237897>.
- Sim, S., Koh, M., Joo, K., Noh, S., Park, S., Kim, Y., and Park, K. 2016. *Estimation of Thermal Sensation Based on Wrist Skin Temperatures*. Sensors (Switzerland). 16 (4): 420. <https://doi.org/10.3390/s16040420>.
- Antoine U, V., Lynette M, J., Luc J.M., S., and Derk Jan, D. 2008. *Blue-Enriched White Light in the Workplace Improves Self-Reported Alertness, Performance and Sleep Quality*. Scandinavian Journal of Work, Environment and Health. 34 (4): 297–306. <https://doi.org/10.5271/sjweh.1268>.

Understanding of Occupant Wellbeing in Sustainable Built Environment - a Mindfulness Framework

Ming Hu¹

¹ University of Maryland, College Park, MD

ABSTRACT: Mechanisms underpinning how the built environment affects mental health and cognitive functioning are largely unexplored due to the complexity of built environment, and the difficulty in quantifying psychological responses. The aim of this paper is to propose a mechanism “mindfulness” based on an integrative theoretical foundation/ research method to understand the impact of sustainable building on human performance and wellbeing.

KEYWORDS: mindfulness, wellbeing, built environment

INTRODUCTION

WHAT IS MINDFULNESS

The concept of mindfulness has its origins in Buddhism tradition, the training and practice of mindfulness is integral component of Buddhist practice. The word “mindfulness” originally comes from the Pali word “sati”, which in Buddhist tradition implies awareness, attention, or alertness. In the original Buddhist text Satipatthana Sutta, mindfulness is “to be alert to what one is doing in the present; to recognize the skillful and unskillful qualities that arise in the mind; and also how to effectively abandon the qualities that get in the way of concentration” (MN10 1994). Later, when it was introduced to Zen Buddhism, the mindfulness was described as integral psychological and physical state of “this Body itself is Emptiness and Emptiness itself is this Body”(有我无我) (Heart Sutra). In other words, mindfulness means aware but not being distracted. Modern Buddhist teacher Chogyam Trungpa Rinpoche said that “mindfulness does not mean pushing oneself toward something or hanging on to something. It means allowing oneself to be there in the very moment of what is happening in the living process.”¹

Mindfulness was introduced in western scientific community in the 1970s, first in clinical applications of meditative and contemplative practices. ¹ The most influential figure in adopting mindfulness as scientific method and terminology is Jon Kabat-Zinn, who founded mindfulness- based stress reduction. He removed the Buddhist framework and any connection between mindfulness and Buddhism, instead putting mindfulness- based stress reduction in a scientific context ^{2 3}. The characteristic of mindfulness includes openness or receptiveness, curiosity and a non-judgemental attitude. Mindfulness is not a goal-oriented activities, rather it is training to stay in the present moment. Mindfulness was defined by Kabat-Zinn as ‘paying attention in a particular way: on purpose, in the present moment, and nonjudgmentally’. ⁴And it was further defined by UK Mindfulness all party parliamentary group in 2015 as “paying attention to that’s happening in the present moment in the mind, body and external environment, with an attitude of curiosity and kindness”. ⁵However, the qualities of the ‘external environment’ are rarely discussed in relation to mindfulness (Porter, 2017)

In this study, we go back to the Buddhist origin of mindfulness, and defined mindfulness as the process which one is fully aware of in the very moment of living process with ardent and watchful mind.^{2,3} Its opposite is “mind wandering”. In Buddhism, chaos, confusion, and suffering arise due to distractions and forgetting our true, ⁴for which, mindfulness is a way to bring back the lost awareness which has already caused so many problems. While striving for the ultimate goal of attaining enlightenment is at the heart of Buddhism, this process can result in the more everyday benefit of gaining calm, serenity, moments of inner peace, and improving one’s wellbeing.⁵

1.0 EXISTING LITERATURE AND KNOWLEDGE GAP

Western mindfulness literature has been very ambivalent toward physical external environment for practicing. Kabat-Zinn suggested that “practitioners need not find someplace special to practice”, based on the assumption that the potential to mediate mindfully and revel the present moment exists wherever practitioner are. However, if we go back to the origin of Buddhism practice, the physical spaces with particular architectural and landscape qualities with the intention of enabling and embodying mindfulness have been critical. Buddhist mindfulness practices acknowledge and work with the external environment in several ways, including finding a place with less distraction and focusing on particular sound and pattern. For example, sitting under the tree or use of symbolic geometries to focus the mind. Such physical environment setting has not transferred to western secular mindfulness practice, rather the types of spaces people practice mindfulness can be found in three categories. First, the notion of taking a retreat in a more seclude place away from daily actives is often used to most mindfulness teaching and training program, the space include

monastery and others. Second, and most commonly, the space used for mindfulness training happen in regular meeting room, offices or people's own home. Lastly, there are very few examples of customized designed interiors for mindfulness, where a space is set aside and configured for group of individual meditation.

According to research done in clinical psychology, behavioral medicine, mindfulness can be cultivated and achieved through a variety of techniques, such as meditation. In fact, all current mindfulness practices all have a mediative component, and heavily rely on internal (personal) activities/changes (e.g., yoga). To this extend, the aim of our study is to fill the knowledge gap of how external physical environment impact on the effectiveness of mindfulness. We want to explore what and whether there are external factors can help to put people in a mindfulness stage without using those commonly used internal techniques. In our study, we go back to Buddhist tradition for original meanings, ideas and inspirations.

Unlike modern western interpretation, in Mahayana (including Vajrayana) and Theravada Buddhist tradition, places for practicing are designed and constructed with specific quality to help reach the mindfulness status. The recurring space qualities/characteristic identified from Buddhist literature are: quiet, solitude, and nature. ⁵ In our experiment, we focused on solitude and nature. Many Buddhist sutras and teachings emphasize the importance a findings a suitable environmental for beginners to learn meditation practices. Such environments are often referred as solitary places. As stated in The questions of Purna, by devotion to places of mountains and forests, the source of good qualities will be increased. The solitary place is not narrowly defined as to be alone or isolated from other people. The most important characteristics of solitary place is to help the practitioners minimize distractions of the mind (not the body), which may be achieved amongst others. There are large monasteries and temples hosting thousands of people living and studying in the remote settlement, such as Larung Gar Buddhist Academy. The atmosphere of the place can help reduce the level of distraction, which facilitate people reaching mindfulness state.

Nature is a critical element in Buddhist tradition and solitary places. The origin can be traced back to the Lumbini garden where the historical Buddha was born, the Bodhi tree that Buddha sat underneath for his enlightenment. Many Buddhist monasteries and temples are nested in nature, and natural elements and patterns are visible in traditional Buddhist paintings, architecture and decorations, bearing both explicit and implicit meanings, as well as in the literature. ⁵

In summary, characteristics of places of mindfulness practicing most frequently mentioned in the Sutras and Buddhist arts are quiet and solitude, and nature or natural elements, including natural sounds, views, aromas, and vegetation, e.g., trees, grassland. Our question is whether a place possessing those qualities can be used in other functions (e.g., office) to help people being in a more mindful state for other activities (e.g., working). If these qualities be found and mindfulness to be experienced in an office environment, how can we measure it? This question will be discussed in the following experimental polite study.

2.0 INTEGRATIVE THEORETICAL FOUNDATION

Our methodological framework is based on the convergence of an event-related potential (ERP) cognitive-neuroscience approach, cognitive load theory (CLT) and attentive restoration theory (ART). Unlike behavior studies used in the cognitive psychology approach, ERPs provide a continuous measurement of processing between a stimulus and response, very appropriate for studying a built environment design. Due to the complexity and multi-faceted attributes of design, ERP continuous measurements have the potential to objectively elucidate what events (stimuli) are affected by particular design feature manipulations. ERP measurement is more cost-effective than fMRI, and the vast array of developed ERP/EEG approaches provides a solid basis for application to design research (Hu et al,2021)

CLT - initially developed by John Sweller while he was studying problem-solving in 1988, is a theoretical framework based on previous knowledge of human cognitive architecture in the brain, which includes long-term memory and working memory. CLT comprises two types of cognitive loads: intrinsic load and extrinsic load, with intrinsic load defined by the nature of the task itself, and extrinsic load determined by the way in which the task is presented, including in which type of environment the task is presented. Attention restoration theory (ART) suggests that people concentrate better after spending time in nature, or even looking at scenes of nature. The original development of ART was largely descriptive, based on observations of human-nature interactions and analysis of qualitative data. Although widely cited and applied in landscape design and biophilia design, there has been little formal empirical assessment of the core ideas of the theory.

2.1. Integrative methodology

Our methodological approach is to combine the ERP/EEG neuroscience approach with Virtual Reality (VR) technology to enable built environment design manipulation and experimentation. The use of EEG in built environment, cognitive science research is growing rapidly due to its portability and flexibility in allowing test subjects to move around while immersed in a real environment. EEG is used to measure ERPs that demonstrate brain activity directly related to a specific event (stimulus), such as the presentation of an image, word, or special visual environment. VR is a commonly known technology that can add the dimensions of immersion and interactivity to three-dimensional, computer-generated models, offering an experience that does not exist in the conventional form of representation. It is possible to measure the emotional response of an individual in a controlled environment to correlate the person's emotional response and satisfaction regarding particular design features of a built environment. VR not only provides a fully controlled environment but also allows for the rapid manipulation of different built environment stimuli.

2.2. Hypothetical mechanism: Mindfulness and Wellbeing

Our hypothesized mechanism, based on the combined CLT and ART and motivated by our preliminary work, is **Mindfulness**. Mindfulness (present focused) has become a popular way to conceptualize the effects of nature, which tend to pull attention to the natural scenery and away from internal processing. We employ a narrow definition of mindfulness in this work, meaning a greater focus on the present moment through greater engagement with the built environment and activities occurring in it, consistent with the core aspects of mindfulness as defined across current theories. Mindfulness has been associated with receptive attention and perceptual clarity. Further, improvements in mindfulness have demonstrated reductions in workplace burnout and perceived stress, as well as improvements in personal well-being and team and organizational performance and climate. Another way to conceptualize mindfulness is in terms of reductions in task-unrelated mental processing (cf. mind wandering), which has been closely investigated in empirical research on mindfulness.

The idea of increased occupant mindfulness as a way to understand the effects of daylight and nature is consistent with the reports that occupants in sustainable building environments feel stronger environmental satisfaction and support. Physical workplace satisfaction has been positively associated with job satisfaction and better performance, and environmental satisfaction has been linked to contributions to the well-being of residents, particularly the elderly.

2.3. Experiment setup

The research team conducted pilot VR environment tests using lighting and views as the experimental parameters, with 42 participants. In this project we define buildings where occupants have increased access to environment stimuli including daylight and natural views as sustainable buildings (SB), and those buildings without such stimuli as conventional buildings (CB). Two different models of the same, three-dimensional virtual building were built by using Autodesk Revit software to construct SB and CB designs. These were then rendered, using Unreal Software, into two “real time” VR buildings / designs for use in the experiment. The simulated environment consisted of a two-story building composed of four different spaces: (1) public: entry lobby / open staircase, (2) semi-public: collaboration space, conference room, open kitchen, (3) semi-private: fitness center, conference room in open office, (4) private: individual work space. When the participants were in the VR environment, a “preset walk-through” allowed them to get comfortable with the equipment and the experience. Figure 2 illustrates SB and CB locations where the participants “stopped” and “looked around” in the VR environment. These stop locations were referred to as Maximum Effect Moment (MEX) events during the analysis below. Participants first entered through the building lobby, then walked up to the second floor open office area through a large open staircase. During the two-floor tour, they encountered the fitness center, open kitchen, collaboration space, and conference rooms. Refer to Figure 1 for the virtual environment of green building. Two physical built environment features we focused on according to the original interpretation of Mindful space: Nature and Daylight.

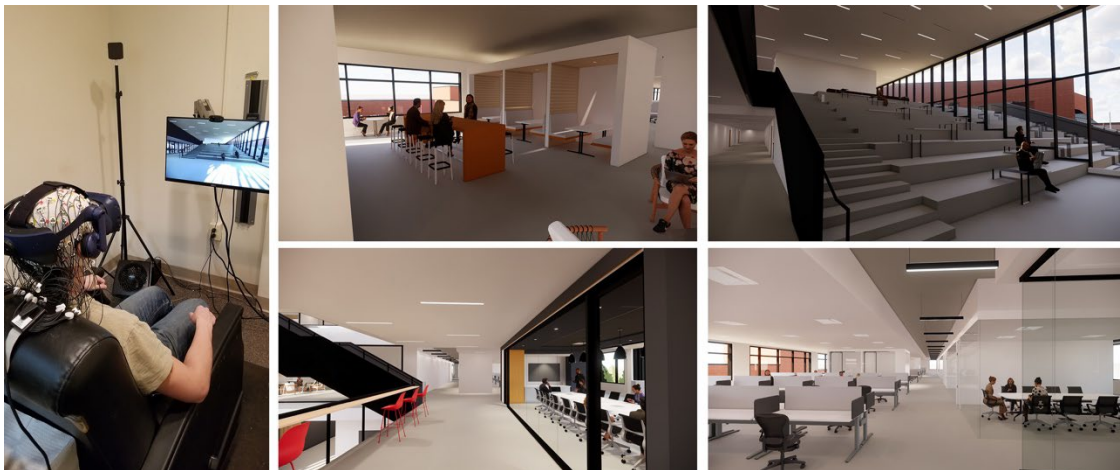

Figure 13: Virtual environment of green building. Source: Author

View to nature (VN): Multiple studies have demonstrated that a visual connection to nature has a positive impact on attention restoration, stress reduction, and overall health and well-being (Twohig-Bennett and Jones, 2018; Van den Bosch and Sang, 2017; Kuo, 2015). In buildings, the window and skylight are the primary connections to the outdoors. Studies have demonstrated that viewing nature through a window positively affected both hospital patient recovery time and reliance on pain medication (Ulrich, 1984; Dijkstra, Pieterse, and Pruyn 2008; Choi, 2012) and student recovery from mental fatigue and stress (Li and Sullivan, 2016). A recent study testing 86 subjects showed occupants have higher working memory (6%, level of significance $r=0.31$) and ability to concentrate (5%, level of significance $r=0.26$) in a space with a window. In addition, these participants showed higher positive emotions (e.g., happy, satisfied) and lower negative emotions (e.g., sad, drowsy) (Ko et al, 2020). To date, very few studies have gone beyond the binary, “with” or “without” nature empirical design to investigate how different type of nature views effect cognitive functioning and wellbeing.

Daylight (DL): Numerous studies have been conducted on lighting effects, and the results are mixed. For example, Hughes and McNelis (1978) reported that increased illuminance (from 500 to 1500 lx) caused 9% performance improvements for clerical office workers. Vimalanathan and Babu (2013) identified that a higher illuminance (1000 lx) contributes to 19.91% and 5.12% of improvement in reaction time and error response of neurobehavioral tests (compared to 500 lx and 750 lx). Recently, Smolders and Kort (2014) studied two illuminance levels at 200 lx and 1000 lx (4000k) in a lab setting; the results revealed the illuminance level had a significant effect on positive affect on occupant mood. Meanwhile, other studies revealed different findings. Baron et al (1992) found that lower illuminance (150 lx) can enhance performance on a complex word categorization task as compared to high levels (1500 lx).

3.0 PRELIMINARY RESULTS AND CONCLUSION

Indexing Occupant Experience using EEG and VR: Sustainable vs. Conventional Building

We collected preliminary neurophysiological data to assess for differences in occupant experiences between the CB and SB versions of the building detailed above. To maximize and balance experimental control with developed cognitive-neuroscience methods, with the free-form realistic experience that comes with immersive VR, we have developed a novel 3-task approach to measuring experiences of the VR buildings. At the controlled end, we recorded activity to a series of still images taken from each building. Then, activity was recorded to a movie of moving through the buildings. Finally, we measured activity as participants were immersed in the VR environment with a full headset. This 3-task approach allowed investigation of activity using well-developed event-related potential (ERP) methodologies (still images), as well as graduated greater realism (movie and then immersive VR), to provide a wide array of data from which to infer the underlying mechanisms and effects. Stimuli included 45 still images, one 5-minute video, and a guided VR tour for each building type. Across the tasks, participants spent about 25 minutes in each building. With sensor placements, task practice, and acclimation to the VR, testing of each participant took about two hours. EEG analysis included both conventional time-domain and advanced time-frequency amplitude and functional connectivity measures. As we will describe in detail below:

“this approach provides objective measures of direct visual engagement with the built environment (e.g., engagement of visual processing areas), as well as engagement of medial and lateral prefrontal areas understood to be central in salience and control processing. From this, we have observed increased visual system engagement and reduced prefrontal engagement in sustainable relative to conventional buildings.”

Data were collected initially from 36 participants in a first wave, and then from an additional 16 participants in a second wave (all data 96-channel, BrainVision Actichamp). Hypotheses were as follows. Hypothesis 1: Compared to CBs, occupants will respond to SBs with higher engagement, particularly to the sustainable visual stimuli; hence, SBs are associated with increased visual system engagement compared to CBs. Hypothesis 2: Compared to CBs, occupants of SBs will exhibit modulated attentional focus and control processing.

Results from the still image presentation are shown in Figure 2 and demonstrate robust differences between the SB and CB designs. The left panel presents the amplitude effects and the right theta band frontal and occipital functional connectivity (described further below). For amplitude, the top row contains traditional time-domain activity, and the three rows below that depict the time-frequency activity for alpha (8-12 Hz), theta (3-7 Hz), and delta (0-3 Hz). The top maps to the right of the amplitude plots depict the amplitude differences (color topo plots, where red indicates relatively greater amplitude for the SB, and blue indicates relatively greater amplitude for the CB) and the associated significance (black and white topo plots, where white indicates $p < 0.01$, and black indicates $p > 0.10$, uncorrected Wilcoxon nonparametric comparisons). The first column presents average activity across the earlier 0-500 ms time range, and the second column the later 500-1000 ms range.

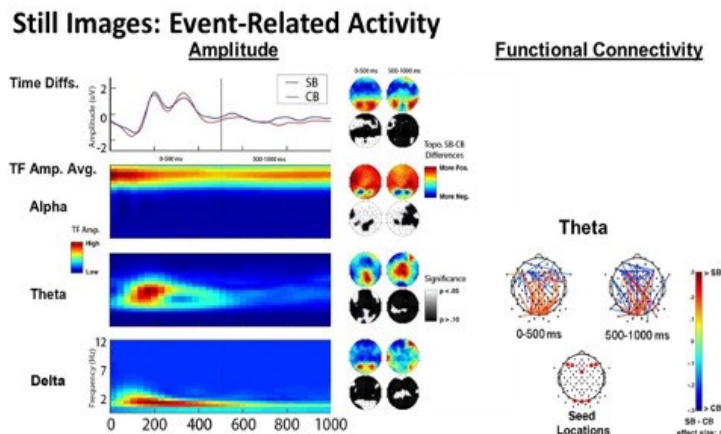

Figure 2: Still Images: Event-Related Activity. Source: Author

The time-domain amplitude results in the 0-500 ms range depict significantly greater activity in bilateral occipital regions (associated with processing visual information) and broad decreases in frontal regions (associated with control processing, problem-solving, movement, and social interaction [63]). Time-domain activity in the 500-1000 ms range does not show clear differences. Occipital processing increases for the SB, relative to the CB, are readily apparent for each band in the 0-500 ms range (delta, theta, and alpha), suggesting increased engagement in occipital areas for multiple processing systems. It is important to note that alpha activity plays an inhibitory role, and thus decreases in alpha for SB (blue color, for SB-CB, i.e., greater alpha amplitude for the CB occipitally) index increased occipital processing for the SB. This increase in occipital processing is sustained in the 500-1000 ms range only for alpha. Next, broad and bilateral increases in frontal alpha were observed in the 0-500 ms range, continuing through 500-1000 ms, providing further support for decreased frontal activity concomitant with the increased occipital activity in the alpha range. Finally, relatively localized increases in lateral-frontal areas can be observed in the theta band, where hypotheses predicted modulated engagement of lateral prefrontal areas associated with control.

Movie: Average and Event-Related Activity

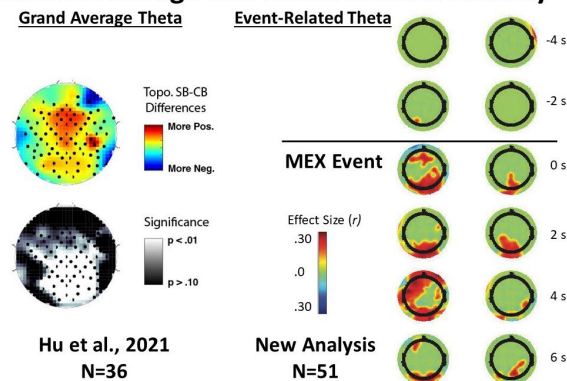

Figure 3: Movie: Average and Event-Related Activity, Source: Author

Results for the continuous EEG recorded during the movie are presented in Figure 2. The video contains all the images from the stills, as described above. Amplitude results from the published report, in the left part of the figure, indicate significant SB increases in theta band activity across the movie period, relative to CB, including medial-frontal, centro-parietal, and occipital areas. Next, we averaged around the maximum effect events (MEX, indexing the moments with maximal differences between SB and CB). Here we found significant MEX-related SB-CB differences, supporting the view that the shift toward visual processing (occipital) occurred during the movie, and some evidence of modulated frontal activity, similar to what was observed in response to the stills.

CONCLUSION

Our preliminary work demonstrates that our approach can index how participant present focus (cf. mindfulness) is driven by nature views and lighting. This work provides an objective empirical index for present focused mindfulness from which to infer how mindfulness is modulated by particular building design elements.

REFERENCES

- Baron, R. A., Rea, M. S., & Daniels, S. G. (1992). Effects of indoor lighting (illuminance and spectral distribution) on the performance of cognitive tasks and interpersonal behaviors: The potential mediating role of positive affect. *Motivation and emotion*, 16(1), 1-33.
- Bellia, L., Pedace, A., & Barbato, G. (2013). Lighting in educational environments: An example of a complete analysis of the effects of daylight and electric light on occupants. *Building and Environment*, 68, 50-65.
- Choi, J. H., Beltran, L. O., & Kim, H. S. (2012). Impacts of indoor daylight environments on patient average length of stay (ALOS) in a healthcare facility. *Building and environment*, 50, 65-75.
- Dijkstra, K., Pieterse, M. E., & Pruyn, A. (2008). Stress-reducing effects of indoor plants in the built healthcare environment: The mediating role of perceived attractiveness. *Preventive medicine*, 47(3), 279-283.
- Hu, M., Simon, M., Fix, S., Vivino, A. A., & Bernat, E. (2021). Exploring a sustainable building's impact on occupant mental health and cognitive function in a virtual environment. *Scientific Reports*, 11(1), 1-13.
- Hughes, P. C., & JF, M. (1978). Lighting, productivity, and the work environment.
- Ko, W. H., Schiavon, S., Zhang, H., Graham, L. T., Brager, G., Mauss, I., & Lin, Y. W. (2020). The impact of a view from a window on thermal comfort, emotion, and cognitive performance. *Building and Environment*, 175, 106779.
- Kuo, M. (2015). How might contact with nature promote human health? Promising mechanisms and a possible central pathway. *Frontiers in psychology*, 1093.
- Li, D., & Sullivan, W. C. (2016). Impact of views to school landscapes on recovery from stress and mental fatigue. *Landscape and urban planning*, 148, 149-158.

- Porter, Nicole, Johanna Bramham, and Martin Thomas. "Mindfulness and design: creating spaces for well being." In *Creative practices for improving health and social inclusion*. 5th International Health Humanities Conference, Sevilla 2016 (2017), p 199-209. Universidad de Sevilla, Vicerrectorado de Investigación, 2017
- Smolders, K. C., & de Kort, Y. A. (2014). Bright light and mental fatigue: Effects on alertness, vitality, performance and physiological arousal. *Journal of environmental psychology*, 39, 77-91.
- Twohig-Bennett, C., & Jones, A. (2018). The health benefits of the great outdoors: A systematic review and meta-analysis of greenspace exposure and health outcomes. *Environmental research*, 166, 628-637.
- Ulrich, R. S. (1984). View through a window may influence recovery from surgery. *Science*, 224(4647), 420-421.
- Van den Bosch, M., & Sang, A. O. (2017). Urban natural environments as nature-based solutions for improved public health—A systematic review of reviews. *Environmental research*, 158, 373-384.

ENDNOTE

¹Academic Mindfulness Interest Group, Melbourne, and Melbourne Academic Mindfulness Interest Group. "Mindfulness-based psychotherapies: a review of conceptual foundations, empirical evidence and practical considerations." *Australian & New Zealand Journal of Psychiatry* 40, no. 4 (2006): 285-294.

²Wilson, Jeff. *Mindful America: Meditation and the mutual transformation of Buddhism and American culture*. Oxford University Press, 2014.

³Nisbet, M. C. "The mindfulness movement: How a Buddhist practice evolved into a scientific approach to life." *Skeptical Inquirer* 41, no. 3 (2017): 24-26.

⁴ Kabat-Zinn, Jon. *Wherever you go, there you are: Mindfulness meditation in everyday life*. Hachette Books, 2009.

⁵ <https://www.themindfulnessinitiative.org/mindful-nation-report>

Urban Morphology, Inequitable Exposure, and Intra-Urban Heat: A Local-Scale Pilot Study in Cincinnati

Debanjali Banerjee ¹, Pravin Bhiwapurkar ¹

¹ University of Cincinnati, Cincinnati, OH

ABSTRACT: This paper examines the impact of urban morphology on disproportionate exposure to intra-urban heat in six neighborhoods in Cincinnati. Cities modify their climate, often known as the urban heat island effect, increasing the risk of outdoor overheating. Variation in heat exposure among neighborhoods contributes to unequal distribution of intra-urban heat, affecting low socioeconomic communities the most. While most overheating-related cases are reported indoors, a strong correlation between indoor and outdoor temperature suggests the significance of less understood implications of urban morphology on ambient temperature. Cognizance of such alliances is critical to prevent adverse effects and improve preparedness for the increasing global temperature. Therefore, in this study, we are enquiring, about how neighborhood outdoor temperature varies with urban morphology. Six Cincinnati neighborhoods were selected based on the existing SUHI maps to apprehend causal factors of inequitable exposure to intra-urban heat. Fixed stations were used to get the canopy layer temperature. Outdoor HOBO T-RH fixed stations were placed outside single-family homes (without centralized air conditioning) in similar local climate zones (LCZ) to assure indistinguishable exposure to the instruments. Finally, we have used statistical models to analyze how the predictor and response variable behaves in the system to create their microclimate interaction. Our preliminary results show a prevalence of high daytime and reduced nighttime UHI among neighborhoods. The proximity to freeways and industries is critical to the high heat exposure in low-income communities. Lack of tree canopy cover and high impervious surface, as a function of low street aspect ratio, are prominent urban morphology parameters associated with UHI.

KEYWORDS: Urban Heat Island, Built Environment, Urban morphology, Intra-urban heat, Cincinnati Neighborhoods

INTRODUCTION

The urban heat island (UHI) effect is one of the most significant demonstrations of surface modification resulting in higher surface temperature, increasing energy consumption, and indoor-outdoor thermal discomfort, leading to heat-related health issues including death in an extreme scenario (Oke, 2017; Stewart. al., 2021; Krayenhoff et. al., 2014; Santamouris 2015; Bao et. al., 2015; Stewart et. al., 2014). UHI has been studied for several cities globally with similar conclusions that enunciate roads, buildings, impervious surfaces, and other human-modified infrastructures absorb and reemit heat more than any natural surface, causing significantly modified urban energy balance (Wilson et. al., 2019; Akbari et. al., 2016). Urban areas where land modification is higher combined with low greenery becomes “heat island” with a temperature difference as large as 1-7K higher than their surroundings (Santamouris et. al., 2015; Gabbe et. al., 2020; Sailor et. al., 2014). As global temperature rises every year, it is critically important to find mitigation and adaptation techniques to avoid the negative impact of UHI. Recent studies have pointed out that the disproportionate impact of UHI is mostly driven by historic planning policies (Hoffman et. al., 2020). Research suggests that neighborhoods impacted by UHI are often occupied by residents and communities of color. While some studies suggest, people with pre-existing conditions, the elderly, and socially isolated populations are often impacted by the adverse effect of higher city temperatures, however emerging studies also suggest demographics with lower education, income, and racial minorities are more likely to live in neighborhoods that were historically redlined (Rathi et. al., 2022; Niu et. al., 2021; Haddad et. al., 2020; Khan et. al. 2020;). After the Federal Aid Highway Act of 1956, several highways were designed through black and brown communities, historically group D or redlined areas. Therefore, even today, these neighborhoods often have low tree canopy cover, higher impervious materials, wider roads, and single-story family houses, creating unique urban morphologies that contribute to higher canopy layers and surface UHI. It is therefore of critical importance that while developing mitigation and adaptation strategies to avoid adverse effects on the well-being of residents, the urban parameters that contribute towards UHI need to be studied thoroughly, ideally not generalized but more neighborhood-specific (Santamouris et. al., 2015).

Urban morphology consists of different climatic properties such as radiative, thermal, moisture, and, aerodynamic. Existing literature suggests various surfaces and associated microclimates are found in cities within or between different local climate zones (LCZ), contributing towards complex spatial-temporal variability within a few miles, further determining building energy consumption (Akbari et. al., 2016, Aflaki et. al., 2016; Yu et. al., 2021). Tree canopy cover has been a widely accepted UHI mitigation strategy when implanted correctly. Vegetation deflects solar radiation and increases shaded surfaces thus reducing surface temperature compared to unshaded surfaces. The majority of research finds a negative correlation between urban greenery and air temperature, thus reducing summertime energy

use and heat-related deaths. However, urban greenery can be a convoluted term if not defined correctly. The impact of tree canopy cover is significantly higher with up to 8k temperature difference observed whereas grassland and urban green roofs reduce the temperature by only 0.2k-1.5k (Park et. al., 2021; Jandaghian et. al., 2020, Grimmond et. al., 2010; Hirano et. al., 2012; Magli et. al., 2015). Contradictorily grassland without large trees or shading often has higher daytime UHI and reduced nocturnal UHI due to a higher sky view factor. Thus, bare grounds or urban parks mostly comprised of grassland might not have a positive impact on lowering daytime UHI. The impact of impervious surfaces on UHI depends on the material's heat capacity besides the street aspect ratio defined by the ratio of average building height with average street width. Street aspect ratio and sky view factor function differently with daytime and nocturnal UHI. Neighborhoods with low street aspect ratio experience a daytime increase in air temperature as the surface exposure to the sun is significantly higher; thus, the increase in daytime UHI is due to materials' greater thermal capacities and conductivity (Park et. al., 2021; Magli et. al., 2015). Higher sky views factor or openness release heat faster at night and reduces nocturnal UHI.

Thus, our hypothesis is, neighborhoods with less investment, where mostly low-rise dilapidated buildings are observed, and as a consequence higher surface and air temperatures during the daytime will be noted causing higher pedestrian discomfort and daytime energy consumption. Most of the existing studies on UHI are based on univariate analysis that allows an understanding of the distribution of one variable with respect to air temperature. However, UHI is a derivative of multiple variables as mentioned early, thus lack of multivariate analysis lacks our understanding of the relationship between several variables that contributes to forming its unique microclimate. In this pilot study, we are enquiring about the best subset of variables that define urban morphologies' contribution to the variation of neighborhood outdoor temperature.

1.0 METHOD

Our study has three primary components- onsite fixed station data collection, urban morphology data collection based on statistical principles of random sampling, and statistical analysis to find out the best-suited model to predict outdoor temperature.

1.1 Selection of study area

Existing studies have commonly concluded minorities and people of color have a higher probability of heat exposure than historically white neighborhoods. Six Cincinnati neighborhoods were selected close to downtown based on the existing city of Cincinnati surface urban heat island [SUHI] maps and demographics data to apprehend causal factors of inequitable exposure to intra-urban heat.

Table 1: Selection criteria for HOBO fixed stations

Neighborhoods	Typical House Description
1. East Price Hill (EPH)	<ul style="list-style-type: none"> • Single-family residence • No central air • If unit air conditioning were present, either resident is impoverished to run the system, or the system is not functional • The building represents most of the houses in that neighborhood, i.e., height, scale, building type, building condition, and maintenance. • The rudimentary urban fabric around the building is an utmost representation of the neighborhood such as tree canopy cover, street aspect ratio, grassland, etc. are observed mode i.e., the value that appears most frequently in a neighborhood.
2. Westwood (WW)	
3. South Cumminsville (SC)	
4. Millvale (M)	
5. Avondale (AV)	
6. Bond Hills (BO)	

1.2. Selection for fixed station points

To best reflect problems associated with temperature rise and energy affordability, our hypothesis based on existing studies were that single-family residence without centralized air conditioning with limited or no reliance on unit air conditioning system will experience the adverse effect of UHI, and subsequently, global temperature raises the most. In other words, residents who rely on natural ventilation and fan or impoverished to use air condition systems would be ideal for our study. If the house relies on a unit air conditioning system, a significant portion of the house needs to have no reliance on any form of air conditioning. With help of local nonprofit organizations, we shortlist residents who fulfill these criteria. One resident with the above criteria was selected from each neighborhood.

1.2.1. Instrument calibration

All seven HOBO MX2305 sensors were calibrated by placing them approximately 7 feet apart, protected by AcuRite temperature and humidity solar radiation shields to avoid direct radiation with recording set to each second to get maximum data points. Initially while placing the sensors, we ensured the first couple of readings are similar to confirm similar exposure to outdoor heat. The instruments were attached to outdoor poles for 48 hours to record temperature data. If the sensor data shows temperature fluctuation of 0.05-0.23 degrees, we considered that as negligible.

1.2.2. On-Site measurement protocols

Onset HOBO MX2305 outdoor Bluetooth Temperature Data Logger was mounted outside the residential property to get temporal variations over time for ten days (09/01/22-09/10/22). Each outdoor sensor was mounted 3 feet from the ground and protected by AcuRite temperature and humidity solar radiation shields to avoid direct radiation. HOBO MX2305 outdoor sensor uses wireless transmission of recorded readings to phone or tablet using Bluetooth LE communications that can measure temperatures between -40F to 158F with an $\pm 0.2^\circ$ accuracy.

1.2.3. Data processing

We have used Statistical Analysis System (SAS) programming language for onsite temperature and relative humidity data cleaning as it has been widely used in various fields and industries for data analysis, cleaning, mining, and related data handling procedures. We averaged out the data for every ten minutes, thus for every hour, we have 6 data points for temperature and humidity. As these are outdoor sensors, we noticed some unusual reading hikes. If the reading hike was not stable for at least two consecutive readings (i.e., at least for two minutes), we have assumed that this could be because of sudden vehicle movement or any pedestrian activity. Thus, we have considered those as noise and removed them.

1.3. Urban characteristics data

The percentage of tree canopy cover, impervious surfaces, and grassland were calculated by using open sourced i-Tree Canopy program based on statistical principles of random sampling for each neighborhood. A polygon was drawn that covers geographic boundaries for each neighborhood. i-Tree Canopy randomly generates multiple sample points and zooms to each one of the random sampling points to choose from the pre-defined list of cover types for that spot. For the cover assessment within a defined project area, we primarily focused on tree canopy, grassland, and impervious surface based on existing UHI studies. Multiple suggested survey points were used until the cover estimate error percentage was less than 0.5% for each study area. Street aspect ratios were calculated based on the ratio between average height building height with street width (H/D). The area of the parking lot, bare ground, and proximity to the highway were calculated from google map imager.

1.4. Statistical modeling

Our goal is to incorporate as many regressors as possible to predict the response variable so that all the critical information about urban morphologies from the dataset can influence the fitted values. At the same time, the reason for adopting this method is to come up with as few regressors as possible as multiple variables have linear relations. Even though multicollinearity does not reduce the reliability of the regression model but if one predictor variable in the regression model is linearly predicted from any other predictor variable with a substantial degree of accuracy due to multicollinearity, it does affect conclusions about individual predictors. Our study has one response variable and multiple predictor variables with collinearity; thus, we opt for stepwise regression to decide which subset of predictor variables needs to be included in the regression model to predict the response variable. Stepwise regression helps to cut down unnecessary regressors which will help to collect necessary and required data for future studies to reduce data collection, data warehousing, and statistical model time and cost. However, as deleting variables can also induce bias in the estimates of predicted response, we opt for all three types of stepwise regression a.) Forward Selection; b.) Backward Elimination; c.) Bidirectional elimination (a combination of forward selection and backward elimination). The forward selection method starts with the assumption that the original dataset has no variable. The data mining algorithm adds one variable at a time starting with the variable with the highest correlation value with the response variable. The significance of the model gets tested through the F statistics value and the algorithm moves forward with the next regressor with the highest value. The forward selection method continues until all the variables from the data set have been used and added to predict the response variable. The backward elimination method functions in a reverse manner. The algorithms start with the assumption that all variables are present in the equation while predicting the response variable and eliminating one variable at a time if it's not significant. Unlike the forward selection method, variable elimination depends on their partial F statistic value. The variable with the lowest F statistic value gets removed and the process continues as long as the model can refit with the remaining variables and can predict the response variable. Bidirectional elimination is a modified version of the forward selection method where the initial assumption of the original dataset has no variable remains the same.







Table 2: Urban variables and their interpretation

Variables	Description
Street Aspect Ratio	The ratio between average height building height with street width (H/D)
Impervious Surface	Percentage of impervious surfaces
Parking Lot	Area of parking lots right on the street, for example, grocery store and church parking lots
Bare Ground	Abundant/ undefined ground areas. Often has no trees but minimum or no grass coverage
Proximity to Highway	Distance to the highway from individual streets
Tree Canopy Cover	Percentage of tree canopy cover
Grass Land	Percentage of grassland

2.0 RESULTS AND ANALYSIS

Our fixed station results in four categories (Table 3-6) show, the maximum temperature is observed between 3 pm and 8 pm. Millvale and South Cumminsville have consistently higher temperatures. However, in both of these neighborhoods, early morning temperatures (3 am-8 am) and late night temperatures (9 pm-2 am) dropped significantly more than others. For the early morning and night time temperatures, most of the values are left-skewed with a concentration on the right side of the distribution graph while the left tail of the distribution graph is longer. As time progresses, during noon and afternoon the values tend to be right skewed. The relationship between urban development and the thermal pattern of every settlement is unique. Our research has identified the influence of surrounding patterns and the nature of the built forms determine the temporal pattern. Bond Hill, Millvale, and South Cumminsville have significantly higher impervious surfaces with low tree canopy cover compared to other neighborhoods.

Table 3: Demographics data with sample land use land cover for each neighborhood

<p>Avondale</p> <ul style="list-style-type: none"> • Population* 12,466 • 92 percent of Avondale residents are African American 		<p>Bond Hills</p> <ul style="list-style-type: none"> • Population* 6,972 • Predominantly African American population, with less than 7% of white residents. 	
<p>Westwood</p> <ul style="list-style-type: none"> • Population* 29,950 • A large number of German immigrants • Cincinnati's largest park (and forest) is in Westwood. • Cincinnati's largest neighborhood 		<p>East Price Hill</p> <ul style="list-style-type: none"> • Population* 15,340 • Predominantly white neighborhood with a 38% African American population 	
<p>South Cumminsville_1</p> <ul style="list-style-type: none"> • Population* 801 • Predominantly African American community 		<p>South Cumminsville_2</p> <ul style="list-style-type: none"> • Population* 801 • Predominantly African American community 	
<p>Millvale</p> <ul style="list-style-type: none"> • Population* 2400 • Predominantly African American community 			

* Population data are based on 2020 census data

A majority of the greenspaces in these neighborhoods are grassland with low tree coverage. Because of the higher sky view factor, the daytime temperature for these neighborhoods is consistently higher than others. Westwood is being significantly different than other neighborhoods with various types of street aspect ratios and green coverage. Even though this neighborhood has the largest greenspace for the city, the temperatures inside the neighborhood are not drastically different, which implies the impact of the cityscape on a granular level. Thus, Westwood experiences

significantly different temporal patterns within the neighborhood with both wider streets with low canopy cover and narrower streets with higher tree canopy coverage; compared to other neighborhoods where temporal patterns are consistent throughout. During the daytime, the maximum temperature difference between neighborhoods was significant and as high as 11k whereas at nighttime the difference was reduced to 2-3k (Fig 2). Neighborhoods with higher daytime temperature release absorb heat at a faster rate due to wind speed and higher sky view factor. However, it poses approximately a three-hour of short window when the drop is observed where neighborhoods with higher daytime temperature experience lower nocturnal temperatures than neighborhoods with lower daytime temperatures. However, the temperature raises at a significantly higher rate with sunrise.

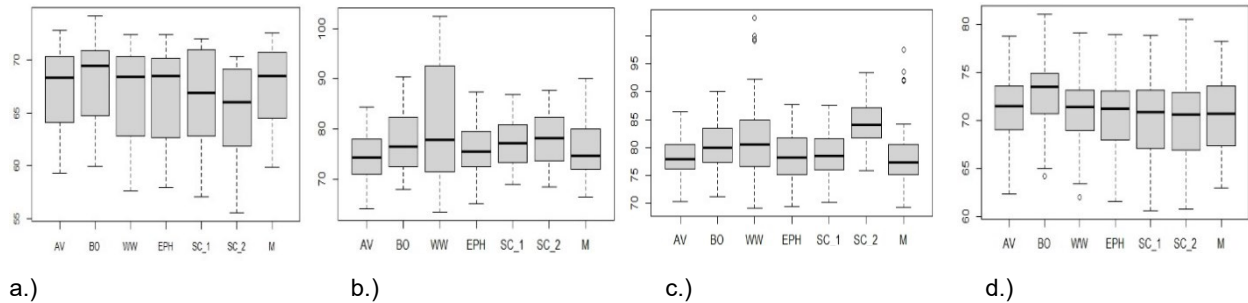

Figure 1: Boxplot displaying a.) Early morning Temperature Profile between 3 AM- 8 AM, b.) Noon Temperature Profile between 9 AM- 2 PM, c.) Afternoon Temperature Profile between 3 PM- 8 PM, d.) Night Temperature Profile between 9 PM- 2 AM
 Neighborhood Abbreviation- AV: Avondale, BO: Bond Hills, WW: Westwood, EPH: East Price Hill, SC_1: South Cumminsville_1, SC_2: South Cumminsville_2, M: Millvale

We used multivariate regression where outdoor dry bulb temperature (y) was used as a dependent variable and relative humidity, wind speed, street aspect ratio, impervious surface, parking lot, bare ground, proximity to the highway, tree canopy cover, grassland was used as independent variables ($x_1, x_2 \dots x_n$).

$$y = b_1x_1 + b_2x_2 + \dots + b_nx_n + c \dots \dots \dots (1)$$

Unlike any other regression methods, the major advantage of opting for stepwise regression is the algorithm tests the best model in three different ways to find the “best” suited predictors. Three different stages can provide three different models which may help to run further analysis before opting for the “best” model. For our study, all three regression models provided the same “best” variable subset. Both forward and backward regression shows wind speed, street aspect ratio, proximity to the highway, and tree canopy cover are the best subset variable to predict daytime outdoor temperature with an R-squared value of 0.4718 with an adjusted R-squared of 0.4689. South Cumminsville and Millvale had the most streets fall in the upper quartile followed by Bond Hill and East Price Hill. The wider range of temperature has been observed for Westwood as it poses the most diverse landscape. However, for nighttime, the parent set that includes all variables provides an R-squared value of 0.9818 with an adjusted R-squared of 0.9799. Thus, our results show a larger number of parameters need to be considered to predict nocturnal air temperature. This is mostly due to the complex heat exchange between surface and air.

Table 3: Summary Statistics of Early morning Temperature between 3 AM- 8 AM

Neighborhoods	Min	Max	1 st Qu.	Mean	Median	3 rd Qu.	Skewness
Avondale	59.29	72.83	64.28	67.17	68.31	70.30	Left skewed
Bond Hills	59.97	74.18	64.87	68.13	69.48	70.84	Left skewed
Westwood	57.65	72.38	62.82	66.78	68.39	70.27	Left skewed
East Price Hill	57.96	72.36	62.64	66.78	68.47	70.12	Left skewed
South Cumminsville_1	57.07	71.96	62.95	66.39	66.85	70.94	Normal Distribution
South Cumminsville_2	55.56	70.34	61.95	64.95	66.05	69.06	Slight Left skewed
Millvale	59.85	72.52	64.48	67.42	68.47	70.74	Left skewed

Table 4: Summary Statistics of Noon Temperature Profile between 9 AM- 2 PM

Neighborhoods	Min	Max	1 st Qu.	Mean	Median	3 rd Qu.	Skewness
Avondale	64.08	84.47	71.28	74.43	74.33	77.76	Normal Distribution
Bond Hills	67.98	90.47	72.57	77.77	76.60	82.28	Right skewed
Westwood	63.42	88.44	71.63	81.48	77.86	92.60	Right skewed
East Price Hill	65.12	87.44	72.55	75.91	75.50	79.53	Slight Right skewed
South Cumminsville_1	68.96	86.86	73.45	77.36	77.19	80.79	Normal Distribution

South Cumminsville_2	68.40	87.67	73.65	78.10	78.17	82.25	Normal Distribution
Millvale	66.42	90.14	72.08	75.95	74.63	79.66	Right skewed

Table 5: Summary Statistics of Afternoon Temperature Profile between 3 PM- 8 PM

Neighborhoods	Min	Max	1 st Qu.	Mean	Median	3 rd Qu.	Skewness
Avondale	70.22	86.34	76.14	78.15	77.89	80.53	Normal Distribution
Bond Hills	71.18	90.08	77.33	80.19	79.89	83.40	Normal Distribution
Westwood	69.08	91.20	76.75	81.45	80.47	84.86	Right skewed
East Price Hill	69.35	87.75	75.14	78.44	78.20	81.57	Normal Distribution
South Cumminsville_1	70.10	87.59	76.01	78.76	78.56	81.52	Normal Distribution
South Cumminsville_2	75.83	93.50	81.72	84.29	84.03	87.13	Normal Distribution
Millvale	69.29	97.46	75.25	78.37	77.34	80.45	Normal Distribution

Table 6: Summary Statistics of Night Temperature Profile between 9 PM- 2 AM

Neighborhoods	Min	Max	1 st Qu.	Mean	Median	3 rd Qu.	Skewness
Avondale	62.36	78.83	69.04	71.01	71.49	73.60	Normal Distribution
Bond Hills	64.22	81.13	70.72	72.57	73.50	74.97	Left skewed
Westwood	62.01	79.18	68.96	70.92	71.40	73.17	Left skewed
East Price Hill	61.61	78.95	68.02	70.53	71.24	73.12	Left skewed
South Cumminsville_1	60.59	78.87	67.15	69.99	70.88	73.13	Left skewed
South Cumminsville_2	60.78	80.55	66.94	69.97	70.64	72.88	Left skewed
Millvale	62.94	78.25	67.38	70.45	70.70	73.62	Normal Distribution

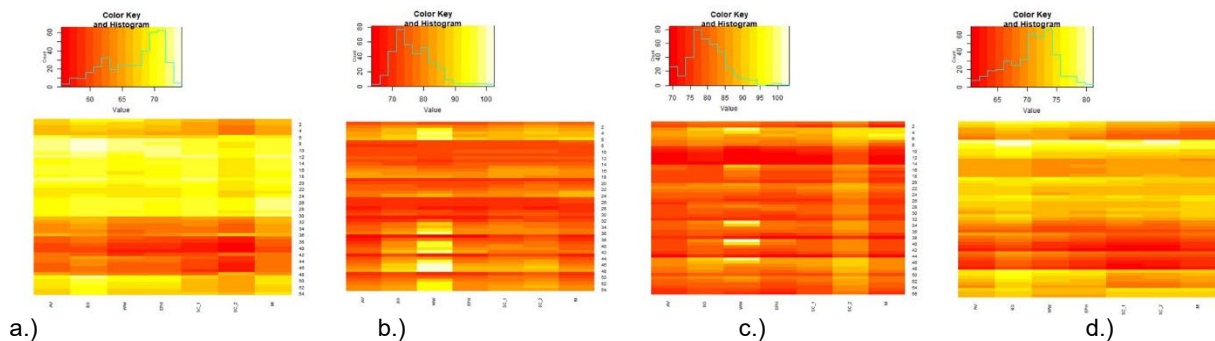

Figure 2: Heatmap matrix has been used to normalize input data by running a clustering algorithm to visualize each observation point for a.) Early morning Temperature Profile between 3 AM- 8 AM, b.) Noon Temperature Profile between 9 AM- 2 PM, c.) Afternoon Temperature Profile between 3 PM- 8 PM, d.) Night Temperature Profile between 9 PM- 2 AM.

Neighborhood Abbreviation- AV: Avondale, BO: Bond Hills, WW: Westwood, EPH: East Price Hill, SC_1: South Cumminsville_1, SC_2: South Cumminsville_2, M: Millvale

3.0 DISCUSSION

Our preliminary result from statistical modeling shows predictor and response variable behaves differently in the system to create their unique microclimate interaction including a prevalence of high daytime and reduced nighttime UHI among neighborhoods. The proximity to freeways and industries is critical to the high heat exposure in low-income communities. In South Cumminsville and Millvale, lack of tree canopy cover and high impervious surface, as a function of low street aspect ratio, are prominent urban morphology parameters associated with UHI. As the daytime temperature is related to thermal absorption and nocturnal temperature relates to thermal release rate, our predictor variables subset behaves differently for daytime and nocturnal outdoor temperature prediction. With all or most of the variables (Table 2), the outcome of our daytime temperature model includes an insignificant p-value. Our results show urban surface warming rates are strong and higher in the morning as surface heat sharing through convection favors heat storage; in the afternoon it is the reverse increasing the cooling rates by enhancing the net loss of longwave radiation by reducing the surface air temperature and surface heat storage. The heterogeneous nature of the urban fabric makes it difficult to characterize using a single representative temperature. During night time the exchange of sensible heat between an urban solid surface and the adjacent air depends upon the temperature of the air near the

surface. As urban surfaces are not homogeneous in material, this impacts airflow, solar exposure, and radiation for each surface. Our fixed station close to highways and large vacant industrial land or parking lot shows significantly higher temperatures during the daytime. During the daytime, wind speed, street aspect ratio, proximity to the highway, and tree canopy cover are the best subset variable to predict daytime outdoor temperature whereas the parent set that includes all variables provides many accurate results to predict nighttime temperatures. Additionally, we have observed, as the material has different thermal absorption and release properties, one set of subset variables will not be able to represent the complex heterogeneity of urban systems for both day and night time. For all of our studied neighborhoods except a few areas of Westwood, we have observed, single-family residential properties have a significant offset from the street, often separated by grassland. The cooling rates for grassland and park (without trees) are much larger because of their larger sky view factor due to the relatively small thermal admittance of dry soil. During days with higher humidity as soils tend to be wet thermal admittance is comparatively larger. Approximately two after sunrise, the areas with more grassland and unshaded surfaces tend to have higher temperatures whereas during noon neighborhoods with more impervious surfaces and low canopy cover start warming up at a much faster rate.

CONCLUSION

As demonstrated by our pilot project, urban morphology plays a significant role in influencing the air temperature which further can limit or exceed the overheating risk. Data published by International Organization for Migration (IOM, 2011) shows the overheating risk is mostly associated with indoor thermal comfort as people spend most of their time indoors during heatwaves. Studies on historical heatwaves such as Chicago 1995, Greece 1987, Europe 2003, and Russia 2010 have established a positive correlation between outdoor temperature and negative health impact. Even though this study has not used hospital admission data or any health data to establish the relationship between urban heat and health, but rather uses outdoor temperature as a proxy variable to understand health risks. Extreme weather conditions such as heat or cold waves (cold snaps) in urban areas have a significant negative impact on the quality of life and health of urban citizens. Exposure to extreme heat can impact a person's ability to thermoregulate body temperature, resulting in heat stress, which may lead to death. Neighborhoods with increased air temperature and more hours of sun exposure can cause heat-related death, cardiovascular disease, and heart attacks. Higher air pollutant levels can increase respiratory disease and hospital admissions. Poor air quality possesses a great threat to people, especially those in poverty who lack access to health care and proper housing conditions. Disproportionate exposure to heat specifically during noon and night time indicate few neighborhoods will be at a higher risk of heat-related physical health outcomes such as respiratory breathing problems, heat cramp, heat strokes, diarrhea as well as mental health conditions such as depression, anxiety, fatigue, aggression and even higher rates of suicide. This disparity is solely based on the location of the property. The widespread inequalities in heat exposure are often defined by race and ethnicity but they may be well explained by differences in socioeconomic variables alone. Socioeconomic variables such as access to public transportation and healthcare have been prominent determinants of heat vulnerability. The elderly, and people without a personal vehicle who lives in areas with less or no public transportation often fails to reach cooler shelter during heat waves. US census report shows in 2020, 8.6 percent of people, did not have health insurance at any point during the year. People with access to healthcare and insurance often avoid seeking medical care even when they suspect it may be necessary, even individuals with major health problems or who are experiencing symptoms avoid seeking medical care. From an architecture and urban design standpoint, despite several literatures on mitigation and resilience on indoor and outdoor thermal comfort, very limited literature tries to establish the relation between the two even though multiple studied variables on building and city scale are similar for both conditions. To study the two-way interaction of buildings and microclimate, the limited number of studies that establish a correlation between indoor and outdoor thermal comfort, use whole building simulation with limited to no surrounding consideration and apply weather station meteorological and future projected climate data as input. The studies that use satellite data are often city-scale studies. However, the significance of the microclimate argument stands on the reliance on urban morphology and change in temperature on a granular level, thus studying microclimate phenomena and UHI on a macro or city scale is a contradiction to its fundamental definition itself. Similarly, using meteorological climate data or future projected climate data ignores the unequal exposure to urban heat on a micro-scale. With the complexity and heterogeneity of the urban environment, extrapolation of local-scale results to a city or national level cannot be suggestive.

REFERENCES

- Aflaki, A., Mirnezhad, M., Ghaffarianhoseini, A., Ghaffarianhoseini, A., Omrany, H., Wang, Z.-H., & Akbari, H. (2017). Urban heat island mitigation strategies: A state-of-the-art review on Kuala Lumpur, Singapore and Hong Kong. *CITIES*, 62, 131–145. <https://doi.org/10.1016/j.cities.2016.09.003>
- Akbari, H., & Kolokotsa, D. (2016). Three decades of urban heat islands and mitigation technologies research. *Energy and Buildings*, 133, 834–842. <https://doi.org/10.1016/j.enbuild.2016.09.067>
- Bao, Junzhe, Xudong Li, and Chuanhua Yu. 2015. "The Construction and Validation of the Heat Vulnerability Index, a Review." *INTERNATIONAL JOURNAL OF ENVIRONMENTAL RESEARCH AND PUBLIC HEALTH* 12 (7): 7220–34. <https://doi.org/10.3390/ijerph120707220>.
- Gabbe, C. J., & Pierce, G. (2020). Extreme Heat Vulnerability of Subsidized Housing Residents in California. *Housing Policy Debate*, 30(5), 843–860. <https://doi.org/10.1080/10511482.2020.1768574>
- Grimmond, C. S. B., Roth, M., Oke, T. R., Au, Y. C., Best, M., Betts, R., Carmichael, G., Cleugh, H., Dabberdt, W., Emmanuel, R., Freitas, E., Fortuniak, K., Hanna, S., Klein, P., Kalkstein, L. S., Liu, C. H., Nickson, A., Pearlmutter, D., Sailor, D., & Voogt, J. (2010). Climate and more sustainable cities: Climate information for

- improved planning and management of cities (Producers/Capabilities Perspective). *Procedia Environmental Sciences*, 1(1), 247–274. <https://doi.org/10.1016/j.proenv.2010.09.016>
- Hoffman, J. S., Shandas, V., & Pendleton, N. (2020). The Effects of Historical Housing Policies +doi:10.3390/cli8010012
- Haddad, S., Ulpiani, G., Paolini, R., Synnefa, A., & Santamouris, M. (2020). Experimental and Theoretical analysis of the urban overheating and its mitigation potential in a hot arid city ? Alice Springs.
- Hirano, Y., & Fujita, T. (2012). Evaluation of the impact of the urban heat island on residential and commercial energy consumption in Tokyo. *ENERGY*, 37(1), 371–383. <https://doi.org/10.1016/j.energy.2011.11.01>
- International Organization for Migration (IOM), Environment and Climate Change Division, Geneva, Tech. *Extreme Heat and Migration*. 2011. https://publications.iom.int/system/files/pdf/mecc_infosheet_heat_and_migration.pdf.
- Jandaghian, Z., & Akbari, H. (2020). Effects of increasing surface reflectivity on aerosol, radiation, and cloud interactions in the urban atmosphere. *THEORETICAL AND APPLIED CLIMATOLOGY*, 139(3–4), 873–892. <https://doi.org/10.1007/s00704-019-03006-4>
- Krayenhoff, E S, A Christen, A Martilli, and T R Oke. 2014. "A Multi-Layer Radiation Model for Urban Neighbourhoods with Trees." *BOUNDARY-LAYER METEOROLOGY* 151 (1): 139–78. <https://doi.org/10.1007/s10546-013-9883-1>.
- Khan, H. S., Paolini, R., Santamouris, M., & Caccetta, P. (2020). Exploring the Synergies between Urban Overheating and Heatwaves (HWs) in Western Sydney. *ENERGIES*, 13(2). <https://doi.org/10.3390/en13020470>
- Magli, S., Lodi, C., Lombroso, L., Muscio, A., & Teggi, S. (2015). Analysis of the urban heat island effects on building energy consumption. *International Journal of Energy and Environmental Engineering*, 6(1), 91–99. <https://doi.org/10.1007/s40095-014-0154-9>
- Niu, Y., Li, Z., Gao, Y., Liu, X., Xu, L., Vardoulakis, S., Yue, Y., Wang, J., & Liu, Q. (2021). A Systematic Review of the Development and Validation of the Heat Vulnerability Index: Major Factors, Methods, and Spatial Units. *Current Climate Change Reports*, 7(3), 87–97. <https://doi.org/10.1007/s40641-021-00173-3>
- Oke, T. R. *Urban Climates*. Cambridge, United Kingdom: Cambridge University Press, 2017
- Park, Chae Yeon, James H Thorne, Shizuka Hashimoto, Dong Kun Lee, and Kiyoshi Takahashi. 2021. "Differing Spatial Patterns of the Urban Heat Exposure of Elderly Populations in Two Megacities Identifies Alternate Adaptation Strategies." *SCIENCE OF THE TOTAL ENVIRONMENT* 781 (August)
- Rathi, S. K., Chakraborty, S., Mishra, S. K., Dutta, A., & Nanda, L. (2022). A heat vulnerability index: Spatial patterns of exposure, sensitivity and adaptive capacity for urbanites of four cities of india. *International Journal of Environmental Research and Public Health*, 19(1). <https://doi.org/10.3390/ijerph19010283>
- Stewart, I D, E S Krayenhoff, J A Voogt, J A Lachapelle, M A Allen, and A M Broadbent. 2021. "Time Evolution of the Surface Urban Heat Island." *EARTHS FUTURE* 9 (10). <https://doi.org/10.1029/2021EF002178>.
- Santamouris, M, C Cartalis, A Synnefa, and D Kolokotsa. 2015. "On the Impact of Urban Heat Island and Global Warming on the Power Demand and Electricity Consumption of Buildings-A Review." *ENERGY AND BUILDINGS* 98 (SI): 119–24. <https://doi.org/10.1016/j.enbuild.2014.09.052>.
- Stewart, I D, T R Oke, and E S Krayenhoff. 2014. "Evaluation of the 'local Climate Zone' Scheme Using Temperature Observations and Model Simulations." *International Journal of Climatology* 34 (4): 1062–80. <https://doi.org/10.1002/joc.3746>.
- Sailor, D. J. (2014). Risks of summertime extreme thermal conditions in buildings as a result of climate change and exacerbation of urban heat islands. *BUILDING AND ENVIRONMENT*, 78, 81–88. <https://doi.org/10.1016/j.buildenv.2014.04.012>
- Wilson, B, and A Chakraborty. 2019. "Mapping Vulnerability to Extreme Heat Events: Lessons from Metropolitan Chicago." *Journal of Environmental Planning and Management* 62 (6): 1065–88. <https://doi.org/10.1080/09640568.2018.1462475>.
- Yu, C., Hu, D., Wang, S., Chen, S., & Wang, Y. (2021). Estimation of anthropogenic heat flux and its coupling analysis with urban building characteristics - A case study of typical cities in the Yangtze River Delta, China. *SCIENCE OF THE TOTAL ENVIRONMENT*, 774. <https://doi.org/10.1016/j.scitotenv.2021.145805>

ARCC 2023 RESEARCH PAPERS
Technology and Architecture Track

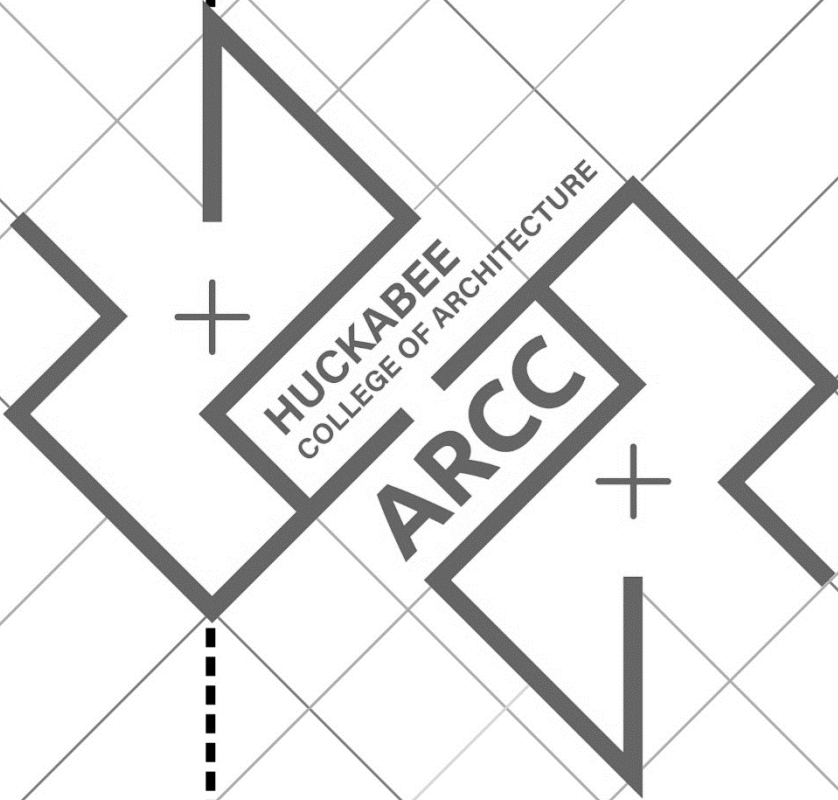

A Framework Proposal for Developing Historical Video Games Based on Player Review Data Mining to Support Historic Preservation

Sarvin Eshaghi¹, Sepehr Vaez Afshar¹, Mahyar Hadighi¹

¹Texas Tech University, Lubbock, TX

ABSTRACT: Historic preservation, which is a vital act for conveying people's understanding of the past, such as events, ideas, and places to the future, allows people to preserve history for future generations. Additionally, since the historic properties are currently concentrated in urban areas, an urban-oriented approach will contribute to the issue. Hence, public awareness is a key factor that paves the way for this conservation. Public history, a history with a public audience and special methods of representation, can serve society in this regard. Historical video games, which get their game objectives from the past, can be considered a form of public history, raising people's awareness and letting them gain historical experience. While plenty of studies focused on this content with various approaches, this study takes the topic under consideration with a player-oriented focus. The research uses the Steam video game digital distribution service database to explore the existing historical games based on their genre, player scale, dimension, VR compatibility attributes, and player rating. The database includes 1,148 games published between 2002 and 2022, filtered as historical by Steam tags and sorted by player review. For the data collection, the study uses the Octoparse web scraping tool for data extraction, and for the data analysis, it uses RapidMiner Studio data mining software. The study aims to provide a framework applicable to the development of commercially playable historical video games contributing to heritage preservation by raising public awareness in the context of public history.

KEYWORDS: Historic Preservation, Public Awareness, Video Games, Data Scraping, Data Mining, Virtual Reality

INTRODUCTION

American urban neighborhoods and communities were in danger of destruction in the 1950s and 1960s due to the damaging effects of freeway construction and urban renewal. Hence, the town planners were invited to be more sensitive, maintain, and enhance the neighborhoods' physical fabric. In 1965, the so-called concerns led to the promotion of historic districts in the United States (Hamer 2000). Currently, the National Park Service, the US agency managing national parks, monuments, and other natural, historical, and recreational properties, defines historic preservation as humans' communication with their past regarding the future. Through historic preservation, people can figure out the important parts of history and the factors which could be preserved for the future. It is a prominent way to convey people's understanding of the past to the next generations. These understandings may include the people, events, and ideas, as well as places. The professions embracing the historic preservation field are as varied as architects, landscape architects, historians, archeologists, curators, and many other experts (NPS 2022). Hence, the historic preservation field expanded its spectrum of expertise towards being an urban occupation since the beginning of the current century through its intersection with urban revitalization.

Given the high concentration of historic buildings and neighborhoods in urban areas, preserving historic properties and districts requires an urban-oriented approach to inclusion and economic development (Ryberg-Webster & Kinahan 2014). According to De Guichen and d'Ieteren (2009), the survival of this heritage relies to a great extent on public awareness and enlightened decision-making on the part of authorities. Hence, in this context, public history—differentiated from traditional academic history in terms of target audience and locations of representation—raises awareness through the urban area itself instead of via written or oral academic discourses (Eshaghi et al. 2021; Plummer 2001). Due to Howe and Kemp, public history is multidisciplinary in its nature and requires well-defined objectives. Multiple, ever-changing, and diverse audiences accounted for its venues. These audiences may have various socio-economic classes, cultural settings, and educational levels. The public historians' task is to advocate expansive public history knowledge and awareness. However, the public history contents, including visuals, texts, and oral data, rarely demonstrate the comprehensive research behind it (Plummer 2001). Awareness of the importance of heritage buildings and neighborhoods can engender a public effort towards preservation—an effort that should come with opportunities for the enjoyment of the focal heritage (De Guichen and d'Ieteren 2009; Vaez Afshar et al. 2021; Afshar et al. 2022).

In this regard, historical game studies with a multitude of themes, flourishing year by year (Wright 2018), can provide both education about the historical issues at stake and provide entertainment focused on preservation. Following the popularity of the games, the historical game studies field recognized the importance of outreach within the domain.

Hence, within the last fifteen years, video games experienced an explosion of enthusiasm towards including history as their content (Bierstedt 2022). Additionally, since the appearance of historical game studies, in general, game studies, the pedagogical potential for learning has been pointed out within video games. Also, people have adapted to entertain, learn, and acquire skills via interacting and engaging with a variety of interactive contexts and multimedia content (Redder and Schott 2022).

In historical video games, which are a game genre whose gaming objectives are based on the past, it is assumed that the player gains key historical experiences of the setting, cultures, societies, and periods. While the traditional written or visual historical contents are not directly replaceable with mentioned historical video games, their interactiveness and multimodality allow the players to freely explore the historical places, spaces, artifacts, and inhabitants and experience the practices and rituals through hearing sounds and languages. Since historical video games are beyond linearly moving images associated with a narrative, players need to understand them (Redder & Schott 2022; Varinlioğlu et al. 2022). The puzzles, challenges, and obstacles required to be solved for proceeding within the game are the gamific features of the 2D or 3D worlds within the video games (Adams & Rollings 2010; Vaez Afshar et al. 2022). Hence, the game system's parameters still shape a player's agency despite video games being highly interactive (Aarseth 2007). As historical video games both function as a descriptive historical text and a systematic form of play guiding attention, learning, and activity, generating an inevitable efficient platform for presenting and exploring various histories. Since the emergence of historical video games, they have reproduced and allowed a chance to experience a wide range of histories (Redder & Schott 2022).

The carried research in the historical video games field demonstrates the concerns of scholars exploring the intersection of history and games about the form of historical games, the effect of false storytelling, and the gamific representation analyses focusing on the accuracy and the authenticity of the historical content provided within the games (Elliott 2017; Morley 2020; Rollinger 2020). However, this study explores various aspects of historical video games via web scraping and data mining, focusing on the players' notions. The mined features include the games' compatibility with head-mounted display (HMD) devices providing a virtual reality (VR) experience, player scale, dimension, and genre. It aims to figure out the characteristics effective in the player rating within the analyzed games. The ultimate goal of the analysis is to provide a framework applicable to the development of commercially playable historical video games contributing to heritage preservation by raising public awareness in the context of public history. Below follows a literature review exploring the existing historical video games and the investigations that scholars have conducted in this field.

1.0 HISTORICAL VIDEO GAMES

Many studies in the literature are investigating the developed and commercially played historical video games to figure out the contents carried in them, the way they convey these contents, the reasons these games got popular among gamers, their educational aspects, and so on.

Redder and Schott (2022), in their study, mentioned several historical video games before their main case study. Due to Redder and Schott (2022), current hit historical games like *Assassin's Creed: Origins* (2017), *Red Dead Redemption 2* game occurring in America's wild-west period setting (2018), and *Total War: Three Kingdoms* (2019), sold respectively 155 million copies till 2020, 38 million till 2021, and over one million in the first week following their release dates. These games carry an educational value beyond barely written content by demonstrating authentic and periodically credible historical elements. *Civilization* series (1991-2016) and *Humankind* (2021) are samples of historical games reflecting histories involving resource management and global strategy in civilization development. As another type, *Kingdom Come: Deliverance* (2018) and *Titanic: Honor and Glory* games provide vast explorable worlds to the players as role-playing games to experience the documented histories by scholars. On the other hand, *Wolfenstein II: The New Colossus* (2017) is a sample touching history indirectly in alternate timelines. In their main case study, *A Plague Tale: Innocence* (2019), they used a multimodal approach exploring both the presented historical content in game design and the gameplay. They focused on imaginative history in their research, including fiction occurring within period-accurate elements. The researchers introduce this game as valuable for its capability in history education regarding the re-mediation of past concerning beliefs, i.e., the Black Death.

In another attempt, Bierstedt (2022), in his study, in addition to mentioning the common existing outreaches focusing on consultancy, education, and new game developments in the historical video games field, noted the importance of the fourth category, digital criticism, in the form of Let's Play. Due to him, while a historian can analyze historical video games using this method as a tool, its potential is yet underestimated. Hence, he tried to fix the issue from two points of view; first, by highlighting the requirement of various outreach methods via case studying the recent high-cost games, and second, by emphasizing the advantages of digital platform outreaches theoretically and practically with some experiments. He also discourses the streamer-historian category definition. These historians critique historical video games by playing and commenting in the form of videos or texts.

2.0 RESEARCH

2.1. Data collection

As previously mentioned, this research will investigate historical video games based on their attributes focusing on the players' ideas and reviews regarding the games. The research undertaking is based on the extensive video game digital distribution service database, Steam (Steam 2022). Since this research is player-oriented, we used the tagging system and the user review information pool of Steam. Tags are a feature of this database that either the developer, the players, or the Steam moderators can apply to a game. These tags, which include the themes, terms, and genres, allow them to markup games for a better description of the game to others (Steam Tags 2022). Additionally, Steam users who have playtime in a specific game are allowed to add reviews to it and share their experiences with others. Steam uses a combination of positive and negative reviews to calculate a review score (Steamworks 2022). These reviews have a spectrum including overwhelmingly positive, very positive, positive, mostly positive, mixed, mostly negative, negative, very negative, and overwhelmingly negative, which are also related to the review number (Gamedeveloper 2022). Hence, by implementing the historical tagging filter and sorting them based on user review, we ended up with a sample of 1,148 games produced in the period of 2002 to 2022, which are historical based on the developers or the players.

In the next step, the data gathering, we applied web scraping using Octoparse (Octoparse 2022), a modern visual web data extraction software. Via Octoparse, both experienced and inexperienced people can extract bulk information from various websites with almost no coding needed in a time and effort-efficient manner. In this software, by entering the required website URL, it is possible to click on the target data and run the extraction to get the web page's information as a spreadsheet (Ahamad et al. 2017). To do so, we first extracted basic info like the game title and release date. Then, we checked the most used tags within these games to decide which attributes' information we wanted to gather. Among those tags, we selected the genres. Game genres are understandable categories identifying the gameplay, and they can be both combined with other genres and can be divided into sub-genres (Clearwater 2011). On the other hand, due to Heintz and Law (2015), while it is hard to distinguish the difference between game genre and game type, the first one is defined as gameplay style and artistic design, and the other as gameplay mechanics and functionality and architecture. However, in practice, they may be used conversely. Hence, to determine the genres among the tags, we both used Steam's categories (Steam Tags 2022) and the intersection of several papers defining the genres (Apperley 2006; Arsenault 2009; Clearwater 2011; Elliott et al. 2012; Heintz & Law 2015). Consequently, we chose RPG, Action, Adventure, Simulation, and Strategy as the investigating genres, defined in Table 1.

Table 1: Genre definitions. Source: (Apperley 2006)

<i>Genre</i>	<i>Definition</i>
<i>Action</i>	<i>It is usually extensively performative, differing from other performative genres, requiring the player's engagement in extreme nontrivial actions to make the ergodic traversal. Additionally, the player should select the appropriate inputs to perform a required action for the game.</i>
<i>Adventure or RPG</i>	<i>They are closely connected to the literary genre of fantasy. However, in these games, the players take a character model and act in that environment without real role-playing. They try to suggest something to the computer that is not in the program.</i>
<i>Simulation</i>	<i>It simulates flying, driving, sports, and the town, city, and small community dynamics.</i>
<i>Strategy</i>	<i>Divided into real-time and turn-based strategy subgenres, it has a general god's eye-view towards the taking placed actions generated from more photorealistic depictions. It remediates the strategy table-top board games playing.</i>

Additionally, we gathered data regarding the games' player scale as single or multiplayer, dimension as 2D or 3D, VR compatibility, and rating as a percentage and a positive and negative range. Finally, we combined all the Excel sheets and prepared the final data set. However, due to the inaccuracy of percentage data, in which the number of people rated is effective, we removed the percentage data from the final list (Table 2).

Table 2: A part of the gathered dataset table. Source: (Author 2023)

Game Title	Release Date	Dimension	Player Scale	VR	Rating	RPG Genre	Action Genre	Adventure Genre	Simulation Genre	Strategy Genre
Crowfall: Traces of the Lost Colony	2022	2D	Single Player	No	Mostly Positive	No	No	Yes	No	No
Easy Red 2	2022	3D	Multiplayer	No	Very Positive	No	Yes	No	Yes	Yes
Museum of Mechanics: Lockpicking	2022	2D	Single Player	No	Mixed	No	No	No	Yes	No
Astonishing Baseball Manager	2022	2D	Multiplayer	No	Positive	No	No	No	Yes	Yes
GearCity	2022	3D	Single Player	No	Very Positive	No	No	No	Yes	Yes
Blacksmith Legends	2022	3D	Single Player	No	Mixed	No	No	No	Yes	No
Sunslinger Valley	2022	2D	Single Player	No	Mixed	No	Yes	No	No	No
Legend of the Phoenix	2022	2D	Multiplayer	No	Mixed	No	No	No	Yes	No
Ancient Wars: Sparta Definitive Edition	2022	3D	Single Player	No	Mostly Positive	No	No	No	No	Yes
Decisive Campaigns: Ardennes Offensive	2022	2D	Multiplayer	No	Positive	No	No	No	Yes	Yes
Inua - A Story in Ice and Time	2022	3D	Single Player	No	Positive	No	No	Yes	No	No
Blade&Sword	2022	2D	Single Player	No	Very Positive	No	Yes	Yes	No	No
Battle Cry of Freedom	2022	3D	Multiplayer	No	Mostly Positive	No	Yes	No	Yes	Yes
Leave No One Behind: Ia Drang	2022	3D	Single Player	No	Mixed	No	No	No	Yes	No
Buccaneers! The New Age of Piracy	2022	2D	Single Player	Yes	Very Positive	No	Yes	No	No	No
Buccaneers!	2022	2D	Single Player	Yes	Very Positive	No	Yes	Yes	No	No
Ironsmith Medieval Simulator	2022	3D	Single Player	No	Mostly Negative	No	No	Yes	Yes	No
Hidden Post-Apocalyptic Top-Down 3D	2022	3D	Multiplayer	No	Positive	No	No	No	No	Yes
Gladia	2022	3D	Multiplayer	No	Mostly Negative	No	Yes	No	No	No
Guldford Castle VR	2022	3D	Single Player	Yes	Very Positive	No	No	Yes	No	No
Love and Guillotines	2022	2D	Single Player	No	Mixed	No	No	No	Yes	No
A Series of Temporal Mishaps	2022	3D	Single Player	No	Mostly Positive	No	No	Yes	No	No
Lenin Simulator	2022	2D	Single Player	No	Mixed	No	No	No	Yes	No
Lonely Knight	2022	3D	Single Player	No	Mixed	No	Yes	Yes	No	No
Fursan al-Aqsa: The Knights of the Al-Aq	2022	3D	Single Player	No	Very Positive	No	Yes	No	No	No
Deadly Dozen Reloaded	2022	3D	Single Player	No	Positive	No	Yes	No	No	No
A Little Time	2022	3D	Single Player	No	Mixed	No	No	Yes	No	No
Age of Valakas: Vietnam	2022	2D	Single Player	No	Positive	No	Yes	No	No	No
Colonize Prologue	2022	3D	Single Player	No	Mostly Positive	No	No	No	Yes	No
Card Shark	2022	2D	Single Player	No	Mixed	No	No	Yes	Yes	No
Attack at Dawn: North Africa	2022	2D	Single Player	No	Positive	No	Yes	No	Yes	Yes
Chivalry 2	2022	3D	Multiplayer	No	Very Positive	No	Yes	No	No	No

2.2. Data mining

The current era faced insufficient data gathering with highly accelerated data aggregation growth. Through data mining, it is possible to figure out rules or patterns among this huge bunch of data leading to the detection of new information (Andry et al. 2022). Here, in this study, during the analysis stage of the gathered information set, we used a data mining and machine learning tool, RapidMiner Studio (Rapidminer 2022), for data preprocessing and visualization. The tool has both a Free Open Source and a commercial edition. RapidMiner, which can also be integrated with different programming languages like Python and R, includes standard data mining features ready to use, with no coding required.

In their study, Dol and Jawandhiya (2022) compared several free, open-source data mining tools like KNIME, Keel, Weka, RapidMiner, Orange, and Tanagra. They also described the tools mentioned and their use in various papers via applied data mining techniques such as classification algorithms like Decision Tree, Naïve Bays, and Random Forest, clustering algorithms like K-means, Agglomerative, and association rule algorithms like Apriori, besides the performance parameters. In other researches, the authors used RapidMiner and its data-mining techniques to analyze insurance data, sales transactions in a company, and work accidents data to achieve critical information and predictions (Andry et al. 2022; Ginting & Iqbal 2022; Sani et al. 2022).

The current research uses data mining of the player-generated historical game information in Steam to figure out attributes influencing rating patterns. Firstly, to examine the correlation between the social rating data and all other attributes, the Mutual Information Matrix model is used (Figure 1).

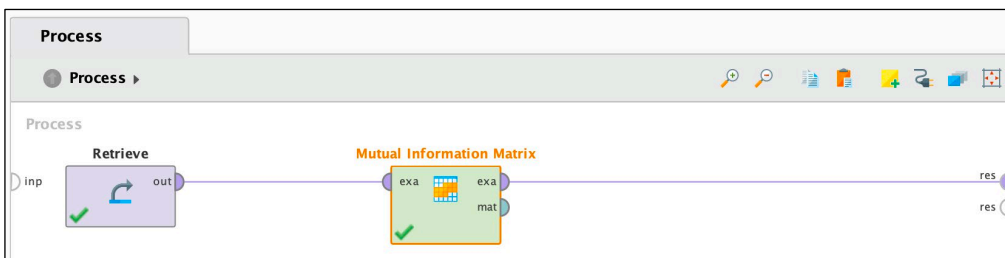

Figure 1: Mutual Information Matrix process. Source: (Author 2023)

Mutual information between two attributes shows their dependence on each other as a quantity. It measures how much data each attribute gives about the others and is a dimensionless quantity. This model's result demonstrates that the dimension and the strategy genre attributes affect the rating most among the others (Figure 2).

Attributes	Release Date	Dimension	Rating	Player Scale	VR	RPG	Action	Adventure	Simulation	Strategy
Release Date	0.259	0.003	0.030	0.002	0.003	0.259	0.000	0.001	0.001	0.002
Dimension	0.003	0.996	0.055	0.009	0.004	0.003	0.007	0.001	0.001	0.014
Rating	0.030	0.055	2.174	0.023	0.005	0.030	0.016	0.016	0.024	0.146
Player Scale	0.002	0.009	0.023	0.978	0.004	0.002	0.011	0.037	0.000	0.035
VR	0.003	0.004	0.005	0.004	0.242	0.003	0.002	0.003	0.002	0.023
RPG	0.259	0.003	0.030	0.002	0.003	0.259	0.000	0.001	0.001	0.002
Action	0.000	0.007	0.016	0.011	0.002	0.000	0.977	0.016	0.026	0.036
Adventure	0.001	0.001	0.016	0.037	0.003	0.001	0.016	0.975	0.101	0.115
Simulation	0.001	0.001	0.024	0.000	0.002	0.001	0.026	0.101	0.995	0.009
Strategy	0.002	0.014	0.146	0.035	0.023	0.002	0.036	0.115	0.009	0.912

Figure 2: Mutual Information Matrix model result. Source: (Author 2023)

Then, for data modeling, we applied a Decision Tree to the dataset after assigning the label role to the rating attribute using the Set Role model (Figure 3).

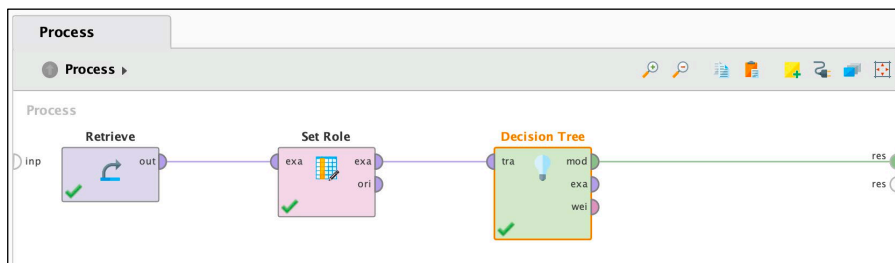

Figure 3: Decision Tree Process. Source: (Author 2023)

A decision tree is generated from the collection of nodes in the form of a tree to make an estimate of a numerical target value or a decision on values affiliation to a class. However, to do so, one of the attributes should be defined as a label attribute allowing the Decision Tree to generate the results based on that. In other words, the role of an attribute explains how other applied Operators handle that specific Attribute. Hence, the label role causes the rating attribute to act as a target Attribute for learning Operators (Figure 4).

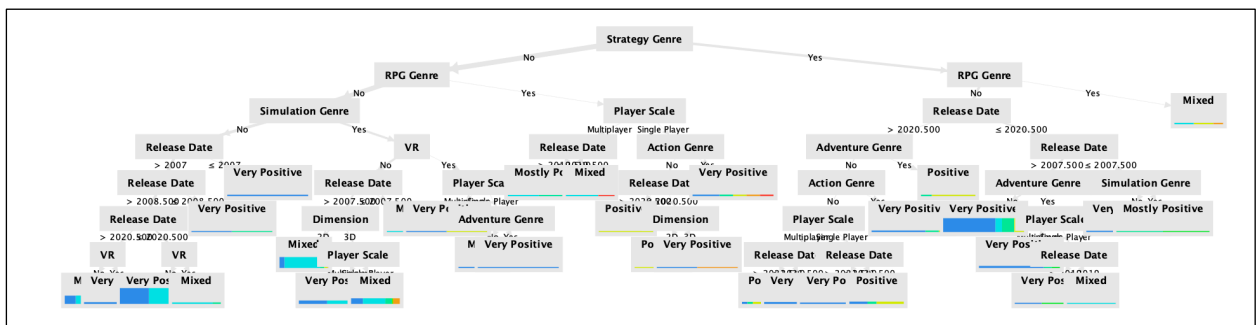

Figure 4: Decision Tree model result. Source: (Author 2023)

Analyzing the results, the Decision Tree shows that while most of the games with very positive ratings are strategy games released after 2020 (Figure 5), the others are games published between 2007 and 2020, compatible with VR technology (Figure 6).

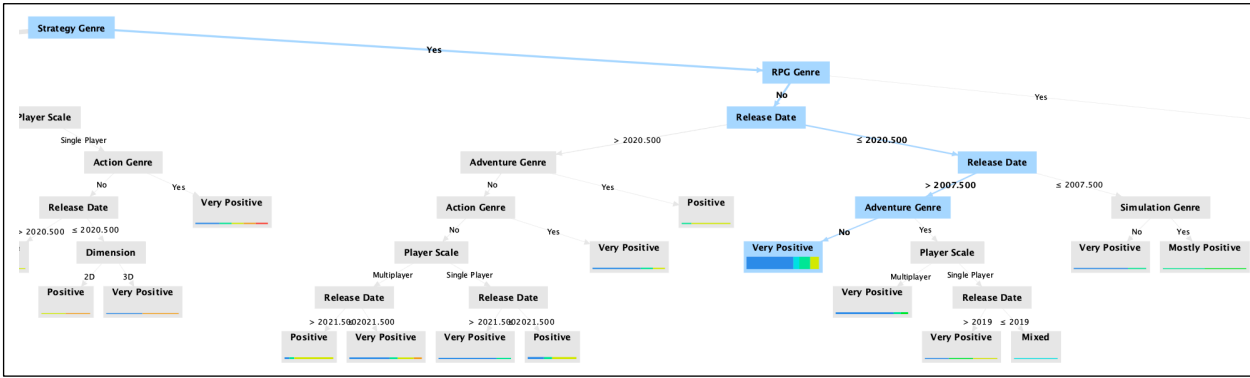

Figure 5: Decision Tree 'Very Positive' rating result (1). Source: (Author 2023)

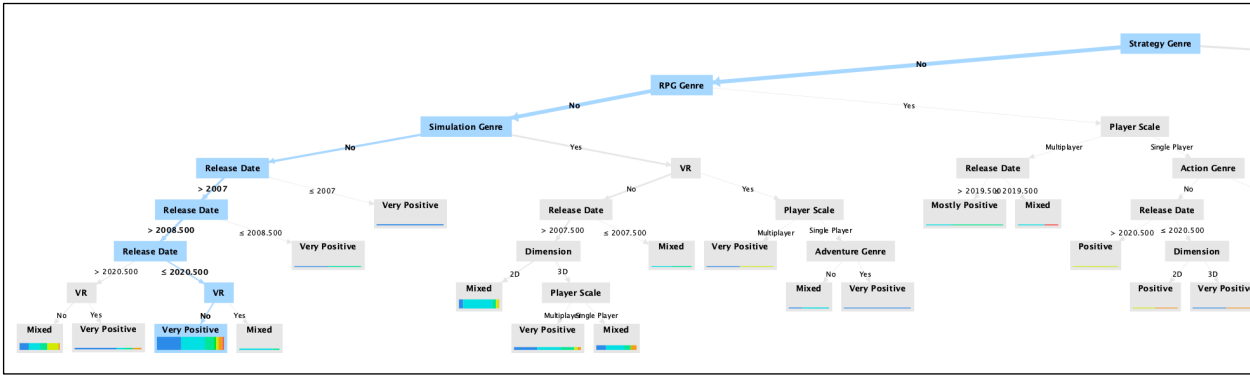

Figure 6: Decision Tree 'Very Positive' rating result (2). Source: (Author 2023)

However, most of the games with mixed rating results appeared as single-player simulation games with no VR compatibility, which were released after 2007 (Figure 7).

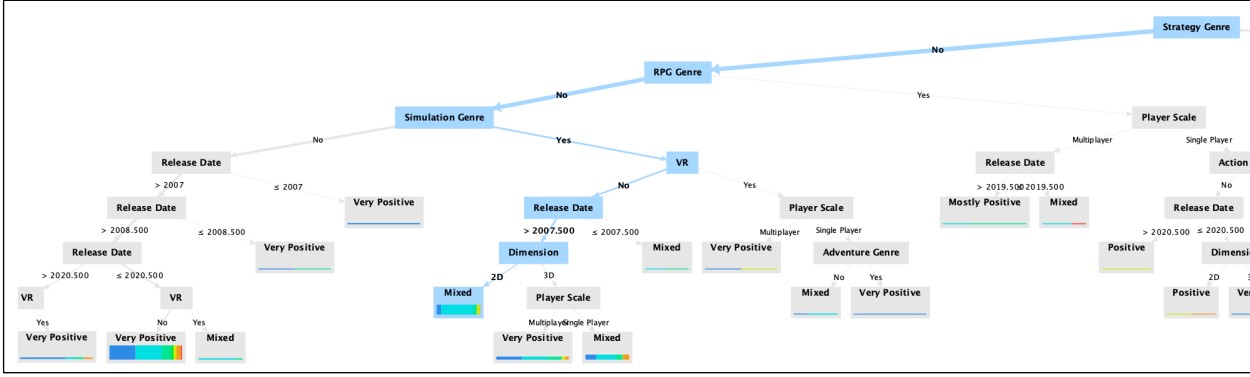

Figure 7: Decision Tree 'Mixed' rating result. Source: (Author 2023)

Regarding the above analytic applications, we visualized the data to see how the attributes are associated with the rating and release date attributes. To have a more understandable result, we converted the rating data to numerical data ranging from 1 for overwhelmingly negative and 9 for overwhelmingly positive. Due to the results, in general, each year, the number of historical video games is raised from 2002 to 2022. Also, we can see a general enhancement in the rating of the games from the past till now.

Figure 8 depicts that while Simulation, Strategy, and Action genres have been used in historical video games since the early 2000s, the RPG genre entered the historical video game field later, after 2014. Additionally, due to the ratings, Action and Strategy historical games are more popular among the players despite the PRG and Simulation ones.

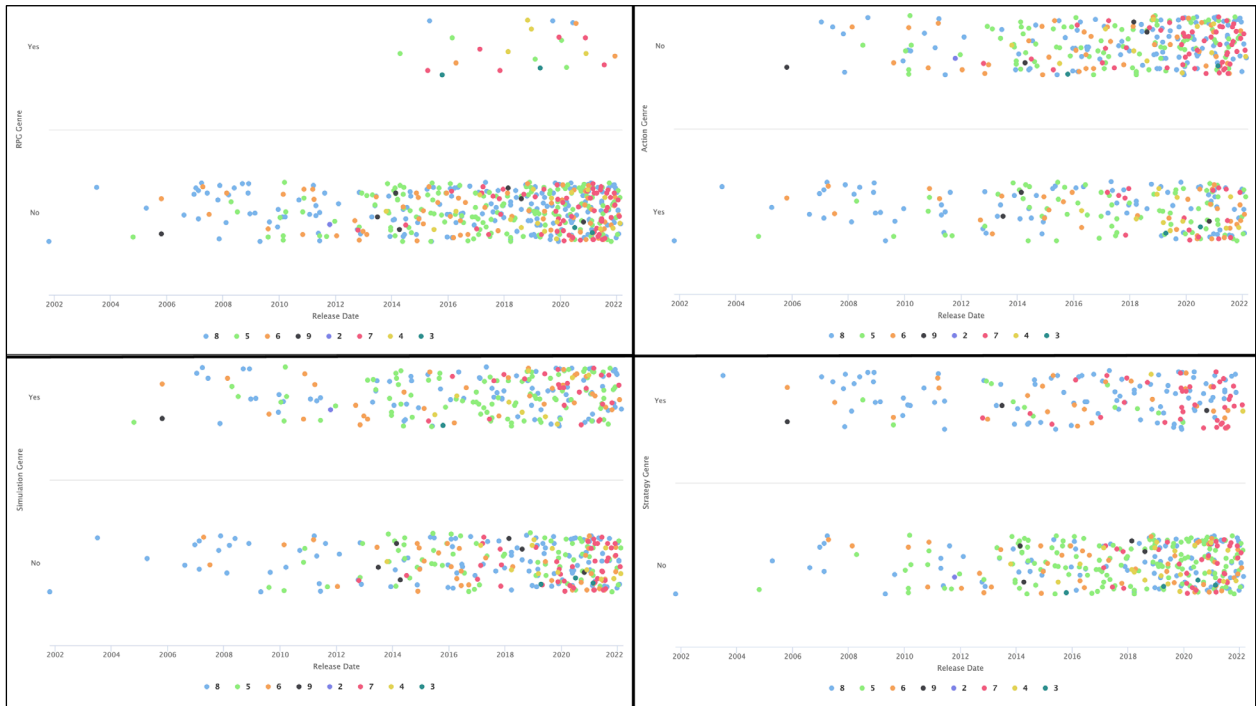

Figure 8: Data Visualization of game genres in association with the rating and the release date. Source: (Author 2023)

Additionally, the results regarding the dimension, player scale, and VR compatibility show that the HMD feature allowing the VR experience is emerged since 2014 and is not well-settled yet in the field (Figure 9). Additionally, single-player games started to be developed a few years after multiplayer and are remarkably more popular and better rated than multiplayer. 2D and 3D games have been distributed almost equally over the years. However, surprisingly, the 2D ones are slightly trendier.

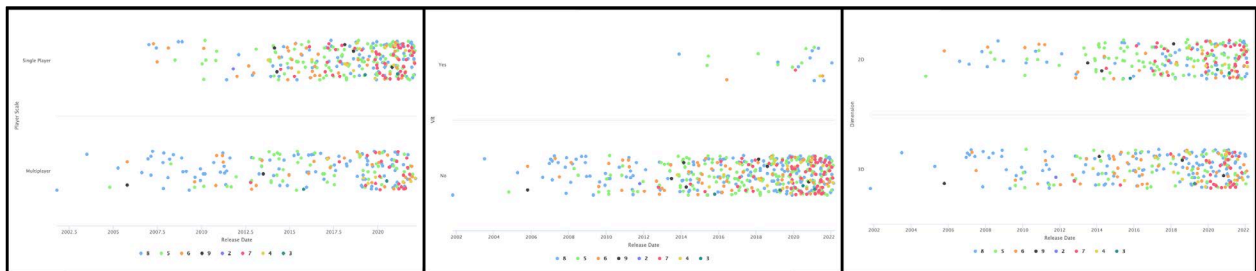

Figure 9: Data Visualization of dimension, player scale, and VR compatibility attributes in association with the rating and the release date. Source: (Author 2023)

CONCLUSION

To conclude, historic preservation allows people to find the important parts of history valuable to be preserved for the next generations and conserve them. Due to the high concentration of the historic properties within the urban areas, historic preservations require an urban-oriented approach. Additionally, public awareness and enlightened decision-making enhance this process. Hence, public history, differing from the academic one, in terms of audience and presentation could serve to this issue. Historical video games are a great sample of public history implementation. These games which their objectives are based on the past, let the player gain historical experience regarding the setting, culture, society and periods.

This study explores the existing 1,148 historical video games published between 2002 and 2022 within the Steam database regarding their genres, player scale, dimension, and VR compatibility through web scraping with Octoparse the data and mining in via RapidMiner Studio to figure the effect of these attributes on the player rating (Figure 10).

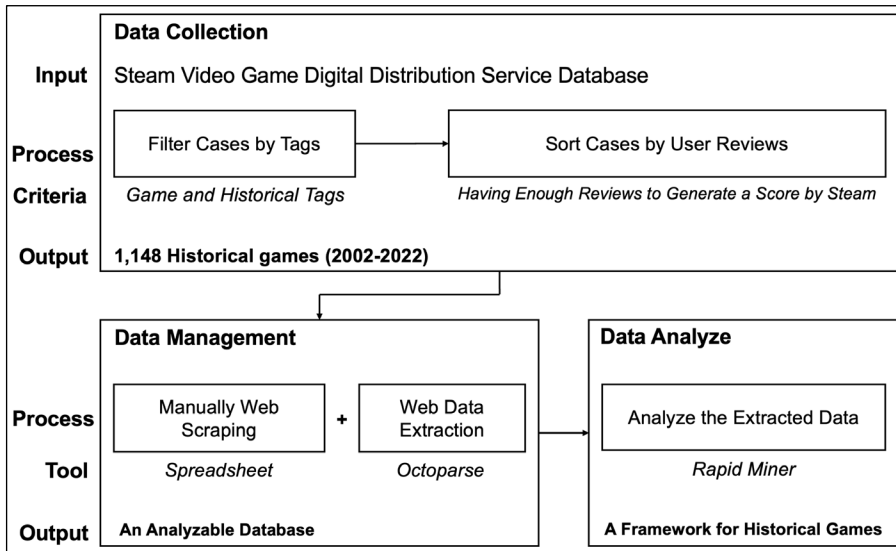

Figure 10: Methodology. Source: (Author 2023)

Due to the results, since the general number of historical video games and their rating amount is getting more as time goes on, it is assumed that historical video games are getting better in terms of quality, or it could also be related to the rise of people's interest in playing historical games. Also, the late emergence of VR games within the historical video game field and their low rating means that VR technology has great potential within this field and needs to be paid more attention to by historical video game developers. Finally, field experts can use this study's results to enhance the quality and popularity of these games among players. Consequently, when used as a tool for education and public awareness, architects and designers can help to preserve and promote the architectural heritage of different cultures and periods. Therefore, the results of this study can be of great value to architects and designers interested in the history and preservation of architectural importance. By understanding the trends and potential of historical video games, they can create new and innovative approaches to architectural design that reflect the historical context and cultural significance of different buildings and structures.

REFERENCES

“Steam Tags (Steamworks Documentation),” n.d. <https://partner.steamgames.com/doc/store/tags>.

Aarseth, E. 2007. *I fought the law: Transgressive play and the implied player*. Situated Play. In Proc. DiGRA. 24-28.

Adams, E., and Rollings, A. 2010. *Fundamentals of Game Design*. Upper Saddle River. N.J: Prentice Hall.

Afshar, S.V., Eshaghi, S., Kim, I. *Pattern Analysis of Virtual Landscape within Educational Games*. 2022. Journal of Digital Landscape Architecture, 7, 435–442. DOI: 10.14627/537724042

Ahamad, D., Mahmoud, D. A. M. M., and Akhtar, M. M. 2017. *Strategy and implementation of web mining tools*. International Journal of Innovative Research in Advanced Engineering. 4. 01-07.

Andry, J. F., Hartono, H., and Honni, A. C. 2022. *Data Set Analysis Using Rapid Miner to Predict Cost Insurance Forecast with Data Mining Methods*. Journal of Hunan University Natural Sciences. 49(6).

Apperley, T. H. 2006. *Genre and game studies: Toward a critical approach to video game genres*. Simulation and gaming. 37(1). 6-23.

Arsenault, D. 2009. *Video game genre, evolution and innovation*. *Eludamos*, Journal for computer game culture. 3(2). 149-176.

Bierstedt, A. F. 2022. *Livestreaming History: The Streamer-Historian and Historical Games Outreach*. Games and Culture. 17(6). 871-884.

Clearwater, D. (2011). *What defines video game genre? Thinking about genre study after the great divide*. 5(8). Data Science Platform | Rapidminer. n.d. <https://www.rapidminer.com/>.

De Guichen, G., and d'Ieteren, C. P. 2009. *Raising awareness for better conservation*. Museum International. 61(3). 98-106.

Dol, S. M., and Jawandhiya, P. M. 2022. *Use of Data mining Tools in Educational Data Mining*. In 2022 Fifth International Conference on Computational Intelligence and Communication Technologies (CCICT) (380-387). IEEE.

Doucet, Lars. “Fixing Steam’s User Rating Charts.” Game Developer. October 6, 2014. <https://www.gamedeveloper.com/business/fixing-steam-s-user-rating-charts>.

Elliott, A.B.R. 2017. *Simulations and Simulacra: History in Video Games*. Práticas da História. (5). 11–41.

Elliott, L., Ream, G., McGinsky, E., and Dunlap, E. 2012. *The contribution of game genre and other use patterns to problem video game play among adult video gamers*. International journal of mental health and addiction. 10(6). 948-969.

- Eshaghi, S., Afshar, S. V., & Varinlioglu, G. 2021. *The Sericum Via: A serious game for preserving tangible and intangible heritage of Iran*. In 9th International Conference of the Arab Society for Computer-Aided Architectural Design: Architecture in the Age of Disruptive Technologies. DOI: 10.6084/m9.figshare.14384318
- Ginting, S. I. B., and Iqbal, M. 2022. *Application of Data Mining to Predict Work Accident Rates using Rapid Miner*. Jurnal Mantik. 5(4). 2694-2701.
- Hamer, D. 2000. *Learning from the past: historic districts and the new urbanism in the United States*. Planning Perspectives. 15(2). 107-122.
- Heintz, S., and Law, E. L. C. 2015. *The game genre map: A revised game classification*. In Proceedings of the 2015 Annual Symposium on Computer-Human Interaction in Play (175-184).
- Howe, B. J., and Kemp, E. L. (Eds.). 1986. *Public History: An Introduction*. Krieger Publishing Company.
- Morley, N. 2020. *Choose Your Own Counterfactual*. Classical Antiquity in Video Games: Playing with the Ancient World. 179.
- Plummer, M. R. 2001. *Public history and public awareness of history*. The University of Texas at Dallas.
- Redder, B. D., and Schott, G. 2022. *Rats, Plagues, and Children, Oh My! Multimodal Representations of the Past in Historical Games: Visuality Design in and for Education*. Video Journal of Education and Pedagogy. 1(aop). 1-21.
- Rochat, Y. 2019. *A Quantitative Study of Historical Video Games 1981–2015*. In Historia Ludens. Routledge. 3-19
- Rollinger, C. (Ed.). 2020. *Classical Antiquity in Video Games: Playing with the Ancient World*. London. and New York: Bloomsbury Publishing.
- Ryberg-Webster, S., and Kinahan, K. L., 2014. *Historic preservation and urban revitalization in the twenty-first century*. Journal of Planning Literature. 29(2). 119-139.
- Sani, A., Waseso, B., Gunadi, G., and Haryanto, T. 2022. *Data Mining on Sales Transaction Data Using the Association Method with Apriori Algorithm*. In 2022 10th International Conference on Cyber and IT Service Management (CITSM). (1-5). IEEE.
- Steam video game digital distribution service | Steamgames. n.d. <https://store.steampowered.com/>
- Steamworks. "User Reviews (Steamworks Documentation)," n.d. <https://partner.steamgames.com/doc/store/reviews>.
- U.S. National Park Service. "What Is Historic Preservation? - Historic Preservation (U.S. National Park Service)," n.d. <https://www.nps.gov/subjects/historicpreservation/what-is-historic-preservation.htm>.
- Vaez Afshar, S., Aytac, G., Eshaghi, S., & Vaez Afshar, S. 2022. *Online Footprint - A serious game for reducing digital carbon emission*, International Conference of the Ibero-American Society of Digital Graphics: Designing Possibilities-Ubiquitous.
- Vaez Afshar, S., Eshaghi, S., Varinlioglu, G., and Balaban, Ö. 2021. *Evaluation of Learning Rate in a Serious Game-Based on Anatolian cultural heritage*. In 39th International Conference of Education and Research in Computer Aided Architectural Design in Europe: Towards a new, configurable architecture, (pp. 273-280). DOI: 10.52842/conf.ecaade.2021.2.273
- Varinlioglu, G., Vaez Afshar, S., Eshaghi, S., Balaban, Ö., & Nagakura, T. 2022. *GIS-Based Educational Game Through Low-Cost Virtual Tour Experience- Khan Game*. CAADRIA proceedings. DOI: 10.52842/conf.caadria.2022.1.069
- Web Scraping Tool & Free Web Crawlers | Octoparse. n.d. <https://www.octoparse.com/>.
- Wright, E. 2018. On the promotional context of historical video games. Rethinking History, 22(4). 598-608.

A look at residential building stock in the United States - Mapping life cycle embodied carbon emissions and environmental impact

Ming Hu¹

¹University of Notre Dame, Notre Dame, IN

ABSTRACT: Mitigating the climate emergency and moving toward carbon neutrality requires the existing building stock to be understood, inventoried, and analyzed and its contribution to environmental impact quantified. In the United States, the largest knowledge gap concerning embodied carbon in buildings exists at the whole building level, due to a lack of building-level data at the national level and a lack of methodology. To fill this knowledge gap, the main goals of this study are (a) to propose and test a methodology that maps the life cycle embodied carbon (LCEC) and life cycle environmental impact (LCEI) from both operational and embodied carbon at the whole building stock level and (b) to assess the LCEC and LCEI of the US residential building stock using the proposed methodology. The findings indicate that single-family detached houses are the top contributor to embodied carbon in the United States, and large multifamily houses are the most embodied carbon-intense building type. Further, California, New York, and Florida are the top three LCEC contributors and are also primary contributors to all five environmental impact measures.

KEYWORDS: embodied carbon, residential, building stock, emission

INTRODUCTOIN

Mitigating the climate emergency and moving toward carbon neutrality requires the existing building stock to be understood, inventoried, and analyzed and its contribution to environmental impact quantified. In the United States, the largest knowledge gap concerning embodied carbon in buildings exists at the whole building level, due to a lack of building-level data at the national level and a lack of methodology. To fill this knowledge gap, the main goals of this study are (a) to propose and test a methodology that maps the life cycle embodied carbon (LCEC) and life cycle environmental impact (LCEI) from both operational and embodied carbon at the whole building stock level and (b) to assess the LCEC and LCEI of the US residential building stock using the proposed methodology. The findings indicate that single-family detached houses are the top contributor to embodied carbon in the United States, and large multifamily houses are the most embodied carbon-intense building type. Further, California, New York, and Florida are the top three LCEC contributors and are also primary contributors to all five environmental impact measures.

1.0 BACKGROUND

In 2019, GHG emissions from the building sector were nearly 14 gigatons of carbon dioxide (GtCO₂), or 38% of the total energy-related GHG emissions, including 28% from building operations and 10% from building construction (UNEP 2020) (Abergel et al., 2018). In the building sector, the operational energy use of buildings and associated carbon emissions have been better studied and understood, and various regulations, policies, and strategies have been adopted to reduce operational energy and carbon (Hu and Esram 2021). However, the operational stage only presents a partial contribution of the carbon emissions and environmental impact from the building sector. As illustrated in Figure 1, a building's whole life cycle includes the product stage (A1–A3), construction stage (A4–A5), use stage (B1–B7), and end-of-life stage (C1–C4). Operational carbon is associated with life stages B6 and B7, and embodied carbon occurs during life stages A1–B5 and C1–C4.

Building Life Cycle Stage		
Product	A1	Raw material extraction
	A2	Transport
	A3	Manufacturing
Construction	A4	Transport
	A5	Construction/Installation
Use	B1	Use
	B2	Maintenance
	B3	Repair
	B4	Replacement
	B5	Refurbishment
	B6	Operational energy use
	B7	Operational water use
End of Life	C1	Deconstruction
	C2	Transport
	C3	Waste processing
	C4	Disposal
Beyond Life	D	Reuse/ Recovery/ Recycling

Figure 1: Life cycle stages (by author)

There has been increasing interest in studying embodied carbon emission from building sector, and there are well-established international standards and methods to guide the assessment of embodied carbon in buildings (Cang et al. 2020) ; however, most embodied carbon studies focus on individual cases (Blanchard and Reppe 1998) or a building materials comparison (Kahhat et al. 2009). In addition, many embodied carbon studies of building materials have concentrated on the product stage (A1–A3). Research efforts focusing on a material comparison during the A1–A3 stage are critical to a comprehensive understanding of a building’s embodied carbon, but are inadequate to tackle the full spectrum of building decarbonization from the whole life cycle perspective (e.g., building durability, considerations of the manufacturing location, means of transportation, and construction method) and may limit other solutions, such as innovative designs and adaptive reuse. Therefore, a whole building life cycle embodied carbon (LCEC) assessment is essential to reduce carbon emissions from buildings. In the United States, the largest knowledge gap concerning embodied carbon in buildings exists at the whole-building level (Hu and Efram 2021), which is associated with two issues. First, there is a lack of building-level data at the national level; in particular, the data from the residential building sector is extremely limited compared to commercial buildings (Heisel et al. 2022). Second, as pointed out by the author and other researchers in previous publications, methodologies on how to baseline building embodied carbon emissions should be developed (Chen & Thomas Ng, 2016; Dong et al., 2021). The developed methodologies and guidelines should cover the whole life cycle stage beyond the initial building construction (A stage) (Hu 2020) (Abd Rashid and Yusoff 2015). A lack of data and methodology obstructs informative policy decisions that can reduce carbon emissions from the US building sector (Waldman, Huang, and Simonen 2020). To fill this knowledge gap, the main goals of this study are (a) to propose and test a methodology that maps the LCEC and life cycle environmental impact (LCEI) from both operational and embodied carbon at the whole building stock level, and (b) to assess the LCEC and LCEI of the US residential building stock using the proposed methodology. The results are demonstrated and discussed.

2.0. MATERIALS AND METHODOLOGY

Papers should follow the mirror margins (left page, right page) of this paper template. Headers, footers or footnotes are not permitted. Papers should be organized in chapters and sections consecutively numbered using Arabic numerals and decimals. Both chapters and sections (subsections) should be preceded with single blank lines.

2.1. Overall approach

In this study, as illustrated in Figure 2a, a four-step bottom-up approach was used to assess the embodied carbon and environmental impact of the US residential building stock. The most used bottom-up building stock modeling is the archetype approach, where an average building is modeled to represent a segment of the building stock (Reyna et al. 2021). This type of approach and model development is well-suited to typology studies and building sector-wide studies since it can link a high-resolution detailed assessment at an individual building level, scale it up, and apply the archetype data to a segment of the building stock. A bottom-up modeling approach developed by Tuominen et al. (2014) was adopted in this study. The first step was to segment the building stock and develop the archetypes representing variations in the segment. Four residential segments used by the U.S. Energy Information Administration (EIA) Residential Building Energy Consumption Survey (RECS), and National Renewable Energy Lab (NREL) were adopted in this study: the single-family detached house (SD), single-family attached house (SA), multifamily 2–4-unit building (MFS), and multifamily ≥ 5-unit building (MFB).

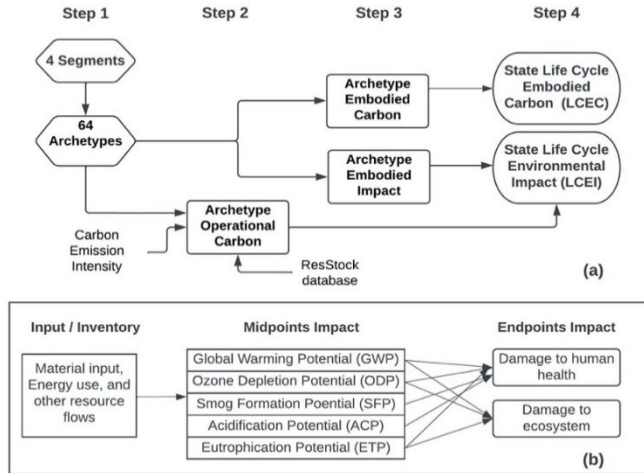

Figure 1. Research steps: (a) four-step research plan, (b) environmental impact assessment (by author)

The second step was to assess the operational carbon. First, the operational energy use intensity (EUI) (measured in kWh/m²) of each archetype per state was extracted and downloaded from the ResStock database, which was created and is managed by NREL (“ResStock,” n.d.). The operational EUI refers to energy use in the B6 stage. Next, it was multiplied by the total floor area (for each archetype) and the carbon emission intensity (CEI) in the state to obtain the total operational carbon from the residential building stock in the state. The energy-related CEI (measured in kg CO₂/MMBtu) per state was downloaded from EIA (EIA 2019b); it varies significantly across states, both on an absolute basis or on a per capita basis. The physical size of a state, available fuels, types of businesses, climate, and population size and density all play a role in determining the level of total and per capita emissions (EIA 2019a, 2005–2016). The existing energy supply infrastructure (e.g., the availability of a renewable energy source) also has an impact on the CEI; for example, the states with the most carbon-intensive energy supply (e.g., coal) have a higher carbon emission intensity. West Virginia has the highest emission intensity, at 79 kg CO₂/MMBtu, while Washington and Oregon have the lowest value, at 35 kg CO₂/MMBtu (EIA 2019b). Finally, the total operational carbon is added together with the embodied carbon to assess the LCEI of the building stocks per archetype and aggregated to the state level.

In the third step, embodied carbon and the associated environmental impact were calculated for each archetype. First, a 3D model was created to represent each archetype; the physical characteristics of the archetype are modeled according to the building characteristics described in Table 2. Then, the life cycle assessment tool Athena Impact Estimator for Buildings was used to assess the LCEC and LCEI (including those from the operational stage) of each individual archetype. In the last step, the LCEC and LCEI (both operational and embodied) of each archetype were aggregated to segment level per state based on the percentage of the archetypes within the segments for each state (measured in floor area). A more detailed process and the equations used are explained in section 3.4.

In this study, as illustrated in Figure 2b, five midpoint environmental indicators were used to assess the LCEI of the US residential building stock: global warming potential (GWP), ozone depletion potential (ODP), acidification potential (ACP), smog formation potential (SFP), and eutrophication potential (ETP).

2.2. Archetypes creation

For this study, directly calculating the environment impact of individual buildings was not feasible because of the enormous study area. However, environmental impact could be assessed based on a set of building physical characteristics and energy consumption, presenting unique building archetypes. The archetype building models were generated using the ResStock database and the American Housing Survey (AHS) database, which include buildings with relatively similar characteristics, representing the residential building stock segment and archetypes (Table 1).

Table 1. Archetype variables in building segments

Archetype category	Building height	Primary structure type	Exterior wall type
Single-family detached house (SD)	1–2 stories	S1-Masonry	W1-Siding (aluminum, vinyl, steel)
Single-family attached house (SA)		S2-Wood frame	W2-Brick
Multifamily 2–4-unit building (MFS)	2–6 stories		W3-Wood
			W4-Stucco
			W5-Concrete or concrete block
			W6-Shingles (composite materials)

Multifamily >= 5-unit building (MFB)			W7-Stone W8-Other material
--------------------------------------	--	--	-------------------------------

Archetypes were described following the naming convention XX-YY-ZZ, whereby XX describes the segment type (SD, SA, MFS, MFB), YY represents the primary structure type (S1 for masonry, S2 for wood), and ZZ represents the exterior wall materials (W1–W8). For each archetype, the construction assemblies were created by assigning building materials to numbered layers with a certain thickness, and those layers together comprise a certain building assembly. The dimension and material of these layers are based on the author’s industry knowledge from practice and a literature review on historic and contemporary construction assemblies used in the United States (Woolson et al. 1922) (“Building Technology Heritage Library.” n.d.) (*Building Knowledge, Constructing Histories. Volume 2* 2018, 2). Using the primary structure options, exterior wall materials, and construction assemblies, 64 archetypes were generated for this study, which represent over 95% of US residential buildings (mobile homes were excluded from this study). For example, SD-S1-W6 represents a single-family detached house with a primary structural masonry wall, exterior wood shingle wall, and blown-in cellulose insulation; SA-S2-W1 represents a single-family attached house with a primary wood structural frame with exterior vinyl siding.

2.2. Assess life cycle embodied emissions of archetypes and aggregate to the state level

A two-step process was used obtain the state-level LCEC and LCEI from the residential building stock. In the first step, the LCEC and LCEI of an individual archetype were calculated. A method used by the researcher in a previous study was employed in this project (Hu, Cunningham, and Gilloran 2017). First, three-dimensional virtual models were created in Autodesk Revit for each archetype building based on the information presented in Table 2. Next, a material schedule was created within the Revit model and then exported into an Excel format file. The schedule was simplified to remove irrelevant information and create a clear spreadsheet. The data was useful to this study as it included primary and secondary structure systems (e.g., interior walls, columns, floors, and foundations,) and the building envelope (e.g., external walls and roof). After the data was brought into the Athena Impact Estimator for Buildings, the program calculated the LCEC and other environmental impact categories. The individual archetype embodied carbon and midpoint environmental impact (MEI) were obtained, measured by kgCO_{2eq}/m² and MEI/m², respectively (refer to section 4 for detailed measure units for each impact category).

Table 2. Physical characteristic variables of archetypes

Archetype	Single-family detached (SD)		Single-family attached (SA)		Multifamily 2–4 unit (MFS)		Multifamily >= 5 unit (MFB)	
	S1	S2	S1	S2	S1	S2	S1	S2
Construction type	S1	S2	S1	S2	S1	S2	S1	S2
Floor area (m ² /unit)	230	232	160	160	92	102	79	82
Height/stories	1	1	2	2	3	3	6	6
Number of bedrooms	3	3	2	2	2	2	2	2
Number of windows	12	12	8	8	8	8	4	8
Type of window	Double-pane glass w/ wood frame		Double-pane glass w/ metal frame		Single-pane glass w/ metal frame		Single-pane glass w/ metal frame	
Basement	Y	Y	Y	Y	N	N	N	N
Foundation	Concrete							
Roofing	Shingles (composition or asphalt)							
Construction type	S1	S2	S1	S2	S1	S2	S1	S2
Adequate insulation	Y	Y	Y	Y	Y	Y	Y	Y
Wall material	W1-W8		W1-W6		W1-W5, W7		W1-W8	

In the second step, the individual embodied carbon and MEI were aggregated at the state level. Based on the data extracted from ResStock and RECS, the percentage of each archetype (measured by the average floor area per archetype) was obtained and multiplied by the total number of buildings in each state to determine the total floor area (m²) of each archetype. Then the aggregated LCEC and life cycle midpoint environmental impact (LMEI) for each state could be calculated use equations A and B listed below.

$$LCEC = \sum_{t=i}^n (QA_i \times EC_i) \tag{Equation A}$$

Where QA_i is the floor area of one archetype (m²), EC_i is the LCEC of each archetype (kgCO_{2eq}/ m²), t is the archetype, and n represents the total number of archetypes in the state.

$$LMEI = \sum_{t=i}^n (QA_i \times MEI_i) \tag{Equation B}$$

Where QA_i is the floor area of one archetype (m^2), MEI_i is the midpoint environmental impact of each archetype (MEI/m^2), t is the archetype, and n represents the total number of each archetype in the state.

3.0 FINDINGS

3.1. LCEC per archetype

As shown in Figure 3a, MFBs have the highest normalized embodied carbon (per floor area) across all archetypes, ranging between 8,024 kg CO_{2eq}/m² and 9,441 kg CO_{2eq}/m², mainly due to the building type itself. Multiple units (with less area associated with each unit) are included in a single building, hence more materials are needed for interior walls (in unit), corridor walls, and shared space walls. The higher structural load also requires a more robust foundation system and primary structure system, which leads to more materials used. However, compared to other segments, the normalized embodied carbon of different archetypes in MFBs have the least variation because of the percentage of building assemblies contributing to embodied carbon. Figure 4a also shows that archetypes for SDs, SAs, and MFSs have comparable normalized embodied carbon: an SD has a normalized embodied carbon range of 1,253 kg CO_{2eq}/m² to 2,847 kg CO_{2eq}/m², an SA has a range of 1,093 kg CO_{2eq}/m² to 3,090 kg CO_{2eq}/m², and an MFS has a range of 901 kg CO_{2eq}/m² to 3,099 kg CO_{2eq}/m². In general, the archetypes with wood as a primary structure (S2) have a lower value than those with masonry as a primary structure material (S1). As illustrated in Figure 3b, the dominating archetypes are as follows: S2W1 (29%) in SD, S2W2 (23%) in SA, S2W2 (20%) in MFS, and S1W2 (29%) in MFB.

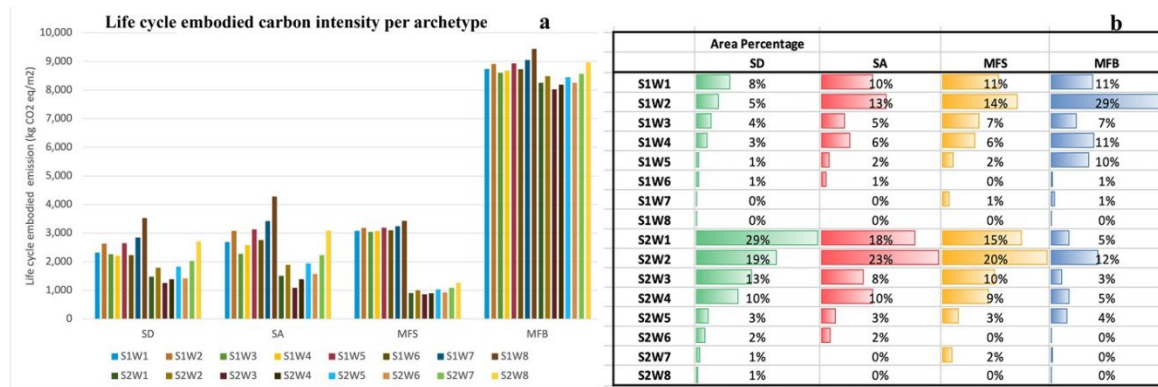

Figure 2. LCEC by archetype: (a) LCEC intensity per archetype, (b) percentage of share of archetypes (by author)

Regarding the building assembly groups' contribution to embodied carbon, the four segments show different breakdowns (Figures 6a–d). “Walls” (exterior and interior wall) is the dominating group for embodied carbon in the SD, SA, and MFS (Figure 4a, 4b, and 4c), while “floors” and “walls” contribute to a similar level in the MFB (Figure 4d). The second highest contributing group is “foundation” in the SD and MFS, with “floors” in the SA. The contribution from “columns/beams” in the SD is negligible because most SDs do not use a beam and column structure; the bearing wall system is the commonly used construction type for SDs in the United States. To reduce embodied carbon for the future residential building stock, the focal building assembly groups vary per building segment. For SDs and SAs, walls should be the focal category, for MFSs, foundation and walls should be focal areas, and for MFBs, walls and floors are the hot spots.

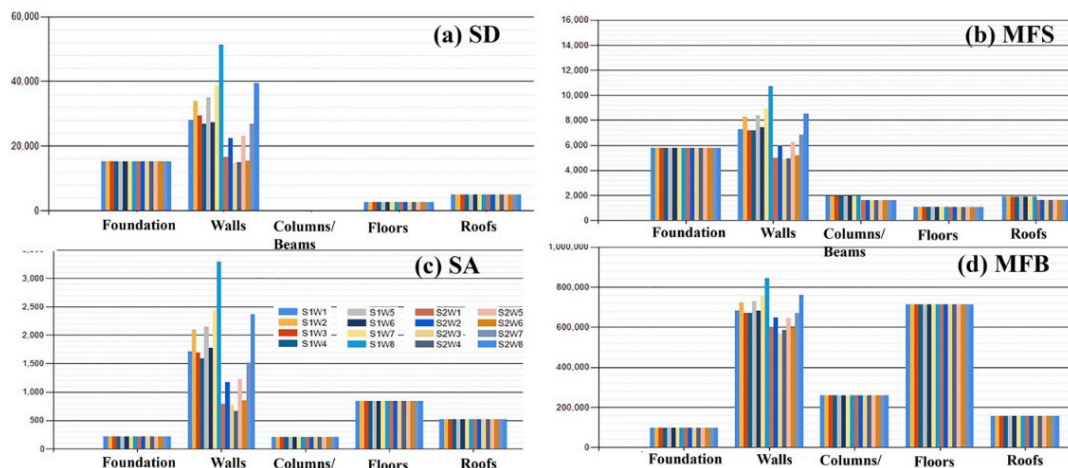

Figure 3. Life cycle carbon emission breakdown per building assembly: (a) SD, (b) SA, (c) MFS, (d) MFB (by author)

3.2. LCEC emissions per state

Figure 5a indicates California as the highest contributor to residential building stock embodied carbon (10%), followed by New York (9%) and Florida (7%). Figure 7b illustrates the archetypes' contribution per state. It is clear that archetypes contribute differently per state. For example, in California (CA), the majority contribution is from MFB-S1; in Kansas (KS), the primary contributor is MSB-S2; and in Pennsylvania, MSF-S1, SA-S2, and SA-S1 have similar contributions to embodied carbon. This is mainly explained by the total built area of the different archetypes. There is no one-size-fits-all solution for a carbon emissions reduction; each state must determine its unique residential building stock characteristics to create meaningful policy.

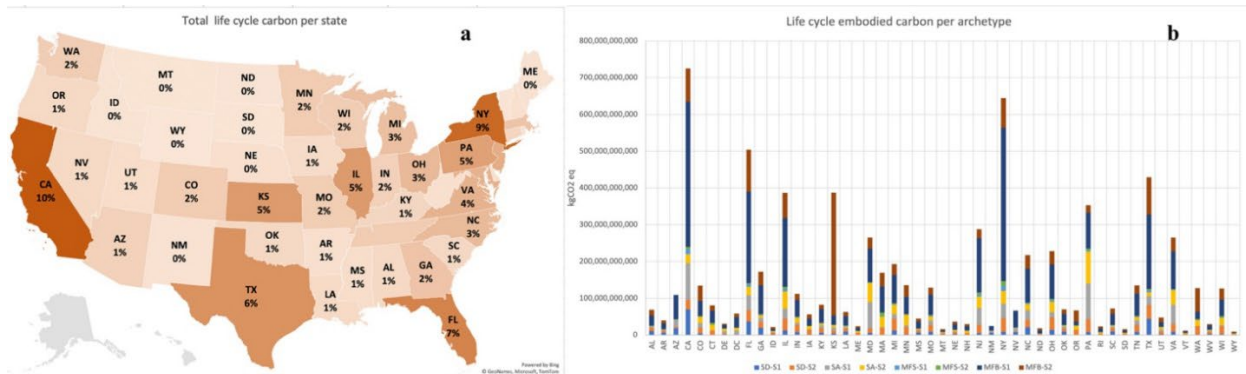

Figure 4. LCEC by state: (a) percentage of LCEC emissions per state, and (b) LCEC emissions breakdown per archetype per state (by author)

3.3. Archetype environmental impact per state

As illustrated in Figure 6a–e, California, New York, Texas, Florida, and Illinois are the five main contributors to the five environmental impact categories measured in this study, accounting for around 44% of the LCEI from the US residential building stock. These contributions are directly related to the total floor area (refer to Figure 8f), with the more buildings, the higher the impact potential. For example, California has 10% of the building stock, and contributions to all five categories are around 10–11%. However, New York has 9% of the building stock but contributes 12% each to ODP, ETP, GWP, and SFP and 7% to ADP. This is somewhat disproportionate in terms of built area and environment impact potential. It is difficult to find a potential explanation without further examining the residential building characteristics in New York state. This can be the next research step.

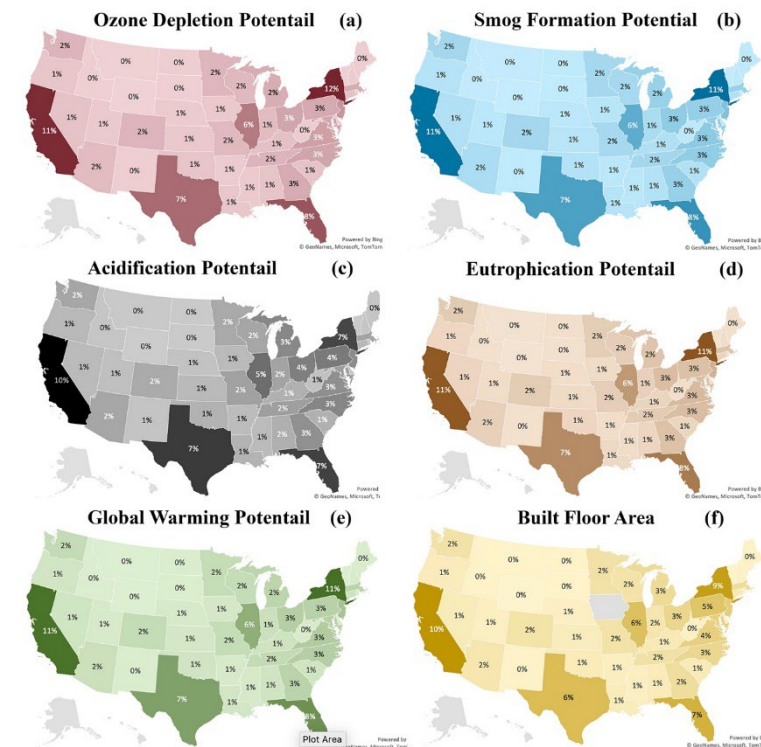

Figure 5. LCEI of residential building stock: (a) ODP per state, (b) SFP per state, (c) AC per state, (d) EC per state, (e) GWP per state, and (f) floor area contribution (by author)

DISCUSSION AND CONCLUSION

The contributions of this study can be described at two levels: empirical evidence and methodology validation. First, at the empirical evidence level, as compared to previous studies, the ECEI of an SD is 20 kg CO_{2eq}/m²/yr to 58 kg CO_{2eq}/m²/yr, which is lower than older studies (before 2010) but aligned with the value published in 2014 (Mosteiro-Romero et al., 2014). The life span is assumed to be 60 years. The mean ECEI of an SD is 36 kg CO_{2eq}/m²/yr. This average value can be potentially used as a benchmark for SDs in the United States. An SA has an ECEI profile similar to the SD's, with a mean value of 40 kg CO_{2eq}/m²/yr. Conversely, the two multifamily building segments differ much from each other. The MFB has the highest ECEI with a mean value of 144 kg CO_{2eq}/m²/yr, and the MFS has the lowest value, at 34 kg CO_{2eq}/m²/yr. Also, the MFB has the smallest variation within the segment, indicating MFBs are more similar to each other in terms of construction type and building materials used. The mean values of the four residential building segments can be used as a benchmark for new buildings in those segments. It is imperative to have a benchmark for future designs to understand the practicality of the embodied carbon reduction goal.

Regarding LCEI, even though the SD is the dominating residential segment, accounting for 82% of the floor area, the MFB is the leading building segment contributing to all environmental impact categories except acidification: 100% to ODP, 85% to ETP, 78% to HHP, and 80% to GWP. This is mainly related to the construction types and building materials used in MFBs, as most large multifamily buildings (especially high-rise buildings) have concrete and steel primary structures as opposed to wood structures in SDs and SAs. For future construction, regulating the building materials and construction methods in MFBs should be the focal area.

At the methodology level, this study employs a bottom-up archetype approach to map the LCEC and LCEI from the residential building stock. Such an archetype approach is aligned with the framework used by the NREL for mapping operational energy use of the residential building stock. The four-step method can be applied to other building stocks or other regions with compatible data sources. Modeling and mapping the building stock at the national level is a critical step toward inventorying the existing building impact to make informative policy decisions for future construction or renovation.

From the analysis described, the ECEI of residential buildings is not influenced by building age, size, climatic condition, or geographic location, and it is also independent of operational carbon. As demonstrated in Figure 5a, California, New York, and Florida are the top three states contributing to embodied carbon emissions, and the three vary in location, climatic condition, building segment breakdown, and average building size and age. The primary embodied carbon contributors vary in different building segments. For SDs and SAs, walls (exterior and interior) should be the focal category, with the use of wood as primary and secondary structural materials promoted. For MFSs, the foundation and walls are the two categories with the highest embodied carbon contributions. A concrete foundation is commonly used, and it is difficult to find alternative solutions, but a more efficient foundation design can result in a smaller foundation and fewer materials used. Further, using more wood products in the exterior and interior wall application can be emphasized. For MFBs, both walls and floors are hot spots, thus using more wood products and reducing the use of concrete and steel can be a viable solution. A strategy applicable to all building segments and archetypes is to reduce the overall size of housing and units. A reduction of floor area through a more efficient use of space has been identified as an effective strategy to lower the overall carbon emissions from the building sector (Hertwich, Edgar et al. 2019).

Overall, this research establishes a methodology to assess the LCEC and LCEI of the US residential building stock. Four building segments and 64 archetypes were created to present the residential building stock. Five MEI metrics were calculated: GWP, SFP, AP, EP, and ODP. Findings indicate that SDs are the top contributor to embodied carbon in the United States, and MFBs are the most embodied carbon-intense building type. California, New York, and Florida are the top three life cycle carbon emission contributors and are also primary contributors to all five environmental impact measures.

REFERENCES

- Abd Rashid, Ahmad Faiz, and Sumiani Yusoff. 2015. "A Review of Life Cycle Assessment Method for Building Industry." *Renewable and Sustainable Energy Reviews* 45 (May): 244–48. <https://doi.org/10.1016/j.rser.2015.01.043>.
- Abergel, T, B Dean, J Dulac, and I Hamilton,. 2018. "2018 Global Status Report: Towards a Zero-Emission, Efficient, and Resilient Buildings and Construction Sector." <https://www.worldgbc.org/sites/default/files/2018%20GlobalABC%20Global%20Status%20Report.pdf>.
- Blanchard, Steven, and Peter Reppe. 1998. "Life Cycle Analysis of a Residential Home in Michigan." https://www.css.umich.edu/sites/default/files/css_doc/CSS98-05.pdf.
- Building Knowledge, Constructing Histories. Volume 2.* 2018. Boca Raton London New York Leiden: CRC Press.
- "Building Technology Heritage Library." n.d. Accessed May 9, 2022. <https://archive.org/details/buildingtechnologyheritagelibrary>.
- Cang, Yujie, Liu Yang, Zhixing Luo, and Nan Zhang. 2020. "Prediction of Embodied Carbon Emissions from Residential Buildings with Different Structural Forms." *Sustainable Cities and Society* 54 (March): 101946. <https://doi.org/10.1016/j.scs.2019.101946>.
- Chen, Yuan, and S. Thomas Ng. 2016. "Factoring in Embodied GHG Emissions When Assessing the Environmental Performance of Building." *Sustainable Cities and Society* 27 (November): 244–52. <https://doi.org/10.1016/j.scs.2016.03.015>.
- Dong, Yahong, S. Thomas Ng, and Peng Liu. 2021. "A Comprehensive Analysis towards Benchmarking of Life Cycle Assessment of Buildings Based on Systematic Review." *Building and Environment* 204 (October): 108162. <https://doi.org/10.1016/j.buildenv.2021.108162>.
- EIA. 2019a. "Energy-Related Carbon Dioxide Emissions by State, 2005–2016." U.S. Energy Information Administration. <https://www.eia.gov/environment/emissions/state/analysis/pdf/stateanalysis.pdf>.

- . 2019b. "OVERVIEW DATA ANALYSIS & PROJECTIONS." <https://www.eia.gov/environment/emissions/state/>.
- Heisel, Felix, Joseph McGranahan, Joseph Ferdinando, and Timur Dogan. 2022. "High-Resolution Combined Building Stock and Building Energy Modeling to Evaluate Whole-Life Carbon Emissions and Saving Potentials at the Building and Urban Scale." *Resources, Conservation and Recycling* 177 (February): 106000. <https://doi.org/10.1016/j.resconrec.2021.106000>.
- Hertwich, Edgar, Lifset, Reid, Pauliuk, Stefan, Heeren, Niko, Ali, Saleem, Tu, Qingshi, Arden, Fulvio, et al. 2019. "Resource Efficiency and Climate Change: Material Efficiency Strategies for a Low-Carbon Future." Zenodo. <https://doi.org/10.5281/ZENODO.3542680>.
- Hu, Ming. 2020. "A Building Life-Cycle Embodied Performance Index-the Relationship between Embodied Energy, Embodied Carbon and Environmental Impact." *Energies* 13 (8). <https://doi.org/10.3390/en13081905>.
- Hu, Ming, Peter Cunningham, and Sarah Gilloran. 2017. "Sustainable Design Rating System Comparison Using a Life-Cycle Methodology." *Building and Environment* 126: 410–21.
- Hu, Ming, and Nora Wang Efram. 2021. "The Status of Embodied Carbon in Building Practice and Research in the United States: A Systematic Investigation." *Sustainability* 13 (23): 12961. <https://doi.org/10.3390/su132312961>.
- Kahhat, Ramzy, John Crittenden, Fariya Sharif, Ernesto Fonseca, Ke Li, Anil Sawhney, and Peng Zhang. 2009. "Environmental Impacts over the Life Cycle of Residential Buildings Using Different Exterior Wall Systems." *Journal of Infrastructure Systems* 15 (3): 211–21. [https://doi.org/10.1061/\(ASCE\)1076-0342\(2009\)15:3\(211\)](https://doi.org/10.1061/(ASCE)1076-0342(2009)15:3(211)).
- Mosteiro-Romero, Martín, Uta Krogmann, Holger Wallbaum, York Ostermeyer, Jennifer S. Senick, and Clinton J. Andrews. 2014. "Relative Importance of Electricity Sources and Construction Practices in Residential Buildings: A Swiss-US Comparison of Energy Related Life-Cycle Impacts." *Energy and Buildings* 68 (January): 620–31. <https://doi.org/10.1016/j.enbuild.2013.09.046>.
- "ResStock." n.d. National Renewable Energy Laboratory. <https://resstock.nrel.gov/>.
- Reyna, Janet, Eric Wilson, Aven Satre-Meloy, Amy Egarter, Carlo Bianchi, Marlena Praprost, Andrew Speake, et al. 2021. "U.S. Building Stock Characterization Study: A National Typology for Decarbonizing U.S. Buildings. Part 1: Residential Buildings." NREL/TP-5500-81186, 1836659, MainId:80961. <https://doi.org/10.2172/1836659>.
- UNEP, UNEP Copenhagen Climate Centre (UNEP-CCC). 2020. "Emissions Gap Report 2020." <https://www.unep.org/emissions-gap-report-2020>.
- Waldman, Brook, Monica Huang, and Kathrina Simonen. 2020. "Embodied Carbon in Construction Materials: A Framework for Quantifying Data Quality in EPDs." *Buildings and Cities* 1 (1): 625–36. <https://doi.org/10.5334/bc.31>.
- Woolson, I.H., E.H. Brown, J.A. Newlin, W.K. Hatt, E.J. Russell, R.P. Miller, and F.P. Cartwright. 1922. "Recommended Minimum Requirements for Small Dwelling Construction: Report of Building Code Committee July 20, 1922." <https://www.govinfo.gov/content/pkg/GOVPUB-C13-355ae8e6789ebb0186fc7fd126f3f1e0/pdf/GOVPUB-C13-355ae8e6789ebb0186fc7fd126f3f1e0.pdf>.

AI-assisted Generative EA Design with topological optimisations for an 80 or 50 meters long Hybrid 3D-printed WAAM Steel Bridge in Germany

Thomas Spiegelhalter^{1, 2}

¹Florida International University, Miami, FL

²Carbon-Neutral-Projects LCC, Miami-Berlin, US-Germany

ABSTRACT: Artificial Intelligence-ML-enabled generative design (GD) using evolutionary algorithms (EA), automation, and topology optimisation (TO) has experienced tremendous growth in recent years. As a result, AI, GD and EA have evolving applications in many fields, such as medicine, synthetic biology, industrial and product design, infrastructure, architecture, engineering, and construction. This research paper discusses performance-based workflows of artificial intelligence-ML-assisted, cloud-based computation for a real-world hybrid 3d-printed Steel bridge inspired by biology growth patterns. The critical comparison of the workflows includes AI-EA-driven generative design, with topological optimisations for reducing weight and cost and accelerating the prefabricated assembly speed. The generative bridge design was also incrementally optimized with finite element structural analysis (FEA) and cloud-driven deep neural network (GNN) scenarios. After hundreds of cloud-based AI-ML computed, GD scenario outcomes were validated, and further TO's were performed in a dozen more iterations for the selected geometries. This includes several 3d-printing wire-and-arc additive manufacturing (WAAM) scenarios versus hybrid versions of partly 3d-printed components with prefabricated off-the-shell tubes that were critically compared and validated.

In addition, the generative bridge design is incrementally optimized with finite element structural analysis (FEA) and cloud-driven deep neural network (GNN) scenarios. The optimisations were performed based on scientific accuracy methods and EU-German code-specific permitting details to achieve a national certification for assembly.

As a result, the award-winning, mixed hybrid off-the-shelf material, 50-meter robotically-printed, BlueMint(©)Steel Bridge will be assembled in one large transportation module and plugged into several micro-pile foundations in July 2023. These assembly considerations had the advantage that prefabricated bridge modules could be flown in by helicopter and easily assembled from a barge on the river Rhine. The assembly site of the bridge is located at the EU's longest River Rhine Estuary of the smaller Emscher River in Germany.

KEYWORDS: Artificial Intelligence, Evolutionary Algorithms, Generative Design, Topological Optimizations, Additive Manufacturing

INTRODUCTION

Competition Criteria for the new Leisure Park and Bridge Design

The bridge's construction site is on the small River Emscher Estuary into the Rhine. It is still a region where the post-industrial environment is not accessible by the public, and there are sealed-off brownfield areas. The general public park master plan includes the regeneration of a post-industrial-era riverfront with the former coal mining area pumping stations, intending to provide a culturally stimulating, accessible location for a future public park. A design competition was held to build a bridge spanning 80 or 50 meters of the estuary. The author's office in Miami-Berlin won the commission for the generative engineering design with the local landscape architect's park design. Many soil surveys, a lidar search of WWII-era bombs, and ecosystem inventories of existing plants and animals, together with environmental impact analysis, were undertaken in two years. Due to different soil, hydrologic, and load conditions on the different bridge structures, an all-in-one, low-weight, micropile-supported bridge structure was designed, and FEA optimized, containing three micro pylons outside of a reasonable existing tree root zone. (Figure 1).



Figure 1: Site view of the estuary area of the new post-industrial park (left two images), digital twin for the bridge (middle), and assembly location for the bridge (right). Source:(©Thomas Spiegel2022).

1.0 METHODS

1.1 AI-Generative Cloud Design and Analog Topology Optimization with Graph Neural Networks

Topology Optimization (TO) has been used for 20 years, but it is not a Generative Design (GD) that has been available in cloud subscription since 2018. TO typically starts with a single, wholly modeled, human-biased design-CAD concept, with loads and constraints applied according to the structural requirements of the design (Spiegelhalter, 2014).

The TO output is just one optimized concept for evaluation derived from human-designed geometry.

No AI-ML-assisted automation is applied to generate multiple ideas like in GD. Generative Design (GD) is an AI-enabled, cloud-based modeling-driven design technique using genetic/evolutionary (GA/EA) algorithms.

It generates hundreds of geometry cloud scenarios based on the user's selected preserved design space, constraints, off-sets, constraints, materials, starting shape areas and structural requirements such as loads and events. Once the generative cloud design iterations and scenarios are completed, it returns a streamlined, artificially generated native mesh model that can be further processed inside any CAD system for downstream use.

This process includes topological optimisations (TO) with finite element analysis (FEA) and other relevant workflows for the bridge design.

Specifically for the generative bridge design, performance parameters and materials components were automated with text-based guidance using Graph Neural Network (CNN) over data described with Graphs within the non-Euclidean design space (Thyssen-Krupp AG,2023; Bian et al, 2022).

The Evolutionary Algorithm (EA) for the most natural-looking growing-like design and the Genetic Algorithm (GA) were tested and compared in iterations of generative bridge designs.

Several generative design (GD) tools are commercially available in design and engineering today: Dassault Systemes CATIA V6, SolidWorks, Bentley, Altair's OptiStruct, Autodesk's Revit Dynamo Studio, InventorPro, Fusion360, Nastran, Netfabb Shape Generator, Grasshopper-Rhino, and Siemens NX SolidEdge-Frustum. However, only Autodesk GDs work fully integrated with the cloud-based storage that supports the AI; other brands still work only locally, as limited versions (Figure 2).

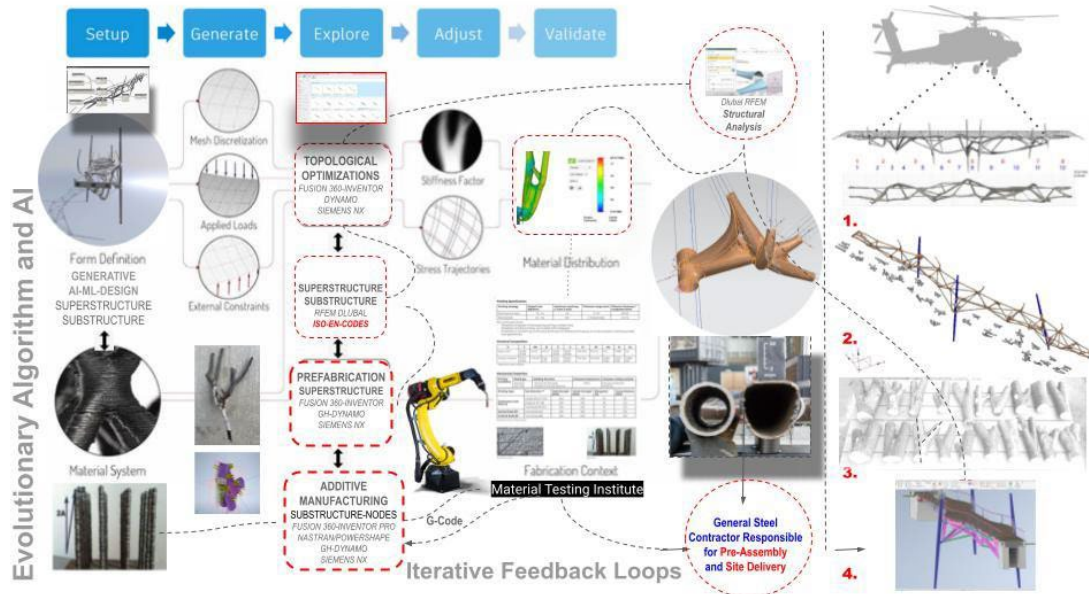

Figure 2: AI-assisted Generative Design Cloud, Iterative Feedback Loops, Finite Element Modelling and Topological Optimization for additive Manufacturing Flowchart. Source:(©Author.2022)

1.2. Generative and Evolutionary Algorithms for the Design Iterations of the Bridge Competition

Both an Evolutionary Algorithm (EA) -for more naturally-looking, growing-like designs- and a Genetic Algorithm (GA) were tested and compared across the design iterations for the winning bridge design. An Evolutionary Algorithm (EA) is an algorithm that uses natural mechanisms and solves challenges of complex geometries through processes that emulate living organisms' behavior. (Figure 4)

EAs are components of both evolutionary and bioinspired computation. Genetic algorithms (GAs) are methods for solving constrained and unconstrained optimization problems based on natural selection, metaphorically speaking, the process that drives biological evolution. GAs automatically adjust populations of individual solutions across hundreds of cloud-computing FEA iterations and outcomes. Furthermore, GA is a general-purpose example of a meta-heuristic search algorithm, which can explore a black-box parameters model to find the most efficient designs according to multiple preset objectives (Wang, Wang, and Guo 2003; Allaire, Jouve, and Toader, 2002). Therefore, GA was used in the early stages of the design process, auto-generating hundreds of designs according to performance-based

parameters inputs, materials, and manufacturing types to reduce the weight and manufacturing costs (Spiegelhalter, 2014). The integrated decisions also guide aesthetics via a cloud modeling of the CAD results, which can be edited, emphasizing organic growth patterns and lightweight architecture.

2.0 MULTIPLE AI-ML ASSISTED GENERATIVE DESIGN, GA-EA PARAMETER SET UPS

2.1. Hundred GA Cloud Scenarios - three Selected Iterations with TOs and FEA

Each experimental GD workflow consisted of several criteria input steps, depending on the complexity of setting up the workspace before the geometry was sent into the AI-ML-assisted computing cloud. For this experimental bridge design, Autodesk Robot-Assisted Structural Analysis, InventorPro, Netfabb, Nastran, CFD Ultimate, ANSYS, and the Fusion360 cloud subscription were used, along with SIEMENS NX and RFEM standalone Dlubal 3D Finite Element Analysis software (Figures 2,3,4,5). The specific software workflow with the cloud platform was necessary to avoid unnecessary file exchange compatibility issues with natively coded components, material and performance data (Bian et al., 2022).

The setup involved running the AI-cloud-based GD engine multiple times, with hundreds of explorations, readjustments, optimisations and validations. The first iteration was coded with Robot Structural Analysis as a typical Euclidean topology standard design based on a structural design tutorial for EU-Codes as a baseline experiment.

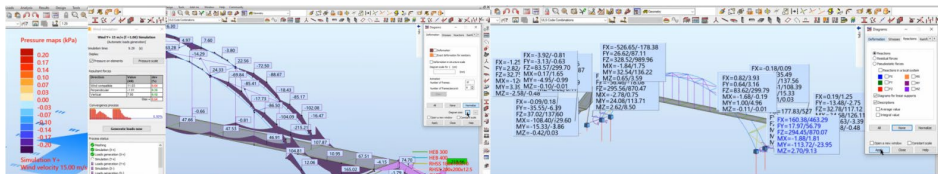

Figure 3: First bridge iteration with Autodesk Robotic Structural Tutorial Analysis as a euclidean standard design solution for an 80 m arched suspension bridge proposal. Source:(©Thomas Spiegelhalter, 2021)

The second bridge design was modeled with InventorPro and Generative Design in Fusion360. It shows a contrary geometry of a growth-looking, organic, non-euclidian. 80-meter-long arching bridge topology. The model was created as a starter shape geometry with a primary structure over a preserved bridge circulation deck geometry (Figures. 4,5).

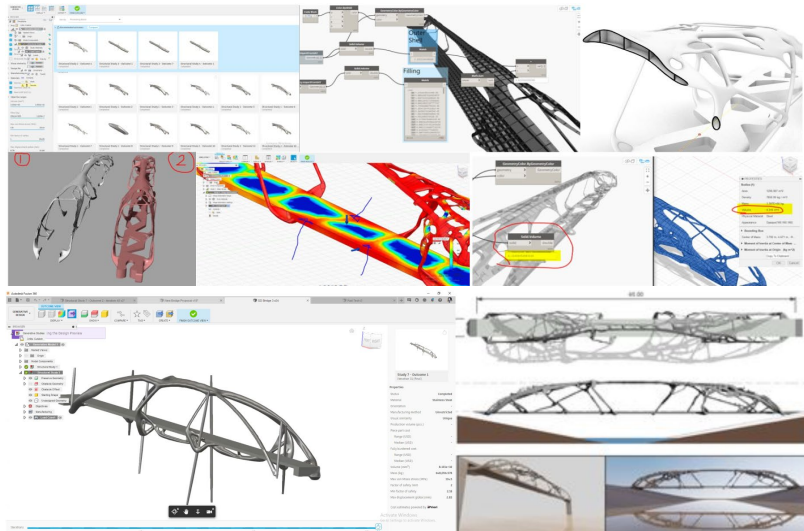

Figure 4: Second 80 m arched bridge iteration, this time with Autodesk InventorPro/Fusion360 Generative Design with organic experimental GA/EA workflows and Dynamo Scripting to topologically optimize the weight and material choices for 3d-steel printing. Renderings in Revit-Enscape Vers. 2022. Source:(©Thomas Spiegelhalter, 2022).

Nevertheless, the winning submission in the contest's third bridge design focused on different parametric inputs for load distribution and at different angles in the topography for a shorter 50-meter-long main structure. This time, the Generative starting design space with the obstacles and offsets was set below the preserved bridge geometry and the circulation decks with the distribution of the loads via seven micro-piles over the river estuary (Figure. 6).

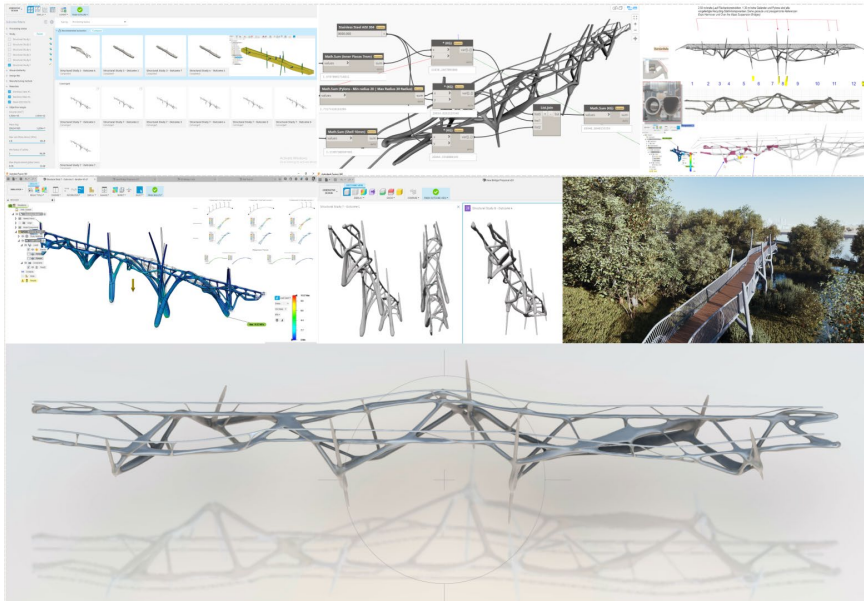

Figure 5: Winning Autodesk InventorPro/Fusion360 Generative Design space, constraints, obstacles, offsets, with genetic and evolutionary algorithms (GA/EA) and Dynamo Scripting. Source:(©Thomas Spiegelhalter, 2022)

2.2. Five more Adjusted GD-EA Space Setups, Structural Load Iterations, and Codes Compliance

The structural load types with safety factors for the conceptual GD-bridge model before it was sent into the cloud included (to name a few): Self-weight (0.5 kN/m² and 78.5 kN/m³), vertical and horizontal payloads (5.0 kN/m²), structural buckling, nonlinear stress, and dynamic loads such as modal frequency, quasi-static event simulation, dynamic event simulation, wind load, water load (2m/sec.), impact loads (3m/sec. with 200 kg), and thermal stress loads (Figures. 3, 4, 5 and 6) (Andia and Spiegelhalter, 2014). This time, the preserved geometry with boundaries (the keep in's) stayed in the final modeling space of the starting shape (such as nodes and connection points between tubes and pylons) under the preserved geometry, and the scaled obstacle geometry with the constraints (the keep-outs, clearances) for seven pylons and foundations. Then, the design loads for the concrete abutments, seven pylons, and micropile foundations were separately computed with other FEA software to calibrate and merge the results into the shared cloud Masterfile. The next step included after the GD geometry was further topologically cleaned and optimized the coding of all the relevant structural design conditions and load types based on the Eurocode 3 (EN 1993/EC 3).

2.3. Results of Methods 1-8, Iterations and Validations

One of the early competition intentions was to completely 3d-print the entire organic, award-winning, non-euclidian bridge in stainless steel (SS 308Lsi). However, printing the whole structure in 8-10 mm organically and non-centred designed tubular steel wall thickness and geometry would have consumed 11,630 hours for a WAAM 3D printing or about 2,080 hours for printing using more than six Kuka robots. Additionally, it would need 3,488kg of welding wires, several protection gas tanks, and 58.147kWh of electricity. All costing around 1,3 Mio. Euros before taxes (including assembly), not including the cost for the project design, engineering and planning, permitted simulation tests, and other license fees. Moreover, tying the incredibly post-industrial green park schedules with assembly deadlines for several other integrated site preparations and construction processes together in 6 months made waiting more than one year to have the entire steel bridge printed impossible.

The initial desire to only robotically 3d-print the world-largest steel bridge was rapidly scaled back towards more economically feasible structural design (Wang, Wang, and Guo 2003). The decision evolved towards striving for a hybrid design with a balanced mixture of prefabricated steel tubes and only 3D-printed nodes and posts for handrails to preserve the organic growth aesthetic of the final lightweight bridge design. Within FEA and RFEM structural fitness iterations, pylons were significantly reduced from seven to just three, and all the loads were remodeled and recalculated. The initially uncentred growth nodes a non-aligned hollow tube were all geometrically centered and adjusted versus the previous designs with non-centred geometries, drastically reducing printing weight, materials and costs. The internationally conducted tender, resulting in price inquiries and bidding, showed a 225% cost reduction.

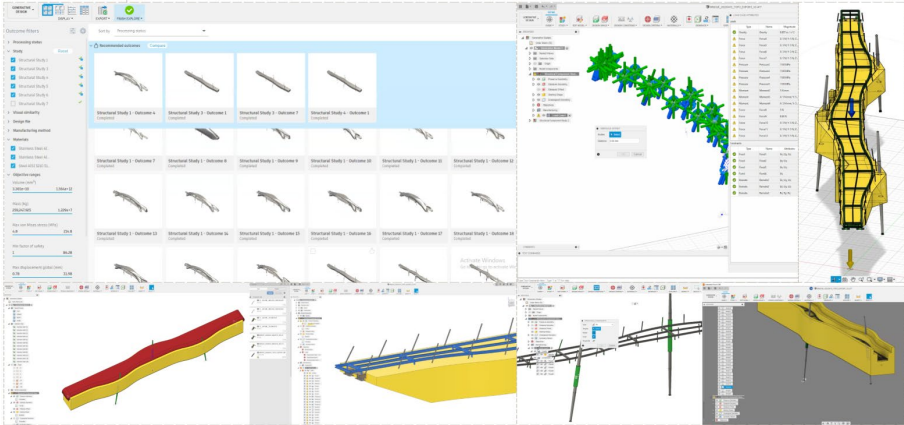

Figure 6: Autodesk InventorPro/Fusion360 Generative Design space, constraints, obstacles, offsets, with genetic and evolutionary Algorithms (GA/EA) and Dynamo Scripting. Source:(©Thomas Spiegelhalter, 2022).

Other challenges include combining data from the additive manufacturers for their various robot G-codes to handle the interference with little file cleaning up and coding the robots printing and machining paths. The required robot-G-coding for the WAAM with Direct Energy Deposition or Powder Bed Fusion (PBF) 3D printer types is based on ISO/ASTM 52900 Standards for metal additive manufactured components and will be directly developed in Fusion360 and Inventor Pro with Dynamo. All computational bridge design workflows for the Autodesk simulation of mechanical multiphysics were based on the Autodesk simulation Accuracy Verification Examples (AVEs) from NAFEMS USA Benchmark publications and COMSOL for the Dlubal software workflows (AVEs, 2022; Autodesk Fusion 360 Accuracy, 2022; Kindo,2015).

By aligning the entire generative design and TOs workflows to these standards and guidelines, the 3D printing and the associated prefabrication technologies will improve clarity and facilitate quality improvement.



Figure 7: Autodesk InventorPro/Fusion360 perspectives and renderings in Autodesk Alias.Source:(©Thomas Spiegelhalter, 2022).

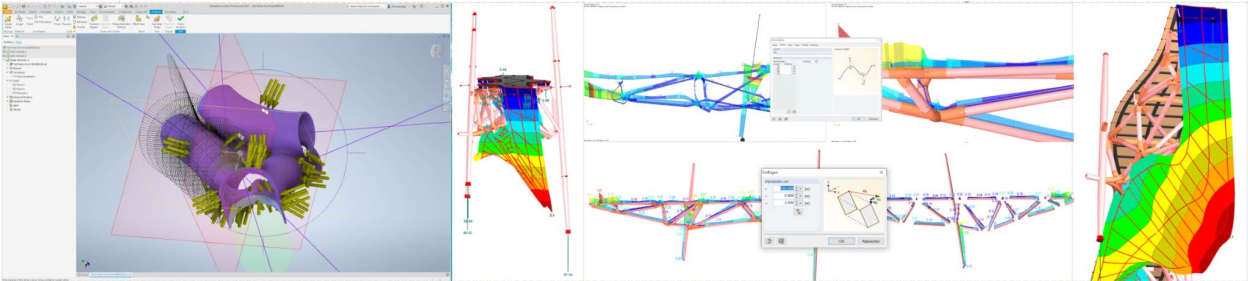

Figure 8: Autodesk InventorPro-Nastran and RFEM Dlubal structural analysis of the non-centred 3d-printed components with fitness tests and optimizations. Source:(©Thomas Spiegelhalter and Mathias Pfeiffer, 2022)

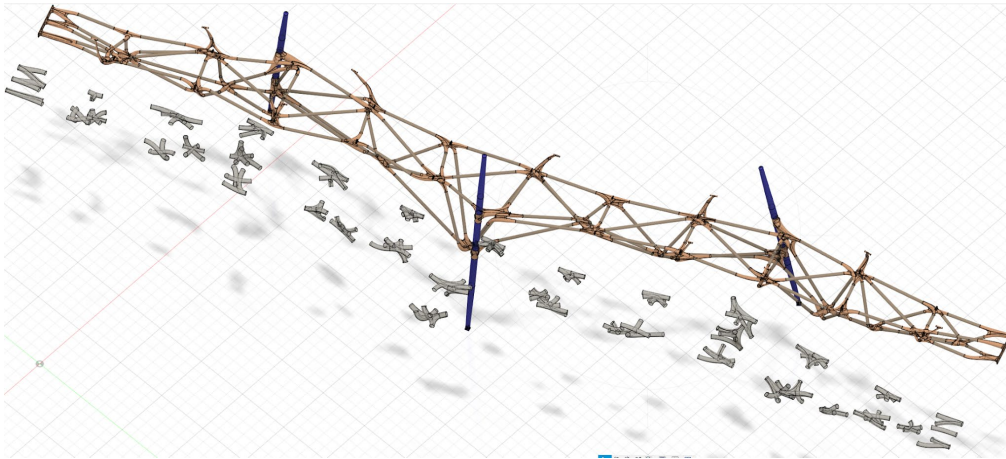

Figure 9: Autodesk InventorPro/Fusion360-Dynamo, Siemens NX, Topological Optimizations (TO) of the nodes and entire geometry. Source:(©Thomas Spiegelhalter, 2022).

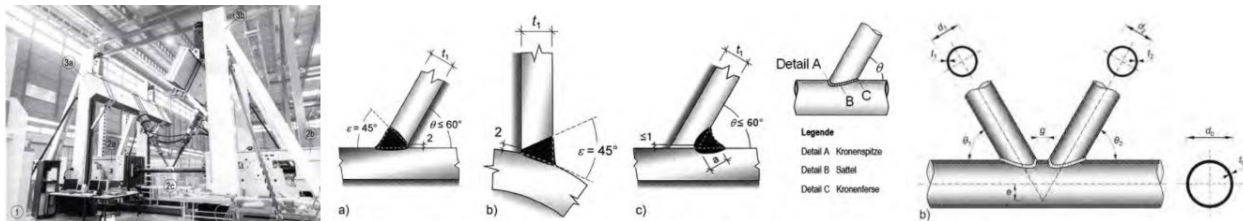

Figure 10: Left image: Example of the K-joint test rig at the material Testing Institute in Stuttgart, Germany. Middle image: Overview of an executed weld details as joint connections, a.) crown toe, b.) saddle, c.) crown heel. Right image: Dimensions of hollow section joints, b.) K- and N-joint with a gap. Source:(Ummehofer, Th; Weidner, P.; Muench; et al., Static load capacity of welded, high-strength hollow section joints, DOI: 10.1002/stab.202200056).

3.0 AI- MACHINE LEARNING OR HUMAN AESTHETICS

3.1. Human bias, Artificial Intelligence, Aesthetics Constraints, and Code Permits

Once the final bridge geometry with all centered and aligned structural tubes on the nodes was optimized and validated, it became apparent that a non-centred, organic aesthetical geometry was more appealing than the centered steel tubes and node connections. In this context, it is important to note that GA-based workflows using load metrics and EAs cannot capture human perceptions of the bridge aesthetics (Andia and Spiegelhalter, 2014). The AI-ML algorithms only process performance-based data with TOs closed to growth patterns (Figure. 11).

Therefore, the final iteration processes involved a lot of 1-1 workshops with the software in ZOOM with the team members, the client and the additive manufacturers discussing aesthetics, textures, robotic G-codes and WAAM or Laser Printing capabilities. Then, the following validation phase and fitness tests for the final approval by a German Steel Test Institute to comply with the DIN EN 1993-1-8 and ISO 14346 codes and permits required even more refinement (Thyssen-Krupp AG, 2023) (Figure. 10).



Figure 11: Typical growth patterns, global bracing, bending moments based on weight factors and growth of trees, roots and tree branches used by EAs as a shape scheme for shape optimisations in robotic structural analysis programs. Source:(©Thomas Spiegelhalter.2022)

CONCLUSION & FUTURE WORK

This research-led structural design project demonstrates an innovative AI-assisted computational structural design approach with deep neural networks. It combines bottom-up evolutionary agents-based geometry models for growth processes found in natural systems with top-down genetic and evolutionary algorithms for optimisation.

Comparing various software applications through many performed generative design and finite element modeling iterations to create an efficient and aesthetically stimulating hybrid additive manufactured BlueMint® steel bridge with robotic 3D WAAM paid off.

The public hype that wire and arc additive manufacturing (WAAM) is the only method of metal 3D printing versus standard off-the-shelf prefabrication with steel tubes has been refuted. However, the many comparative GD and TOs with FEA modeling showed that WAAM still needs to be more efficiently suited to the requirements of the construction industry in terms of better scaling, speed and cost. For example, using only the WAAM technology for a 50 m by 3 m span foot and bike bridge would have been too expensive and slow to manufacture compared to the determined hybrid solution to mix both techniques in a balanced scale, as demonstrated in this research-led design-to-build process. The research finding was clear by performing eight iterations with hundreds of cloud scenarios over four selected design models for further optimisations: The purely organic growing non-centred geometries were aesthetically more convincing. Nevertheless, the multiphysics iterations optimized the configurations in real-world settings to achieve an economical and sustainable mixed additive manufacturing process. As a result, the weight of the hybrid bridge made from a balanced mix of 3D printing and prefabricated steel was reduced dramatically, helping minimize overall production costs and increase assembly speed. Finally, the developed hybrid computational methods suggest further studies on developing other generative EA workflows with deep neural networks. These could expand evolutionary algorithmic computing capabilities, excelling higher-performance production solutions, aesthetics and reducing costs. Future research will include retesting the many experiments performed again, including advanced geometric analysis, material testing, compressive testing of cross-sections and full-scale load testing of the bridge at various production stages throughout and post-construction on the site with sensors.

ACKNOWLEDGEMENTS

We express our gratitude to Landscape Architect Peter Drecker for his collaborative efforts in designing the landscape and integrating our award-winning Generative Steel Bridge Design into the forthcoming Kleine Emscher estuary park at the Rhine in Duisburg, Germany (Andia and Spiegelhalter, 2014). We also extend our appreciation to Prof. Dipl.-Ing. Pfeiffer and Dr. Sum for assisting us in the FEA simulation using Dlubal RFEM software (Kindo, 2015). Lastly, we would like to thank our client, the Emschergenossenschaft in Duisburg, Germany, for their trust in our team and making this project a reality.

REFERENCES

- Allaire, G., Jouve, F., & Toader, A. M. (2002). *A Level Set Method for Shape Optimisation*. *Comptes Rendus Mathématiques*, 334(12), 1125-1130.
- Andia, A., & Spiegelhalter, Th. (2014). "Toward Automating Design and Construction." In *Post-Parametric Automation in Design and Construction*. London: Artech House Publishers, 19-26.
- Autodesk® Simulation Accuracy Verification Examples (AVEs). (2022, November). Manual of the NAFEMS Ltd., ISO 9001:2015 accredited. Accessed July 13, 2023. <https://www.nafems.org/community/regional/americas/>.
- Autodesk Fusion 360 Accuracy verification examples. (2022, November). Accessed July 13, 2023. <https://help.autodesk.com/view/fusion360/ENU/?guid=GUIDC75BE7CE-E4EE-4CAA-8697-095DA51459FB>
- Bian, S., Grandi, D., Hassani, K., Sadler, E., Borijin, B., Fernandes, A., Wang, A., Lu, T., Otis, R., Ho, N., & Li, B. (2022). *Material Prediction for Design Automation Using Graph Representation Learning*. arXiv. <https://doi.org/10.48550/arXiv.2209.12793>
- Kindo, T. (2015). Verify Simulations with the Method of Manufactured Solutions, COMSOL Multiphysics Accuracy Verifications. Accessed July 13, 2023. <https://www.comsol.com/blogs/verify-simulations-with-the-method-of-manufactured-solutions/>
- Spiegelhalter, T. 2014. "Siemens Digital(Self-Learning) Factories and Automation: Automated System Optimization via Genetic Algorithms." In *Post-Parametric Automation in Design and Construction*. London: Artech House Publishers, 19-26.
- Thyssen-Krupp AG. "CO2 Reduced Bluemint® Steel Certification." TUEV Sued. Accessed on July 13, 2023. <https://www.thyssenkrupp-steel.com/en/products/bluemint/bluemint.html>.
- Wang, M. Y., Wang, X., & Guo, D. (2003). *A Level Set Method for Structural Topology Optimisation*. *Computer Methods in Applied Mechanics and Engineering*, 192(1), 227-246.

An Environmental Analysis of a Residential Building in the US: Modeling Challenges and Materials Optimization

Ash Ragheb¹

¹Lawrence Technological University, Southfield, MI

ABSTRACT: This study employs a Life Cycle Assessment LCA approach in calculating environmental impacts of a single-family house located in the US Midwest. The paper models the house over a service life of 60 years and its implications on the environment from cradle to grave. The study calculates impact to air, water, and land through a set of characterization measures based on the mid-point impact assessment methodology developed by the U.S. Environmental Protection Agency; the Tool for the Reduction and Assessment of Chemical and other environmental Impacts (TRACI) version 2.2. The building is a 2-story high and a basement. The skeleton is light frame construction (Type V) as a common method of construction for residential buildings in this region in the US.

To achieve its goal, the study provides an assessment to which building assembly systems contribute the most to the total building impacts and identify the worst burden among them. The outcome tests materials alternatives to use within the enclosure to minimize total impact. The paper employs a retrofit scenario analysis to evaluate replacing current high-impact materials with alternatives retrofit scenarios that have lower impacts and briefly calculate the reduction in the total building impacts against the original construction materials.

KEYWORDS: Environmental Impacts, Life Cycle Assessment, Sensitivity Analysis

INTRODUCTION

In the last 2 decades, the US building industry has greatly invested in energy efficiency for new buildings and performance improvement for the existing buildings. These energy efficient strategies usually include tighter enclosure, using passive design principles, and using renewables for onsite energy generation. Equally important on the other hand is the environmental impact of construction materials and systems during the entire life cycle of the building. The future success of achieving sustainability in the built environment will heavily depend on the way these impacts are balanced and optimized. Residential buildings in the US consume 22% of total energy that totaled 20 quadrillion Btu in 2020. Therefore, reduction in energy and environmental impact will significantly contribute to cleaner and healthier environment.

The contribution of buildings to the overall environmental impacts of human activities has been significant and well-documented (EPA 2009, EIA 2015). According to the US Energy Information Administration (EIA 2015), 19% of the world's primary energy is consumed in the U.S. Buildings also contribute 40% to carbon dioxide emissions in the U.S. (EIA 2012) and near 66% of non-industrial solid waste generation (EPA 2009). The building sector in the U.S. constitutes approximately 44% of the total material use as well as roughly 1/3 of the total CO₂ emission identified as one of the main factors of greenhouse gas emissions (U.S.DOE 2002). Life Cycle Assessment LCA represents a quantitative tool for calculating the environmental impacts of buildings at all stages in their life cycle from cradle to grave. Throughout the life cycle of a building, various natural resources are consumed, including energy resources, water, land, and several pollutants are released back to the global/regional environment. These environmental burdens result in global warming, acidification, air pollution, etc., which impose damage on human health, natural resources, and biodiversity. There is no doubt that reducing the environmental burden of the construction industry is crucial to a sustainable world.

Many studies use LCA in assessing the environmental impacts of buildings. For example, Tingley et al (2015) have used LCA at the level of construction materials to compare three different insulation materials when applied in a typical dwelling. Thiers and Peuportier (2012) conducted a comparative LCA on 2 high energy efficient buildings in northern France: a multi-family social house and two attached passive houses. They found that passive houses have significant reduction in environmental impact especially in the building operation phase, where most impacts take place, due to house energy efficiency. Asif et al (2007) conducted LCA on a 3-bed room semi-detached house in Scotland and found concrete alone consumes 65% of the total embodied energy of the home while its share of environmental impacts is even more crucial. However, this study narrows down to the systems and materials that cause most emissions for the studied case in order to test better retrofitting alternatives as building adapts to its future.

Modeling a single-family residential building with U.S. energy grid has rarely been studied. In Addition, building assembly systems (structural, enclosure, floors, and roofs) on the residential side are rarely studied on individual or as combined systems and need further LCA studies. Thus, such information and data indicating the significant impacts by building systems and/or materials would be of great use in design and management of the building life cycle maintenance. The literature also supports that retrofit and building adaptation is a healthy process to save energy and protect investments. Thus, LCA is a beneficial tool in this ongoing adaptive process as the findings support these flexible retrofits of systems, and/or materials, with way less impacts alternatives.

1.0 RESEARCH METHOD AND ASSUMPTIONS

A life cycle assessment (LCA) framework is selected to analyze the environmental impacts of a residential building in the Midwest. Sixty years of use was assumed to be the basic life cycle. LCA is the most appropriate framework for the identification, quantification, and evaluation of the inputs, outputs, and the potential environmental impacts of a product, process, or service throughout its life cycle, from cradle to grave i.e., from raw material acquisition through production and use to disposal [as defined in ISO 14040, 1997]. The LCA had three main phases; inventory analysis for quantifying emissions and wastes, impact assessment for evaluating the potential environmental impacts of the inventory of emissions and wastes, and interpretation for defining the most significant impacts.

LCA is defined as a holistic and systematic process to calculate the environmental burdens associated with a product or process. The process identifies and quantifies energy and material usage and environmental releases of the studied system and evaluates the corresponding impacts on the environment. Identification and quantification of material and energy flows (inputs and outputs) of the case study house were obtained from the construction drawings and specifications and modeled using series of software listed below.

The quality of the data used in the life-cycle inventory was evaluated with the help of a six-dimensional estimation framework recommended by (Heijungs, et al. 2002). The quality target for the LCA was set to be at the level of “good,” which means reliability of a most recent documented data from actual drawings, specs sheets. In life-cycle impact assessment LCIA, the magnitude and significance of the energy and material flows (inputs and outputs) were evaluated. The impact categories included were those identified by EPA (2006) as ‘Commonly Used Life Cycle Impact Categories’. Among the 10 listed categories, the impact categories discussed in this paper shown as follows. To shorten the text in findings, impacts will be abbreviated as shown in bold. The impacts are:

- Primary Energy (Fossil Fuel Consumption) **FFC**,
- Resources Use **RU**,
- Global Warming Potential **GWP** (Climate Change),
- Acidification Potential **AP**,
- Eutrophication Potential **EP**, (Water Contamination)
- Human Health Respiratory Effect Potential **HHREP**,
- Photochemical Ozone Creation Potential **POCP**, or Summer Smog,
- Ozone Depletion Potential **ODP**.

The chosen impact categories are also on the short list of environmental themes that most environmental experts agree to be of high importance in all regions of the world and for all corporate functions. Furthermore, the used impact categories are consistent with the air and water emissions that the World Bank (1998) has recommended to be targeted in environmental assessments of industrial enterprises. The classification, or assigning of inventory data to impact categories, and the characterization, or modeling of inventory data within the impact categories (ISO 1997), were performed using the ATHENA 4.2 Impact Estimator (2018) which is used to model the building. The program filters the LCI results through a set of characterization measures based on the *mid-point impact assessment* methodology developed by the U.S. Environmental Protection Agency (U.S. EPA); the *Tool for the Reduction and Assessment of Chemical and other environmental Impacts* (TRACI) version 2.2. In the life-cycle interpretation section, the results are also examined from the building assembly systems (foundations, structures, walls, floors, and roof) so that the environmental impact of each system’s life cycle can be quantified.

1.1. Case Study Building Description

The case study is a single-family house located in zone 5-A (per ASHRAE’s classification) in the Midwest of the U.S. Its construction ended in 2015. The building has 2,500 sq ft (232 m²) of gross floor area, and a volume of 36,700 cu ft (1039 m³). The building consists of a basement, 2 floors above ground, and an attic. The structural frame is dimensional lumber light wood frame construction. The exterior walls have 25% brick veneer, and the rest is vinyl siding. Interior walls are wood studs with gypsum board facing to receive paint or wallpaper. Basement walls are 10” thick cast-in-place concrete. The annual energy consumption (operational energy) is calculated using the actual consumption energy bills. The natural gas consumption, mainly for water and space heating, of the building is 1.2 Mbtu (480 Btu/sq ft/year) and this is equivalent to 0.14 kWh/sq ft/year. The electricity consumption is 6,650 kWh/year (2.66 kWh/sq ft/year, or approx. 9,076 Btu/sq ft/year of energy intensity), which is slightly below U.S. average consumption for a residential building. (10,632 kWh/year) per Energy Info Administration (eia.doe.gov) as of 2021.

In the study, the life cycle of the building was divided into 5 main phases; building materials manufacturing, construction processes, operation phase, maintenance, and demolition. Transportation of materials was included in each life-cycle phase through the software. The building materials phase included all of the transportation to the wholesaler warehouse. The construction and demolition phases included the transportation from the warehouse to the site.

1.2. Materials Manufacturing

The following building element categories were included in the study: foundation, structural frame (beams & columns), floors, external walls (enclosure), roofs, and some internal elements e.g., doors, and partition walls. The amount of each material used in the building was derived from the bill of quantities generated by the software. However, building modeling was mainly based on input from architectural drawings, and the architect's specifications.

1.3. Construction Phase

The construction phase of the building included all materials and energy used in on-site activities. Data were modeled for the use of electricity, construction equipment, and transportation of building materials to the site (average 100 mi).

1.4. Operation Phase

The use of the house was divided into mainly space and water heating (by natural gas) and electrical consumption for space cooling, lighting, and appliances. Energy consumption was obtained from actual bills. In the retrofit analysis with new materials, energy estimation was performed using eQuest 3.65, a DOE 2 energy simulation program for electricity use and HVAC heating and cooling loads. All building parameters (dimensions, orientation, walls, windows, etc) were modeled.

1.5. Maintenance and Retrofit Phase

The maintenance phase included all of the life-cycle elements needed during the 60 years of maintenance; use of building materials, construction activities, and waste management of discarded building materials. An estimated 75% of building materials was assumed to go to landfill, and 25% was assumed recovered for other purposes such as recycling.

1.6. Demolition Phase

The demolition phase included demolition activities on-site, transportation of discarded building materials (75% of the total) to a landfill (100 mi), and shipping of recovered building materials to recycling site (100 mi, on average). The entire house was assumed to be demolished.

2.0 INTERPRETATION OF RESULTS

To interpret the results for the purposes of design management, an analysis of the result from the building assembly systems perspective is important. Hence, the life-cycle phases are divided into life-cycle elements, the elements belonging to different building assembly systems are grouped together, and the life-cycle impacts of each building system; foundations, walls, structure (columns and beams), roofs, floors, are calculated. Figure 1 shows that the environmental impacts of the house life cycle are divided into 5 components systems. Three significant systems account for the highest environmental impacts of this house. These are roof, the wall systems, and the structure (columns/beams) respectively.

The results for all impacts have to be normalized per sq meter of building area for fair comparison. However, when comparing the life cycle impacts of assembly systems, it was surprising to find that the roof system has huge impact compared to building walls and structures which come second and third respectively. This happens in most impact categories (FFC, GWP, AP, EP, POCP, HHREP). In this study (Fig.1), the result was primarily due to increasing the attic insulation thickness to increase energy efficiency. The insulation used (fiberglass batt), albeit high in R-value (R 30), it has high embodied energy and has huge emissions during its manufacturing process. Insulation also covers wide area of the attic and walls systems forming the building enclosure. The other material, causes this huge roof impact, is asphalt shingles (with its massive embodied and transportation energy). These results made fossil fuel consumption FFC (embodied + transportation energy) the most dominant impact category in the whole assembly (Fig.1). Resources use RU is the highest in foundations and floors systems due to the massive concrete weight in foundations and the wide area both systems cover. GWP is more dominant in roof, walls, and structures (due to insulation emissions). AP is the highest impact in roof and structure assembly due to some materials such as gypsum boards, fiberglass insulation, and vapor barriers which release Sulphur dioxide (SO₂) and Nitrogen oxides (NO_x) during manufacturing that contribute to acid rain formation when released to the environment.

Figure 2 shows the percentage of the contribution of each building system to the 8 impact categories evaluated. For example, from left to right, roof system is the major contributor to fossil fuel energy (FFC) impact due to insulation, roof felt, and asphalt shingles. Foundations system is the main contributor to resources use (RU) due to weight. Wall system is another major contributor to respiratory impact HHREP and AP due to insulation manufacturing, gypsum boards, brick, and vinyl siding. Contamination to water EP is mostly caused by structures (beams/columns) due to massive releases to water by wood industry during manufacturing. Finally, ozone impact ODP is mostly caused by the foundation systems which contain cement with its notorious releases during its manufacturing.

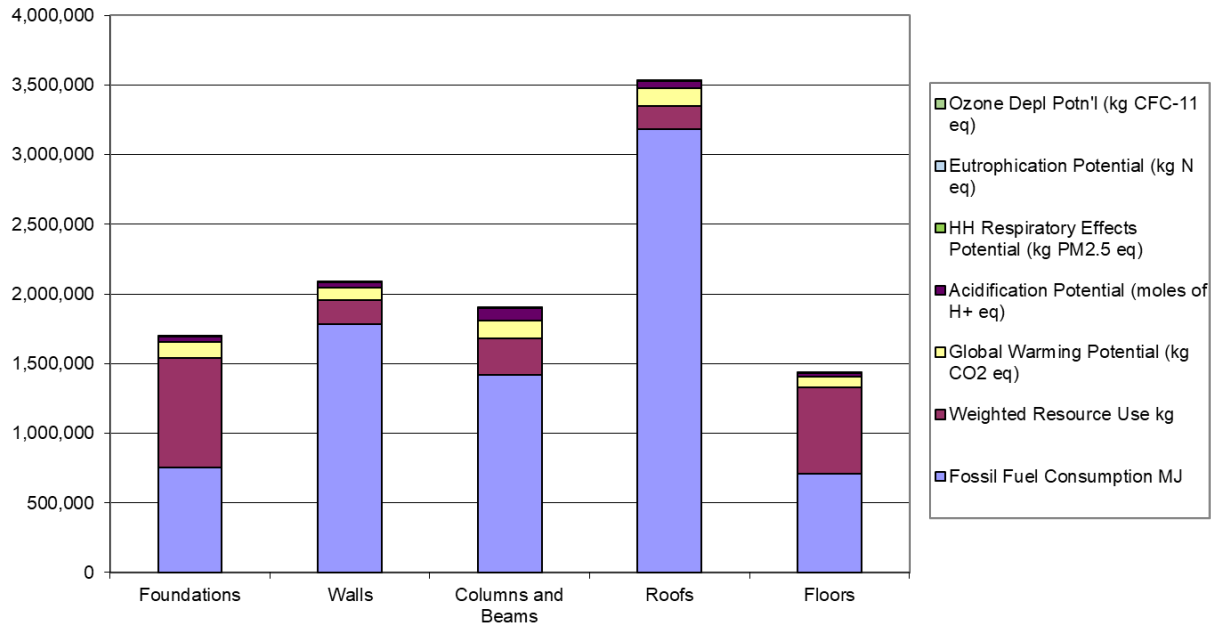

Figure. 1: Environmental Impacts by Each Building Assembly Systems. Source: Author 2023

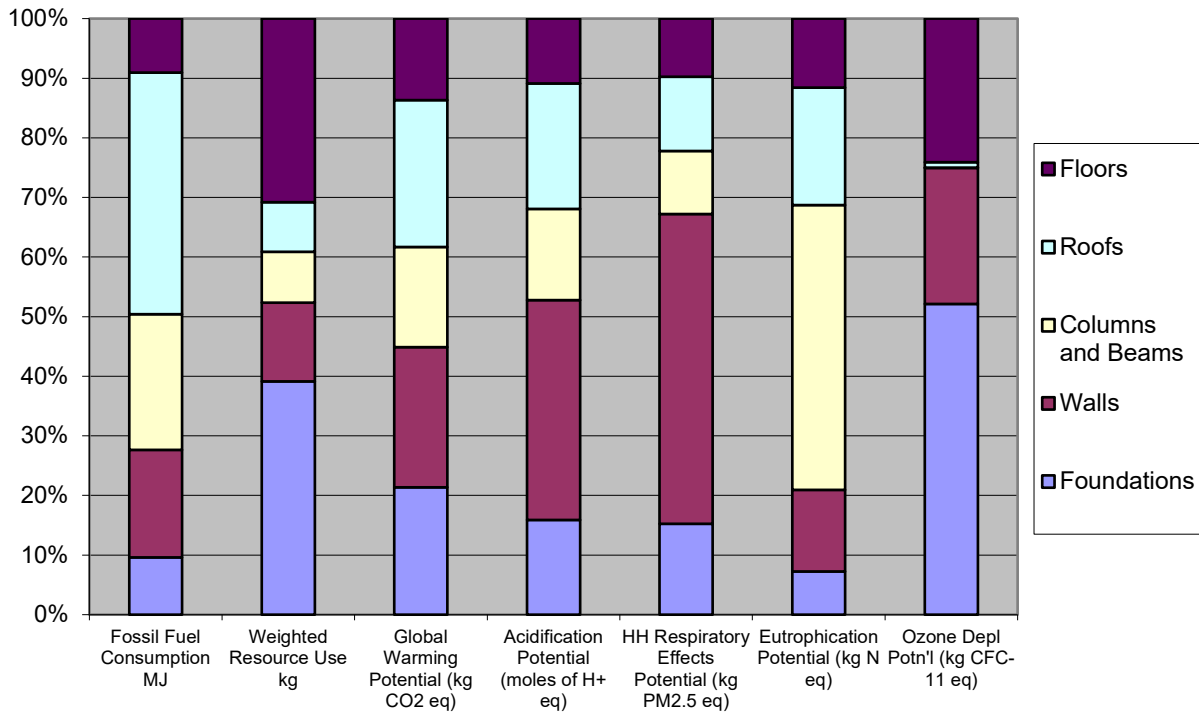

Figure. 2: Building Assembly Systems Contribution to Each Env Impact Category. Source: Author 2023

3.0 RETROFIT SCENARIO ANALYSIS

Sensitivity analysis is typically used to check either the significance of changing key parameters contributing to the overall LCA or key assumptions governing the methodology of the LCA itself. The *what if* sensitivity scenarios are used to compare the replacement of materials that have high impacts within the building with more environmentally friendly alternatives, and then quantify these changes in the environmental impacts again at the end of the 60 years. From the previous results, the study found that materials such as attic fiberglass insulation and bituminous felt underlayment

cover huge area, quantities, and potential high impact in many categories. Therefore, *roof* materials are replaced with more environmentally friendly alternatives, then the total impacts are assessed again with the new alternatives to test how much reduction to the results was achieved. The other systems (foundations, structure, floors) are not changed in this analysis because they are fixed systems (cannot be changed) once the building is erected. The roof is chosen because it represents the highest impacts share by assembly systems, besides walls and structure (Fig.1). This is consistent with ISO 14043 (1998) to “asses the sensitivity of data elements that influence the results most greatly”.

Table 1: Retrofit Scenario Analysis

	Attic Insulation	Roof Deck	Walls	Windows Glazing
Existing	10" fiber glass batt insulation (no vapor barrier) w/ R-30	Bituminous felt underlayment	4" fiber glass batt insulation	Double pane transparent glass
Retrofit	12" blown in cellulose insulation w/ R-30	Synthetic underlayment	4" cellulose insulation	Double pane Low-e glass

3.1. Retrofits Assumptions Scenarios

A list of changing variables included in the analysis is shown in (Table 1). The main assumptions for retrofitting was to try other alternatives for the roof and wall system since they showed the highest impact among assembly systems (Fig.1). cellulose blown in insulation proved to be more environmentally friendly and gives comparable R-value over fiberglass insulation but with way less environmental impact due to its recycling nature. Roof replacement is suggested to take place 2 times during 60 years of life (every 30 years). This seems quite reasonable assumption since the life expectancy of a good roof shingles is between 20-30 years. Suggested changes are to replace the 10" thick fiberglass insulation and bituminous felt with 12" thick cellulose insulation (to give the same R-value) and synthetic felt. In addition, since most impact happen in building operation phase, a double pane low emissivity (low-e) glass was suggested to reduce heat gain and keep warmth inside. The materials that were chosen represent the most significant materials of the roof system due to quantity (coverage area) and their possible high emissions during manufacturing. Other roof and walls materials such as OSB roof sheathing, ridge vents, gypsum boards, vinyl siding were similar in both comparative assemblies. Despite its high impact, vinyl siding was not optimized for its durability over wood siding that need extensive maintenance and protection from the elements using polyurethane based paints (another notorious high impact material).

3.2. Retrofit Sensitivity Results

Figure 3 shows results of all impact categories by building assembly systems. The two scenarios are the *existing* calculations scenario and the *retrofit* scenario. Results show that sensitivity scenario with alternative materials has reduced values in all impact categories due to the change of insulation, roof underlayment, and low-e glass (Table 1). These reductions range between 6% and 20% in the 8 different impact categories this study has investigated. The retrofit sensitivity also highlights the importance of roof insulation and felt as sensitive materials that have huge quantities within the house. They significantly reduce the whole impacts if chosen carefully by architects.

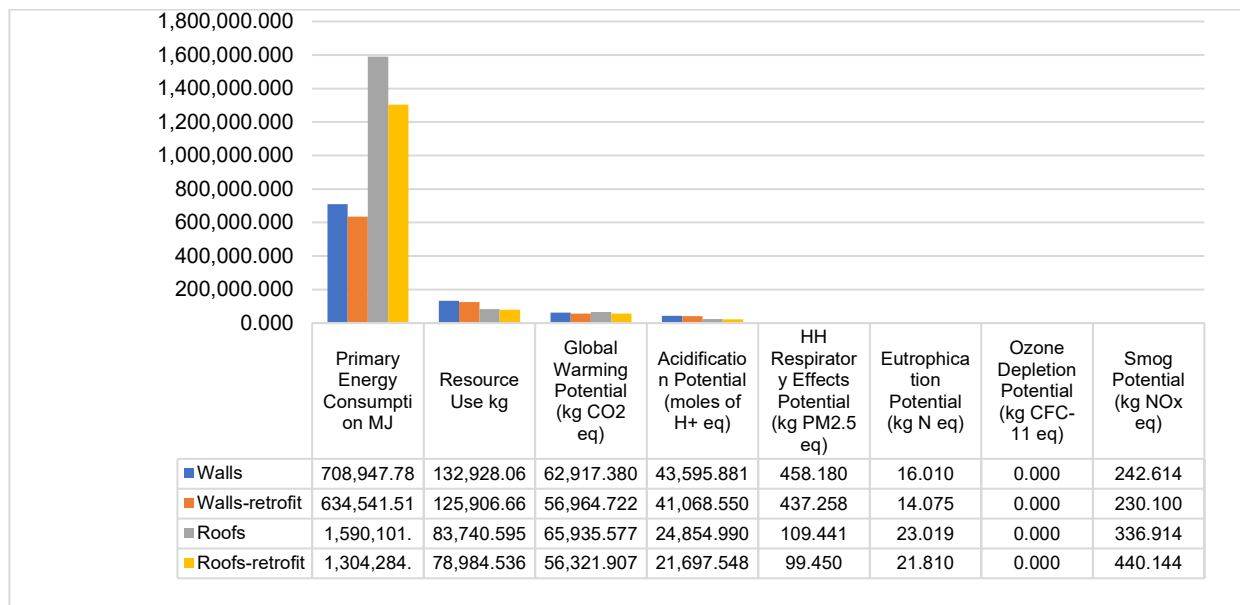

Figure. 3: Environmental Impacts Reduction Due to Retrofitting with New Materials. Source: Author 2023

CONCLUSION

This study quantified and compared the environmental impact caused by a residential building's assembly systems. The study examined the building assembly components that most contribute to its life cycle impact. The study found that roof and wall systems to have significant environmental impacts due to the use of fiberglass insulation, roof felt, and asphalt shingles materials. Using more environmentally friendly materials like cellulose insulation and low emissivity glass in windows rendered a reduction of 6% -20% in different impact categories throughout the entire life cycle. Using a synthetic felt (with its light gray colors) vs. roof bituminous felt (black color) reduced the annual energy consumption of the building by 11% over 60 years which in turn reduced the total impact. The outcome has shown the importance of LCA as tool to choose better alternatives during the maintenance (retrofit) phase of a residential building. Some limitations on impacts includes furniture, computers, construction of infrastructure are not assessed due to the limitation of the modeling software. These were excluded to focus on modeling the building assembly systems not the interior furniture.

LCA results demonstrated that the case study house has overall lower energy consumption rate for a residential building in the U.S. This is mainly due to tighter enclosure. One shortcoming though was the use of fiberglass batt insulation without considering its high environmental impact. This resulted in that the roof system had high impact in most impact categories. The LCA method helped to narrow down to this high-impact system and material choices used (e.g. insulation, roofing felt). Hence, even an energy efficient building may have a reverse huge impact due to selection of high-impact building materials within its assembly systems. It seems to have a reduced annual energy savings but has significant high impact of materials that achieve this saving.

The limitation of the study relates to the single-case study method used, because wider generalization based on a single case is not possible. However, the results of the study can be interpreted together with the results from previous LCA studies. The findings of this study support previous arguments that operation energy is a major environmental burden in the life-cycle of buildings, and that some building materials e.g. insulation also have significant impact. This is typical for buildings in the U.S. For other countries, it is more difficult to generalize based on the results of this study. There are many regional conditions used in the calculations that could affect considerably the results outside the U.S. Building design, construction methods, and intensity of energy use in the operation phase are all different. Most importantly, there are differences in electricity generation and energy use (grid mix) especially if a higher proportion of coal is burned in the power plant like the case in the United States. Many European countries and Canada have a higher percentage of electricity from hydro power (almost no emissions) and non-fossil fuels which will affect the final emissions especially the release of CO₂, SO₂, and NO_x to air. The study is also unique in modeling the house with the U.S. electricity grid which depends on coal as a resource at 39% (DOE, EIA 2015).

REFERENCES

- Asif M, Muneer T, Kelley R (2007). Life cycle assessment: A case study of a dwelling home in Scotland. *Building and Environment*, 42: 1391 - 1394.
- ATHENA, Impact Estimator 4.2 (2016). Athena Sustainable Materials Institute, Morrison Hershfield Consulting Engineers. Ottawa; Merrickville, Ontario, Canada.
- eQuest 3.65 (2016), USDOE interface, the QUick Energy Simulation Tool (eQuest) [software tool]. Available from: <http://www.doe2.com/equest/>
- Heijungs, R. and Suh, S. 2002. Computational Structure of Life Cycle Assessment. Kluwer Academic Publishers, The Netherlands.
- ISO. (1997). "Environmental management, life cycle assessment, principles and framework." *SFS-EN ISO 14040*, Geneva.
- ISO 14043 (1998). *Environmental Management – Life Cycle Assessment - Life Cycle Interpretation*. International Organization for Standardization, Geneva, Switzerland
- Thiers S, Peuportier B (2012). Energy and environmental assessment of two high energy performance residential buildings. *Building and Environment*, 51: 276 - 284.
- Tingley, D., Hathway, A., Davison, B. (2015). *An environmental impact comparison of external wall insulation types*. *Building and Environment*, 85: 182-189.
- U.S. DOE, Energy Information Administration EIA (2021), Electric Power Industry 2021: Year in Review, [<https://www.eia.gov/tools/faqs/faq.php?id=97&t=3>], (accessed Nov 2022).
- U.S. EPA, Env. Protection Agency (2009). Buildings and the Environment: a Statistical Summary. <http://ww2.harford.edu/faculty/eaugusti/Environ%20Health/green%20building%20stats.pdf>
- U.S. EPA, Env. Protection Agency (2006), *Life Cycle Assessment: Principles and Practice*, EPA/600/R-06/060 May 2006.
- U.S. EPA, Env. Protection Agency (1993), *Life Cycle Assessment: Inventory Guidelines and Principles*, EPA/600/R-92/245
- World Bank. (1998). "Industrial estates, pollution prevention and abatement handbook." *Draft Technical Background Document*, Environmental Dept., Washington, D.C.

An Evolutionary Multi-objective Optimization Tool for Designing Kinetic Façades Integrating Daylight and Lighting Energy Simulation

Samin Kamalisarvestani¹, Mehdi Ashayeri¹, Narjes Abbasabadi²

¹Southern Illinois University, Carbondale, IL, United States

²University of Washington, Seattle, WA, United States

ABSTRACT: To date, few work has been done to evaluate the performance of dynamic shading configurations through simultaneously and effectively integrating energy and health metrics at the early-stage design. This study creates a framework for designing kinetic shading patterns using integrated daylight and lighting energy. The framework automates the entire exploration process by incorporating evolutionary-based multi-objective optimization algorithms for the simultaneous evaluation of Spatial Daylight Autonomy (sDA), Annual Sun Exposure (ASE), and Lighting Energy (LE) metrics on façade pattern selection and movements. To create the platform, we used series of open-source software, including Rhino Ver. 7, Grasshopper, Ladybug Tools, and Wallacei. In this study, we tested five shading patterns for designing the kinetic façade design: two contemporary patterns (Mashrabiya of Al-Bahr Tower, Dubai, UAE, and City View Garage, Miami, USA), a vernacular pattern called Shobak extracted from a traditional Iranian lattice, and two simple patterns (horizontal and vertical blinds). We tested the patterns on a shoebox model with a full glass wall opening toward the south in Chicago, IL. The results show that an effective computational platform can provide a holistic design exploration capability for developing kinetic shading configurations that consider visual health and comfort, as well as uniform daylight distribution, at the early-stage design. It also includes the LEED certification pass/fail component to aid the exploration of the platinum LEED v.4 lenience. This work is an attempt to conduct a more comprehensive analysis of performance metrics in the design of kinetic façades for sustainable architecture.

KEYWORDS: Daylight, lighting energy, kinetic shading pattern, multi-objective optimization, early design stage.

INTRODUCTION

Introducing spaces that utilize the attributes of daylight to improve the comfort, health, and performance of the users has remained a major challenge for the field of Architecture (Altomonte 2009). Lighting accounts for 18% of the overall building energy usage in U.S. college and university buildings (U.S. National Grid, Managing Energy Costs in Colleges and Universities). Therefore, daylight triggered the interest in using renewable energy resources to improve the potential performance of buildings (Boyce, Hunter, and Howlett 2003). Visual discomfort in educational buildings is an essential issue since it is directly related to students' well-being and learning performance (Baker and Steemers 2013; Michael and Heracleous 2017). Daylight, due to its highly variable and uncertain characteristics, changes appearance and varies with time, making it difficult to track and predict (Gherri 2015). However, it is beneficial to maximize its contribution to providing a more comfortable condition for the users (Zomorodian and Tahsildoost 2019).

Daylight is a primary design feature that provides a connection to the outdoor environment (Gherri 2015) and creates a dynamic indoor lighting condition (El Sheikh 2011). Daylight can affect human health, including psychological, mental, physiological conditions (Tzempelikos 2017) and visual comfort (Altomonte 2009). Working in daylight considerably decreases negative moods (El Sheikh 2011) and increases productivity, especially for precision, reading, and writing activities. As a result, to bring natural light into the building, the percentage of window to wall ratio has been increased since early 20th century. Although glass is helpful for allowing light into buildings, a lack of ability to control the intensity of direct natural light (Schumacher, Schaeffer, and Vogt 2012) can result in an increase in heat gain and non-uniform daylight distribution, contributing to visual discomfort such as glare (Sherif, Sabry, and Gadelhak 2012). Thus, optimizing the daylight performance for a design is essential to ensure the occupant comfort (Gherri 2015). To achieve the goal, the façade plays an integral role in controlling light penetration with relevance to the sun's movement position and adapting to the outdoor environment (El Sheikh 2011).

Façade is a building component that defines the zone between buildings' exterior and interior (Moloney 2011). Façade, on the one hand, is an essential element to protect the building against extreme climatic conditions (e.g., glare and overheating) (Schumacher, Schaeffer, and Vogt 2012); on the other hand, to provide interiors with essential daylight (Sharaidin, Burry, and Salim 2012). Moreover, building façades account for more than 40% of heat loss in the winter and overheating in the summer (Barozzi et al. 2016). However, daylight management arises because of the problems that the traditional concept of façade has been practiced: static and pre-designed. Accordingly, high-performance

building façades have become one of the primary targets for researchers and designers because of their essential roles (Wang, Beltrán, and Kim 2012), including an increase in lighting and visual comfort. By actuating the façades and making them more dynamically responsive to the environment, they can now better adapt to improve user comfort and different weather conditions (Alawaysheh 2019; Alotaibi 2015). The kinetic façade can be designed in a dynamic form to reach an optimal building performance (Alotaibi 2015). The kinetic façade is characterized by complex shapes and patterns (Alotaibi 2015), singular forms, and a dynamic process from which a range of forms and patterns manifest over time (Moloney 2011). The Kinetic façade is capable of changing its geometry and patterns repeatedly and reversibly to integrate motion with environmental conditions of the context and user requirements (Alotaibi 2015; Gherrri 2015).

Parametric models can automatically adjust geometric models in response to dynamic real-time data (Davis, Salim, and Burry 2011). Thus, the combination of kinetic façade and parametric modeling has the potential to improve the control of lighting in buildings to meet users' comfort by employing responsive components (Pesenti, Masera, and Fiorito 2015; Pesenti et al. 2015). Patterns play the leading role in predicting the performance of kinetic façades through parametric modelling. Kinetic patterns are formed by multiple singular movements (Mahmoud and Elghazi 2016) to provide various façade compositions. Geometric patterns have been popularly used in architectural designs, primarily due to their function as an element in adorning surfaces (Sayed et al. 2015). Due to their systematic symmetry and mathematical nature, geometric patterns can easily be generated as single reproducible modules with parametric tools (Abas and Salman 1994). Porosity in these patterns can link the function of light to the façade as a filter between the outside and interior to create games of reflections and shadows while concealing the direct penetration of natural light (Gherrri 2015). Geometrical patterns have shown profound effects in ancient Architecture as an environmental solution for daylight (Alani and Barrios 2015). For instance, Mashrabiya is a traditional latticework shading system in Arab countries. Hence, integrating geometric patterns with kinetic façade can strengthen the relationship between daylight and indoor conditions and, consequently, optimal building performance.

This paper aims to explore how various parametric and kinetic shading devices enhance daylight performance and reduce electricity usage in a unified system as a suggestion tool for improving indoor health for educational spaces based on platinum LEED v4 requirements. Educational buildings are among the most important fields for daylight solutions, as optimal daylighting can improve students' mood, concentration, behavior, and learning process in general (Schumacher, Schaeffer, and Vogt 2012). To explore this idea, kinetic shading forms will be created in RhinoCeros and Grasshopper; and daylight and glare metrics will be simulated using Radiance and OpenStudio interface ("OpenStudio" 2008) and optimized using Wallacei to find the best pattern solution for user comfort in terms of daylight performance. This will help designers expand the use of kinetic façades with optimum patterns with simulation in the early stage of the design.

1.0 METHODOLOGY

This research tested various kinetic shading patterns to explore and optimize the design objectives dynamically, an acceptable illuminance level, minimum direct sun hours, reduced lighting energy, and the view to the outside. Consequently, five various kinetic shading patterns are assessed on a shoebox model with a window on the south façade. The procedure is developed in the Rhino3D / Grasshopper (Rhino 3D 1980) Modeling environment. Ladybug/Honeybee ("Ladybug Tools" 2012) is used for daylight analysis and OpenStudio ("OpenStudio" 2008) to estimate lighting energy usage.

The workflow for the framework entails four main steps (Figure 1):

Step 1: This step handles various inputs to explore design space; shoebox geometry setup, adding sensor grid to the shoebox, and creating five kinetic shading patterns. A shoebox with 5m width, 10m depth, and 3m height is generated parametrically in the grasshopper, and the window is embedded on the south façade of the shoebox with an 80% window-to-wall ratio to maximize the daylight penetration into the interior space as much as possible. Materials for the shoebox are also selected with different diffuse reflectance, 50% for the wall, 80% for the ceiling, 20% for the floor, 35% for kinetic shading devices, and 50% for transmittance of the window. After modeling the core geometry, kinetic patterns are designed parametrically in the grasshopper to have seven opening angle degrees (0°, 15°, 30°, 45°, 60°, 75°, 90°). The patterns are selected among five different functional designs, namely, horizontal, and vertical louvers, Mashrabiya, a pattern from Miami City View Garage, and Shobak (Figure 2).

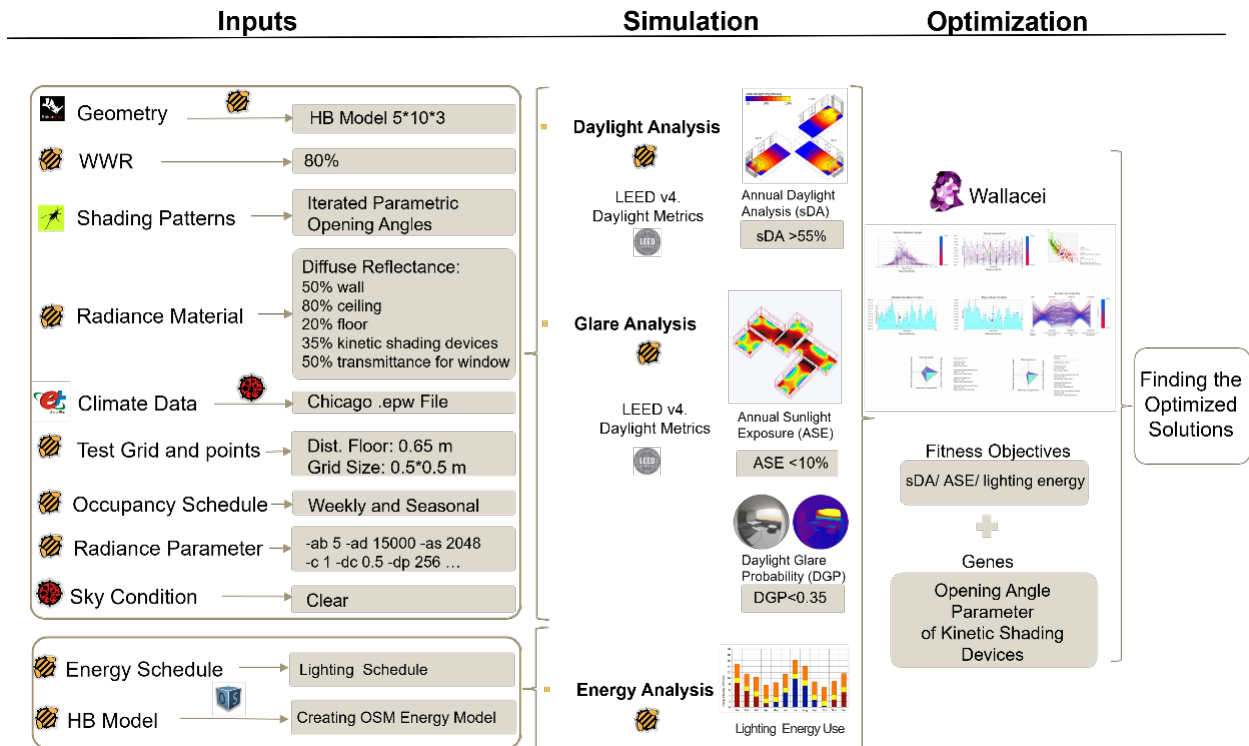

Figure 1: Detailed workflow. Source: (Authors 2022)

Step 2: The previously generated shoebox is translated as the Honeybee model (HBM) for daylight assessment. Kinetic shading patterns are added to the HBM as shading devices with 0.1m offset from the window. The following step is to add sensor grids with a scale of 0.5*0.5 (total of 200 sensors) and 0.6m offset from the floor. Chicago weather data is used for daylight analysis from the EnergyPlus website. The college building occupancy schedule which represents occupancy presence and density, is also added to run the daylight simulation effectively. Two daylight metrics are evaluated during the simulation, annual daylight simulation and direct sun hours, to analyze spatial daylight autonomy (sDA) and annual sunlight exposure (ASE). The best practice in defining metrics is to use standard metrics published by organizations such as the US Green Building Council's (USGBC) Leadership in Energy and Environmental Design (LEED) (LEED Leadership in Energy and Environmental Design: Reference Guide for Building Design and Construction; V4, 1994). In addition, to give more depth to the daylight evaluation, Daylight Glare Probability (DGP) is also calculated. DGP enables evaluating the influence of both direct illuminances at the eye level and luminance contrast to determine the final glare condition for occupants (Wienold and Christoffersen 2006).

The simulation aims to meet the sDA (300 (lx)/55%) and ASE (1000 (lx)/250h) criteria of platinum LEED v4. sDA illustrates the percentage of floor zone that obtains no less than 300 (lx) for at least 55% of the yearly inhabited hours (Heschong, Wright, and Okura 2002), and any sDA percentage less and more than 55% defines as inadequate zones and required daylight levels, respectively. Moreover, 250 hours of direct illumination of 1000 lux to analyze the ASE should be less than 10% (Gherri 2015). DGP has also been divided into four categories: imperceptible, perceptible, disturbing, and intolerable, with values ranging from $DGP \leq 0.35$, $0.35 < DGP \leq 0.40$, $0.40 < DGP \leq 0.45$, and $DGP > 0.45$, respectively (Reinhart, Mardaljevic, and Rogers 2006). Another objective is lighting energy (LE) analysis, which is needed HBM to be translated to OpenStudio model (OSM) and adding the college lighting usage schedule. College lighting schedule is generated from annual daylight analysis to control daylight in energy analysis.

Step 3: Having optimal decision-making requires multi-objective optimization and dynamic trade-offs between objectives. Therefore, daylight simulation results (sDA and ASE) and lighting energy (LE) analysis output are inputted as fitness objectives (FO) and opening angles as parametric variables to run the optimization through genetic algorithms. Optimization was done in Wallacei (Makki, Showkatbakhsh, and Song 2018) an evolutionary engine that allows users to run evolutionary simulations with a generation size of 100. The FO is to maximize sDA (300 (lx)/55%), minimize ASE (1000 (lx)/250h), and minimize LE as much as possible. Simulation is done for each pattern separately, with 50 generations for the entire population of the objectives. The next step in this process is to decode and filter the simulated result based on FO to select the desired solution.

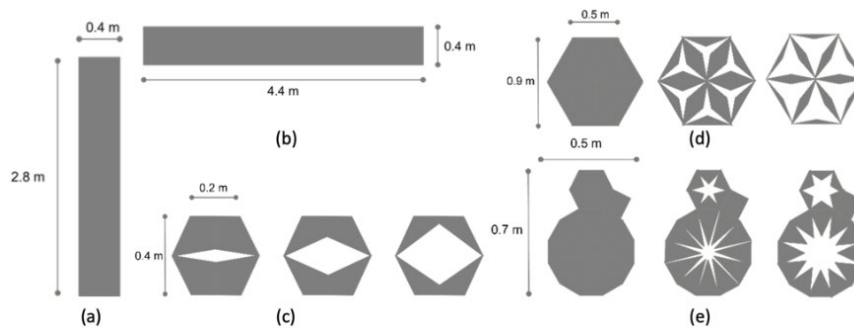

Figure 2: Vertical louvers (a), Horizontal louvers (b), Miami City View Garage pattern (c), Mashrabiya pattern (d), and Shobak pattern (e). Source: (Authors 2022)

2.0 RESULTS

Five kinetic shading patterns are used as a case study to demonstrate this methodology. Following the methodology steps, daylight metrics (sDA and ASE) and lighting energy (LE) are optimized and among the five patterns’ average fitness values, Mashrabiya, Shobak, horizontal louvers, vertical louvers, and Miami patterns showed the best results, respectively. Mashrabiya (Figure 4-top), with an opening angle of 75°, can accomplish sDA of 59.7%, ASE of 9.2%, and LE of 1093.3 kw/h to pass the platinum LEED v4. In contrast, the Miami pattern with opening angle of 90° (Figure 5-bottom), results are sDA of 56.6% and ASE of 12.1%, a failure, which cannot pass the mentioned criteria for daylight. DGP analysis was also done for the average optimal solutions from the optimization to visualize the risk of glare for occupants. Results found all kinetic shading patterns with opening angles of 75° and 90° in imperceptible range (DGP<0.35) at 12:00 pm on the 21st of June and December, achieving complete visual comfort through daylight metrics (Figure 5).

Table 1: Results from optimization.

	Fitness values with rank 1					Relative difference between fitness rank 0				Average of fitness rank 0			
	Fitness Objective/Rank	OA*	sDA	ASE	LE	OA	sDA	ASE	LE	OA	sDA	ASE	LE
Horizontal	sDA/0	90°	62.5	11.8	1071								
	ASE/0	15°	29.2	5.1	1480	60°	54.2	8.2	1216	75°	56.1	10	1134
	LE/0	90°	62.2	11.8	1070								
Vertical	sDA/0	90°	62	12	1064								
	ASE/0	0°	33.6	7.8	1429	45°	56.9	10	1220	75°	60.7	11.2	1090
	LE/0	90°	61.8	12	1063								
Mashrabiya	sDA/0	75°	62.5	12	1098								
	ASE/0	0°	22.7	4.8	1557	30°	40.2	8.1	1408	75°	59.7	9.2	1093
	LE/0	75°	59.7	12	1063								
Miami	sDA/0	90°	56.6	12	1125								
	ASE/0	15°	40	8.8	1340	45°	55.2	11	1227	90°	56.6	12.1	1124
	LE/0	90°	56.5	12	1124								
Shobak	sDA/0	75°	56.7	12	1128								
	ASE/0	0°	34.5	7.5	1429	30°	45.7	9.4	1344	75°	56.5	9.9	1124
	LE/0	75°	56.5	12	1124								

* Opening Angle

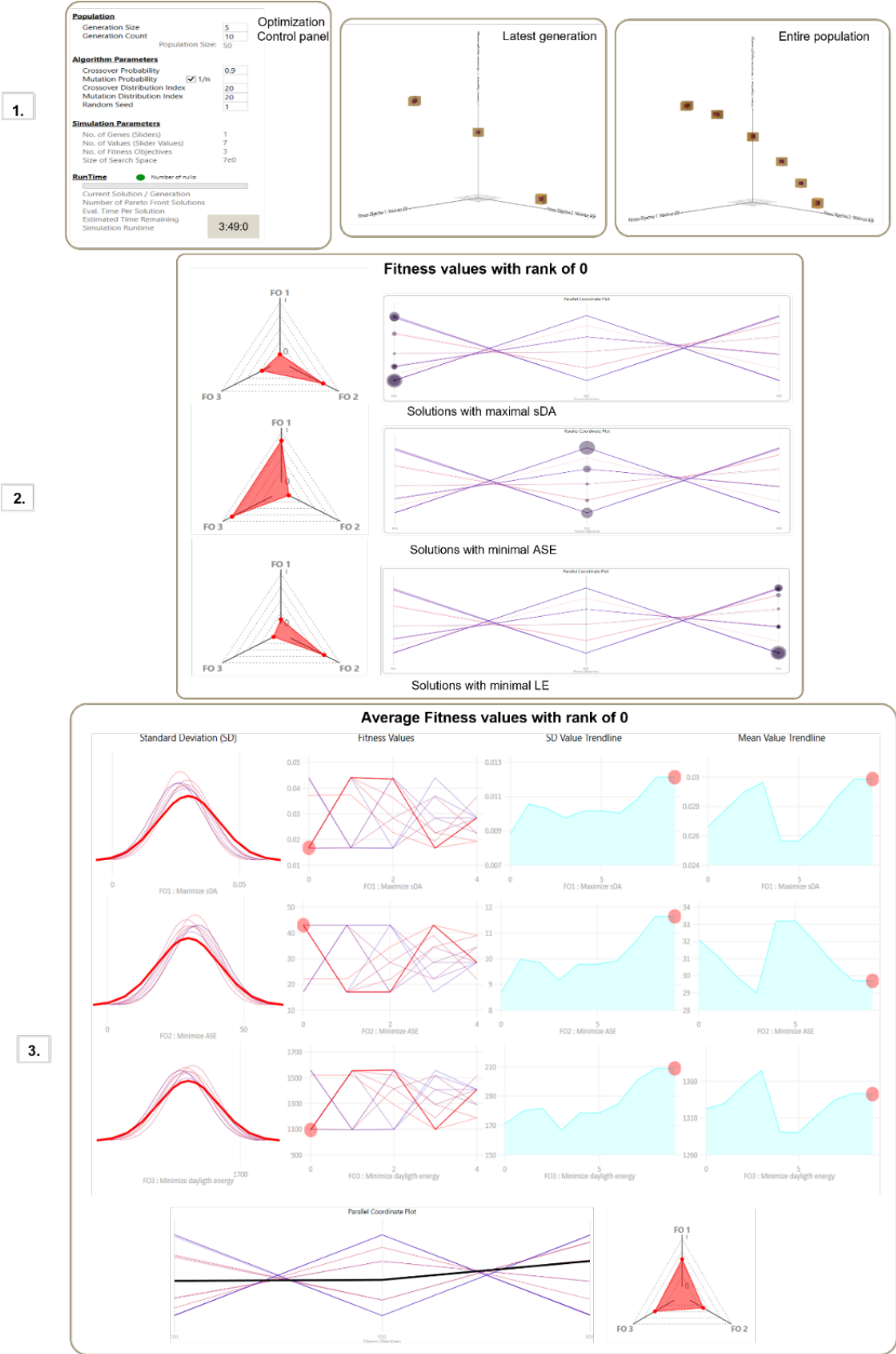

Figure 3: Optimization results for the Mashrabiya pattern. Source: (Authors 2022)

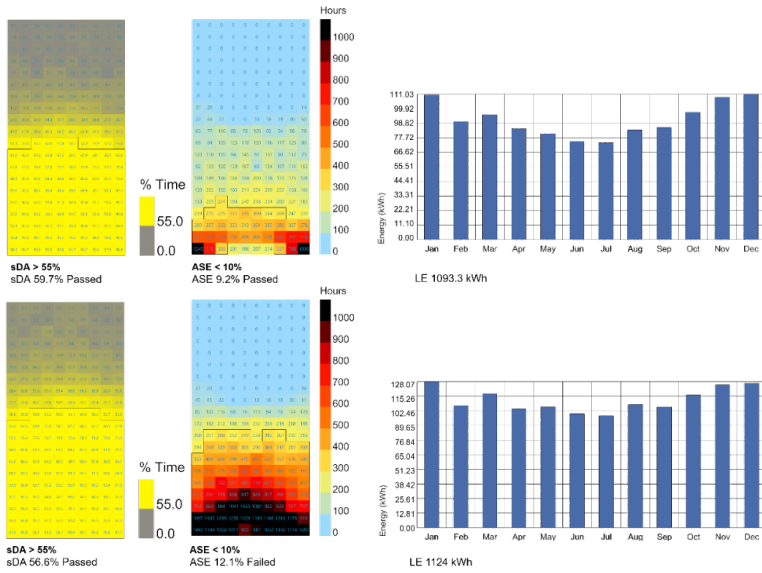

Figure 4: Results of sDA, ASE, and LE simulations for the Mashrabiya (top) and Miami (bottom) patterns. Source: (Authors 2022)

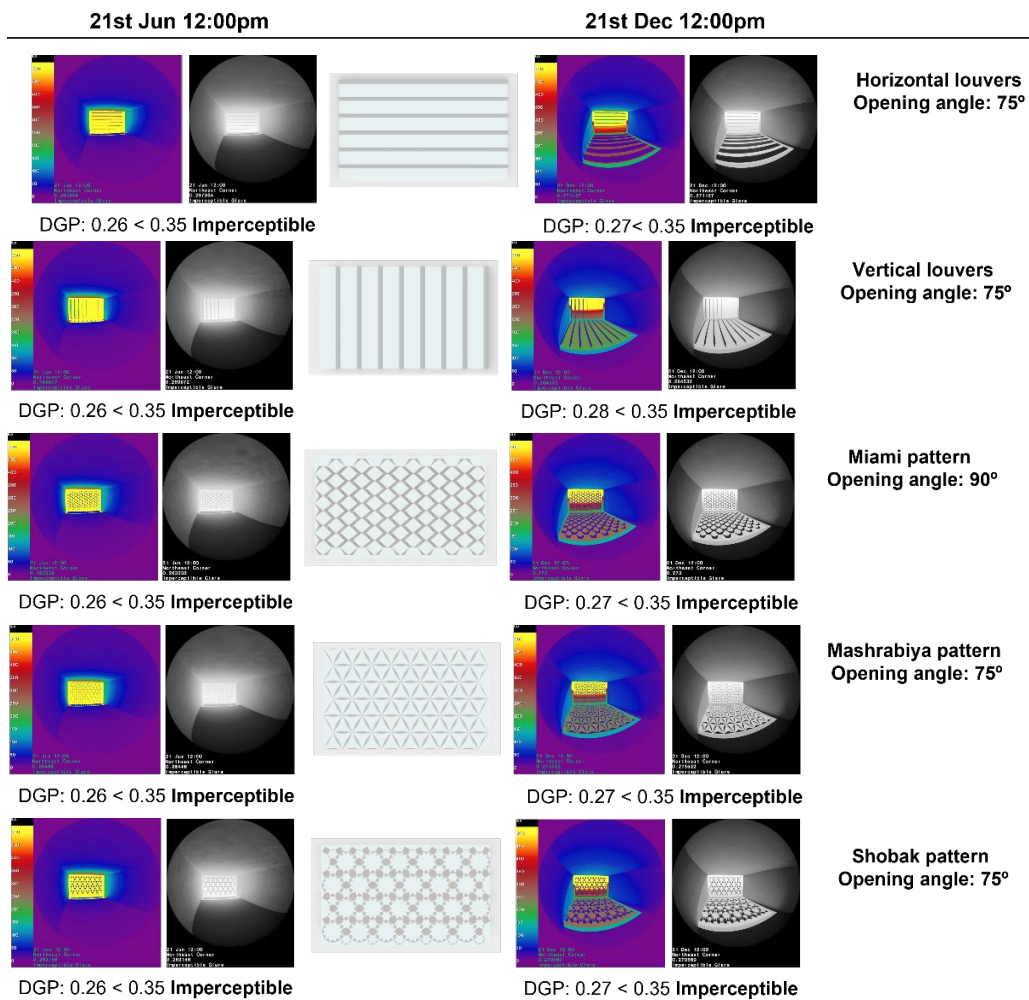

Figure 5: DGP and façade renders. Source: (Authors 2022)

The processing phase has started with 50 generated data sets for each pattern and after decoding the results and data cleaning, five solutions per pattern were selected for further analysis. These solutions are among the best solutions for

each FO which has a rank of 0, the relative difference between fitness ranks that are solutions with equally ranked 0 (the 'fittest' solution is the one with the rank 0) among the three objectives, and the average of fitness ranks which calculated the average between the three objectives.

After processing the data, a consistent behavioral pattern is determined among all fitness values with a rank of 0 of five patterns. Both ASE and sDA data have a non-linear correlation with LE, which indicates that the higher the sDA percentage, the lower the amount of LE usage is. However, they both show the same opening angles when the fitness rank is 0 for the sDA or the LE, which determines the sDA directly affects the LE amount. On the other hand, ASE and LE have an opposite trend; by decreasing the ASE and fitness rank of 0, the LE increasing slightly. Following the methodology of using different opening angles for kinetic shading patterns, results show that higher opening angles such as 75° and 90° have a higher rate of sDA and a lower rate of LE. While lower opening angles like 0° and 15° indicate a lower percentage of ASE (Table 1).

Relative differences between FOs also show moderate opening angles, relatively halfway open for each pattern, which illustrates the possible opening angle for patterns in which all the three FO ranks are 0. Rank 0 indicates an opening angle that can decrease ASE and LE and increase sDA simultaneously. Moreover, the average fitness values mostly show the opening angle of 75° for the average solution between three objectives, which is the optimal solution for this methodology. Therefore, the average between FOs is the calibrated result for the research objectives (Table 1)

Figure 3 indicates the optimization results of Mashrabiya pattern with simulation runtime of approximately 4 hours (section 1). Fitness values with rank of 0 indicate the number of solutions for each FO (sDA, ASE, and LE). Diamond charts in section 2, show the most optimal solution for each FO and each axis on the diamond chart represents one of them. The closer the point to the center of the diamond chart the fitter the solution. Parallel coordinate plots analyze all the solutions in the population through comparing the fitness values for each solution across all FOs. The aim is to extract emergent behavior exhibited by the simulation and better understand how the solutions are optimizing throughout the simulation by showing the frequency of the repeated solutions for FOs. In section 3, average fitness values with rank of 0 orders the solutions according to their mean fitness by calculating the mean fitness rank of each solution's fitness objectives ("Evolutionary Engine for Grasshopper3D | Wallacei" 2019).

3.0 DISCUSSION

The interaction of the building's façade with the surrounding environment significantly impacts the amount of useful daylight penetration into interior spaces. As a result, the early design of a façade with performance-based kinetic shading devices can lead to optimal natural light quality and quantity. Because of the dynamic nature of daylight, the kinetic configuration of shading devices can influence visual comfort and daylight performance and reduce lighting energy consumption. Kinetic shading devices with real-time motions can identify the best orientation and configuration for meeting the occupants' needs. Due to their self-shading assets, parametric and modular kinetic shading patterns redirect daylight into the interior space. These features allow for a reduction in the intensity of direct sun radiation while still allowing adequate daylight to enter the interior space. Furthermore, the transition from two to three-dimensional shape changes in the kinetic patterns is a crucial decision that considerably impacts daylight performance and visual comfort requirements.

For five different kinetic shading patterns, metric simulation using climate-based daylight metrics, based on different opening angles of the kinetic forms, was performed for horizontal and vertical louvers, Mashrabiya, Shobak, and a pattern from Miami City View Garage. The optimization results show an uncomfortable level of glare (ASE) with an opening angle of 75° and 90° for most of the cases (ASE>10%). However, those opening angles provide appreciable daylight level (sDA) for the interior space (sDA>55%). Moreover, enough daylight penetration into the building showed remarkable reductions in lighting energy results.

CONCLUSION

The observation of this study validates that the accuracy of simulation models can be improved by identifying behavioral patterns using a multi-objective optimization approach. Second, the results confirmed that the proposed kinetic shading patterns could be scaled to an actual college building because of the accurate optimization. The primary outcomes of this research are the optimal opening angle for each pattern with a higher amount of daylight and lower lighting energy usage and glare. The simulated results accurately visualized the shoebox daylight demand and main lighting energy load patterns. Thus, this methodology allows designers and policymakers to accurately test the lighting and energy performance of the potential future case scenarios to decide on the early steps of the design.

ACKNOWLEDGEMENTS

SK: conceptualization; methodology; software; formal analysis; investigation; data curation; writing original draft; visualization. MA: conceptualization; investigation; resources; writing (review and editing); supervision; project administration. NA: conceptualization; investigation; resources; writing (review and editing); supervision.

REFERENCES

- Abas, Syed Jan, and Amer Shaker Salman. 1994. *Symmetries of Islamic Geometrical Patterns*. World Scientific.
- Alani, Mostafa W., and Carlos R. Barrios. 2015. "A Parametric Description for Metamorphosis of Islamic Geometric Patterns."
- Alwaysseh, Areen. 2019. "The Impact of Kinetic Façade on the Performance and Energy Efficiency of a Public Building in Dubai-The Case of Dubai Frame." PhD Thesis, The British University of Dubai.
- Alotaibi, Fahad. 2015. "The Role of Kinetic Envelopes to Improve Energy Performance in Buildings." *Journal of Architectural Engineering Technology* 4 (3): 149–53.
- Altomonte, Sergio. 2009. "Daylight and the Occupant." *Visual and Physio-Psychological Well-Being in Built Environments: PLEA*.
- Baker, Nick, and Koen Steemers. 2013. *Daylight Design of Buildings: A Handbook for Architects and Engineers*. London: Routledge. <https://doi.org/10.4324/9781315073750>.
- Barozzi, Marta, Julian Lienhard, Alessandra Zanelli, and Carol Monticelli. 2016. "The Sustainability of Adaptive Envelopes: Developments of Kinetic Architecture." *Procedia Engineering* 155: 275–84.
- Boyce, Peter, Claudia Hunter, and Owen Howlett. 2003. "The Benefits of Daylight through Windows." *Troy, New York: Rensselaer Polytechnic Institute*.
- Davis, Daniel, Flora Dilys Salim, and Jane Burry. 2011. "Designing Responsive Architecture: Mediating Analogue and Digital Modelling in the Studio."
- El Sheikh, Mohamed Mansour. 2011. *Intelligent Building Skins: Parametric-Based Algorithm for Kinetic Facades Design and Daylighting Performance Integration*. University of Southern California.
- "Evolutionary Engine for Grasshopper3D | Wallacei." 2019. 2019. <https://www.wallacei.com/>.
- Gherri, Barbara. 2015. *Assessment of Daylight Performance in Buildings: Methods and Design Strategies*. WIT press.
- Heschong, Lisa, Roger L. Wright, and Stacia Okura. 2002. "Daylighting Impacts on Human Performance in School." *Journal of the Illuminating Engineering Society* 31 (2): 101–14.
- "Ladybug Tools." 2012. 2012. <https://www.ladybug.tools/>.
- LEED Leadership in Energy and Environmental Design: Reference Guide for Building Design and Construction ; V4. 1994.*
- Mahmoud, Ayman Hassaan Ahmed, and Yomna Elghazi. 2016. "Parametric-Based Designs for Kinetic Facades to Optimize Daylight Performance: Comparing Rotation and Translation Kinetic Motion for Hexagonal Facade Patterns." *Solar Energy* 126: 111–27.
- Makki, M., M. Showkatbakhsh, and Y. Song. 2018. "Wallacei: An Evolutionary and Analytic Engine for Grasshopper 3D." Wallacei.
- Michael, Aimilios, and Chryso Heracleous. 2017. "Assessment of Natural Lighting Performance and Visual Comfort of Educational Architecture in Southern Europe: The Case of Typical Educational School Premises in Cyprus." *Energy and Buildings* 140: 443–57.
- Moloney, Jules. 2011. *Designing Kinetics for Architectural Facades: State Change*. Routledge.
- "OpenStudio." 2008. 2008. <https://openstudio.net/>.
- Pesenti, Marco, Gabriele Masera, and Francesco Fiorito. 2015. "Shaping an Origami Shading Device through Visual and Thermal Simulations." *Energy Procedia* 78: 346–51.
- Pesenti, Marco, Gabriele Masera, Francesco Fiorito, and Michele Sauchelli. 2015. "Kinetic Solar Skin: A Responsive Folding Technique." *Energy Procedia* 70: 661–72.
- Reinhart, Christoph F., John Mardaljevic, and Zack Rogers. 2006. "Dynamic Daylight Performance Metrics for Sustainable Building Design." *Leukos* 3 (1): 7–31.
- Rhino 3D, Robert McNeel &. 1980. "Robert McNeel and Associates." www.Rhino3d.Com. 1980.
- Sayed, Zahra, Hassan Ugail, Ian Palmer, Jon Purdy, and Carlton Reeve. 2015. "Parameterized Shape Grammar for Generating N-Fold Islamic Geometric Motifs." In *2015 International Conference on Cyberworlds (CW)*, 79–85. IEEE.
- Schumacher, Michael, Oliver Schaeffer, and Michael-Marcus Vogt. 2012. *MOVE: Architecture in Motion - Dynamic Components and Elements*. Walter de Gruyter.
- Sharaidin, Kamil, Jane Burry, and Flora Salim. 2012. "Integration of Digital Simulation Tools with Parametric Designs to Evaluate Kinetic Façades for Daylight Performance."
- Sherif, Ahmed H., Hanan M. Sabry, and Mahmoud I. Gadelhak. 2012. "The Impact of Changing Solar Screen Rotation Angle and Its Opening Aspect Ratios on Daylight Availability in Residential Desert Buildings." *Solar Energy* 86 (11): 3353–63.
- Tzempelikos, Athanasios. 2017. "Advances on Daylighting and Visual Comfort Research." *Building and Environment* 100 (113): 1–4.
- "U.S. National Grid, Managing Energy Costs in Colleges and Universities - Google Search." Accessed March 28, 2022.
- Wang, Jialiang, Liliana O. Beltrán, and Jonghoon Kim. 2012. "From Static to Kinetic: A Review of Acclimated Kinetic Building Envelopes." In *Proceedings of the Solar Conference*, 5:4022–2029.
- Wienold, Jan, and Jens Christoffersen. 2006. "Evaluation Methods and Development of a New Glare Prediction Model for Daylight Environments with the Use of CCD Cameras." *Energy and Buildings* 38 (7): 743–57.
- Zomorodian, Zahra S., and Mohammad Tahsildoost. 2019. "Assessing the Effectiveness of Dynamic Metrics in Predicting Daylight Availability and Visual Comfort in Classrooms." *Renewable Energy* 134: 669–80.

Beyond Patterning: Embedding Shading in Opaque Building Envelopes

Luis Santos¹, Nick Safley²

¹Department of Architecture, Design and Media Technology, Aalborg University, Aalborg, Denmark

²College of Architecture and Environmental Design, Kent State University, Kent, OH

ABSTRACT: This research explores the passive solar self-shading of building opaque surfaces through small-scale patterning embedded in material units. The investigation focused on concrete masonry unit (CMU) blocks as they are moldable into various patterns and commonly used as uninsulated construction material for exterior walls. With CMU as the medium for the study, the authors developed surface patterning systems to externally shade the opaque wall surfaces that might require compound shading due to their solar exposure. The hypothesis is that self-shading buildings' exposed thermal mass by embedding shading patterns is an opportunity to shave cooling building loads and provide a performative purpose that goes beyond ornamental architectural patterning. However, current building energy simulation workflows have limitations in modeling small-scale shading, particularly those embedded within a material unit. To address this limitation, this work proposes and validates a novel co-simulation method that allows for the testing and refining of passive shading patterns. Using the proposed approach, it was possible to devise a feedback loop of material testing and simulation to assess and optimize the energy performance benefits of embedding shading patterns in an exposed CMU building surface. First, the research examined the potential of optimally shade exposed thermal mass in a south-facing building using an overhang in warm to hot climates. Then, the authors used the proposed co-simulation method to design and assess different CMU groove patterns' ability to reduce building cooling loads. The results show that optimally shade exposed thermal mass can reduce cooling loads by 29% in hot climates, while carving small-scale shading in CMU can reduce cooling loads by 15%.

KEYWORDS: Building Performance, Passive Cooling, Shading Opaque Building Surfaces, Embedded and Self-Shading, Façade Patterning.

INTRODUCTION

Currently, most buildings still consume considerable amounts of energy to provide a thermally comfortable environment. Energy-intensive building operation results in carbon emissions that contribute to climate change. This reality pushes architects to deploy passive energy conservation measures in their designs. Shading and thermal mass are effective passive design strategies in hot and dry climates. Although recent studies show that shading the opaque portion of building envelopes helps reduce cooling loads and mitigates the urban heat island effect (Valladares-Rendón and Lo 2014; Liu et al. 2019), there is little research on the subject, particularly in the case of embedding passive self-shading in building components with thermal mass properties. In fact, the design, simulation, and optimization of embedded shades in opaque building surfaces to reduce cooling loads are often neglected, primarily because of the lack of simulation performance-driven workflows and clear modeling guidelines. As a result, the design of stereotomy relief patterns in opaque building surfaces is mostly driven by compositional and aesthetical purposes.

This paper examines new ways to model, simulate, and optimize embedded shading systems in opaque portions of exposed construction elements to reduce building cooling loads in hot and dry climates. To that end, we focused on concrete masonry unit (CMU) blocks due to their widespread use in construction, structural versatility, thermal mass properties, and simple fabrication process.

1.0 RELATED WORK

Passive shading is a heat rejection design strategy that is highly effective in both reducing cooling loads and improving thermal comfort in buildings, particularly in humid and dry hot climates. There is a consistent body of work on designing and optimizing shading devices to minimize cooling loads. More recent work includes the investigation of Huo et al. (2021) that optimized external venetian blind systems for different Chinese climate zones and for different orientations. The authors observed significant cooling load reductions that could reach 65% and developed a new index to describe the energy efficiency of external shading. Kirimtat et al. (2019) optimized the design of parametric exterior shades for windows for both daylight and building energy performance. The optimized shades reduced 14% of building energy consumption while keeping an annual daylight availability above 50% for a Mediterranean climate. Khoroshiltseva et al. (2016) studied the energy impact of external shading devices in energy retrofit in Madrid, Spain. They estimated that external shading could reject 17% of solar heat gains, thus helping reduce cooling loads.

Thermal mass is another passive design strategy that is highly effective in dampening the daily swing of temperature in hot and dry climates, thus favoring a steadier cool indoor environment in hot and dry climates. Several studies showed the effectiveness of thermal mass. Thiele et al. (2015) demonstrated that increasing the thermal mass in exterior walls could reduce annual cooling loads from 53% to 100% depending on the location and building orientation in California, USA. Reilly and Kinnane (2017) discuss the benefits of thermal mass in reducing interior temperatures in hot and dry climates. Carlos (2017) simulation study demonstrated that thermal mass could reduce annual overall thermal loads by 12% to 33% in different locations in Portugal. Lin et al. (2018) conducted an optimization study of thermal mass with similar results for a building located in Wuhan, China, a humid subtropical climate. Kuczyński and Staszczuk (2020) showed that replacing lightweight frame walls with cellular concrete shortened the total time when the indoor temperature is above 28 °C from approximately 19 days to only 8 hours, which can lead to cooling loads reductions of 67% in a warm temperate climate.

Combining passive shading of windows with thermal mass in hot and dry climates can yield the advantages of both strategies, i.e., reject heat and, by directly shading thermal mass, enhance its heat sink capacity. Baglivo et al. (2017) showcased the benefits of shading interior thermal mass in the cooling season in terms of reducing operative temperature and cooling loads in a warm climate. Al-Saadi and Jabri (2020) combined and optimized different passive strategies, including the shading of windows and thermal mass in a hot and moderate climate. The optimization study reduced overall building energy consumption by approximately 17% and 30%, respectively. Sarri et al. (2021) studied the impact of shading phase change materials (PCM) and reported similar results.

Despite interesting results, most of the investigation on combining passive shading with thermal mass in buildings focuses on shading the transparent portion of the building envelope and consequently the interior thermal mass. Only a few studies looked at the potential energy benefits of shading the opaque part of the building envelope. Valladares-Rendón and Lo (2014) studied the energy impact of shading both the opaque and transparent surface of building façades in a hot and humid climate. The study shows that shading the entire envelope mitigates the urban heat island effect and can reduce cooling loads by approximately 9%. Liu et al. (2019) conducted a similar investigation but only focused on shading the opaque portion of building façades. The authors observed that shading the opaque part of building façades in a subtropical climate could reduce cooling load by up to 5.6 %.

The investigations presented in (Valladares-Rendón and Lo 2014; Liu et al. 2019) are limited to the use of detached shading elements that shade opaque building surfaces. In fact, there is little work in assessing the energy impact of embedded shading patterns in exposed opaque building elements with thermal mass, such as standard grooving patterns in CMU blocks. Limitations on modeling and simulating the shading effect of embedded micro-shading devices in building energy simulation (BES) tools hinder such investigation endeavors. In fact, despite the recent incorporation of sophisticated shading algorithms in state-of-the-art BES tools (Jones, Greenberg, and Pratt 2012), such simulation tools still have some limitations that make modeling small carved shading patterns in continuous surfaces challenging. For example, EnergyPlus (Crawley et al. 2001) limits the size of elements preventing, thus, modeling the geometry of standard grooving patterns of CMU blocks. However, state-of-the-art BES tools such as EnergyPlus can abstract shading geometry through bidirectional scattering distribution functions (BSDF) and pre-calculated sunlit fraction schedules. The former only applies to fenestrations, while the latter, despite being simpler, to any surface. This work will explore such geometry abstraction capabilities to address the limitations of modeling embedded shading for energy-performance building design workflows.

2.0 RESEARCH GOALS

Considering the limited research on assessing the impact of shading opaque building surfaces and the current BES constraints in modeling small-sized and embed self-shading, the study presented in this paper aims to:

1. Develop a method to model and accurately simulate embedded shading in the opaque portion of building envelopes.
2. Use the proposed method to:
 - a. Assess the potential of self-shading non-transparent building surfaces in reducing cooling loads in hot and dry climates.
 - b. Design effective embedded shading patterns in simple exposed building elements such as CMU to reduce building cooling loads.

3.0 METHODOLOGY

To achieve the research goals, the methodology adopted in this investigation had three phases. Phase I consisted of developing and implementing the modeling approach of embedded shading for BES. Phase II validated the modeling approach and tested the hypothesis that shading the opaque surfaces of building envelopes, particularly of surfaces composed of uninsulated thermal mass, contributes to reducing cooling loads in buildings. Finally, in Phase III, we applied the proposed modeling approach to design energy-saving embedded shading patterns in concrete masonry units (CMU).

3.1. Phase I: a building energy modelling approach for embedded shading

The authors developed a co-simulation building energy model (BEM) method for small-sized embedded shading pattern in opaque surfaces. Given an initial BEM and a set of tridimensional shading patterns samples, the proposed modeling approach allows designers to embed shading patterns in different surfaces that compose the building envelope. The co-simulation method is a procedural modeling approach with the following steps:

1. Given an initial BEM, the approach pre-calculates an annual sunlit fraction schedule for the different building envelope surfaces. An annual sunlit fraction schedule describes the percentage of area that a building surface is exposed to beam solar radiation in each hour of the year. Although EnergyPlus can compute sunlit daylight fraction schedules, the proposed approach uses Radiance (Ward 1994). We chose Radiance rather than EnergyPlus because:
 - a. Radiance handles a broader range of tridimensional geometric descriptions than EnergyPlus. Thus, it will be essential to calculate the small-size embedded shading patterns simulated in later steps (see steps 3 and 4).
 - b. Keep the consistency between the sunlit fraction schedules being used by the approach. Although the sunlit fraction schedules generated by both tools are similar, Radiance is more precise in lighting-based calculations.

The approach samples the building surfaces with a sensor node at their centroid to compute the sunlit fraction schedules. The sensor is representative of the entire surface area. For each hour of the year, the simulation reports whether the sensor node is solar exposed. The system stores the annual data in a comma-separated value (csv) file.

2. Given a three-dimensional carved-out shading pattern sample model(s), our method uses a ray-casting process to map a fine grid of sensors on the sample(s) (see Figure 1). Each sensor is representative of the area allocated to it.

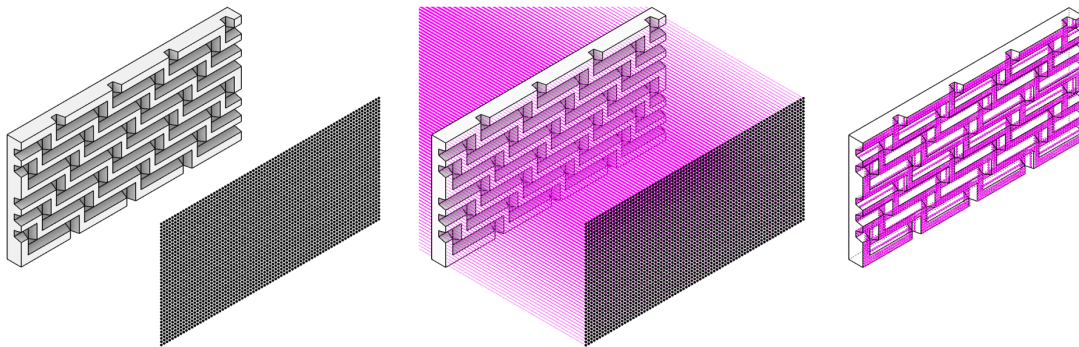

Figure 1: The ray casting process for sampling a 3D object with carved shading. Left: generator of a fine grid of samples parallel to the object. Center: for each sample a ray is traced. Right: a sensor is placed at the first intersection point of the ray and the 3D object. Source: Santos and Safley.

3. The system applies the shading patterns to the desired building surfaces. The three-dimensional shading patterns and the corresponding sensor grids are automatically reoriented to match the solar exposure of their parent building surface. Then, the system uses Radiance again to calculate the new sunlit fraction schedules for the surfaces with a shading pattern. Hence, for each hour of the analysis period, the system calculates the number of sensors exposed to the direct sun. The hourly sunlit fraction results from dividing the number of sunlit sensors in each hour by the total number of sensors. Then the proposed approach updates the sunlit fraction schedule csv file pre-computed in step 1 with the new sunlit fractions.

4. Finally, the system can run a final energy simulation with EnergyPlus that imports the updated sunlit fraction schedule csv file. Note that if the embedded shading results from carving out a building surface, the system automatically corrects the thickness of such building surface to account for the removed material.

It is possible to use the proposed system to simulate any macroscopic shading system. Designers can also use the system only to generate sunlit fraction schedules. To that end, users could skip steps 1 and 4. We implemented the system in the Rhinoceros computer-aided design ecosystem using python, grasshopper, ladybug, and honeybee, a popular front end to EnergyPlus and Radiance.

3.2. Phase II: validation of the main investigation premise and modeling approach

In this phase we first examined whether shading opaque building surfaces is a useful passive cooling strategy in warm to hot climates. This included the assessment of shading the south façade of a south facing single thermal zone model in the following locations: (1) Phoenix, AZ, ASHRAE climate zone 2B (hot and dry), (2) Oakland, CA, ASHRAE climate zone 3C (warm and marine), (3) Miami, FL, ASHRAE climate zone 1A (very hot and humid), and (4) Houston, TX, ASHRAE climate zone 2A (hot and humid). For each location, we considered two scenarios, the baseline scenario, which is unshaded, and the shaded scenario, which includes an optimized south-facing overhang for each location that blocks most of the direct solar beam. Finally, we compared the energy consumption of both scenarios.

Second, we validated the modeling approach by assessing the deviation between our shading modeling approach and a standard workflow of computing sunlit fractions in BES. The research compared the impact of estimating annual cooling loads using sunlit fractions calculated by our modeling method against the ones natively computed by EnergyPlus. To that end, we performed a paired t-test that examined whether there is a significant change between the sunlit fraction schedules generated by our approach and those natively generated by EnergyPlus for the same BEM. Finally, we performed the second validation task using the BEM of the shaded model scenario in Phoenix of the first validation task, a geometry that EnergyPlus can easily handle.

Figure 2 presents the geometry BEM of the single thermal zone used. As this work focuses on studying the energy impact of shading opaque surfaces in warm to hot climates, there is no window in the main exposed façade (south). Nevertheless, a small fenestration (window-to-wall ratio of 10%) was assigned to the opposing façade since it is unlikely that a thermal zone cannot access daylight and view. This modeling assumption aims to reduce the effect of solar heat gains through the transparent portion of the building envelope in investigating the potential energy benefits of shading opaque surfaces. Table 1 describes the u-values and the thermal boundary conditions of the different surfaces that compose the thermal zone envelope. This work considered the default construction assemblies recommended by ASHRAE for mass buildings for each climate zone, except for the south façade (or the building surface to shade). The building surface to shade is a simple wall of uninsulated CMU for the following reasons: (i) insulation has a lesser role in building energy conservation in warm to hot climates than in temperate and cold ones, (ii) to facilitate the study of the cooling effect of shading thermal mass in buildings in hot climates, (iii) to prepare the study of an energy efficient shading pattern for CMU conducted in phase III. Not adding an insulation layer allows to observe in more detail the impact of shading building surfaces with thermal mass on overall building energy performance. Table 2 presents the optimal overhang depth per location considered in this validation step.

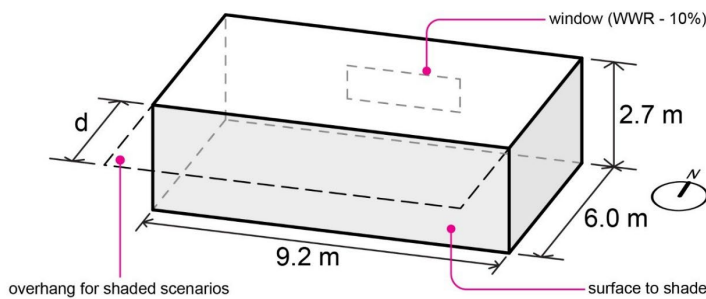

Figure 2: Thermal zone geometry. Note that the optional overhang is marked with a dashline. Source: Santos and Safley.

Table 1: Boundary conditions and u-values of the different surfaces of the thermal zone.

Surface	Boundary condition	U-value [W/m ² K]		
		Phoenix (AZ), Houston (TX)	Oakland (CA)	Miami (FL)
North wall	Outside	0.76	0.6	1.63
East wall	Adiabatic	N.A.	N.A.	N.A.
South wall (or surface to shade)	Outside	2.24	2.24	2.24
West wall	Adiabatic	N.A.	N.A.	N.A.
Roof	Outdoor	0.21	0.21	0.26
Floor	Ground	2.01	2.01	2.01

Table 2: Optimal south overhang depth per location used in the first validation task.

Location	ASHRAE Climate zone	South Overhang Depth (d)
Phoenix (AZ)	2B: hot and dry	1.85 m
Oakland (CA)	3C: warm and marine	2.20 m
Miami (FL)	1A: very hot and humid	1.35 m
Houston (TX)	2A: warm and humid	1.6 m

3.3. Phase III: application of the proposed method in the design of a concrete masonry unit

In this phase, we applied the proposed modeling approach to the design and energy assessment of subtractive carving shades into CMU blocks. We developed a parametric model to generate different patterns based on a grid of horizontal and vertical grooves. This orthogonal grid defines potential carving paths and allows the generation of different shading patterns for different solar exposures. For example, it is expected that horizontal groove-dominated patterns perform better for south orientation while vertical-based groove patterns for the west or east orientations. The authors decided

to generate the widest and deepest carving possible to maximize the potential for shaded area. To determine such width and depth, the authors fabricated different prototypes. Those experiments determined a groove width of 15.8 mm and a depth of 10 mm. Figure 3 shows the prototypes and the final generative grid of vertical and horizontal grooves.

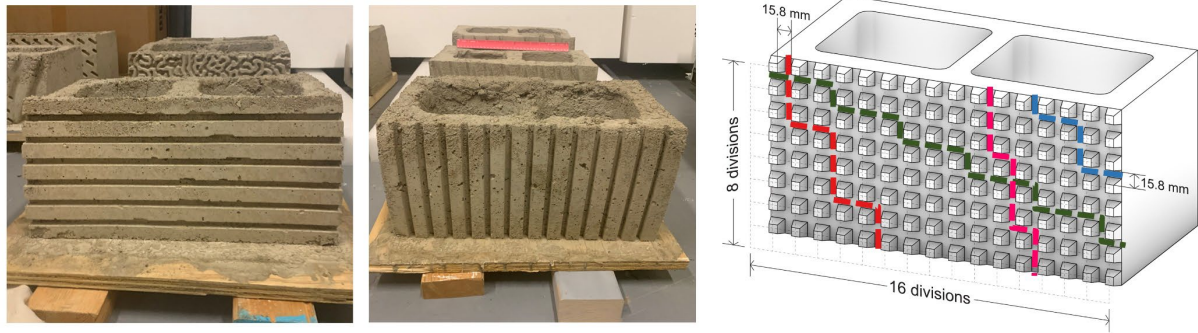

Figure 3: Groove spacing was determined by material capacity via physical testing to failure during molding (left). On the right, the resulting groove generator grid with some possible carving paths highlighted in colored dashed lines. Source: Santos and Safley.

As the proportion of the width and depth of the carvings might not result in optimal vertical and horizontal shading angles for south and west/east orientations, we constrained the parametric model to generate grooves in a stepped configuration. The assumption is that the existence of both horizontal and vertical elements could compensate for the nonoptimal shading effect. Additionally, the stepping configuration allows tackling solar orientations other than perfect south, east, or west. After an initial exploration, we selected five groove patterns from this system to be further investigated (see Figure 4).

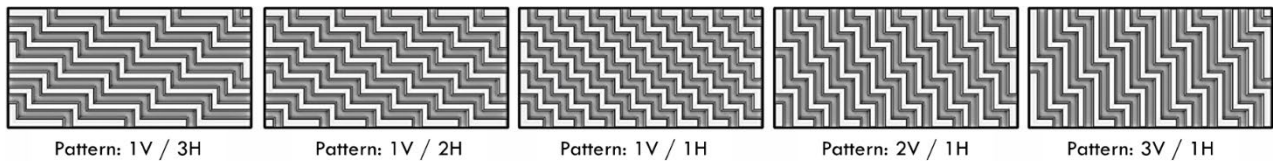

Figure 4: The selected studied carved shading patterns for CMU blocks. Source: Santos and Safley.

Then we used the proposed approach to study the energy performance of all selected patterns for different orientations in the southwest quadrant, starting from south to west in incremental steps of 15° in Phoenix, AZ. Phoenix was the selected location as it reported the largest absolute reduction of cooling loads (although not the largest relative reduction) in phase II. The BEM was the same used in Phase II but without the overhang. First, we used our modeling method to determine the best shading pattern for each orientation. Since the study only examined five solutions, we used a brute force method to find the best-performing one. Hence, for each orientation, the goal was to maximize the objective function expressed in equation (1). Equation (1) measures, for the same building surface, the relative difference between a year's cumulative sunlit fraction area of a non-shaded and a shaded condition. In summary, it calculates the annual cumulative shaded area increase caused by a given shading pattern.

$$f(t) = \frac{\sum_{t=1}^t \% \text{ Sunlit area of unshaded surface}(t) - \sum_{t=1}^t \% \text{ Sunlit area with shading pattern}(t)}{\sum_{t=1}^t \% \text{ Sunlit area unshading pattern}(t)} \times 100\% \quad (1)$$

After finding the best performing pattern for each orientation, we compared the annual cooling load of applying the shading pattern against the annual cooling load of an unshaded solution (i.e., the baseline case).

4.0 FINDINGS

The following sections present and discuss the results of phases II and III.

4.1 Phase II

Figure 5 presents the results of the first task of Phase II. It assesses the impact on building energy performance by optimally shading a south-facing opaque façade composed of CMU units.

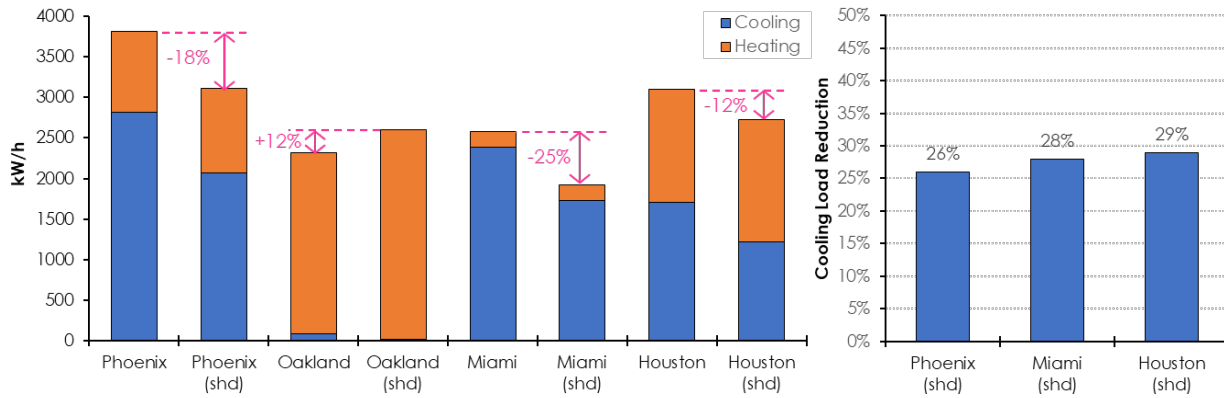

Figure 5: The impact in heating and cooling loads by optimally shading the south thermal zone model, described in section 3.2.

The graph on the left shows that shading the CMU wall reduces building energy consumption in all locations except for Oakland, CA. Although optimally shading the south-facing CMU wall reduces the cooling loads in Oakland, such reduction comes at the expense of increasing heating loads. Despite its warm climate, Oakland is dominated by heating loads due to its cool nights and mild cooling seasons. Since optimally shading the thermal zone in Oakland did not result in overall building energy savings, we excluded that location from the graph on the right. The bar chart on the right reports the relative reduction of cooling loads. It shows a cooling loading shaving that ranges from 26% to 29% in our thermal zone. Such results support that shading opaque building surfaces can be an interesting passive cooling strategy in hot climates.

In the second validation task, we assess the proposed method's ability to model and simulate small-size embedded shading for BES workflows. The paired t-test conducted in this task evaluated whether there was no significant change in using our approach to pre-calculate the sunlit fraction schedules – the null hypothesis. The data set included a sunlit fraction produced by EnergyPlus and another generated by the proposed approach for the shaded scenario in Phoenix. The test confirmed the null hypothesis as the *p-value* (≈ 0.06) was above 0.05, the validity threshold. This means there is no significant change in using our approach to compute sunlit fraction schedules compared to using EnergyPlus. After the paired t-test validation, we measured the deviation in simulation output using our modeling approach against a typical BEM workflow. The deviation in annual thermal loads was negligible, *relative error* < 2%, which attests to the robustness and accuracy of the proposed co-simulation method.

4.3 Phase III

Figure 6 shows, on the right, the shading performance of the five selected shade patterns (Figure 4) for different orientations in the southwest quadrant. Equation (1) expresses the shading performance by measuring the relative increase of cumulative shaded area for an entire year compared to an unshaded scenario.

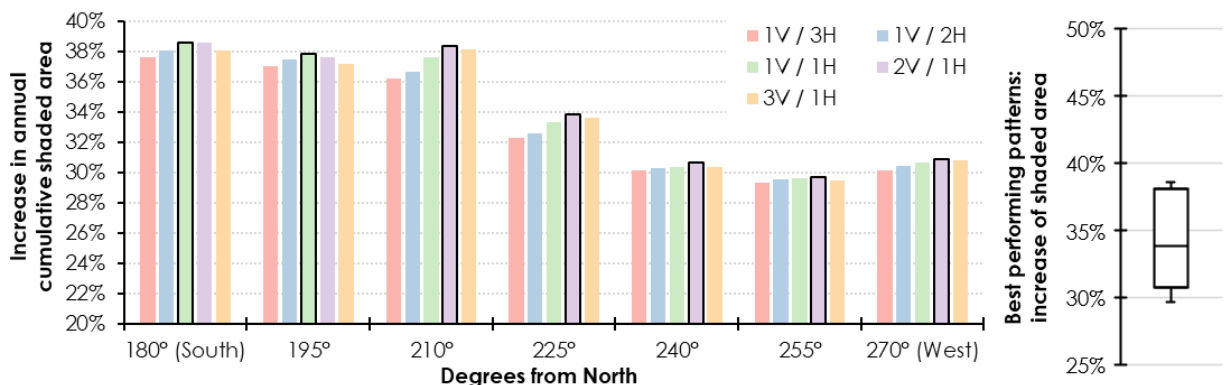

Figure 6: Finding the best shading pattern for each orientation. Left: comparison of all the examined patterns for each orientation. The best shading patterns are outlined. Right: box plot of the increase of the cumulative shaded area of the best shading patterns.

The pattern 1V/1H performed best for the south orientation (180°) and orientation 195°, while 2V/1H presented the best results for all the other orientations. The figure also shows that the largest variations in performance are for 210° and 225° (southwest) orientations. From orientations $\geq 210^\circ$, vertical groove prevalence becomes more relevant. For the south orientation, a balance between horizontal and vertical grooves outperforms patterns dominated by horizontal

reliefs. The constraints imposed by the fabrication process made the typical vertical shading angle used for south solar exposures suboptimal for Phoenix, thus making horizontal-dominated patterns less effective for the south.

Figure 6 box plot presents the distribution of shading improvement of the best-performing patterns. The selected solutions increase the cumulative shaded area in a year by 33% on average. The box plot shows a compact performance distribution. However, both graphs indicate that the shading patterns are less effective in handling low sun angles, as their performance drops between the southwest and west. Figure 7 supports this by showing that the best pattern for the south is more effective in reducing solar exposure than the one for the west.

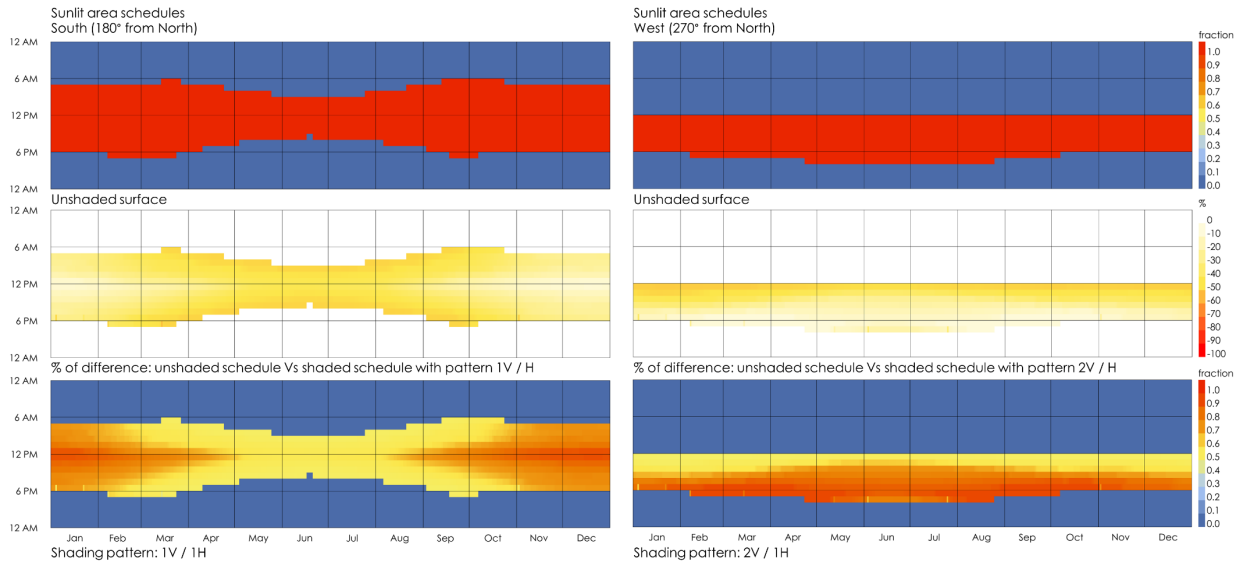

Figure 7: Comparison of hourly sunlit area fraction between an unshaded surface and the best shading patterns for south and west.

Figure 8 measures the reduction in cooling load reduction for the best-performing shading pattern in each orientation. For orientations 180° (south) to 210°, the reduction in cooling loads is relatively stable (15% to 14%). However, the proposed carved shades are less effective in shaving cooling loads from orientations 225° (southwest) to 270° (west), which aligns with the findings illustrated in Figures 6 and 7. These findings indicate that the parametric model used to generate grooving patterns might be limited in generating solutions that effectively tackle low sun angles. Nevertheless, reducing cooling loads by 10% to 15% through adequately design carved patterns is an interesting result.

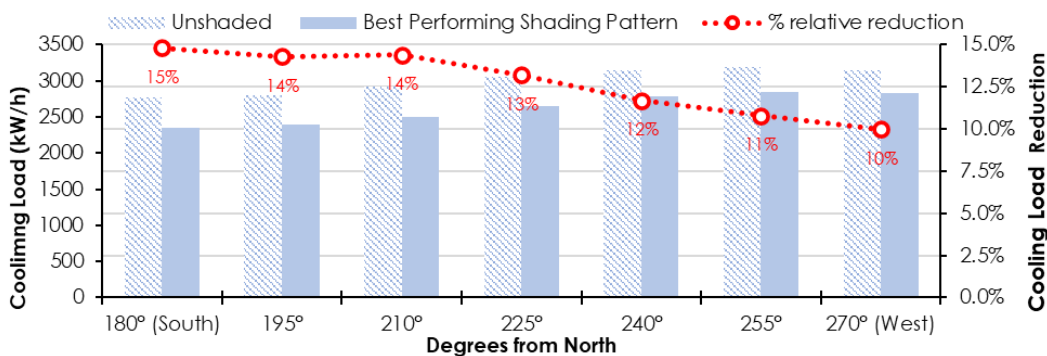

Figure 8: Assessing the impact of the best performing shading patterns in annual cooling loads.

CONCLUSION

This work investigated the energy benefits of carving shading into exposed CMU elements. To that end, the paper advances a novel co-simulation method to overcome the limitations of current building energy simulation tools in modeling small-sized embedded shades. The results of the experiments that tested the proposed modeling approach verified its validity, accuracy, and robustness. The first experiment examined whether optimally shading exposed thermal mass surfaces composed of CMU material units can effectively contribute to building energy conservation. The results showed that shading exposed thermal mass in buildings can be an effective passive cooling strategy in hot climates. However, it could increase building energy consumption in more moderate warm climates. The second

experiment showed that by optimizing embedded shading in exposed CMU can reduce 10% to 15% of the cooling loads in a hot and dry climate.

Considering that it is impossible to shade the entire area using carved shades, such results indicate that adequately designing the groove patterns in such basic building elements can contribute to energy conservation in buildings. Thus, this work shows that there is potential to drive the design pattern of grooves in CMU blocks using performance-based criteria.

Since this work only focused on the shading of exposed thermal mass surfaces, future work will investigate the potential of combining the shading effect of carving shades in well-insulated building envelopes. Additionally, the research will examine the impact of such self-shading strategies on building surfaces composed of opaque and transparent elements. Finally, we plan to support the simulation-driven results with physical experiments.

REFERENCES

- Al-Saadi, Saleh N., and Khalifa S. Al-Jabri. 2020. "Optimization of Envelope Design for Housing in Hot Climates Using a Genetic Algorithm (GA) Computational Approach." *Journal of Building Engineering* 32: 101712.
- Baglivo, Cristina, Paolo Maria Congedo, Matteo Di Cataldo, Luigi Damiano Coluccia, and Delia D'Agostino. 2017. "Envelope Design Optimization by Thermal Modelling of a Building in a Warm Climate." *Energies* 10 (11): 1808.
- Carlos, Jorge S. 2017. "The Impact of Thermal Mass on Cold and Hot Climate Zones of Portugal." *Indoor and Built Environment* 26 (6): 733–43.
- Crawley, Drury B., Linda K. Lawrie, Frederick C. Winkelmann, Walter F. Buhl, Y. Joe Huang, Curtis O. Pedersen, Richard K. Strand, et al. 2001. "EnergyPlus: Creating a New-Generation Building Energy Simulation Program." *Energy and Buildings* 33 (4): 319–31.
- Huo, Huimin, Wei Xu, Angui Li, Yanjie Lv, and Changping Liu. 2021. "Analysis and Optimization of External Venetian Blind Shading for Nearly Zero-Energy Buildings in Different Climate Regions of China." *Solar Energy* 223 (July): 54–71.
- Jones, Nathaniel L., Donald P. Greenberg, and Kevin B. Pratt. 2012. "Fast Computer Graphics Techniques for Calculating Direct Solar Radiation on Complex Building Surfaces." *Journal of Building Performance Simulation* 5 (5): 300–312.
- Khoroshiltseva, Marina, Debora Slanzi, and Irene Poli. 2016. "A Pareto-Based Multi-Objective Optimization Algorithm to Design Energy-Efficient Shading Devices." *Applied Energy* 184 (December): 1400–1410.
- Kirimtat, Ayca, Ondrej Krejcar, Berk Ekici, and M. Fatih Tasgetiren. 2019. "Multi-Objective Energy and Daylight Optimization of Amorphous Shading Devices in Buildings." *Solar Energy* 185 (June): 100–111.
- Kuczyński, T., and A. Staszczuk. 2020. "Experimental Study of the Influence of Thermal Mass on Thermal Comfort and Cooling Energy Demand in Residential Buildings." *Energy* 195 (March): 116984.
- Lin, Yaolin, Shiquan Zhou, Wei Yang, and Chun-Qing Li. 2018. "Design Optimization Considering Variable Thermal Mass, Insulation, Absorptance of Solar Radiation, and Glazing Ratio Using a Prediction Model and Genetic Algorithm." *Sustainability* 10 (2): 336.
- Liu, Sheng, Yu Ting Kwok, Kevin Ka-Lun Lau, Pak Wai Chan, and Edward Ng. 2019. "Investigating the Energy Saving Potential of Applying Shading Panels on Opaque Façades: A Case Study for Residential Buildings in Hong Kong." *Energy and Buildings* 193 (June): 78–91.
- Reilly, Aidan, and Oliver Kinnane. 2017. "The Impact of Thermal Mass on Building Energy Consumption." *Applied Energy* 198 (July): 108–21.
- Sarri, Abdelkader, Djamel Bechki, Hamza Bouguettaia, Saleh Nasser Al-Saadi, Slimane Boughali, and Mohammed M. Farid. 2021. "Effect of Using PCMs and Shading Devices on the Thermal Performance of Buildings in Different Algerian Climates. A Simulation-Based Optimization." *Solar Energy* 217 (March): 375–89.
- Thiele, Alexander M., Astrid Jamet, Gaurav Sant, and Laurent Pilon. 2015. "Annual Energy Analysis of Concrete Containing Phase Change Materials for Building Envelopes." *Energy Conversion and Management* 103 (October): 374–86.
- Valladares-Rendón, L. G., and Shang-Lien Lo. 2014. "Passive Shading Strategies to Reduce Outdoor Insolation and Indoor Cooling Loads by Using Overhang Devices on a Building." In *Building Simulation*, 7:671–81. Springer.
- Ward, Gregory J. 1994. "The RADIANCE Lighting Simulation and Rendering System." In *Proceedings of the 21st Annual Conference on Computer Graphics and Interactive Techniques*, 459–72. ACM.

Blockchain-Enabled BIM For Unified Lifecycle Design-Construction Data Management.

Oluwatoyin O. Lawal¹, Nawari O. Nawari¹

¹ School of Architecture, University of Florida, Gainesville, FL,

ABSTRACT: Design information in construction projects is often fragmented throughout the project development phase, perhaps owing to its multiplicity of authorship. However, the adoption of Building Information Modelling (BIM) in the Architecture, Engineering and Construction and Operations (AECO) industry has been widespread albeit predominantly in the design stage, a bit more sparingly in the construction stage and almost non-existent in the building operation phase. Recent advancements in cloud computing for BIM have assisted in harmonizing this fragmented information at various stages of its evolution. The application of Blockchain Technology (BCT) in Architecture, Engineering and Construction has also presented new possibilities with BIM. This research explores the potential for integration of a blockchain-enabled BIM in building lifecycle management. This entails the holistic management of all data generated or associated with the design, construction and operation of any facility from project conception, through project life to project de-commissioning or reuse. The benefits and limitations of the proposed Unified BCT-BIM are discussed along with the future research work.

KEYWORDS: Blockchain technology, AECO, BIM, Facility Management, Unified Lifecycle Data Management

INTRODUCTION

Data management problems in the architecture, engineering, construction and operations (AECO) industry are complex (Jiao, et al., 2013). The quantum of data generated throughout the lifecycle of a project increases exponentially across different phases and contains varying levels of detail. The state of use of these data also varies and these data produce information which are interrelated throughout the building life. The diversity and intensity of information generated over a facility's lifecycle is a critical requirement for information integration. Therefore, breakdown structures or the organization of information, which has now become a vital tool in computerizing communication is feasible for integrating information across domains to enhance interoperability (Gebremichael, Lee, Lee, & Jung, 2022). This study is in furtherance to existing research which proposes a single data structure that is decentralized, using BCT. By utilizing the mathematical principles of asymmetric cryptography, BCT builds trust, which allows users to transact even if they do not know each other. (Leng, et al., 2020).

A unified platform is proposed for visualizing a tamper-proof network of building information in real time to improve auditability in operations and maintenance of facilities. This borrows from the concept of Big Data which refers to massive data sets having large, more varied and complex structure with the difficulties of storing, analyzing and visualizing for further processes or results. (Sagiroglu & Sinanc, 2013). The study proposes a '*Big-BIM data*' concept whereby a unified interactive platform where the relationship between all data components can be visually analyzed by integrating blockchain, BIM and FM from the project inception.

There is a lack of a holistic solution that addresses the entire BIM for Facility Management (FM) workflow (Patacas, Dawood, & Kassem, 2020) which can be solved using a Common Data Environment (CDE) to address key processes in information management and accommodate additional data sources if required. Earlier studies on blockchain technology have also proposed a Common Data Environment (CDE) for secure data storage of digital assets, interdisciplinary coordination, management and versioning of information containers (Sreckovic, et al., 2021) (Wang, Wu, Wang, & Shou, 2017) (Pishdad-Bozorgi, Yoon, & Dass, 2020).

The underlying technology used to create public ledgers is blockchain, using a distributed consensus algorithm to create a single sequence of blocks. (Durán, Yarlequé-Ruesta, Bellés-Muñoz, Jimenez-Viguer, & Muñoz-Tapia, 2020) Nawari & Ravindran (2018) suggested that the application of blockchain technology in BIM workflow creates a decentralized system with open governance and transparency and such systems provide secure execution of BIM data exchanges and validation through privacy and trust mechanisms (Nawari & Ravindran, 2019). Therefore, the ability of a BIM model to act as a distributed ledger, enhancing collaboration and information sharing coupled with its ability to store actual information of the building (Ye, Yin, Tang, & Jiang, 2018) and represent the evolutionary stages in the project lifecycle (Succar, 2009) (Jiao, et al., 2013) positions it as an effective distributed ledger for effective unified lifecycle management.

This research hypothesis is that a blockchain-BIM framework can provide an effective unified Lifecycle Data Management system. A unified platform is proposed for visualizing a tamper-proof network of building information in real time to improve auditability and traceability of operations and maintenance in simple and complex facilities. This borrows from the concept of Big Data which refers to massive data sets having large, more varied and complex structure with the difficulties of storing, analyzing and visualizing for further processes or results. (Sagiroglu & Sinanc, 2013).

The study proposes a 'Big-BIM data' concept whereby a unified interactive platform where the relationship between all data components can be visually analyzed by integrating blockchain, BIM and FM from the project inception. The aim of this study is to demonstrate the capacity and efficiency of a blockchain-enabled BIM model to create a unified lifecycle database from planning and design to construction and operation. Fig 1 shows an overlap of three related domains which influence this research namely; Building Information Modeling, Blockchain and Facility Management.

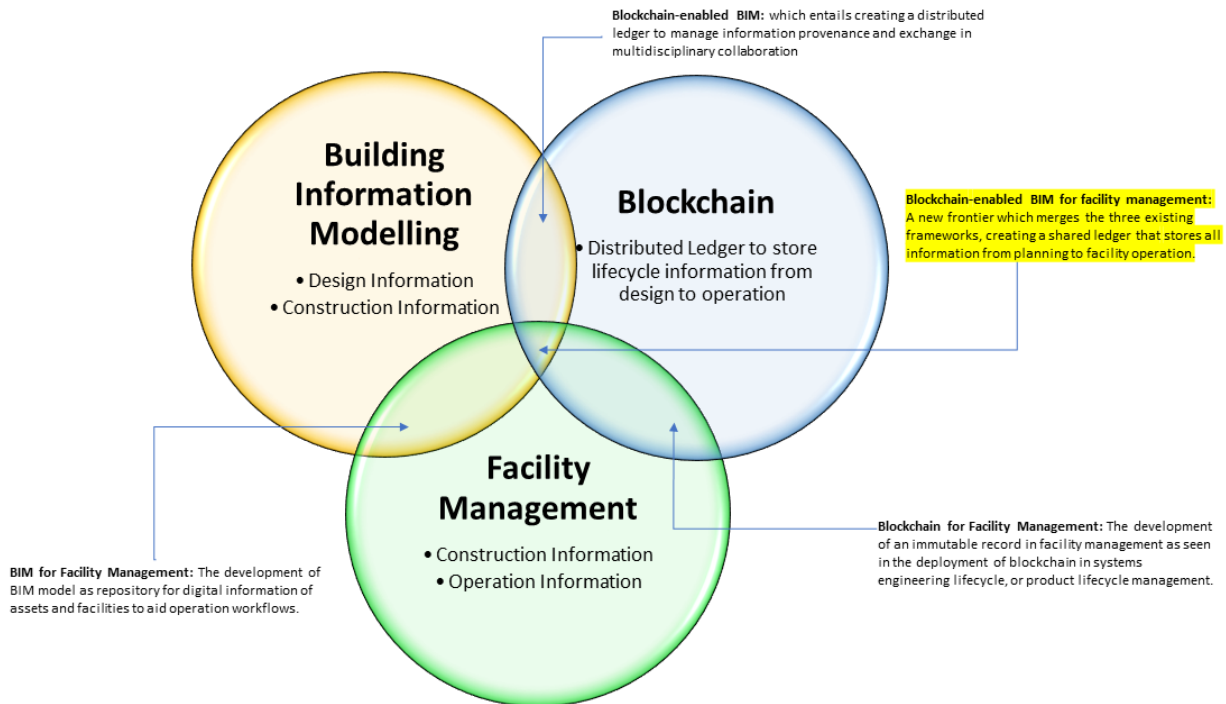

Figure 1: Research Framework Overlaps. Source: By Authors

1.0 LITERATURE REVIEW

1.1 Bibliometric Survey

The figures below show results of a bibliometric survey using cite space software to visualize results from a Web of Science database search. The search was conducted in two broad but similar categories; first was using keywords 'blockchain' and 'lifecycle management'. The second search is a more streamlined survey which was with keywords 'blockchain' and 'building lifecycle management'. Figure 2 shows a citation analysis based on keywords for blockchain and lifecycle management. The Web of Science search returned 114 results. Relevant publication search in cite space was limited to between 2009 when the concept of blockchain was first made known, till date. This shortlist showed 105 valid results and the major keywords associated with this study are shown below. Publications with keywords containing supply chain sustainability had the highest citations, followed by big data, while smart cities cluster is the only one of twelve clusters which was related to the AECO industry.

The keyword clusters are largely dominated by computer science and engineering fields. This is indicative to the fact that more could be done in lifecycle assessment studies using blockchain in the AECO industry when compared with similar studies in information technology and management. Figure 3 is a visualization of the keyword cluster for a more narrowed search using keywords; 'blockchain' and 'building lifecycle management'. The Web of Science search returned 34 results in total, with only 29 found to be valid within the timeframe of 2009 to 2022. Building Information Modeling and Smart cities were the most dominant keywords in blockchain and building lifecycle management research while big data and design science research were the least dominant keyword clusters.

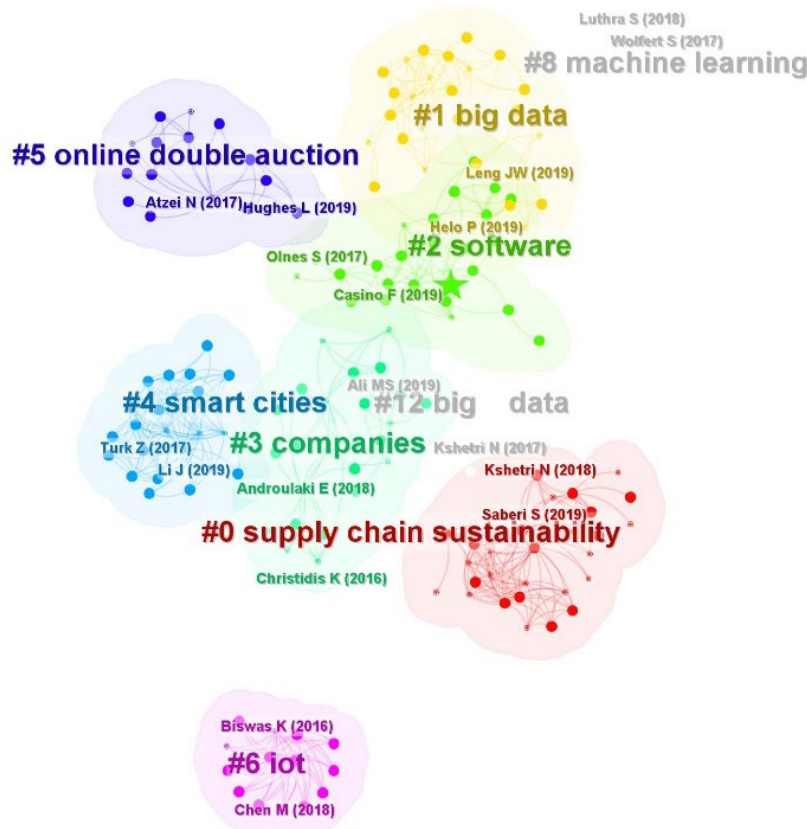

Figure 2: Keyword Search Visualization for Blockchain and Lifecycle Management. Source: (CiteSpace)



Figure 3: Keyword Search Visualization for Blockchain and Building Lifecycle Management. Source: (CiteSpace)

1.2. Related Work

Li et al (2021) proposed a semi-custom system of developing a BIM-enabled Building Lifecycle Management (BLM). Information silos, low data interoperability and poor cross-party coordination were emphasized as main challenges in a BIM-enabled BLM implementations, however, there is an existing knowledge gap in implementing BLM for property

owners in spite of efforts in academia and industry. (Li, et al., 2021). In the area of safety, safety information provided by facility owners can be input into the system via a data storage repository. This information is retrievable with an end-user interface and the fully developed system would provide facility management workers the ability to interact with a single graphic user interface (GUI) (Wetzel & Thabet, 2015).

BIM's suitability for this study is evident in its gradually increasing level of adoption amongst AECO firms globally. The AECO industry began actively adopting BIM in the early and mid-2000s (Jung & Lee, 2016). Countries like the United Kingdom and Singapore have implemented nearly a decade-old programs to help the adoption of BIM for construction projects (Jung & Lee, 2016). Asset owners have however found it difficult to effectively measure the benefits of adopting BIM. This has therefore led to the development of a benefit realization management BIM framework to monitor the value of BIM for asset owners (Love, Matthews, Simpson, Hill, & Olatunji, 2014). BIM is also highly useful for non-technical aspects of construction besides the development of technical information such as drawings and construction documents. Scientometric analysis to map managerial areas of BIM have revealed that new roles and relationships between stakeholders and project delivery systems emerge as the technical side of BIM evolves. (He, et al., 2017)

Kelly et al (2013) posited that BIM in FM applications is still considered an emerging field following discussions with industry experts which revealed challenges such as the significant difference in data lifespan of BIM technologies, FM technologies and the physical building asset (Kelly, Serginson, Lockley, Dawood, & Kasseem, 2013). More recently, BIM in Facilities Management (FM) has become more prevalent with increasing need for data interoperability and augmented knowledge sharing and management. BIM-FM integration is increasingly deployed in building operations and maintenance as it enhances augmented information handover, accuracy of FM data and efficiency of work order execution to effectively manage building maintenance (Parn, Edwards, & Sing, 2017).

With the increasing digitalization of the AECO sector, there are considerable gaps to be bridged to allow for wholesale integration of technologies such as BIM, Project Lifecycle Information Modelling (PLIM) to effectively manage the large natural resources consumed at operational phase of building lifecycle (Roberts, Parn, Edwards, & Aigbavboa, 2018). Adoption of permissioned blockchain shows great potential for engineering lifecycle management with further research to identify the role of the technology, especially in addressing issues of trust and security associated with big data (Joannou, Kalawsky, Martinez-Garcia, Fowler, & Fowler, 2020)

Outside the AECO domain, blockchain technology has also been used for drug lifecycle management especially since valid data is the blood for the product lifecycle management (Omidian & Yadollah, 2022). Other studies of blockchain in healthcare have explored how BCT can assist in environmental management of Covid-19 healthcare facilities and in emergency engineering management (Zhong, Gao, Ding, & Wang, 2023).

2.0 BIM-BLOCKCHAIN VALUE PROPOSITION FOR UNIFIED DESIGN TO CONSTRUCTION LIFECYCLE DATA MANAGEMENT

The comparative analysis below illustrates the existing challenges as a result of traditional data management in the building lifecycle. Table 1 below shows the various phases involved in the development of buildings starting from the pre-design project planning phase, through the design, construction and operation phase, to transfer of asset and finally to the end of life of building assets. For each phase, the associated issues leading to the lack of a unified data management and ways by which BIM-blockchain integration can proffer solutions to the issues.

Table 1: Comparative Analysis of existing issues

Phase	Existing Issues	Potential BIM-Blockchain Solution
Project Planning	<ul style="list-style-type: none"> • Disconnection between planning and pre-design information and eventual design and subsequent documentation • Disharmony between non-technical and non-verbal information and nuances and eventual design information. • Lack of transparency in selection of project team. 	<ul style="list-style-type: none"> • Use of a Common Data Environment as repository for all project information. • Paper-based information and model-based information are stored and accessible by all participants of the blockchain network.
Design	<ul style="list-style-type: none"> • Weak or non-existent change order management for design changes. • Poor record-keeping for design iterations for future reference. • Fragmented pre-design information due to information collection from various sources e.g clients, building codes, planning regulations. • Information silos due to poor data interoperability, causing different disciplines to develop designs in isolation. 	<ul style="list-style-type: none"> • Design information from different disciplines can be integrated in a unified platform
Construction	<ul style="list-style-type: none"> • Lack of transparent contract administration. 	<ul style="list-style-type: none"> • Track the provenance of materials and services.

	<ul style="list-style-type: none"> • Disruptive construction workflow due to weak project management, payment delays etc • Lack of transparency in construction supply chain. • Counterfeiting of products and installation. • Information asymmetry amongst stakeholders. • Adversarial behavior of project team members. 	<ul style="list-style-type: none"> • Use smart contracts to automate construction processes to eliminate human-centric disruptions. • Provide a transparent and tamper-proof supply chain management. • Eliminate the need for adversarial behaviors by decentralizing and distributing information. No single stakeholder has autonomy over the system.
Operation	<ul style="list-style-type: none"> • Facility management is disjointed from previous design and construction information. • Tamper-prone and error-prone maintenance records. • Manually operated maintenance scheduling. 	<ul style="list-style-type: none"> • Design and construction information remains intact in BIM model. • With the advent of digital twin, BIM model can be linked with physical building asset throughout facility life.
Transfer of Asset	<ul style="list-style-type: none"> • Over-reliance on third parties to oversee transaction. • Prevalent property fraud. 	<ul style="list-style-type: none"> • Peer-to-peer transaction of assets due to the distributed nature of asset information.

3.0 CONCEPTUAL FRAMEWORK

As BIM applications evolve in their capabilities, their level of adoption in AECO - which currently dwindles as the project transits from design to construction to operation - will inevitably increase. This is in furtherance to Parhiala et al (2014) who described BIM models as a Digital Mock-up (DMU), the Building Information Model is a source of all the project information linked through a shared database. (Parhiala, Yalcinkaya, & Singh, 2014).

The various stages of the project lifecycle from programming to conceptual design, to fabrication and construction through to renovation and demolition are enumerated in Figure 4. For each phase of the project lifecycle, the relevant stakeholders are identified and added to a secondary blockchain network which is administered by the client or an appointed consultant. For effective administration of the blockchain, such consultant should be one whose involvement is likely to span all or most of the project lifecycle.

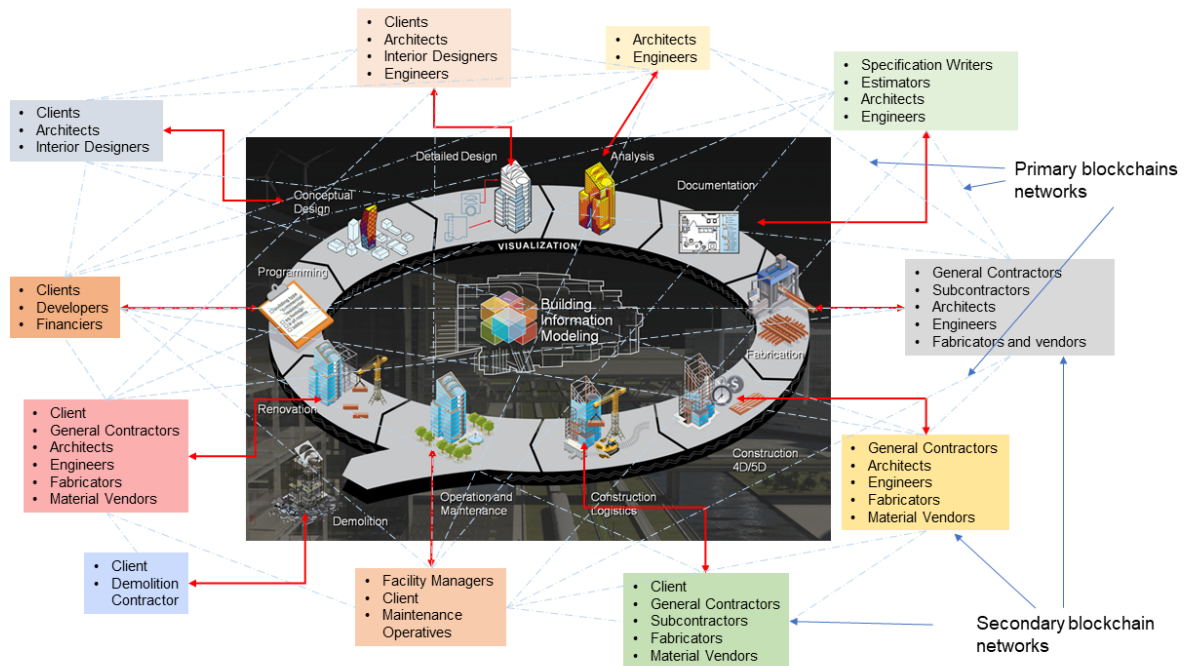

Figure 4: Concept Diagram for Stakeholder Interactions in the BIM-Lifecycle. Source: (Parhiala, Yalcinkaya, & Singh, 2014)

All participants share a BIM database which is connected to a distributed ledger to act as a Common Data Environment (CDE). The CDE contains paper-based and model-based information and all changes or transactions and it connects to a distributed ledger which is accessible to all members of the blockchain which is invariably all of the stakeholders in the building project throughout its lifecycle.

All secondary blockchains are interconnected to ensure the transparency of project information across the numerous project phases. This interconnection, combined with the interoperability of BIM data from various disciplines provides a closed information loop which allows all participants access to paper-based and model-based project information, regardless of the phase which such information was generated.

The blockchain integration at the secondary network level enables the data generated from transactions within the BIM model to act as big data as every design operation within the model is catalogued across all stages of project delivery. This may otherwise be known as Big BIM data. BCT makes these data immutable and traceable. Transactions within the model can be visualized through a distributed ledger known as a Unified Building Lifecycle Ledger with a workflow as shown in Figure 5 below wherein all changes within the model reflects on the ledger. This ledger is a constantly evolving repository of project information which allows all participants access to real time information.

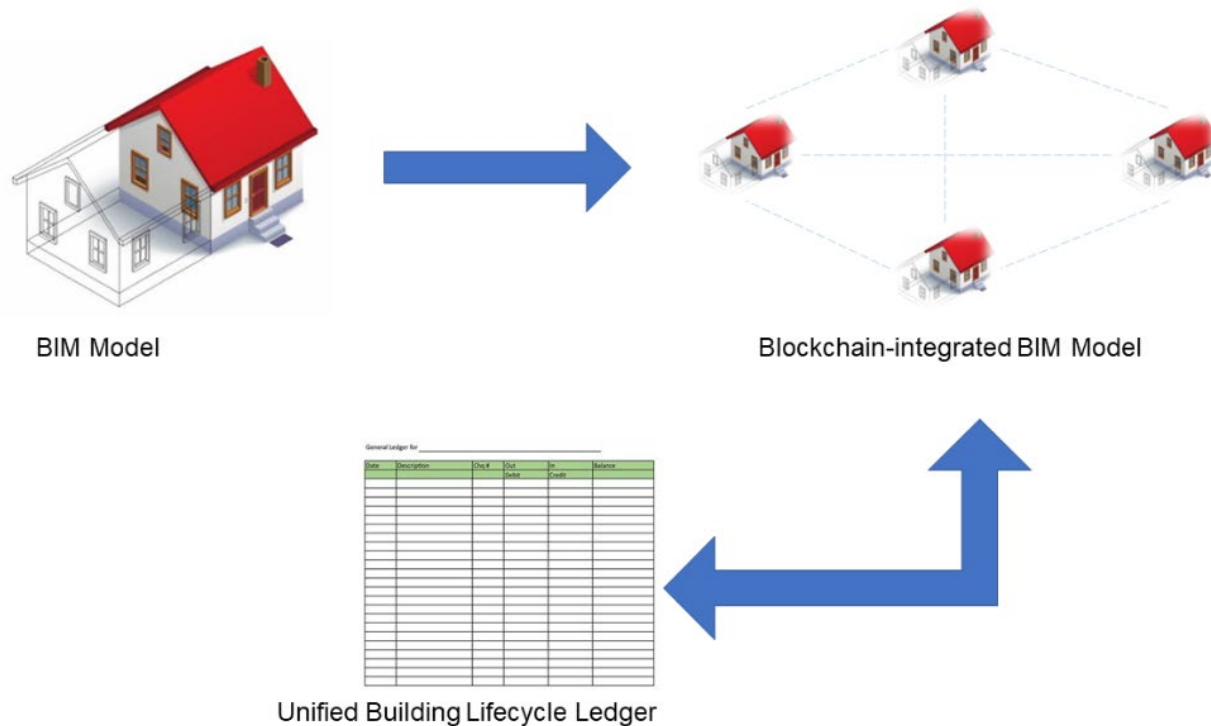

Figure 5: Schematic BIM-Blockchain Integration Workflow for Building Lifecycle Management. Source: By Authors

The CDE is fundamental to the functionality of this proposal. This is a virtual storage architecture which can be cloud-based, similar to BIM360. This CDE hosts the BIM model which is shared amongst all stakeholders throughout the project lifecycle. The first known commercial product which integrates BIM and blockchain as a plug-in is BIMchain (Kuperberg & Geipel, 2021) developed by Lucetium SAS in Paris, France. Pradeep, Amor & Yiu's (2020) analysis of BIMchain concluded that it improves data reliability, reduces liability, clarifies stakeholder responsibilities and shows evidence of how BCT can be leveraged in a BIM environment. However, it does not completely justify its claims of 'better quality of data' as this is a function of many other factors. (Pradeep, Amor, & Yiu, 2020).

The aim of Digital Built Britain, otherwise referred to as BIM Level 3, is to extend BIM beyond design and construction, into operation by promoting a life cycle approach for buildings through an integrated digital environment (Carbonari, Stravoravdis, & Gausden, 2018). The Allplan BIMplus cloud BIM platform offers a complete BIM solution that supports BIM Level 3 (Dmitrieva, Sheverova, & Golovantseva, 2022) as well as Pradeep et al's (2020) concerns mentioned earlier.

While BIMchain offers the platform for tamper-proof information management and exchange within the shared BIM model and within the design and construction phase, BIMplus ensures that all information exchanges within the BIM interface is immutable and retrievable beyond construction phase and throughout the project lifecycle. This study proposes a hybrid of these two unique paradigms to achieve a unified design-construction data management wherein all stakeholders are connected to one another and to every phase of the project delivery and operation. This cyclic relationship is enumerated in Figure 6 below.

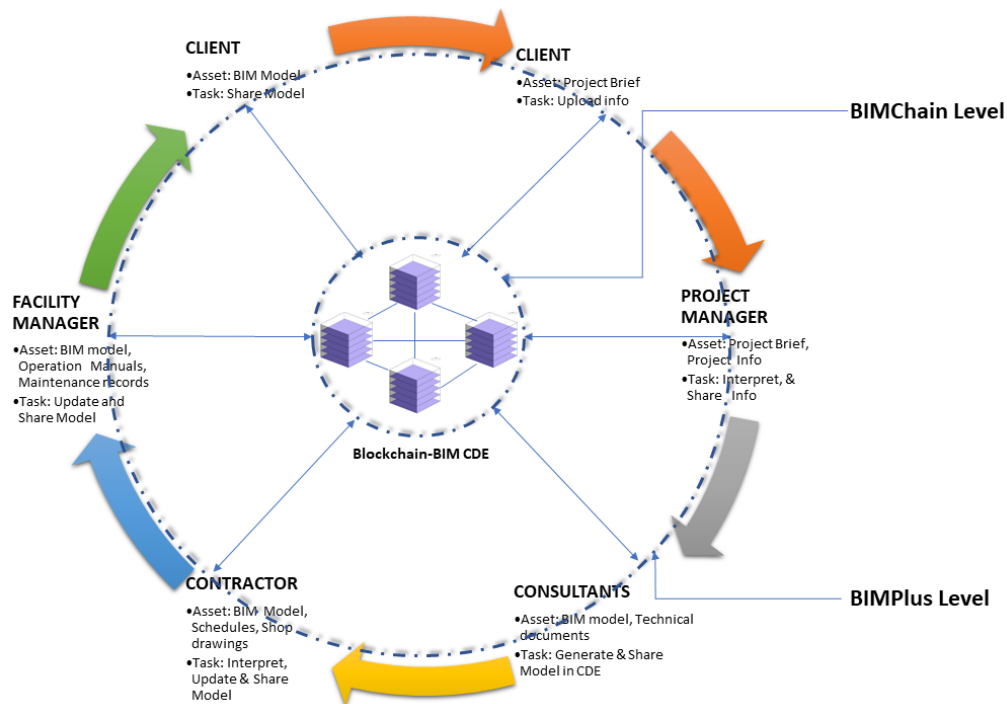

Figure 6: Schematic BIMchain – BIMplus Interaction for Building Lifecycle Management. Source: By Authors

CONCLUSION

The proposed model is conceptual in nature but provides the underlying foundation for developing a strategy for unifying building lifecycle data towards a more efficient facility operation. This paper began with a very terse bibliometric review to provide an overview to the timeliness of this study as not much research in blockchain and building lifecycle management has been done, especially in AECO industry. This was also evidenced in the review of related work. The analysis of the limitations of traditional data management and how blockchain technology may correct it provides context for the development of a conceptual framework.

This study builds upon established research on interactions between BIM and building lifecycle and demonstrates the potentials of having all building stakeholders connected throughout the life of the building through the integration of BIM for FM with blockchain. It also shows two distinct levels of blockchain connection. There is sufficient research on the secondary blockchain connection proposed in this study, however the cross-level blockchain interaction is the distinctive feature of this study. Further research is required to adequately structure the data into categories to ensure privacy of sensitive information. This is critical to ensure willful participation of stakeholders.

FUTURE POTENTIAL

BIM Model as a Distributed Ledger

The underlying technology used to create public ledgers is blockchain, using a distributed consensus algorithm to create a single sequence of blocks. (Durán, Yarlequé-Ruesta, Bellés-Muñoz, Jimenez-Viguer, & Muñoz-Tapia, 2020) Nawari & Ravindran (2019) suggested that the application of blockchain technology in BIM workflow creates a decentralized system with open governance and transparency and such systems provide secure execution of BIM data exchanges and validation through privacy and trust mechanisms (Nawari & Ravindran, 2019).

Lawal & Nawari, (2022) also proposed a blockchain-enabled traceability and provenance system which could either be paper-based, model-based or hybrid to ascertain traceability of data in construction lifecycle (Lawal & Nawari, 2022). Therefore, the ability of a BIM model to act as a transaction ledger, enhancing collaboration and information sharing coupled with its ability to store actual information of the building (Ye, Yin, Tang, & Jiang, 2018) and represent the evolutionary stages in the project lifecycle (Succar, 2009) (Jiao, et al., 2013) positions it as an effective distributed ledger for effective unified lifecycle management. This will contribute towards bridging a knowledge gap in the area of building operations and facility management.

REFERENCES

- Carbonari, G., Stravoravdis, S., & Gausden, C. (2018). *Improving FM task efficiency through BIM: a proposal for BIM implementation*. Journal of Corporate Real Estate, 20(1), 4-15.
- Dmitrieva, T. L., Sheverova, A. O., & Golovantseva, A. B. (2022). *Analysis of BIM software systems used in the Russian market*. AIP Conference Proceedings. 2434, p. 060001. AIP Publishing LLC.

- Durán, R., Yarlequé-Ruesta, D., Bellés-Muñoz, M., Jimenez-Viguer, A., & Muñoz-Tapia, J. L. (2020). *An architecture for easy onboarding and key life-cycle management in blockchain applications*. IEEE access, 8, 115005-115016.
- Gebremichael, D. D., Lee, H., Lee, Y., & Jung, Y. (2022). *Unified Breakdown Structure for Information Integration to Enhance Interoperability in the Built Environment*. Journal of Computing in Civil Engineering, 36(6), 04022030.
- He, Q., Wang, G., Luo, L., Shi, Q., Xie, J., & Meng, X. (2017). *Mapping the managerial areas of Building Information Modeling (BIM) using scientometric analysis*. International journal of project management, 35(4), 670-685.
- Jiao, Y., Wang, Y., Zhang, S., Li, Y., Yang, B., & Yuan, L. (2013). *A cloud approach to unified lifecycle data management in architecture, engineering, construction and facilities management: Integrating BIMs and SNS*. Advanced Engineering Informatics, 27(2), 173-188.
- Joannou, D., Kalawsky, R., Martinez-Garcia, M., Fowler, C., & Fowler, K. (2020). *Realizing the role of permissioned blockchains in a systems engineering lifecycle*. Systems, 8(4), 41.
- Jung, W., & Lee, G. (2016). *Slim BIM charts for rapidly visualizing and quantifying levels of BIM adoption and implementation*. Journal of Computing in Civil Engineering, 30(4), 04015072.
- Kelly, G., Serginson, M., Lockley, S., Dawood, N., & Kassem, M. (2013). *BIM for facility management: a review and a case study investigating the value and challenges*. Proceedings of the 13th International Conference on Construction Applications of Virtual Reality, 2, pp. 30-31. London.
- Kuperberg, M., & Geipel, M. (2021). *Blockchain and BIM (building information modeling): progress in academia and industry*. arXiv preprint arXiv, 2104.00547.
- Lawal, O. O., & Nawari, N. O. (2022). *Audit and Provenance Model for Transactions in Real Estate Markets through Blockchain-based Supply Chain Management*. Blockchain and Cryptocurrency Congress (B2C' 2022) (p. 128). Barcelona: IFSA Publishing.
- Leng, J., Ruan, G., Jiang, P., Xu, K., Liu, Q., Zhou, X., & Liu, C. (2020). *Blockchain-empowered sustainable manufacturing and product lifecycle management in industry 4.0: A survey*. Renewable and sustainable energy reviews, 132, 110112.
- Li, L., Yuan, J., Tang, M., Xu, Z., Xu, W., & Cheng, Y. (2021). *Developing a BIM-enabled building lifecycle management system for owners: Architecture and case scenario*. Automation in Construction, 129, 103814.
- Love, P. E., Matthews, J., Simpson, I., Hill, A., & Olatunji, O. A. (2014). *A benefits realization management building information modeling framework for asset owners*. Automation in Construction, 37, 1-10.
- Nawari, N. O., & Ravindran, S. (2019). *Blockchain technology and BIM process: review and potential applications*. Journal of Information Technology in Construction, 24(12), 209-238.
- Omidian, H., & Yadollah, O. (2022). *Blockchain in pharmaceutical life cycle management*. Drug Discovery Today, 27(4), 935-938.
- Parhiala, K., Yalcinkaya, M., & Singh, V. (2014). *Maintenance of facilities and aircrafts: a comparison of IT-driven solutions*. IFIP International Conference on Product Lifecycle Management (pp. 11-20). Berlin, Heidelberg: Springer.
- Parn, E. A., Edwards, D. J., & Sing, M. C. (2017). *The building information modelling trajectory in facilities management: A review*. Automation in construction, 75, 45-55.
- Patacas, J., Dawood, N., & Kassem, M. (2020). *BIM for facilities management: A framework and a common data environment using open standards*. Automation in Construction, 120, 103366.
- Pishdad-Bozorgi, P., Yoon, J., & Dass, N. (2020). *Blockchain-based information sharing: A new opportunity for construction supply chains*. EPIC Series in Built Environment, 1, 274-282.
- Pradeep, A. S., Amor, R., & Yiu, T. W. (2020). *Blockchain improving trust in BIM data exchange: a case study on BIMCHAIN*. Construction Research Congress 2020: Computer Applications, 1174-1183.
- Roberts, C. J., Parn, E. A., Edwards, D. J., & Aigbavboa, C. (2018). *Digitalising asset management: concomitant benefits and persistent challenges*. International Journal of Building Pathology and Adaptation.
- Sagiroglu, S., & Sinanc, D. (2013). *Big data: A review*. 2013 International Conference on Collaboration Technologies and Systems (CTS), (pp. 42-47). doi:10.1109/CTS.2013.6567202
- Sreckovic, M., Sibenek, G., Sigalov, K., Ye, X., Konig, M., & Reitmayer, K. (2021). *Upkeeping digital assets during construction using blockchain technology*. Proc. of the Conference CIB W78, 2021, pp. 11 -15.
- Succar, B. (2009). *Building Information modelling framework: A research and delivery foundation for industry stakeholders*. Automation in Construction, 18(3), 357-375.
- Wang, J., Wu, P., Wang, X., & Shou, W. (2017). *The outlook of blockchain technology for construction engineering management*. Frontiers of engineering management, 67-75.
- Wetzel, E. M., & Thabet, W. Y. (2015). *The use of a BIM-based framework to support safe facility management processes*. Automation in Construction, 60, 12-24.
- Ye, Z., Yin, M., Tang, L., & Jiang, H. (2018). *Cup-of-Water theory: A review on the interaction of BIM, IoT and blockchain during the whole building lifecycle*. ISARC. Proceedings of the International Symposium on Automation and Robotics in Construction. 35, pp. 1-9. IAARC Publications.
- Zhong, B., Gao, H., Ding, L., & Wang, Y. (2023). *A Blockchain-Based Life-Cycle Environmental Management Framework for Hospitals in the COVID-19 Context*. Engineering, 20, 208-221.

Changing Roles of Human in the Human-Robot Interactions in Design and Construction

Rui Liu ^{1,2}, Vahid Koliyaei ¹, Frederick Lucak ¹, Yibei Guo ²

¹College of Architecture and Environmental Design, Kent State University, Kent, OH

²College of Aeronautics and Engineering, Kent State University, Kent, OH

ABSTRACT: Human and robot interaction in architecture, engineering, and construction (AEC) has recently increased intensively due to the fast development of advanced computing and artificial intelligence. Throughout history, the relationship between humans and machines has been in tension since the industrial revolution in the 18th century. The study reviews the past and current human-robot “interactions” in the AEC industry. It discusses the future of the human-robot collaborative design and construction through two projects, one with automation in robotic portrait sketching employing a computer vision algorithm and the second with direct communication between a human and a robotic arm through natural language processing in a simulated environment to build a masonry arch. The two projects demonstrate the potential of intelligent robotic construction via “seeing” and “speaking.” The study attempts to interpret the current role of humans in human-robot interactions in design and construction and speculates the future trends and the impacts on job loss and gain in the AEC industry.

KEYWORDS: Robotic Construction, Humans-Robots Interaction, Collaborative Design and Construction

INTRODUCTION

The concept of machine behavior and its ramifications have existed in religions, mythology, and literature for centuries. Leonardo da Vinci drew a mechanical man in 1495, which has been tested for viability in the contemporary era. The term “robot” was derived from the Czechoslovakian term “robota”, which means “worker” (G. & C. Merriam Co., 1965), which first appeared in Karel Chapek’s 1920 drama *Rossum’s Universal Robots* (Rosheim, 2006). As industrialization accelerated after World War II, humans started to accept automation as a fascinating, desirable, and probably inevitable industrial development for economic progress, improved living standards, greater freedom, and better lives (Wingo, 1963). Over the last decade, as shown in Figure 1, the discipline of computational design in architecture has used robotic manufacturing to investigate the intrinsic qualities and accuracies of material systems revealed by automation in construction (Gramazio and Kohler, 2008).

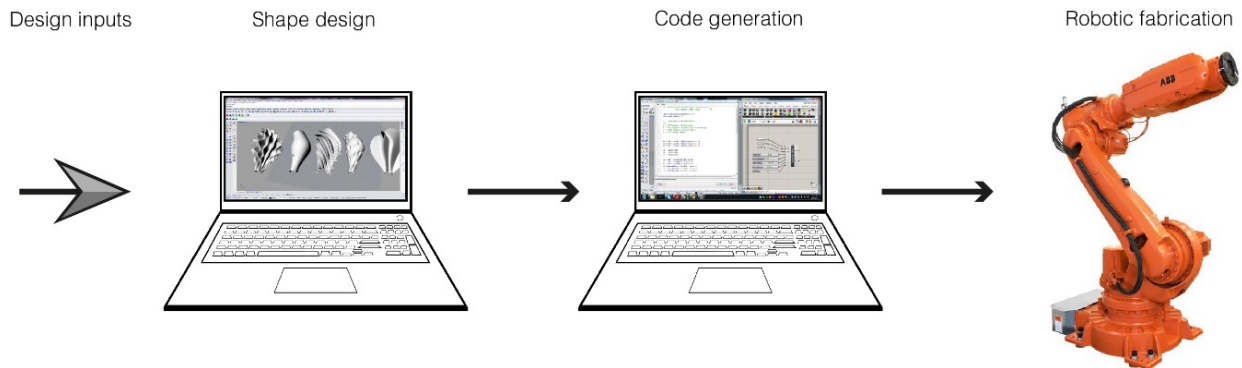

Figure 1: Robotic fabrication. Source: Authors

Human-Robot Interaction (HRI) in design and construction has attracted much interest in academia, technological firms, and the media due to the fast development of advanced computing and artificial intelligence. However, throughout history, the relationship between humans and machines has been in tension since the industrial revolution in the 18th century. In the mid-1950s, some people started to see automation had a possible detrimental effect, endangering the health and the lives of industrial workers who face a variety of growing pressures both physically and psychologically (Beach, 1971). This paper reviews the past and current human-robot “interactions” in the AEC industry in the section on “Automation in Construction.” It discusses HRI in achieving automation in construction in the section “Level of Automation.” The section on “Case Studies” discusses two projects to speculate the future of the human-robot collaborative design and intelligent construction via “seeing” and “speaking,” one with robotic portrait sketching employing a computer vision algorithm and the second with direct communication between a human and a robotic arm

through natural language processing in a simulated environment to build a masonry arch. The case studies demonstrate the changing roles of humans in human-robot interactions in design and construction caused by advanced computing and artificial intelligence.

1.0 AUTOMATION IN CONSTRUCTION

1.1 Robots/Machine/Tools

The construction industry is inherently dangerous, accounting for around 20% of all worker accidents in the United States (U.S. Department of Labor, 2014). In addition, construction firms report difficulties filling job vacancies, with nearly 200,000 construction jobs across the country left unfilled due to a lack of skilled applicants (Glaser and Molla, 2017). Automation in construction may reduce these issues while allowing for totally new uses. Remote automated construction might find use in building interplanetary habitats, such as assisting in forthcoming human Mars expeditions (Khoshnevis, 2004). Various tools (e.g., grippers, drills, extruders, saws, etc.) have been invented, either working independently, e.g., 3D printers, CNC machines, or being connected to robot arms, for digital fabrications. Some examples of automation in construction using concrete or ceramics are listed in Table 1. Research groups at the University of Stuttgart have employed robotic construction to design and construct new types of architecture using composite materials. Robotic masonry structure building was first demonstrated at the architectural dimension in the Gantenbein Winery construction when robotic arms were utilized to build the complex's undulating brick walls (Bonwetsch et al. 2007). More examples are available from *Fabricate* conference proceedings (<https://www.uclpress.co.uk/collections/series-fabricate>).

Table 1: Examples of Automation in Construction using Concrete or Ceramics

	Tech./Project Name	Year	Affiliation	Reference
1	Concrete 3D Print	2003	WinSun	Malaeb et al., 2015
2	Powder Bed 3D Print	2009	D-Shape	Jakupovic, 2016
3	Mesh Mould	2013	ETH	Hack et al., 2017
4	Glass 3D Print	2014	MIT	Klein et al., 2015
5	WAAM	2014	MX3D	Gardner et al., 2020
6	ABS plastic 3D Print	2015	Ai-Build	Rosenzweig et al., 2015
7	Concrete Extrusion 3DPrint	2016	XtreeE	Buswell et al., 2018
8	Smart Dynamic Casting	2012	ETH	Fritschi, 2016
9	Mobile concrete 3DPrint	2016	Cybe	Tarhan & Şahin, 2019
10	Smart Slab	2017	ETH	Meibodi et al., 2017
11	KnitCrete	2018	ETH	Popescu et al., 2021
12	3D Print Tile	2019	KSU	Liu & Liu, 2019, 2021

New robotic tools have influenced operational performance results in architecture, and construction method has also influenced the development of correlating robotic fabrication methods and machinery (Bonwetsch et al., 2006; Dörfler et al., 2016; Abdelmohsen et al., 2019; Piškorec et al. 2018). Additionally, integrative design techniques proposed co-development of design formulation, material testing, and robotic production strategy to speed iterative advancement among equipment and idea (Parascho et al. 2015). The projects mentioned above followed the linear robotic fabrication sequence, as shown in Figure 1. Automated tools were used as executors during the process of automation in construction. There were no interactions between humans and robots/machines/tools.

1.2 Human-Robot Interaction

Robotics and automation have advanced tremendously in recent years, with quicker, smaller, and more affordable equipment. They have great potential to enhance productivity, decrease operational expenses, improve the quality of the products, and expand production flexibility. The world has entered the "Fourth Industrial Revolution," defined by genetic advancements, artificial intelligence, robotics, and autonomous vehicles (Schwab, 2016). Automation has already had a significant impact on the manufacturing industry. It will have an increasing influence on even more industries, including the AEC industry. However, in the early 1950s, many people had negative opinions on automation, fueled partly by Charlie Chaplin's 1936 movie *Modern Times*, which provided a harsh assessment of industrialization's dehumanizing effects.

Contrary to dehumanization, HRI is a discipline committed to understanding, creating, and assessing robotic machines for use through or with humanity, which is a subdivision of the topic of human-computer interaction (Yanco and Drury, 2002; Huang, 2016). Feli-Siefer and Mataric (2010) specified that the objective of HRI is to enable the robot system "to interact with humans in a clear, safe, and efficient manner" to "gain" human trust. The ability of the communication interface(s) to transfer visual, auditory, and environmental data between humans and robots may significantly impact HRI performance (Steinfeld et al., 2006; Green et al., 2008). The physical appearance of a robot during the first encounter might influence how it is understood by its users and, therefore, how the human might engage with the robot

(Luptetti, 2017). Anthropomorphic designs paired with natural user interfaces improve these technologies' overall adoption and interactivity (Duffy, 2003; Richert et al., 2018). However, it may be easier for humans to accept other types of robots, e.g., bionic quadruped robots, robotic arms, robot vacuums, etc., in industrial automation.

1.3. Roles of Human in HRI

Although HRI is new to the AEC industry, HRI in design and construction is developed based on a considerable collection of information from subjects of robotics, mechatronics, engineering, and computer science. The architectural study can link many different fields through novel techniques and applications. As a result, it is critical for professionals in the AEC industry to understand the potential of HRI in design and construction. Over the last few decades, the discipline of robotic systems has evolved into two separate applications: industrial and creative. Industrial robots are designed to replace humans in repetitive, filthy, and dangerous activities. They are designed to boost speed and production while lowering costs.

On the other hand, the creative use of robots strives to supplement humans by providing super accuracy and re-enabling complexity (ARUP, 2020). Humans are designers who predefined robotic duties. They observe the automatic operation, make required modifications, and refine the building operations. There are two ways to look at robotic building processes: (1) full automation intended to replace human labor and (2) collaborative procedures involving humans and robots that extend potential design and construction options (Han et al., 2021). While automation may result in more rapid and effective building processes, employing human actors in manufacturing is a significantly more worthwhile and sustainable aim. Instead of eliminating the presence of human employees on building sites, it is beneficial to investigate how robots may assist people to create a human-centered computing environment. The roles of humans in HRI in design and construction are further defined in the observe-orient-decide-act (OODA) loop (Figure 2) created by Colonel John Boyd.

2.0 LEVEL OF AUTOMATION

2.1. Boyd's OODA Loop

Colonel John Boyd, a military expert, applied the OODA notion following a cyclical pattern of observe-orient-decide-act for a human to make decisions in a war, which frequently occurred at the functional level throughout military conflicts. It is currently frequently used to comprehend business procedures and learning processes. An entity (person or institution) that can execute this cycle swiftly, monitoring and responding to events unfolding faster than an opponent, might "get in" the opponent's decisions cycle and gain an edge (Richards, 2020). All of the HRI projects in design and construction can be analyzed based on the autonomy in digital fabrication and their processes to engage humans in the OODA model. Accordingly, Table 2 adopts Boyd's OODA loop to evaluate the level of HRI in design and construction.

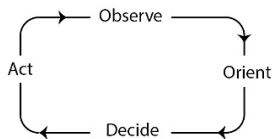

Figure 2: OODA Loop (adapted from Richards, 2020)

2.2. Application of OODA Loop

The Light-Vault project (Figure 3) provides a novel robotic construction strategy for brick vaults. The researchers devised a technique for the two robots to work together with humans to construct the vault without scaffolding or other reinforcement. This required the adoption of generic and specialized approaches that enabled rapid and diverse staging and execution. In the project, the robotic arms displayed the constructed structure to humans, but humans were still the primary observers of the construction. Human has the primary duty to interpret the design and construction to make decisions. The computer-assisted humans in designing the structure and simulating the construction sequence. The robot performs the construction with humans' confirmation. According to Boyd's OODA loop, the project falls between level 2 and level 3 of HRI in design and construction. The following two projects completed at the authors' institution demonstrate the changing roles of humans in human-robot interactions in design and construction caused by advanced computing and artificial intelligence.

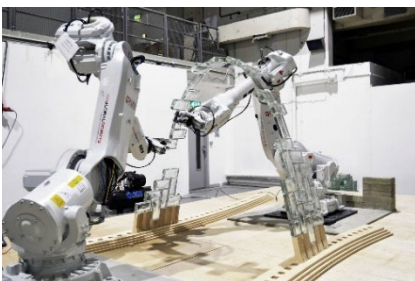

Figure 3: The Light-Vault (Bruun, E. et al, 2021; Parascho, S. et al, 2021; reproduced with permission)

Table 2: Boyd’s OODA (Adopted from Proud et al., 2013)

Level	Observe	Orient	Decide	Act
1	Humans are the primary designers and supervisors in design and construction (characterized as information filtering, prioritization and comprehension). Humans are the primary designers and supervisors for obtaining and reviewing all information related to design and construction, with machine or robot backup in case of an emergency.	Humans are in charge of assessing and interpreting the information of design and construction, and generating predictions. Humans are the primary source of forecasting and analysis for contingencies. To interpret the design and construction is the duty of the humans.	The machine or robot does not execute or help in rating duties. Humans should accomplish everything. All decisions are made by humans, however machines or robots can be employed to assist.	Only humans could carry out decisions. Humans are the main operators with machine or robots covering contingencies.
2	The machine or robot is in charge of obtaining and showing unstructured, unprioritized data to humans. The humans are still the primary observer of data for the purpose of design and construction.	The machine or robot is the main analyzer for predictions with humans shadowing for emergencies. But humans still have the responsibility in interpreting data related to design and construction.	Analyses and Evaluations are performed by both humans and computers. Human outcomes are seen as superior.	With human confirmation, the machine or robot performs the decisions. Human shadows contingency.
3	The machine or robot is in charge of obtaining and presenting design and construction data for the humans. However, it emphasizes non-prioritized, pertinent data for the human.	The machine or robot evaluates the information and forecasts the activities in design and construction. Despite the fact that the human is in charge of interpreting the data.	Evaluations are performed by both humans and computers. The computer's output is superior to human's.	Prior to actually executing the decisions in design and construction, the machine and robot provides the human a pre-programmed limited time to veto.
4	The machine and robot is in charge of collecting data for the humans and it only shows filtered non-prioritized items to human.	The machine or robot evaluates the informatin related to design and construction and overlays predictions with evaluation. For contingencies, the humans shadows the interpretations.	The machine or robot is in charge of evaluations, showing the humans all outcomes, including reasons.	Before execution, the machine or robots permits the humans context-dependent limited time veto. Humans shadows for contingencies.
5	The machine or robot collects, filters, and organizes data related to design and construction that is shown to the human.	The machine or robot evaluates the design and construction, and overlays analysis with prediction, and display entire outcomes to the human.	The machine or robot performs evaluations and shows a reduced set of rated possibilities in design and construction to the human while explaining "why" choices were reached.	The machine and robot operates autonomously, notifies the human, and permits for overriding following operation in design and construction. Humans are contingency shadows.
6	The machine or robot collects, filters, and prioritizes information in design and construction without presenting it to the human, only displaying a "program operating" flag.	The machine or robot analyzes, anticipates, interprets, and documents comprimizations to provide a conclusion that is only shown to humans if the conclusion matches the specified environment.	The machine or robot is in charge of evaluations. The machine or robot conducts overall rankings and shows a limited subset of ranked possibilities to the humans without explaining "why" judgments were chosen.	The machine or robot performs autonomously in design and construction and just tells the human when necessary. It enables override capability following operation. Humans are contingency shadows.
7	The machine or robot collects, filters, and ranks information related to design and construction without presenting it to the user.	The machine or robot anticipates, analyzes, and integrates data related to design and construction to provide a conclusion that is not visible to humans.	The machine or robot is in charge of evaluations, making the final decisions in design and construction. However, the findings are not displayed to the humans.	The machine and robots runs autonomously with no human intervention.
8				

3.0 CASE STUDIES

3.1. Robotic Portrait Sketching

A linear workflow was developed to engage a robotic arm in sketching using any input images, with one example illustrated in Figure 4. The input image was converted to a squiggle drawing using computer vision algorithms, with the results saved as a scalable vector graphics (SVG) file. Unlike pixel-based raster files, SVG files store images based on points and lines on a grid represented by math formulas that could be resized without losing quality. The SVG file was imported into Rhino and scaled. KUKA|PRC, parametric robotic control for Grasshopper, enables human designers to generate the KUKA instruction set in KUKA Robot Language (KRL), a proprietary programming language similar to Pascal to control KUKA robots. Abode Illustrator provides functions to convert JPEG images into a vector drawing and

save the drawings as an SVG file. A rich library provided by OpenCV (open source computer vision), initially developed by Intel, has machine learning algorithms, e.g., adaptive thresholding, canny edge detection, etc., to convert JPEG images into vector drawings. Adaptive thresholding computes the threshold value for a small set of neighboring pixels and then performs the segmentation. Canny edge detection is a popular multi-stage algorithm to detect edges by reducing noises, finding the intensity gradient of an image, suppressing non-maximum values, and examining hysteresis thresholding to get strong edges in an image.



Figure 4: Robotic Portrait Sketching. (Left) Kuka KR60 Arm, (Right-Up) Input Image, (Right-Down) Sketch by Kuka Arm. Source: Authors

Like many other robotic design projects with workflow shown in Figure 1, it falls between level 2 and level 3 HRI automation. Artificial intelligence image processing with diffusion models adopted by Dall-E 2, Google's Imagen, Stable Diffusion, and Midjourney have stormed the world, inspiring creativity and pushing the boundaries of machine learning by generating a near-infinite variety of images from text prompts. These algorithms enable humans to interact with the machine to generate almost any imaginary images. Robots could sketch these created images following the proposed workflow without explicitly being displayed on a computer screen.

The project shows the "seeing" potential of the machine or robot to assist humans in interpreting imaginary images by converting them into dots and lines represented by math formulas. The robot could implement object recognition algorithms to correlate the appropriate category labels with different items. The capacity would enable the robots to pick up the correct tools for the design and construction.

3.2. Robotic Masonry Arch Construction

Algorithms were developed and verified to design masonry corbel arches that could be built without centering based on the principle of equilibrium conditions for each masonry unit (Figure 5a). A variety of masonry vaults could be generated from the algorithm (Neupan and Liu, 2020). Also, the algorithms have been employed to simulate the process of robotic construction using KUKA|PRC, as shown in Figure 5b. However, due to the dynamics of real-world construction and the uncertainty of hardware, the automation in construction using robot arms may fail in task executions, leading to structural failures and endangering human lives. Therefore, it is critical to identify near-miss failures in an early stage before a difficult situation happens and correct abnormal robot behavior according to human supervisors' instant verbal guidance due to the limited reasoning capacity of the machinery.

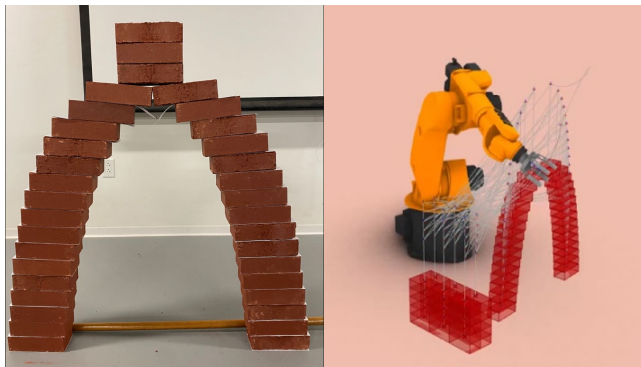

Figure 5: Masonry corbel arch design and construction. (Left) Masonry corbel arch, (Right) Robotic masonry construction. Source: Authors

A workflow was developed for advanced automatic robotic manufacturing following an end user’s natural language instruction. The method (Figure 6) helped a robot understand a human’s verbal commands and directly follow verbal guidance to perform actual tasks. It helps a robot to extract task goals and execution methods from ambiguous verbal instructions of a human. Using ordinary speaking language makes interaction between a human and a robot natural and instant without heavy prior training in defining communication language and contents. With the timely intervention of a human, robot and human workers are integrated seamlessly, and robot performance is vastly increased with a human’s comprehensive understanding of tasks. This project demonstrated the potential of human verbal guidance in intelligent robotic masonry arch construction, developing a natural, instant, and early-failure-preventive human-robot collaborative partnership in smart construction work. As shown in Figure 6a, a framework of speech encoder (wav2vec2) and decoder (Speech2Text2) was employed to recognize human verbal instructions (Baevski et al., 2020; Wang et al., 2021). Embeddings obtained by the Transformer model developed by google were used to classify word labels shown in Figure 6b. The developed algorithms have been successfully implemented in a simulated environment with the interface screenshot shown in Figure 7. Based on the results from the natural language processing model, corresponding data from the simulator are retrieved, and new settings are sent to the robot.

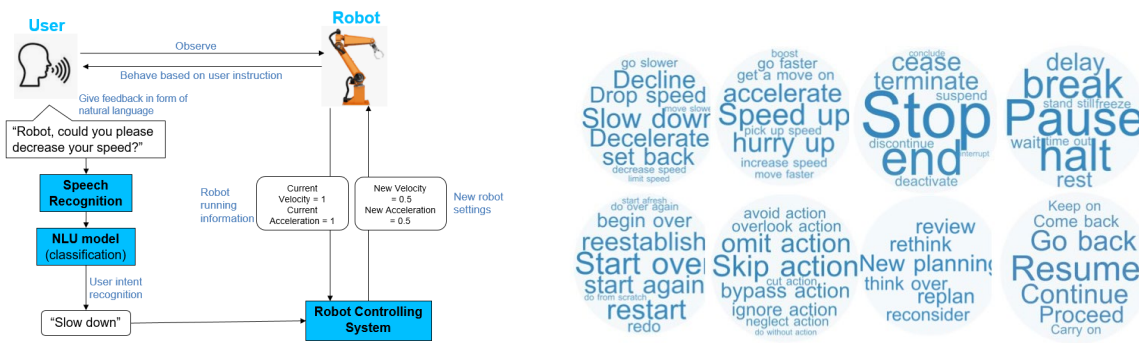

Figure 6: Intelligent masonry arch construction with human verbal guidance. (Left) Workflow of intelligent construction, (Right) Word classification labels. Source: Authors

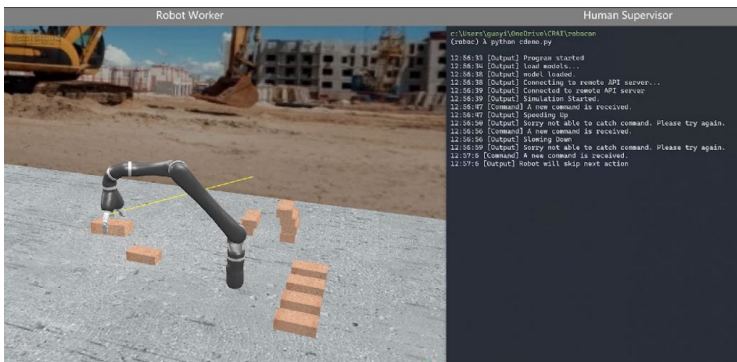

Figure 7: Screenshots of result demo. Source: Authors

AEC professionals are growing interested in exploring the applications of artificial intelligence algorithms, including computer vision and natural language processing, in architectural and engineering designs, manufacturing, fabrication, and construction. This project encourages creative thinking by engaging the computing power and algorithms of natural language processing to augment human capacities in intelligent design and construction through HRI. The project demonstrates the potential of elevating the HRI in design and construction to the upper levels defined in Table 2.

4.0 DISCUSSIONS

Artificial intelligence and robots, for example, will significantly benefit people, enterprises, and economies, increasing economic growth, and productivity. The magnitude to which these techniques replace employees will be determined by the rate at which they develop and are adopted, economic growth, and the rise in labor demand. Even as technology causes job losses in some fields, it will also generate new vocations that are not present now, much like previous technologies did. According to McKinsey Global Institute (2017), their 46-country scenarios imply that between practically zero and one-third of workplace activities might be replaced by 2030, with a mean of 15%. The amount varies considerably among nations, with advanced economies being more affected than emerging economies, reflecting more excellent pay rates and hence economic incentives to automate. Researchers at PricewaterhouseCoopers have estimated that robots and artificial intelligence could replace 38 percent of the United States jobs by the early 2030s (PwC, 2017). Some economists think 3.4 million U.S. jobs could be lost by 2025 due to

technological advances, artificial intelligence, machine learning, 3D printing, and robotics (McRae, 2017). The majority of these lost jobs will be in office and administrative positions, fast food, retail, manufacturing production, transportation, and construction. Jobs that are popular now are expected to become more automated in the future. Machines and robotics have displaced manufacturing workers. Touch screens have replaced many cashiers at restaurants and stores. Artificial intelligence—such as a voice Bot—is used to make sales calls, replacing salespeople. Surgical robots are used in knee replacement surgery and vision correction surgery. Self-driving trucks are expected to take over the jobs of truck drivers in the future. The careers that people have today will be very different in the next 40 years; according to ManpowerGroup, 65 percent of the jobs Generation Z will not yet exist (ManpowerGroup, 2016). Skilled AEC professionals equipped and connected with emerging technologies are expected to remain in high demand across the country. It is expected to see more and more design and construction projects utilizing various forms of HRI in design and construction, like interacting with robots, drones, and other emerging technologies to improve the efficiency of the construction.

CONCLUSION

Human-centered computing would enable the machine or robot to gain the “trust” of humans during the HRI in design and construction, promoting the adoption of these technologies by a human. The two projects, one with robotic portrait sketching and the other with intelligent robotic masonry construction with human vertical guidance, demonstrated that AI algorithms in computer vision and natural language processing would change the roles of humans in the HRI in design and construction. The AEC industry is typically behind other industries in adopting emerging technologies, but the “Industrial Revolution 4.0” would significantly change the future design and construction practice. Skilled AEC professionals equipped with emerging technologies will remain in high demand. But corresponding laws and regulations should be developed to ensure that human-centered computing is utilized ethically.

ACKNOWLEDGEMENTS

The research is supported by the cross disciplinary integration grant funded by the authors’ institution.

REFERENCES

- Abdelmohsen, S., Tarabieh, K., El-Dabaa, R., Hassan, A., Salem, I., El-Ghazi, Y. 2019. *Coupling Parametric Design and Robotic Assembly Simulation to Generate Thermally Responsive Brick Walls*. Proceedings of the 16th IBPSA Conference.
- ARUP report. 2020. *Designing with digital fabrication*. ARUP.
- Baevski, Alexei, Yuhao Zhou, Abdelrahman Mohamed, and Michael Auli. 2020. wav2vec 2.0: A framework for self-supervised learning of speech representations. *Advances in Neural Information Processing Systems*, 33: 12449-12460.
- Beach, E. 1971. Automation in Perspective. *Applied Economics*, 3:2, 147-152, DOI: 10.1080/00036847100000036
- Canning, C., Donahue, T.J., & Scheutz, M. 2014. *Investigating human perceptions of robot capabilities in remote human-robot team tasks based on first-person robot video feeds*. IEEE International Conference on Intelligent Robots and Systems.
- Bonwetsch, T., Gramazio, F. 2007. *Digitally Fabricating Non-Standardised Brick Walls*. ManuBuild.
- Bruun, Edvard P. G., Rafael Pastrana, Vittorio Paris, Alessandro Beghini, Attilio Pizzigoni, Stefana Parascho, and Sigrid Adriaenssens. 2021. Three Cooperative Robotic Fabrication Methods for the Scaffold-Free Construction of a Masonry Arch. *Automation in Construction*. 129 (September): 103803. <https://doi.org/10.1016/j.autcon.2021.103803>.
- Buswell, R. A., Leal De Silva, W. R., Jones, S. Z., & Dirrenberger, J. 2018. *3D printing using concrete extrusion: a roadmap for research*. <https://bit.ly/29K635B>
- Dörfler, K., Rist, F., & Rust, R. 2012. *Interlacing—an experimental approach to integrating digital and physical design methods*. Brell-Cokcan S and Braumann J (eds), Robotic fabrication in architecture, art and design. 82-91.
- Duffy, B.R. 2003. Anthropomorphism and the social robot. *Robotics and Autonomous Systems*. 42(3), 177–190.
- Feli-Siefer, D., Mataric, M.J. 2010. Human-robot interaction. *IEEE Robotics and Automation Magazine*. 17(2), 4643–4659.
- Fritschi, L. 2016. *Smart Dynamic Casting- A digital fabrication method for non-standard concrete structures Smart Dynamic Casting* [Architect MAA, Royal Danish Academy of Fine Arts]: ETH Zürich. <https://doi.org/10.3929/ethz-a-010800371>
- G. & C. Merriam Co. 1967. *Webster's Seventh New Collegiate Dictionary*. G. & C. Merriam Company.
- Gardner, L., Kyvelou, P., Herbert, G., & Buchanan, C. 2020. Testing and initial verification of the world's first metal 3D printed bridge. *Journal of Constructional Steel Research*. 172. <https://doi.org/10.1016/j.jcsr.2020.106233>
- Glaser, A., Molla, R. 2017. *The Construction Industry is Short on Human Workers and Ripe for a Robotic Takeover*. McKinsey Global Institute.
- Green, SA., M. Billingham, X. Chen, and JG. Chase. 2008. Human-Robot Collaboration: A Literature Review and Augmented Reality Approach in Design. *International Journal of Advanced Robotic Systems*, 1–18.
- Han, I. X., Meggers, F., & Parascho, S. 2021. Bridging the collectives - A review of collective human-robot construction. *International Journal of Architectural Computing*. <https://doi.org/10.1177/14780771211025153>
- Hack, N., Wangler, T. P., Zurich, E., Mata-Falcón, J., Dörfler, K., Wangler, T., Kumar, N., Nikolas Walzer, A., Graser, K., Reiter, L., Richner, H., Buchli, J., Kaufmann, W., Flatt, R. J., Gramazio, F., & Kohler, M. 2017. *Mesh Mould*:

- An onsite, robotically fabricated, functional formwork.* National Museum of Qatar View project Grinding of Inorganic Solids in the Presence of Organic Additives
- Huang, W. 2016. *When HCI Meets HRI: the Intersection and Distinction.* Proceedings of the 9th Nordic Conference on Human-Computer Interaction, 1–8.
- Jakupovic, A. 2016. *D-SHAPE – Report.* 3D Printhuset A/S.
- Klein, J., Stern, M., Franchin, G., Kayser, M., Inamura, C., Dave, S., Weaver, J. C., Houk, P., Colombo, P., Yang, M., & Oxman, N. 2015. Additive Manufacturing of Optically Transparent Glass. *3D Printing and Additive Manufacturing*, 2(3), 92–105. <https://doi.org/10.1089/3dp.2015.0021>
- Khoshnevis, B. 2004. Automated Construction by Contour Crafting—Related Robotics and Information Technologies. *Automation in Construction*. 13.
- Liu, B., Liu, R. 2021. Performance-based computational design and fabrication for a resilient solution: dredged material for masonry vault construction. *The Plan Journal*. 6(2). <https://www.doi.org/10.15274/tpj.2021.06.02.7>
- Luptetti. 2017. ML, Robots, aesthetics, and heritage contexts: Association for Computing Machinery. *Interactions*. 24, 5 (September - October 2017), 6–7. <https://doi.org/10.1145/3125389>
- Malaeb, Z., Hachem, H., Tourbah, A., Maalouf, T., Zarwi, E., & Hamzeh, F. 2015. 3D Concrete Printing: Machine and Mix Design. *International Journal of Civil Engineering and Technology*. 6(6), 14–22.
- ManpowerGroup. 2016. *The Skills Revolution: Digitization and Why Skills and Talent Matter.* ManpowerGroup Report.
- McKinsey Global Institute. 2017. *Job Lost Job Gain: Workforce transitions in a time of Automation.* McKinsey Global Institute.
- McRae, M. 2017. *Unsettling New Statistics Reveal Just How Quickly Robots Can Replace Human Workers.* Science Alert.
- Meibodi, M., Bernhard, M., Jipa, A., & Dillenburger, B. 2017. *The Smart Takes from the Strong: 3D printing stay-in-place formwork for concrete slab construction.* UCL Press. <https://doi.org/10.3929/ethz-b-000237103>
- Neupane, B. and Liu, R. (2020). *Exploring Forms of Masonry Vaults Built without Centering.* IASS 2020/21 Surrey Symposium: Conceptual design, pp. 1-14(14).
- Parascho, S., Knippers, J., Dörstelmann, M., Prado, M., Menges, A. 2015. *Modular Fibrous Morphologies: Computational Design, Simulation and Fabrication of Differentiated Fibre Composite Building Components.* Advances in Architectural Geometry, 29–45. Cham: Springer
- Parascho, Stefana, Isla Xi Han, Alessandro Beghini, Masaaki Miki, Samantha Walker, Edvard P. G. Bruun, and Sigrid Adriaenssens. 2021. *LightVault: A Design and Robotic Fabrication Method for Complex Masonry Structures.* In Advances in Architectural Geometry 2020, 350–75. Paris, France: Presses des Ponts. https://thinkshell.fr/wp-content/uploads/2019/10/AAG2020_18_Parascho.pdf.
- Popescu, M., Rippmann, M., Liew, A., Reiter, L., Flatt, R. J., van Mele, T., & Block, P. 2021. Structural design, digital fabrication and construction of the cable-net and knitted formwork of the KnitCandela concrete shell: *Structures*, 31, 1287–1299. <https://doi.org/10.1016/j.istruc.2020.02.013>
- Proud, R. W., Hart, J. J., & Mrozinski, R. B. 2013. *Methods for Determining the Level of Autonomy to Design into a Human Spaceflight Vehicle: A Function Specific Approach.* NASA.
- Piškořec, L., Jenny, D., Parascho, S., Mayer, H., Gramazio, F., Kohler, M. 2018. *The Brick Labyrinth.* In Robotic Fabrication in Architecture: Springer International Publishing.
- PricewaterhouseCoopers (PwC). 2017. *Will Robots Steal Our Jobs? The Potential Impact of Automation on the UK and Other Major Economies.* UK Economic Outlook.
- Richert, A., S. Müller, S. Schrode, and S. Jeschke. 2018. Anthropomorphism in Social Robotics: Empirical Results on Human–Robot Interaction in Hybrid Production Workplaces. *AI and Society*. 413–424.
- Richards, C. 2020. *Boyd’s OODA Loop.* *Necesse*, 5(1), 142–165.
- Rosenzweig, D. H., Carelli, E., Steffen, T., Jarzem, P., & Haglund, L. 2015. 3D-printed ABS and PLA scaffolds for cartilage and nucleus pulposus tissue regeneration. *International Journal of Molecular Sciences*. 16(7), 15118–15135. <https://doi.org/10.3390/ijms160715118>
- Rosheim, M.E. 2006. *Leonardo’s Lost Robot:* Springer Verlag.
- Schwab, Klaus. 2016. *The Future of Jobs Employment, Skills and Workforce Strategy for the Fourth Industrial Revolution.*
- Steinfeld, A., Fong, T., Kaber, D., Lewis, M., Scholtz, J., Schultz, A., & Goodrich, M. 2006. *Common metrics for human–robot interaction.* Proceedings of the 2006 ACM Conference on Human-Robot Interaction, 33–40.
- Tarhan, Y., & Şahin, R. 2019. Developments of 3D Concrete Printing Process: Effect of Mineral Additive Type and Ratio on Radon Gas Emanation of Self-Compacting Concrete. *International Civil Engineering and Architecture Conference.*
- U.S. Department of Labor. 2014. Federal register, Department of Labor: Wage and Hour Division, Department of Labor.
- Yanco, HA., & Drury, JL. 2002. *A Taxonomy for Human-Robot Interaction.* Proceedings of the AAAI Fall Symposium on Human-Robot Interaction, 111–119.
- Wang, C., Wu, A., Pino, J., Baevski, A., Auli, M., Conneau, A. 2021. *Large-Scale Self-and Semi-Supervised Learning for Speech Translation.* arXiv preprint arXiv:2104.06678
- Wingo, W. 1963. *Automation’s Impact.* The Science Newsletter, 84(18), 278.

Combining Electrochromic Glazing Systems with Different Light Transmissions Towards Optimizing Daylight in Office Buildings

Alireza Jahanara ¹, Jae Yong Suk²

¹ The University of Texas at San Antonio, San Antonio, TX

² University of California, Davis, CA

ABSTRACT: Electrochromic (EC) glass is one of the advanced fenestration systems that offer daylight harvesting and outdoor views. EC glasses vary in their visual and thermal properties based on the electric field. EC glazing preserves outside visibility while controlling incoming sunlight and solar heat gains. This research focuses on the optimization of EC glazing configurations with different visual light transmissions to improve qualitative and quantitative daylighting performance in office buildings. This paper analyzes the EC glasses with different tinting control algorithms based on the interior daylight sensors installed, and to examine its dynamic controls of the visible light transmittance. The window in the study was divided into upper and lower apertures and each aperture has electrochromic glazing installed with different transmittance values to find optimum visible light transmission values. The daylight analyses were performed using ClimateStudio for Rhino software as a parametric tool to link with Radiance and DAYSIM. The daylighting performance of EC glasses was then evaluated by both Spatial Daylight Autonomy (sDA) and Annual Solar Exposure (ASE) metrics.

This study identified the best configuration of EC glazing that greatly decreases discomfort glare potential while improving daylight introduction and distribution throughout a year in a deep office space in San Antonio, Texas and Seattle, Washington. Moreover, the performance-based design approach leads to optimize the EC glazing configurations. The optimization of EC glazing is an adept solution for anyone seeking to balance natural light introduction and occupants' visual comfort in buildings. This study also offers valuable insights into the optimal configuration of EC glazing for different climates.

KEYWORDS: Electrochromic Glazing, Daylight Transmission, Performance Simulation, Optimizing Daylight

INTRODUCTION

Building windows perform an essential role in controlling external environments. Creating a well-daylit space requires a suitable balance between daylight provision and control. The wise use of daylight is preferred by building occupants in working spaces, as it is proven that it does not only increase the employees' satisfaction, productivity and visual comfort, but it also improves their health and well-being; on the other hand, an excessive amount of natural light coming through the window can also cause visual discomfort in the form of glare (Cannavale et al., 2020).

Moreover, due to the wider availability of embedded sensing devices and automated components, automated building controls are becoming more popular (Reynisson & Guðmundsson, 2015). Sensing devices and automated components can integrate with building control strategies and occupant data, leading to optimized daylighting in order to approach a sustainable environment (Dutta, 2018). Hence, the interaction between the occupants and the so-called automated glazing technologies, such as electrochromic (EC) glass, is an area of particular interest in current studies (Cannavale et al., 2020). The goal of EC glass technologies is then to maintain a balance between the advantages and disadvantages of sunlight penetration (Dutta, 2018).

EC glass has the benefit of controlling the transmittance of the glass by itself without needing a separate shading device, and it is easily controlled via an electric signal (Ardakan et al., 2017). Moreover, unlike blinds or roller shades which are usually mounted indoors, EC glass can be installed as the external layer of dual or triple glass. This is an effective means of controlling solar radiation and thus has a high solar radiation block ratio. An additional advantage is its relatively low maintenance, as smart glass does not often need replacing due to contamination or damage (Ardakan et al., 2017). EC glass's visual transmittance can be controlled by a small application of electric current. This is beneficial in managing the admission of daylight into buildings, as the windows can be darkened when too much light causes glare and can be made lighter when more light is needed to illuminate the interior space (Reynisson & Guðmundsson, 2015).

This research seeks to find a strategy to balance daylight optimization with visual comfort. As a result, we have divided the windows into upper and lower parts, so that the upper part supports daylight optimization and the lower part supports visual comfort. We also tested and compared EC glasses from different companies with different tinting to find the best configuration of EC glass tinting in terms of daylighting and visual comfort.

Dependent Variables: Metrics for Daylight

Analysis of daylight performance is generally performed in computer-based simulations by using a range of metrics:

- Spatial Daylight Autonomy (sDA) describes a percentage of floor areas that receive sufficient daylight above 300 lx in more than 50% of its occupied hours (Dutta, 2018).
- Annual Sunlight Exposure (ASE) is a proxy for direct sunlight, an indicator of potential illuminance problems. It measures a percentage of floor area that receives at least 1000 lx for at least 250 occupied hours per year, which must not exceed 10% of the total floor area (Cannavale et al., 2020).
- Visible light transmission (Tvis) is the portion or percentage of visible light that goes through the glazing system, as opposed to being absorbed or reflected. It is the initial “filter” for decreasing the highly dynamic and intense outdoor daylight situations to more comfortable and tempered internal conditions. Conventional glazing suggests a fixed visible light transmission that cannot be adjusted, whereas EC glass adjusts tinting in response to both the dynamic conditions outside and the variable demands of interior inhabitants (Dutta, 2018).

Independent Variables: EC Glass

Electrochromic (EC) glass is a type of smart glass that can change its optical properties, such as transparency, color, and reflectivity, in response to an applied voltage or current. There are several types of EC glasses available in the market, each with its own unique features and applications. In this research, we will focus on three types of EC glasses: Halio, Halio Black, and Sage.

Halio EC glass is a high-performance smart glass developed by Kinestral Technologies. It can transition from clear to dark in less than three minutes, providing superior solar control and privacy. Halio glass uses a proprietary electrochromic technology that allows for precise and uniform tinting across large areas (Kinestral Technologies, 2021).

Halio Black is a variant of Halio glass that has a darker tint and higher light blocking capability. It is designed for applications that require maximum privacy and light control, such as conference rooms, hotel lobbies, and healthcare facilities. Halio Black glass has a visible light transmission (VLT) of less than 1% when fully tinted, making it almost opaque (Kinestral Technologies, 2021).

Sage Glass is another type of EC glass that is known for its dynamic shading and energy-saving features. It uses a patented electrochromic technology that can tint the glass from clear to dark blue-gray, reducing solar heat gain and glare while maintaining natural daylighting. Sage Glass can also be programmed to respond to changing weather conditions, occupancy patterns, and user preferences, providing a personalized and energy-efficient indoor environment (SageGlass, 2021).

For our research, we evaluated the performance of several types of electrochromic (EC) glasses, including Halio, Halio Black, and Sage (refer to Table 1). Our objective was to test their spatial daylight autonomy (sDA) and annual solar exposure (ASE). To conduct performance simulations in Climate Studio, we employed different Tvis values for the EC glass, which are outlined in Table 1 below. These evaluations provide insights into the effectiveness of EC glass in regulating light in building designs.

Table 1: Visible light transmission (Tvis) for Halio, Halio Black and Sage

Name	Tvis0	Tvis1	Tvis2	Tvis3	Tvis4	Tvis5	Tvis6	Tvis7	Tvis8
Halio	62.5%	43.2%	30.0%	22.1%	13.9%	8.9%	7.0%	4.4%	1.5%
Halio Black	59.7%	21.6%	11.3%	2.3%	0.8%	0.5%	0.1%		
Sage	59.7%	17.3%	5.5%	0.9%					

Various intermediate tint states for EC glasses are supported in Climate Studio, since they were supplied by the manufacturer. In Table 1 above, Halio comes with one clear and eight tint states ranging from 62.5% to 1.5% visible light transmittance. Halio Black has six tint states ranging from 59.7% to 0.1%, and Sage has four tint states ranging from 59.7% to 0.9%. When the EC glass is totally tinted, the staff in the office building do not have a view to the outside.

1.0 METHODOLOGY

This study compares the daylighting performance of EC glass with different Tvis. Accordingly, a two-part window was designed. The upper and lower halves of the window have identical dimensions (1.5*3.5m; refer to Figure 1). The upper section is used to allow or redirect controlled daylight, while the lower section can fulfill the occupants' view and visual comfort requirements, particularly those sitting close to the window. Dividing the window into equal upper and lower halves enables independent control of daylight and view for each section. By incorporating electrochromic (EC) glazing, the amount of daylight entering the upper section can be regulated while maintaining an unobstructed view from the lower section. For this study, we used three types of EC Glazing and did not consider artificial lighting. To identify the optimal daylighting configuration, we tested seven different scenarios, as shown in Table 2:

Table 2: Seven scenarios designed to find the best configuration

Cases	1	2	3	4	5	6	7
Upper halves	Halio	Halio Black	Sage	Halio	Halio Black	Sage	Double glazing
Lower halves	Double glazing	Double glazing	Double glazing	Halio	Halio Black	Sage	Double glazing

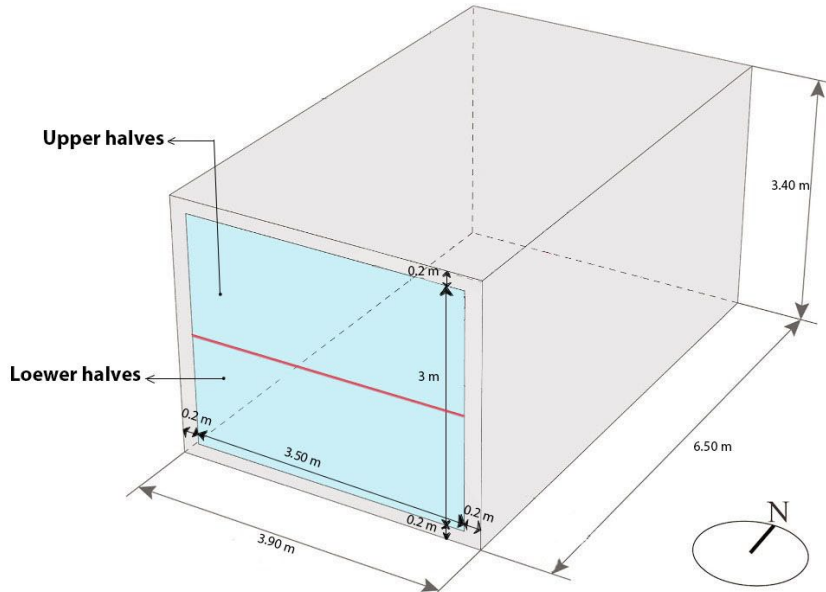
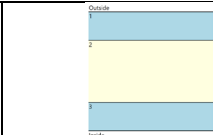

Figure 1: Dimensions of the office model Source: (Author)

To find the best configuration for the south façade among these seven configurations, sDA and ASE were computed for a perimeter office in San Antonio, Texas, and Seattle, Washington using Climate Studio to run a performance simulation for Rhino. Quantity of daylight illuminance and potential risk of excessive sunlight penetration were compared in these seven different configurations. The aim was to increase sDA while decreasing ASE for deep office spaces in San Antonio, Texas and Seattle, Washington. To study the daylight performance of office buildings in this research, all phases of simulation were developed in Rhino for modeling and for performance in Climate Studio for Rhino (see Table 3). This study models the office space and the EC glazing as well as analyzing different scenarios for EC glazing with different daylight transmissions based on the annual climate-based daylight. In the simulation process, different types of EC glass were simulated to find the optimum configuration that will provide the optimum daylight and visual comfort for the office model. The red line determines the border of upper and lower halves.

Table3: The list of key input values for the office in ClimateStudio for Rhino

Category	Input parameter	Input value
Building	Locations	San Antonio, TX
		Seattle, WA
	Orientation	South
	Geometry	3.9 m × 6.5 m × 3.4 m (length × width × height)
Material (daylighting)	Reflectance	50% (interior wall)
		20% (floor)
		30% (ceiling and south wall)
Window	 <p>1 - Clear Float Glass Clear 6 [mm] 2 - Air - EN673 13 mm 3 - Clear Float Glass Clear 6 [mm]</p>	U-Value[W/m ² K] = 2.69 SHGC = 0.703 TVIS = 0.774

2.1 Result of Daylight Simulation

Each of the EC glazing in this study was controlled independently based on the light level in the sensor located in the middle of the glass pane, at the height of 1.10m from the bottom of the glass for upper and lower glazing. As illustrated in Table 4 and 5, sDA and ASE metrics were calculated for each of the seven models for San Antonio, TX and Seattle, WA separately.

Table 4: The results of sDA and ASE for San Antonio, TX

	Case 1	Case 2	Case 3	Case 4	Case 5	Case 6	Case 7
Upper halves	Halio	Halio Black	Sage	Halio	Halio Black	Sage	glazing
Lower halves	glazing	glazing	glazing	Halio	Halio Black	Sage	glazing
Spatial Daylight Autonomy (sDA)	40.2	39.9	38.1	50.0	50.5	50.5	38.8
Annual Sunlight Exposure (ASE)	42.2	43.4	46.4	10.9	18.9	18.9	48.2

Table 4: Case 7 acts as a control simulation, as neither the upper nor lower halves had EC glazing. As shown in Table 4, the control sDA is 38.8%, while the control ASE is 48.2%. In the first daylight simulation (Case 1), the EC glazing in the upper halves and double glazing in lower halves were calculated at 40.2% sDA and 42.2 ASE. In Case 2 and 3 we can see a decreased sDA and an increased ASE. However, in all three cases the values still suggest a high potential for visual discomfort. In Case 4, the application of EC glazing in both halves improved the daylighting performance of the space while decreasing the glare to 10.9% through annual sun exposure. In Case 4, the light transmission was the same for the upper and lower halves. In this case, the optimum daylight was reached with 50.0 sDA, and visual comfort was achieved with ASE of 10.9%. In Cases 5 and 6 we have the same sDA at 50.5%, but we had an increase in ASE.

Table 5: In the first case, the upper halves of the EC glazing and lower halves of the double glazing were measured at 31.2% sDA and 30.3% ASE. However, these values suggest a high potential for visual discomfort in all three cases. Additionally, both sDA and ASE decreased in Cases 2 and 3. Case 4 showed promising results, as implementing EC glazing on both upper and lower halves led to an improvement in the space's daylighting performance. The annual sun exposure was reduced to 9.9%, effectively reducing glare. The upper and lower halves had the same light transmission, resulting in an optimum daylight of 46.8 sDA and visual comfort of 9.9% ASE. Cases 5 and 6 produced varying results. In Case 5, the sDA decreased to 38.5%, while the ASE increased to 18.9%. Conversely, in Case 6, the sDA increased to 40.5%, while the ASE increased to 19.9%. Despite these variations, the values still indicate the potential for visual discomfort in the space. Case 7 had the worst scenario, where both halves used double glazing. This resulted in a sDA of 30.8 and the highest ASE potential for glare and discomfort, measuring at 39.2.

Table 5: The results of sDA and ASE for Seattle, WA

	Case 1	Case 2	Case 3	Case 4	Case 5	Case 6	Case 7
Upper halves	Halio	Halio Black	Sage	Halio	Halio Black	Sage	glazing
Lower halves	glazing	glazing	glazing	Halio	Halio Black	Sage	glazing
Spatial Daylight Autonomy (sDA)	31.2	25.9	27.1	46.8	38.5	40.5	30.8
Annual Sunlight Exposure (ASE)	30.3	26.6	25.2	9.9	18.9	19.9	39.2

CONCLUSION

The study analyzed the impact of electrochromic (EC) glazing on daylighting performance and visual comfort in an identical office space in two different climate conditions: San Antonio, TX and in Seattle, WA. Spatial daylight autonomy (sDA) and annual sunlight exposure (ASE) were utilized to evaluate its performances.

The results showed that the use of EC glazing in both the upper and lower sections of the window significantly improved the daylighting performance of the space while decreasing discomfort glare potential. Among the cases examined, Case 4 yielded the most promising results, with an sDA of 50.0% and ASE of 10.9% for San Antonio Texas and with an sDA of 46.8% and ASE of 9.9% for Seattle, WA. In contrast, the use of double glazing without EC resulted in lower sDA values and increased potential for visual discomfort since its Tvis value is much higher than EC glass products and the value does not change depending on the amount of incoming sunlight.

Based on the findings, increasing the tint state range (i.e. Visible light transmission) can lead to an increase in spatial daylight autonomy and a decrease in annual sunlight exposure for an office space in two different climates: San Antonio and Seattle. Moreover, the study revealed that EC glazing's performance varied across different cases. Therefore, it is essential to consider the tint state range when applying EC glazing to optimize performance.

Overall, the research findings suggest that utilizing EC glazing in a building can significantly enhance daylighting performance while reducing visual discomfort. However, it is crucial to carefully consider the specific application of EC glazing, based on tint state range (T_{vis}) to optimize its performance. The study's ultimate goal is to encourage further investigation into how EC glazing considerations can be integrated into advanced design approaches, including performance and optimization.

REFERENCES

- Ardakan Malekafzali, A. (2016). Daylighting Analysis of Electrochromic Glazing and, (April).
- Cannavale, A., Ayr, U., Fiorito, F., & Martellotta, F. (2020). Smart electrochromic windows to enhance building energy efficiency and visual comfort. *Energies*, *13*(6), 1–17. <https://doi.org/10.3390/en13061449>
- Dutta, R. (2018). Modeling an Electrochromic window using a multi-criteria control strategy. *2018 Building Performance Analysis Conference and SimBuild*, 149–156. Retrieved from www.ibpsa.us
- Malekafzali Ardakan, A., Sok, E., & Niemasz, J. (2017). Electrochromic glass vs. fritted glass: An analysis of glare control performance. *Energy Procedia*, *122*, 343–348. <https://doi.org/10.1016/j.egypro.2017.07.334>
- Reynisson, H. E., & Guðmundsson, K. (2015). Energy Performance of Dynamic Windows in Different Climates Sweden School of Architecture and the Built Environment Division of Building Technology, (June).
- SageGlass. (2021). SageGlass® Dynamic Glass. Retrieved from <https://www.sageglass.com/>

Comparison of Carbon Accounting between Linked BIM-LCA Tools for Mass Timber Buildings

Giankeving Guzman Ganto¹, Valerie M. Thomas², María del Mar Ceballos³, Russell Gentry⁴

¹School of Civil and Environmental Engineering, Georgia Institute of Technology, Atlanta, GA

²School of Industrial and Systems Engineering, Georgia Institute of Technology, Atlanta, GA

³Office of Sustainability, Kennesaw State University, Kennesaw, GA

⁴School of Architecture, Georgia Institute of Technology, Atlanta, GA

ABSTRACT: Several studies have reported that mass timber buildings have lower supply chain (embodied) carbon than functionally equivalent steel and concrete buildings. Mass timber products also contain and store biogenic carbon. Taken together, it is likely that mass timber buildings will have a significantly lower environmental impact, as measured by carbon accounting, than functionally equivalent structural steel or reinforced concrete buildings. Many commercial Life Cycle Assessment (LCA) tools are available to calculate the carbon footprint of buildings. This paper explores the variation, uncertainty, and life cycle stage considerations in carbon accounting by developing an independent carbon accounting of a building and comparing the results with those of two building LCA tools which are Tally and Athena Impact Estimator. The analysis and comparison were mainly evaluated in terms of Global Warming Potential (GWP). The case study building is a small service garage with two design alternatives, a baseline building with a structural steel frame and cold-formed steel roof and a mass timber building composed of a Glue-laminated timber frame and a Dowel-laminated timber roof. The case study compares carbon accounting values from tools that integrate LCA and BIM (Building Information Modeling) models with scenarios for biogenic carbon and supply chain carbon emissions by life cycle stage. The advantages, limitations, and assumptions in each of these workflows and the associated tools are assessed. The results show that the calculation of the carbon footprints of mass timber has more variation across tools than calculations for steel buildings. Carbon accounting in Product stages, End of life, and module D are the main stages responsible for the variation. Through this work, we conclude that standardization, development, and updating of building LCA practices and building LCA databases are necessary for greater transparency and consistency of environmental impact calculations. Biogenic carbon accounting for wood products needs clarification when used for comparing a proposed design to a baseline as is often done for green certifications or the attribution of carbon credits.

KEYWORDS: Life cycle assessment (LCA), BIM-LCA integration tools, Mass Timber, embodied carbon, carbon accounting.

INTRODUCTION

The construction industry consumes 32% of resources including 12% of water and 40% energy (Yeheyis et al. 2013). As the world races to meet carbon reduction commitments by 2030 and 2050, the new and renovated buildings are an opportunity for reducing environmental impacts. Sustainable building design can use several methods to support the carbon reduction goals. It is relevant that these methods use reliable and precise information to make the sustainable design process more efficient (Bueno and Fabricio 2018).

Life-cycle assessment (LCA) is a complete method to analyze products and processes by quantifying materials and energy used and wastes released to the environment (Puettmann et al. 2021). LCA can work as a comparative tool between products and materials, but it requires LCA practitioners to follow appropriate procedures in order to have an apples-to-apples comparison (Gu et al. 2021). There are commercial tools that facilitate life cycle assessment of buildings. This paper explores the advantages, limitations, and database assumptions of Tally and Athena Impact Estimator and compares the Global Warming Potential (GWP) results with an independent carbon accounting.

Biogenic carbon is the carbon exchange between biomass products, such as wood, and the atmosphere. These products can capture CO₂ through photosynthesis and release it during decomposition or combustion (Hoxha et al. 2020). Existing building LCA tools showed important differences in carbon results mainly in how each tool considers carbon storage, biogenic carbon, and lifecycle stages (Gu et al. 2021). It is relevant to identify and assess the variables which cause differences in carbon results between tools in order to report a carbon accounting in frequent design and construction processes such as green certifications or the attribution of carbon credits. Several studies have reported that mass timber buildings have lower embodied carbon than functionally equivalent steel and concrete buildings. The paper describes the main factors of variation using a garage structure case study with a mass timber design option and a steel design option.

1.0 LITERATURE REVIEW

ISO 14040 defines Life Cycle Assessment (LCA) as a compilation and evaluation of the inputs, outputs and the potential environmental impacts of a product system throughout its life cycle. Life Cycle Assessment has a framework with four phases: goal and scope definition, inventory analysis, impact assessment and interpretation. The system boundary as part of the scope definition, indicate the building’s LCA stages included in the assessment (Figure 1).

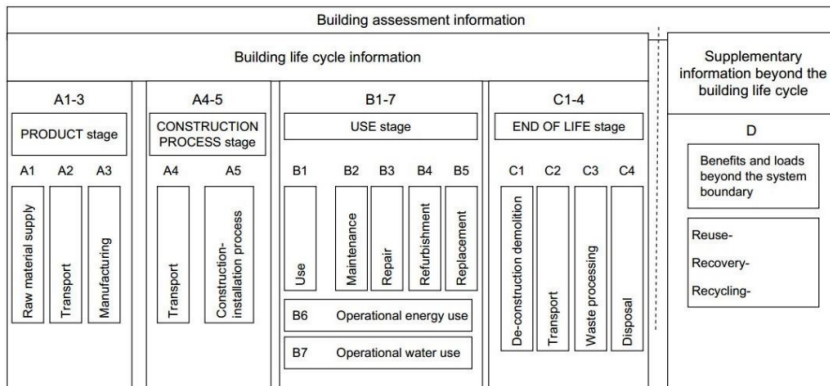

Figure 1: Life cycle stages per EN 15978:11 Sustainability of construction works — Assessment of environmental performance of buildings. Source: (Potrč Obrecht et al. 2019)

LCA is growing in interest and demand in the construction industry in order to achieve sustainable goals. As a result, practitioners are looking for simplified methods to integrate LCA into design and construction processes (Bueno and Fabricio 2018). The integration of Building Information Modeling (BIM) and LCA can improve material information of the building (Soust-Verdaguer, Llatas, and García-Martínez 2017). Graphic and non-graphic information of building elements can be stored and managed on BIM platforms (Barlish and Sullivan 2012). The methods and tools that integrate BIM and LCA in early stages of the design can help the construction material selection for ensuring environmental benefits (Ajayi et al. 2015).

Previous life cycle assessments of buildings have used a mixture of tools such as Autodesk Revit, Athena Impact Estimator, Excel, Dprofiler, and SimaPro (Soust-Verdaguer, Llatas, and García-Martínez 2017). The BIM-LCA integration tools adapted to the US region are Green Building Studio, One Click LCA, and Tally (Bueno and Fabricio 2018). It is relevant to point out not just the benefits but also the limitations of BIM-LCA integration tools. Some of the limitations are data interoperability among different tools and rigid BIM elements regarding material selection (Stadel et al. 2011). Apart from that, the environmental results can vary from tool to tool as it showed in the five whole building life cycle assessments using mass timber products (Kwok et al. 2019)

An Environmental Product Declaration (EPD), known as a type III environmental declaration, is a standardized and LCA-based device to convey the environmental impact of a product (Grahl B and Schmincke E 2007). EPDs use life cycle assessment to measure and report various environmental categories. The main input for producing EPDs is LCA database, an EPD will be as reliable as the LCA database it applies (Bergman and Taylor 2011). There are several databases (e.g., Gabi, Athena LCI, Ecoinvent, US LCI, etc.) to perform LCA which means that consistency is a current constraint when mixing them (Palumbo et al. 2020). Despite having this limitation, EPD and LCA are transparent processes that require steady development and updating of LCA data (Bergman and Taylor 2011).

Mass timber products as a structural material are an option to reduce greenhouse gas emissions from making a product or building (Li, Rismanchi, and Ngo 2019). Wood products capture carbon dioxide from the environment through photosynthesis which makes these products a carbon sink (Duan, Huang, and Zhang 2022). Some studies consider that the carbon sequestered by wood products would go back to the environment if the product was incinerated or decayed. Assumptions, uncertainties in the data, and end-of-life scenarios can affect the carbon accounting of mass timber buildings (Robati and Oldfield 2022).

2.0 RESEARCH METHODOLOGY- CASE STUDY

The research methodology of the paper is based on a case study. The case study has two design options which were modeled in a Building Information Modeling Tool. The following workflow (Figure 2) represents the main inputs and outputs of each tool, it states the advantages, limitations, and assumptions identified in the application of these building LCA tools for the case study. The global warming potential (GWP) results are evaluated in a comparative analysis.

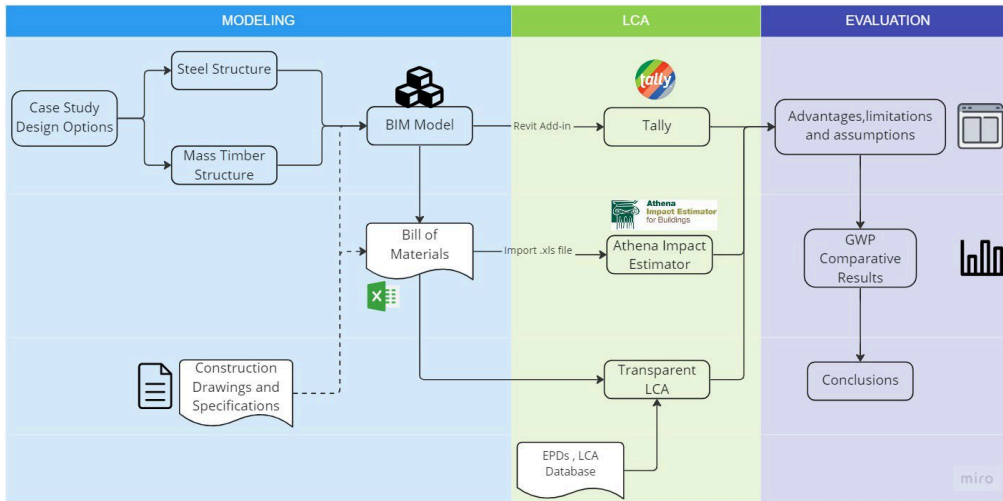

Figure 2: Research Methodology workflow. Source: Created by the author.

The case study building selected for the LCA is a small service garage with a gross area of 1018 square feet (40.7'x25'). Besides the gross area, the garage was designed with a significant cantilever area of 912 square feet. The case study is an on-campus building that will store an important asset for the university. The service garage has structure and finishing elements, however, the scope of the study is focusing only on the structure. The baseline design is business as usual which includes a structural frame and cold-formed steel. The mass-timber option is composed of a glulam frame and a Dowel-laminated timber roof (Figure 3). Both options have the same concrete foundation which makes the superstructure the only difference between the two.

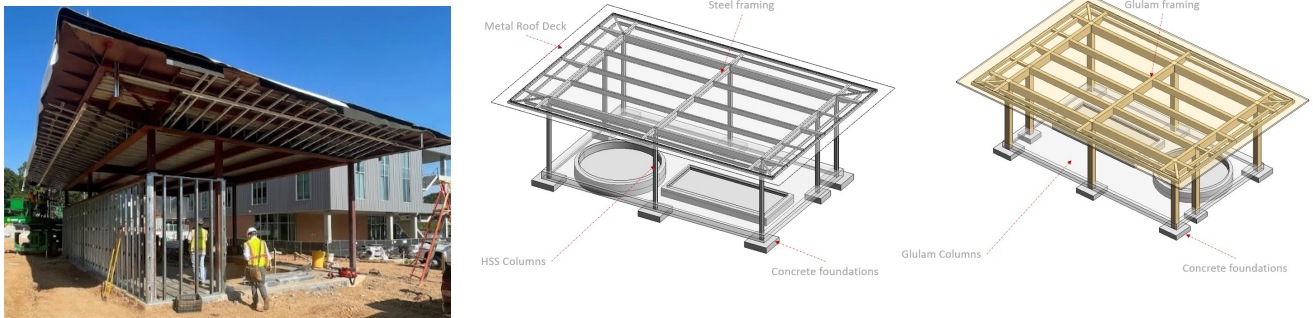

Figure 3: Garage case study under construction and the isometric representation of the two design options: Steel Structure and Mass Timber Structure. Source: Created by the author.

2.1 Bill of Material Take off

Both options of the structure were modeled on Autodesk Revit 2023. The list of materials on Table 3 as part of the Independent Life Cycle Assessment represents the quantity of required materials in each design option. The units used for each material are aligned with the functional or declared units on the Environmental Product Declaration (EPD). ISO 21930 defines functional unit as “quantified performance of a product system for use as reference unit in an EPD based on LCA”. Based on that reference, the unit for concrete and wood material is cubic meter (volume). All the steel elements are measured in metric ton (weight).

3.0 LIFE CYCLE ASSESSMENT METHODS

3.1. LCA on Tally

The case study used a commercial version of Tally 2023 (2022.04.08.01) which works as a plug-in for Revit 2023. Tally utilizes GaBi 8.5 database for LCA modeling and reports environmental impacts according to the Tool for the Reduction and Assessment of Chemical and Other Environmental Impacts (TRACI) 2.1.

Tally works within the Revit Environment, and it has a user-friendly interface (Bueno and Fabricio 2018). The LCA modeling in Tally starts with matching the Revit materials already used in the project with one of the options of the Tally database. The quantity take-off is automatically assigned from the Revit parameters. After the material matching, Tally has the option to include or exclude Biogenic Carbon and edit the transportation distances if the user has specific information to refine the default values.

3.2. LCA in Athena Impact Estimator for Building

Athena Impact Estimator for Building (Version 5.4.01) uses its own LCA database to calculate a Life Cycle Inventory and the TRACI methodology to perform a life cycle impact assessment (Bowick, O’connor, and Meil 2014).

The building information such as location, life expectancy, and floor area are the first input to create a project. All the project elements can be created using the assembly option on Athena, or the bill of materials can be imported from an external source. Athena includes a waste factor for the quantity of material which varies from 1%-5% according to the material type.

Table 1: Advantages, limitations and assumptions of Tally and Athena Impact Estimator.

	<i>Tally 2023 (2022.04.08.01)</i>	<i>Athena Impact Estimator (Version 5.4.01)</i>
LCA Methodology	TRACI (Tool for the Reduction and Assessment of Chemical and Other Environmental Impacts)	
Database	GaBi 8.5	Athena LCI / US LCI / Ecoinvent
Advantages	<p>Tally materials are for the whole building (structure, envelope, and finishing)</p> <p>The input of the bill of material is automatically taken from the BIM model.</p> <p>The system boundary includes all of the life cycle stages except B1 (use), B7 (Operational water), and C1 (Demolition). A5 (Construction Installation) and B6 (Operational Energy) are optional stages that work as input from external sources.</p> <p>Not previous LCA modeling experience required.</p>	<p>The system boundary includes all of the life cycle stages except B1 (use), B3 (Repair), B5 (Refurbishment), B7 (Operational water), and C3 (Waste processing). The life cycle stage B6 (Operational Energy) is optional that works as input from external sources.</p>
Limitations	<p>Material customization is limited. Specific EPD cannot be updated by the user.</p> <p>There is not DLT nor NLT as part of the Engineered Wood materials on the Tally database. CLT was used as the most proxy.</p>	<p>Athena database’s scope includes structural and envelope materials but not interior finishing materials.</p> <p>It is possible to define the elements within Athena’s interface but the quantity of material will not be as accurate as importing specific measures from an external source (e.g. excel sheet)</p> <p>Specific EPD cannot be updated by the user.</p> <p>There is not DLT nor NLT as part of the Engineered Wood materials on the Tally database. CLT was used as the most proxy.</p>
Reference EPD	American Wood Council EPD	CORRIM data for US
Wood- End of Life Assumption	14.5% Recovered 22% Incinerated with energy recovery 63.5% Landfilled (wood product waste)	Recycling (10%) Combustion (10%) Landfilling (80%)

3.3. Independent LCA

The independent carbon calculation uses Environmental Production Declarations (EDPs) of the materials used in the case study (concrete, rebar, different types of steel, Glulam and DLT) and other LCA data. The functional unit is the building, and the system boundary is limited to the product stages (A1-A3). In choosing the most suitable EPDs available, technical features, and geographic representation (Table 2), the straightforward carbon calculation is the product of the Global Warming Potential declared on the EPDs by the quantity of materials used in the case study (Table 3).

Table 2: Environmental Product Declarations suitable for the case study materials.

Source	Product Description	Location	Source Type	Unit	Impact	Unit	System Boundary
EPD- Thomas Concrete	Mx 407-1FS / 4000 PSI at 28 days	Atlanta	Product Specific	1m3-Concrete	218		
EPD-Concrete Reinforcing Steel Institute	Reinforcing bar	North America	Industry Average	1 metric ton	854		
EPD-AMERICAN INSTITUTE OF STEEL CONSTRUCTION	Steel Plate	US	Industry Average	1 metric ton	1730		
EPD-Steel Deck Institute	Steel Roof and Floor Deck	US	Industry Average	1 metric ton	2320		
EPD-AMERICAN INSTITUTE OF STEEL CONSTRUCTION	Hollow Structural Steel Section	US	Industry Average	1 metric ton	1990		
EPD-STEEL TUBE INSTITUTE	Hollow Structural Steel Section	US	Industry Average	1 metric ton	1710		
EPD-AMERICAN INSTITUTE OF STEEL CONSTRUCTION	Hot rolled Structural Steel Sections	US	Industry Average	1 metric ton	1220		
EPD-METAL BUILDING MANUFACTURERS ASSOCIATION	Hot rolled Structural Steel Sections	US	Industry Average	1 metric ton	1468		
CORRIM REPORT-LCA for SE Products	Glue Laminated Timber	SouthEast,US	Industry Average	1m3	135.06		
EPD-StructureCraft	Dowel Laminated Timber	CAN	Product Specific	1m3	121.4		

Table 3: Global Warming Potential of the case study based on the EPDs.

Component	Material	Unit	Mass Timber			Steel Structure		
			Quantity	KgCO ₂ -eq/Unit	GWP(KgCO ₂ -eq)	Quantity	KgCO ₂ -eq/Unit	GWP(KgCO ₂ -eq)
Foundations	Concrete	m3	22.86	218	4984.4	22.86	218	4984.4
	Reinforced Rod	metric Ton	1.60	854	1366.4	1.60	854	1366.4
Column	Hollow Structural Steel	metric Ton	0		0.0	3.16	1850	5841.1
Beams	Hot Rolled Structural Steel	metric Ton	0		0.0	3.70	1344	4974.4
Roof	Steel Plate	metric Ton	0		0.0	1.21	1730	2095.6
	Metal Deck	metric Ton	0		0.0	1.49	2320	3466.8
Column and Beams	Glulam	m3	15.10	135	2039.2	0		0.0
Roof	DLT	m3	15.84	121	1922.5	0		0.0
					10312	22729		

The biogenic carbon in the EPDs for Glulam and DLT are in accordance with ISO 21930 which characterizes the net biogenic carbon emissions across the reported system boundary is zero (carbon neutral). This assumption does not consider the sequestration of biogenic carbon. To illustrate this sequestration, the carbon and carbon dioxide are calculated as follows:

Data:

- Dry density of Glulam: 548 kg/m³ (American Wood Council EPD)
- Dry density of DLT: 449 kg/m³ (StructureCraft EPD)
- % Carbon as weigh of wood product: 50%

Calculation:

- Stored CO₂ per kg of wood product = $0.5 \frac{kgC}{kg\ of\ wood} \times \frac{44\ kgCO_2}{12\ kgC} = 1.83 \frac{kgCO_2}{kg\ of\ wood}$
- Stored CO₂ per unit volume of Glulam = $1.83 \frac{kgCO_2}{kg\ of\ wood} \times 548 \frac{kg}{m^3} = 1003 \frac{kgCO_2}{m^3}$
- Stored CO₂ per unit volume of DLT = $1.83 \frac{kgCO_2}{kg\ of\ wood} \times 449 \frac{kg}{m^3} = 822 \frac{kgCO_2}{m^3}$
- Total Stored CO₂ for the case study = $1003 \frac{kgCO_2}{m^3} \times 15.1\ m^3 + 822 \frac{kgCO_2}{m^3} \times 15.84\ m^3 = 28,2\ metric\ Ton\ CO_2$

The end-of-life scenarios of the wood will affect the net biogenic carbon emissions (Feitel, Redwine, and Kingsley 2021). Table 1 shows different wood end-of-life assumptions for Tally and Athena Impact Estimator. The comparative results section will show the variation per life cycle stage of wood products.

4.0 GWP COMPARATIVE RESULTS

The carbon emission for the steel structure of the case study shows a variation with an A-C system boundary, but it is uniform when module D is included in both building LCA tools. For the mass timber structure, there is more variation between tools in both system boundary scenarios.

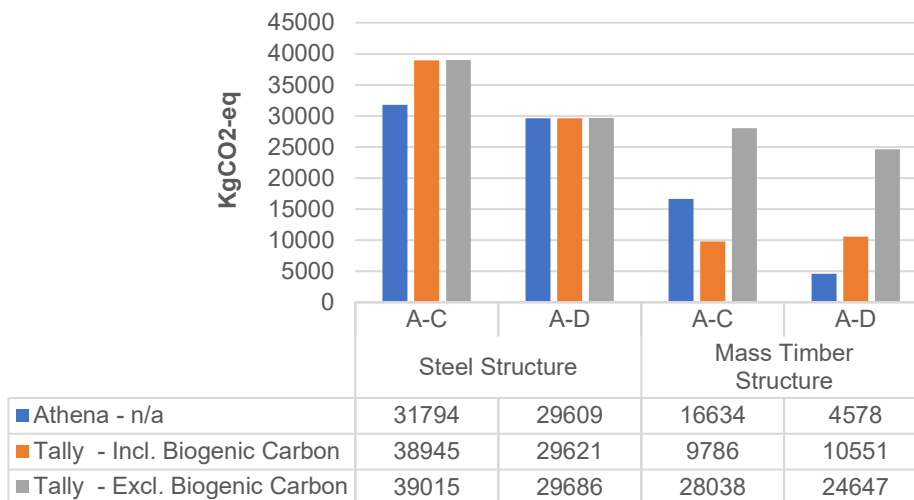

Figure 4: Global warming potential results of the steel structure (left) and mass timber structure (right) across life cycle stage scenarios.

At a building material level, wood materials have more effect on the variation than concrete materials (Figure 5). For wood, the product, end-of-life, and module D stages are mainly responsible for the variation. Since Athena puts the carbon sequestration in Module D, if we define the system boundary from A-C, the carbon emissions from Athena will be more conservative than Tally including Biogenic Carbon but less conservative than Tally excluding Biogenic Carbon.

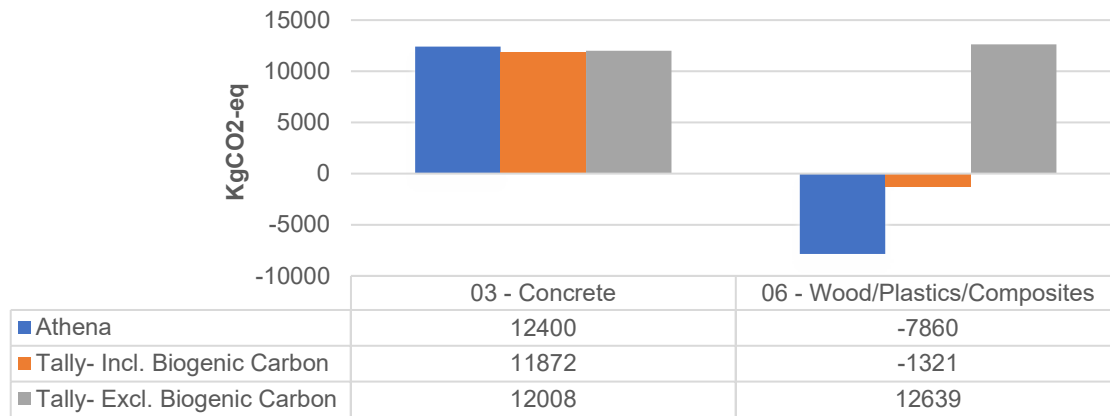

Figure 5: Global warming potential results of the Mass Timber structure per type of material. A-D System boundary.

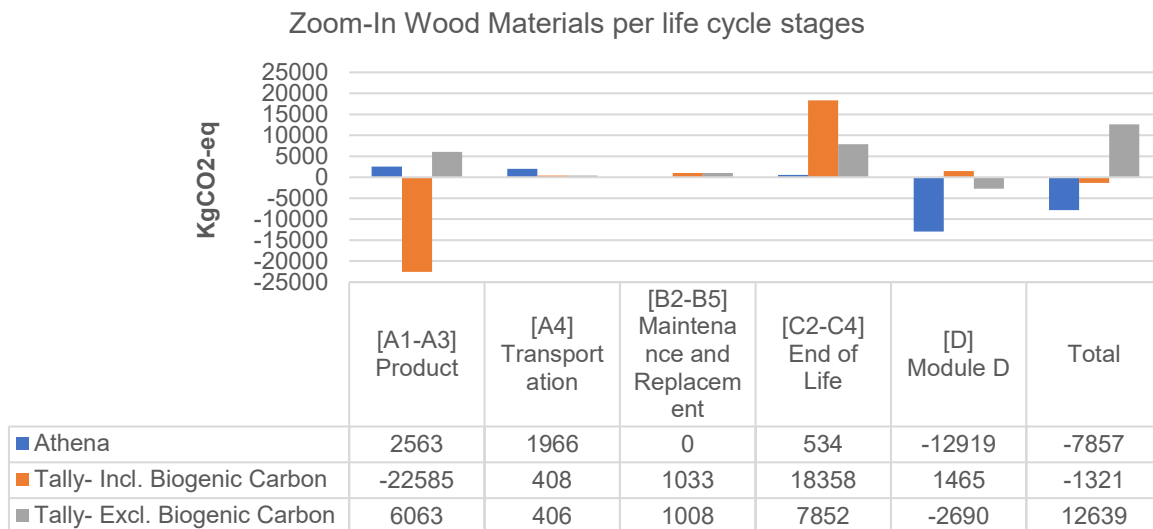

Figure 6: Global warming potential results of the wood products per life cycle stages.

In order to eliminate the quantity of material as a factor of the variation, 1m3 of Glue Laminated Timber is modeled in both building LCA tools. Figure 7 shows clearly the material selection for Glue Laminated Timber in both tools. The results show the same behaviour of the case study. We can conclude that the variation of mass timber carbon accounting is mainly because the database behind each LCA tool and different assumptions on the material end-of-life.

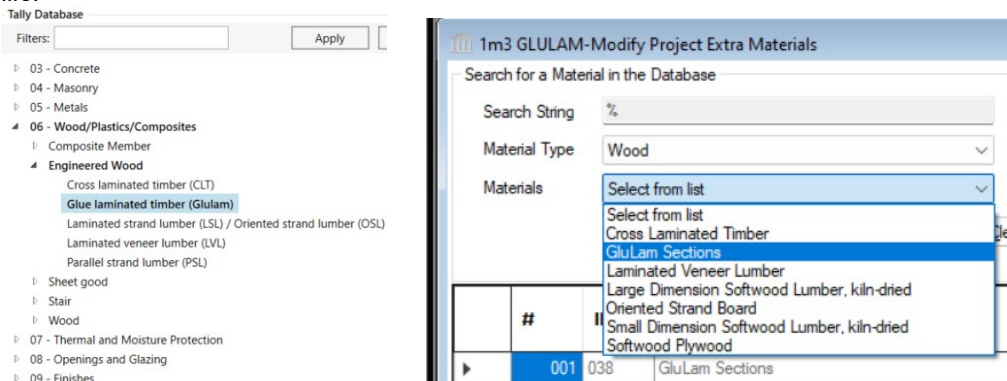

Figure 7: Wood material selections on Tally (left) and Athena (right) for 1m3 of Glue Laminated Timber. Source: Created by the author

The comparison of the GWP results of Tally and Athena with the independent calculation based on EPDs and LCA data has as a system boundary the Product stages (A1-A3). It's clear that mass timber structure is more beneficial in terms of environmental impacts than steel structure in the product stages for the small service garage. Apart from Tally including the biogenic carbon as a negative value in the product stage, it is relevant to point out that the independent carbon accounting reports less carbon than Tally and Athena Impact Estimator. This is mainly because the independent carbon accounting works with product specify and industry average EPDs most suitable to the technical and geographic features of the case study. On the other hand, Tally and Athena use mixed and generic data sources.

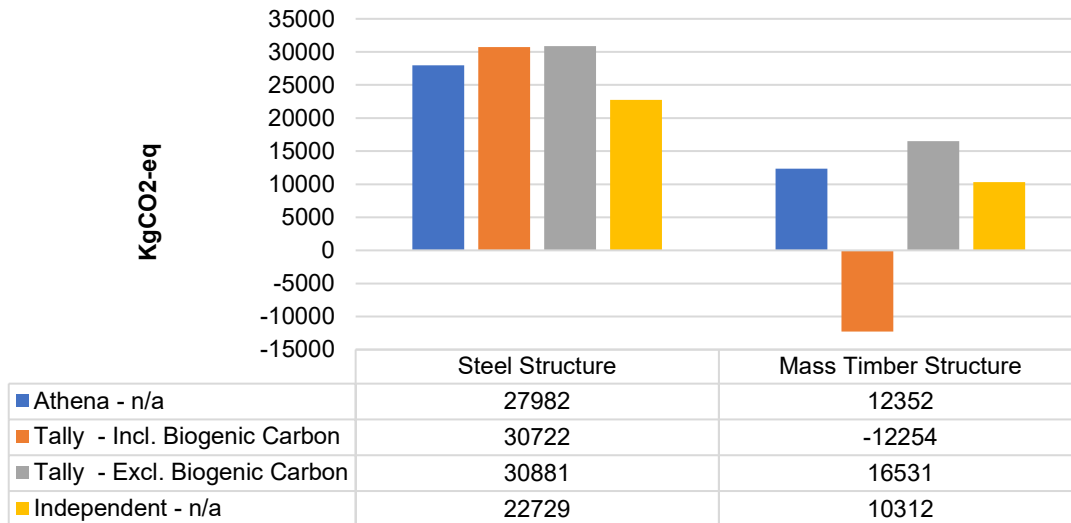

Figure 8: Product Stage (A1-A3) GWP results of building LCA tools and an independent calculation.

CONCLUSION

This paper contributes to sustainable building practices by detailing and analysing the main factors behind the variation of GWP results across the most popular commercial LCA tools for buildings. The steel structure has less variation than the mass timber structure across the building LCA tools. For the mass timber structure, the product stages, end-of-life stage and module D are mainly responsible for the variation between tools. Choosing the system boundary of building life cycle assessment whether A, A-C or A-D will affect the GWP results. There are important differences in the global warming potential results reported by Tally and Athena Impact Estimator. The tools use different LCA databases. For the mass timber structure, the tools assume different wood end-of-life scenarios. Buildings have the opportunity to storage carbon through using wood products mainly because they can capture CO2 from the atmosphere. As a result of that, an appropriate calculation for biogenic carbon needs to be identified and implemented uniformly across tools.

Our research contributes on how the advantages, limitation and assumptions of the building LCA tools can impact on the GWP results of building life cycle assessments. Tally and Athena Impact Estimator have limited options for customization regarding the material selection by the end-user. For mass timber products, neither tool has Dowel-Laminated Timber as an option within wood products (Figure 7). The ability for flexible material selection is critical for reliable results. Then building LCA practitioners should have all the construction documents and specifications to choose the most appropriate materials from the available LCA database. On the other hand, the tools could be used during the design process to measure the environmental impact of different materials where the reliability of the assessment will depend on the accuracy of the information provided.

The results of the building LCA tools and the independent calculation supports that the mass timber structure has lower global warming potential than the steel structure in the product stages (A1-A3). Athena Impact Estimator pushes the carbon sequestration to Module D, the independent calculation based on EPDs follows the zero biogenic carbon emission, and Tally has the option to include or exclude biogenic carbon. While there is need for consistency among tools, the overall comparison indicates that mass timber structures have potential to reduce greenhouse gas emissions in the construction industry.

The independent calculation indicates less carbon than Tally and Athena Impact Estimator. This is mainly because the independent calculation used data most suitable to the technical and geographic features of the case study. On the other hand, Tally and Athena use mixed and generic data sources. Greater standardization, development and updating of building LCA practices and building LCA databases will support reliable results in carbon accounting of building.

ACKNOWLEDGEMENTS

We would like to express our appreciation to the Office of Infrastructure and Sustainability at the Georgia Institute of Technology for generously letting us use the Reck garage as case study . We would also like to extend our thanks to all the members of the Georgia Sustainable Building Materials Technical Advisory Committee for their valuable feedback throughout the entire process. Their expertise and dedication have greatly enriched our research and helped us to better understand the complex issues surrounding sustainable building materials.

REFERENCES

- Ajayi, Saheed O., Lukumon O. Oyedele, Boris Ceranic, Mike Gallanagh, and Kabir O. Kadiri. 2015. "Life Cycle Environmental Performance of Material Specification: A BIM-Enhanced Comparative Assessment." *International Journal of Sustainable Building Technology and Urban Development* 6 (1): 14–24. <https://doi.org/10.1080/2093761X.2015.1006708>.
- Barlish, Kristen, and Kenneth Sullivan. 2012. "How to Measure the Benefits of BIM - A Case Study Approach." *Automation in Construction* 24 (July): 149–59. <https://doi.org/10.1016/j.autcon.2012.02.008>.
- Bergman, Richard, and Adam Taylor. 2011. "Product Declarations for Wood Products-An Application of Life Cycle Information about Forest Products." *Forest Products Journal* 61 (3).
- Bowick, Matt, Jennifer O'connor, and Jamie Meil. 2014. "Athena Guide to Whole-Building LCA in Green Building Programs Contributing Authors." www.athenasmi.org.
- Bueno, Cristiane, and Márcio Minto Fabricio. 2018. "Comparative Analysis between a Complete LCA Study and Results from a BIM-LCA Plug-In." *Automation in Construction* 90 (June): 188–200. <https://doi.org/10.1016/j.autcon.2018.02.028>.
- Duan, Zhuocheng, Qiong Huang, and Qi Zhang. 2022. "Life Cycle Assessment of Mass Timber Construction: A Review." *Building and Environment*. Elsevier Ltd. <https://doi.org/10.1016/j.buildenv.2022.109320>.
- Feitel, Alexis, Bob Redwine, and Greg Kingsley. 2021. "Platte Fifteen Life Cycle Assessment."
- Grahl B, and Schmincke E. 2007. "The Part of LCA in ISO Type III Environmental Declarations." *Int J Life Cycle Assess* 12(1), 38–45.
- Gu, Hongmei, Shaobo Liang, Francesca Pierobon, Maureen Puettmann, Indroneil Ganguly, Cindy Chen, Rachel Pasternack, Mark Wishnie, Susan Jones, and Ian Maples. 2021. "Mass Timber Building Life Cycle Assessment Methodology for the U.S. Regional Case Studies." *Sustainability (Switzerland)* 13 (24). <https://doi.org/10.3390/su132414034>.
- Hoxha, Endrit, Alexander Passer, Marcella Ruschi Mendes Saade, Damien Trigaux, Amie Shuttleworth, Francesco Pittau, Karen Allacker, and Guillaume Habert. 2020. "Biogenic Carbon in Buildings: A Critical Overview of LCA Methods." *Buildings and Cities* 1 (1): 504–24. <https://doi.org/10.5334/bc.46>.
- Kwok, Alison, Hannah Zalusky, Lindsay Rasmussen, Isabel Rivera, and Hannah McKay. 2019. "Cross-Laminated Timber Building: A WBLCA Case Study Series."
- Li, Jiehong, Behzad Rismanchi, and Tuan Ngo. 2019. "Feasibility Study to Estimate the Environmental Benefits of Utilising Timber to Construct High-Rise Buildings in Australia." *Building and Environment* 147 (January): 108–20. <https://doi.org/10.1016/j.buildenv.2018.09.052>.
- Palumbo, Elisabetta, Bernardette Soust-Verdaguer, Carmen Llatas, and Marzia Traverso. 2020. "How to Obtain Accurate Environmental Impacts at Early Design Stages in BIM When Using Environmental Product Declaration. A Method to Support Decision-Making." *Sustainability (Switzerland)* 12 (17). <https://doi.org/10.3390/SU12176927>.
- Potrč Obrecht, T., R. Kunič, S. Jordan, and A. Legat. 2019. "Roles of the Reference Service Life (RSL) of Buildings and the RSL of Building Components in the Environmental Impacts of Buildings." In *IOP Conference Series: Earth and Environmental Science*. Vol. 323. Institute of Physics Publishing. <https://doi.org/10.1088/1755-1315/323/1/012146>.
- Puettmann, Maureen, Francesca Pierobon, Indroneil Ganguly, Hongmei Gu, Cindy Chen, Shaobo Liang, Susan Jones, Ian Maples, and Mark Wishnie. 2021. "Comparative Lcas of Conventional and Mass Timber Buildings in Regions with Potential for Mass Timber Penetration." *Sustainability (Switzerland)* 13 (24). <https://doi.org/10.3390/su132413987>.
- Robati, Mehdi, and Philip Oldfield. 2022. "The Embodied Carbon of Mass Timber and Concrete Buildings in Australia: An Uncertainty Analysis." *Building and Environment* 214 (April). <https://doi.org/10.1016/j.buildenv.2022.108944>.
- Soust-Verdaguer, Bernardette, Carmen Llatas, and Antonio García-Martínez. 2017. "Critical Review of Bim-Based LCA Method to Buildings." *Energy and Buildings*. Elsevier Ltd. <https://doi.org/10.1016/j.enbuild.2016.12.009>.
- Stadel, Alexander, Jonathan Eboli, Alex Ryberg, James Mitchell, and Sabrina Spatari. 2011. "Intelligent Sustainable Design: Integration of Carbon Accounting and Building Information Modeling." *Journal of Professional Issues in Engineering Education and Practice* 137 (2): 51–54. [https://doi.org/10.1061/\(ASCE\)EI.1943-5541.0000053](https://doi.org/10.1061/(ASCE)EI.1943-5541.0000053).
- Yeheyis, Muluken, Kasun Hewage, M. Shahria Alam, Cigdem Eskicioglu, and Rehan Sadiq. 2013. "An Overview of Construction and Demolition Waste Management in Canada: A Lifecycle Analysis Approach to Sustainability." *Clean Technologies and Environmental Policy*. Springer Verlag. <https://doi.org/10.1007/s10098-012-0481-6>.

Critical Material Regionalism

Susannah Dickinson¹

¹University of Arizona, Tucson, AZ

ABSTRACT: The following paper presents an upper division architecture studio integrating critical thinking with material design research; focusing on the extraction, processing, fabrication and maintenance for construction and the relationship to regional ecologies. Why as a society and academy are we not more focused on the actual materials we are using in design when their impact on climate change is so apparent? The larger question that the class sought to unravel was; can architecture actually be sustainable and how can this terraforming of the earth to make shelter for humans be in synthesis with our planet rather than destroying it? This submission focuses on proposals for expanded knowledge and pedagogical processes about the role, use, value and impact of materials in architecture, locally and globally with the goal of moving us forwards in more sustainable ways. Also, the paper addresses what are the pedagogical and design implications when we focus initially and centrally on material ecologies rather than just incorporating materials as a de-facto later stage part of the design process?

KEYWORDS: Pedagogy; Design as Research; Critical Practice; Sustainability; Regional Materials.

INTRODUCTION

Pre-industrialized urban form was generally constrained by specific geographical locations and their carrying capacity, determined by the availability of resources and shelter (Wang et. al., 2020). Since industrialization and increasing globalization, most developing cultures have increasingly supported more out sourcing of products, including building materials. This has meant that our buildings and cities worldwide have generally become more heterogeneous and less environmentally tuned, due to less focus on place-based design and the use of local materials. The construction industry is one of the largest consumers of natural resources in the world, being responsible for 50% of the carbon emissions recorded since the 1950's (Adriaanse et al.1997) yet the potential tie between the use of sustainable materials and the construction industry is completely underdeveloped. Improving the symbiosis between our local environmental ecologies, natural and designed, and social systems of shelter, including the supporting physical infrastructure, was the goal of this class, with the larger aim of moving forwards as a society in a more systematic, sustainable direction. The socio-environmental opportunity that will get us to a more sustainable future is: how can our human built environment and its various infrastructural systems and networks connect and work more symbiotically with each other and those of nature rather than working in opposition to each other? System-based design modeling aims at synthesizing solutions from complex scenarios and multiple strands of data. The design research studio sought to develop dynamic scenarios that linked human and ecological systems to foster the optimization and expansion of both.

1.0 CRITICAL PRACTICE AND CRITICAL REGIONALISM

While there is no desire (or time or space) to create a universal manifesto of architecture¹. It seems apt to refer to some theoretical underpinnings and relationships of the studio pedagogy. With the focus on a local region, there is an obvious relationship to the theory of Critical Regionalism², which arose out of past concerns about globalization and lack of what some saw as a meaningful architectural direction. The pedagogical development of this theory, from the authors perspective, is the additional complexity which various technological developments and realities of the Anthropocene and climate change bring into the equation. The Anthropocene nuances the relationship of nature and culture (they are not dichotomies) and blurs the boundaries of much of our geographical regions, which in reality were often cartographic lines of control in the first place. Our advancements with technology have enabled us to understand and connect more scales and boundaries in a literal physical way, from the microscopic to the pervasive satellite imagery, which can oft show some more invisible phenomena, like urban heat island effects, but this technology has also changed our cultural relationship to each other, not just the planet, through social media and the ability to connect in cultural groups that are less bounded by geographical limits. These changes, developments and insights imply that regionalism is not static and it's various boundaries are complex phenomena that need to be re-evaluated and have different meanings and geographic and ecological realities depending on what is at stake or in question. The additional development of philosophies like New Materialism, Complexity Theory and Posthumanism add even more into the equation. Beyond local materials and regions there is also the concept of criticality and critical practice. Simply put, this is work that seeks to change the current status quo, not necessarily as an opposing force, but an acknowledgement of global issues of concern, which may or may not be addressed effectively by our various cultures³. Being completely local in a literal sense should not be the goal in our inter-connected globalized world. So, what does this all mean to the pedagogy of an architectural studio?

2.0 STUDIO PEDAGOGY AND METHODOLOGY

We obviously have some pressing issues at present as a human race; the goal of the studio was to frame some of these wicked problems primarily under the auspices of sustainability, in a hopefully deep way, rather than just green-washing. The paradox of wicked issues is that they are complex to solve, but their focus, revealing and study is fundamentally important to the academy and beyond. The focus of the studio on actual physical materials, at multiple scales, was the first introduction to this particular student cohort to the concepts and connections that the selection of a material in their designs can have in a detailed way: understanding that the choice is not neutral, but has profound and often damaging connections to the regional and global world around us. Students were conscious of some architectural environmental certification programs, like LEED and Passive house, plus were aware of concepts like life-cycle assessment etc., but generally these were understood in fairly superficial ways, rather than factoring in more externalities of the environment, politics, and labor like for example emergy models can (Odum 1995, Srinavassan and Moe, 2015).

The following work is from B.Arch students in their final year of their professional program at a state, land grant institution. In the final three semesters of the undergraduate professional program, students are now focused in research clusters, this one being based on 'Material Matters', with various classes taught by different faculty, and in this particular case including some design-build studios. The work disseminated here is from their capstone project, which is over the final two semesters; the first semester is a 3-credit preparatory seminar with the second semester being a 6-credit studio. The examples are from the first iteration of this class and this new research focus within the School of Architecture. As the student numbers were particularly large, both the seminar and studio were co-taught with an additional faculty member in addition to the author, in this particular case by two different faculty members, one for each class per semester, see the acknowledgements for more detail.

Initially the first assignment introduced various technical and theoretical texts and just required the students to produce some form of expression in a physical form to pronounce where the students' particular frame of reference was coming from, or a particular issue of concern that they had. This was challenging for many students as it was the first time that many had not been prescribed a format or media or specific analysis to study i.e. they needed to have a point of view. The range of examples was a chance to see where everyone's abilities, knowledge and ethics lay within the studio framework, and for many, although often abstract, pointed to individual's architectural positions and issues of concern.

Then students began with the selection of a local, regionally sourced building material or potential building material, investigating their properties, site-locale, life-cycles and fabrication techniques to help build deep knowledge of the matter that architecture is made of. Selection of materials was the choice of individual students, but initially some background readings and input by material and ecological experts was given to understand that some are ultimately more sustainable than others. This was not to imply that using a local material is always appropriate or the answer; there should be an awareness of the implications and costs of using any materials, apart from the energy used in their transportation. The regionality of the studio also gave the students an opportunity to dive deeply into the local ecologies, histories and climates. Wood and bio-materials are the only renewable materials, so they were obvious choices, but some chose to focus on earth-based materials such as masonry, adobe, caliche and clay; steel and other metals and concrete, in it's typical mix were avoided, due to their negative environmental impacts, although the extraction sites and processing of these materials did factor into some student's work. In a couple of instances students switched their material choice later in the semester, but most stayed with their initial, individual choices.

The choice of initially working with the micro scale of a material, was a conscious pedagogical decision, and a flipping of the traditional studio format where materials are often given less agency. Apart from enabling students to use their empirical knowledge skills in iterative testing in quantitative and qualitative ways, it also enabled an initial focus and direction in an otherwise complex issue (Figure 1). Although students chose this micro focus, pedagogically it was imperative to also work on a regional scale of mapping and data collection in tandem (Figure 2). Obviously this multi-scalarity was not always literally concurrent, but each assignment required some accounting at multiple scales as deliverables. This gave students the opportunity to make connections from the molecular to the territorial (Ibañez et al, 2019), and enable the important iterative and reflective design process to emerge. Design of our built environment has historically been the realm of the construction, planning and building industries, there is a pressing need to start researching our building materials across multiple scales, understanding the networks and flows of the connections in order to engage broader more sustainable research on the reshaping of our built environment, embodied energy and complex externalities. Too often architects are trained or work in silos, where the perceived boundaries are limited beyond the actual energetic and cultural realities.

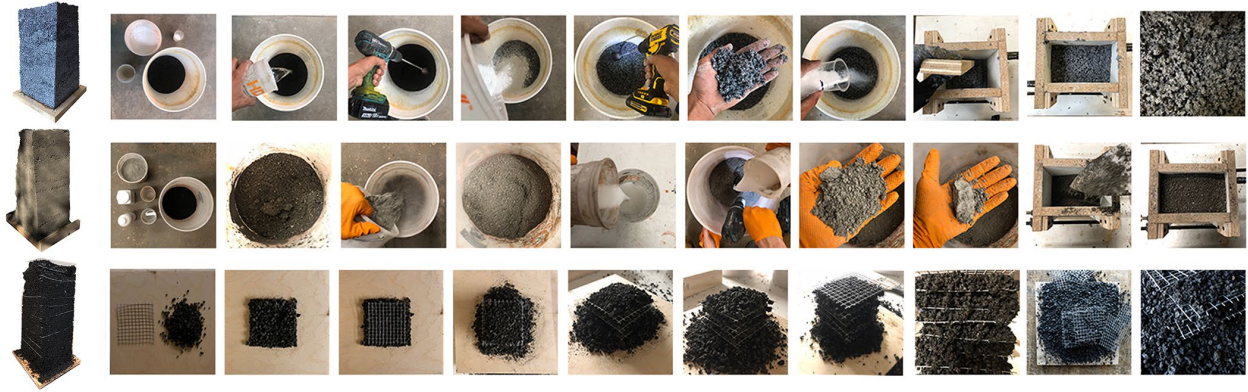

Figure 1: Research showing 3 types of scoria from top to bottom; lime scoria, geopolymer scoria with fly ash and mechanically stabilized scoria (Jacob Downard, 2021)

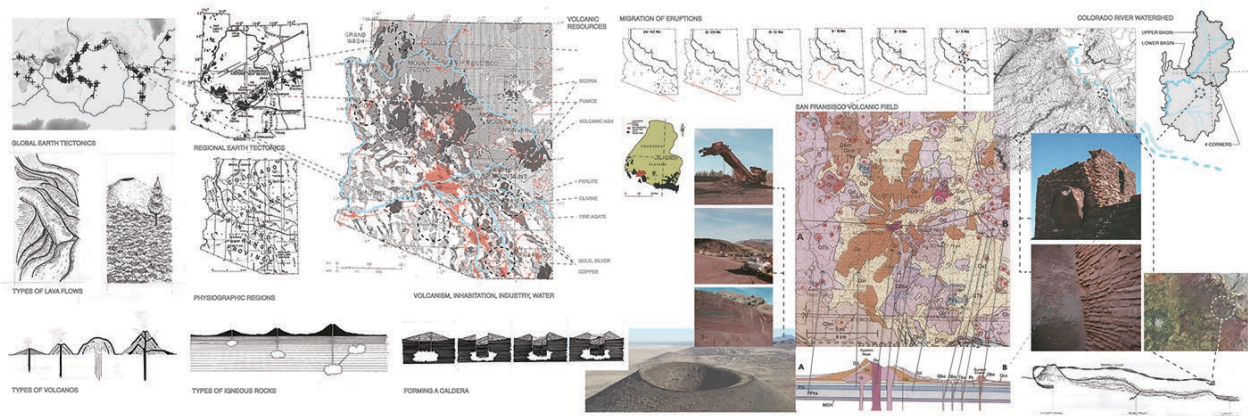

Figure 2: The same student from Figure 1 above, showing his initial work on understanding scoria as a part of a broader subject of volcanism; it's geological processes and regional specifics. (Jacob Downard, 2021)

In our complex world, it is important to factor in as many parameters of reality as possible into the design equation, if we are to see and reveal our impact of material choices. Each student is different and has different biases and backgrounds. From experience students and designers tend to work in or between one of two extremes; those that start off with something very simple and then they need to add in layers of complexity to enrich their project, or those that work initially with complex levels of ideas and information and often ultimately have to prioritize or simplify some of their work to enable a design or focus to emerge. This focus on a material enabled both extremes to succeed, but also meant that regardless they had to work in a connected, iterative way. Most of the larger, macro scale work was done with mapping and more theoretical research, although physical field trips were part of the class. This mapping was enabled by geographic information system (GIS) and other digital workshops, and lectures by other faculty at the University with specialties beyond those of the instructors. Apart from learning ways of extracting big data related to material choices, it was also critical to start understanding physical geologies and ecologies in order to work with appropriate boundary conditions and to begin to understand the spatio-temporal relationships. For example, readings and mapping of environmental biomes were required, which related to where specific trees and plants grew or where appropriate soil conditions existed, these also invariably tied into climate data with specific geo-locations. With all students the introduction of climate change and geologies processes introduced the concept of adaptation and change over time which de-concretized information and place into more plastic realities, students began to see the connections and complexities between varying scales and nuances of climates and terraforming over time (Figure 3).

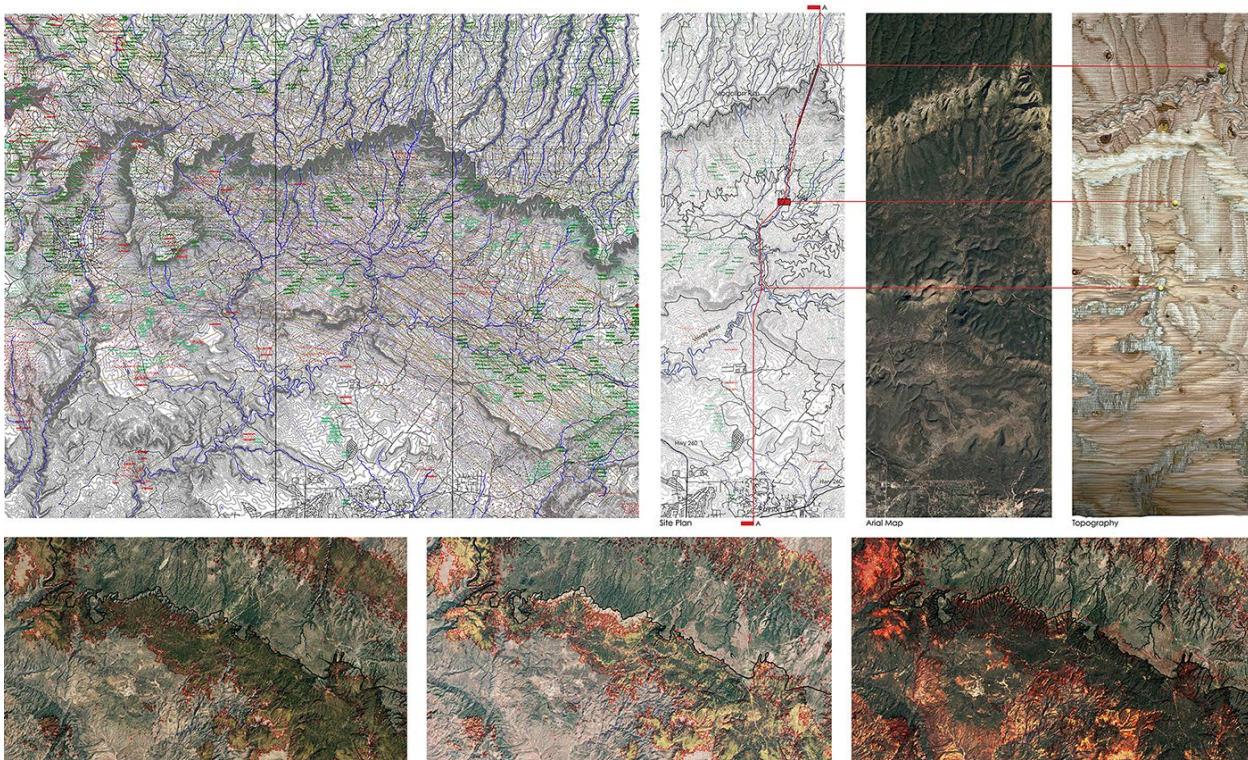

Figure 3: Upper row: various representational techniques of Mogollon Rim, on left showing connection to wildlife movement. Lower row: mapping showing presence of alligator juniper trees in 1983, 2020 and projection of 2050. (Daniel Cazarez, 2022)

Student’s work was encouraged to emphasize dynamic natural systems, adaptability, resiliency, and inter-connectivity. Appropriate representation of these aspects is also key. Media and the way ideas and work were represented needed to be designed as well as the content. Typical cartesian methodologies of representation have been critiqued if we hope to move forwards in new more sustainable ways (Moe, 2019). The use of actual materials, often at full scales, helped in this aspect of representation and abstraction. The mapping exercises, that started off often in more traditional 2D formats needed to be more nuanced and developed. Appropriated techniques, often from other fields like landscape architecture, were encouraged to increase a sense of time in their studies. Also, it was important for students to understand that maps and data are not neutral (Kurgan, 2013), whether by bias, manipulation or censorship, so understanding sources and looking at sometimes more invisible or harder to find aspects of sites and regions were imperative to be more inclusive and critically focused e.g. pollution, climate change, digital infrastructure, social inequity etc. That all being said satellite imagery has its place, once biases are understood, in comprehending and democratizing large scale formations and patterns of the earth.

Beyond mapping and data, parametric digital design and fabrication methods were also developed. Digital fabrication is considered to be the most disruptive advancement in the construction industry since the industrial revolution. Now advanced systems of additive and subtractive fabrication are becoming smaller, cheaper, faster and therefore more accessible to more groups. The ability to produce in large quantities irregular building components with the same ease as standardized parts has introduced the notion of mass customization into building design, fabrication and construction. In many cases it is just as easy and cost-effective for a CNC milling machine to produce 1000 unique objects as to produce 1000 identical ones. This means that for the first time in history we can now make the shift from mass production to mass customization. This ability to customize means that we can now achieve site and environmentally specific optimized forms in architecture, which are built affordably with factory production quality specifications (Dunn, 2012; Parmar & Dickinson, 2018). This ability to now make affordable, bespoke forms of architecture and construction that are more energy efficient and climatically adaptable, means for example that trees that are less-uniform in their form (i.e., not literally tall and straight), like smaller diameter lumber, which is often the by-product of thinning for wildfire prevention, can be utilized in ways that industrialization previously ignored. (Monier, 2013; Kolarevic & Parlac 2015; Layton, 2021). The cost and increasing portability of CNC tools also means these can be utilized on the ground by community groups (Risen, 2018), in the form of scanning and photo cataloguing the complexities of the real and the actual future bespoke fabrication, (Figure 4).



Figure 4: Example of photogrammetry technique on wood branch: (Taylor Forsberg, 2022)

3.0 FINAL RESULTS

The complexity of our material ecologies and processes needed to be understood, which gave students agency at multiple levels to create more diverse, resilient designs and methodologies. Some results were more speculative than others, but each needed to be grounded in some sense of physical reality, which generally meant that an understanding of human culture's impact and relationship to environmental issues needed to be addressed in some way. Most students, given the chance, care deeply about the future of the planet, so this ability to connect beyond a typical building site, to start to address our wicked problems was empowering to all. In depth looking, seeing what is actual there and how we got where we are is an exercise in itself, with the added goal of some kind of project or process that could hopefully improve and bring awareness to our issues of concern. The following discusses two specific examples out of the eighteen projects completed.

Wildfires have become more frequent and more devastating due to climate change and are becoming an increasing global issue of concern beyond the natural, more historic, regenerative realities. These fires affect the environment and wildlife in multiple ways, plus have an increasing impact on our built environment and its infrastructure. One particular student, Riley DeSpain, had worked as a fire-fighter during the past summer so had seen this devastation up close, which was in part the reason for selecting small diameter ponderosa pine. Currently this material, that if not put to use soon after a wildfire, becomes a hazard that wildland firefighters are sent out to chop up and burn during winter months. Prescribed burns of small diameter ponderosa pine forests can aid larger sized trees in reaching their maximal growth, therefore, creating better usable lumber. This method has been historically the most efficient solution to continue supplying the lumber industry with the larger diameter trees. However, this carries negative social, economic, and environmental consequences. One problem is that small diameter timber can drive larger wildfires, which creates soil and erosion conditions that promote flooding to sometimes occur. When major wildfires burn, they leave behind slick burned out soil that is unable to absorb water like healthy soil. After researching the many wildfires in Arizona from the past few years, Flagstaff became the area of focus for Riley's project, due to its cultural and social prioritization of the outdoors. The Mount Elden area is located directly north of Flagstaff, which was affected by a large, 2000 acre fire, the Museum Fire in 2019, which affected this popular recreation area. The United States Forestry Service (USFS) has since taken action and implemented a planning project to rebuild the area, aimed at developing a trail system while responding to ongoing negative impacts from unsustainable recreation on forest resources. The desired condition is a trail system that provides diverse opportunities for recreation activities, while balancing the forest's needs. The project aimed at creating architectural interventions at specific points along the trail, providing places for observation, reflection and celebration; challenging people to integrate, interact and approach their environment in a new way. Highlighting views of the area and the Museum Fire scar, the project allows the occupants to reflect on the devastation the fire caused and appreciate the parts that are still green and healthy. The project aimed at utilizing the in-situ, small diameter lumber, with simple construction tools and methods on site, so USFS crews could rehabilitate the trails with this material, as an alternative to the pile burns, which currently occur (Figure 5).

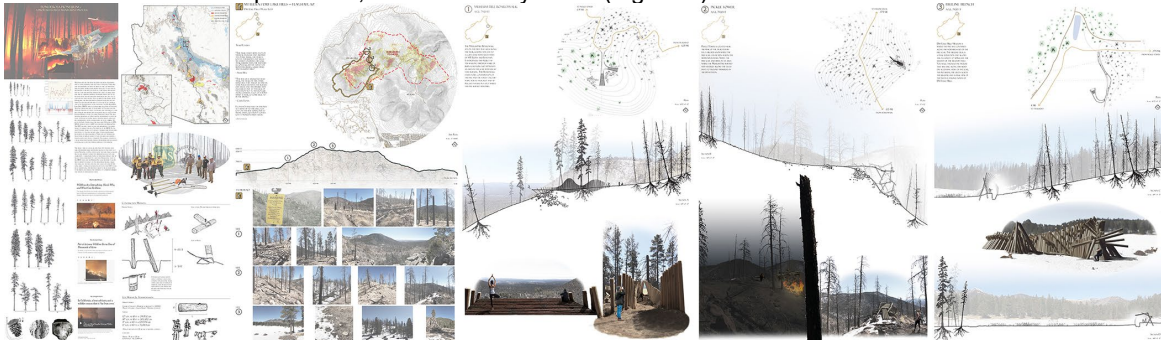

Figure 5: Example of final studio presentation on small diameter ponderosa pine, *Ponderosa Pioneering*: (Riley DeSpain, 2022)

Kiel Moe and Oliver Curtis have speculated on how architects can aim at more than just reducing environmental impact; Instead, timber building raises the possibility of maximizing (positive) environmental impacts through design. For example, by extending this analysis further through cooperation among foresters and architects, acting as trans-scalar designers, it is conceivable to estimate how tree harvesting and timber buildings would increase overall carbon storage at the forest level, as well as enhance key aspects of biodiversity. If this construction system analysis were extended to forestry cycles more directly, then adjusting the intensity of harvesting in a specific place could have a carbon increase over time (Moe and Curtis, 2019, 133).

Another student decided to study the material mycelium. Mycelium is the microscopic root structure of fungi. These long roots, known as hyphae, grow one cell at a time and are only one cell wide, but when millions of these long roots, known as hyphae, grow together it is strong enough to bind organic material, making what we call mycelium composite materials. These composite materials can be grown with any form of fungi, although characteristics will differ, and only require a cellulose rich substrate and a relatively small amount of water. The example student, Rafael Taiar, concluded that city of Phoenix, Arizona produces over 223 thousand tons of paper waste every year, which could be the cellulose substrate. Speculating that with the right type of fungus, mycelium composite materials could be used as an alternative more sustainable building material in that climate, plus providing a more circular economy with the use of cardboard waste.

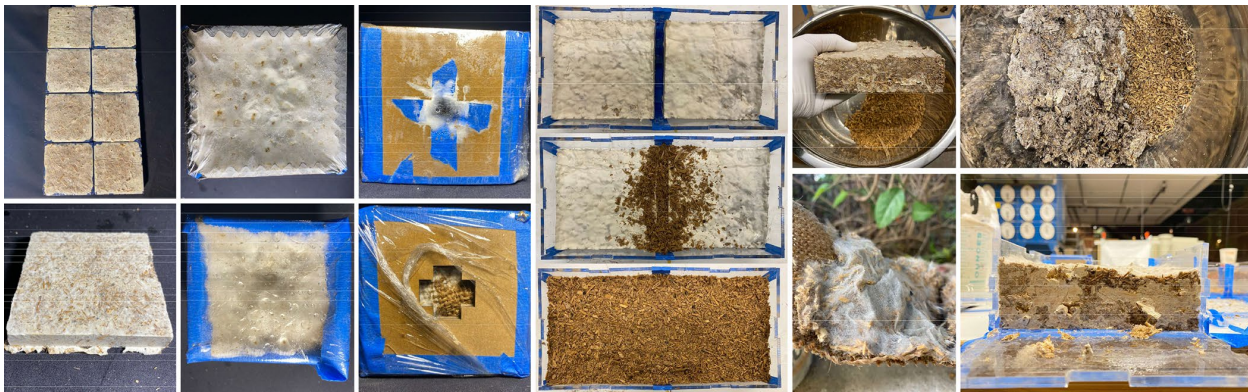

Figure 6: Studies of various mycelium growth with various cellulose substrates: (Rafael Taiar, 2021)

He suggested after research and tests to use the fungal species *Podaxis Pistillaris* as it was native to the Sonoran Desert and fruits during the rainy seasons (Figure 6). His project proposed the use of cardboard waste in combination with this species of fungus to create a multi directional building block. These blocks would initially be held together by cardboard rods that connect their cores until the material has grown, developed and strengthened. With time, the mycelium will incorporate the cardboard, and in contact with rain or water will produce new mushroom spores that can be used to grow more blocks. He speculated that this circular system could minimize the transportation of building materials and construction waste and allow for every construction to be the source of materials for the next, empowering people to take ownership of their futures through the fabrication and experimentation with mycelium composites (Figure 7).

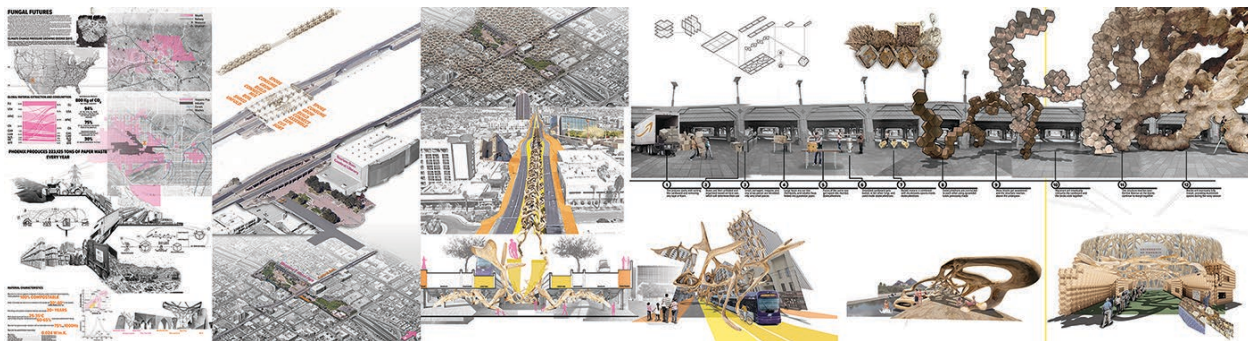

Figure 7: Example of final studio presentation on mycelium, *Fungal Futures*: (Rafael Taiar, 2022)

One of the interesting discussions at the final review of the above mycelium project focused on the idea that architecture can be formless, and can be about setting up a process that could organically grown in more informal ways across our urban environments rather than the typical top down approaches one sees today. This continual adaptation over a relatively fast period of time also goes beyond the old dichotomies of tectonic and stereotomic forms.

CONCLUSIONS, NEW QUESTIONS AND FUTURE DIRECTIONS

The ability to connect and work in multiple scales and ecologies in a meaningful way; understanding architect's and architecture's role in the problems and potential solutions is imperative moving forwards. We need to look at these wicked problems however complex. The academy, research and teaching methods should be about raising questions and critical thinking rather than business as usual. That being said obviously some courses are more speculative than others. This was fairly open and flexible to allow individual students agency in their position, hopefully related to their future career interests. Although different from typical studio projects where a site and program are given, there was great variety in the projects, from those that had more of a speculative, purely research, revealing agenda to those that essentially wanted and had comfort in a more typical architectural resolution, often for their portfolios. This need/desire for a more typical architectural project is an open question, particularly in state-based institutions where the range of student abilities is often large, and the realities of each student achieving a high level of success and contributing to research in the field at an undergraduate level is perhaps a little unrealistic, especially depending on their prior curriculum and training. It seems to have real change students need to be more aware of these concepts and methods from day one of their education. With such a range of student abilities it is a challenge to get the balance of prescribed and more open assignments for students, on reflection there should have been slightly more control over the weaker students at the beginning to clarify certain tests, inquiries, methods and dissemination were completed in appropriate ways.

As this was a first pass at a course focused around materials, it would be great to put together a more cohesive program over the three semesters, to enable students to have a full bag of tools coming into this final project, and ideally as mentioned to revise the entire curriculum to get more sustained, meaningful work which could have some direct impacts on research and community-based projects. At this high level it is important to get collaborations with other fields, as collaborators during the design process. It would be great to ultimately merge some more lab protocols with the studio, regardless it was exciting to see actual materials being speculated upon and tested in more sustainable directions, especially after the remote world of covid. This work and it's connection to applied sustainable research has already inspired some grant applications around these local issues, which can hopefully result in more impactful, real ways. This regional, more local approach to materials is obviously transportable to other regions and climates throughout the world.

ACKNOWLEDGEMENTS

I would like to thank the School of Architecture at the College of Architecture, Planning, and Landscape Architecture at the University of Arizona, which gave me the opportunity to teach this capstone class in the inaugural year of our new format. I would also like to thank all the faculty involved in the Material Matters cohort, but particularly Dan Hoffman and my two co-teachers, Jesus Robles and Sheehan Wachter. Lastly, I would like to thank all the participating students who made this all possible.

REFERENCES

- Adriaanse, A. and World Resources Institute, eds. 1997. *Resource Flows: The Material Basis of Industrial Economies*. Washington, D.C: World Resources Institute.
- Bean, J., Dickinson, S., and Ida, A., eds. 2020. *Critical Practices in Architecture: The Unexamined*. Cambridge Scholars Publishing; UK, Spain and Germany.
- Dunn, N. 2012. *Digital Fabrication in Architecture*. London, UK: Laurence King Publishing
- Eggner K. 2002 " Placing Resistance: A Critique of Critical Regionalism" in Journal of Architectural Education, May 2002, Vol. 55, No. 4. pp 228-237.
- Frampton, K. 1983, "Towards a Critical regionalism: Six Points for an Architecture of Resistance," in *The Anti-Aesthetic: Essays on Post-Modern Culture*, ed. Hal Foster. New York: The New Press, 17-34.
- Ibañez, D., Hutton, J., and Moe, K., eds. 2019. *Wood urbanism: From the molecular to the territorial*. Actar Publishers, New York and Barcelona.
- Kolarevic, B & Parlac, V. 2015. *Building Dynamics: Exploring Architecture of Change*. United Kingdom: Taylor and Francis.
- Kurgan, L. 2013. *Close Up at a Distance: Mapping, Technology and Politics*. New York: Zone Books
- Layton, P. 2021. *Annual Report 2021*. Wood Utilization and Design Institute, Clemson University. <https://www.clemson.edu/centers-institutes/wud/documents/2021-annual-report-final.pdf>
- Moe, K. 2019. "Nonlinear Perspective" in Log, Fall 2019, No. 47, Overcoming Carbon Form, pp 118-130
- Moe, K and Curtis, O, 2019. " Specific Carbon" in *Wood urbanism: From the molecular to the territorial*. Actar Publishers, New York and Barcelona.
- Monier, V., Bignon, J. C., & Duchanois, G. 2013. Use of irregular wood components to design non-standard structures. In *Advanced materials research* (Vol. 671, pp. 2337-2343). Trans Tech Publications Ltd.
- Odum, H.T. 1996. *Environmental Accounting, Emery and Decision Making*. New York: Wiley
- Parmar, R. & Dickinson, S. 2018. "Critical Wikihouse: Connecting GIS Data to Site and Tiny Home Design." Proceedings of The Architectural Research Centers Consortium and European Association for Architectural Education, ARCC - EAAE 2018 International Research Conference, Architectural Research for a Global Community, 406-14.
- Rendell, J. 2020. Foreword and Postscript, "From Critical to Ethical Spatial Practice" in *Critical Practices in Architecture: The Unexamined*. Cambridge Scholars Publishing; UK, Spain and Germany.

Risen, C. 2018, July 12. "A fantastical take on timber construction." *Architect: The journal of the American institute of architects*. https://www.architectmagazine.com/awards/r-d-awards/citation-limb-a-fantastical-take-on-timber-construction_o

Srinivasan, R. and Moe, K. 2015. *The Hierarchy of Energy in Architecture – Energy Analysis*: New York: Routledge.

Wang, W., Jiao, L., Zhang, W., Jia, Q., Su, F., Xu, G., and Ma, S., 2020. "Delineating urban growth boundaries under multi-objective and constraints." *Sustainable Cities and Society*, Vol 61, 102279.

ENDNOTES

¹ Keith Eggener's "Placing Resistance: A Critique of Critical Regionalism" essay appropriately warns about imposing top down manifestos on local culture.

²As mentioned by Alexander Tzonis, Liane Lefaivre in the Pomona Meeting Proceedings, ed Amourgis, S., 1981 and Kenneth Frampton

³ See Jane Rendell's foreword and postscript, "From Critical to Ethical Spatial Practice" in Bean, J., Dickinson, S., and Ida, A., eds. 2020. *Critical Practices in Architecture: The Unexamined*.

Energy Performance Simulation for 3D Concrete Printed Houses

Chengde Wu¹, Shelby Doyle¹, Nick Senske¹, Pete Evans¹

¹Iowa State University, Ames, IA

ABSTRACT: 3D Concrete Printing (3DCP) is an emerging design and construction technology. Many industry and research efforts have focused on the software, hardware, and material developments of the field. Additional research avenues remain available, such as energy performance simulation methods specific to 3DCP. The hypothesis of this research is that 3DCP wall assemblies can perform as well as wood-frame houses designed for cold climates such as ASHRAE zone 5 and this claim can be evaluated through design, simulation, and analysis. This paper investigates the energy performance of 3DCP walls with different wall assemblies and insulation materials as a method for calibrating design and construction detailing. The simulation results are compared with the energy performance of conventional wood frame houses. The results show that 3DCP can achieve the same or better energy performance compared to conventional wood frame constructions with properly designed thermal breaks and appropriate insulation material.

KEYWORDS: 3D Concrete Printing, R-value Simulation, Energy Simulation, Thermal Bridge

INTRODUCTION

3D printing technology was first patented in 1981 by Hideo Kodama and developed into stereolithography by Charles Hull in 1983. In 1997, 3D Construction Printing was established and then became known as Contour Crafting (Pan et al. 2021). It then took until 2014 to complete a set of full-scale residential buildings with 3D construction printing (Wu et al. 2016). Since then, many advances and developments have continued that claim the benefits of 3DCP including reducing waste, labor, environmental impacts, and construction time (Wu et al. 2016). However, today, the use of this technology in the building industry is still in a nascent state and limited to proprietary materials and machines. Building codes only mention 3DCP technology in the 2021 International Building Codes as Appendix AW which refers to the first attempt at evaluating 3D Construction Printing. This outline, UL 3401 published in 2019, includes several equivalencies and standards to allow for this construction typology but limited the application of this technology to each jurisdiction and specific material mix and machine utilized in the process. In 2022, ISO/ASTM presented a draft standard, ISO/ASTM DIS 52939, a comprehensive international standard for the “production and delivery of high quality additively manufactured structures.” However, this rapidly developing environment around 3DCP has not developed an understanding of the environmental performances in diverse climatic conditions. This paper aims to illustrate a methodology around energy simulation for a better understanding of 3DCP technology.

1.0 RESEARCH FRAMEWORK

1.1 Research questions

Studies have shown that 3DCP walls present many challenges to energy conservation. As an example, Suntharalingam (2021) simulated 32 different configurations of 3DCP wall patterns, with and without cavity insulation, and concluded that the best performing U-value was 0.34 W/m²K (R-16.9), which does not meet the IECC (International Energy Conservation Code) standard for ASHRAE zone 5A and colder which requires a wall R-value of 20 (International Code Council 2021). Therefore, with the growing interest and rapid adaptation of 3DCP technologies, the research in this paper aims to investigate the following research questions:

- How do 3DCP houses perform in energy consumption compared to conventional wood frame houses?
- How can 3DCP houses achieve energy performance that meets the IECC standards and Passive House recommended metrics?
- What are the primary factors that affect 3DCP energy performance?

1.2. Research goal

The goal of this research is to investigate the energy performance of 3DCP houses. The goal can be achieved by 1) assessing R-values and thermal bridges of various 3DCP wall assemblies, 2) simulating the energy consumption of 3DCP houses and comparing them with wood frame houses, and 3) suggesting high-performing 3DCP wall assemblies.

1.3. Research methodology

To analyze the energy performance of 3DCP walls, this study primarily employs computational methods to simulate construction outcomes. Firstly, the authors identified various 3DCP wall assemblies through literature review and design interventions. The R-values and the thermal bridging effects of the 3DCP walls are then simulated with THERM, a software application developed by the Lawrence Berkeley National Laboratory which is a U.S. DOE Office of Science National Laboratory managed by the University of California. The 3DCP walls are then applied to a conventional wood-frame three-bedroom house design to conduct comparative whole-house energy consumption simulations in ClimateStudio + Rhino. ClimateStudio is an environmental performance analysis software for the Architecture, Engineering, and Construction (AEC) sector that is a plug-in for McNeel Rhinoceros, a freeform surface modeler that utilizes NURBS mathematical models. The results are then analyzed to identify critical factors for designing high-performing 3DCP wall assemblies.

1.4. Research Scope

The primary areas of operational energy consumption of buildings are heating, cooling, lighting, ventilation, hot water use, and plug load (Pérez-Lombard et al. 2008). To make the comparison between 3DCP and wood-frame wall assemblies consistent, the simulation results in this study focus on heating and cooling loads and assume all other factors maintain constant. This study only focuses on the energy performance of 3DCP walls. 3D printing of other building components, such as foundation and roof, will be researched in future studies. The foundation in this study is assumed to be poured concrete and the roof assemblies are conventional wood truss frames.

Many experimental 3DCP house projects are located in warm and/or dry climates where the indoor/outdoor temperature difference is relatively small or condensation is not a concern. Additionally, much 3D printing work is occurring in industry rather than academic spaces. The result is that there is little research literature on cold weather 3DCP.

To better understand how 3DCP houses can perform in cold and humid climates, we set the climate zone to ASHRAE Zone 5 for the simulations. Zone 5A has an average minimum temperature between -15°F to -20°F (-26°C to -29°C). Zone 5B has a low minimum temperature between -10°F to -15°F (-23°C to -26°C). Zone 5 is considered 'cold' because it has significantly more heating degree days than cooling degree days - about 6,000 (°F-days) heating degree days and 1,000 cooling degree days meaning that residences in this zone require a high level of operational heating energy to maintain indoor comfort (International Code Council 2021). A *degree day* compares the mean (the average of the high and low) outdoor temperatures recorded for a location to a standard temperature, usually 65°F (18°C) in the United States. The more extreme the outside temperature, the higher the number of degree days. A high number of degree days generally results in higher levels of energy use for space heating or cooling (EIA 2022).

Heating Degree Days (HDD) are a measure of how cold the temperature is on a given day or during a period of days. For example, a day with a mean temperature of 40°F has 25 HDD. Two such cold days in a row have a total of 50 HDD for the two-day period. *Cooling Degree Days* (CDD) are a measure of how hot the temperature is on a given day or during a period of days. A day with a mean temperature of 80°F has 15 CDD. If the next day has a mean temperature of 83°F, it has 18 CDD. The total CDD for the two days is 33 CDD (Thom 1959).

2.0 DESIGN INTERVENTION

This section describes the identified design interventions for 3DCP wall assemblies. The hypothesis is that 3DCP wall assemblies can perform as well as wood-frame houses designed for cold climates such as ASHRAE zone 5 and this claim can be evaluated through design, simulation, and analysis. When compared to standard concrete construction, 3DCP can reduce costs by eliminating formwork and automating labor to dramatically reduce construction time. However, the high embodied carbon of concrete and the poor energy performance of 3DCP wall assemblies remain under-addressed (Bukkapatnam 2017).

The use of concrete has impacts on both the embodied and operational carbon of buildings. Embodied carbon is the amount of carbon emitted during the making of a building. Manufacturing Portland cement accounts for approximately 5% of the anthropogenic CO₂ emissions worldwide and about 2% of total CO₂ emissions in the United States (Hanle 2004). As a construction material, cement production is one of the largest CO₂ emitters. Operational carbon is the amount of carbon emitted during the operational or in-use phase of a building. This includes the use, management, and maintenance of a product or structure. Operational carbon from buildings currently accounts for 28% of global Green House Gases (Architecture2030 2022).

This paper focuses on reducing operational carbon through the design, simulation, and eventual construction of high-performance 3D printed residential wall assemblies. For the purpose of this work, high performance is defined as the reduction of heating and cooling loads of a simulated house. To begin, the authors surveyed several case studies of existing 3D printed concrete wall assemblies, then modeled these wall assemblies and simulated the R-values of these assemblies to identify where to focus design interventions. Results indicated that several commonly used reinforcement methods for 3D concrete construction led to thermal bridging and energy performance that did not meet IECC code minimums in ASHRAE zone 5. Thermal bridging occurs when a conductive or poorly insulating material allows a low

resistance pathway for heat flow across a thermal barrier. Figure 1 shows two common 3DCP walls with thermal bridges.

Although the tieback concrete beads and steel rebars are beneficial for maintaining structural integrity, they form highly conductive thermal bridges that lead to energy loss and potential condensation. Thermal bridging can be mitigated by using less conductive materials for tensile strength such as fiber reinforcement bars or integrating reinforcement directly into the 3D print mix (e.g., GFRC). Other options include increasing the mass of the wall assembly through the greater thickness or introducing high-performing insulation materials such as EPS, XPS, and spray foam. A third strategy is to design thermal breaks into the wall assembly. This strategy involves placing a material with low thermal conductivity in an extrusion with the purpose of reducing the flow of thermal energy. For example, a thermal break at window opening is expected to effectively reduce energy loss compared to the common wall detail where concrete beads are continuous from outside to inside forming a thermal bridge (Figure 2). These findings informed the design intervention and the wall designs that the research team identified to simulate.



Figure 1: A concrete bead ties together the exterior and interior 3d printed walls (left, image source: Suntharalingam 2021) and standard steel reinforcement to tie together the exterior and interior 3d printed walls (right) Source: PERI

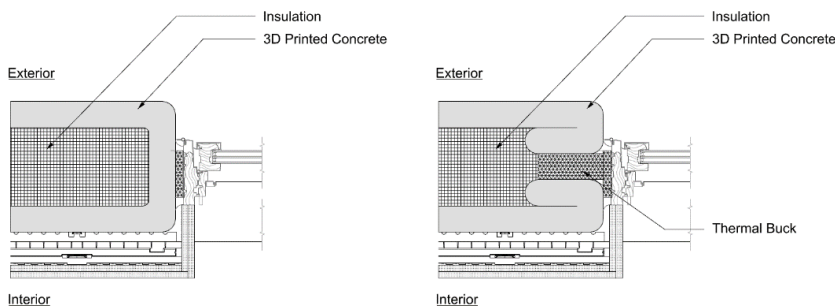

Figure 2: Window detail with concrete beads as a thermal bridge (left) and a detail with thermal break (right). Source: Authors

3.0 SIMULATIONS

Heat transfer through building envelope occurs in three forms, conduction, convection, and radiation. Walls lose or gain heat only through conduction and infiltration (as a form of forced convection). Both the selection and installation of materials impact heat transfer. Heat loss from infiltration is uncontrolled air leakage through joints in the construction and cracks around windows and doors. In the winter, the cold air that infiltrates the building is equal to the amount of hot air that escapes. Computational simulation does not currently accurately account for infiltration without experimental data and this can lead to large differences between the simulated assembly, installed assembly, and post-occupancy performance. Understanding how different assemblies and insulation materials impact the R-values of 3DCP walls is essential to holistically understand the energy performance of 3DCP houses. This section investigates the R-values of various wall assemblies and insulation materials through computational simulations and compared them with wood framing wall constructions. The authors also investigated how different wall assemblies affect overall building energy consumption in heating and cooling at the whole-building level.

3.1. Input parameters for R-value simulation

R-value simulations of various wall assemblies were carried out using THERM, a software that is used to model two-dimensional heat-transfer effects in building components. The required input parameters for THERM include boundary conditions, 2D sectional geometries, and thermal properties of materials. The boundary conditions of the simulations in this paper are shown in Table 1, following ASHRAE Fundamentals 2013. The conductivity of materials used for the wall assemblies is shown in Table 2. The conductivity of concrete varies greatly depending on many factors while showing a strong positive correlation with its density. This research used 1.0 W/m-K which is a representative of the conductivity of typical concrete at 2300kg/m³ (Asadi 2018).

Table 1: Boundary conditions

Outdoor ambient temperature	-18 °C
Indoor ambient temperature	20 °C
Outdoor air film coefficient	26 W/m ² -K
Indoor air film coefficient	3.06 W/m ² -K

Table 2: Conductivity of the materials used in the simulations

Materials	Conductivity (W/m-K)	Materials	Conductivity (W/m-K)
3D printed concrete	1.000	EPS	0.038
Wood (OSB, 2x6, etc.)	0.150	XPS	0.029
Steel	50.000	Spray foam	0.024
Fiber reinforced plastic	0.505	Cellulose	0.040
Gypsum board	0.160	Fiberglass	0.040
Polyethylene Siding	0.500	Sheep wool	0.038
Air gap	Varies by thickness	Mineral wool	0.035

Air gaps are set to “Frame Cavity Slightly Ventilated NFRC 100” in Honeybee, a Rhino/Grasshopper plug-in for energy simulation, and the RSI value of the air gaps follows the curve shown in Figure 3 per NFRC 100.

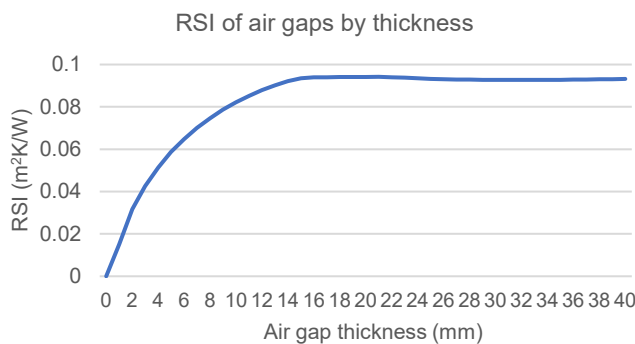

Figure 3: Varying RSI value of air gap by thickness. Source: Authors

3.2. Wall assembly simulation



R-value is a critical metric for evaluating the energy performance of a wall assembly. In the context of construction, the R-value is a measure of how well a two-dimensional barrier, such as a layer of insulation, a window or a complete wall or ceiling, resists the conductive flow of heat. R-value is the temperature difference per unit of heat flux needed to sustain one unit of heat flux between the warmer surface and colder surface of a barrier under steady-state conditions. R-values are additive for layers of materials, and the higher the R-value the better the performance. In this section, the authors simulated various wood framing walls and 3DCP walls to investigate R-values and thermal bridges of the wall assemblies. As the baseline, the authors modeled a code-compliant wood framing wall with 2x6 wood stud and cavity insulation, which is the most common construction system for residential houses in North America. The authors also modeled three high-performing wall assemblies: Structural Insulated Panels (SIPs), Exterior Insulation Finish System (EIFS), and double stud wall with spray foam. These three wall assemblies were developed to mitigate the thermal bridge effect of wood studs that pass through the insulation layer. Table 3 shows the R-values and heat flux of the four wall assemblies. While the 2x6 stud framing wall is just enough to be compliant with the IECC 2018 standards, the other three high-performing walls showed much higher R-values. The EIFS wall has the potential to achieve a much higher R-value when using a thicker exterior insulation board. The thermal bridges at the wood studs in the 2x6 stud wall can be easily seen from the false-color image that shows the heat flux through the wall.

R-values for the two most common 3DCP wall construction methods, incorporating concrete tieback beads and reinforcement bars, were simulated with cavity insulation. With 6” cellulose in the cavity, the single-layer concrete bead wall only showed R-11.5 due to the energy loss through the tieback beads as a thermal bridge, which is clearly visible from the false-color image showing the heat flux (Table 4). The R-value of this wall assembly is far below the energy code requirement. When stacking two layers and offsetting the intersection points, the overall R-value almost doubled while the R-value per unit thickness only increased nominally. The reinforcement rebars in the latter two walls are assumed to be installed at 4” (100mm) intervals vertically. The R-values of the rebar walls are calculated by weighting the sections where rebars are installed and where no rebars are installed. Although the overall R-value of the steel rebar wall is much higher than the single concrete bead wall, the heat flux of where the rebars are installed is much higher than the single concrete bead wall. This is due to the extreme thermal conductivity of the steel. When using fiber reinforced plastic (FRP) rebars, the thermal bridge effect is significantly reduced.

Thermal bridges not only cause energy loss but also potentially cause condensation at the interior surface of the wall. Condensation can damage the interior finish and lead to molding and potential health risks (Citterio, et al, 2008). To evaluate the potential condensation, we simulated the temperature gradient of the wall sections as shown in Table 5.

For the steel rebar wall, the interior surface temperature at the point of rebar is around 5°C. Reading off Psychrometric chart, the dew point temperature of 25°C at 30% relative humidity is 6°C, so there is a high probability of condensation where the rebars are installed. On the other hand, the interior surface temperature of fiber reinforced wall is between 15°C - 20°C so the probability of condensation on the interior surface is dramatically lower.

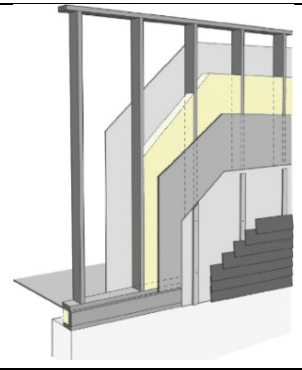
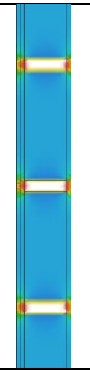
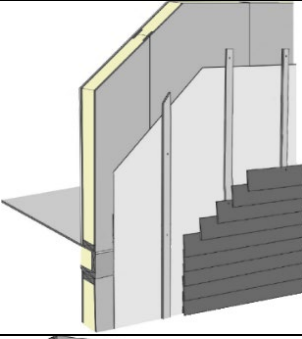
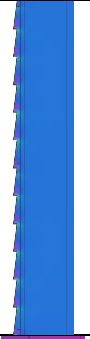
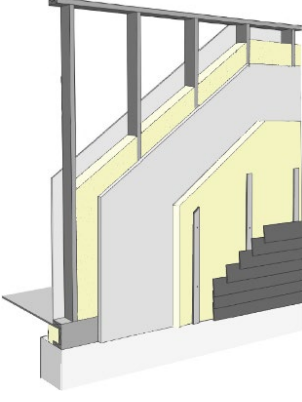
Table 3: R-value and heat flux simulation of wood frame walls. (Axon image reference: Buildingscience.com). Source: Authors

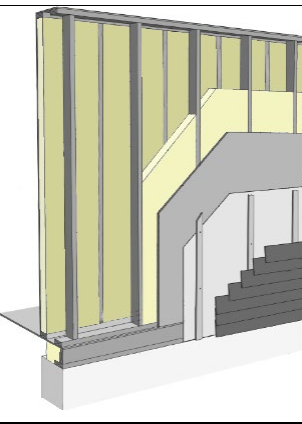
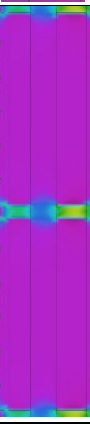
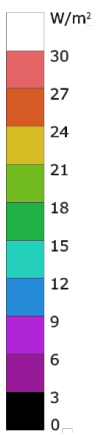
Assembly Name	Axon	Section	Heat flux	Legend
<p>2x6 Stud with Cavity Insulation R-19.0</p>		<p>5.5" Cellulose</p> <p>(Outside/ Left) Vinyl Siding 1/2" Wood furring 1/2" OSB 2x6 Wood stud 1/2" Gypsum panel (Inside/ Right)</p>		
<p>SIPs R-25.7</p>		<p>(Outside/ Left) Vinyl Siding 1/2" Wood furring 1/2" OSB 6" EPS 1/2" OSB 1/2" Gypsum panel (Inside/ Right)</p>		
<p>EIFS R-29.6</p>		<p>3" EPS 5.5" Cellulose</p> <p>(Outside/ Left) Vinyl Siding 1/2" Wood furring 1/2" OSB 2x6 Wood stud 1/2" Gypsum panel (Inside/ Right)</p>		
<p>Double Stud R-38.2</p>		<p>3.5" Spray foam 5.5" Cellulose</p> <p>(Outside/ Left) Vinyl Siding 1/2" Wood furring 1/2" OSB 2x4 Wood stud 1/2" OSB Air gap 2x6 Wood stud 1/2" Gypsum panel (Inside/ Right)</p>		

Among the four wall assemblies, the FRP rebar wall showed the highest R-value per unit thickness while showing little minimal bridging. The authors further investigated how different insulation materials impact the overall R-value of the fiber rebar wall. With 6" (150mm) insulation, the R-values of the wall with different insulation materials are shown in Table 6. While all walls are code-compliant, the R-value of the spray foam wall is very close to the Passive House recommendation of R-37.8 for Zone 5. After running dozens of simulations by varying the thickness of insulation, the authors found that the R-value of fiber rebar wall is approximately linearly proportional to the thickness of insulation regardless of the type of insulation.

Table 4: R-value and heat flux simulation of 3DCP wall assemblies. Source: Authors

Single Layer Concrete Beads	Double Layer Concrete Beads	Steel Rebar Tieback	FRP bar Tieback
			
			
Conductance: 0.49 W/m ² K R-value: 11.5 Insulation: 6" cellulose Wall thickness: 10" Average R/inch: 1.15	Conductance: 0.25 W/m ² K R-value: 22.7 Insulation: 12" cellulose Wall thickness: 18" Average R/inch: 1.26	Conductance: 0.26 W/m ² K R-value: 21.8 Insulation: 6" Cellulose Wall thickness: 10" Average R/inch: 2.18	Conductance: 0.26 W/m ² K R-value: 22.0 Insulation: 6" Cellulose Wall thickness: 10" Average R/inch: 2.20

Table 5: Temperature simulation of the 3DCP wall assemblies for condensation evaluation. Source: Authors



Single Layer Concrete Beads	Double Layer Concrete Beads	Steel Rebar Tieback	FRP Bar Tieback	Legend
				

Table 6: R-values of the FRP tieback wall with different insulation materials

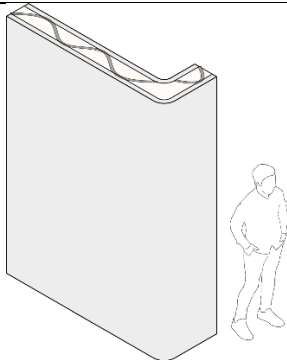
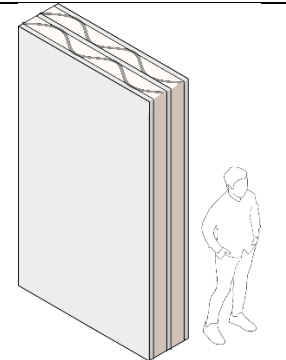
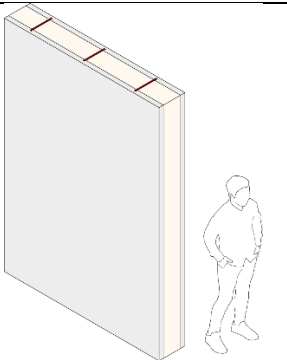
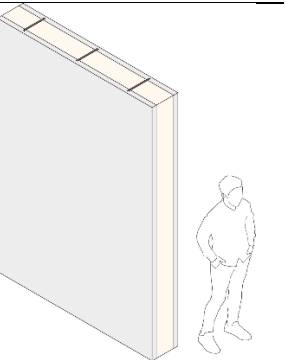
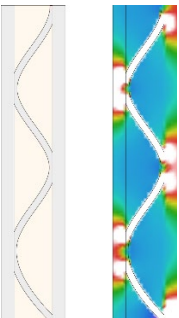
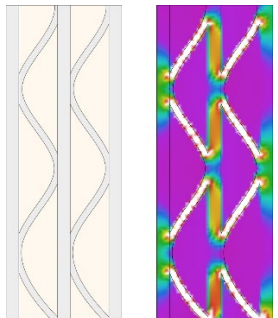
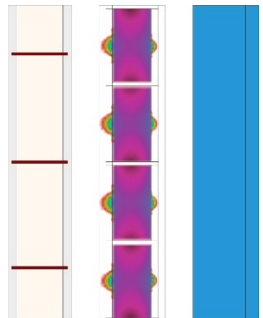
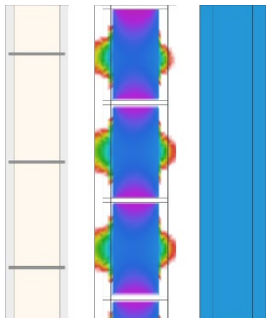
Material	RSI (m2K/W)	R-value (ft2hF/Btu)
Fiberglass	4.05	23.0
Cellulose	4.05	23.0
Spray foam	6.55	37.2
Sheep wool	4.24	24.1
Mineral wool	4.60	26.1

3.3. Building Energy Simulation

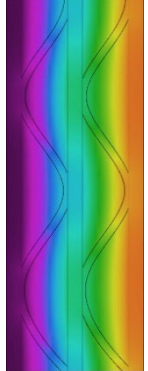
By simulating various wall assemblies with different insulation materials, the authors concluded that fiber reinforced wall is superior in energy conservation and condensation prevention. The R-value of the wall is primarily dependent on the thickness and the conductivity of the insulation. To holistically evaluate how fiber reinforced 3DCP walls impact building energy consumption, the authors simulated the energy consumption of a three-bedroom house located in Hamburg, Iowa. The simulation parameters are set as shown in Table 7.

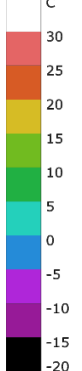
Table 7: Simulation parameters. Source: Authors

Occupancy	3 people, 1.2 met
Occupancy schedule	
Equipment power density	5.38 W/m2
Lighting power density	5W/m2
Heating/Cooling setpoint	20 °C/ 25 °C
Heating/ Cooling COP	0.8/ 1.0
Mechanical ventilation	8 L/s/P
Infiltration	0.5 ACH
Glazing	Double pane clear, U-value: 2.67W/m2-K, SHGC: 0.7, Tvis: 0.8

The energy simulation of a three-bedroom house was conducted for a 3DCP construction and a 2x6 wood stud construction, both with cellulose as insulation (Figure 4). The simulations were carried out using the thermal modeling and simulation functions in ClimateStudio. The type of 3DCP wall was set to the fiber-reinforced wall and the insulation was set to 6" (150mm) cellulose. The simulation results show that the 3DCP consumed 4% less energy in heating and cooling combined compared to the wood stud wall construction. The energy saving comes from the difference in their R-value, and not from the difference in construction methods.

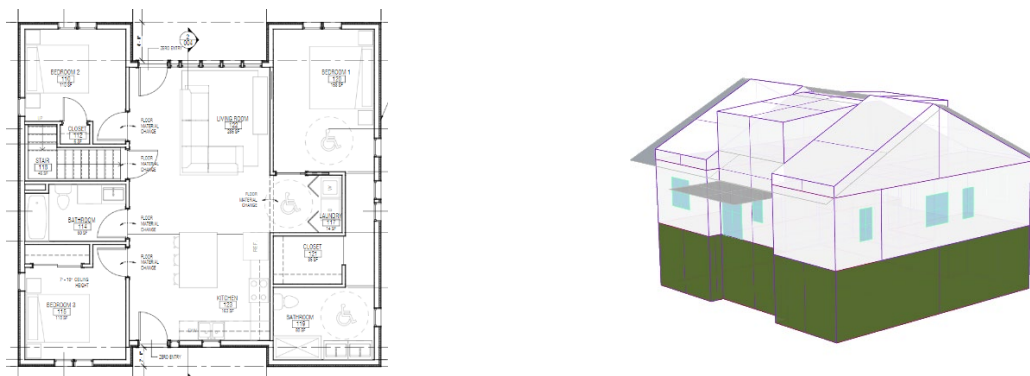

Figure 4: Floor plan of a three-bedroom house and its energy model in ClimateStudio. Source: Authors

4.0 DISCUSSION

This research investigated the energy performance of 3DCP houses by simulating the R-values of various 3DCP wall assemblies and heating/cooling loads of a three-bedroom house with 3DCP walls. Although R-value is a critical metric for evaluating the energy performance of a wall, infiltration could also greatly impact the energy performance. Infiltration can occur by the expansion/contraction from thaw/freeze cycles, the design of the details, and/or construction craftsmanship. The data for the infiltration rate of 3DCP walls are not well known, and physical testing is required in the future to better understand the infiltration rate which would allow more accurate energy simulation.

Another factor that can affect the energy performance of 3DCP houses is that 3DCP walls can act as thermal mass and reduce energy consumption at specific time of year when diurnal temperature swing goes below and above the

comfort zone. Thermal mass is the ability of a material to absorb, store and release heat. Thermal lag is the rate at which a material releases stored heat. For most common building materials, the higher the thermal mass, the longer the thermal lag. The capacity of the thermal mass is dependent on the thickness of the interior concrete wall, the size of the windows, and the climate. The effect of 3DCP walls as thermal mass and thermal lag needs further investigation.

This paper studied various insulation materials with different conductivity, but conductivity is not the only factor that needs to be considered when selecting insulation material. Due to the nature of 3D additive printing, the construction method of adding insulation is also critical. For example, the moisture content of a 3DCP can impact the adhesion and performance of spray foam insulation. If a consistent installation is not possible, then other types of insulation such as batt or board, should be considered, even if these perform less well in simulations. This research established that 3DCP wall assemblies can perform as well as wood-frame houses designed for cold climates such as ASHRAE zone 5 and this claim can be evaluated through design, simulation, and analysis. However, this work excludes many important considerations such as material costs, labor costs, or assembly time requirements. For high-performance 3DCP projects to become a reality outside of the computer and the lab, construction practices and economic factors will need to be balanced with environmental outcomes.

CONCLUSION

In this research, the authors first reviewed the most common 3DCP wall constructions and identified various ways to improve the energy performance of the walls through design interventions. The authors then simulated the R-values of various wall assemblies and heating/cooling load of a three-bedroom house with 3DCP walls. The primary findings of this research include: 1) 3DCP walls are susceptible to thermal bridging due to the high conductivity of concrete and the tieback component that provide structural strength. Removing thermal bridges through design and material choice can greatly improve energy performance and reduce the probability of condensation. 2) Without thermal bridges, the R-value of 3DCP walls is primarily determined by the thickness and conductivity of the insulation. Increasing insulation thickness and/or choose the insulation with low conductivity can achieve reasonably high R-value. 3) 3DCP can achieve the same or better energy performance compared to conventional wood frame constructions with properly designed thermal breaks and appropriate insulation material. Future studies include conducting blow-door tests to gather data for infiltration rates of 3DCP walls, Calibrated Hot Box testing to measure actual R-values of different 3DCP wall assemblies, measuring whole building energy consumption to validate the simulation results, studying the embodied carbon of 3DCP houses, and developing 3DCP walls with low embodied carbon footprint. In addition to the challenges in thermal performance, much research needs to be done to address the challenges in many other aspects of 3DCP technology such as hardware, software, material properties, ambient printing environment, and many more. Despite these challenges, there is value in further exploring the potentials of 3DCP technology.

ACKNOWLEDGEMENTS

This research is funded by Iowa Economic Development Authority and the Center for Global & Regional Environmental Research at University of Iowa. The three-bedroom house used in this study is designed by BNIM.

REFERENCES

- Architecture2030. 2022. *Why the built environment?* <https://architecture2030.org/why-the-building-sector/>
- Asadi, I., Payam, S., Hassan, Z.F.B.A, and Mahyuddin, N.B. 2018. *Thermal conductivity of concrete—A review*. Journal of Building Engineering 20: 81-93.
- Bukkapatnam, S., Mander, J., Paal, S., Pei, Z., and Zeng, L. 2017. *Workshop Report—NSF Workshop on Additive Manufacturing (3D Printing) for Civil Infrastructure Design and Construction*. National Science Foundation (NSF), Alexandria, VA.
- Citterio, M., Manuela C., and Erhorn-Kluttig H. 2008. *Thermal Bridges in the EBPD Context: overview on MS approaches in regulations*. ASIEPI Information paper.
- EIA. 2022. *Heating/Cooling Degree Days*. <https://www.eia.gov/energyexplained/units-and-calculators/degree-days.php>
- Hanle, L.J., Jayaraman, K.R., and Smith, J.S. 2004. *CO2 emissions profile of the US cement industry*. Washington DC: Environmental Protection Agency. Accessed from: <https://www.eia.gov/energyexplained/units-and-calculators/degree-days.php>
- International Energy Conservation Code (IECC) | ICC Digital Codes. 2021. *2021 International Energy Conservation Code (IECC): ICC Digital Codes*. International Code Council. Accessed November 30, 2022. <https://codes.iccsafe.org/content/IECC2021P1/chapter-3-ce-general-requirements>.
- Pan, Y., Zhang, Y., Zhang, D., and Song, Y. 2021. *3D printing in construction: state of the art and applications*. International Journal of Advanced Manufacturing Technology 115. <https://doi.org/10.1007/s00170-021-07213-0>
- Pérez-Lombard, L., Ortiz, J., and Pout, C. 2008. *A review on buildings energy consumption information*. Energy and buildings 40, no. 3: 394-398.
- Suntharalingam, T., Upasiri, I., Gatheeshgar, P., Poologanathan, K., Nagaratnam, B., Santos, P., and Rajanayagam, H. 2021. *Energy Performance of 3D-Printed Concrete Walls: A Numerical Study*. Buildings 11, no. 10 : 432.
- Thom, E.C. 1959. *The Discomfort Index*. Weatherwise 12(2): 57-61. <https://www.tandfonline.com/doi/pdf/10.1080/00431672.1959.9926960>
- Wu, P., Wang, J., and Wang, X. 2016. *A critical review of the use of 3-D printing in the construction industry*. Automation in Construction, 68, 21-31. <https://doi.org/10.1016/j.autcon.2016.04.005>

Estimating Thermal Comfort and Energy Use with Future Warmer Weather

Wendy Meguro¹, Elliot J. Glassman², Josephine Briones¹

¹University of Hawaii at Manoa, Honolulu, HI

²WSP Built Ecology, New York, NY

ABSTRACT: Annual temperatures in Hawai'i are increasing and many residential buildings in subtropical Honolulu do not have mechanical cooling. This research demonstrates a method using whole-building energy modeling and future, hotter weather files to: 1) simulate the negative impact on occupants' thermal comfort in unconditioned multifamily buildings; 2) describe strategies designers may utilize now to promote future thermal comfort; and 3) quantify increased future energy use intensity with mixed mode operation.

Using the TMY3 weather file, the unconditioned baseline multifamily building is estimated to be comfortable 88% of the time without fans, and 96% of the time with fans. The simulation estimates that the building will be significantly less comfortable in the future, as low as 75% of the time in 2050 and 58% of the time in 2080. Encouragingly, with fans, it is estimated to be comfortable 85–91% of the time in 2050 and 71–90% of the time in 2100.

Designers may take action now to prepare for future hotter temperatures with the following effective strategies: provide exterior shading; specify glazing with a stringent solar heat gain coefficient; limit the glazed area; provide adequate façade open area for natural ventilation; and provide ceiling fans. In mixed mode operation, the building's energy use intensity increases from approximately 90 kWh/m²/yr (29 kBtu/ft²/yr) today to approximately 107–132 kWh/m²/yr (34–42 kBtu/ft²/yr) in the year 2080. The findings on poorer thermal comfort negatively impact health and productivity, particularly for populations who cannot afford air conditioning. Increased air conditioning energy use impacts demand on the electrical grid, onsite renewable energy system sizing, and the ability to meet greenhouse gas emissions targets.

KEYWORDS: Thermal Comfort, Future Weather, Climate Change Adaptation, Building Performance Simulation

INTRODUCTION

The years 2013–2021 are among the ten warmest years (NOAA 2021) and warming from anthropogenic emissions will persist for centuries (IPCC 2018). These climate changes will have unequal consequences: most regions will experience increased hot days, however, it is expected that areas in the tropics like Hawai'i will experience them more (IPCC 2018). When people are exposed to temperatures of 32°C (90°F) they feel uncomfortable and nearing 38°C (100°F), symptoms like increased stress from sweating and blood flow and failure to regulate physiology can cause respiratory strain, heat stroke, and circulation collapse (ASHRAE 2021). Thermal comfort is a major factor affecting occupant satisfaction with a space and is influenced by air temperature, humidity, radiation of thermal energy from building surfaces or from direct sun, air movement, occupants' activity level, and clothing.

Globally, the use of energy for space cooling is growing faster than for any other end use in buildings, straining electricity grids and driving up greenhouse gas emissions (IEA 2018). Given current policies, it will triple by 2050, mostly from the residential sector in emerging economies (IEA 2018). Averaged across all countries, space cooling accounted for around 14% of peak demand in 2016 (IEA 2018). In some places, space cooling can represent more than 70% of peak residential electrical demand on extremely hot days, and having capacity to meet that peak demand is very expensive (IEA 2018). Nearly 90% of the households in the United States (US) use air conditioning (EIA 2022a). The demand for air conditioning in Hawaii is increasing (Jedra 2019). "Policies for more efficient air conditioning, combined with policies for more efficient buildings, could actually keep [global] energy demand for cooling flat, while allowing strong growth in access to cooling for populations around the world" (IEA 2018).

1.0 CONTEXT

1.1 Increasing Heat and Energy Use

In Hawaii, climate change is creating social equity issues (CCH 2019a; CCH 2019b) and will hinder progress toward the State's clean energy and emissions goals (HSEO 2022). Increased demand for cooling may increase the risk of electricity generation shortfalls during peak demands in the early evening. In Honolulu, HI, the TMY3 weather data from 1976–2005 (NREL 2008) shows natural ventilation can provide thermally comfortable indoor conditions for about half the year using the Adaptive Comfort Model in ASHRAE Standard 55-2010 (ASHRAE 2010) charted in the Climate Consultant Tool (Climate Consultant 2021). Many detached and multifamily residences do not have mechanical air conditioning. However, annual temperatures in Hawai'i are increasing (EPA 2016) with high temperatures of 107.3°F

measured in summer 2019 in Honolulu, HI (CCH 2019a). Many of the areas experiencing the highest temperatures (CCH 2019a) are the most socially vulnerable (CCH 2019b).

Air conditioning can enhance thermal comfort, but undesirably increases energy cost, hampers progress toward Hawai'i's goal of 100% clean energy by 2045 (HSEO 2022), and burdens low-income residents. During summer on O'ahu, homes with air conditioning used 50% more energy in 2014 and 68% more energy in 2019 than homes without (Hawaiian Electric 2019). "High energy burdens can threaten a household's ability to pay for energy" (US Dept. of Energy 2018). In Hawai'i, where the average price of electricity for residents is almost three times the national average (EIA 2022b), low-income families will be more burdened by these increased energy expenses (CCH 2019c). Estimating and designing for thermal comfort while minimizing air conditioning use with current and future weather align with social and economic needs as well as greenhouse gas emissions goals.

1.2 Future Weather Data

The professional design community of architects and engineers have the knowledge and tools to anticipate impacts of future weather (AIA 2021; Melton 2022a) by using future weather files, but the building industry lacks a standardized way to create or use the future weather files or present simulation results (Rastogi et al. 2022; Melton 2022b). Using historical weather data is likely to result in underestimating building greenhouse gas emissions and may result in failing to maintain indoor comfort in naturally ventilated and mixed mode buildings (Rastogi et al. 2022). There are a few ways to produce future regional weather files (Melton 2020). Arup and Argos Analytic, a consulting firm and climate data startup, developed the WeatherShift™ tool to morph data in global climate change models to produce annual hourly energy plus weather (EPW) files adjusted for different carbon emission scenarios (Arup et al. 2022; Fairley 2015). The procedure of morphing yields weather time series that encapsulate the average weather conditions of future climate scenarios, whilst preserving realistic weather sequences (Belcher et al. 2005). This allows designers to compare the different impacts that emission scenarios will have on the built environment. In collaboration with Arup and Exeter University, this new data was endorsed by the United Kingdom (UK) Climate Impacts Programme (UKCIP) to assist professionals in the use of weather and climate change information in building design and future-proofing of buildings (Chartered Institution of Building Services Engineers (CIBSE) n.d.).

1.3 Application of Future Weather for Design Guidance

The American Institute of Architects (AIA) Code of Ethics requires members make reasonable efforts to advise clients on a built environment that is resistant to climate change (AIA 2020). Designing climate-adaptive architecture that adjusts in response to a changing environment to moderate negative effects (US GCRP n.d.) requires identification of hazards, climate projections, vulnerabilities, and design solutions (AIA 2022). Yet, there is a lack of consensus on a standardized framework for communicating results of simulation with long-term climate data projections (Rastogi et al. 2022). This research examines one building typology and location: unconditioned multifamily buildings in Honolulu, HI. The research (i) identifies the hazard of rising temperatures; (ii) selects various climate projections; (iii) estimates negative impact on occupants' thermal comfort; (iv) quantifies increased future energy use if air conditioning is installed with mixed mode operation; and (v) describes design solutions to promote future thermal comfort. This research demonstrates a method that may be replicated for other building typologies or locations and provides design guidance. Acknowledging that not all building design teams utilize energy modeling as a design tool (AIA 2021), designers working on multifamily residential in Honolulu or subtropical climates may use this research to understand the relative effectiveness of design options on improving thermal comfort.

2.0 METHODS

2.1 Whole-building Energy Model

The team simulated a conceptual design for two multifamily five story residential buildings with an exterior walkway and 40 one-bedroom dwelling units per building (Fig. 4). Although the research focuses on this specific building, the design strategy recommendations apply widely to future residential buildings in Honolulu and the process may be replicated for different building types. The simulation engine EnergyPlus 8.9 (US DOE 2018) was used through the Rhino 6 (Robert McNeel & Associates 2019) software's Grasshopper plug-ins, Honeybee (Ladybug Tools 2019a) and Ironbug (Ladybug Tools 2019b). The building envelope properties were based on the ASHRAE 90.1-2013 prescriptive values for climate zone 1 as referenced by the International Energy Conservation Code (IECC 2015) (International Code Council 2014) which was the energy code for Honolulu at the time of the analysis. Honolulu, Hawaii is located at 21°N latitude, is hot-humid, and the Honolulu International Airport TMY3 weather data has zero heating degree days (HDD18.3°C) and 5527 cooling degree days (CDD10.0°C) (ASHRAE 2007).

The IECC baseline model was used to compare the level of thermal comfort without mechanical cooling under potential future climate scenarios. A multi-zone model of the building was generated with all the residential units as well as exterior walkways as shading elements. An annual simulation was performed to determine the amount of energy consumption given variable occupancy, resident energy use, and hourly outdoor temperatures. The energy model was parameterized to utilize both current and future climate weather files in order to test the impact of warming temperatures on energy consumption and thermal comfort. Various energy conserving measures such as improved glazing, exterior shading, and reduced window to wall ratio were also built into the parametric model to test for scenarios that would be better suited to handle future climate.

2.2 Future Weather Files

The thermal comfort analysis is run under varying future weather files that are associated with global emissions projections. In 2014, the Intergovernmental Panel on Climate Change (IPCC) adopted various greenhouse gas concentration pathways for its fifth Assessment Report (AR5) (IPCC 2014). Two of the four Representative Concentration Pathways (RCPs) are studied here. In the RCP 4.5 scenario, global greenhouse gas emissions are anticipated to peak around 2040, then decline. In the RCP 8.5 scenario, emissions will continue to rise through the year 2100, building up the greenhouse gas concentrations in the atmosphere. Within each RCP, there is a range of possible projections, and the team used the 50th and 90th percentile scenarios in this research. Future weather files for the different IPCC climate scenarios were obtained from the WeatherShift tool (Arup 2022) from Integrated Environmental Solutions in 2019.

2.3 Adaptive Thermal Comfort

The adaptive thermal comfort model from ASHRAE 55-2010 (ASHRAE 2010) is based on the idea that occupants can tolerate different indoor temperatures depending on the prevailing mean outdoor temperature; namely, occupants' tolerance for various internal conditions is based on the season. Studies show that occupants of naturally ventilated buildings can accept a wider range of temperatures than their counterparts in air-conditioned buildings because the preferences were based on outdoor temperature.

Hourly indoor temperatures from the energy model were used to assess occupant thermal comfort under the 80% acceptability in the ASHRAE 55 adaptive thermal comfort model. If the hourly indoor temperature, outdoor temperature, and air speed conditions fell within the adaptive comfort band, it was considered to be comfortable. The process was run for air speed conditions that would be present with and without fans to quantify the annual hours when the increased movement of air would enhance thermal comfort. The hours were then binned into three categories: hours that were too "hot" irrespective of the use of fans; hours that would be comfortable with the use of fans; and hours that were comfortable even without fans. The simulated air speed of 0.8 meters per second (1.78 miles per hour) was used to represent ceiling fans. It is assumed that occupants will be able to adjust their clothing to maintain comfort as per the applicability requirements of the ASHRAE 55 adaptive comfort criteria (section 5.4.1). Therefore, the CLO value used in the comfort calculation varies between 0.5 (summer clothing) and 1.0 (business clothing) hourly by temperature. The process was repeated using the energy models run with future climate files and hourly outdoor temperatures from the morphed future climate files themselves.

2.4 Mixed Mode Operation

The whole building energy models were simulated to determine the impact of mixed mode operation on energy use. When outdoor conditions were comfortable, the model assumed that the occupants would open the windows and the building would rely on natural ventilation for fresh air and cooling. When the conditions became too warm for natural ventilation, the windows would be closed and air conditioning would take over for cooling and ventilation for the residential spaces. The limit considered the maximum outdoor temperature for natural ventilation was 25.6°C (78°F).

The analysis was conducted for current climate conditions as well as the future year climate projections under both RCP 4.5 and RCP 8.5 scenarios. The energy consumption was calculated and compared for each of the future scenarios given the amount of time that the same building would be able to operate in natural ventilation mode versus mechanical cooling mode.

2.5 Design strategies

In a climate like Hawaii's that is already cooling dominated, efforts to reduce solar loads will be increasingly important in a warmer future in order to promote thermal comfort and reduce cooling loads. Strategies investigated in the parametric energy model include reducing window to wall ratio, improved solar protection in the glass specification, and exterior shading.

Peak cooling load was used as a proxy for thermal comfort in this study because the magnitude of the cooling demand above the desired interior setpoints indicates how uncomfortably warm the space will get. It would also indicate the need for cooling capacity needed to be considered for buildings, both under current climate conditions and in the future. Other metrics used to measure the impact of future cooling needs were the energy use intensity of the building and peak electrical load, numbers that were bound to increase with added air conditioning.

3.0 RESULTS

3.1 Whole-building Energy Model

Air conditioning (AC), domestic hot water, lighting, and equipment are the major energy end uses in a condo/multifamily residential building in Honolulu. Designers can have the biggest impact on the air conditioning, domestic hot water (DHW), and lighting energy through good passive design, HVAC and DHW system selection, and efficient lighting.

The IECC baseline building consumed 106 kWh/m²/yr (33.6 kBtu/ft²/yr) of energy with full mechanical cooling. The parametric modeling showed that the energy use intensity (EUI) could be reduced to as low as an EUI of 47.0 kWh/m²/yr (14.9 kBtu/ft²/yr) with full mechanical cooling, or 34.4 kWh/m²/yr (10.9 kBtu/ft²/yr) without cooling. This was achieved through reducing WWR, providing solar protective glass or exterior shading devices, efficient lighting, minimum

ventilation, and choosing efficient mechanical and DHW systems. However as demonstrated in the next section, the ability to eliminate the mechanical cooling system to achieve the lower EUI is limited in future climate scenarios.

3.2 Adaptive Thermal Comfort

The following annual graphs show occupant thermal comfort in the IECC baseline building under each of the climate scenarios and using the Adaptive Comfort model (Fig. 1). The yellow areas indicate hours during the year that are uncomfortable unless ceiling fans are used to increase air speeds to 0.8 meters per second (1.78 miles per hour). The red areas indicate hours during the year that are uncomfortable even with fans and in which natural ventilation is possible. Even under more optimistic future weather scenarios where global temperature rise is muted (through reduction in global greenhouse gas emissions), the simulated passively cooled space in Hawai'i struggles to meet a good level of comfort throughout the year (more than 90% comfortable).

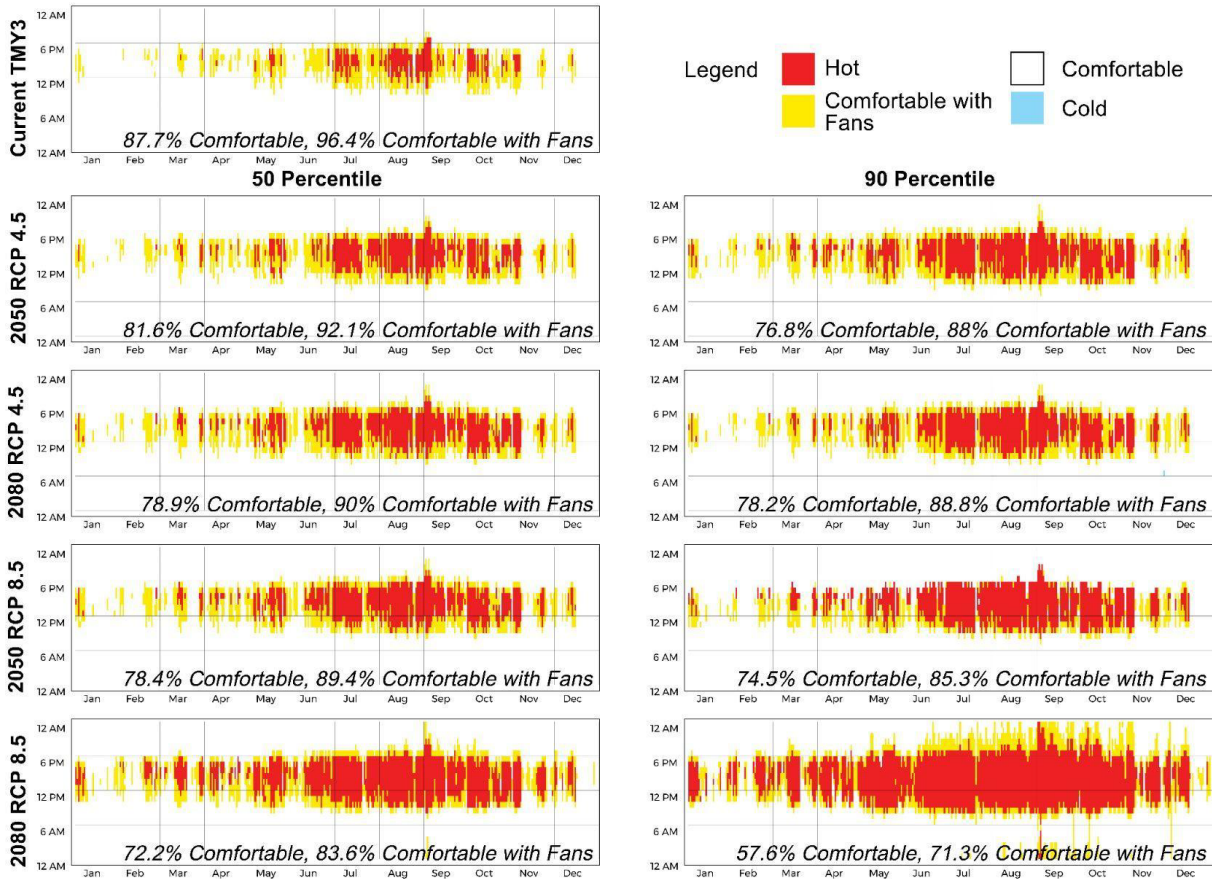

Figure 1: Annual graphs of occupant thermal comfort (% of hours) using the adaptive comfort model, the IECC baseline building, and eight future climate scenarios. Source: WSP.

Using the ASHRAE 55 adaptive comfort model, the baseline multifamily building with the TMY3 weather data is currently estimated to be comfortable 88% of the time without fans, and 96% of the time with fans. The simulation estimates it is comfortable significantly less often in the future (Fig. 2), as low as 75% of the time in 2050 and 58% of the time in 2080. Encouragingly, fans are an effective low energy strategy to increase the number of comfortable hours.

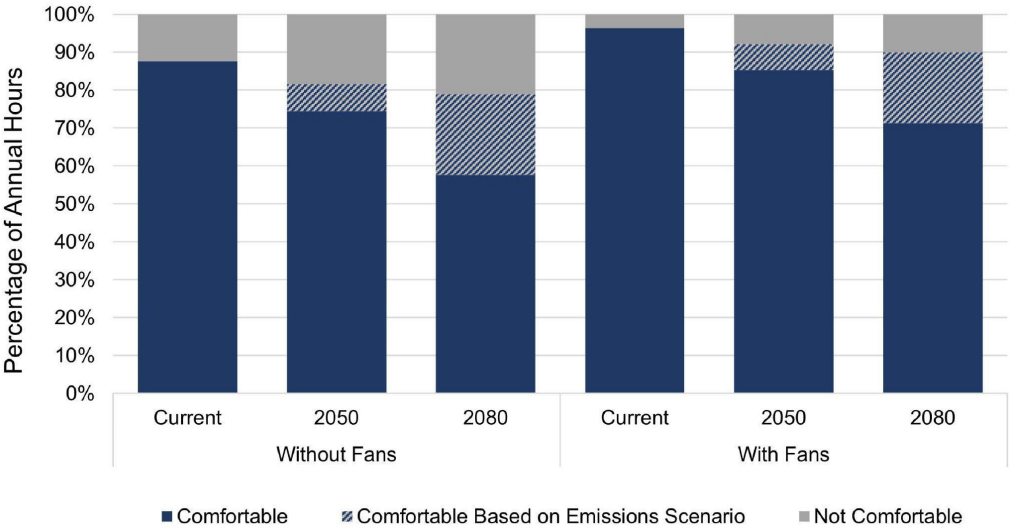

Figure 2: Percentage of annual hours that meet ASHRAE 55 adaptive thermal comfort model in the multifamily IECC baseline building without mechanical cooling in Honolulu, HI. Source: WSP.

3.3 Mixed Mode Operation

In mixed mode operation, the IECC 2015 baseline model EUI is 90.4 kWh/m²/yr (28.7 kBtu/ft²/yr), as compared to 34.4 kWh/m²/yr (10.9 kBtu/ft²/yr) with natural conditioning only. For reference, with full cooling, the EUI is 106 kWh/m²/yr (33.6 kBtu/ft²/yr). Utilizing mixed mode operation and ceiling fans as compared to full cooling has low or no additional initial cost but may require occupant education to leverage natural conditioning and fans when possible and only use the mechanical cooling when the temperatures exceed the ability of these low or no energy conditioning methods to maintain thermal comfort.

With future climate scenarios, the analysis shows a steady increase in energy consumption over time as the ability to maintain comfort with natural conditioning and fans decreases with a warming climate (Fig. 3). In mixed mode operation, the building’s energy use intensity increases from approximately 90.4 kWh/m²/yr (28.7 kBtu/ft²/yr) today to approximately 107–132 kWh/m²/yr (34–42 kBtu/ft²/yr) in the year 2080. This increase in energy use due to warming can further perpetuate future warming trends unless clean energy sources are used.

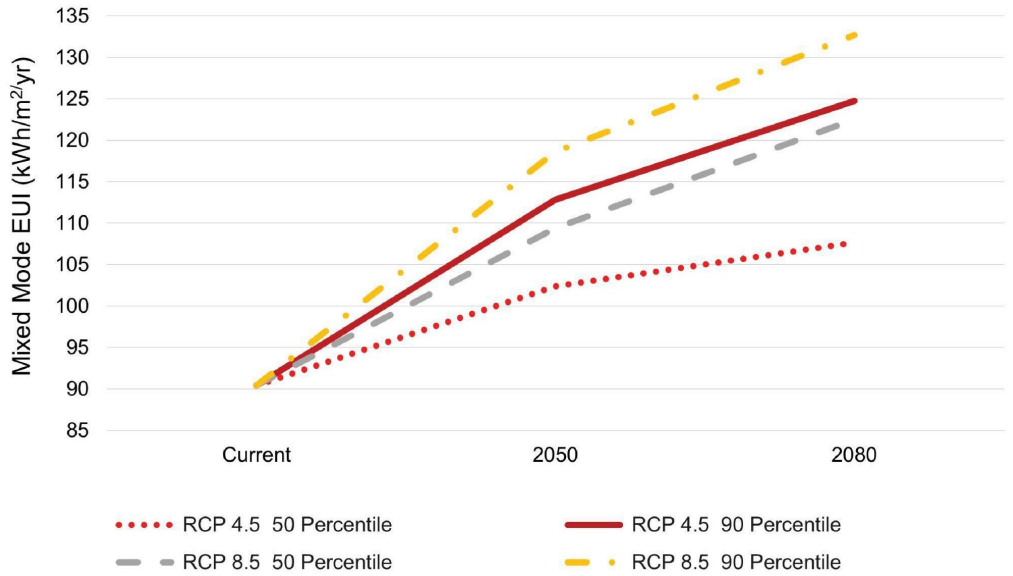

Figure 3: EUI of the mixed mode IECC baseline energy model with future climate scenarios. Source: Authors.

3.4 Design Strategies

These models use the IECC baseline as a basis for the thermal comfort studies. Additional design strategies such as exterior shading would be effective at reducing both temperature rise due to solar gains and direct radiative solar effects. Shading would provide additional hours of thermal comfort, however, the IECC baseline model does not include

local external shading over the windows. The design itself does provide some self shading due to the exterior walkways and close clustering of the residential blocks.

The parametric analysis showed that design strategies that reduced solar loads were the most effective drivers at reducing EUI and peak cooling load such as adding exterior shading, specifying glazing with a stringent solar heat gain coefficient, limiting the glazed area, providing adequate façade open area for natural ventilation, and providing ceiling fans (Fig. 4). With passive strategies (e.g., exterior shading) natural ventilation would be possible more often than without the passive strategies.

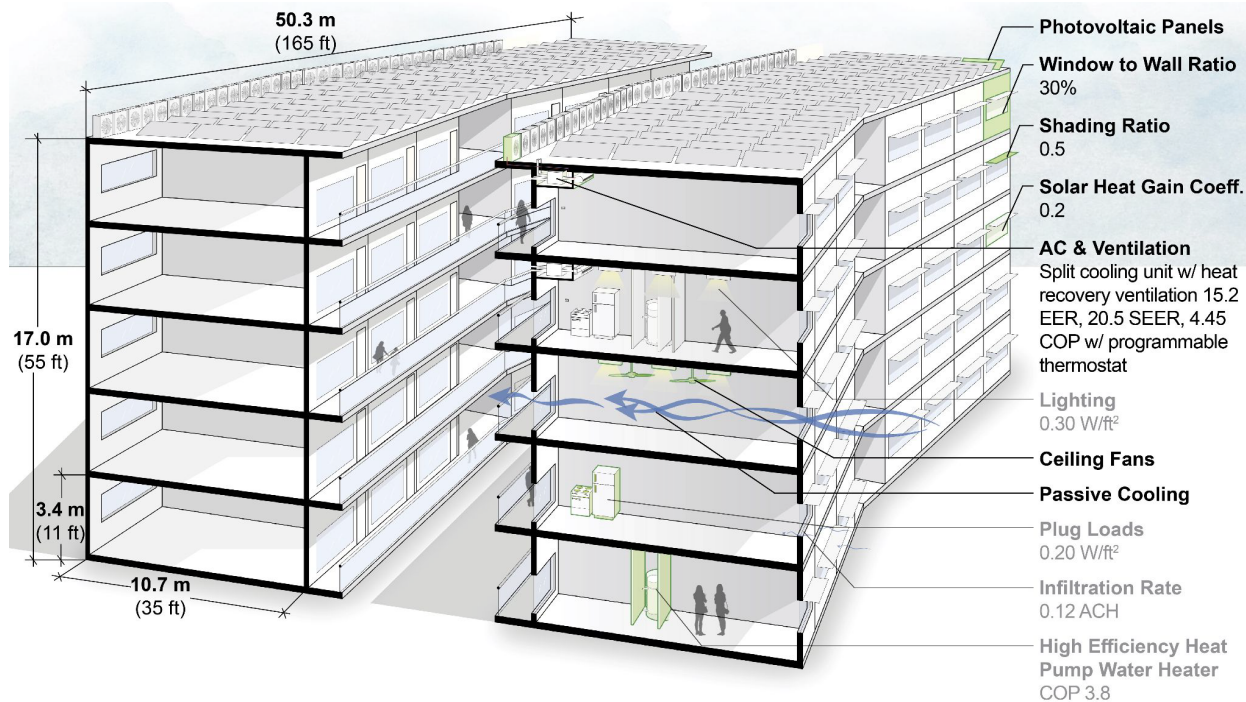

Figure 4: Section perspective of multifamily buildings with recommended design strategies. Source: University of Hawaii: Darlyn Chau, Aiko Tells, Wendy Meguro.

4.0. DISCUSSION

The estimated future increases in interior temperature indicate several future research needs. First, there is a need for research on the point at which reducing solar loads and providing ceiling fans is insufficient and mechanical cooling should be introduced. The lack of a robust overheating metric makes simulating climate-related heat impacts very difficult (Rajkovich and Holmes, 2022). One approach is to utilize criteria for passive survivability to maintain thermally safe conditions during a four-day peak summertime power outage (USGBC 2019). Second, when mechanical cooling is installed, there is a need to educate occupants on the significant potential energy cost savings from mixed mode operation to meet the State GHG emissions targets. Third, when projecting progress toward the Hawai'i Clean Energy Initiative targets (HSEO 2022) for energy efficiency, future hotter weather and increased demand for space cooling should be considered. Fourth, additional types of regional weather files that represent a warmer than typical year, current, and future may need to be developed and utilized in the US. This is similar to the Design Summer Year (DSY) used to evaluate overheating risk within buildings available for selected UK locations through the CIBSE.

This research may be applied by designers of new construction or major renovations. In addition to massing and orientation, the strategies to reduce solar heat gain may extend the amount of time when mechanical cooling is not needed. We encourage designers to provide provisions for future installation of mechanical cooling. Based on observed continuous use of mechanical cooling in selected detached homes in Hawai'i, installing mechanical cooling sooner than necessary may increase building energy use (Meguro et al. 2020). Designers may enable the building to adapt by oversizing mechanical rooms to accommodate a future need for more equipment in 2080 (Fairly 2015) cost-effectively to extend the useful life of the building and its embodied carbon.

The findings may also motivate the State to adopt more stringent energy targets which would mitigate climate change and decrease the need for future mechanical cooling installation and energy use. Other cities enacted energy efficiency and GHG emission limits (New York City 2019) for certain buildings. Similarly, research into Hawai'i's path to a clean energy economy recommends a carbon tax (Rhodium 2018) and recognizes that increased energy efficiency investments accelerate reduction of oil consumption (Rhodium 2018). Potential future policies to reduce overheating in

buildings are preceded by regional-scale policies to reduce the urban heat island. The cities of Denver and Los Angeles offer rebates for buildings to add green roof systems, e.g., cool-roofs, solar PV, or vegetation, while San Francisco mandates solar and green roofs on a portion of most new construction (CCH Office of Resiliency 2019c).

CONCLUSION

The simulation estimates that the multifamily building in Honolulu, HI will be warmer and less comfortable in the future, but ceiling fans and design strategies to limit heat gain can help. While methods to model and present results of energy and thermal comfort with future weather are not standardized, this research demonstrates one approach with design guidance that may be applied today. Designers may take action now to prepare for future hotter temperatures through climate-appropriate building massing and orientation, exterior shading, glazing solar heat gain coefficient, limited glazed area, natural ventilation, and ceiling fans. These design strategies increase thermal comfort and help meet the State's GHG emissions reduction targets by reducing the need for mechanical cooling. If mechanical cooling is installed in the future, the building's energy use intensity increases, but may be lessened through inclusion of the aforementioned design strategies and occupant education on mixed mode operation. Designers should plan for future addition of mechanical cooling in buildings and policymakers should implement policies to curb GHG emissions and reduce overheating in buildings.

ACKNOWLEDGEMENTS

Funding was provided by the Office of Naval Research and the Hawaii Natural Energy Institute with resources from the State of Hawaii Energy Systems Special Fund §304A-C. In kind support was provided by the UH School of Architecture and Sea Grant College Program. Additionally, we thank team members Charles Chaloeicheep, Zachary Stevens, and Eileen Peppard, Aiko Tells, and Darlyn Chau.

REFERENCES

- American Institute of Architects (AIA). 2022. "Resilient Project Process Guide".
https://content.aia.org/sites/default/files/2022-06/AIA46_Resilient_Process_061422.pdf
- AIA Strategic Council. 2021. "Scalable Climate Action".
https://content.aia.org/sites/default/files/2021-11/21_10_EX_Scalable_Climate_Action_v02.pdf
- AIA. 2020. "2020 Code of Ethics and Professional Conduct". https://content.aia.org/sites/default/files/2020-12/2020_Code_of_Ethics.pdf
- ASHRAE. 2010. *ANSI/ASHRAE Standard 55-2010: Thermal Environmental Conditions for Human Occupancy*. Atlanta, GA: ASHRAE.
- ASHRAE. 2021. *2021 ASHRAE Handbook: Fundamentals. Inch-Pound Edition*. Section 10.3.1, Fig. 1. Atlanta, GA: ASHRAE.
- Arup, Argos Analytics LLC. n.d. "WeatherShift". Accessed October 13, 2022. <https://www.weathershift.com/heat>
- Belcher, S., Hacker, J. 2005. "Constructing Design Weather Data for Future Climates". *Building Serv. Eng. Res. Technol.* United Kingdom: The Chartered Institution of Building Services Engineers (CIBSE). DOI: 10.1191/0143624405bt112oa.
https://www.researchgate.net/publication/43155423_Constructing_design_weather_data_for_future_climates
- Chartered Institution of Building Services Engineers (CIBSE). n.d. "Weather Data". <https://www.cibse.org/weatherdata> and https://www.cibse.org/media/0kckd3lu/weatherdata_technicalbriefingandtesting_final.pdf
- City and County of Honolulu (CCH): Office of Climate Change, Sustainability & Resiliency (OCCSR). 2019a. "Heat Watch Report - Honolulu, Hawaii". CAPA Strategies, LLC. https://www.resilientoahu.org/s/Community-Heat-Assessment-Preliminary-Report-Honolulu_Dec_2019-lores.pdf
- CCH: OCCSR. 2019b. "Social Vulnerability Index (SoVI)". <https://www.resilientoahu.org/equity/data>
- City and County of Honolulu (CCH). 2019c. "One Climate One O'ahu - Climate Action Plan 2020-2025".
<https://www.resilientoahu.org/climate-action-plan>
- Climate Consultant 6.0. and Milne, M. 2021. <https://www.sbse.org/resources/climate-consultant>
- Energy Information Administration (EIA). May 31, 2022a. "Nearly 90% of U.S. Households Used Air Conditioning in 2020". <https://www.eia.gov/todayinenergy/detail.php?id=52558>
- EIA. 2022b. "Table 5.6.A. Average Price of Electricity to Ultimate Customers by End-Use Sector, by State, July 2022 and 2021". https://www.eia.gov/electricity/monthly/epm_table_grapher.php?t=epmt_5_6_a.
- EPA United States Environmental Protection Agency. 2016. "What Climate Change Means for Hawaii".
<https://19january2017snapshot.epa.gov/sites/production/files/2016-09/documents/climate-change-hi.pdf>
- Fairley, P. 2015. "Wizards of Weather". *Architectural Record*.
- Hawaiian Electric. 2019. "News Release: Record Summer Heat Drives Increase in Electricity Demand".
https://www.hawaiianelectric.com/documents/about_us/news/2019/20190923_record_summer_heat_drives_increase_in_electricity_demand.pdf
- Hawaii State Energy Office (HSEO). 2022. "Hawaii Clean Energy Initiative". <https://energy.hawaii.gov/hawaii-clean-energy-initiative/>
- Rajkovich, Nicholas B., and Seth H. Holmes. 2022. *Climate Adaptation and Resilience Across Scales: From Buildings to Cities. 1st ed.* New York, NY: Routledge. <https://doi.org/10.4324/9781003030720>.
- Intergovernmental Panel on Climate Change (IPCC). 2018. "Summary for Policymakers. In: Global Warming of 1.5°C." <https://doi.org/10.1017/9781009157940.001>

- IPCC. 2014. "Climate Change 2014". Synthesis Report. Contribution of Working Groups I, II and III to the Fifth Assessment Report of the Intergovernmental Panel on Climate Change [Core Writing Team, R.K. Pachauri and L.A. Meyer (eds.)], IPCC, Geneva, Switzerland.
https://www.ipcc.ch/site/assets/uploads/2018/05/SYR_AR5_FINAL_full_wcover.pdf
- International Code Council (ICC). 2014. *2015 International Energy Conservation Code*. Illinois: ICC.
- International Energy Agency. 2018. "The Future of Cooling: Opportunities for energy-efficient air conditioning".
<https://doi.org/10.1787/9789264301993-en>
- Jedra, C. September 20, 2019. "Why The Growing Demand For AC Threatens Hawaii's Renewable Energy Goals". *Civil Beat*. <https://www.civilbeat.org/2019/09/as-ac-replaces-trade-winds-hawaiis-demand-for-electricity-imperils-renewable-goals/>
- Ladybug Tools LLC. 2019a. Honeybee. US. <https://www.ladybug.tools/honeybee.html>.
- Ladybug Tools LLC. 2019b. Ironbug. US. <https://www.ladybug.tools/index.html>.
- Meguro, W., Glassman, E. 2021. "Evaluating Energy Targets and Efficiency Measures in Multifamily Subtropical Buildings through Automated Simulation". *Technology | Architecture + Design*, 5:1, 82-95, DOI: <https://doi.org/10.1080/24751448.2021.1863676>
- Meguro, W., E. Peppard, S. Meder, J. Maskrey, R. Josephson. 2020. "Going Beyond Code: Monitoring Disaggregated Energy and Modeling Detached Houses in Hawaii". *Buildings*. <https://www.mdpi.com/2075-5309/10/7/1120>
- Melton, P. 2020. "Stop Designing for the Past: Your Future Could Depend on It". *BuildingGreen*.
<https://www.buildinggreen.com/news-analysis/stop-designing-past-your-future-could-depend-it>
- Melton, P. February 24, 2022a. "Future Climate and Professional Liability: AIA Weighs In". *BuildingGreen*.
<https://www.buildinggreen.com/newsbrief/future-climate-and-professional-liability-aia-weighs>
- Melton, P. January 10, 2022b. "The Future of Designing with Future Weather Data". *BuildingGreen*.
<https://www.buildinggreen.com/news-analysis/future-designing-future-weather-data>
- National Renewable Energy Laboratory (NREL). 2008. *Users Manual for TMY3 Data Sets*.
<https://www.nrel.gov/docs/fy08osti/43156.pdf>
- New York City. 2019. "Local Law 97 Greenhouse Gas Emission Reporting".
<https://www1.nyc.gov/site/buildings/codes/greenhouse-gas-emission-reporting.page>
- NOAA. 2021. "2021 was World's 6th-warmest Year on Record". <https://www.noaa.gov/news/2021-was-worlds-6th-warmest-year-on-record>
- Rastogi, P., Laxo, A., Cecil, L. D., Overbey, D. 2022. "Projected Climate Data for Building Design: Barriers to Use". *Buildings and Cities*, 3(1), pp. 111–117. United Kingdom. DOI: <https://doi.org/10.5334/bc.145>
- Rhodium Group. 2018. "Transcending Oil: Hawaii's Path to a Clean Energy Economy".
<https://rhg.com/research/transcending-oil-hawaiis-path-to-a-clean-energy-economy/>
- Robert McNeel & Associates. 2019. Rhino 6. Seattle, WA. <https://www.rhino3d.com/>.
- U.S. Department of Energy (DOE). 2018. EnergyPlus 8.9. Washington, DC. <https://energyplus.net/downloads>
- U.S. Global Change Research Program (US GCRP). n.d. Glossary. <https://www.globalchange.gov/climate-change/glossary>
- US Green Building Council (USGBC). 2019. LEED version 4 pilot credit "Passive Survivability and Back-up Power During Disruptions". <https://www.usgbc.org/credits/new-construction-core-and-shell-schools-new-construction-retail-new-construction-data-48?return=pilotcredits/new-construction/v4>

Exploring the Potential of the Physical Space Design Techniques for Immersive Experiences in the Metaverse: An Interpretation of Spatial Perception

Michelle Boyoung Huh¹, Seogjae Choi²

¹University of Arkansas, Fayetteville, AR

²The University of Texas at Austin, Austin, TX

ABSTRACT: The increased use of the metaverse throughout the pandemic posits a need for better metaverse designs to provide immersive experiences. The development of virtual reality has been proposed to improve the user's immersion in the metaverse, but the quality of the visual representation of virtual reality is determined by the capabilities of hardware and software. This suggests that improvement of the metaverse design itself focusing on the contents can help establish a more immersive space in the metaverse. Since human spatial perception is based on the continuity of recognition, applying architectural design principles to the metaverse design can produce an immersive experience of space by leveraging the existing familiarity of space in the physical world. To design immersive space in the metaverse, this study proposes an interpretation of spatial perception in the physical world at three levels: 1) perception, 2) abstract, 3) and memory level. The first level of spatial perception in the metaverse can be improved by the application of space transition design in the physical world. Additionally, the scene transition techniques of a film can promote the immersive perception of space at the abstract level. By examining the potential of the physical world design techniques for designing the metaverse this study suggests opportunities for future interdisciplinary research with architecture to provide more immersive environments in the metaverse. This will help users recognize the metaverse as the physical virtual world, and in turn, facilitate social interaction between users and improve productivity in the metaverse.

KEYWORDS: Metaverse, Immersive experience, Spatial perception, Transition experience

INTRODUCTION

The metaverse was first described as the 3D world where human beings exist as an avatar in Neal Stephenson's novel, *Snow Crash*. For over a decade, the metaverse had primarily been referred to in the game industry as a term broadly representing a large scale of the virtual world that populates through an avatar (Seidel et al. 2022).

As the game industry has developed over the decades, the concept of social interaction in a virtual environment has become common. Notably, millennials born between 1981 and 1996, and Generation Z born between 1997 and 2012, who were exposed to this game culture through their adolescence, are accustomed to collaborating in virtual environments by building and sharing virtual spaces to gather and play. The shift to virtual workplaces for remote work has rapidly increased due to the global pandemic. Since the current virtual workplace that mostly relies on video conferencing and communication platforms has a limitation in promoting active engagement and social interaction in real-time, metaverse can be an alternative virtual workplace platform that can provide a more immersive and effective work environment. The sense of community brought by the game industry has been applied to the suggestions in this study. It aims to expand the utilization of metaverse from workplaces to various social activities that require collaboration and social interaction.

A literature review reveals the emerging trend in defining the metaverse to accommodate the important concept of interconnectivity between the real world and the virtual world, and among users. As a digital medium that provides immersive and interconnected experiences (Seidel et al. 2022), the metaverse focuses on social meaning that can be reinforced by stories and user interaction in spaces. To allow the avatar, which is a user's alter ego and active subject in the metaverse (Park and Kim 2022), actively create interconnected experiences, the metaverse provides differently designed space.

Humans experiences the real world by moving their body in time through space. In the metaverse, by using a keyboard and mouse, the avatar moves from place to place and meets up with others. Seidel and his colleagues (2022) interpreted this experience by citing Clark (2004)'s idea about the merger of technology and biology that happens as technology gradually became intertwined with biology.

This study begins with the idea that a well-choreographed travel experience in the metaverse can be woven with a physical spatial sense. We know that the virtual world is not real, and it cannot be the same as the real world. But through realistic story content (Park and Kim 2022) and well-designed spatial sequences, it can provide a tangible

feeling of connectivity and a sense of community. The fictitious but feasible scenario of the metaverse can intertwine with the user's previous memory in the real world. This allows users to extend their minds to mixed reality. By emphasizing the importance of the physical quality of spatial perception in a series of different interconnected spaces, this study aims to introduce the potential opportunity for interdisciplinary study with interior architecture in metaverse design.

1.0 LITERATURE REVIEW

1.1. Knowledge Gap in Designing Immersive Experiences of Space Transition in the Metaverse

The virtual environment of the metaverse which consists of scenes, non-player characters (NPCs), and avatars, are constructed by the integration of the physical world and digital graphical techniques (Zhao et al. 2022). Zhao and colleagues describe two different methods in constructing virtual environments of metaverse depending on where acquire the initial data: 1) physical-based construction and 2) design-based construction. Physical-based construction is to build a virtual environment based on the existing physical environment by using 3D measurement methods whereas design-based construction more relies on digital design technology and the designer's imagination that can be reinforced by technologies. Although the source of the initial data and the detailed process of building the environment vary, both methods aim to build a realistic environment.

Previous studies show that the implementation of a realistic virtual environment is critical in building the metaverse environment. However, such digital representation has limitations since the quality of the virtual environment is determined by the digital rendering quality of color, material, and light. To provide an immersive experience in the metaverse, not only 'building' realistic visualization but also 'designing' realistic spatial experience must be considered.

Moving through differently designed spaces using avatars and interacting with other users in real-time is the key feature of the metaverse. Thus, creating distinct experiences in each space and designing the integration of those separated experiences coherently is critical in the design of metaverse space (Seidel et al. 2022). The precedent study highlighted the integration and interconnection of different spaces in the metaverse, but it was limited in demonstrating the interconnection between the user and space and in building the body of knowledge about designing the experience of in-between spaces of the metaverse. This study addresses the importance of the design of a transition experience in the metaverse to reinforce the physical quality of spatial perception.

To improve spatial perception in the metaverse and provide a more immersive experience, the following section analyzes spatial perception in physical space. This analysis identifies the concepts to be applied to designing the metaverse. Based on the conceptual framework, we suggest how to provide a transitional experience with the integration of user interaction and dynamic visual scenes, which introduces the physical quality of spatial perception.

1.2. Spatial Perception in the Physical World

In the physical world, according to environmental analysis, which assumes that the perceptions of spatial and physical elements shape the environment, the perception of space can be split into three levels that appear simultaneously: 1) perception level, 2) memory level, and 3) abstract level (Stenros, Santo, and Schadewitz 1993). First, the perception level relates to the physical experience of moving in the environment. It is created in the process of using our senses as we move our bodies. This experience comes from the relationship between the environment and the user. In architecture, the sequence of space and relations between path, place, and user can be explained at this level. The second level is the memory level which refers to the experience of the image and feel of a specific space. The distinctively designed space, the user's memory, and personal history can affect forming of this level. Finally, the abstract level is to figure out space at a more conceptual and to recognize the space in the context. Stenros et al. (1993) describe that while we cannot clearly distinguish the three levels, the overlapped three perception levels provide the feeling of place and create a continuous and layered space experience. The interaction between these three levels through a building (dwelling), human, and space to produce space perception is shown in Figure 1.

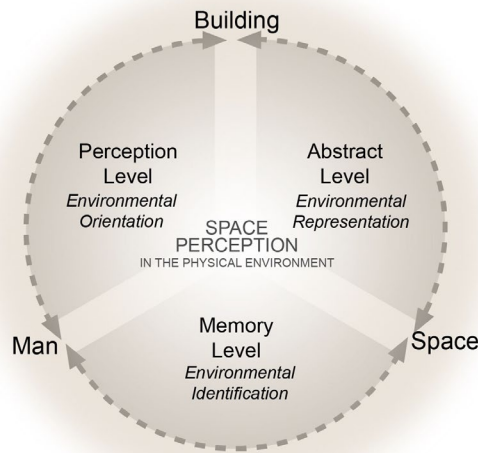

Figure 1: Interaction between three levels of space perception through elements in the physical world. (Author 2022 developed based on Stenros 1998)

The relationship between building (dwelling), human, and space that creates three space perception levels in the physical world can be interpreted into the relation between interconnected metaverse environment, microscopic scale space, and user/avatar as shown in Figure 2. In the metaverse, memory level can be achieved by designing different themes and styles so that each space can provide different experiences. However, perception level and abstract level of perception need to be determined further based on the understanding of the nature of the digital environment.

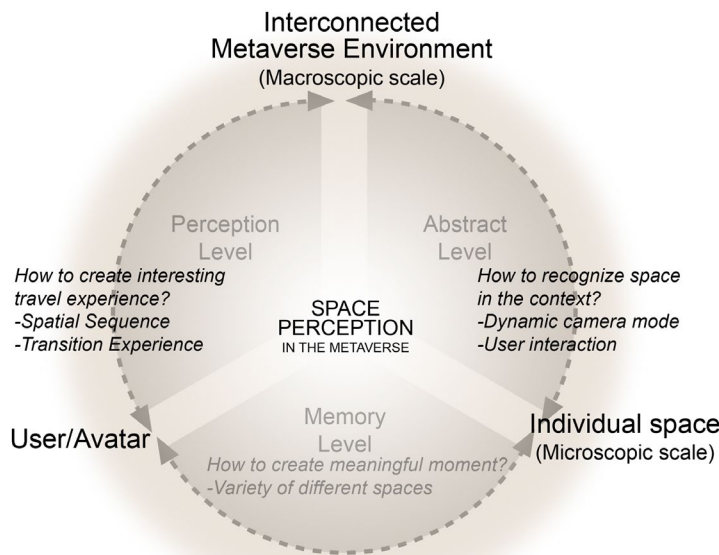

Figure 2: Interaction between three levels of space perception through elements in the metaverse.(Author 2022)

To implement perception and abstract level, through the lens of interior architecture design, this study investigates two relationships: 1) the relationship between user-metaverse environment focusing on the process of perceiving space as an avatar moves and 2) the relationship between microscopic scale-macroscopic scale to improve the quality of spatial perception of individual space within the entire context. Based on this conceptual framework, reinforcement of interspace transition experiences and application of dynamic visual scenes will be presented as a suggestion to improve the two space perception levels.

1.3. Threshold Space in Architecture

The threshold, which originally means a lower doorsill between the door jambs is used as a representation of a space-defining and independent element that is placed in the act of crossing from one space to another (Boettger 2014). Since 'space' can be determined by an individual's physical experience in movement and perception, 'threshold space', a compound term of threshold and space, can be explained as an experience in transitional space (Boettger 2014). Boettger (2014) defines threshold space as a transition space that separates one space from another and simultaneously connects them. The threshold space is a spatial preface placed ahead of or behind functional space. One of the key elements in architectural design is space sequence design which is designing the experience of a space entered and a space left and designing moments to give a notion of moving towards another space. The ambiguity of threshold space which can be both a boundary and a bridge between spaces offers various possibilities depending on individuals in perceiving space. How can we bring this experience in transitional space into the metaverse?

Unlike the physical world which consists of various scales of inhabited space defined by boundaries, the metaverse is an open-ended and scalable environment. For open spatial bodies, such as metaverse environments, in which is difficult to identify the boundaries of space, threshold spaces are integrated into various forms of paths, such as ramps and stairs, which are separate spaces and part of the path (Boettger 2014).

2.0 APPLICATION OF ARCHITECTURAL CONCEPTS IN DESIGNING METAVERSE

2.1. Path, Movement, and Spatial Perception: Application of Threshold Space in the Metaverse

J.J. Gibson considers the human senses as an aggressive and seeking mechanism, not a passive receiver as Aristotle argued (Bloomer and Moore 1977). Unlike Aristotle who insisted that perception occurs via the sense naturally, J.J. Gibson defines the senses as a perceptual system that actively seeks out information from the environment and objects which our body interacts with. Among the five basic senses that J.J. Gibson lists, visual, auditory, taste-smell, basic orienting, and the haptic system, Bloomer and Moore point out the significant contribution of basic orientation and haptic sense in an understanding of three-dimensionality. Basic orientation is a postural orientation relating to gravity. Haptic sense is the sensory system that our body can experience in interacting with surrounding objects and the environment (Bloomer and Moore 1977). Both sensory systems are closely related to our body movement on the ground plane. Bloomer and Moore describe that humans expand their inner order to the outer inhabited world by responding to the configuration of the place, path, pattern, and edge in the physical world. Spatial perception can be explained as the process of connecting our internal world to the world outside by experiencing a series of space configurations.

In the metaverse, placing the avatar can be interpreted as the act of constructing a dwelling in the virtual world, beyond the body and physical world. This is similar to the expansion toward the outer world that takes place as we bring our body out of the boundary of our familiar inner landscape in the physical world. After placing their body out of the boundary, a human body in the physical world, and an avatar in the metaverse, the perceptual process proceeds depending on the movement in the space.

In architecture, the concept of a path is a critical design element that determines the quality of space experience, as an implementation of the choreography of a trip that allows humans to perceive their bodies extending to the world. In the process of navigating along a path, an interesting spatial experience can be introduced by variations in the shape, direction, proportion, scale, intervening intersection, and elevation in the path. In the physical world, we experience a variety of paths that are designed differently based on the consideration of spatial characteristics of the start point and destination, the surrounding environment, and the design solution to respond to these integrated circumstances. Some paths are designed to emphasize the spatial characteristics of the destination and make it predictable in advance, so one can be ready for the space where they are about to meet. Some are designed to be detoured intentionally to induce the imagination. In the case of public spaces, straightforward and clear paths that can be read intuitively are used. Through this experience in the physical world, we become familiar with perceiving the spatial sequence and thus have the ability to imagine what might be before and after the path.

Visually showing a different landscape from the traveler's viewpoint is another variation of the path that can provide a unique spatial perception by stimulating the imagination (Bloomer and Moore 1977). While moving the body along paths, what one sees allows imagining beyond the destination. Since human vision provides relatively detailed spatial information three-dimensionally, it takes a predominant role in spatial perception (Eimer 2004). Even when the body does not physically move along the eyesight, recognizing both the visible and the invisible and expanding spatial perception can be interpreted in the metaverse the same as in the physical environment. In a metaverse environment, users stay in physical reality but bring their avatar along on the paths, and the mind's eye follows it. The actual eye's capacity allows one to perceive the space seen on the digital screen and the mind's eye imagines the space beyond the visible scene. Two act of imaging the inner landscape and recognizing the world outside expands their spatial perception. Reaching the space cannot be physically achieved, but it can be surmised and experienced. Since the current metaverse environment relies on digital visualization shown through the screen, architectural path design strategies can be applied with a focus on designing and constructing virtual scenes. By improving the design of the path and its surrounding environment, focusing on what spatial experiences are to be provided when moving between interconnected spaces, the metaverse can provide a more immersive spatial experience.

The sense of interconnectivity can be introduced by designing and placing paths and transitional spaces between different spaces based on an understanding of the spatial sequence and the entire context as in architecture, rather than simply moving the avatar from space to space without a transitional sequence. Given the first-hand spatial experience obtained from physical space and users' familiarity with them, applying various forms of architectural path design to the metaverse makes it easier for users to immerse themselves in the metaverse. The characteristics of space, the programmatic concept (private/public, service/served, etc.), the use of space, and the relative scale and hierarchy in adjacent spaces can also affect designing transition in the metaverse.

It is critical to design transition in the metaverse focusing on 1) designing the experience in a coherent manner and 2) designing the continuous transformation that can occur in a stepwise manner (Seidel et al. 2022). Based on the analysis of each space, the configuration of threshold space and its back-and-forth sequence can be determined. The sequence of threshold spaces can be subdivided into recognition, approach, arrival, direction, monitoring, and termination (Boettger 2014). The variations of space can be applied to emphasize specific phases in the sequence. Beyond the functional aspect of movement between the spaces, through the coherent transition scenario, threshold space plays a critical role in connecting each spatial experience coherently to give a notion that they are in the same world as well as seamlessly entering each different space. By applying a similar design strategy to a similar configuration to the ones used for the physical world to design the Metaverse, the individual experiences can be tied coherently.

2.2. Integration of Dynamic Visual Scene

In providing an immersive and seamless spatial experience in the metaverse, interactive camera moving when navigating different spaces can more realistically promote the transition experience. Due to the tendency of the human sense which is to follow the dominant sensory modality that provides accurate information about the external environment, in understanding three-dimensionality, human vision takes a critical role (Eimer 2004). In the case of digital environments where users have limitations in using their senses to interact with the environment and perceive space, visualization on the screen predominantly affects spatial understanding.

Metaverse can be developed further with the application of VR devices that allow the integration of visual sources with the user's actual movement. However, the limitation of current head-mounted VR devices can be an obstacle to the metaverse which aims to create an optimized and seamless virtual environment that can replace various social functions that were performed in the physical environment without any inconvenience. Park and Kim (2022) describe the difference between the metaverse and AR/VR focusing on its social meaning. Compared to VR/AR which deals with the level of engagement of physical approach in digitally rendered space, metaverse focuses on its services to provide more sustainable and immersive content with a well-designed story sequence. Metaverse is not a single virtual space that is designed with digital design tools but a scalable and interconnected virtual world where users can socialize as doing in the physical world. Thus, the metaverse needs to be further developed to focus on its components regardless of the external plug-ins. In the metaverse, hardware, and software components have technical challenges to seamlessly perform high-resolution images without rendering delay. Due to the large amount of data required to perform a wide 360-degree field of view, capacity limitations of hardware and software make immersion difficult. To offer a sustainable immersive environment even with the low-capacity hardware and software, immersion achieved by content is critical (Park and Kim 2022). Thus, this paper claims the application of architectural spatial sequence, in the process of building scenarios, can contribute to improving the sense of immersion.

Park and Kim (2022) highlight the importance of the approach in the form of a complete multimodal-based scenario, such as a movie and a television show, that uses multimedia content. Due to the nature of screen-based environments, the application of spatial compositions of physical space should be implemented with the integration of dynamic camera mode. With the camera mode of first-person point of view and third-person point of view, which are optimized to follow the user with eye level height and walking pace, it may be difficult to understand space and its relationships in a comprehensive way (Calderon, Worley, and Nyman 2006). Particularly, in an open-ended environment, it is relatively difficult to recognize a specific space within a larger environment and comprehend the surroundings. Even if the user explores across different spaces, providing a variety of spatial experiences is limited if the actual scene that one sees is a series of moving forward.

To improve spatial understanding in virtual space, the application of dynamic camera mode has been suggested in the related precedent study. Nnadi et al. (2008) demonstrate the benefit of dynamic camera mode in spatial reasoning, particularly in virtual game space. Through the experiment, they validate the fact that the camera changes help the user to recognize the space transition faster and more efficiently, with the premise of having distinctly different designs for each region and optimized software performance. Calderón and colleagues (2006) argue that cinematic camera control can contribute to enhancing a real-time navigable experience as well as facilitating spatial understanding in a design sense.

Understanding how dynamic visual media such as films handle visual experiences in consideration of perceptual systems can help to implement dynamic visual content that optimizes the application of transition spaces in the metaverse. In the film, even though the scenes are presented from multiple viewpoints, we perceive scenes and events as continuous (Smith 2009). The mismatch between the psychologically perceived continuity and spatiotemporally discontinuous is derived from the nature of visual information (Smith 2009). It is in the same vein that we covered in

the previous sections regarding the variations in path design. In the real world, humans naturally perform the attentional shift with their eye capacity even when they observe the same scene. This allows observers to link the scene from different viewpoints into a continuous event by constructing the additional scene with their imagination. With the benefits of the high degree of consistency in the perceptual system humans implement in processing dynamic visual scenes (Smith 2009), we can incorporate cinematography techniques into transition space design on metaverse. The dynamic visual scene can be implemented with the use of dynamic camera movement, the editing of multiple viewpoints, and the integration of light and sound effects. For example, to develop the transition experience, which is a critical element in emphasizing the interconnection of spaces in the metaverse, designers can apply the movie scene transition techniques, including editing with a scene from multiple views that can effectively recognize transition to other spaces, changes of camera movement, and visual-auditory effects.

By Integrating user interactions, the dynamic visual scene can improve the user's perception of space quality, especially at the abstract space perception level, allowing the user to experience space more realistically. Different camera modes, for example, first and third-person point of view, free-roaming view, and the bird's eye view can be mixed by the application of film editing technology and be presented when the user moves into space using a mouse and keyboard. It can help the user to recognize the individual experience from the context and by doing so, the individual experiences can be represented distinctly but at the same time be tied in a coherent manner within the context. In the process, the improved spatial perception can contribute to the interweaving of technology into biology, which would allow the metaverse to exist as a virtual but physical reality.

CONCLUSION

Improving the design of the metaverse can produce effective spatial perception, and in turn, more immersive experiences for users. Given that users of the metaverse are familiar with the physical world, employing similar principles to designing the physical world to design the digital world can leverage the continuity of perception which makes users perceive the metaverse likely the real world. Specifically, in architectural design, the designing transition between spaces is a critical factor to enrich spatial perception by providing a cue to change ambient along the sequence of space. Applying this design principle in the metaverse cannot be achieved by a change of viewpoint only. This study suggests the implementation of scene transition techniques used in cinema to enhance space perception in the metaverse. The combination of showing a scene from multiple views by camera movement and visual-auditory effects notifies users of the change in space, and further, allows an immersive experience and deeper social interaction with other users.

By highlighting the potential of applying architectural design for designing the metaverse to provide immersive experiences, this study suggests opportunities for future research. This does not have to be limited to transition design but can be extended to designing the detailed elements of space. The application should not be a mimicry of the physical world. The architectural design principle needs to be translated according to the characteristics of the metaverse with the consideration of hardware and software capabilities. As an example of the translation, this study modifies the space perception defined by Stenros et al.(1993). Like this, future research about the interpretation of the design principles in the physical world and the detailed application of such interpretation is needed.

REFERENCES

- Bloomer, K. C., and Moore, C. W. 1977. *Body, Memory, and Architecture*. New Haven: Yale University Press.
- Boettger, T. 2014. *Threshold Spaces : Transitions in Architecture : Analysis and Design Tools*. Boston: Birkhäuser.
- Calderón, C., Worley, N., and Nyman, K. 2006. "Spatial cinematic mediation in real-time architectural walkthroughs." *Journal of Information Technology in Construction* 11: 343-360.
- Clark, Andy. 2004. *Natural-Born Cyborgs : Minds, Technologies, and the Future of Human Intelligence*. Cary: Oxford University Press.
- Eimer, M. 2004. "Multisensory Integration: How Visual Experience Shapes Spatial Perception." *Current biology* 14(3): R115–R117.
- Nnadi, O., Fischer, U., Boyce, M., and Nitsche, M. 2008. "Effect of Dynamic Camera Control on Spatial Reasoning in 3D Spaces." *Proceedings of the 2008 ACM SIGGRAPH Symposium on Video Games*, 157–162.
- Park, S., and Kim, Y. 2022. "A Metaverse: Taxonomy, Components, Applications, and Open Challenges." *IEEE access* 10: 4209–4251.
- Seidel, S., Berente, N., Nickerson, J., and Yepes, G. 2022. "Designing the Metaverse." *Proceedings of the 55th Hawaii International Conference on System Sciences*, Maui, HI.
- Smith, Tim. 2009. "Film (Cinema) Perception." *Encyclopedia of Perception* 1:458-461.
- Stenros, A. 1993. "Orientation, Identification, Representation: Space Perception in Architecture." In *Endoscopy as a Tool in Architecture*, edited by Aura, S., Alavalkama, I., and Palmquist, H. Tampere: Tampere University Press.
- Zhao, Y., Jiang, J., Chen, Y., Liu, R., Yang, Y., Xue, X., and Chen, S. 2022. "Metaverse: Perspectives from Graphics, Interactions and Visualization." *Visual Informatics* 6(1):56–67.

Full Scale: Educating Architects Through Performed Labor

Nick Safley¹

¹Kent State University, Kent, OH

ABSTRACT: Educating architects within the design studio on the relationship of decisions made during design to the labor required to actualize material construction is a fundamental shortcoming of architectural education. This shortcoming is notably the bridge between architectural practice and the academy. Two overlapping academic simulations of construction address this divide common in the American architectural education environment today: fabrication-based courses focused upon novel techniques and design-build courses focused primarily on building-scale construction. Neither adequately address the connections between design labor and construction labor. The problem-oriented case study presented here is an alternative to these shortcomings that addresses the failings of traditional design-build and fabrication courses by selecting elements from each course type to help students understand construction labor's relationship to design. This course places students in a large-scale manufacturing facility to work alongside professionals to realize the full-scale design of an isolated building element, the unitized curtain wall envelope. Students performed the construction of this element mock-up under the oversight of construction professionals and integrated custom fabricated elements built as more traditional digital fabrications. By designing and constructing a small area of unitized curtain wall, which could be repeated to enclose a much larger volume, students could map their labor on the mock-up to larger-scale constructions in future design work. Through the direct performance of labor upon scalable assemblies, students can make informed decisions relating to design and labor in many scales of construction.

KEYWORDS: Construction, Fabrication, Labor, Envelope, Full Scale

INTRODUCTION

The aesthetic and technical decisions we make as designers are never isolated from the performance of the labor needed to execute those decisions. It remains challenging to educate architects on the scale of work necessary to actualize design within the laboratory of the studio. This challenge is not a new issue, as architectural education since the Bauhaus has sought to bridge a widening gap between design and construction (Carpenter 2014). Currently, no method of teaching design's relationship to construction labor has successfully prepared students for the range of scales and materials in contemporary design and construction. Full Scale, a course taught in the spring 2022 semester at Kent State University, addresses this issue through focused attention on a single building element, the unitized curtain wall envelope, as a scalar assembly applicable from low rise construction to the largest structures on the planet. The course's objective was to teach students to value their position in design as that of coordinating labor by participating in manufacturing labor directly. By preparing students to be social stewards of design's relationship to the human component of material construction, the course bridged the design of a single element with the performance of the labor needed to realize it. Students learned how an aesthetic decision will affect the time and effort of those performing the construction beyond a simple understanding of cost differences. This knowledge places the designer in an expert role in the building's construction and demands power back to the architecture profession. (Kieran and Timberlake 2004)

Currently, architectural education engages the material construction of buildings in two ways: either too focused or too broad to understand the labor impact of design decisions made for the large range of possible project scales in the profession. First, design-build courses, although not completely uniform in their pedagogical approach, tend to focus on built works where students perform the design and act as part of the construction team, most often on small complete projects. Second, fabrication courses, which have been formalized in many architecture colleges, tend to be more focused on experimental material organization utilizing digital tools than on having a social or professional focus. By focusing neither on small-scale building for social purpose nor on technique-based material experimentation alone, this course case study proposed a pedagogical model for teaching construction that focused upon a singular building element and placed students in a large-scale manufacturing facility to work alongside professionals to realize a full-scale mock-up of that element.

1.0 BACKGROUND INFORMATION

Design-build and fabrication courses share a lineage in higher education, and coursework of this sort has existed for 140 years in the United States as a pedagogical tool (Canizaro 2012). Design-build courses, which typically have a

social agenda, predate those focused on fabrication and can be further traced back to influences at the dawn of industrial production in the 19th century, such as John Ruskin's construction of a road with students from Oxford. (Galloway 1996). More recently, courses of this sort have strived to bridge the divide between design, material construction, and the architectural profession, which can be traced to the Dessau Bauhaus of the 1920s (Carpenter 2014). This Bauhaus program of study centered on a critical relationship between design and its constrained relationship to construction at the core of its curriculum (Lonman 2010). From this beginning, as a means to address industrial production methods in the Bauhaus, design-build education has continued to evolve to meet the cultural demands of the day. In the 1960s and in the 1990s, design-build education took on a countercultural or community service position in response to dominant trends within architectural academic institutions. Design-build education often has an overt social agenda and can be typified by a focus on community service and small-scale building construction even today (Canizaro 2012).

Related to, but distinct from, design-build pedagogy is digital fabrication-based teaching that developed in the late 1990s as fabrication labs began to emerge in American universities and across the globe. Schools "tooled up" with laser cutters, 3 Axis Routers, robotic arms, and, more recently, 3D printers. Fabrication courses have had less time to develop into the various subcultures that exist within design-build, and a more general understanding of fabrication can be made. Coursework and pedagogy focused on digital fabrication tend not to focus on the delivery of buildings for a larger social good, but instead on the experimental application of computer-aided fabrication tools. Courses focus on novel connections, processes, and the control of complex geometry related to material assembly (Carpenter 2014). While some of these courses have expanded in scale towards inhabitable structures and larger-scale proof of concept, like those for the ETH, the building scale constructions primarily performed as large-scale proof of concepts of novel technology and technique (Gramazio and Kohler 2022). Fabrication pedagogy is equally as diverse as design-build, but courses typically focus on novel methods and tools unrelated to full-scale or normative construction. Experimentation in these courses is less related to building delivery than finding the limits of technological processes or simply teaching digital tools for their own sake.

For this study, determining the current differences between design-build pedagogy and fabrication-based pedagogy was critical, as was identifying their shortcomings. Traditional design-build and fabrication courses fail to address the relationship between design and construction in two primary ways. First, design-build typically only addresses small-scale construction capable of being built by students in one or two semesters, eliminating student exposure to techniques and technology used to construct the most resource and labor-intensive works. Students generally hold to light framing and readily available residential scale material to keep costs down, expedite the construction process, and eliminate requirements for specialized skills.

2.0 METHOD

The *Full Scale* seminar course was designed to sidestep the pitfalls of both design-build and fabrication courses while maintaining the parts of both course types that prepare students to interact with a specific labor force. This course forms a hybrid between fabrication and design-build by focusing upon a single built element, the envelope. It focuses further on unitized curtain walls to facilitate rich interaction with a local contractor. Instead of the complex practice of a class full of students managing an entire project like most design-build pedagogy, the scope of the course was narrowed. Similarly, students did not venture into experimental or novel digital fabrication techniques or tools but learned a suite of fabrication tools and processes commonly found in curtain wall fabrication, such as metal milling and laser cutting. Projects were kept at a scale that could be accomplished in a semester by a small team between work performed in our industry partner's shop facility and with the school's metal fabrication tools.

Students in this course focused on the exterior envelope, specifically designing and constructing a unitized curtain wall mock-up. By focusing on the envelope, arguably the most critical building element that architects retain expertise over. Students in this course developed a working knowledge of envelope technology in parallel to understanding the scale of human labor needed to achieve their aesthetic goals. This was done by being present or performing all parts of the design and fabrication process, something not possible in a professional practice situation utilizing an exterior technology of this type. The architect, as a professional in practice, is seldom, if ever, able to maintain this level of contact with a contractor or subcontractor due to professional definition and law, as architects are not those charged with physically constructing a building.



Figure 1: Example Construction by Group 2, custom laser cut steel sheet attached to standard extrusions. (Seminar Group 2: Chance Vidovic, Joel Dalzell, Brooklynne Irwin, Kalp Champaneri, Hunter Edmiston, 2022)

Digital fabrication courses generally use student labor to achieve a segment of a boundary-less systemic logic that could potentially expand to other projects or applications. The labor in these courses is secondary to the innovation of a system or assembly logic. In contrast, the course being discussed here utilizes a boundless system, the unitized curtain wall, which is well-established and not a site for the course's innovation. The pedagogical positioning of Full Scale between a design-build and digital fabrication course limited the scope and scale without a focus on technological novelty so students could monitor and perform labor on large-scale building technology.

2.1 Organization

The course was comprised of 14 students, five graduate students and nine undergraduate students, and all but one student was from the architecture program. The non-architecture student was a construction management undergraduate who had an architectural background. Students' year levels ranged from 3rd-year undergraduate to 2nd-year graduate, and they needed no fabrication, software, or practice knowledge to enroll. Students possessed a wide range of practice and fabrication experience, so necessary shop training was performed during class time early in the semester for metals and handheld power tools. The scope of physical making in the course was more significant than most students had participated in before, and all coursework had to be completed within a semester. This course developed three proposals in student teams that combined with an industry partner to create a series of comparable artifacts in place of a singular project for the entire class.

2.2 Concept

Developing a large-scale mock-up of curtain wall designs was the central task of the course. Grid-based visual precedents from parallel artistic and craft practices were used to develop edgeless patterns composed of technical curtainwall details. Instead of a bounded object, such as a building, students developed an envelop system which could be applied to a variety of forms and scales of construction. Students were taught rendering techniques in V-Ray and Rhino to develop envelope designs visually. Parallel to this, students learned to read and draw unitized curtain wall construction details and evaluate shop drawings. Individual design interests in pattern or assembly type were used to form teams. These teams produced new boundless rendered textures of their designs to see how curtain wall units

aggregated across a flat edgeless surface, layering in material information as it became available. Students were limited to materials workable with the tools available in the college's shop, with college funds set aside for outside fabrication if needed. During this period, all students underwent metal fabrication training in the College of Architecture shop in preparation for any in-house fabrication.

The course intentionally sidesteps more significant systems integration questions that you might find in design-build practices. A complete picture of building construction or its comprehensive network of constituents is unrealistic in the academic context, particularly in a semester seminar. Aesthetic issues of composition within gridded construction systems and fabrication material experimentation were used to maintain a tension between a design-build course project delivery which addresses the complex web of actors and influences in construction with a fabrication course that addresses novel material assembly. The course prioritizes large-scale craft, materiality, and human-scale assembly to expose students to material processes and labor practices in a specific industry. Early readings and research were used to understand the curtain wall system's embedded carbon and material extraction. The course textbook, *The Ecologies of the Building Envelope* by Alejandro Zaera-Polo, framed the historical development, networked politics related to the materials, and larger construction industry labor practices of curtainwall systems and subassemblies.

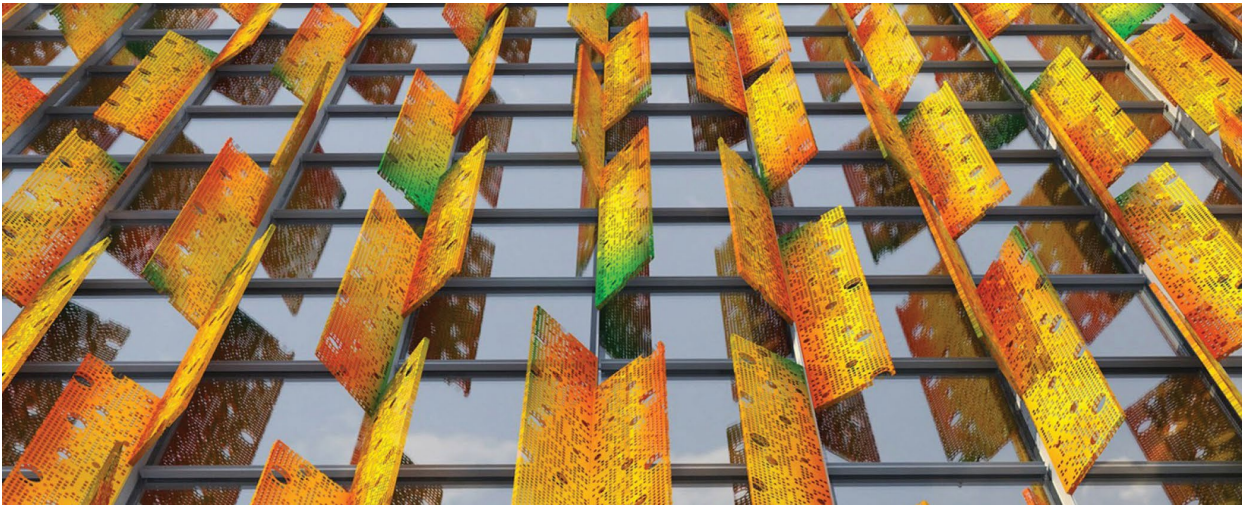

Figure 2: Boundless Rendered Textures of Wall Systems by Seminar Students, Group 2. (Seminar Group 2: Chance Vidovic, Joel Dalzell, Brooklyne Irwin, Kalp Champaneri, Hunter Edmiston, 2022)

2.3 Industry Collaboration

Critical from the course's inception was the involvement of an industry partner, United Architectural Metals. This unitized curtain wall fabricator has employed many former Kent State University architectural graduates at all levels, including upper management, and has a long productive relationship with the College. Many Kent State graduates intern with this company, and the College has a clear working relationship. The class toured the manufacturing facility to observe their process early in the semester. The initial plan for the course was only to observe the fabrication of the units, as it was assumed that liability and injury risk would prevent any more significant involvement of students in the fabrication process in United Architectural Metals shop. Surprisingly, the university and industry partner allowed students into their shop to assemble prefabricated parts after receiving safety training. United Architectural Metals manufactured the complex CNC machined parts from approved shop drawings, with students observing the fabrication process. Students then assembled the fabricated parts under the supervision of the plant manager using hand tools. Fabrication and assembly in the United Architectural Metals' shop took place over two days. Two more weeks were needed in the Kent State CAED shop to fabricate and connect the custom additions. By designing and constructing a small area of unitized curtain wall alongside professional manufacturers, students could map their labor to small parts that they could assemble into much larger constructions.

2.4 Design Development

Students were tasked with refining one project per group to develop a small section of wall for a full-scale material mock-up. Each student group prepared a digital model, detailed wall sections, and rendered elevations which considered floor slab locations, panel supports, mullion depth, stack joint location, and maximum glazing sizes. The teams discussed these documents with the industry partner who functioned in a design assist role, something this manufacturer also does for professionals. There was some discussion of thermal performance in these meetings, but no thermal modeling of the walls' performance was carried out as the systems varied little outside of the opaque wall area percentage. Overall assembly thermal performance that included opaque wall area containing insulation was used to calculate a total R-Value/U-Factor of the assemblies and verify the walls satisfied code requirements. A suite of available unitized curtain wall details was shared from the industry partner with the students, and each team integrated

them with their designs. These profiles were vast and were those the industry partner had as drop material from recent projects in their shop, reducing the course cost for the students, the university, and the industry partner. Students used information from these meetings to inform the design patterns, materiality, and composition.

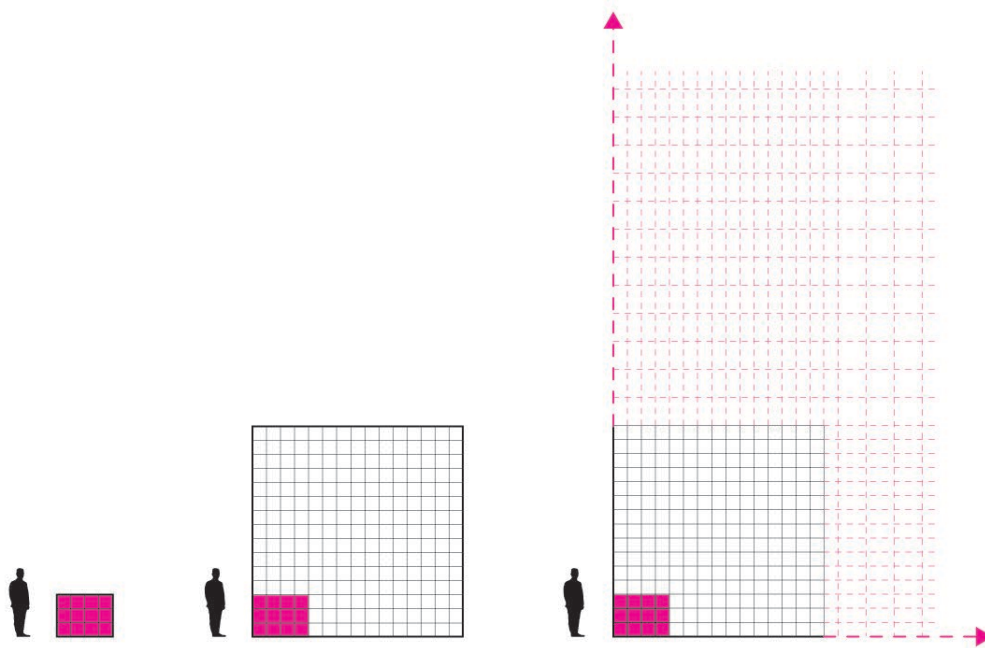

Figure 3: The labor used in the mockup fabrication could then be mapped to larger construction and units' sizes. (Image by Author)

One result of the design assist meeting was determining that some parts of each group's design were too complex or not cost-effective for the industry partner to manufacture. The students isolated those parts to fabricate in the College's shop, where they would directly control all aspects of the fabrication. In addition to meetings with the curtain wall manufacturer, a representative from an insulated glass unit manufacturer visited to help students specify glass that achieved the aesthetic goals of their group's design, using the rendered images as a tool for discussion and reference. This meeting resulted in groups choosing glass with the best thermal performance for their project and specifying custom ceramic frits, coatings, and glass colors to match the rendered images. The glazing manufacturer donated the specified glazing units to the course, which could only be delivered in a timely and cost-efficient manner in 1'x1' format. The glazing size provided a productive constraint and is the industry standard sample size for insulated glass units. Mock-up designs began with these constraints of glass size, curtain wall profiles, connection details to the curtainwall for custom parts, and dimensions of drop material. Each constraint asked the students to adapt their designs and understand the materials' costs. Student groups had a budget to track and get approved before they could purchase any non-donated material or labor.

2.5 Custom Fabrication

Parallel to the curtain wall unit fabrication, students learned small-scale shop processes in the college fablab to create custom parts to integrate into their envelopes. These digitally fabricated parts functioned much more like a traditional fabrication course with a craftsperson relationship between design and making. These highly custom parts were fabricated during class time with the supervision and assistance of the college shop staff. Allowable materials and processes were limited, like most common fabrication courses, so that each group could focus on a chosen technique. The college funded these portions of the assembly, and each team was given a budget to manage.

Three distinct fabrication methods and material combinations emerged unique to each group. Group 1 studied custom milled concrete formworks to produce soft bends in the material surface. They fabricated formwork and developed a concrete mixture with a dye additive and steel wire mesh reinforcing. Group 2 studied laser-cut steel plates to produce bent screens with multicolor painted color gradients. The group developed a new relationship with a local steel fabricator specializing in laser cutting who was excited enough about the course to offer assistance for free. Group 3 rolled soft profiles from sheet steel and spot welded the parts together. A thick nontraditional coating, spray on truck bed liner, was applied for durability, a contrasting texture, and to hide surface imperfections. This coating company requested photographs as they were interested in future product applications in the building industry.

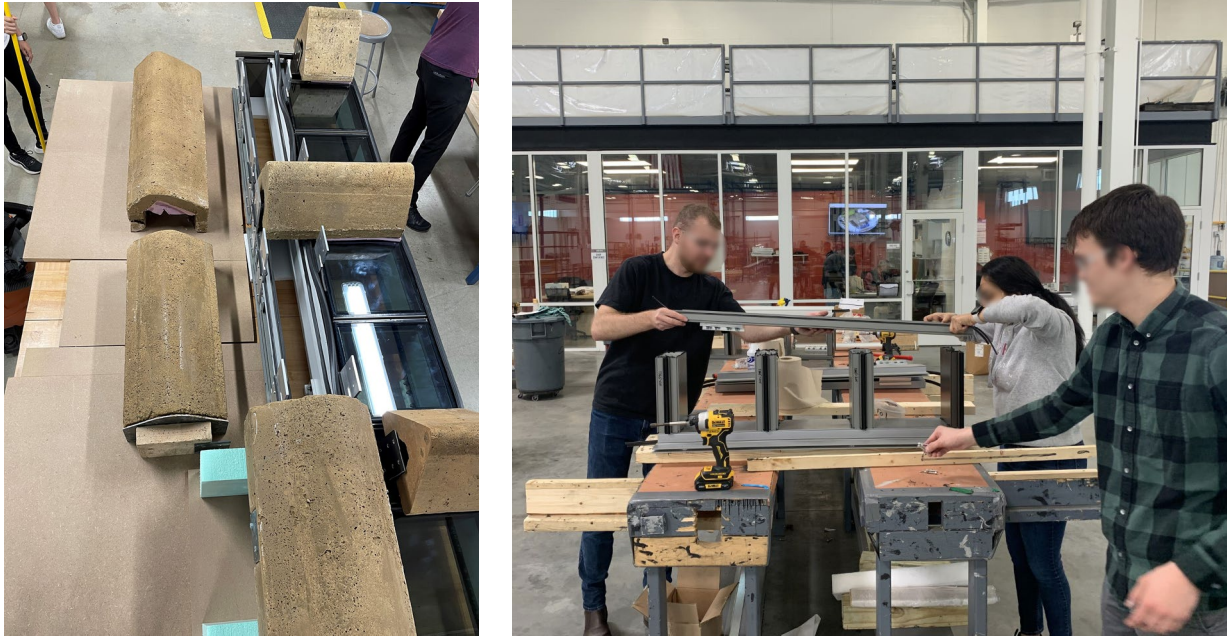

Figure 4 & 5: Seminar Students Assembling Units in Industry Partner's Facility. (Images by Author)

3.0 IMPLEMENTATION & RESULTS

3.1 Physical Results

Over the semester, students completed three full-scale mock-ups of unitized curtain wall assemblies. Funding for the unitized parts was donated by the industry partner as material and labor. Hundreds of person-hours were spent preparing digital files, meeting with the students, communicating with students, and producing shop drawings. A vendor donated the glazed units, and the college provided funding for the custom fabrications attached to the unitized systems. The three student groups developed mock-ups to best show their project, which took on a vertical or horizontal orientation. Depending upon orientation, projects were between 4' and 9' tall and 2'-6" and 6' wide. Each project was limited by the amount of glass available, 12 units, and the course budget. The overall elevational area of each mock-up remained relatively equal, at about 24 sq ft each. The depth of each assembly also varied, but each was roughly 18" to 24" from the back of the mullion, the furthest extent projecting outside of the glass. The mock-ups used full-scale details and materials for all parts, but the mock-up area was reduced from that applied to a building. Additionally, these three projects were installed for exhibit in Kent CAED gallery.

3.2 Collaborative Teaching

A complete understanding of the relationship between construction and design in a built work is impossible by one person, so students worked both with experts in the curtain wall industry, in the school's fabrication lab, and in teams where students served as project managers. As this was the first time teaching this particular seminar, much of the course specifics outside the overarching structure were negotiated as work progressed. The course delivery would not have been possible without the ideas and suggestions of the industry partner team and the college fabrication lab staff. The industry partner suggested the inclusion of the students in the actual performance of the fabrication early in the semester and completely changed the focus of the course from observation of construction labor to performing it themselves. While some degree of self-performance was assumed to take place in the college fablab, the scope of student involvement expanded immediately. The student on-the-ground experience working in both shops helped bridge the divide between architect as manager and fabricator, and subcontractor or manufacturer as a worker pervasive in academia and practice. Students worked not in an oversight role but participated in the fabrication of the units themselves with oversight from those traditionally viewed as labor. As a result, the management and laborer dynamic were reversed during a large part of the course. Anecdotally, this suspension of traditional building industry roles played out humorously when a tour of architects from a well-known national design firm, Kieran Timberlake, passed by the area where students were fabricating the mock-ups. Students reacted to being observed in this situation as laborers without the touring architects knowing their status as aspiring professionals as "uncomfortable" or making them "feel invisible." The situation was a topic of discussion amongst the students, with the workers from the industry partner laughing at the students' realizations.



Figure 6 & 7: Constructions by Group 1 and 3. (Seminar Group 1: Caleb O'Byron, Olivia Muchewicz, Jayda Vorndron, Drashty Rana, Devanshi Jariwala 2022, and Seminar Group 3: Austin Bayer, Ethan Prodin, Charles Thompson, Olivia Newbrough 2022)

3.3 Accomplishments & Lessons

All student teams completed the fabrication of their designs for the final review. Group 1's concrete parts did not fit correctly on the curtain wall as the dimension was changed during the shop drawing process and not found until the installation. This group's project was rebuilt over a small part of the summer to fit the fabricated curtain wall. There was a push for all teams at the end of the semester as fabrication intensified, and students had to travel to the industry partners' facility. This time crunch would be easily addressed in future versions of the course, as mock-up design did not take place until week 6 of the 18-week course. Keeping the custom parts material consistent across all groups would also simplify the disparity in the amount of work needed to fabricate the custom parts and allow for more direct comparisons between projects. Students needed more time to complete tasks that deviated too far from the initial course specified material, folded steel sheets. Regardless of this final push, student evaluations of the class were overwhelmingly positive. The lack of clear distinctions between the graduate and undergraduate students was notable at the end of the semester and provided evidence that the course content was impactful for all year levels allowed to enroll. The college's ongoing strong relationship with the industry partner allowed this course to succeed, as did having helpful shop staff to assist students within the school. A few students in the course interviewed for summer internships with the industry partner, and future versions of this course will surely place students in this fabrication environment professionally and academically.

Self critically, the narrow focus of the course does not provide the complete range of experience you might find in a design-build course or one as technically focused as a fabrication course. This course is a novel hybrid approach to teaching construction and could be repeated multiple times with different building elements. Within one student's education, a course of this type could be taken multiple times with various focuses on a single trade or contractor. Implementing courses of this type as a sequence would ideally result in a more significant cultural relationship between architectural academia and the local labor force near the school. It is impossible to gain a complete view of the material and people needed in building construction in one course as specialization is enforced within the profession and the academy. Buildings take teams for this reason, and the envelope construction focused upon in this course was the ripest for young architects to address the aesthetic, environmental, and political stakes of the architect in a focused location.

CONCLUSION

Full Scale as a model for architectural education focuses on design and architecture's relation to the labor or construction, manufacturing, and fabrication. Sidestepping a design-build focus on small-scale building, as a model of practice performed in the academy, and digital fabrication pedagogy as pure technique-based research, this course proposes a pedagogical model for teaching construction between practice and the academy. By focused on a singular building element at full scale the course placed students in a professional manufacturing facility to work alongside professionals in a direct relationship with labor typically removed from an architect's outlook. In normative practice, architectural decisions, aesthetic or otherwise, are seldom indexed in any way outside of cost, setting a contentious relationship between the labor constructing a project and the labor of those designing as each is abstracted from the other by professional convention. This manager vs. labor relationship is either not addressed in most fabrication courses or handled in an unfocused manner in most design-build courses. Full Scale, even in the experimental format it was delivered, focused on the labor needed to achieve one building element in detail by working directly as the labor constructing and designing. While each other course type has its pedagogical niche in the academy, Full Scale, as a course, is a model capable of being focused on many other building elements or taught in relation to other exterior wall systems. Working on a known assembly type with a labor force in place gave the students the ability to experience the labor needed to construct a small portion of a system which could be scaled radically. Through the performance of labor directly, these students can make informed design decisions in the future through direct knowledge. By teaching students to understand their position as one that coordinates large amounts of resources and labor towards design, Full Scale prepares students, through a scaled performance, to have an informed relationship with construction labor.

REFERENCES

- Canizaro, Vincent. 2012. "Design-Build in Architectural Education: Motivations, Practices, Challenges, Successes and Failures." *International Journal of Architectural Research Archnet-IJAR* 6, no. 3 (November 2012): 20–36.
- Carpenter, William Joseph. 2014. "Digital Fabrication and the Design Build Studio." In *102nd ACSA Annual Meeting Proceedings, Globalizing Architecture/ Flows, and Disruptions*. Miami Beach.
- Galloway, William. 1996. "Ruskin's Road: Architecture and the Object of Work." In *Proceedings: 84th ACSA Annual Meeting & Technology Conference*, 539–43. Washington, DC: ACSA Press.
- Gramazio, Fabio, and Matthias Kohler. 2022. "Architecture and Digital Fabrication." – ITA Institute of Technology in Architecture | ETH Zurich.
- Kieran, Stephen, James Timberlake. 2004. "Role Reminders in the New World." Essay. In *Refabricating Architecture: How Manufacturing Methodologies Are Poised to Transform Building Construction*, 25–48. New York, NY: McGraw-Hill.
- Lonnan, Bruce. 2010. "Constructing Design in the Studio: Projects That Include Making." In *98th ACSA Annual Meeting Proceedings, Rebuilding*. New Orleans.

Generative Urban Design: A Workflow Integrating Real-World Mobility, Zoning, and Multi-Objective Simulation

Peng Du¹, Nithin Cheluva Ranganath Mavinkere¹, Yang Yang²

¹Thomas Jefferson University, Philadelphia, PA

²Cornell University, Ithaca, NY

ABSTRACT: The problems involved in rapid urbanization are becoming extremely complex, and require collaborations across disciplines. New methods and tools are needed to better support urban designers in addressing environmental, organizational, and societal challenges. This paper introduces a generative urban design workflow integrating real-world transportation, zoning, and multi-objective simulation, and applies this workflow to a case study for a high-density and pedestrian-oriented development in the heart of Philadelphia's downtown area. The research started with building an urban model and running a real-world mobility simulation, by integrating three layers of data, including street network, amenities, and buildings. Based on the simulation result, the primary street network was designed following simulated pedestrian movement trends. Then, the secondary street networks, block offsets, and buildings were generated, and specifically, zoning policy was factored into the algorithm to control the building footprint and height. A multi-objective evolutionary algorithm (MOEA) was applied to optimize the performance of three design objectives including view access, green space, and solar exposure. As a result, 7,500 design solutions were generated and analyzed by the algorithm. The research also filtered the original large solution pool, and selected and evaluated the "best-performing solutions". Various parametric design software and data analytics tools were used in this research.

KEYWORDS: Urban Design, Generative Design, Multi-Objective Optimization, Mobility, Simulation

INTRODUCTION

With more than a million people moving to urban areas every week, and the global population projected to be 70% urbanized by 2050 – set against a backdrop of extreme environmental challenges relating to climate change and resource depletion – cities are facing profound challenges for substantial portions of their citizenship. Therefore, the problems involved in this urbanization process are becoming extremely complex, and require collaborations across disciplines (Du 2015). Because the urban design process tends to be very complex and interdisciplinary, various stakeholders need to participate in this process, and each stakeholder has their own complex and competing goals for the project (Besserud and Hussey 2011). However, traditional design methods struggle to address this need. Specifically, decisions regarding key urban performance drivers, such as land use, zoning, density, transportation, building morphology, energy consumption, and carbon emission, are often made by developing and refining only a very limited number of design proposals through manual iteration and experience, without rigorously testing the full range of possible design schemes (Wilson et al. 2019; Sun 2021). Therefore, new methods and tools are needed to better support urban designers in addressing environmental, organizational, and societal challenges.

In recent years, many researchers and designers have developed a generative design approach, which is a framework that involves the integration of a rule-based geometric system, a series of measurable goals, and a system for automatically generating, evaluating, and evolving a very large number of design options. We have seen more studies and applications of generative design in a variety of industries, such as engineering and industrial design, but much less in the urban design field. This paper introduces a generative urban design workflow, by integrating real-world urban mobility, zoning policy, and several other performance indicators, and its application in a case study for a high-density and pedestrian-oriented development in the heart of Philadelphia's downtown area. Various parametric design software and data analytics tools were used in this research.

1.0 BACKGROUND

The generative design approach can help urban designers navigate complex design problems and a multitude of competing goals across different stakeholder domains (Nagy, Villaggi, and Benjamin 2018). This intelligent design process normally involves three different types of tools: (1) parametric design software to model the geometry and space of all possible design options, (2) simulation software to quantify the performance of the metrics set for each design option, and (3) analytical platform to filter large groups of design options to identify the highest-performing options. Based on the nature of the urban design process, which is multi-objective and multi-objective, evolutionary algorithms (MOEAs) have been recently used in generative design processes to solve complex design problems. This method uses principles of evolution to create sequential generations of design solutions and evolve them to contain higher-performing design solutions over time (Nagy et al. 2017). Therefore, MOEAs can enable urban designers to

simultaneously address multiple design objectives that are competing against one another without necessitating trade-off decisions between the design goals (Showkatbakhsh and Makki 2022).

An increasing number of studies have applied MOEAs through generative urban design to optimize urban forms measured by a set of quantifiable design objectives, and conduct data-driven and comparative visual analysis (Balling et al. 1999; Koenig et al. 2020; Choi, Nguyen, and Makki 2020), however very few studies were conducted in a real-world urban context by taking account of its dynamic urban mobility and zoning policy. Most of the mobility simulations in the previous studies were operated based on the distance and density analysis of points of interest (POI) in cities, and the most commonly used approaches are Space Syntax and Walkability Score (Hillier 1996; Brewster et al. 2009). However, the problem with such approaches is their insensitivity to the interactive relationships between key urban network indicators in practice, such as street network, amenity allocation, and population distribution (Yang, Samaranayake, and Dogan 2020). Also, most of the studies on urban form generation have focused on finding the optional solutions in theory, but ignored the existing urban planning and design policies in real cities, such as zoning regulation and land use policy. Therefore, the methodology introduced in the following section fills these two research gaps by developing a workflow integrating real-world mobility, zoning, and multi-objective simulation.

2.0 RESEARCH METHODOLOGY

2.1. Urban mobility simulation and urban massing generation

An urban model was created using the Urbano, an urban mobility modeling plugin for Rhino/Grasshopper, with data loaded from GIS, OpenStreetMap (OSM) and Google Places (Dogan et al. 2020; Dogan, Samaranayake, and Saraf 2018). A pedestrian movement simulation was conducted in a larger urban area beyond the study site, and the results were used to design primary street networks within the study site. There are three layers of data that were integrated into this real-world mobility simulation: street network, amenities (points of interest), and buildings with building-level population information. Therefore, the primary street network was designed by following the trends of the pedestrian movements. Then an algorithm was created to generate secondary street networks, block offsets and buildings. Specifically, the zoning for the site, e.g., max. floor area ratio (FAR), was factored in the algorithm to control the building footprint and height based on the formula below. The building forms were generated through an extrusion of building footprints in order to simplify the entire urban massing model. Also, additional bonuses were applied to the FAR in order to maximize the density.

$$\text{Building Height (No. of floors)} = \frac{\text{FAR} \times \text{Parcel Area}}{\text{Standard Floor Area}}$$

2.2. Multi-objective simulation and solution selection

A multi-objective evolutionary algorithm (MOEA) was conducted by using the Wallacei, an evolutionary and analytic plugin for Rhino/Grasshopper, to evaluate and optimize the performance of each design objective of every single iteration. A major advantage of employing an MOEA is the algorithm's capacity of solving multiple, sometimes even conflicting, objectives without having to make trade-off decisions (Showkatbakhsh and Makki 2022). Given the large size population (number of iterations) generated, the pareto front solutions, a set of non-dominated solutions, being chosen as optimal, if no objective can be improved without sacrificing at least one other objective, were selected firstly. This approach allows researchers to focus on the set of optimized trade-off solutions, and to make further trade-off decisions within this set, rather than considering the full range of every solution to seek for the most optimal one. A K-means clustering algorithm was then applied, so the solution closest to the center of each cluster was selected. In addition, more solutions were selected for the final evaluation, including the most optimal solution for each design objective, the solution closest to the "Utopia" point across all the design objectives, as well as the solution with the most equal weight between all the design objectives.

3.0 GENERATIVE DESIGN AND EVALUATION

3.1. Site Analysis

The site is in the Center City area of Downtown Philadelphia, between Spring Garden Street and Callowhill Street, and between North 9th and 5th Streets (see Figure 1). The area of the site is approx. 193,700m³, and a huge part of the site is currently occupied with parking lots and vacant/unused spaces. Therefore, the study site is considered a vacant area with three north/south streets remaining, including 6th, 7th, and 8th streets, as well as three preserved buildings, including two landmarks Willow Steam Generation Plant (close to the west boundary of the site) and Franklin Music Hall (in the middle of the site), and a Target store (close to the east boundary of the site). The site is located in the heart of the dense and vital Downtown Philadelphia, but it is currently facing two main challenges: (1) there is no meaningful open/green space in the site; (2) there is a lack of vitality in the areas adjacent to the landmark Franklin Music Hall, which is a concert venue in Philadelphia with a capacity 3,000 people, due to the lack of amenities and open spaces. The zoning of the site is CMX-3 (Commercial Mixed-Use), with a maximum occupied area of the lot 75% intermediate or 80% corner, as well as a maximum of FAR 500%. As additional bonuses, Green Buildings could get additional FAR up to 100% (Philadelphia City Planning Commission 2022).

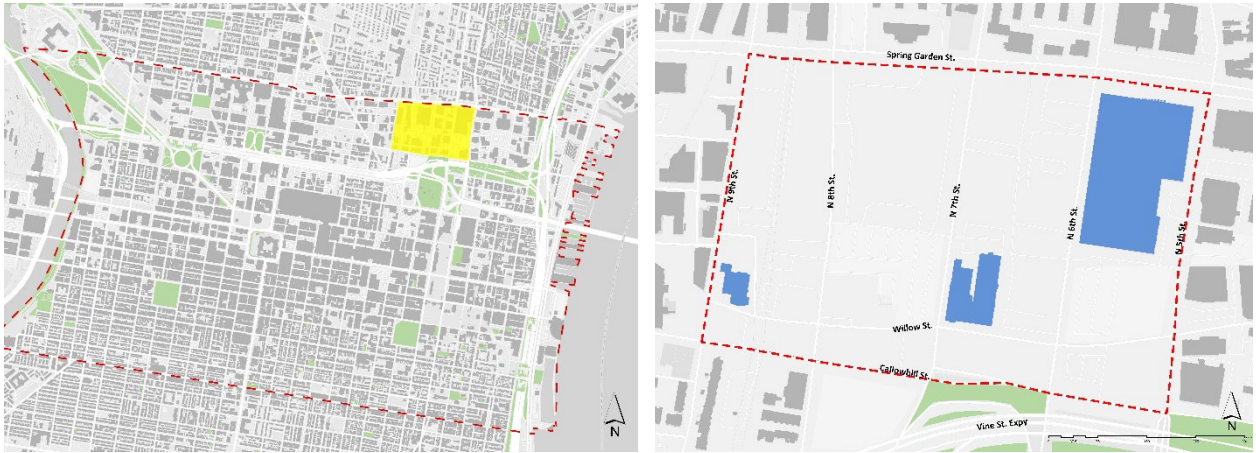

Figure 1: Study site: (left) the site location within the Center City area; (right) the site and its urban context, with three preserved existing buildings highlighted in blue. Source: (Authors 2022)

3.2. Generative process

The generative process of the urban form, as shown in Figure 2, has five major steps including (1) conducting pedestrian movement simulation for the site and its surrounding areas; (2) defining the primary street network based on the mobility simulation; (3) generating secondary street network and block offsets based on the defined primary street network as well as the context of the surrounding urban fabric; (4) dividing blocks to parcels with possible green spaces; (5) generating building massing based on the zoning regulations.

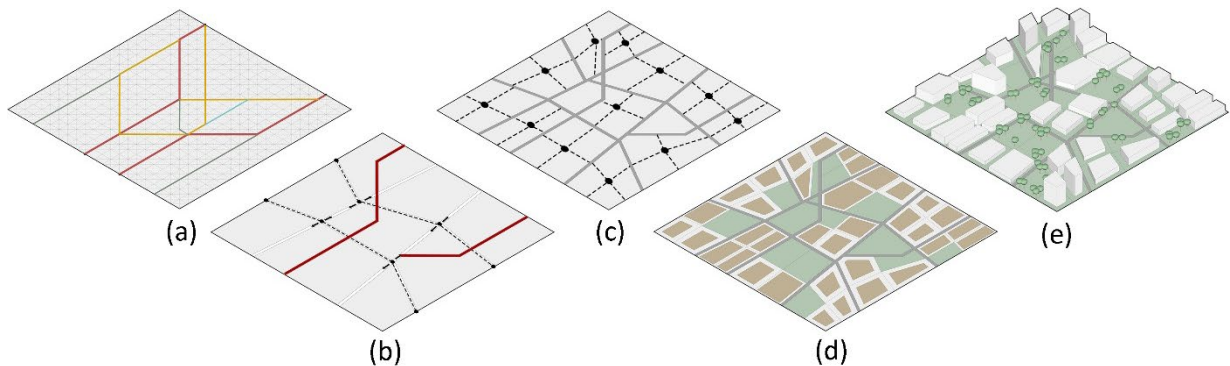

Figure 2: Five steps involved in the generative process of urban form: (a) mobility simulation; (b) primary street network; (c) secondary street network with blocks; (d) parcel; (e) building. Source: (Authors 2022)

A 3D parametric urban model within the circular area (1km radius from the center of the site), integrated with the data of existing street network, amenities (points of interest), and buildings (population), was created using the Urbano Grasshopper plugin. Specifically, a 20m x 20m grid covering the site was created to serve as a virtual environment, through which people can walk across the site freely. Each intersection point of the grid represented a potential location for a building or amenity that people can access to. Through the pedestrian movement simulation via Urbano, "Street Hits" which counts how many people use a certain street segment for all trips was used to reveal people's potential pedestrian trails across the site. As a result, those street segments with high "hits" indicated a strong pedestrian movement trend, which was further transformed into the primary street network (see Figure 3). Therefore, the primary street network consisted of the proposed new streets based on the simulation results, plus three remained north/south streets.

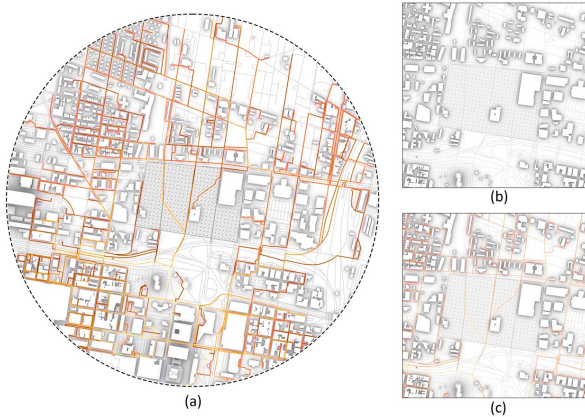

Figure 3: Urban mobility simulation: (a) Pedestrian movement simulation for the site and its surrounding areas; (b) 20m x 20m grid without mobility simulation; (c) 20m x 20m grid with mobility simulation. Source: (Author 2022)

The secondary street network was generated via the following steps: (1) horizontally connecting the major intersections between the two north-south site boundary streets (North 9th and 5th Streets) and the existing streets beyond the site boundary; (2) each intersection between these newly added streets and the previously defined primary streets was set within a moving range 50m only the primary streets in order to possibly create more dynamic street structures; (3) each block created by the primary and secondary streets was further divided into four parts. Therefore, unlike the primary street network, the secondary street network was not fixed. Then, each street center line was offset to form individual pedestrian paths with a street width of 6m. The created blocks were further divided into parcels, of which 10% are defined as green spaces. Also, any parcel smaller than 1,000 m² automatically became green space to avoid an unrealistic size or shape of the building footprint that doesn't fit the existing urban fabric. Finally, FAR 600% (max. FAR 500% with an additional 100% bonus) was applied to the rules of building massing generation to maximize urban density as illustrated in the methodology section. As demonstrated in the research methodology section, this fixed FAR impacts two variables of buildings: footprint and height.

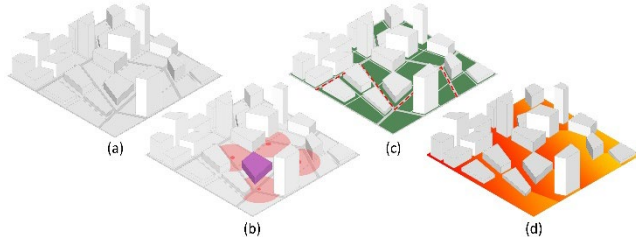

Figure 4: Design objectives for simulation: (a) massing model; (b) view access; (c) green space; (d) solar exposure. Source: (Authors 2022)

3.3. Simulation

Based on the two major challenges introduced in the site analysis section, the study set up three quantified Design Objectives, including (1) increasing the openness of the areas (m²) adjacent to the landmark Franklin Music Hall, measured by the total area of the unobstructed view on the ground level from the Franklin Music Hall towards its surrounding context. Specifically, a circular area with a 50-meter radius was created to represent a reasonable distance for human view access in outdoor spaces. (2) increasing green spaces, measured by the total area (m²) of green spaces on the ground level; (3) increasing the solar exposure on the ground level in winter, measured by the percent (%) of the total ground surface area exposed to the sun (streets + green spaces). To save the simulation time, only 12 pm on the first day of the “extreme cold week” in Philadelphia was analyzed. Figure 4 shows the three Design Objectives for simulation.

4.0 ANALYSIS AND SELECTION

4.1. Algorithm results and analysis

The algorithm ran a population comprised of 500 generations with 15 iterations in each generation via Wallacei, totaling 7,500 iterations. Figure 5 shows an overview of the algorithm results. As the mean value trendline shows, the simulation was successful in improving the mean values for Design Objectives 1 and 3 (view access and solar exposure), but the variation of solutions was fluctuating throughout and not converging towards an optimal result for Design Objective 2 (green space). In other words, the simulation was more effective in finding the “best performing solution” for the Objectives 1 and 3 out of the total 7,500 iterations. Also, as the standard deviation (SD) shows, Design Object 3 (solar exposure) presents a greater SD value than Design Objectives 1 and 2 (view access and green space).

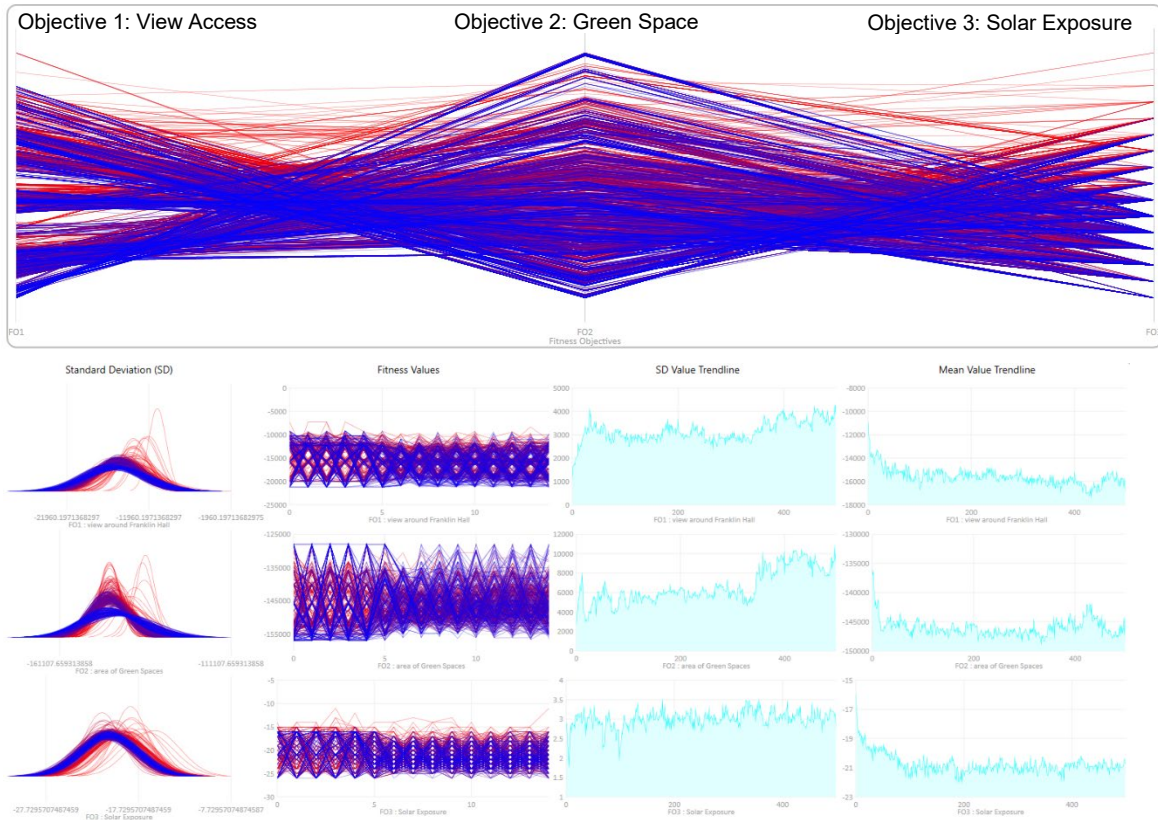

Figure 5: Algorithm Results: (top) parallel coordinate plot; (bottom from left to right) standard deviation, design objective values, standard deviation trendline, and mean value trendline. Source: (Author 2022)

4.2. Selection process and evaluation

MOEAs in urban design also require a rigorous selection process to critically review and select the generated solutions. The process started with filtering the entire population (e.g., 7,500 iterations) down to a significantly smaller pool of solutions by selecting pareto front solutions. Specifically, 184 solutions were selected from a total of 7,500 iterations. A K-means clustering algorithm was then applied, with 10 clusters in total (Figure 6). The solution closest to the center of each cluster was selected, so the number of selected solutions was down to 10. In addition, five more solutions were selected for evaluation, including the optimal solution for each design objective (e.g., the largest area of green spaces, greatest percent of the areas of the streets and open spaces exposed to the sun in winter, and best view access around the landmark Franklin Music Hall), the solution that is the same (or the closest to the same) value for all three design objectives, and the solution that has the optimal average value of all three design objectives. Therefore, the number of the selected solutions becomes 15 after adding these 5 solutions, which is the pool for the final comparison and evaluation (Figure 7).

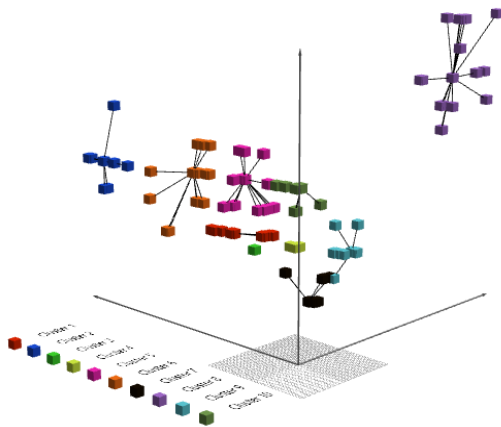

Figure 6: The K-means clustering of the pareto front solutions with 10 clusters in total presented through the objective space. Source: (Author 2022)

Solution 1 has the same (or the closest to the same) value for all three design objectives, and Solution 2 has the optimal average value for all three design objectives. Compared to Solution 1, Solution 2 is only 1% less in solar exposure but has a greater value of both view access and total green space. Solutions 3-5 are the optimal solution for solar exposure, total green space, and view access around the Franklin Music Hall, respectfully. The optimal solution for one objective is normally found to have a poor performance for the other objectives. Solution 4 has the largest area of green space (156,928m²) but the least view access and the least solar exposure, so it is not desirable. Solution 5 has the greatest view access around the Franklin Music Hall (21,280m²), meaning that it has the largest public space around this landmark building among all the solutions, although it has less green space and low-level solar exposure. Interestingly, it is also found that green spaces are gathered in the west and north of the Franklin Music Hall, and further extended to the site boundaries. An “L” shape “green corridor” is formed where the Franklin Music Hall sits at the middle point. Therefore, this solution might be arguably the most desirable option, as the lack of meaningful public space and urban vitality are the two biggest challenges for this site as introduced above, and creating high-quality public space is more important than simply increasing the size of green space across the site. Obviously, the public space around the Franklin Music Hall would be an ideal place for people to gather, and the continuity of green space connecting the west and north boundaries of the site would help attract people to enter the site, particularly to walk to the landmark Franklin Music Hall.

Solutions 6-10 are the 10 selected solutions after the K-means clustering of the pareto front solutions was implemented. Specifically, Solution 9 is very interesting from the design viewpoint. The value of the view access around the Franklin Music Hall is close to the low end, and the total green space is just a little above the average, but each of the preserved existing buildings, Willow Steam Generation Plant, Franklin Music Hall, and the Target store, has considerable-size public space adjacent to it. Instead of creating one large public space around one single building, the public spaces created in this design option are located adjacent to different important buildings. Therefore, the distribution of public spaces could also bring urban vitality across the site. The greatest solar exposure this solution offers also support this idea by increasing thermal comfort in winter.

CONCLUSION

This paper proposes a generative and performance-oriented urban design workflow integrating real-world transportation, urban policy, and multi-objective simulation, and applies this workflow to an urban design project in Downtown Philadelphia. Specifically, the study built an urban model with population and amenity data and conducted pedestrian movement simulation to help design the street network. Zoning was integrated into the algorithm to generate urban forms that are regulated by zoning and land use policy. The study defined three qualified design objectives (view access, green space, and solar exposure), and ran a multi-objective evolutionary algorithm (MOEA) to seek the optimal solutions. Finally, the study filtered the original large solution pool (7,500 iterations), and selected and evaluated the “best-performing solutions”.

There are several limitations in this study that are important to consider when designing future research. First, only pedestrian movement was simulated to generate pedestrian paths on the site. The mobility by other modes of transport, such as car, bus, or bicycle, could be simulated, so the streets could be designed differently to accommodate different transport behavior. Second, the study applied a fixed FAR (e.g., 6) to the algorithm, so a wide variety of building massing models (e.g., footprint and height) has not been seen in the final selected solutions. This doesn't reflect urban developments in reality either, as different parcels could end up with different FARs even though they are regulated by the same zoning policy. Therefore, future research could apply different FARs (up to the max. FAR required by the local zoning policy) associated with different groups or types of buildings as a variable to the workflow. Lastly, more quantifiable metrics, such as energy, carbon, accessibility, and daylight, could be incorporated into the workflow as additional Design Objectives or selection criteria to achieve more comprehensive design decision-making.

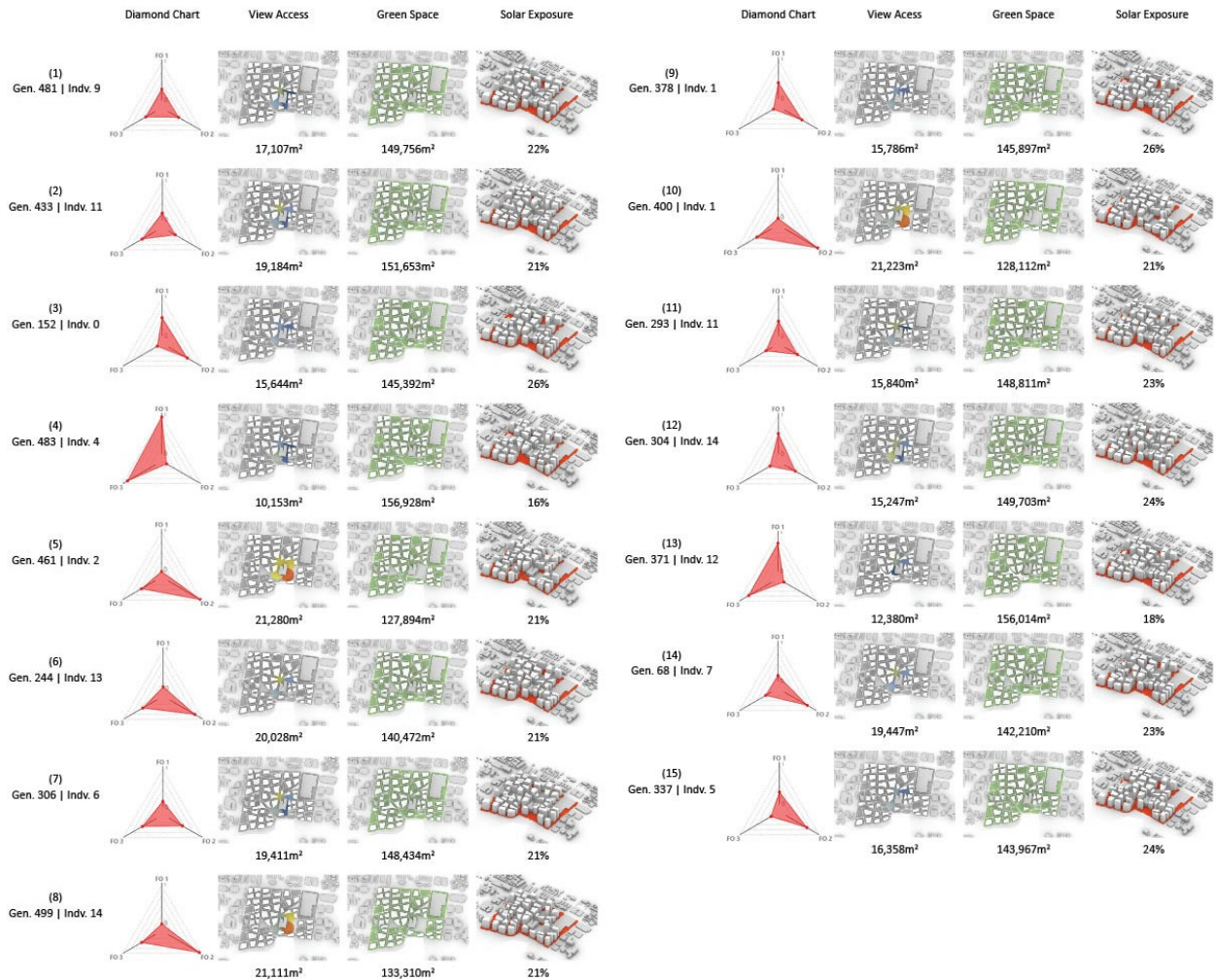

Figure 7: Evaluation results of the selected solutions for a final comparison. Source: (Author 2022)

ACKNOWLEDGEMENTS

The study presented in this paper was part of the research titled “Create a Smart Mobility Platform for Analyzing and Visualizing the Effects of Urban Mobility on Population Health in the Center City of Philadelphia”, funded by the Jefferson Smart & Healthy Cities Fellowship Seed Grant.

REFERENCES

Balling, R. J., J. T. Taber, M. R. Brown, and K. Day. 1999. “Multiobjective Urban Planning Using Genetic Algorithm.” *Journal of Urban Planning and Development* 125 (2). <https://trid.trb.org/view/503961>.

Besserud, K., and T. Hussey. 2011. “Urban Design, Urban Simulation, and the Need for Computational Tools.” *IBM Journal of Research and Development* 55 (1.2): 2:1-2:17. <https://doi.org/10.1147/JRD.2010.2097091>.

Brewster, Mark, David Hurtado, Sara Olson, and Jessica Yen. 2009. “Walkscore.Com: A New Methodology to Explore Associations Between Neighborhood Resources, Race, and Health.” In .

Choi, Jason, Phat Chi Thanh Nguyen, and Mohammed Makki. 2020. “The Design of Social and Cultural Orientated Urban Tissues through Evolutionary Processes.” *International Journal of Architectural Computing*, September. <https://doi.org/10.1177/1478077120951948>.

Dogan, Timur, Samitha Samaranyake, and Nikhil Saraf. 2018. “Urbano: A New Tool to Promote Mobility-Aware Urban Design, Active Transportation Modeling and Access Analysis for Amenities and Public Transport.” In *Proceedings of the Symposium on Simulation for Architecture and Urban Design*, 1–8. SIMAUD '18. San Diego, CA, USA: Society for Computer Simulation International.

Dogan, Timur, Yang Yang, Samitha Samaranyake, and Nikhil Saraf. 2020. “Urbano: A Tool to Promote Active Mobility Modeling and Amenity Analysis in Urban Design.” *Technology|Architecture + Design* 4 (1): 92–105. <https://doi.org/10.1080/24751448.2020.1705716>.

Du, Peng. 2015. “Environmental and Social Sustainability Implications of Downtown High-Rise vs. Suburban Low-Rise Living: A Chicago Case Study.” ILLINOIS INSTITUTE OF TECHNOLOGY. <http://gradworks.umi.com/10/00/10007536.html>.

- Du, Peng, Antony Wood, Nicole Ditchman, and Brent Stephens. 2017. "Life Satisfaction of Downtown High-Rise vs. Suburban Low-Rise Living: A Chicago Case Study." *Sustainability* 9 (6): 1052. <https://doi.org/10.3390/su9061052>.
- Du, Peng, Antony Wood, and Brent Stephens. 2016. "Empirical Operational Energy Analysis of Downtown High-Rise vs. Suburban Low-Rise Lifestyles: A Chicago Case Study." *Energies* 9 (6): 445. <https://doi.org/10.3390/en9060445>.
- Hillier, Bill. 1996. *Space Is the Machine: A Configurational Theory of Architecture*. Cambridge: Cambridge University Press. <http://catdir.loc.gov/catdir/toc/cam023/95021500.html>.
- Koenig, Reinhard, Yufan Miao, Anna Aichinger, Katja Knecht, and Kateryna Konieva. 2020. "Integrating Urban Analysis, Generative Design, and Evolutionary Optimization for Solving Urban Design Problems." *Environment and Planning B: Urban Analytics and City Science* 47 (6): 997–1013. <https://doi.org/10.1177/2399808319894986>.
- Mueller, Johannes, Hangxin Lu, Artem Chirkin, Bernhard Klein, and Gerhard Schmitt. 2018. "Citizen Design Science: A Strategy for Crowd-Creative Urban Design." *Cities* 72 (February): 181–88. <https://doi.org/10.1016/j.cities.2017.08.018>.
- Nagy, Danil, Damon Lau, John Locke, Jim Stoddart, Lorenzo Villaggi, Ray Wang, Dale Zhao, and David Benjamin. 2017. "Project Discover: An Application of Generative Design for Architectural Space Planning." In *Proceedings of the Symposium on Simulation for Architecture and Urban Design*, 1–8. SIMAUD '17. San Diego, CA, USA: Society for Computer Simulation International.
- Nagy, Danil, Lorenzo Villaggi, and David Benjamin. 2018. "Generative Urban Design: Integrating Financial and Energy Goals for Automated Neighborhood Layout." In . <https://doi.org/10.22360/simaud.2018.simaud.025>.
- Philadelphia City Planning Commission. 2022. "Philadelphia Zoning Code Quick Guide." <https://www.phila.gov/documents/zoning-code-information-manual-quick-guide/>.
- Showkatbakhsh, Milad, and Mohammed Makki. 2022. "Multi-Objective Optimisation of Urban Form: A Framework for Selecting the Optimal Solution." *Buildings* 12 (9): 1473. <https://doi.org/10.3390/buildings12091473>.
- Sun, Yue. 2021. "Generative Methods for Urban Design and Rapid Solution Space Exploration," August. <https://doi.org/10.7298/x38h-7w50>.
- Wilson, Luc, Jason Danforth, Carlos Cerezo Davila, and Dee Harvey. 2019. "How to Generate a Thousand Master Plans: A Framework for Computational Urban Design." In *Proceedings of the Symposium on Simulation for Architecture and Urban Design*, 1–8. SIMAUD '19. San Diego, CA, USA: Society for Computer Simulation International.
- Yang, Yang, Samitha Samaranyake, and Timur Dogan. 2020. *An Adaptive Workflow to Generate Street Network and Amenity Allocation for Walkable Neighborhood Design*. <https://doi.org/10.7298/bmn8-0y37>.

Global United Spatial Systems: Toward Immersive Conviviality

Keith Kaseman¹

¹Georgia Institute of Technology, Atlanta, GA

ABSTRACT: Mixed Reality (MR) technologies have proven practicable for numerous purposes across many sectors. Recent MR research throughout architecture reveals myriad opportunities for new approaches to spatial practice and production. From immersive modes of visualization and design interactivity to holographic fabrication, assembly, on-site verification, and construction, MR applications are also uniquely imbued with capacities inherently geared to prompt and facilitate beneficial collaborative engagement. This paper presents work that contributes to the field through its sharpened focus on these distinct potentialities and their plausibility to invite broader inclusion within design and production processes. Global United Spatial Systems is a recently launched research and design initiative that aims to envision, develop, and demonstrate working scenarios in which MR applications can be tuned and deployed to spark uniquely convivial atmospheres for collaborative architectural design in a wide array of settings. Cumulatively developed through the confluence of a technologically advanced research lab with a seasoned design practitioner at its helm, associated design-research seminars, and intensive bi-institutional workshops, user-friendly participatory MR design and production tactics serve as the common denominator throughout the varied work. Utilizing Fologram, a commercially available MR platform that links dynamic digital models in real-time to the Microsoft HoloLens and personal devices, various customized collaborative MR design-production interfaces, applications, and approaches are described and discussed. Operating under the premise that this line of research is intrinsically linked to design, the highly technical work aims to utilize and direct MR approaches toward new opportunities for lively architectural collaboration and spatial production. While all work presented here has been carried out within academic architectural research settings, the prime objective for future development is to orchestrate and test MR approaches with broader arrays of participants and players.

KEYWORDS: Mixed Reality, Participatory Design Systems, Inclusive Collaboration, Immersive Environments

INTRODUCTION

Advancements in Mixed Reality in Architecture demonstrate many constructive applications and beneficial opportunities embedded within immersive approaches to spatial production. Defined as an operational spectrum between actual physical space and complete virtual immersion (Kishino and Milgram, 1992), mixed reality (MR) has emerged as a viable platform for developing new modes of practice and work across multiple sectors (Bekele et al., 2018; Peters et al. 2018) including the architecture, engineering, and construction industry (Davila et al. 2020; Pishdad-Bozorgi et al. 2020). MR has been shown to provide numerous advantages in collaborative design work settings, including the benefits of co-designers sharing augmented physical workspaces, enrichment of the spatial experience as such, and the intuitive interactivity achievable with 3D objects and spaces that is not available in traditional 2D viewing on a screen (Wang et al. 2020). Additionally, recent research emphasizes the added value of shared social presence available through cooperative augmented reality approaches (Osmers et al., 2021).

Recent MR-assisted design, fabrication, and construction developments reveal an ever-expanding set of productive workflows enabled by spatial awareness technologies. Notable examples include demonstrations of MR design adjustability on the fly (Goepel 2018), MR-assisted construction of complex masonry (Jahn et al., 2020), and the intrinsically productive nature of collaborative MR approaches (Jahn et al., 2020). Such techniques have been utilized to reframe design studio pedagogy, emphasizing collaborative equity and rapid full-scale spatial production (Kaseman 2020). Live-action MR input devices, including a drone, game controller, and an optical motion capture system, have been woven into immersive collaborative design protocols (Dackiw et al., 2019). Additionally, research groups have incorporated gesture-driven interactivity into MR design and fabrication workflows (Yang et al., 2021). This paper presents recent and ongoing work that launches from and aims to augment this field by focusing on unique potencies offered by customized MR tactics geared for expanded levels of collaborative spatial design engagement and collective MR-assisted architectural production.

1.0 GLOBAL UNITED SPATIAL SYSTEMS

1.1 Overview and working attitude

Global United Spatial Systems (GUSS) is an ongoing research and design initiative that seeks to augment this field by placing a sharpened focus on customized MR working systems that operate through and generate convivial immersive

design environments and expansively collaborative architectural production. Imagine being able to sincerely ask almost anyone, even a child, to participate in a live collaborative design dialogue by simply flashing a thumbs-up sign with their hand and using it as a joystick to reconfigure a full-scale holographic model that everyone involved can see in a shared space. Alternatively, one may join an immersive on-site working session by flying a drone with a game console, moving about while holding a cell phone, or placing spatially tracked physical objects around a site to cooperatively activate geometric features of an easily operable parametric spatial system.

At the same time, digital models configured through such interactions can facilitate or directly drive a host of fabrication, assembly, and construction scenarios. Research developments throughout the nascent field of MR-assisted fabrication have presented various demonstrations through which new modes of cooperative architectural action can be conceived and enabled. For example, holographic instructions and interactive components can now be precisely overlaid onto physical production tools in real space (Jahn et al. 2019), thereby readily facilitating rapid and collaborative fabrication of complex parts and assemblies by non-expert participants. Removing the need to produce or communicate through drawings, the immersive nature of such setups provides numerous access points to inclusive, collaborative design and production scenarios.

GUSS is driven by the premise that design is innately enjoyable when orchestrated as an invitation for diverse exchanges of ideas through shared experiences in real time and space. The primary ambition of this project is to expand the positive reach of architecture and design into readily accessible and widely inclusive applications, collaborative engagements, and uniquely advanced collective spatial productions. As our capacities and insights have evolved throughout this endeavor, our overriding operational attitude is that performing architectural research in MR is inherently a matter of design. Meticulous technical work is required to design MR-enabled interfaces and scenarios as readily engageable spatial design systems; imagining new immersive modes of participatory invitation necessitates nuanced technological development.

2.0 COLLABORATIVE MR DESIGN SPACE

2.1. Participatory immersive multisystem

With graduate research assistants from Georgia Tech School of Architecture (MARCH) and the School of Electrical and Computer Engineering (MS), we initially embarked on this track by installing a technologically sophisticated immersive design environment and launching Spatial Futures Lab (SFL) in early 2019. We transformed an empty room into an interactive spatial computing volume by installing an optical motion capture system within a drone cage and linking physical objects and actions to digital models via Robotic Operating System (ROS). Next, we incorporated aerial robotics into our multisystem, enabling one to fly a drone with a game controller and utilize it as a live 3d cursor linked to real-time parametric spatial models. During these developments, Fologram, software that enables MR environments by connecting dynamic digital models to the Microsoft HoloLens and personal devices, was released as a commercially available platform. We acquired one HoloLens and rapidly incorporated MR into our system, thus enabling one to develop, control, and experientially visualize holographic models in real time by flying a drone with a game controller.

2.2. Interactively operable spatial systems

This robust platform has facilitated a range of immersive workflows, demonstrations, and incremental developments. We substantially amplified its base capacities by developing interactive MR spatial systems as demonstration modules that articulate cooperative potential and ease of operability with minimal training. One interface allows a drone operator to precisely snap to and activate points within a holographic 3-dimensional array, holographically highlighting such spatial actions and ensuing geometric operations. For example, an option within this MR module involves live parametric control of geometric volumes located at each point using the drone as an attractor point, a classic introductory lesson for parametric novices typically experienced only on a computer monitor.

We also developed an operable system that allows users to select panels from a holographic grid by tapping a phone screen. At the same time, a drone operator “extrudes” holographic box trusses out in space from the original grid location; during this operation, the phone user can adjust the taper and structural density of these box trusses. Upon agreement, the results can be baked, and the team can move on to the following selection from the original grid. Another demonstration module involved the placement and live tracking of a physical component within the immersive space, thus augmenting the interactive spatial scenario with a tangible geometric tool. We also developed a custom control algorithm for automated drone flight operations, which can be incorporated into and activated within our system; operators can toggle between manually driven and automated drone flight modes at any point during an immersive working session.

This immersive design environment requires two people to run the system, but it is optimal to have three operators working simultaneously, especially when performing intricate workflows. For example, one team member is tasked to fly the drone while wearing a HoloLens, initiating commands with the game controller. Another would typically be assigned to ascertain the data connectivity throughout the overall system, start the session, and monitor live action within the critical applications interconnected through ROS. A third operator can perform other cooperative tasks, which may involve moving around with a connected phone, initiating MR tasks through another HoloLens, or moving spatially tracked physical components throughout the space in coordination with others to perform the designated workflow. These dynamic working situations rely upon close verbal and gestural communication among team members; final

orchestration protocols naturally emerge through the process of designing, customizing, troubleshooting, and refining the MR spatial system at hand.

2.3. Pilot Workshop

An invitation to transport and install our complete MR design environment for a collaborative SFL workshop at the Institute for Advanced Architecture of Catalonia (laaC) in March 2020 provided our first opportunity to fully flex and assess the collaborative hypotheses built into our platform. Seventeen Master of Robotics in Advanced Construction (MRAC) students, none of whom had any knowledge of our system before day one, served as its premiere test users over one intensive week. Tasked to conceive and design cooperative MR environments and protocols for final demonstration projects, four teams developed and demonstrated collaborative MR workflows and applications geared to project future working scenarios in architecture and construction speculatively.

After a brief introduction and a day of essential training, teams rigorously co-opted the system's capacity to spark various working cooperative MR spatial design scenarios. Each group developed a different set of project goals and workflow procedures, taking turns with access to the overall workspace and system in one to two-hour dedicated increments. Notably, this focused regimen amplified the lively nature of each team's communication conventions and operational protocols. Additionally, technical developments during the workshop enhanced the sensing capabilities of the entire system, amplifying interaction capacities that could support real-time external robotic operations through spatial instructions. This work led to a set of refined interactive protocols developed by one team that involved immersive tagging of operable zones within the physical space, thus laying the foundations for responsive environmental scanning tactics (Figure 1). Another team utilized augmented manual collaborative UAV operations in physical space to develop an intricate multi-operator dataflow that ultimately orchestrated multiple functions into fully automated protocols. Compound tactics included automated flight path definitions, which enabled computational jigs to be distributed throughout interactive point clusters, thus activating localized geometric transformations triggered with the game controller used to fly the drone.

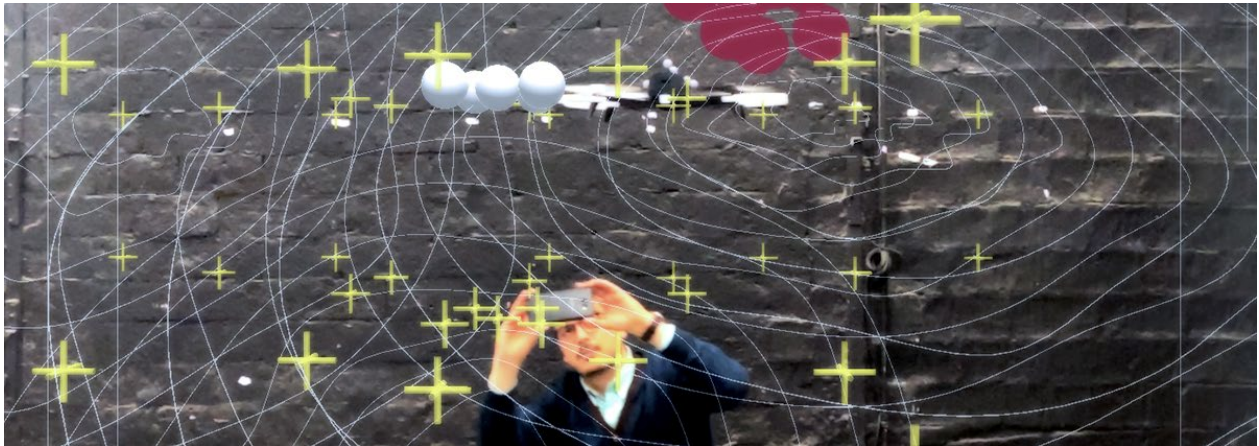

Figure 1: Multi-user / multi-device MR workspace incorporating real-time holographic spatial information. Source: (SFL + laaC 2020)

The overall process and resultant work were intricately immersive, highly engageable, and strikingly diverse. This experimental burst of activity not only served as our initial proof of concept that such an immersive design environment inherently provides a new way to think and work, but it also helped to tighten key technical protocols in the back end of our system. Most importantly, it proved abundantly clear that every participant and the extensive roster of guest reviewers found this way of working to be both convincingly constructive and notably enjoyable.

3.0 USER-FRIENDLY MR SPATIAL SYSTEMS

3.1. Tactics for broad participatory invitation

While the immersive platform described above can be tuned to incorporate user-friendly interfaces and interactions into specialized MR spatial design workflows, its ROS-enabled operation requires intermingled proximity and shared gear among multiple players. As such, the sudden shift in the state of the world in mid-2020 prompted and accelerated a turn toward operational simplicity, work safety, and collaborative enjoyability within our lab. Thus, we initiated a series of focused projects prioritizing ease of use as a critical criterion for inclusive MR collaborative spatial design systems. These working MR modules are also substantially simpler in technological terms – they do not rely on the complex ROS-enabled motion-capture multisystem previously described. Consequentially, this work is inherently more readily transferable to various collaborative scenarios and settings. Additionally, this work shift focuses on the intrinsic relationship between research and design: progressing combined MR tactics in this light relies upon intermingled developments in both technical terms and projective design-oriented ambitions and scenarios.

3.2. Multi-cart MR framework: move and click

Our first endeavor within this focused investigation began during the pre-vaccine era of the global pandemic in late 2020. Working most of the time remotely and meeting in person to test our progress every few weeks, our team of three set out to develop a sophisticated MR spatial system with an elegantly straightforward interface. We designed a complex medium-span holographic structural framework that is interactively adjustable through the mere placement and orientation of rollable physical carts. These physical interface tools are utilized as spatial markers that designate the arrangement and inclination of complex columns; the relative distance and combined orientations of three carts drive computations and resultant configurations of a node-based holographic spatial system (Figure 2).

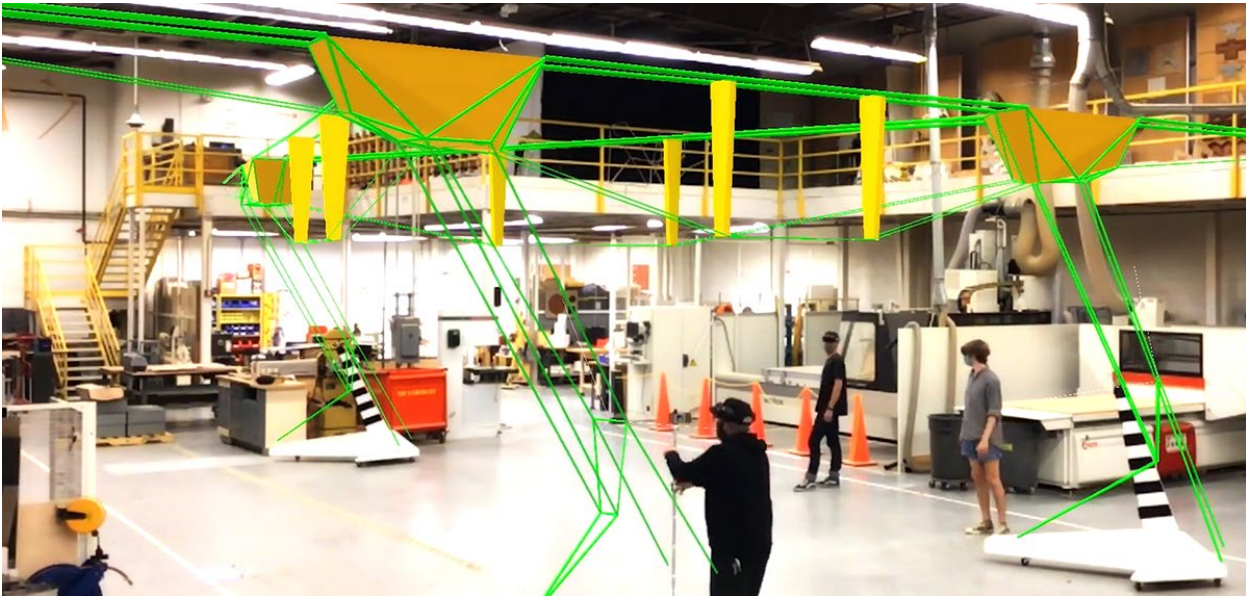

Figure 2: Spatial registration of rolling striped physical carts drives the computation of holographic geometry. Source: (SFL 2021)

Enabling spatial tracking of the carts is relatively straightforward: the orientation of each cart is trackable in Fologram through the HoloLens via a graphic marker or live phone attached to the top of an adjustable fin incorporated into each cart. With this setup, a user can move and rotate a cart into position, then either look at and register the graphic marker through the HoloLens or tap on the screen if the attached phones are in play. Once a cart is moved into a new position and spatially registered as such, the resultant structural framework model is automatically computed and represented in holographic space (Figure 3). In principle, both approaches can be used simultaneously during a session, thus providing the ability to invite participants into the mix with or without head-mounted MR devices. However, for our development purposes, we primarily utilized the integrated graphic marker approach; this simplified the dataflows during live sessions so that we could more easily focus on refining the computational definitions of the spatial framework during our limited in-person sessions.

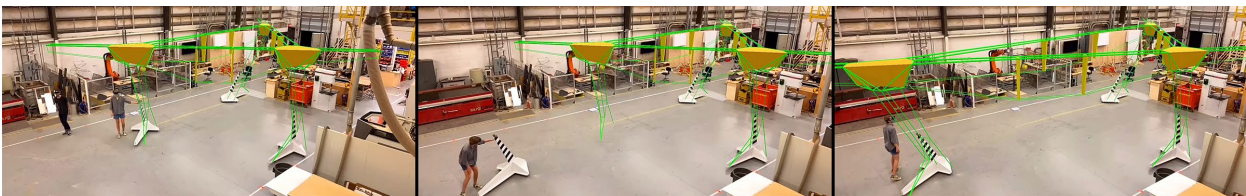

Figure 3: Configurational adjustments to the spatial geometry are made by moving the physical carts. Source: (SFL 2021)

With the overall system constrained to this simple interface and the physical presence of the rolling carts in play, participants can be invited to operate this spatial design application with little instruction. Additionally, given the relatively expansive area of the workspace, real-time coordination amongst active users naturally prompts amplified volume in verbal exchanges and reliance upon hand gestures to communicate at greater distances. All these aspects add to an engaging, immersive working experience that is palpably participatory and collaboratively dynamic. While future development of this system is poised to incorporate interactive analytics such as live structural analysis and material quantity tracking, its proof-of-concept state provides a working baseline through which cooperative MR design and production engagement can be imagined as an openly inclusive and lively process (Figure 4).

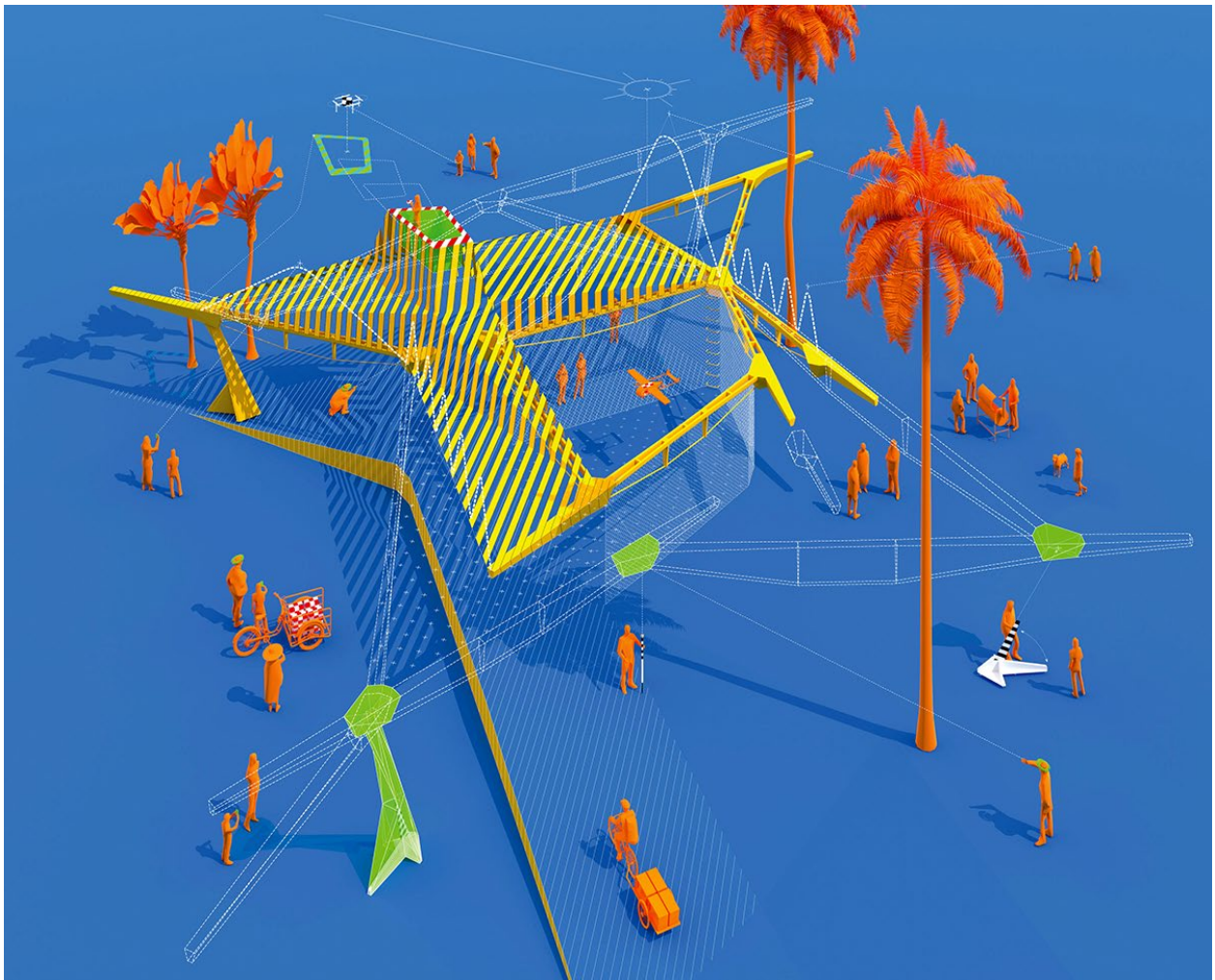

Figure 3: Projective depiction of a participatory MR spatial design engagement with combined approaches. Source: (Kaseman 2021)

3.3. Thumbs-up joystick

Enabled by the advent of the Microsoft HoloLens 2 and its ability to track twenty-five points per hand, customized gestures can be readily defined through programmed criteria in Fologram. This capability was directly infused into ongoing work within the lab and its associated research seminar upon acquiring six HoloLens 2 headsets. As a simple and positive tactic for inviting genuine collaborative MR conviviality, we promptly designed a definition that recognizes and responds to a thumbs-up along with its rotation on two axes; we then tied this interface to parametric spatial models. With this interface, one can, for example, flash a thumbs-up and use it as a joystick to easily modify multiple parameters and aspects of a holographic model.

3.4. Rapidly interactive 1:1 MR engagement

Upon developing a substantive set of customized gesture definitions and readily modifiable demonstration modules, we ran our second internationally bi-institutional cooperative MR workshop in early 2022. This time the focus was on rapidly developing and deploying readily engageable gesture-driven MR spatial design applications for a specific site in the city. Again, with a group of specialized architecture students with little to no experience with MR, the collective challenge was to train, practice, develop, and execute a final participatory project in five days.

Equipped with four HoloLens 2 headsets, teams of four ultimately designed interactive holographic models of dynamic 1:1 architectural intervention within inaccessible airspace above a low building across the busy street from our workshop space. After a brief introduction, general training, and a two-day project involving custom gestures and model interactivity, participants spent half a day preparing digital assets for the task. One team scanned the immediate urban fabric via photogrammetry and through the HoloLens' LIDAR by another; the resultant compiled model was then embedded with a spatial marker in Fologram such that all operable holographic models properly register in the physical context.

This setup allowed participants to work at a large table just inside a garage door directly facing our operative site for two full days, providing the opportunity to develop working MR applications while viewing the results in real space – effectively using the dynamic city as a holographic working monitor. This working scenario was productive and enjoyable, and the final workshop review session was held in this setting. As such, lively MR engagement with dynamic models primarily operable through custom gestures ensued between workshop participants, guests, and curious passersby.

3.5. Twenty-hour bike shed

Near the conclusion of an associated research seminar in which we modified a rod-bending Fologram definition for twenty students to incorporate an industrial electric rebar bender, we set out to perform another high-speed test. With only days left before graduation, an essential research assistant prompted the idea to expeditiously design and produce a bike shed by combining recently cultivated immersive workflows.

First, we utilized a working application developed within the lab that allows two players, each equipped with a HoloLens, to collaboratively model in MR space with key constraints tied to rebar bending and assembly. Participants can draw together in 3d space by establishing, snapping to, and adjusting critical geometry on the fly using a combination of customized and standard one- and two-handed gestures. Cooperative interaction and communication are readily facilitated through the ease with which participants remain active throughout a session; either player can initiate actions at any time simply by allowing a gesture to appear within the HoloLens field of view. In this setting, we established fixed geometry for a roof armature as a snappable holographic element. Then we designed the spatial configuration and key structural rebar elements for the shed in approximately one hour (Figure 4). We immediately shifted to MR-assisted high-tolerance fabrication of the complex rebar elements and component assembly (Figure 5); this was also a swift process.

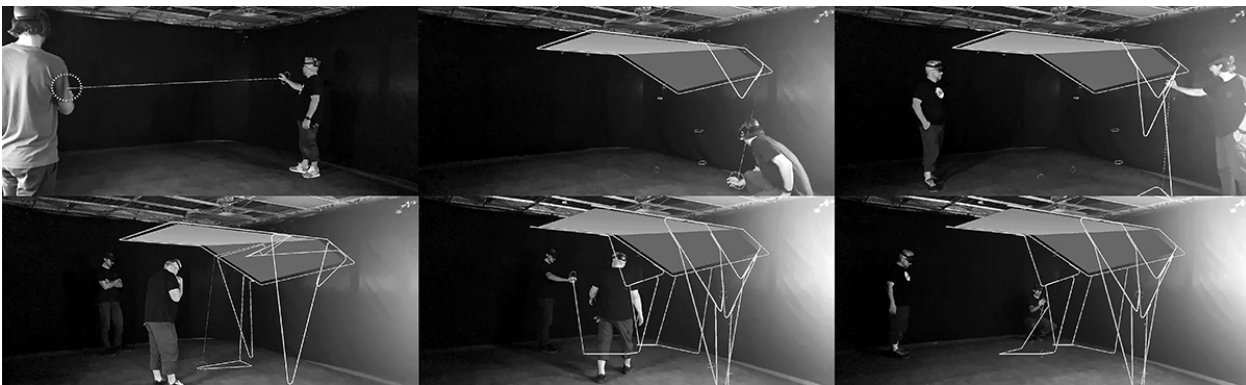

Figure 4: User-friendly and rapid collaborative MR modeling with customized gesture and alignment controls. Source: (SFL 2022)



Figure 5: MR-assisted rebar fabrication workflow: holographic bending, assembly, and final welding. Source: (SFL 2022)

Pre-weld preparation, which involves much grinding, brushing, and final welding, comprised most work hours within the entire process. Once the large transportable welded assemblies were clamped together in their finalized state, we designed additional key elements through MR. For example, bent rebar bike-locking components were holographically modeled in place to precisely integrate the geometry of two specific bicycle frames into the overall shed structure. With all these steps plus painting, transport, and final installation, this bike shed was designed and executed by two people in approximately twenty person-hours (Figure 6).



Figure 6: Final installation of the bike shed designed and produced through MR in twenty person-hours. Source: (SFL 2022)

As was proven through our associated seminar, primarily composed of prior MR and fabrication novices, the techniques that we used to produce the bike shed are readily trainable and provide many opportunities for inclusive participation. As such, this approach holds great promise for new customized modes of genuinely interactive architectural production, especially in terms of its potential transportability into various settings and purposes.

CONCLUSION

Global United Spatial Systems is an ongoing research and design initiative driven to catalyze genuine modes of inclusive, convivial architectural collaboration and production by leveraging MR technologies and customized approaches toward these ends. The work presented here is motivated by the latent prospects embedded in MR spatial design and production approaches to foster new participatory architectural conception and production modes. Several MR-enabled interfaces, applications, work settings, and demonstrations have been presented, each emphasizing collaborative working procedures and interaction opportunities uniquely achievable through immersive technologies. From the intricately configured ROS-enabled workspace that incorporates motion capture, aerial robotics, physical jigs, and dynamic models in live MR to the simplicity of using a thumbs-up as a joystick, the range of delineated tactics points toward various levels of social interaction and participatory invitation. Readily engageable interfaces aim to enhance this potential for broadened collaborative design engagements with an expansive roster of participants with backgrounds and areas of expertise.

Likewise, the capacity to develop and utilize customized gestures for holographic interaction provides user-friendly inroads for enhanced participatory reach and engagement. Additionally, the speed and ease with which novices can be trained in using and developing MR applications are noteworthy, as demonstrated through two intensive and experimental bi-institutional workshops. Rapidity is also highlighted in the production of a small complex structure fully designed and fabricated by two operators in a brief period through a customized, user-friendly cooperative MR workflow. Notably, and perhaps the most challenging aspect to accurately document, is the consistent observation that participants found the process and experience of working in collaborative MR design environments enjoyable in every case above. Further, once the automatic sense of novelty tied to a participant's first contact with MR and its capabilities wears off, the uniquely attractive benefits provided palpably persist in value over extended use. A prime objective of this work is to amplify this quality through participatory MR tactics and spatial systems that may serve as transportable opportunities and invitations for enriched cooperative architectural production.

ACKNOWLEDGEMENTS

Special thanks to Spatial Futures Lab research assistants from Georgia Tech School of Electrical and Computer Engineering, Abhishek Dutta (MS ECE 2018) and Prateek Vishal (MS ECE 2020), and Georgia Tech School of Architecture, Daniela Márquez (MArch 2020), Will Reynolds (MArch 2022), and Thomas Bray (BS Arch 2022) for their unbounded curiosity, diligence, and technical wizardry involved in the work described here. Additionally, our collaborative research workshops at the Institute for Advanced Architecture of Catalonia (IaaC) Master of Robotics in Advanced Construction (MRAC) proved indispensable for advancing our research. Special thanks to MRAC Co-directors Aldo Sollazzo and Alexandre Dubor, IaaC workshop assistants Soroush Garivani (2020) and Daniil Koshelyuk (2022), and the inspiring MRAC students we had the pleasure to work with for these invaluable sessions.

REFERENCES

- Bekele, Mafkereseb Kassahun, Roberto Pierdicca, Emanuele Frontoni, Eva Savina Malinverni, and James Gain. 2018. "A Survey of Augmented, Virtual, and Mixed Reality for Cultural Heritage." *Journal on Computing and Cultural Heritage* 11 (2): 1–36. <https://doi.org/10.1145/3145534>.
- Dackiw, Jean-Nicolas Alois, Foltman, Andrzej, Garivani, Soroush, Kaseman, Keith and Sollazzo, Aldo. 2019. "Cyber-physical UAV Navigation and Operation" In *Ubiquity and Autonomy*, edited by Kory Bieg, Daniel and Clay Odom, 360-369. Austin, Texas: Association for Computer Aided Design in Architecture (ACADIA). <https://www.researchgate.net/publication/340128045>.
- Davila, Manuel, Lukumon Oyedele, Peter Demian, and Thomas Beach. 2020. "A Research Agenda for Augmented and Virtual Reality in Architecture, Engineering and Construction." *Advanced Engineering Informatics* 45 (August): 101122. <https://doi.org/10.1016/j.aei.2020.101122>.
- Goepel, Garvin. 2019. "Augmented Construction - Impact and Opportunity of Mixed Reality Integration in Architectural Design Implementation." In *Ubiquity and Autonomy*, edited by Kory Bieg, Daniel Briscoe, and Clay Odom, 430–37. Austin, Texas: Association for Computer Aided Design in Architecture (ACADIA). <https://www.researchgate.net/publication/337561329>.
- Jahn, Gwyllim, Cameron Newnham, Nick van den Berg. 2020. "Collaborative Fabrication In Mixed Reality." *Data, Matter, Design*. Routledge. September 29, 2020. <https://doi.org/10.4324/9780367369156-82>.
- Jahn, Gwyllim, Cameron Newnham, Nick van den Berg, and Matthew Beanland. 2019. "Making in Mixed Reality." In *Recalibration on Imprecision and Infidelity*, edited by Phillip Anzalone, Marcella Del Signore, and Andrew John Wit, 88–97. Mexico City: Association for Computer Aided Design in Architecture (ACADIA). <https://www.researchgate.net/publication/330158065>.
- Jahn, Gwyllim, Cameron Newnham, Nick van den Berg, Melissa Iraheta, and Jackson Wells. 2019. "Holographic Construction." In *Proceedings of the Design Modelling Symposium, Berlin 2019*, edited by Cristoph Gengnagel, Olivier Baverel, Jane Burry, Mette Ramsgaard-Thomsen, and Stefan Weinzierl, 314–24. Springer International Publishing. https://www.researchgate.net/publication/335473933_Holographic_Construction.
- Kaseman, Keith. 2020. "Mixed Reality Design-Production Research through Cooperative Lab and Studio" In *Teaching - Learning - Research: Design and Environments*, edited by Laura Sanderson and Sally Stone, 75–86. Manchester, UK: Architecture Media Politics Society (AMPS) 22.1. <http://architecturemps.com/wp-content/uploads/2021/09/Amps-Proceedings-Series-22.1.pdf>
- Kishino, Fumio, and Milgram, Paul. 1994. "A Taxonomy of Mixed Reality Visual Displays." *IEICE Transactions on Information Systems* E77-D (12):1321–29. https://cs.gmu.edu/~zduric/cs499/Readings/r76JBo-Milgram_IEICE_1994.pdf.
- Osmer, Niklas, Michael Prilla, Oliver Blunk, Gordon George Brown, Marc Janßen, and Nicolas Kahrl. 2021. "The Role of Social Presence for Cooperation in Augmented Reality on Head Mounted Devices: A Literature Review." In *Proceedings of the 2021 CHI Conference on Human Factors in Computing Systems*, 1–17. Yokohama Japan: ACM. <https://doi.org/10.1145/3411764.3445633>.
- Peters, Terry M., Cristian A. Linte, Ziv Yaniv, and Jacqueline Williams. 2018. *Mixed and Augmented Reality in Medicine*. Boca Raton: CRC Press. <https://doi.org/10.1201/9781315157702>.
- Pishdad-Bozorgi, Pardis, Xinghua Gao, and Dennis Shelden. 2020. "Introduction to Cyber-Physical Systems in the Built Environment." In *Construction 4.0*, edited by Anil Sawhney, Mike Riley, and Javier Irizarry, 23–41. Routledge. <https://doi.org/10.1201/9780429398100-2>.
- Song, Yang, Richard Koeck, and Shan Luo. 2021. "Review and Analysis of Augmented Reality (AR) Literature for Digital Fabrication in Architecture." *Automation in Construction* 128 (August): 103762. <https://doi.org/10.1016/j.autcon.2021.103762>.
- Wang, Peng, Shusheng Zhang, Mark Billingham, Xiaoliang Bai, Weiping He, Shuxia Wang, Mengmeng Sun, and Xu Zhang. 2020. "A Comprehensive Survey of AR/MR-Based Co-Design in Manufacturing." *Engineering with Computers* 36 (4): 1715–38. <https://doi.org/10.1007/s00366-019-00792-3>.

Green Skins for Gray Buildings: How High-Performance Building Envelope Retrofits Impact Occupants' Health and Well-Being?

Ihab M.K. Elzeyadi¹, Stanley Gatland II²

¹University of Oregon, Eugene, OR

²Saint-Gobain North America, Malvern, PA

ABSTRACT: Employers, developers, and designers are persuaded, in response to an increasing marketing campaign by the green building industry, that LEED-certified buildings affect the health and well-being of occupants in many ways. With staff accounting for 90% of business operating costs, a 1% improvement in productivity can have a major impact on the bottom line and competitiveness of any business. Building developers are also discovering the business value of delivering healthy and green buildings to their markets, which are tied to increasing rent and competitiveness in office buildings real estate. Despite the favorability of these hypotheses, most recent studies have failed to systemically prove these linkages leading to non-conclusive evidence of green building performance. In addition, the current trend of open-office plans and glazed facades in work environments to achieve LEED certification credits resulted in mixed perceptions of the favorability of this design strategy by the building occupants. The specific question this paper answer is whether a well-planned evaluation study with pre-post occupancy analysis of a retrofitted, green-certified building could lead to more conclusive findings related to the impacts of green buildings, in general, and those with specific high IEQ on occupant's well-being, health, and productivity.

A late 1960's commercial office building was transformed into a state-of-the-art double platinum-rated LEED® (USGBC LEED v3 Core and Shell and Commercial Interiors) corporate headquarters over an extensive 18-month renovation period. Approximately eight hundred employees work within 270,000 square feet of open-concept office space with an additional 116 meeting rooms available to promote cross-collaboration. The traditional floor plan with perimeter offices and central workstations was reconfigured into an open-concept office space with central workstations, perimeter hallways, and collaborative space. The existing building was stripped down to the steel and concrete structural core and enclosed in a high-performance building envelope and glass façade. The interior open-plan office space was designed to maximize occupant comfort, as well as improve the health and well-being of the employees.

A comprehensive Pre - Post Occupancy Evaluation protocol (PPOE) was employed to assess and analyze multi-comfort parameters and metrics of the thermal, visual, acoustical, and air quality environment over one year, both before and after occupancy. Results of a systematic indoor environmental quality (multi-comfort) assessment and pre-post occupancy evaluation for the building and its occupants pre-and post-retrofit, using continuous and intermittent measurements to quantify indoor thermal, visual, and acoustical comfort, as well as air quality, will be presented and correlated with the occupant's surveyed experience. The paper will provide evidence-based guidelines for implementing successful design strategies to improve the IEQ of an all-glass building. Most important, is the application of an integrated design and post-occupancy evaluation process that would act as a replicable methodology for the design and operation of the future all-glass building.

KEYWORDS: Building Envelopes, Retrofits, Indoor Environmental Quality, Research Application in Practice

INTRODUCTION: Greening Building Retrofits

An increasing marketing campaign by the green building industry and particularly the Leadership in Energy and Environmental Design (LEED™) certification system promotes linkages between LEED™ certified buildings and indoor environmental quality (IEQ). Despite the favorability of this hypothesis, few studies have empirically proven the linkages between LEED™ certified green buildings and their verified improvements in occupants' IEQ and multi-comfort experience (Altomonte et.al, 2017; Elzeyadi, 2016). Based on several recent studies of IEQ evaluations in green buildings, indoor air quality (IAQ) and thermal comfort are rated among the most important IEQ factors (Chinazzo, Giorgia; Wienold, Jan; Andersen, 2016; Gou et al., 2012). However, a study based on responses from 52,980 occupants placed IAQ second and thermal comfort last in importance (Heinzerling et al., 2013). Despite this finding, all IEQ weighting schemes stress the high importance of IAQ and thermal comfort in explaining the occupant's overall perception of IEQ in offices. There is consensus among researchers that both factors play a role in the overall perception of multi-comfort and could act as mediational factors that impact occupant's evaluation of other comfort systems such as visual and acoustical comfort (Elzeyadi, 2015; Abbaszadeh, 2006).

Findings of previous studies of LEED™ certified retrofitted buildings are not always conclusive of a positive correlation between envelope retrofit applications in these environments and human comfort and health (Elzeyadi, 2012). This is in part due to excessive glare, poor lighting quality, and acoustical comfort in all-glass buildings' spaces that are designed to meet certain indoor daylighting metrics yet do not account for visual and acoustical comfort (Heerwagen and Zagreus, 2005). Dynamic daylighting metrics (IES LM-83, 2012) recommend that a minimum of 55% of the spatial daylit area >300 lux be achieved for 50% of the occupied time (sDA300 50%). In addition, the same metrics require that sunlit areas >1,000 lux should not exceed 10% of floor area for 250 hours per year (ASE1000, 250h). Green building rating systems such as LEED v4 adopted this metric. However, supporting research on these guidelines (IES, LM-83, 2012; HMG, 2012) did not investigate how this metric could impact visual interest, daylighting delight, occupant satisfaction, and optimal visual comfort in offices. These outcomes are seen by most studies to be associated with employees' health and productivity (Elzeyadi and Gatland, 2017; Jakubiec and Reinhart, 2013; Figueiro et. Al., 2011).

Previous studies have reported that adopting dynamic daylighting metrics might lead to dull and boring spaces (Reinhart, 2015, Elzeyadi and Lockyear, 2010). In another study, more than 55% of the occupants in The New York Times building, which is designed to manage glare and always prevent sunlight penetration, felt that the daylighting system did not impact their work and well-being positively (Lee et. al., 2013). From an acoustics performance perspective, previous field studies investigating the relationship between all-glass retrofitted LEED™ buildings and acoustical comfort report a negative correlation recommending the need to design buildings with more wall insulation. Based on this, a frequent problem facing designers of high-performance LEED™ buildings is whether the design of buildings with limited perimeter glazing could help balance both visual and acoustical comfort while achieving the desired daylighting metrics and occupants' satisfaction. Following on this problem, the specific question of this paper is: How would a well-designed all-glass retrofitted and LEED™ certified building provides more conclusive evidence related to the impacts of green buildings in general, and those with better indoor environmental quality (IEQ) following an envelope retrofit, have on occupant's well-being, health, and productivity? In answering this question, the study compares occupants' performance, IEQ metrics, and well-being of a conventional cellular office with a typical window-to-solid-wall-ratio building to a well-designed LEED™ certified all-glass building (Figure 1). The paper builds on a previous framework of sustainable design as a place experience (Elzeyadi, 2015). This framework acknowledges the complex systems of interactions between people and their indoor/outdoor environments on multiple layers relating to multi-comfort parameters, occupants' productivity, and symbolic perceptions of their building as a facilitator or inhibitor of performance.



Figure 1: The building complex before (right) and after retrofit (left). Source: Author 1

1.0 INDOOR ENVIRONMENTAL QUALITY AND MULTI-COMFORT ANALYSIS

There seems to be an implicit and, sometimes, explicit view that human comfort occurs in separate envelopes, which might be labeled differently as thermal, visual, acoustical, or spatial. Based on our extensive database of post-430

occupancy evaluation studies we conclude that human comfort is a multi-faceted concept that is affected by the fourfold components of the environment in its physical, physiological, psychological, and social attributes and properties. While one can assume that, the environment affects individuals in different ways, their general achievement of multi-comfort, satisfaction, and well-being is the result of their overall appraisal of the environment's multiple sub-systems (i.e. thermal, visual, acoustical, indoor air quality, and spatial). The IEQ framework for sustainable place-making (Figure 2) was employed to guide this study. It conceptualizes IEQ in places as a complex system that is composed of different qualities that are grouped under three levels: Attributes (instrumental), Aesthetics (latent), and Symbolic (ambiance). The model proposes the systemic interaction of multiple parameters, people, buildings, and the indoor/outdoor environment resulting in sub-systems' impact on building performance, occupants' productivity, comfort, and well-being. These sub-systems affect overall IEQ in buildings and are impacted by their qualities.

Multi-comfort parameters and metrics of the indoor environment were assessed and analyzed at an office building for a corporate headquarters. IEQ parameters and occupant comfort surveys of thermal, visual, spatial, indoor air, and acoustical comfort were collected and analyzed pre- and post-building retrofit of the 800-employee, four-story 25,734 sq. m. headquarters located on a 263,046 sq.m. mature landscaped site, 40 kilometers west of Philadelphia in Malvern, Pennsylvania, USA. The corporate site includes 18,000 sq. m. of open-plan office area, 116 collaborative spaces, a cafeteria, pantry areas, a fitness center, a pond, outdoor workspaces by a rainwater fountain, and 2.1 km of walking trails to further enhance the employee experience (Figure 1). The state-of-the-art facility was designed to promote cross-collaboration, as well as attract and retain talent. Sweeping views of nature and daylight penetration are available for 92% of the interior space. Continuous fresh air ventilation and no- or low-emitting materials were employed to create excellent indoor air quality. Acoustic comfort at the 800 workstations was created through the thoughtful placement of sound-absorbing surfaces, noise-reducing interior partitions, and an active sound masking system.

Both instantaneous and long - term field measurement data of the physical environment and multi - comfort parameters were collected at the level of the building as well as the scale of the occupant's work setting. Environmental sensors and data loggers measuring light levels, temperature, relative humidity, air velocity, and air movement at sampled workstations stratified across the different floor levels of the buildings were deployed over the winter, spring, and summer seasons, respectively. In addition, infrared (IR) and high dynamic range images (HDRI) were taken for sampled seasonal days for the occupant's workstations and from their direct view sheds employing wide angle and fisheye lenses to simulate the occupant's perspectives and fields of vision. Different imaging techniques were employed to document surface temperature, mean radiant temperature, and glare indices over the study period. In addition, acoustic attenuation, sound levels, and speech intelligibility measurements were recorded for typical office simulated conditions in the field at various times after the retrofit. Before occupancy and one-year post-move, the indoor air was evaluated for thermal comfort and quality through on-site measurements and sampling. +An occupant space performance evaluation questionnaire (SPEQ™) survey was administered to the entire employee population before and one year after the move into the retrofitted high-performance, LEED-certified office building. Response to the survey was extremely high with 289 employees completing the questionnaire before the move and 320 completing it after the move. Data tabulation and coding were performed on both the physical and human - response data sets. Physical measurements and survey responses were spatially tagged and statistically analyzed using SPSS software. In addition, data visualizations and multi - comfort parameters were computed using a suite of software that spatially analyzed the occupant's visual, thermal, as well as other indoor environmental quality outcome metrics across various locations of the building.

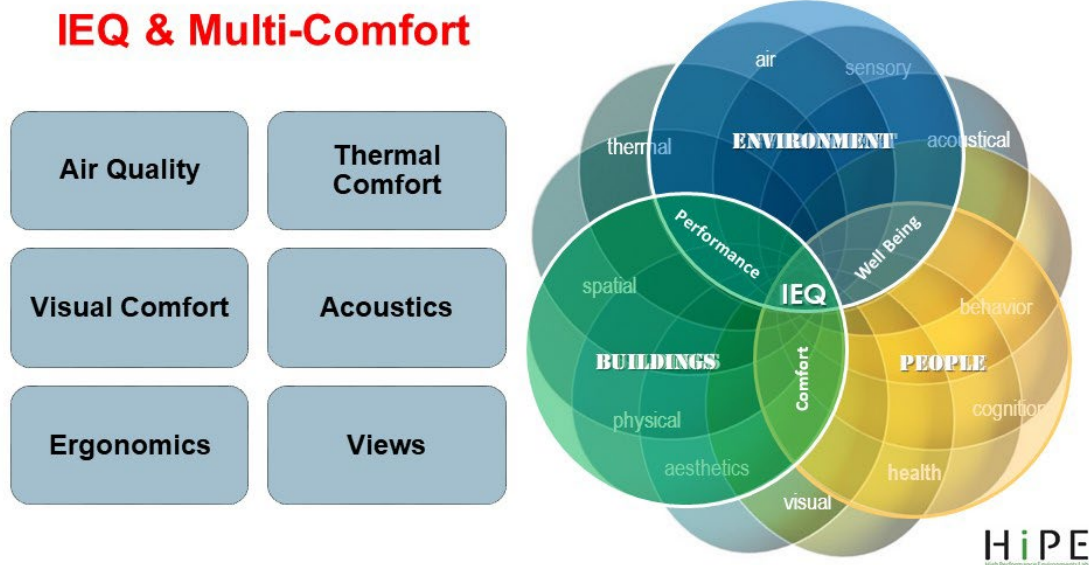

Figure 2: Research Conceptual Framework Source: Author 1

1.1 IEQ Physical Assessment

IEQ assessment was conducted for the same sampled office spaces before and after the retrofits. A total of 12 sampled workstations were selected to document IEQ parameters in the building. The sampled spaces were chosen as representative workstations for the differently-facing orientations and microclimates inside the buildings (Figure 3). Detailed visual, thermal, acoustical, spatial, and indoor air quality assessments were conducted. These assessments were further synthesized and combined to compare spaces representative of the four main orientations and microclimates inside the building both before and after the envelope retrofits. The results were further summarized into five sampled work areas representing the main micro-climate zones; North, South, East, West, and Internal.

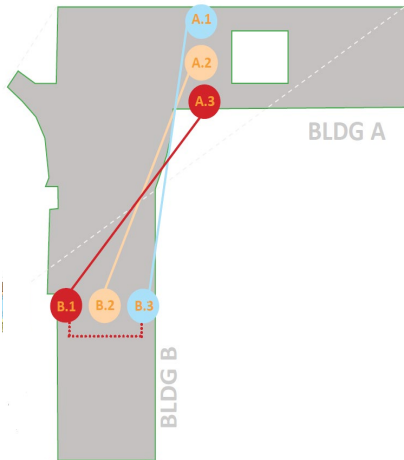

Figure 3: IEQ Assessment for Sampled Location inside the building Source: Author 1

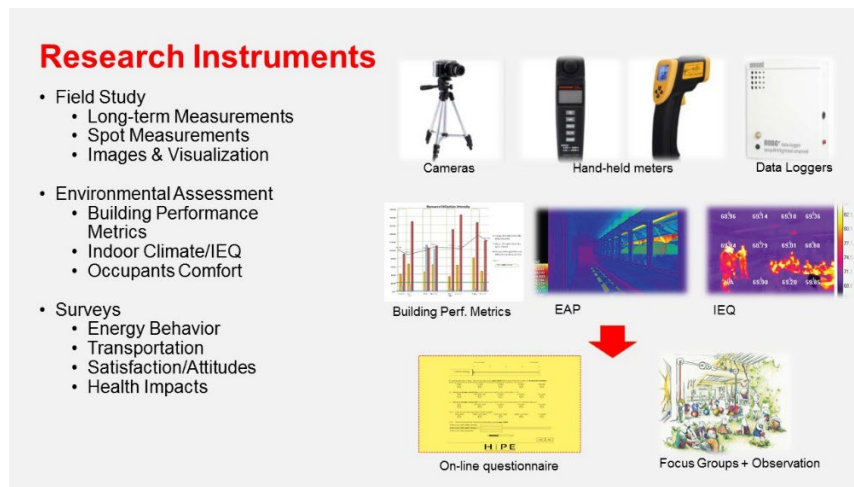

Figure 4: IEQ Methods and Instruments Source: Author 1

1.2 Research Instruments

Multi-Comfort parameters and metrics with the thermal, visual, acoustical, spatial, and air quality environment were assessed and analyzed for both before and after green retrofitting of the building’s envelope. Both instantaneous and long-term field measurement data of the physical environment and multi-comfort parameters were collected at the level of the building as well as the scale of the occupant’s workstation (Figure 4). In addition, occupants’ satisfaction, comfort, productivity, and well-being data was collected using an online Space Performance Evaluation Questionnaire (SPEQ™) as well as focus groups. All study procedures and protocols were approved by an Internal Review Board (IRB) for the protection of human research subjects and all occupants participating in the study signed an online informed consent form before their participation. The study collected both objective and subjective environmental data that was cross-referenced and spatially tabulated to ensure data was mapped and tagged to accurately represent occupants’ spatial locations and time of collection. All data was tagged with research identification numbers and securely protected to maintain the privacy and anonymity of the responses. Only aggregate data is reported on and statistically analyzed to maintain occupants’ privacy.

2.0 INDOOR ENVIRONMENTAL QUALITY - OCCUPANTS' PERSPECTIVE ANALYSIS

In addition to physical assessments and visualization of the multi-comfort metrics of the environment, an occupant questionnaire was administered to solicit employees' satisfaction with both buildings. An average of 42% of the employees for pre-retrofit and 44% of the employees for post-retrofit completed the questionnaire. The occupant questionnaire was administered to solicit employees' satisfaction, health, and productivity perceptions of both buildings. Questions addressed specific issues such as glare, daylighting distribution, and controls to achieve multi-comfort for the various spaces. A comparative analysis of the occupants' attitudes and perceptions of their satisfaction with the physical environment and IEQ parameters reveals a shift in attitude as to the impact of the building design on their multi-comfort and satisfaction. Preliminary results of the survey show strong occupants' satisfaction with the environmental agenda and green/LEED™ certification of the building. More than 75% of occupants in the retrofitted building agree with the importance to work in a building that is environmentally conscious (Figures 5 & 6).

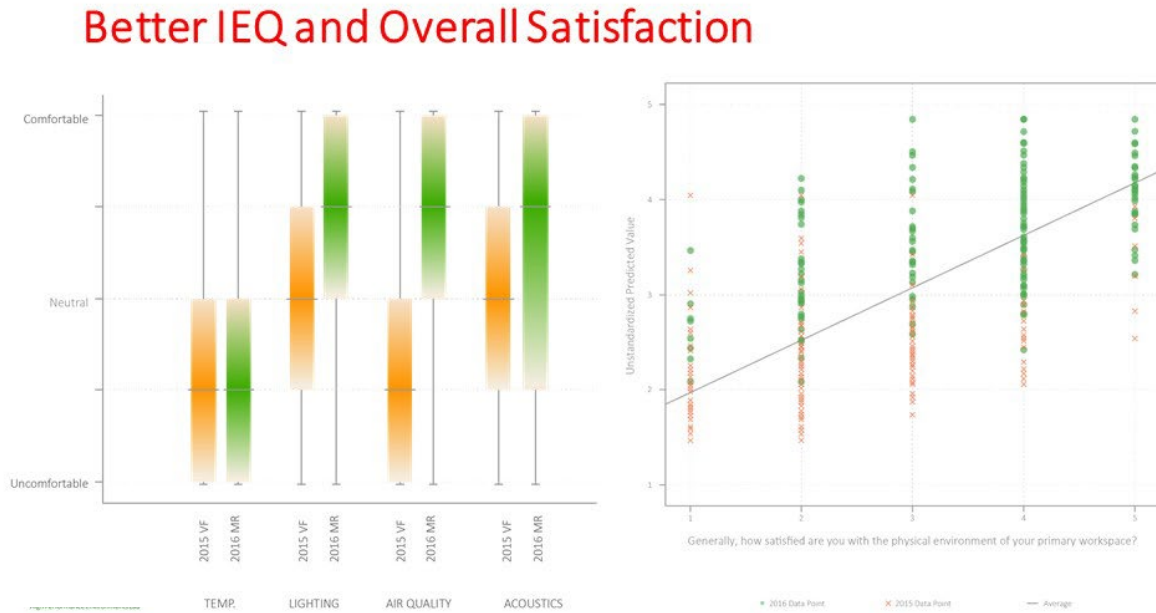

Figure 5: (Left) Comparative Analysis of Occupants' Satisfaction with the IEQ Sub-systems of their Work Environment (Green, post-retrofit/post-occupancy, and Orange, before retrofit).(Right) Relationship between occupant's overall satisfaction and the building's green retrofit changes.

3.0 OCCUPANTS' PERCEPTIONS OF HEALTH AND PERFORMANCE RESULTS

A total of 379 employees participated in the survey with a net total of 356 employees completing all questions and evaluating their new work environment post-occupancy after they settled in for 12 months in their new environment. This was essential to control for any bias in perceptions related to moving to a new environment and to allow for environmental adaptation and habituation for the new work setting. In the third year, the survey was repeated after 24 months has passed since the move to the green retrofitted building. In that year, 358 participated and completed the survey. Data from the survey responses were cleaned and tabulated to ensure complete data sets for all respondents covering all research questions of the survey. This resulted in slight reductions in the number of responses reported for each survey year but not drastic in terms of the overall percentage of responses to post any sampling bias. The results of this data are analyzed and discussed below.

3.1 Visual Comfort

Perceptions of visual comfort and ratings of the various parameters of the indoor visual environment are measured by the SPEQ™ survey using a calibrated Likert scale. Employees responded to seven different questions that collectively evaluate their visual comfort in the building pre-post occupancy between the existing and retrofitted building. Across all questions, employees reported a higher level of visual comfort improvement of 56.4% after the envelope retrofits as compared to the original one (Figure 5). Visual comfort improved across all parameters between 30-60%. The most improvement was perceived in the amount of light levels for working followed by glare management and daylight availability. The data scale was further normalized to visualize the magnitude and trend of improvement over the neutral conditions where employees reported neither satisfaction nor dissatisfaction (Figure 5).

3.2 Thermal Comfort

Perceptions of thermal comfort and ratings of the various parameters of the indoor thermal environment are measured by the SPEQ™ survey using a calibrated Likert scale. Employees responded to five interrelated questions that collectively evaluate their thermal comfort in the building pre-post occupancy between the existing and retrofitted building using a skip-logic smart questionnaire technique. Across all questions, employees reported slight to severe dissatisfaction with thermal comfort. With some mild improvements (+4.8%) in the perception of hot and cold at various times of the day but the overall perception of thermal comfort was neutral to negative. Issues related to the ability to control the thermal environment and perceptions of minimal temperature shifts and radiant asymmetry were better perceived in the existing building compared to the retrofitted building (Figure 6).

3.3 Acoustical Comfort

Perceptions of acoustical comfort and ratings of the various parameters of the indoor acoustics environment are measured by the SPEQ™ survey using a calibrated Likert scale. Employees responded to seven different questions that collectively evaluate their visual comfort in the building pre-post occupancy between the existing and retrofitted building. Across all questions, employees reported a higher level of acoustical comfort improvement of 42.2% in the retrofitted building as compared to the traditional building (Figure 7). Acoustical comfort improved across all parameters between 20-50%. The most improvement was perceived in the decrease in noise levels from windows and electric lighting.

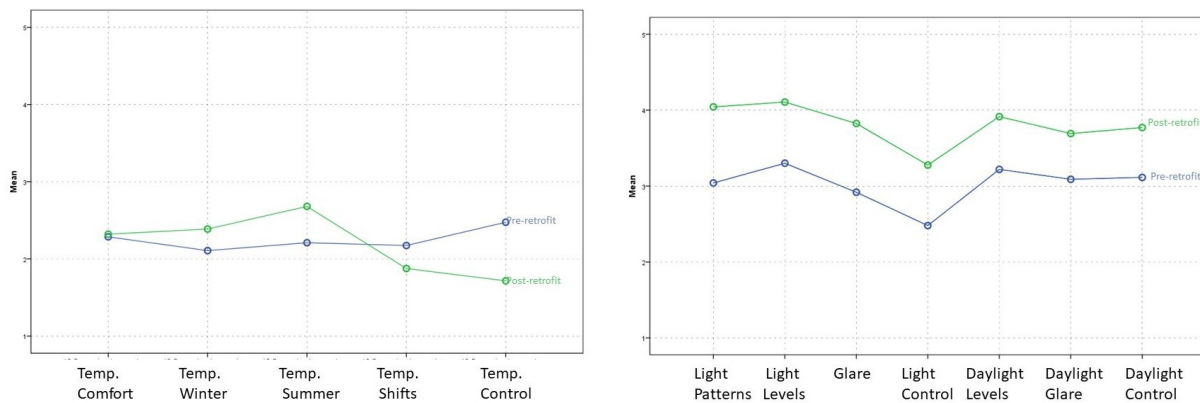

Figures 6 and 7: (Left) Thermal Comfort Perceptions Pre/Post-Retrofit. (Right) Visual Comfort Perceptions Pre/Post-Retrofit

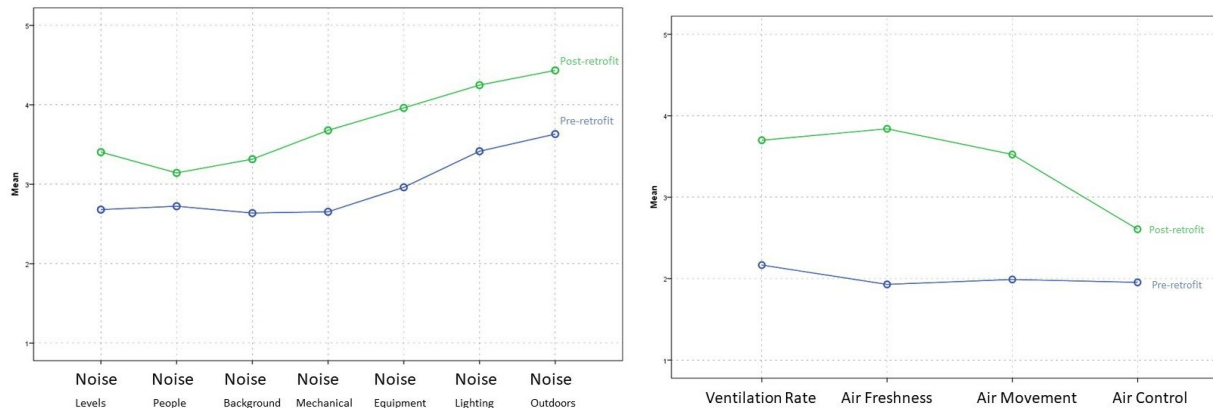

Figures 8 and 9: (Left) Acoustical Comfort Perceptions Pre/Post-Retrofit. (Right) Indoor Air Quality Perceptions Pre/Post-Retrofit. Source: Author 1

3.4 Indoor Air Quality

Perceptions of indoor air quality (IAQ) comfort and ratings of the various parameters of indoor IAQ environment are measured by the SPEQ™ survey using a calibrated Likert-scale. Employees responded to four different questions that collectively evaluate their IAQ comfort in the building pre-post occupancy between the existing and retrofitted building. Across all questions, employees reported a higher level of IAQ comfort improvement of 91.6% in the retrofitted building as compared to the existing one (Figure 8).

3.5 Occupant’s Multi-Comfort

Perceptions of spatial multi-comfort and ratings of the various parameters of the indoor environment are measured by the SPEQ™ survey using a calibrated Likert scale. Employees responded to seven different sub-systems of questions that collectively evaluate their multi-comfort in the building pre-post occupancy between the existing and retrofitted

building. Across all questions, employees reported a higher level of spatial comfort improvement of 26.3% in the retrofitted building as compared to the traditional building (Figure 9). Thermal comfort reported the least improvement while IAQ comfort reported the most improvement and was statistically very significant as a weighting criterion that defined employees' overall multi-comfort perception inside the green retrofitted building.

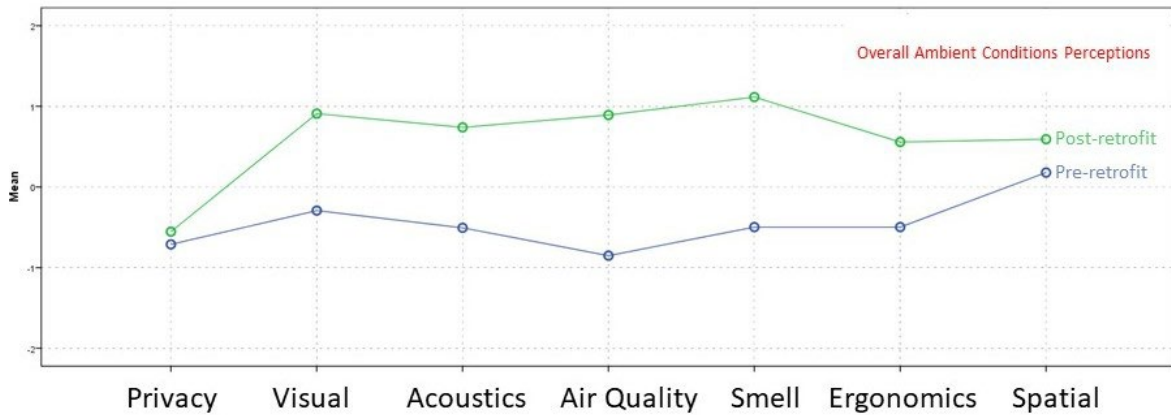
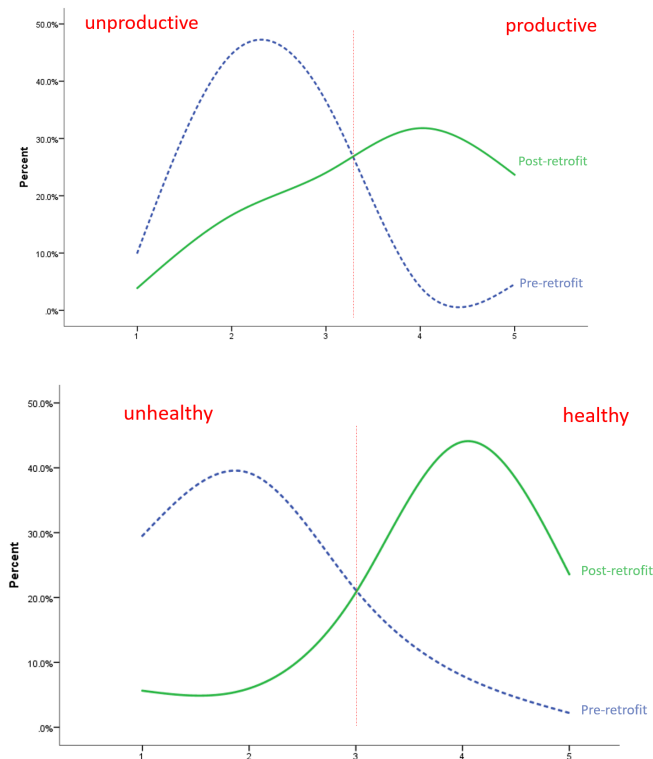

Figure 10: Overall Occupant's Multi-Comfort with IEQ Parameters. Source: Author 1

4.0 OCCUPANT'S SATISFACTION, PRODUCTIVITY, AND HEALTH PERCEPTIONS

A double LEED Platinum (USGBC LEED v3 Core and Shell and Commercial Interiors) certified building was achieved by combining a high-performance building envelope with thermally improved traditional and dynamic glass facades. The provision of flexible working spaces around the perimeter without workstations and opaque partitions created sweeping views of nature that provide an abundance of daylight with views possible from 92 percent of the interior space. Continuous fresh air ventilation and the use of no- or low-emitting materials created excellent indoor air quality. Acoustic comfort was achieved at the 800-plus workstations through the thoughtful placement of better envelope insulation, sound-absorbing surfaces, noise-reducing interior partitions, and an active sound masking system.

The combined eco-system of envelope improvements resulted in the overall positive perceptions of occupants' satisfaction, which increased by 26%. Similarly perceived increase in productivity related to occupying the new building has increased by 38.9%, indicating occupants perceiving the new environment as making their job easier and supportive to their productivity (Figure 10). In addition, improvement in perceptions of health related to occupying the new building has increased by 53.7%, indicating occupants perceive the new environment as supportive of their health and well-being (Figure 11). The reported Sick Building Syndrome Symptoms (SBS), as defined by the World Health Organization (WHO, 1984), has also decreased by 28.6% in the retrofitted building as compared to the existing building. Results show strong correlations between improved visual, acoustic, and indoor air qualities of the retrofitted, high-performance LEED-certified building environment and increased employee satisfaction and improved employee productivity. A comparative analysis of the occupants' attitudes and perceptions of the impact of the building on their productivity reveals a shift in attitude as to the impact of the building design on their work performance and well-being. Proving that, for high-performance buildings, both the occupants and the buildings require ongoing dialogue to ensure the occupants can manage the building to achieve its desired levels of performance.



Figures 11 and 12: Occupant's Perceived Productivity Pre/Post-Retrofit (Left). Occupant's Perceived Health Pre/Post-Retrofit (Right). Source: Author 1

CONCLUSIONS

The project is an exemplary effort and one of the largest studies to date that employed longitudinal IEQ analysis and measurements for both quantitative and qualitative experience combining both building performance and occupants' experience. It employed state-of-the-art methods and protocols to measure IEQ, multi-comfort, health, and productivity between the green retrofitted building and the original building. One of the objectives of this paper is to provide detailed as well as context-specific information to assess IEQ inside high-performance, green-retrofitted buildings from a comprehensive approach. By establishing a comparative approach between a traditional building pre-retrofit and its green retrofitted LEED-certified platinum phase, the study provides an evidence-based study of green building design strategies that impact IEQ parameters and occupants' well-being. It is important to note that this study used a survey research design with over 44% of the population ($n = 356$) surveyed in both the pre-and post-occupancy evaluations. The control of the work conditions and other organizational variables was kept constant to minimize competing variables and ensure the statistical significance of the results. Although the research design led to the statistical reliability of the findings, future studies might be able to replicate the methods before reaching a generalizable conclusion related to the impact of a green-envelope building's retrofits on occupants' multi-comfort and satisfaction. The scope of this study did not consider the cost implications of green building envelope retrofits. This was intended to focus the study on other aspects of green building's impacts on occupants' well-being and health, which in the overall scope of green buildings is more important than the first cost of buildings. Future studies might be interested to study the economic analysis of improvements in satisfaction, productivity, and health of occupants compared to the financial investment in green-envelope retrofits. In addition, it is important to consider that the green-retrofit design strategies should not be perceived as "one size fits all" in general and might not be suitable in all design situations. Future studies need to investigate the individual impacts of some retrofit strategies over others. For example, studies might investigate whether improvements in glazing systems provide more occupants' satisfaction over improvements in HVAC systems. Designers will need to balance the pros and cons of green and high-performance envelope systems as they manage the value proposition of the impact of those systems on IEQ and occupants' comfort. Results show strong correlations between improved IEQ parameters in an all-glass retrofitted envelope building that is well correlated with improved employee productivity and satisfaction. Proving that, for a high-performance building's envelope, a comprehensive design and integration of systems is more important than following a strict prescriptive path.

REFERENCES

Abbaszadeh, S.; Zagreussi, L.; Lehrer, D.; and Huizengai, C. (2006). Occupant satisfaction with indoor environmental quality in 'green' buildings. Center for the Built Environment, University of California, Berkley: CA.

- Altomonte, S. and Schiavon, S. (2013). Occupant satisfaction in LEED and non-LEED certified buildings, *Building and Environment*, 68: pp. 66-76, <https://doi.org/10.1016/j.buildenv.2013.06.008>.
- ANSI/ASA Standard. (2008). Criteria for evaluating room noise (S12.2-2008).
- ASHRAE. 2009. *The Indoor Air Quality Guide: Best Practices for Design, Construction and Commissioning*. Atlanta, GA: ASHRAE, Inc.
- ASHRAE. 2013. *ANSI/ASHRAE Standard 55-2013*. Atlanta, GA: ASHRAE, Inc.
- Chinazzo, Giorgia; Wienold, Jan; Andersen, M. (2016). A preliminary study on the sensitivity of people to visual and thermal parameters in office environments. *Proceedings of 9th Windsor Conference: Making Comfort Relevant*.
- Elzeyadi, I. (2003). Environmental Quality - Shaping Places for People: A Systemic Framework for Conceptualizing People and their Workplaces. In: *Shaping Places for People*, pp. 71- 79. *Proceedings of the Environmental Design Research Association EDRA 34th Conference*. May 22-26, Minneapolis, Minnesota.
- Elzeyadi, I. (2012). Post-occupancy evaluation: A design, operations and performance assessment of a LEED Platinum building." *World Health Design Journal*. January 2012, pp. 60-69.
- Elzeyadi, I. (2015). A Tribute to Performance Arrows: Designing for Better Indoor Environmental Quality. In: *Thought and Leadership in Green Buildings Research*. *Greenbuild 2015: Monumental Green*. Washington, DC: USGBC Press.
- Elzeyadi, I. (2017). A Comparative Analysis of Predictive and Actual Performance of High-Performance LEED Buildings. In W. Prieser, U. Schramm & A. Hardy (eds.), *Building Performance Evaluation: From Delivery Process to Life Cycle Phases (Second Edition)*. NY: Springer.
- Elzeyadi, I. and Gatland, S. (2017). Indoor environmental quality design for advanced occupant comfort – a pre-post occupancy evaluation of a green-certified office building. Edinburgh, Scotland, *Passive Low Energy in Architecture (PLEA) Design to Thrive Conference*.
- Elzeyadi, I. and Lockyear, B. (2010). "Dynamic Daylight-Delight Verses Intensity: The Relationship between Daylighting Quality and Office Layout Inside A LEED Platinum Commercial Building with Glazed Facades." *Proceedings of solar 2010, American Solar Energy Society (ASES) international conference*, Phoenix, AZ, May 19– 22.
- Figueiro, M, J Brons, B Plitnick, B Donlan, R P Leslie, and M S Rea. 2011. "Measuring Circadian Light and Its Impact on Adolescents." *Lighting Research & Technology*. doi:10.1177/1477153510382853.
- Gou, Z., Lau, S. S.-Y., & Shen, J. (2012). Indoor Environmental Satisfaction in Two LEED Offices and its Implications in Green Interior Design. *Indoor and Built Environment*, 21(4), 503–514. <https://doi.org/10.1177/1420326X11418700>
- Heerwagen, J. and Zagreus, L. 2005. *Post Occupancy Evaluation of the Phillip Merrill Environmental Center*. Center for the Built Environment, University of California, Berkeley.
- Heinzerling, D., Schiavon, S., Webster, T., & Arens, E. (2013). Indoor environmental quality assessment models: A literature review and a proposed weighting and classification scheme. *Building and Environment*, 70, 210–222. <https://doi.org/10.1016/j.buildenv.2013.08.027>
- HMG (2012). *Heschong Mahone Group: DAYLIGHT METRICS PIER Daylighting Plus Research Program*. HMG: Fair Oaks, CA
- IES LM-83 (2012). *Lighting Measurement 83: Approved Method: IES Spatial Daylight Autonomy (sDA) and Annual Sunlight Exposure (ASE)*, by the IES Daylight Metrics Committee, IES. Illumination Engineering Society, New York City: NY.
- International Organization for Standardization. (2012). *Acoustics — Measurement of room acoustic parameters — Part 3: Open plan offices (3382-3:2010)*. <https://www.iso.org/standard/46520.html>
- Jakubiec, A. and C. Reinhart (2013). "Predicting Visual Comfort Conditions In a Large Daylit Space Based on Long-Term Occupant Evaluations: A Field Study." In *Proceedings of BS2013, 13th Conference of International Building Performance Simulation Association*, 3408–15.
- Lee, E. et. al. (2013). A post-occupancy monitored evaluation of the dimmable lighting, automated shading, and underfloor air distribution system in The New York Times Building. LBNL Technical report, January. LBNL-6023E. https://windows.lbl.gov/comm_perf/pdf/nyt-sep-survey-results.pdf assessed on July 1, 2017.
- Reinhart, C. 2015. "Opinion: Climate-Based Daylighting Metrics in LEEDv4 – A Fragile Progress." *Lighting Research and Technology* 47: 388.
- USGBC. 2017. *LEED Version 4, Building Design and Construction*. Washington, DC: U.S. Green Building Council (USGBC).
- World Green Buildings Council (WGBC) (2016). *Building the Business Case: Health, Wellbeing and Productivity in Green Offices Report*. Toronto, Canada: Eva Phoenix.

Impacts of Repurposing Renewable Energy Waste as Oriented Strand Board in Texas

Patricia N. Kio¹, Precious Batubo²

¹Fitchburg State University, Fitchburg, MA

²University of Louisiana at Lafayette, Lafayette, LA

ABSTRACT: The United States is the second largest provider of renewable energy, and this accounts for over 20% of the power generated. While wind energy is being adopted, we ought to also consider the disposition of retired wind-turbine blades, which are not easily recycled. Many studies have investigated the end-of-life options and reusing waste from the renewable energy sector but very few apply modular design or map their innovations in the regions. In addition, few studies have attempted to combine modular design and resource efficiency towards transforming them into innovative building construction products. A lot of decommissioned wind turbine rotor blades (DWTRB) have been discarded in landfills, cut up and buried, or kept in storage. In the context of technology and design, this study presents a methodological workflow for modular design innovation based on supply and demand towards substituting high demand primary materials in oriented strand boards (OSB) with DWTRB from wind farms in Texas. Using modular design principles, geometry, and simple linear regression, OSB was replaced with secondary sourced turbine rotor boards from the farms. Also, student coursework was used for evaluating average surface area of walls and roof deck in three-bedroom residential buildings. Resource efficiency from the geometry matching was used to evaluate economic and environmental impacts of the transformation. Findings show that repurposing DWTRB in Texas could improve annual avoidance of CO₂ emissions annually of wind by 7%, and cover roofs and walls for up to 1.9 million three-bedroom residential buildings. This study will aid in decision making for modular repurposing of renewable energy waste, reduce the use of virgin materials and impact climate change.

KEYWORDS: Modular Design, Additive Manufacturing, Renewable Energy, Building Construction, Resource Efficiency

INTRODUCTION

Renewable energy generates about 20% of all electrical energy in the United States (U.S.) and wind energy accounts for 9.2%. Other sources include solar energy at 2.8%; hydropower, biomass and geothermal at 6.3%, 1.3% and 0.4% respectively. Wind is America's largest source of renewable energy and helps to avoid 340 million metric tons of carbon emissions annually equivalent to 74 million cars' worth of emissions. However, end-of-life consideration of the physical components especially the wind turbine rotor blades have not matched the pace of growth in the industry. Texas ranks first among U.S. states in terms of wind power capacity and landfilling dominates the end-of-life disposal practice in the U.S. while combustion is practiced in many European countries (Alsaleh and Sattler 2019). Other current recycling processes include mechanical, thermal, chemical, and hybrid methods; fiber composites of carbon and glass fibers have also been reclaimed and reused. Figure 1 shows the current end-of-life disposal methods of wind turbine rotor blades.

Wind turbines are decommissioned 20 – 30 years after they become operational and resume their production of power. Currently wind turbine rotor blades (WTRB) are made from materials that are difficult to recycle. In addition, their geometry which has been optimized for power generation is a hindrance for the versatility in repurposing.

WTRB are made from fiberglass, bonded with a thermoset resin to resist separation; they are designed for high-stress operation and extreme weather conditions without much consideration for their end-of-life disposition (Brøndsted et al. 2005). Blades are usually regarded as unrecyclable and with the first wave of early commercial wind turbine installations now approaching their end of life, the problem of waste disposal has emerged as a significant factor for the future (Liu and Barlow, 2017). A significant proportion of installed wind turbines about 200,000 tons of rotor blade waste will complete their standard lifetime from 2020 to 2034 leading to a tremendous amount of composite waste (Rani et al. 2021). Figure 2 shows the locations of wind turbines in Texas.

The primary focus of this study are the rotor blades in Texas where findings could be scaled for thousands of wind turbine blades around the world that will reach the end of their design lifetimes in the coming years (Cooperman, Eberle, & Lantz, 2021). These blades have increased in size over the past decades with rotors up to 120 meters diameter (Veers et al., 2003). Historically, wind turbine blades have been constructed using either all-fiberglass or fiberglass construction with selective use of carbon for local reinforcement; for blade sizes up to 30m the most common manufacturing approach was an open mold with wet lay-up. While Vestas Wind Systems used prepreg fiberglass in their blade manufacturing process. Nordex and GE Wind have both built blades in the 35 – 50m length range using hand lay-up of primarily fiberglass structure in open-mold wet processes. NEG Micon is building 40m blades with carbon augmented woods/epoxy, TPI Composites is manufacturing 30m blades using its SCRIMP vacuum-assisted resin transfer molding (VARTM) process. Blades of length 30m and greater are being produced using a dry preform with a

single-shot infusion, eliminating the need for secondary bonding of the blade halves. Some commercial blades incorporated carbon fiber in the load-bearing spar structure, Vestas V90 blades used carbon fiber spars and DeWind used an innovative approach to produce 40m carbon/fiberglass hybrid blades. Despite limited damage/degradation during use, the decommissioned WTRB are generally viewed as zero-value by-products and disposed by burying in landfills or crushed during conventional recycling processes.

This study presents a methodology for repurposing WTRB in accordance with the most preferred waste management hierarchy for non-hazardous materials (EPA, 2020). The work presented here investigates creative reuse case study that adds value to the WTRB preventing them from grinding and graves. Modularity is an important parameter of this study since this approach will support using the maximum amount of waste while repurposing of waste into the final product. It helps manufacturing multiple repeated units can benefit from economies of scale, leading to increased construction efficiency and productivity. Furthermore, this can lead to enhanced quality and accuracy in manufacturing, as well as reduced costs and budgets. Implementing these manufacturing methods can also lead to safer working conditions for construction workers, while promoting greener building practices and reducing waste, thus minimizing the environmental impact of job sites (MBI, 2010; McGraw-Hill, 2011; Lawson, Ogden, and Bergin, 2012). The ideation process of this study includes identifying the building product in demand, design of the building envelope and validating the environmental, economic, and social impacts using data from The United States Wind Turbine Database.

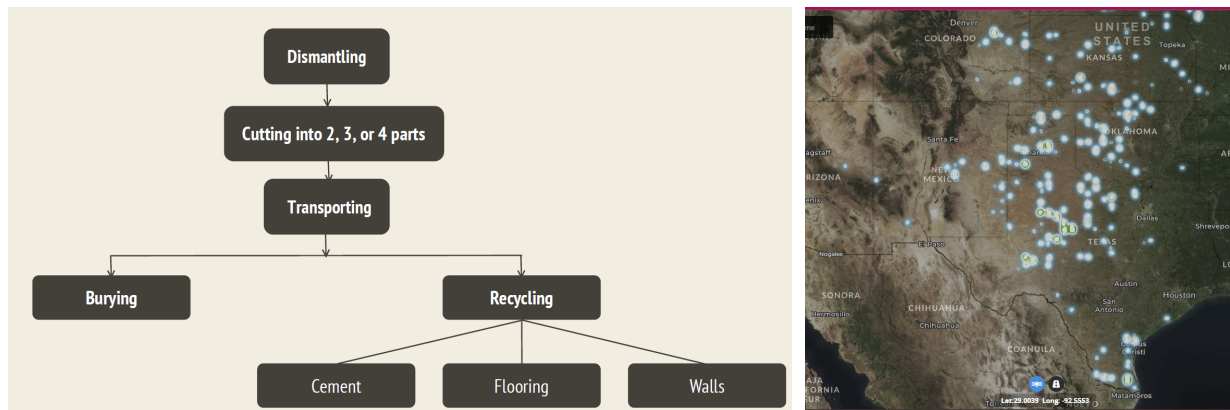

Figure 1: (Left) End-of-life disposal process of wind turbine rotor blades. Source: (Authors 2023).

Figure 2: (Right) Locations of wind farms in Texas. Source: (Hoen B.D. et al. 2023)

1.0 MATERIALS AND METHODS

1.1 Product identification

Oriented Strand Board (OSB) is commonly used as wall, roof, and floor sheathing in the residential and commercial building sector (Kaestner, 2015). The commonly used unit of OSB in the industry is one thousand square feet (MSF) on a 3/8-inch basis (0.885 cubic meters). Post covid information on materials in the construction sector show that Oriented Strand Boards (OSB) have become scarce and difficult to procure leading to delays in construction. During the first 6 months of 2021, manufacturers of plywood and OSB saw a huge price surge, data from the National Association of Home Builders showed that the price of OSB increased by 510% and OSB products like 3/8" OSB sheathing rose by 650 to 662% (Silvaris, 2021). Market news described it as COVID induced product shortages leading to extended waiting periods, advising builders to avoid OSB. Figure 3 depicts the cost trend of OSB in the United States. The system boundary for OSB in this study was limited to the extraction processes investigating the impact of a cradle to gate substitution of OSB with turbine rotor boards (TRB).

1.2. Design of Turbine Rotor Boards

The current United States Wind Turbine Database (USWTDB) provides the locations of land-based and offshore wind turbines in the United States, corresponding wind project information, and turbine technical specifications. Data from USWTDB shows data for 18,586 wind turbine farms in Texas with turbine rotor diameters ranging from 13.4 meters to 162 meters. The average diameter is 101.8 meters equivalent to the height of a 34-storey building if each floor height was 3 meters. Substituting OSB with TRB could provide more affordable materials for residential and commercial buildings and reduce construction time. Impacts were investigated when TRB replaced OSB in three-bedroom residential buildings using students' projects from a building construction systems course in the Engineering Technology Department at Fitchburg State University, Massachusetts.

The number of turbines in the farms range from 1-286 in number. Large and middle range blade sections could be of a shell shaped internal structure, middle and small blades are usually shell shaped blade with foam core while small and micro wind turbine blades have a shaped blade with fully filled structure (Krstulovic-Opara et al. 2009).

OSB at Home Depot comes in sizes of 2ft x 4ft (0.6 x 1.2 meters) and 4ft x 8ft (1.2 x 2.4 meters). This study focuses on the latter size for functional units of exterior residential building envelopes replacing OSB boards placed on studs.

The methods of cutting fiber involve the use of handsaws, rotary cutting tools, angle grinder and jigsaw. Clear coat and epoxy can be sanded and polished to remove scratches or level low/high spots.

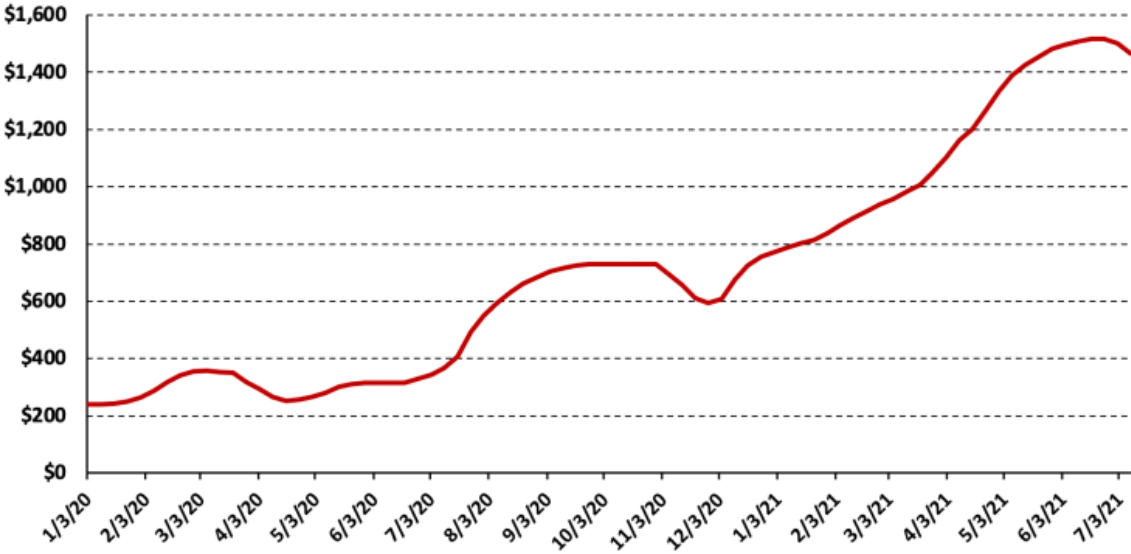

Figure 3: Composite price of OSB. Source: (NAHB, 2021)

1.3. Number of turbine blade boards

The dimensions of the OSB were mapped out along the surfaces of nine sizes of turbine blades obtained from farms in Texas, Figure 4a and 4b. Resource efficiency was calculated by determining the percentage surface area of WTRB converted to OSB, dividing the area of obtainable boards with the total surface area of the blade, Table 1. Details of data analysis for number of turbines at farms are in a supplementary document.

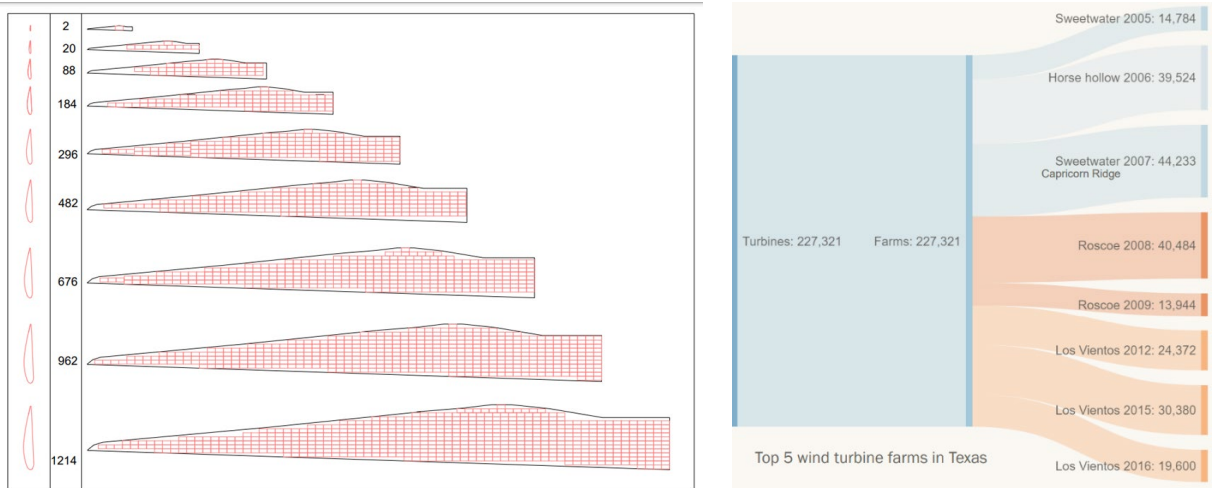

Figure 4a & 4b: (Left) Mapping of turbine blade boards on blades. Source: (Authors, 2022). (Right) Sankey diagram of top five wind farms in Texas. Source: (Authors, 2022)

Table 1: Resource efficiency of turbine rotor boards. Source: (Authors 2022)

Turbine rotor diameter (m)	Surface Area of turbine rotors (m ²)	Number of boards	Area of boards (m ²)	Resource efficiency (%)
13	243	2	5.76	23.70
33	148.64	20	57.6	38.75
53	383.82	88	253.44	66.03
73	728.06	184	529.92	72.79
93	1162.28	296	852.48	73.35

113	1704.06	482	1388.16	81.46
133	2392.3	676	1946.88	81.38
153	3187.48	962	2770.56	86.92

1.4. Simple linear regression

To calculate for the maximum possible number of boards from the wind farms in Texas, the total surface area of rotor blades was predicted using simple linear regression and multiplied by the number of turbines in the wind power project, Figure 5a, b and c. Thereafter the average resource efficiency was used to determine the quantity of recovered material, number of boards, avoided costs and emissions.

The prediction was carried out by using a linear model in equation 1 from the relationship between turbine rotor diameters and their surface areas.

$$\text{Surface area} = 22t_rd - 598.5 \tag{1}$$

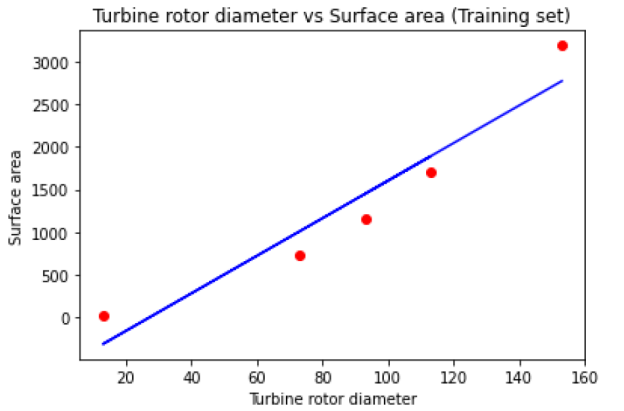

a)

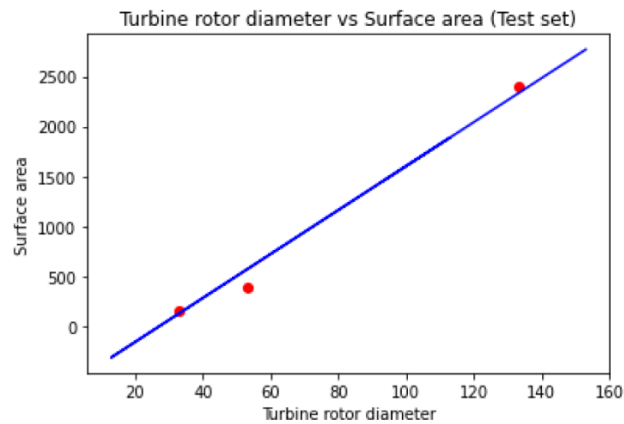

b)

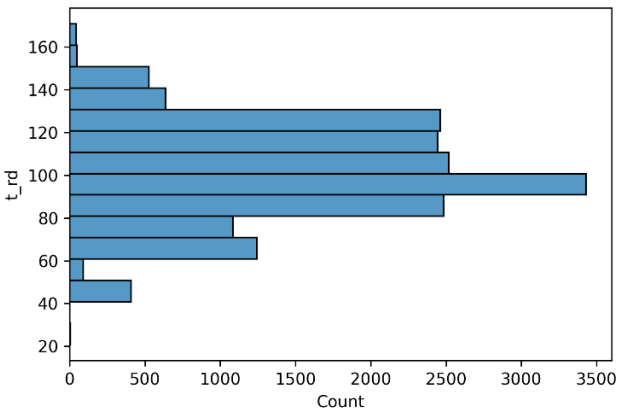

c)

Figure 5: (a&b) Training and test set data visualization for model surface area in square meters and diameter in meters; c. Histogram of turbine rotor diameters (t_rd) in meters for windfarms in Texas. Source: (Authors, 2022)

Total surface areas of all turbines in Texas were calculated as 2,885,643,790m². The resource efficiency of 65.5% was applied showing that a total area of 1,904,524,901.4m² could be available for OSB boards. From student coursework in Figure 5, the average area of the total number of boards for roof decking and walls in a three-bedroom residential building was calculated as using the quantities tool and wall schedule in Revit as 981m²

1.5. Student coursework

Students produced construction drawings of 3-bedroom single family residential buildings in a semester long project. The construction drawings consisted of: site plans, floor plans, roof plans, sections, details, elevation views, and 3D view of the buildings. The students also drew complete framing plans of the residential building (foundation, wall framing, floor framing, and roof framing). Some of the projects are shown in Figure 6, and the total surface area of the building walls and roofs for eight projects were evaluated using the schedule/quantities tool under view tab in Revit, Table 2.

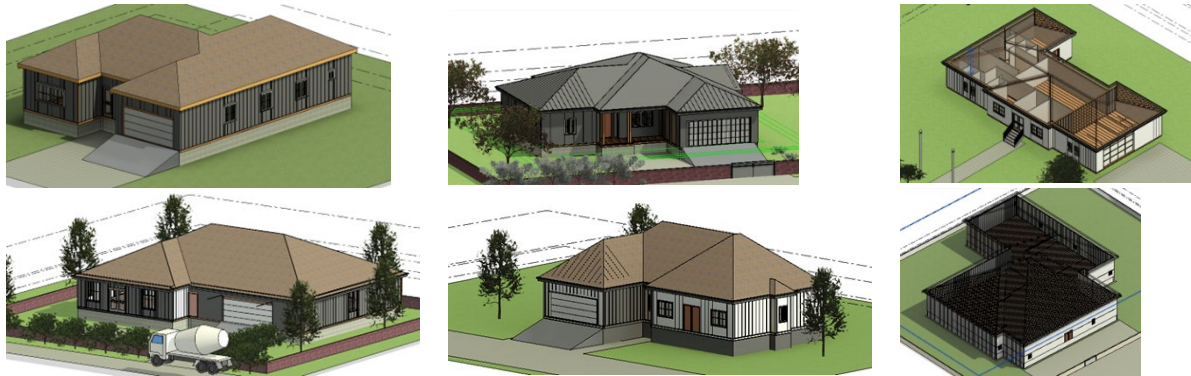

Figure 6: Student coursework for three-bedroom residential buildings. Source: (Authors, 2022)

Table 2: Surface area of roofs and walls in students' projects. Source: (Authors 2022)

Building	Roof (m ²)	Walls (m ²)
1	457	817
2	271	296
3	309	338
4	143	188
5	304	421
6	302	367
7	473	470
8	1378	1315

2.0 RESULTS

2.1. Environmental impacts

Environmental impacts were evaluated using the Waste Reduction Model (WARM) from the United States Environmental Protection Agency, all sizes were converted to tons. The weight of one 7/16inch (11mm) OSB sheathing panel of 4ft by 8ft (2.88m²) is 44 pounds. The total available area of 1,904,524,901.4m² would weigh 29,096,908,215.8 pounds (14,548,454 tons). When sheathing/medium-density fiberboard is reduced at source in WARM, the greenhouse gas emissions from the repurposed scenario would be reduced by 22,692,886.11 MTCO₂E; equivalent to removing annual emissions from 4.8 million passenger vehicles, conserving over 2,500 million gallons of gasoline or conserving 945 million cylinders of propane used for home barbeques. This amounts to 1.3% annual emission from the U.S transportation sector and 1.3% annual emissions from the U.S. electricity sector. Comparing this figure to the 2021 data (American Clean Power, 2023) where wind energy avoids 340 million metric tons of CO₂ emissions annually, repurposing the decommissioned wind turbine rotor blades will increase avoided annual CO₂ emissions by 7%. The avoided energy from the repurposed TRB scenario was given as 162,630,657.25 million BTU equivalent to conserving 1.7 million household's annual energy consumption, 28 million barrels of oil or 1,350 gallons of gasoline. Dividing 1,904,524,901.4m² by 981m² results in a total of approximately 1.9 million roof decks and walls coverage in three-bedroom bungalows in Texas.

2.2. Economic impacts

The economic impacts were calculated by comparing with current prices in Home Depot, considering the avoided costs. The cost of one OSB 7/16 in. Sheathing Panel is \$10.9. Applying this cost to the total surface area results in boards giving possible avoided costs equivalent to \$7,208,097,717.

CONCLUSION

This study presented modular design innovation in a methodological workflow based on supply and demand towards substituting high demand, oriented strand boards with decommissioned wind turbine rotor blades from wind farms in Texas, Figure 7. Using modular design principles, geometry, and simple linear regression, OSB was matched with secondary sourced novel turbine rotor boards from the farms. Also, student coursework was used for average surface area of walls and roof deck in three-bedroom residential buildings. Findings showed that repurposing decommissioned wind turbine rotor blades could increase wind industry's avoided CO₂ emissions by 7%. Future work includes improving resource efficiency by exploring different workflows and geometry.

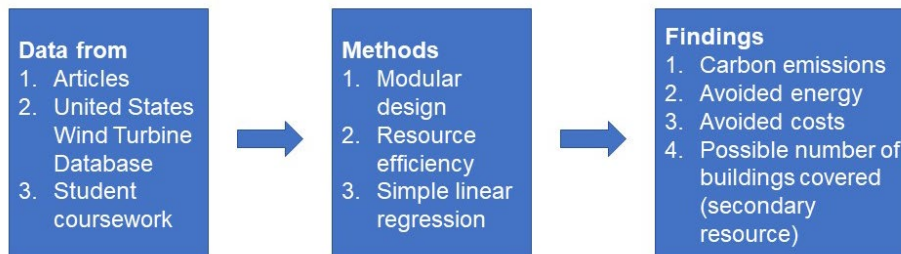

Figure 7: Methodological workflow for repurposing decommissioned wind turbine rotor blades as oriented strand board. Source: (Authors, 2022)

ACKNOWLEDGEMENTS

Burcu Salgin was funded through the 2219-International Postdoctoral Research Fellowship from the Scientific and Technological Research Council of Türkiye within the research titled “Establishing a Design Framework for Repurposing to achieve Industrial Symbiosis and activate Circular Economy: Wind Turbine Blades and Solar Panels as Case Studies”.

REFERENCES

- Alsaleh, A., Sattler, M. 2019. *Comprehensive life cycle assessment of large wind turbines in the US*. Clean Techn Environ Policy 21, 887–903. <https://doi.org/10.1007/s10098-019-01678-0>
- American Clean Power. 2023. Retrieved from <https://cleanpower.org/facts/wind-power/#:~:text=Wind%20is%20America's%20largest%20source%20of%20renewable%20energy.&text=Wind%20is%20the%20largest%20source,the%20country's%20electricity%20and%20growing>
- Brøndsted, P., Lilholt, H., and Lystrup, A., 2005. *Composite Materials for Wind Power Turbine Blades*. Annu. Rev. Mater. Res., 35(1), pp. 505–538.
- Cooperman, A., Eberle, A. and Lantz, E., 2021. *Wind turbine blade material in the United States: Quantities, costs, and end-of-life options*. Resources, Conservation and Recycling, 168, p.105439.
- EPA, US. 2020. Sustainable Materials Management. edited by Department of the Interior. Washington DC: EPA, US.
- Kaestner, D. 2015. "Life cycle assessment of the oriented strand board and plywood industries in the United States of America."
- Hoehn, B.D., Diffendorfer, J.E., Rand, J.T., Kramer, L.A., Garrity, C.P., and Hunt, H.E., 2018, United States Wind Turbine Database v5.3 (January 13, 2023); U.S. Geological Survey, American Clean Power Association, and Lawrence Berkeley National Laboratory data release, <https://doi.org/10.5066/F7TX3DN0>
- Krstulovic-Opara, L., Branko K., and Zeljko D. 2009. "A non-destructive wind turbine blade analysis based on the Thermal Stress Analysis." Proceedings of the international symposium on coupled methods in numerical dynamics, CMND.
- Lawson, R., Ogden, R., and Bergin, R. 2012. "Application of modular construction in high-rise buildings." Journal of Architectural Engineering, 18(2), pp. 148–154.
- Liu, P., and Claire Y. B. 2017. "Wind turbine blade waste in 2050." Waste Management, 62, pp. 229-240.
- MBI. 2010. Improving Construction Efficiency and Productivity with Modular Construction. Charlottesville, VA: Modular Building Institute, US.
- McGraw-Hill Construction. 2011. Prefabrication and Modularization: Increasing Productivity in the Construction Industry. Bedford, MA: McGraw-Hill Construction.
- NAHB. 2021. Price of OSB Up More Than 500% Since January 2020.
- Rani M., Priyanka C., Venkata K., and Sunny Z. 2021. "A review on recycling and reuse methods for carbon fiber/glass fiber composites waste from wind turbine blades." Composites Part B: Engineering 215. doi: 10.1016/j.compositesb.2021.108768.
- Silvaris. 2021. The Current State of the OSB Market in 2021.
- Veers, Paul S., Thomas D. A., Herbert J. S., Daniel L. L., Donald W. L., Dayton A. G., John F. M., Walter D. M., Kevin J., and Michael Z. 2003. "Trends in the design, manufacture and evaluation of wind turbine blades." Wind Energy: An International Journal for Progress and Applications in Wind Power Conversion Technology 6 (3), pp. 245-259.

Investigations in 3D Printing of Precast Molds

Jeffrey Collins¹

¹Kennesaw State University, Marietta, GA

ABSTRACT: Since its development, designers and inventors have been fascinated by experimenting with precast concrete. As a material and a means of production, the plasticity and efficiency of precast captures the imagination of those looking to push the boundaries of both construction procedures and architectural expression. Over the course of the past century, however, public opinion regarding precast concrete has been mixed. Concurrently, advancements in 3D printing have the technology primed to make significant impacts on a number of industries. In the past few years, innovations in additive manufacturing have halved in cost while delivering twice the performance. Though design opportunities afforded through computation and 3D printing suggest new spatial possibilities and question traditional construction techniques, standard manufacturing processes like precast tend to churn at a much slower pace. One area that may be particularly due for research and innovation is formwork; the custom molds into which concrete parts are cast. An elective course was developed as an introduction to using additive manufacturing to enhance the architectural expression of precast concrete, capitalizing on the benefits offered by each system: rapid prototyping, flexibility, modularity, structural stability, longevity. In particular, the focus was on the potential of 3D printing molds. The work further aimed to extend architectural precast components beyond facade panels and into occupiable spaces. Summaries of research conducted, best practices learned, and student work produced via digital and physical models at various scales and materials are presented, analyzed, and discussed.

KEYWORDS: Additive manufacturing, digital design, fabrication, casting, precast concrete

INTRODUCTION

Since its development in the early 1900s (Slaton, 2001), designers and inventors have been fascinated by experimenting with precast concrete. As a material and a means of production, the plasticity and efficiency of precast captures the imagination of those looking to push the boundaries of both construction procedures and architectural expression. One of the masters of custom precast components was Marcel Breuer, who declared “the use of precast concrete is the most important change in the art of building...You can sculpt concrete; you can mold it; you can chisel it. It increases the vocabulary of architectural expression.” (Gatje, 2000) Designers and inventors love concrete. Over the course of the past century, however, public opinion regarding precast concrete has been mixed. A combination of factors – overuse of mass-produced elements, maintenance challenges (Meloy, 2016), and sustainability concerns (Rothman, 2021) – placed precast in a bad light. Previous research (Collins, 2019) suggested the recent lack of expressive precast facade design was further exaggerated by the disconnect in traditional designer and fabricator modes of working and depicting projects. Ongoing developments in software interoperability, collaborative project delivery methods, and innovative mix designs are reviving interest in the use of precast.

Concurrently, advancements in 3D printing have the technology primed to make significant impacts on a number of industries. In the past few years, innovations in additive manufacturing have halved in cost while delivering twice the performance. (Wilson, 2020) 3D printing is ubiquitous, “accelerat[ing] innovation and support[ing] businesses in various industries including engineering, manufacturing, dentistry, healthcare, education, entertainment, jewelry, and audiology.” (formlabs, 2019) 3D printers simultaneously represent advanced technology, and are affordable for home use. Furthermore, used in the classroom, rapid prototyping can enhance learning; offering students agency and forming physical connections to curriculum. (Bertels, 2017) Consequently, there is no shortage of research into the potential of 3D printing in architecture and construction presently occurring at various scales, sorts of materials (Rael and San Fratello, 2018), and levels of integration. Limitations only appear to be one’s imagination, resources, and budget. Documentation of best practices (Wu et al., 2016) is critical; 3D printers – like other tools – have specific procedures, requiring both experimentation and rigor to effectively overcome constraints and push apparent boundaries.

Though design opportunities afforded through computation and 3D printing suggest new spatial possibilities and question traditional construction techniques, standard manufacturing processes like precast tend to churn at a much slower pace. One area that may be particularly due for research and innovation is formwork; the custom molds into which concrete parts are cast. Construction of formwork is notoriously labor-intensive and costly. (Wei et al., 2022) Furthermore, and ironically, the construction of formwork remains shrouded in the mystery of contractual “means and methods” and yet is heavily influential to achieving design intent. Some projects have strived to overcome these challenges through use of digital modelling and direct-to-fabrication approaches. (Aghaei Meibodi et al., 2018, Hun and Post 2019, Kudless et al., 2020). While inspiring, these works often involve substantial research labs, extensive resources, and result in novel solutions. Realization of similar designs, therefore, may appear difficult to attain.

An elective course was developed as an introduction to using additive manufacturing to enhance the architectural expression of precast concrete, capitalizing on the benefits offered by each system: rapid prototyping, flexibility, modularity, structural stability, longevity. In particular, the focus was on the potential of 3D printing molds. The work further aimed to extend architectural precast components beyond facade panels and into occupiable spaces. Summaries of research conducted, best practices learned, and student work produced via digital and physical models at various scales and materials are presented, analyzed, and discussed.

1.0 METHODOLOGY AND FINDINGS

With the financial support of the PCI (Precast/Prestressed Concrete Institute) Foundation, this course was initially offered for the Spring 2022 semester. Students enrolled in the five-year Bachelor of Architecture program are required to complete 11 hours of elective credits. The course was two credit hours and open to upper-year students in the Bachelor of Architecture program. Six students enrolled; three in fourth-year and three in fifth-year. Class periods were scheduled once per week and included a combination of lectures, software demonstrations, student presentations, and interactive workshops. Students visited a local precast concrete plant to observe precast production first-hand.

Student Learning Objectives (SLO) included:

- A. Exploring methods for incorporating 3D printing into architectural design and construction
- B. Strategizing the design and construction of forms for casting
- C. Employing parametric digital modelling for custom components
- D. Iterating the design of individual and aggregation of occupiable modules
- E. Preparing documents for full scale physical mock-ups

Course exercises progressed through four phases:

1. Everyday objects as modules
2. 3D printed modules
3. Cast modules
4. Full scale physical mock-ups

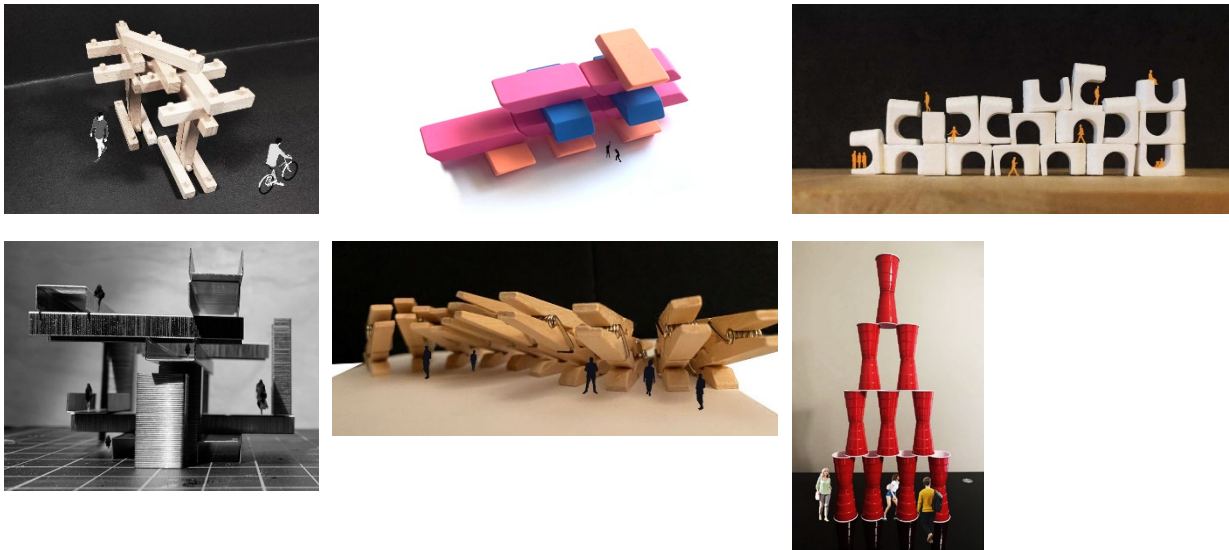

Figure 1: Example Phase 1 student work. (Top left: David Feregrino Rodriguez, Top middle: Austin Turner, Top right: Ana Valdez Tello, Bottom left: Enrique Brimmer, Bottom middle: Tim Gatto, Bottom right: Elizabeth Rodriguez, 2022)

1.1 Phase 1

Inspired by Sou Fujimoto’s “Architecture is Everywhere” exhibit (McKnight, 2015) and initially working individually, students collected household items; at least 20 of the same object. Items were assembled in various ways to capture space. This was a quick exercise; one week. The goal was twofold; to begin to see everyday objects in new ways and to explore aggregates of repetitive modules. Both objectives will recur in future phases. Students were encouraged to assemble, document, and reassemble multiple different combinations, promoting iteration. Example student work from Phase 1 is shown in Figure 1.

Noted takeaways from Phase 1 included:

- Items can be combined to create a new modules, then that part aggregated
- Items may already be assembled from modular parts

- Certain items lend themselves to interpretation as solid objects or as occupiable spaces
- Items with flat sides make them easier to stack
- Items with irregularity allows for variety of configurations

Students began to observe and cultivate strategies for capturing space with modules (SLO D). Key to this outcome – for this and future phases – were several project tasks: “playing” with components, including scale figures, documenting various assemblies, and producing drawings (sections or section perspectives) of assemblies.

1.2 Phase 2

A three-week long assignment, students began Phase 2 by researching existing projects and issues with 3D printing (not as molds). Noted takeaways from this research included:

- Scale varies widely from printing of whole buildings to printing of components
- Direct use of digital modelling can increase accuracy of custom, complex geometries
- Ability to create high-quality prototypes during design process
- Potential reduction in material use based on analysis of design performance and geometric optimization
- Potential reduction in fabrication time, construction waste, and onsite operations
- Variety of materials available

Continuing to work individually (though this could be in pairs with students merging the best qualities of each of their Phase 1 projects, if more enrolled) and inspired by their 3D printing research, digital models of new modules were developed. Then, 3D prints were created using Creality CR-20 Pro machines and standard PLA (Polylactic Acid) filament; at least 20 same part. Again, students were encouraged to assemble, document, and reassemble multiple different combinations, promoting iteration. As custom components, redesign and reprinting of modules based on aggregate goals was supported. Example student work from Phase 2 is shown in Figure 2.

Noted takeaways from Phase 2 prototypes included:

- Consider how individual parts are defined and will be connected to one another during redesign process
- It may be desirable to design assemblies that don't appear repetitive
- 3D printed parts may require clean up and finishing
- Clay, tape, or clips can be used to temporarily hold parts together

Using new modules capture space with, students incorporated additive manufacturing into their design process. (SLO A, C, and D) Therein, the 3D printer was used as a design tool; 3D printed components used as prototypes to learn from rather than as final products.

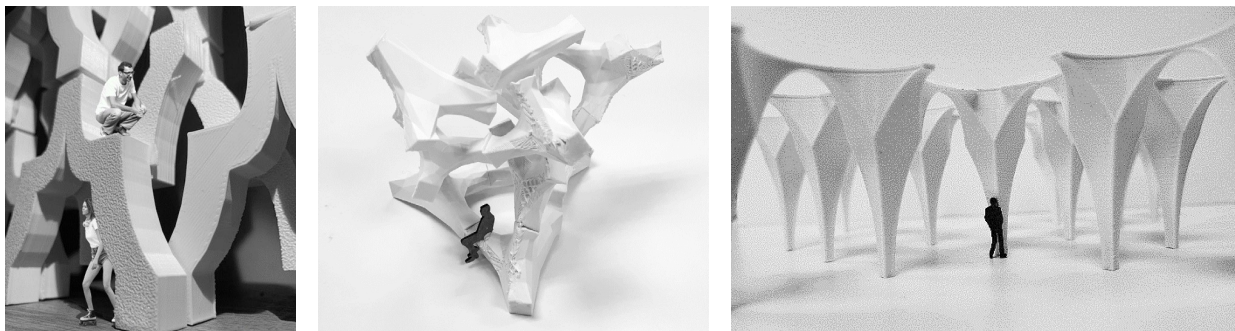

Figure 2: Example Phase 2 student work. (Left: Elizabeth Rodriguez, Middle: Austin Turner, Right: David Feregrino Rodriguez, 2022)

1.3 Phase 3

A six-week long assignment, students began Phase 3 by researching existing projects and issues with formwork (not 3D printed). Noted takeaways from this research included:

- Variety of materials used
- Variety of formwork scales
- Consider panelization (how elements are separated into individual cast parts) during design of formwork
- Extensive time taken to assure accuracy of mold before casting

Working in pairs (this could be increased with more students enrolled) and inspired by their formwork research, students first began by merging the best qualities of each of their Phase 2 projects. Digital models were developed for open one-part molds for new components. Then, 3D printed molds were created and parts were cast (using resin and/or plaster); at least 10 same part. Again, students were encouraged to assemble, document, and reassemble multiple different combinations, promoting iteration. As custom components and molds, redesign and reprinting of modules and molds

and recasting of parts based on aggregate goals was supported. Example student work from Phase 3 is shown in Figure 3. At the end of this phase, local precast producers attended student presentations to provide feedback.

Noted takeaways from Phase 3 prototypes included:

- Suggestion to add drafts (1/4" per 8" thickness) to aid in demolding; this could be exaggerated as a design feature
- Consider form dividers to allow portions of master forms to be used to cast variations of elements
- Larger scale elements are more efficient to form
- Design connections between elements; consider trade-offs for using custom or universal connections

Students extended the use of additive manufacturing within their design processes to the construction of molds to cast novel components, which were then used again to as modules capture space. (SLO A, B, C, and D) Therein, students directly engaged fabrication processes; tasks typically unknown to architects.

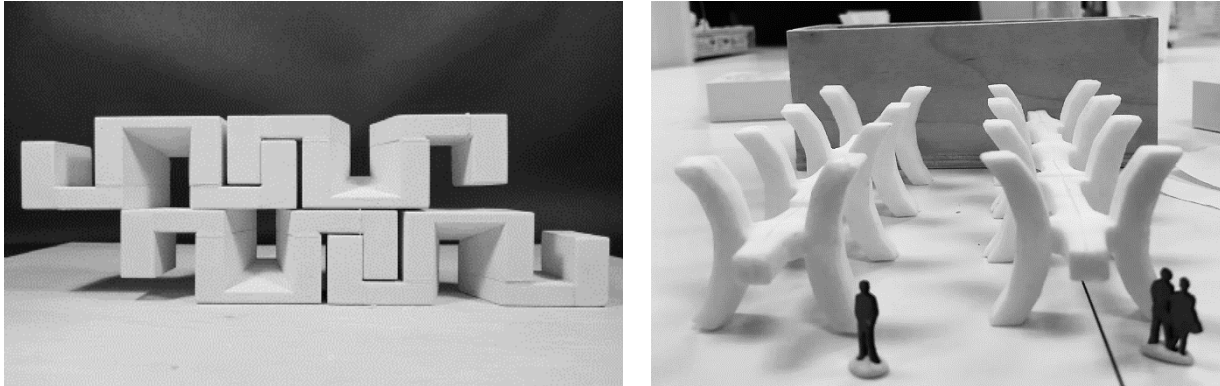

Figure 3: Example Phase 3 student work. (Left: Enrique Brimmer and David Feregrino Rodriguez, Right: Ana Valdez Tello and Elizabeth Rodriguez, 2022)

1.4 Phase 4

During Phase 4 (six weeks), all six students worked together to develop digital and physical models of modules that merged the best of each of the Phase 3 projects. (Again, this could be more large groups of 4-6 students each with more enrolled.) Incorporating suggestions from Phase 3 presentations, new digital and physical models were developed; Figure 4.

An initial parametric model conceived of the Phase 4 module as one vertical bar flanked by two horizontal bars. Then, a series of intersecting surfaces associated with the bars blend the vertical and horizontal elements together and form the module (Figure 4a). Similar to previous phases, physical models (Figure 4b) allowed for exploration of different combinations, iterated back to the digital parametric model (Figure 4c), which was modified to coordinate aggregate goals (Figure 4d). Based on experience 3D printing and casting, it was determined that it would be most beneficial to 3D print and cast one half – as opposed to whole, or quarters – of the module at a time. Figure 4b includes ten such models; each took 1 hour 15 minutes to print and cost \$0.18. Digital models of the 3D prints were altered to allow small magnets to be glued to certain points of the physical models; encouraging easy and playful assembly.

A larger scale mold using a Stratasys F170 machine and flexible TPU (Thermoplastic Polyurethane) filament was strategized. Balancing the cast size with the print bed size, it was determined to make a five-part mold. (Two parts are shown in Figure 4e; a base and a top part that is mirrored and rotated to four top parts.) Printed parts are bolted together (Figure 4f). The assembled mold measured 14 inches long, 11.25 inches wide, and 7.5 inches tall. Parts were sanded, and sealant was used at connections. Ready-mix concrete was poured into mold (Figure 4g). Two parts were cast and joined together (Figure 4h).

Table 1 lists the print times, quantities of TPU and support material, and cost for each of the five mold parts. The average print time of the upper four mold parts was 24 hours 10 minutes 31 seconds. The lower mold part is larger, and its print time was accordingly larger at nearly 38 hours. The total print time for all five parts was 134 hours 38 minutes 6 seconds; five and a half days. The average cost of the upper four mold parts was \$47.73. The cost of the lower mold part was \$76.36. The total cost for all five parts was \$267.29. So far, three casts have been made using the form, with no wear noticed; many more could be produced. Students prepared documents for a full scale physical mock-up intended to be built in collaboration with precast producers. (SLO E) However, due to scheduling constraints, this undertaking was postponed.

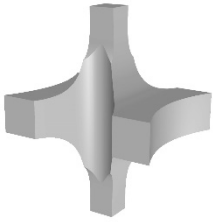

a. Parametric module



b. Physical model aggregation

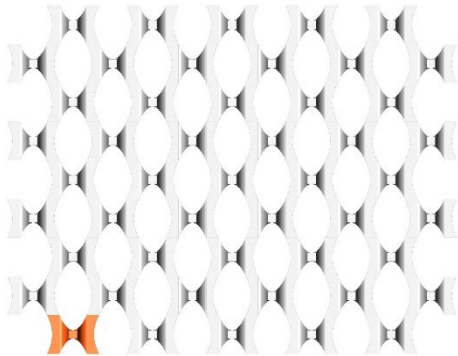

c. Coordinating module in aggregate



d. Digital model aggregation

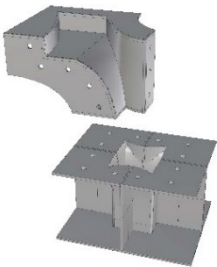

e. Digital model of molds

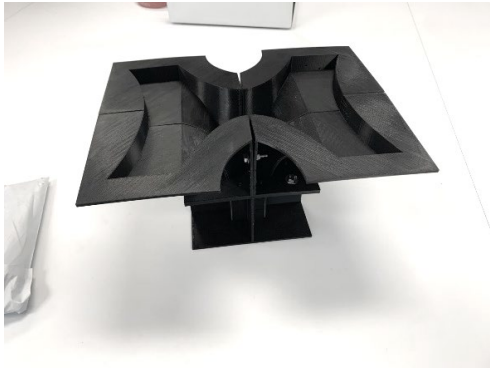

f. 3D printed mold



g. Initial cast



h. Assembly of two casts

Figure 4: Developing and casting Phase 4 module. (Author 2023)

Table 1: Print times, material quantities, and costs for final mold parts.

Part	Print time	TPU material (cu in)	Support material (cu in)	Total cost (\$)
1	24:11:09	9.253	5.856	47.72
2	23:46:07	9.221	5.748	47.53
3	37:56:04	15.904	8.363	76.36
4	24:52:23	9.246	5.946	48.00
5	23:52:23	9.229	5.866	47.68

CONCLUSION

This paper has discussed the research conducted, best practices learned, and student work produced via digital and physical models at various scales and materials during an elective course developed as an introduction to using additive manufacturing to enhance the architectural expression of precast concrete. The work – including effectiveness of strategies for teaching digital parametric modelling, aggregating of modules, 3D printing, and mold-making, incorporating 3D printing into architectural design and construction processes, and lessons learned through making – is ongoing, with future offerings of the course planned for Spring 2023 and beyond. Best practices noted and student work produced in this initial offering will inform course development. In particular, the following modifications are suggested:

Phase 2

- Emphasize collection and analysis of inspiration projects NOT 3D printed
- Illustrate modules as parametric; practice making parametric models
- Note material costs, fabrication times, and other key 3D printing takeaways

Phase 3

- Emphasize collection and analysis of inspiration projects NOT concrete
- Research molds for cast elements NOT concrete (as well as those that are for concrete)
- Focus on one-part molds first, then multi-part molds
- Develop molds in other materials first, then incorporate 3D printing
- Illustrate digital molds as parametric; further practice making parametric models
- Note material costs, fabrication times, and other key mold-making and casting takeaways

Phase 4

- Document issues printing with flexible filament; thickness of walls (too thick makes mold less flexible, too thin and mold may deform), number, location and connections between support fins and mold parts, detailing of part connections (reduce use of sealant, reduce visibility of joint)
- Emphasize treatment of form before casting; sand, seal, coat
- Emphasize treatment of cast after curing; sand, patch, polish
- Adjust schedule to work earlier and more directly with precast producers, at production plant if possible
- Consider benefits of additive manufacturing and formwork as assemblage; entire mold may not be 3D printed

Additional future work may include:

- Apparent relationship between ideal orientation for 3D printing parts and (when flipped over) casting into formwork
- Potential of magnets used to assemble 3D printed models as analogy to connection plates
- Incorporation of additional construction and assembly issues such as structural reinforcing, lifting anchors, connection plates
- Further analysis of print times and material costs, especially in comparison to traditional methods
- Extending to larger molds and casts

ACKNOWLEDGEMENTS

The work presented herein was possible through the financial support of the PCI (Precast/Prestressed Concrete Institute) Foundation. Special thanks to co-investigators Elizabeth Martin-Malikian and Giovanni Loreto; our partners at Metromont Corporation, Tony Smith and Gary Lentz; Kennesaw State University (KSU) architecture students Enrique Brimmer, Tim Gatto, David Feregrino Rodriguez, Elizabeth Rodriguez, Ana Valdez Tello, Austin Turner; and KSU staff members Rachel Johnson and Sabrina Seaman.

REFERENCES

Aghaei Meibodi M., Jipa A., Giesecke R., Shammas D., Bernhard M., Leschok M., Graser K., Dillenburger B. 2018. *Smart Slab: Computational Design and Digital Fabrication of a Lightweight Concrete Slab*. ACADIA 2018: On Imprecision and Infidelity.

- Bertels, R. 2017. *Why your child's future is in 3D printing*. *Education Technology*. Education Technology. <https://edtechnology.co.uk/comments/why-your-childs-future-is-in-3d-printing-1513164352/>
- Collins, J. 2019. *A Framework for Coordinated Models of Architectural Precast Concrete Façades*. PhD Dissertation. Georgia Institute of Technology.
- formlabs. 2019. *Additive Manufacturing: Industry Trends and Outlook*. <https://formlabs.com/blog/additive-manufacturing/>
- Gatje, R. 2000. *Marcel Breuer: A Memoir*. New York: The Monticelli Press.
- Hun D., Post B. 2019. *3D printing shapes building industry, creates rapid construction potential*. Oak Ridge National Laboratory. <https://www.ornl.gov/news/3d-printing-shapes-building-industry-creates-rapid-construction-potential-1>
- Kudless A., Zabel J., Naeve C., Florian T. 2020. *The Design and Fabrication of Confluence Park*. Fabricate 2020: Making Resilient Architecture.
- McKnight, J. 2015. *Sou Fujimoto creates installation from potato chips and ping-pong balls*. Dezeen. <https://www.dezeen.com/2015/10/23/sou-fujimoto-architecture-is-everywhere-installation-chicago-biennial-2015-household-items/>
- Meloy, G. 2016. *Architectural Precast Concrete Wall Panels: Their Technological Evolution, Significance, and Preservation*. (Master's Thesis) Philadelphia: University of Pennsylvania.
- Rael R., San Fratello V. 2018. *Printing Architecture: Innovative Recipe for 3D Printing*. New York: Princeton Architectural Press.
- Rothman, M. 2021 *Can concrete, a major CO2 emitter, be made greener?* PBS NewsHour. <https://www.pbs.org/newshour/show/can-concrete-a-major-co2-emitter-be-made-greener>
- Slaton, A. 2001. *Reinforced Concrete and the Modernization of American Building, 1900-1930*. Baltimore: Johns Hopkins University Press.
- Wei L., Xiaoshan L., Ding W., Bao Y., Min X. 2022. *A review of formwork systems for modern concrete construction*. Structures Volume 38.
- Wilson, G. 2020. *The evolution of 3D printing in manufacturing*. Manufacturing Global. <https://manufacturingdigital.com/technology/evolution-3d-printing-manufacturing>
- Wu P., Wang J., Wang X. 2016. *A critical review of the use of 3-D printing in the construction industry*. Automation in Construction Volume 68.

Learning From the Past: Evaluation and Optimization of the Inherent Energy Performance of a Residential Historic Building in a Hot and Humid Climate

Layla Iskandar¹, Panos Karaiskos¹, Antonio Martinez-Molina², Saadet Beeson¹

¹The University of Texas at San Antonio, San Antonio, TX

²Drexel University, Philadelphia, PA

ABSTRACT: Rehabilitating disused historic buildings and optimizing their energy efficiency is an effective approach to decreasing energy consumption and ensuring the continuity of their life. Achieving a successful retrofit project should take into deliberation not only potential energy savings but also the preservation of the historic building's character. This study presents an analysis approach and associated results of rehabilitating and enhancing the energy performance of an unused historic residential building located in San Antonio, Texas. The character-defining features and inherent energy-efficient characteristics of the building are analyzed thoroughly to ensure their preservation and inclusion in the retrofit plan. This analysis coupled with national guidelines on improving energy efficiency in historic buildings is used to suggest a set of retrofit measures tailored to the building's specific needs. Additionally, a building energy model, created using DesignBuilder software and validated with a 5-month environmental monitoring campaign during the cooling period, is used to compare the energy consumption of the building in its historic state to two scenarios: Scenario A: the building is retrofitted without changing its use; Scenario B: the building is adapted to an office and retrofitted. The results revealed that the application of the selected retrofit package decreased cooling loads by around 60% in both scenarios, although the energy savings are higher in Scenario A. The energy consumption related to lighting and external infiltration were also reduced greatly. Moreover, indoor temperatures were decreased by 5 to 6°F in both cases. This study proves that a holistic approach that balances the goals of energy efficiency with those of historic preservation can result in successful energy retrofits in a hot and humid climate.

KEYWORDS: Energy retrofit, Historic building, Building simulation, Rehabilitation, Heritage

INTRODUCTION

The existing building stock is responsible for over one-third of global energy consumption and a considerable portion of greenhouse gas emissions (IPCC 2014). Regrettably, a substantial proportion of older buildings have poor energy performance, and thus great reductions in energy consumption can be achieved through energy retrofits. According to ASHRAE (2022), the enhancement of energy performance in existing buildings can be attained by modifying existing equipment, inherent systems, or building materials and features. Historic buildings particularly represent an indispensable share of existing assets. However, retrofitting them for energy enhancement is a complex task due to their unique physical characteristics and associated conservation principles. Subsequently, a successful retrofit of a historic structure can only be realized by balancing the objectives of energy efficiency with those of historic preservation. As stated in Preservation Brief 3 of the National Park Service (Hensley and Aguilar 2011), planning must holistically consider the building envelope, its systems and components, site, and environment, in addition to the thorough evaluation of all the measures to be implemented.

A comprehensive literature review by Lidelöw et al. (2019) investigated the relationship between energy efficiency and heritage conservation of buildings. Their findings reveal that research in this field mainly concentrates on the energy facet while rarely articulating the valuable architectural and cultural values of historic buildings. They conclude that it is imperative to articulate and analyze the cultural values of a historic building when considering energy-efficiency measures by implementing value-assessment methodologies and theories. In addition to featuring valuable architectural elements and materials, historic buildings have inherent sustainable features – e.g. porches, awnings, shutters, skylights, and vents – that play a major role in how they perform. Moreover, their unique construction methods – e.g. design, size, shape, orientation, surrounding landscape – and materials often responded to the local conditions of hot and cold temperatures, humidity and precipitation, wind and ventilation, and light and shadow to ensure human comfort (Franzen 2015). Therefore, it is essential to ascertain all existing energy-efficient characteristics and plan to integrate them as much as possible with any new treatments to further enhance energy performance.

Retrofit solutions common to new construction are not always suitable for historic buildings due to the need to protect the historic fabric and visual character. For instance, almost all studies in the literature exclude the use of exterior insulation due to its harmful impact on historic facades (Webb 2017). Additionally, while on-site generation using solar thermal, solar electric, or wind contributes to great energy savings, it can have a significant impact on a building's

historic character (Webb 2017). New treatments must thus be thoroughly evaluated before implementing them to avoid irreparable damage to valuable architectural features, materials, and the building's surroundings. Multiple strategies and passive energy solutions (Martinez-Molina and Alamaniotis 2020) nevertheless can substantially improve the energy efficiency of a building without invasive and intrusive interventions (Bay et al. 2022). For example, treatments such as air sealing, improvements to mechanical systems and appliances, and adding insulation where it has little effect on historic fabric, all yield great energy savings without having a negative impact on the building's cultural value (Hensley and Aguilar 2011). Moreover, many scholars offer innovative solutions by examining novel technologies that can be integrated with the building fabric and decrease the visual impact. For instance, Cristofari et al. (2015) developed a novel flat-plate solar thermal collector prototype that can be fully integrated with a historic building's envelope. Polo López and Frontini (2014) also explore new construction systems and solar components that can integrate historic protection demands and energy-saving requirements harmoniously.

This study aims to analyze the potential of optimizing the energy performance of a historic residential building, particularly in a hot and humid climate. It presents a methodological approach that takes into consideration the building's cultural heritage values in addition to its existing energy-efficient characteristics. The authors attempt to highlight directions of development to enhance the historic building's energy efficiency without compromising cherished qualities.

1.0 CASE STUDY

The chosen case study, the Kelso House, is a 2.5 stories mansion built in 1907. It is located in the Monte Vista National Historic District, slightly north of Downtown San Antonio, Texas. San Antonio is 240.5 meters (m) above sea level and has a Cfa-Humid Subtropical Climate and a Bsk-Semi-Arid Climate on the western part of the city per the Köppen-Geiger climate classification (Kottek et al. 2006). The annual average temperature is 21°C (70°F) and summer temperatures reach a high of 38°C (100°F) (U.S. Department of Commerce 2022). The Monte Vista neighborhood was established during the "Gilded Age" between 1890 and 1930 and features notable early 20th-century residential architecture including Mediterranean, Spanish Colonial Revival, Queen Anne, Italian Renaissance, Neoclassical, and Victorian style (Everett 1999). The Kelso house, designed by celebrated architect Atlee B. Ayres, was designed in the simplified Neoclassical style with Queen Anne and Craftsman influences (Ahlquist et al. 2021). The house's historic significance is also associated with its owner Judge Winchester Kelso, a civic leader who was known as one of the most distinguished jurists in the state (Huddleston 2022). The house was constructed of wood framing and finished with wood cladding, particularly painted wood teardrop siding and shingles with trim. It has Queen-Anne-influenced asymmetrical facades with a wrap-around two-story porch extending to the south and east. Neoclassical decorative elements include grandiose Doric columns, wood-trimmed entablature with frieze, dentils, cornice, and wood balustrades. It also features Tudor gables and complex Craftsman roof proportions, and the windows have a wood frame with single-pane glass. The plan arrangement is irregular and asymmetrical reflecting Craftsman influence.

After being abandoned for a long period, the Kelso House was acquired in 2018 by the Power of Preservation Foundation (PoP) which subsequently restored the exterior. Since restoration started, the house has served as a hands-on learning laboratory for trades education in partnership with local universities and colleges and The City of San Antonio's Office of Historic Preservation (Power of Preservation Foundation 2022). Currently, the house's interior is still in poor condition, with missing or deteriorated interior finishes in most rooms. The foundation intends to rehabilitate it and change the house's use to an office space. The rehabilitation additionally aims to enhance the house's energy performance and develop inherently sustainable solutions that meet the needs of adaptive reuse without altering any historic materials or features.

2.0 ANALYSIS APPROACH

This study aims to assess the potential retrofit options for rehabilitating a historic residential structure in a hot and humid climate, taking into consideration the inherent energy behavior of the building as well as its heritage values. To achieve that, the following specific objectives were set:

- Determining the cultural and architectural values embedded in the structure that need to be preserved in the process of adaptive reuse.
- Analyzing the inherent energy concept of the building to consider it in the retrofit plan.
- Identifying a set of retrofit strategies that do not compromise the heritage values.
- Evaluating the energy savings achieved by implementing the selected retrofit strategies.

The paper starts by analyzing the features that are important in defining the building's historic character by referencing national and international preservation principles and guidelines. It then assesses the inherent energy-efficient characteristics of the structure to plan the energy retrofit smartly and efficiently. Based on the previous analyses, in addition to referencing the guidelines of the National Park Service on improving the energy efficiency of historic buildings (Hensley and Aguilar 2011), a building energy retrofit package suitable for the unique needs of the building is selected. Thereafter, building energy models are developed in DesignBuilder software to evaluate the efficiency of the designated retrofit measures. The energy models are calibrated using indoor temperature measurements obtained from the Kelso house during the cooling period from May to September. A series of sensitivity analyses are carried out

to investigate the impact of the retrofit package in two scenarios: Scenario A: The building function is retained throughout the rehabilitation. Scenario B: The building is adapted to office space, as planned by the PoP Foundation. The results of simulating both scenarios are compared to a baseline, where the building is considered in its historic state, and to each other to assess the reductions in energy consumption.

2.1. Heritage value assessment

According to the National Park Service (Nelson 1988), “*Character refers to all those visual aspects and physical features that comprise the appearance of every historic building. Character-defining elements include the overall shape of the building, its materials, craftsmanship, decorative details, interior spaces and features, as well as the various aspects of its site and environment*”. The heritage value assessment in this study follows national standards and guidelines for rehabilitation including the Secretary of the Interior’s standards for the treatment of historic properties (U.S. Department of the Interior National Park Service 1995) and the Secretary of the Interior’s standards for rehabilitation (U.S. Department of the Interior National Park Service 1997). It also considers international conservation principles expressed in documents such as the Venice Charter (ICOMOS 1964), Burra Charter (Australia ICOMOS 2013), and Appleton Charter (ICOMOS Canada 1983).

The spaces, materials, and features that are significant and need to be retained are the following:

- The exterior wood siding, trim and ceiling boards, wood window and door surrounds, and decorative wooden features including the balustrades, columns, entablatures, cornices, and dentil.
- The roof form and materials.
- The exterior doors and their functional and decorative features.
- The exterior windows and their functional and decorative features.
- The main entrance, the stairs, and the porch that wraps the south and east facades with its decorative features.
- The existing awnings and shading structures.
- The interior woodwork, features, and finishes including the beamed ceiling, wall panelling, staircase, cased openings, cornice, moulding, pilasters, and fireplace surround.
- If possible, the interior spatial configuration and relationship of rooms and spaces should be retained.
- The building surroundings and site features.

2.2. Inherent historic energy concept

Historic buildings were often built using readily available materials and responded to local climatic conditions by taking advantage of natural sources of heat, light, and ventilation. Their thermal performance was immensely influenced by the building’s design, size, type of construction, site orientation, materials, and surrounding landscape. They also relied on what is today known as “inherent energy efficient features” such as awnings, porches, skylights, transoms, vents, etc. to enhance energy performance (Webb 2017). Therefore, understanding the intended original energy concept of a historic building is key to a successful retrofit project. According to Everett (1999), the houses built in the Monte Vista Historic District featured stylistic trends from Europe and the Northeast of America, with multiple adjustments to respond to the hot and humid climatic conditions of San Antonio. The following features are key elements of the inherent historic energy concept of the Kelso house:

- The porch to the south and east with the living areas tucked back in the shade where they can catch the summer evening’s southeast breeze from the Gulf of Mexico while reducing heat gain from the sun through the envelope.
- The awnings on the west façade for shading that reduce heat gain from the sun.
- The wide roof overhangs for shading that reduce heat gain from the sun.
- The numerous large operable windows that allow for natural ventilation.
- The open floor plan with openings on opposite sides that allow for cross ventilation.
- The high ceiling which allows the hot air to rise thus contributing to stack ventilation.

Moreover, it’s important to acknowledge that the building in its current condition does not have any heating or cooling systems nor any internal heat gains as it’s unoccupied. Consequently, the internal environmental conditions are solely influenced by the envelope’s performance and the outside weather fluctuations.

2.3. Energy retrofit analysis

In this section, the rehabilitation of the Kelso house is assessed using a set of energy efficiency measures selected from Preservation Brief 3 entitled “Improving Energy Efficiency in Historic Buildings” by the National Park Service (Hensley and Aguilar 2011). The choice of the most suitable retrofit solutions for the building specifically is based on the previous analyses of the heritage values, inherent energy concept, and the current environmental conditions. Alternative energy sources - e.g., devices that utilize solar, geothermal, wind, and other sources of energy to reduce the consumption of fossil fuel-generated energy – are beyond the focus of this study and that of Preservation Brief 3.

Retrofit solutions that require no alteration to the building:

- **Preserving the inherent historic energy concept.** Avoiding the addition of interior partitions that can obstruct cross ventilation as originally intended, preserving the original ceiling height, retaining the size and placement of the openings, and retaining all existing shading devices.
- **Adding a high-efficiency heating and air conditioning system.** Since the building is unoccupied and the retrofit application involves purchasing new heating and air conditioning equipment, choosing a high-efficiency system is known to yield high energy savings in the total energy end use of the building and is thus recommended. The installation should not be invasive/destructive, should be minimally visible, and should consider the preservation of historic materials.
- **Adding high-efficiency equipment and appliances.** Installing light-emitting diode (LED) lamps and choosing high-efficiency appliances to reduce heat gain.

Operational changes also have great effects on energy use and require no alterations to historic materials or features. The following changes are recommended:

- **Encouraging natural ventilation.** Opening windows when temperatures are mild to encourage cross-ventilation.
- **Installing equipment controls.** Using programmable thermostats and timers for lighting and local ventilation, such as exhaust fans.
- **Maintaining mechanical equipment.** Cleaning and servicing mechanical equipment regularly to ensure their continued efficiency.

Retrofit solutions that require minimal alteration to the building:

- **Reducing air leakage.** Since the house is extremely leaky due to the wood-frame construction, reducing unwanted air leakage should be a priority of the retrofit plan. This can be achieved by adding weatherstripping to doors and windows and sealing cracks in the crawlspace, attic, walls, and around the doors and windows.
- **Adding wall insulation.** Since most interior walls are unfinished in the current state of the building, the addition of wall insulation to the walls causes minimal alteration to the envelope while yielding high energy savings, especially since the house has wood-frame walls with a high rate of air infiltration and low thermal inertia.
- **Adding attic and crawlspace insulation.** Reducing heat transfer through the attic and crawlspace decreases energy consumption substantially. Additionally, the installation is commonly simple and causes minimal disturbance to historic materials.
- **Installing storm windows and doors.** Since historic windows and doors cannot be replaced, the addition of tight-fitting storm windows can enhance the thermal performance of the existing openings without causing the loss of historic fabric.

2.4. Environmental monitoring

To assess the current environmental conditions in the house, a series of 13 indoor and 2 outdoor data loggers were strategically placed throughout the building, as shown in Figure 1. These devices monitored temperature (°F) and relative humidity (%) conditions during the cooling season from the 1st of May to the 30th of September of 2022. The monitoring acquisition is logged at 15 min intervals and averaged hourly to detect any radical changes during each day of the testing period. Average air temperature and relative humidity values for indoor and outdoor conditions of the Kelso house for the period of study are represented in Figure 2. These values reveal that the average indoor air temperature is higher than the outdoor air temperature throughout the entire period. This can be explained by the high external infiltration, the absence of any mechanical air conditioning on the inside, and the lack of any type of ventilation, which encourages the hot air to enter and get trapped in the building thus increasing the temperature. Nevertheless, the average indoor relative humidity remains lower than the outdoor relative humidity.

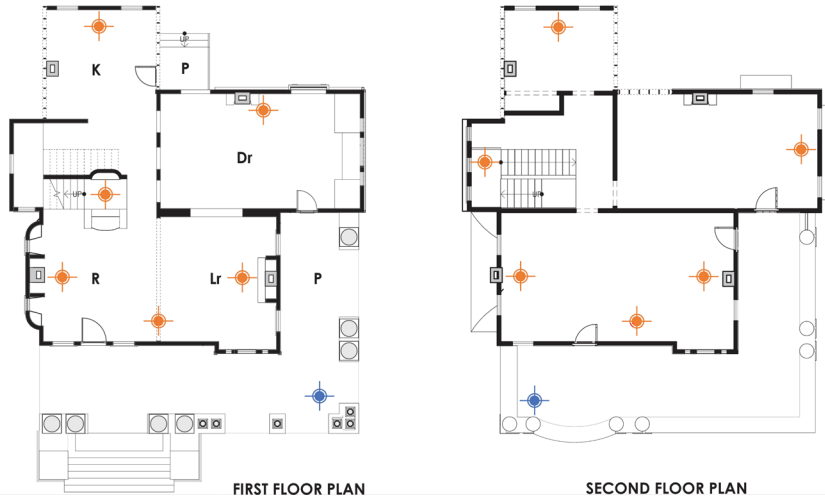

Figure 1: Placement of the data loggers on the first floor (left) and second floor (right). Indoor loggers are represented in orange and outdoor loggers in blue. One more logger is placed on the attic floor. Source: Drawings: (UTSA School of Architecture 2019) and edited by (Authors 2022)

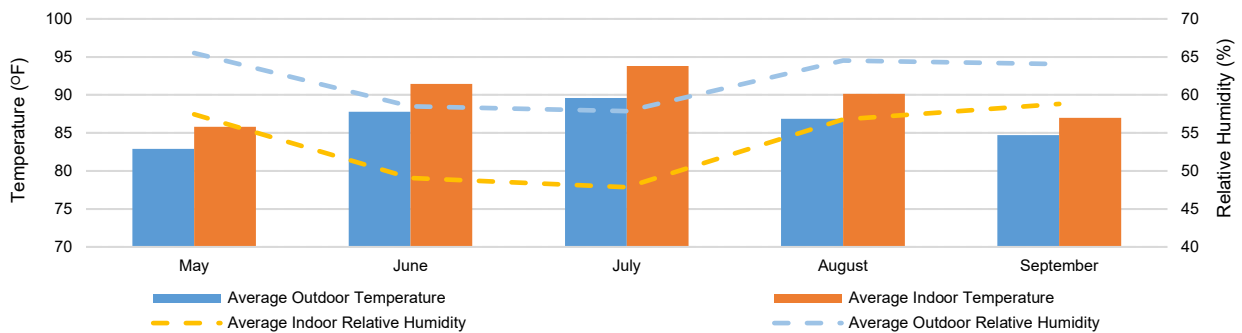

Figure 2: Indoor and outdoor average temperature and relative humidity for the period of study. Source: (Authors 2022)

2.5. Building energy modeling

A detailed energy model is developed for the Kelso house using DesignBuilder (Figure 3). To validate the predictions of the model, mean bias error (NMBE) and coefficient of variation of the root mean square error, CV(RMSE), the two primary uncertainty indices recommended by ASHRAE Guideline 14 (2014), are used. ASHRAE defines the limit for NMBE and CV(RMSE) not to exceed $\pm 10\%$ and 30% respectively, for hourly calibration (Pachano and Bandera 2021). July 15th and August 19th were chosen as two representative summer days to validate the model. The analysis exhibited NMBE and CV(RMSE) values of 0.9% and 11.3% for July 15th, 2022, and -0.4% and 2.5% for August 19th, 2022 thus meeting the guideline’s requirements for validating the model’s predictions. Figure 4 shows the results of the comparison between the measured and simulated indoor temperatures for the two days.

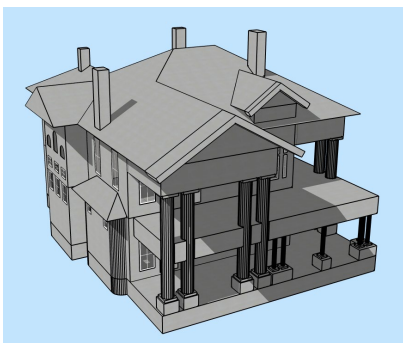

Figure 3: 3D rendering of the building generated in DesignBuilder. Source: (Authors 2022)

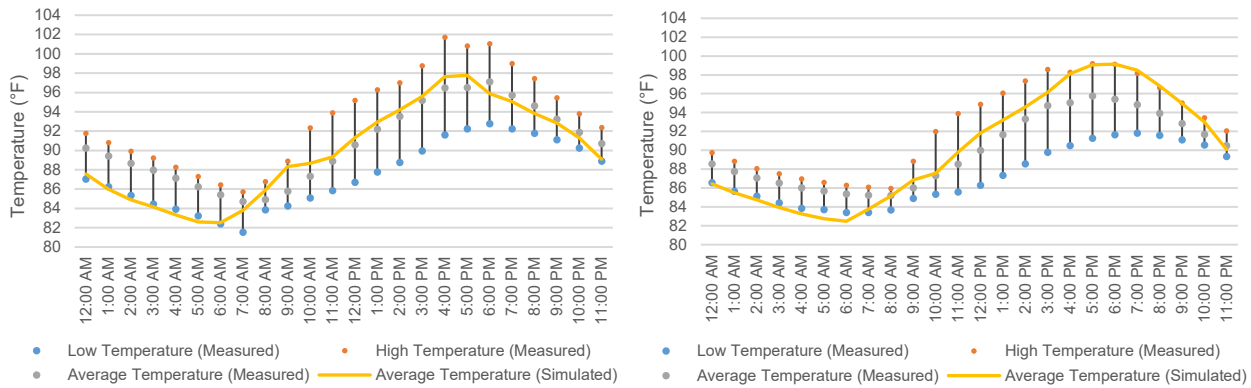

Figure 4: Comparison of hourly indoor temperatures (°F) measured and simulated in DesignBuilder on two representative summer days in San Antonio, TX: July 15th, 2022 (left), and August 19th, 2022 (right). Source: (Authors 2022)

3.0 RESULTS OF THE BUILDING ENERGY MODELING

First, the energy performance of the Kelso house as it functioned historically was estimated as a baseline. Then, the building energy retrofit package selected was applied in two scenarios:

Scenario A: It entails the improvement of the building’s energy performance without changing its residential function. The intent behind considering this scenario was to evaluate the energy savings yielded by the suggested upgrades, without any additional parameters.

Scenario B: This scenario involves the energy upgrade along with the adaptation of the building’s function to office space, as planned by the PoP foundation.

3.1. Annual energy end use for the baseline model

For the baseline model, the building was considered in its historic condition. The historical information about the house including the occupancy and the materials used for the walls, roof, and windows, was acquired from Ahlquist et al. (2021) and on-site surveys. Myers (1982) was referenced to predict the U-value of the historic windows. The characteristics of the baseline model are summarized in Table 1.

Table 1: Characteristics of the baseline building energy model. Source: (Authors 2022)

Characteristics	Description (Baseline Model)
Exterior walls	Wood frame construction with wood shingle cladding. U-value = 0.235 Btu/h.ft ² F
Roof	Pitched roof clad with wood shingles. U-value = 0.170 Btu/h.ft ² F
Floor	Wood joists and hardwood. U-value = 0.366 Btu/h.ft ² F
Windows	Single-glazed wooden windows. U-value = 0.93 Btu/h.ft ² F
Internal gains	Occupancy: 5 people Lighting: Incandescent. Normalized power density = 0.28 W/ft ² .fc
Infiltration	7 ACH
HVAC system	No HVAC system. Natural ventilation considered

3.2. Energy refurbishment

For scenario A, the authors assumed that the floor plan of the building remained unchanged, following the recommendations of Hensley and Aguilar (2011). The authors also supposed that the attic floor remained unoccupied and unconditioned. As for scenario B, since no architectural drawings had been produced for the rehabilitation project, it was presumed that the floor plan of the building would remain unchanged even with the change of use. The attic in this case was transformed into an office space to maximize the use of the interior space. The characteristics of both scenarios were acquired from U.S. Department of Energy (2022); ASHRAE Guideline 34 (2019); Hensley and Aguilar (2011); Myers (1982); and Hanam et al. (2011). The characteristics are summarized in Table 2.

Table 2: Characteristics of scenario A and scenario B. Source: (Authors 2022)

Characteristics	Description (Scenario A)	Description (Scenario B)
Exterior walls	Wood frame construction with wood shingle cladding and R-19 glass fiber batt insulation. U-value = 0.047 Btu/h.ft ² F	Wood frame construction with wood shingle cladding and R-19 fiberglass batt insulation. U-value = 0.047 Btu/h.ft ² F

<i>Roof</i>	Pitched roof clad with composite asphalt shingles. U-value = 0.160 Btu/h.ft ² .F. Attic R-38 glass fiber batt insulation	Pitched roof clad with composite asphalt shingles and R-38 glass fiber batt insulation. U-value = 0.024 Btu/h.ft ² .F
<i>Floor</i>	Wood joists and hardwood with insulation of crawlspace with rigid foam. U-value = 0.045 Btu/h.ft ² .F	Wood joists and hardwood with insulation of crawlspace with rigid foam. U-value = 0.045 Btu/h.ft ² .F
<i>Windows</i>	Single glazed wooden window with the addition of storm window. U-value = 0.46 Btu/h.ft ² .F	Single glazed wooden window with the addition of storm window. U-value = 0.46 Btu/h.ft ² .F
<i>Internal gains</i>	Occupancy: 5 people Lighting: LED with normalized power density = 0.025 W/ft ² .fc	Occupancy: 10 people Lighting: LED with normalized power density = 0.025 W/ft ² .fc (% reduction) Office equipment and computers. Radiant fraction: 0.2
<i>Infiltration</i>	3 ACH	3 ACH
<i>HVAC system</i>	Heating setpoint/setback: 68°F/60°F, Cooling setpoint/setback: 75°F/82°F	Heating setpoint/setback: 68°F/60°F, Cooling setpoint/setback: 75°F/82°F

Results of the baseline model and analyzed scenarios were compared with sensible cooling, total cooling, lighting, heat gain through external infiltration (Figure 5), air temperature, radiant temperature, and operative temperature (Figure 6) during the cooling season from May to September 2022. The main purpose was to predict the efficiency of the building energy retrofit package selected for the building and to evaluate any changes in the energy performance in case the building use was altered. In Figure 5, the results displayed a 63% and 59% decrease in sensible cooling loads for scenarios A and B respectively, compared to the baseline model. Additionally, total cooling loads decreased by 64% and 61% respectively. Even though both scenarios yielded great savings, the function change led to fewer savings overall (scenario B), most likely due to the increase in internal gains since the occupancy was higher and office equipment was added. There is also a 91% and 65% decrease in energy consumption associated with lighting in both scenarios respectively. The high savings were due to the lighting upgrade in the two cases; however, since the change of function entailed the use of the attic space as well as a different schedule and occupancy, the savings in scenario B were naturally lower than in Scenario A. Additionally, the retrofit resulted in a 67% and 80% decrease in heat gain through external infiltration respectively. The high percentage indicates that the historic wood-frame envelope is extremely leaky. Also, relocating the roof insulation in Scenario B (under the roofline) resulted in 13% less external infiltration than in Scenario A (attic). Moreover, Figure 6 shows a large decrease in temperature in both rehabilitation scenarios. Air temperature was reduced by 5°F in both Scenarios A and B, radiant temperature by 6°F in Scenario A and 5°F in Scenario B, and operative temperature by 6°F in Scenario A and 5°F in Scenario B. These results prove the efficiency of the considered energy retrofit package.

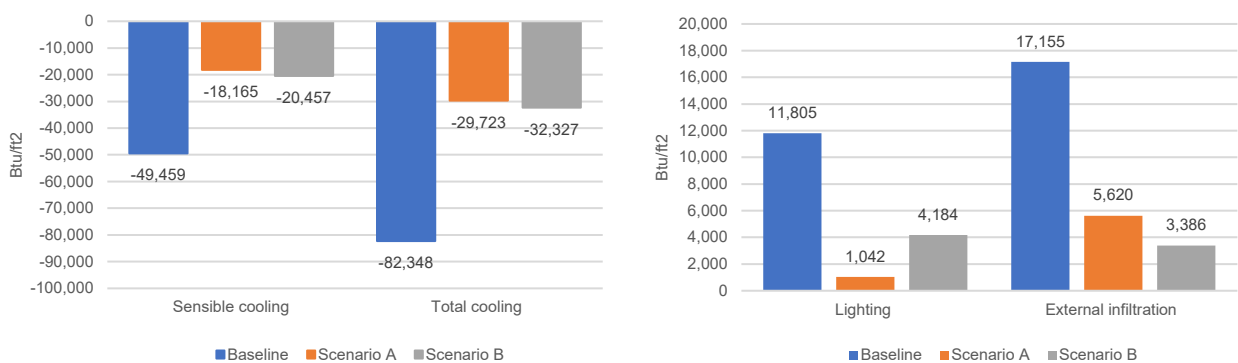

Figure 5: Comparison of the simulation results for sensible cooling, total cooling, lighting, and heat gain through external infiltration for the baseline model (historic), scenario A, and scenario B. Source: (Authors 2022)

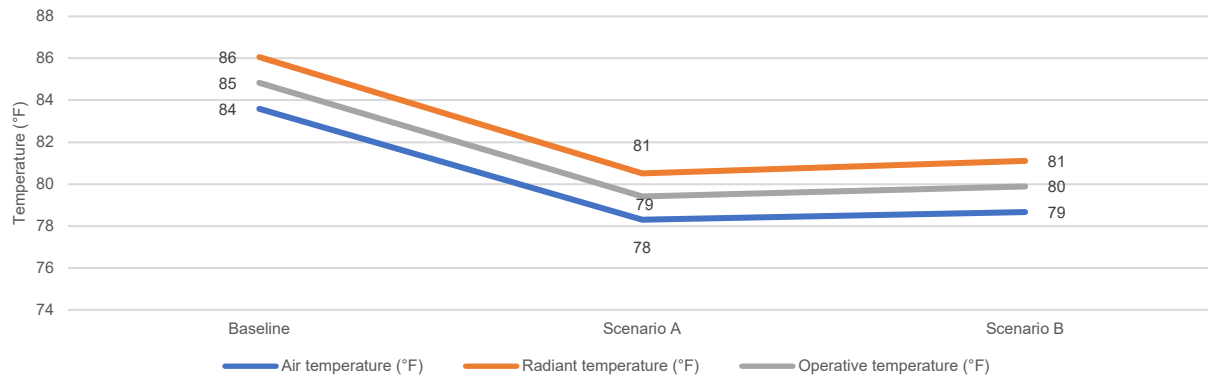

Figure 6: Comparison of the simulation results for air temperature, radiant temperature, and operative temperature for the baseline model (historic), scenario A, and scenario B. Source: (Authors 2022)

CONCLUSION

Energy retrofits of historic buildings have the potential to reduce their energy consumption and extend their life. This research presented a holistic approach to the rehabilitation of heritage structures that balances the goals of energy efficiency with those of preservation, particularly in a hot and humid climate. A historic residential wood-frame building in San Antonio, Texas was proposed as a case study. A set of building energy retrofit measures was suggested based on the recommendations of the National Park Service on improving the energy performance of historic buildings, in addition to a thorough analysis of the existing structure. Heritage values were assessed to highlight the valuable elements and materials that require conservation, and the inherent energy features of the building were identified to ensure that they function effectively together with new energy efficiency measures. The study implemented a calibrated building energy model, performing field monitoring of indoor and outdoor environmental conditions over a 5-month duration (cooling season). The model is used to predict the enhancements in energy performance in the case where the building is rehabilitated without changing its original residential function, and in that where it is rehabilitated and adapted to an office space. The building was considered in its historic state as a baseline, and the two scenarios were compared to the baseline and each other.

The simulations showed that the implementation of the selected energy retrofit measures resulted in very high savings in cooling loads, as well as in lighting and external infiltration. The savings in cooling loads were slightly lower when the function of the building was changed to an office. Additionally, the insulation of the roof resulted in a considerable decrease in heat gains through external infiltration, compared to the insulation of the attic. Indoor temperatures were also reduced significantly in both scenarios, verifying the efficiency of the chosen energy retrofit package. It can be concluded that energy retrofits in hot and humid climates, specifically in wood-frame historic buildings, are very successful and can be implemented with careful consideration of both the heritage values and the inherent energy concept of the building. The change in the building's use has an impact on the percentage of reduction in energy consumption but still yields great savings when compared to the historic state. The methodology of this research can be replicable and the findings adaptable to similar historic buildings in hot and humid climates worldwide.

ACKNOWLEDGEMENTS

This research would not have been possible without the cooperation of the Power of Preservation (PoP) Foundation. This research has been supported by Drexel Building Performance Laboratory.

REFERENCES

- Ahlquist, T., Burt, S., Ford, M., Hernández, D., Maccora, L. and Patrick, S. 2021. *Kelso House Materials Analysis Summary Report*.
- ASHRAE. 2014. *ASHRAE Guideline 14-2014: Measurement of Energy, Demand, and Water Savings*.
- ASHRAE. 2019. *ASHRAE Guideline 34-2019: Energy Guideline for Historic Buildings*.
- ASHRAE. 2022. *ASHRAE Terminology*. <https://terminology.ashrae.org/>.
- Australia ICOMOS. 2013. *The Burra Charter: The Australia ICOMOS Charter for Places of Cultural Significance*.
- Cristofari, C., Norvaišiene, R., Canaletti, J. L. and Notton, G. 2015. *Innovative Alternative Solar Thermal Solutions for Housing in Conservation-Area Sites Listed as National Heritage Assets*. *Energy and Buildings* 89 (February): 123–31. <https://doi.org/10.1016/j.enbuild.2014.12.038>.
- Everett, D.E. 1999. *San Antonio's Monte Vista: Architecture and Society in a Gilded Age, 1890-1930*. San Antonio, TX: Maverick Pub. Co.
- Bay, E., Martinez-Molina, A. and Dupont, W.A. 2022. *Assessment of natural ventilation strategies in historical buildings in a hot and humid climate using energy and CFD simulations*, *Journal of Building Engineering*, Volume 51, 104287, ISSN 2352-7102, <https://doi.org/10.1016/j.jobbe.2022.104287>.

- Franzen, C. 2015. *Building Inherent Historic Energy Concept and Energy Management*. In *Energy Efficiency Solutions for Historic Buildings*, 67–68. Berlin, München, Boston: Birkhäuser. doi:<https://doi.org/10.1515/9783038216506>.
- Hanam, B., Finch, G. and Hepting, C. 2011. *Meter calibrated energy simulation of high rise residential buildings: lessons learned*. 13th Canadian Conference on Building Science and Technology.
- Hensley, J.E. and Aguilar, A. 2011. *Preservation Brief 3: Improving the Energy Efficiency in Historic Buildings*. Washington DC. <http://www.nps.gov/history/hps/tps/briefs/brief03.htm>.
- Huddleston, S. 2022. *Long-Neglected 1906 Kelso House in Monte Vista Has Beautiful New Exterior — More Work Is Needed*. San Antonio Express-News. <https://www.expressnews.com/news/local/article/1906-Kelso-House-in-Monte-Vista-restoration-work-17017952.php>.
- ICOMOS. 1964. *International Charter for the Conservation and Restoration of Monuments and Sites (The Venice Charter)*.
- ICOMOS Canada. 1983. *Appleton Charter for the Protection and Enhancement of the Built Environment*.
- IPCC. 2014. *Climate Change 2014: Mitigation of Climate Change. Contribution of Working Group III to the Fifth Assessment Report of the Intergovernmental Panel on Climate Change*. New York: Cambridge University Press.
- Kottek, M., Grieser, J., Beck, C., Rudolf, B. and Rubel, F. 2006. *World Map of the Köppen-Geiger Climate Classification Updated*. *Meteorologische Zeitschrift*. 15 (3): 259–63. <https://doi.org/10.1127/0941-2948/2006/0130>.
- Lidelöw, S., Örn, T., Luciani, A. and Rizzo, A. 2019. *Energy-Efficiency Measures for Heritage Buildings: A Literature Review*. *Sustainable Cities and Society*. Elsevier Ltd. <https://doi.org/10.1016/j.scs.2018.09.029>.
- Martinez-Molina, A. and Alamaniotis, M. 2020. *Enhancing Historic Building Performance with the Use of Fuzzy Inference System to Control the Electric Cooling System*. *Sustainability* 12, no. 14: 5848. <https://doi.org/10.3390/su12145848>.
- Myers, J.H. 1982. *Preservation Brief 9: The Repair of Historic Wooden Windows*. Washington DC.
- Nelson, L. H. 1988. *Preservation Brief 17: Architectural Character: Identifying the Visual Aspects of Historic Buildings as an Aid to Preserving Their Character*. Washington DC.
- Pachano, J.E. and Bandera, C.F. 2021. *Multi-Step Building Energy Model Calibration Process Based on Measured Data*. *Energy and Buildings* 252 (December). <https://doi.org/10.1016/j.enbuild.2021.111380>.
- Polo López, C. S. and Frontini, F. 2014. *Energy Efficiency and Renewable Solar Energy Integration in Heritage Historic Buildings*. *Energy Procedia*, 48:1493–1502. Elsevier Ltd. <https://doi.org/10.1016/j.egypro.2014.02.169>.
- Power of Preservation Foundation. 2022. *Kelso House Learning Lab*. <https://powerofpreservation.org/kelso-house>.
- U.S. Department of Energy. 2022. *Recommended Home Insulation R-Values*. https://www.energystar.gov/campaign/seal_insulate/identify_problems_you_want_fix/diy_checks_inspections/insulation_r_values.
- U.S. Department of Commerce. 2022. *National Weather Service*. <https://www.weather.gov/wrh/Climate?wfo=ewx>.
- U.S. Department of the Interior National Park Service. 1995. *The Secretary of the Interior's Standards for the Treatment of Historic Properties with Guidelines for Preserving, Rehabilitating, Restoring & Reconstructing Historic Buildings*. Washington DC.
- U.S. Department of the Interior National Park Service. 1997. *The Secretary of the Interior's Standards for Rehabilitation & Illustrated Guidelines on Sustainability for Rehabilitating Historic Buildings*. Washington, D.C.
- Webb, A. L. 2017. *Energy Retrofits in Historic and Traditional Buildings: A Review of Problems and Methods*. *Renewable and Sustainable Energy Reviews*. Elsevier Ltd. <https://doi.org/10.1016/j.rser.2017.01.145>.

Low Cost & Low Tech: Democratizing Building Science Research through Bottom-Up Design

Elizabeth L. McCormick^{1,2}, Lochana Desphande¹

¹University of North Carolina at Charlotte, Charlotte, NC

²North Carolina State University, Raleigh, NC

ABSTRACT: Provoked by rapidly increasing carbon emissions from anthropogenic activity, scientists believe that the planet can no longer sustain global consumption patterns, particularly in regard to fossil fuel consumption. To meet environmental targets, we will need to achieve zero emissions between 2030 and 2050, which will require a drastic departure from current practices in the building and construction industry, as buildings are a primary contributor of carbon emissions and a major consumer of natural resources. However, the default is often to rely on advancements in energetic systems or mechanically-complex technologies in high-performance buildings, a focus area that is often regarded as the opaque domain of the engineer and material scientist. Instead, many innovators are pushing for a bottom-up approach that allows end users to become designers, recognizing different forms of knowledge and democratize the innovation process. The maker movement, for example, has been compared with a new Industrial Revolution for the ability of bottom-up design to productively disrupt mainstream innovation systems dominated by disciplinary experts and inaugurate a new era of collaborative design and sustainable consumption.

When the user has control of the design/innovation process, it opens up a myriad of new possibilities rich with lived experience. Here, *democratized design* is explored as a path to a more sustainable building typology in rapidly urbanizing regions and proposes an approach to innovation in sustainable technologies through accessible physical testing methods. This paper describes a series of simple and low-cost testing devices that were used to explore basic principles of heat transfer, moisture flow and energy storage. Each device was constructed for under \$50 with accessible custom sensors and data collection methods. With these tools, unconventional innovators have the means to make informed, climate-specific design decisions for a post-carbon economy and the new vernacular that it will entail.

KEYWORDS: democratized innovation, bottom-up innovation, environmental design, low-carbon

INTRODUCTION

Within the span of only 100 years, the Earth's population grew exponentially from 1.5 billion people at the beginning of the 20th century to 6 billion in 2009 and is expected to grow to nearly 10 billion by 2050 (Gielen et al. 2016) with the most significant growth rates occurring in developing nations in Asia and Africa (Hoekstra and Molnar 2010). As the Earth's population swells, people are also moving into cities at unprecedented rates. As of 2007, more people were living in cities than rural areas for the first time in history. With land at a premium, global building floor area is expected to double by 2060 (Architecture 2030). Despite global efforts to mitigate climate change, rapid urbanization with air conditioning as the primary thermal strategy will lead to deleterious environmental challenges.

With the technological advancement in the last few decades, building technologies have changed and improved rapidly. Intelligent/smart controls in energy storage, energy efficiency, and energy conversion areas allow buildings to generate more energy than they consume annually (Aldrich 2003; Coley and Schukat 2002). The boom in tech industries led to implementing high-tech solutions to address energy and carbon emission problems caused by the built environment. However, the dependency on technology has isolated the common person from contributing to the mitigation of these problems. High-tech building and energy models can provide greater comfort, control, and efficiency (Huang et al. 2016), however they are programmed to reduce the burden of inhabitants by putting technology at the center. Low-tech approaches, on the other hand, propose a more conservative use of resources with the potential for lower environmental and social impacts. Many innovators are pushing for a bottom-up approach that allows end users to become designers, recognizing different forms of knowledge to democratize the innovation process. This paper describes a building technology elective course offered at the UNC Charlotte School of Architecture, which asks students to design and construct simple and low-cost testing devices to explore basic principles of building science. Each device was constructed for under \$50 with accessible custom sensors and data collection methods. This interdisciplinary course sought to bridge the gap between design and the hard sciences. Students explored ways to understand, visualize and *communicate* basic thermodynamic phenomena in physical and tangible ways. With these tools, unconventional innovators have the means to make informed, climate-specific design decisions for a post-carbon economy and the new vernacular that it will entail.

1.0 BACKGROUND

In both industry and academia, there is a growing emphasis on energy efficiency as the primary strategy for mitigating the environmental consequences of buildings. While this approach helps to reduce the intensity of the impact, it does not *challenge* the way that humans occupy the planet, nor does it challenge our authoritarian, one-sided relationship with nature. This phenomenon has occurred with countless technological advancements throughout history, most recently including renewable energies, energy-efficient light bulbs and electric vehicles – none of which actually question the role that these technologies play within buildings and cities. Ultimately, the technology-centric approach to sustainable development as the dominant model of innovation in industrialized countries preserves the existing power structure of political and professional elites (Brand and Karvonen 2007). This is problematic for several reasons.

“The professional representatives of science, technology, and public policy had done very little to prevent or stop that war or to heal the rifts it produced. **On the contrary, professionals seemed to have a vested interest in prolonging the conflict.** A series of announced national crises – the deteriorating cities, poverty, the pollution of the environment, the shortage of energy – seemed to have roots in the very practices of science, technology, and public policy that were being called upon to alleviate them” (Schon 1991, 9)

As buildings become more technologically complex, performance decisions are often relegated to the opaque domain of engineers and material scientists, further perpetuating disciplinary silos and sociotechnical divides. “The dominant role of technology in modern societies requires the public to rely on individuals with specialized knowledge to invent, design, manufacture and maintain increasingly complex artifacts and networks” (Brand and Karvonen 2007). Developing regions in particular are beholden to the professional elite from Western countries. Similarly, corporate approaches to climate issues demand higher economic supply to support the high-end technological innovations designed to address these issues. High-tech design solutions also call for higher operational and maintenance costs. Instead, a bottom-up approach can empower local decision making, community participation, and grassroots movements. Giving power to the hands of the people and including them in the design and decision-making process can instill a greater sense of confidence and responsibility among users, *democratizing* the innovation process. Taking up responsibilities also has a behavioral consequence on the public that they are more likely to engage them for a long term (Seyfang 2010). Economic costs decrease as man power cuts down and a low-tech approach emphasizes more on human-centered perspective.

Grassroots engagement to lower carbon emissions and address climate change can resonate more with the democratic governance rather than a forced governance. However, it has some downsides in terms of its effectiveness considering the scale and urgency of the climate crisis, as it is difficult to implement behavioral change at the society engagement level. Moreover, many aspects, including public knowledge and awareness, restrict participatory action and acceptance to new innovations. While voluntary actions may not produce the fastest results, they would likely provide long term consequences. A more efficacious approach would be one that is a cohesion between the top-down and bottom-up approaches where government could necessarily be involved with policy making and people could take up voluntary actions. Communication and trust play an important role in this bridged approach.

At an institutional level, educating students about the environment and severity of climate change must also be supplemented by empowering them *to act* upon the climate issues in order to initiate grassroots movements that produce systemic changes. According to Education for sustainable development (ESD) the main aim of climate change education (CCE) is to engage different stakeholders in educating and building a knowledgeable and climate aware society in which local communities show active participation upon recommendations. Fadeeva et al. (2014) recognizes this specifically in Higher education institutions (HEC's) and talks about the need to move beyond the cycle of top-down versus bottom-up participation and embrace a democratic approach and participatory mindset in which everyone is involved and held responsible. Varga et al. (2007) argues how traditional western education is no longer a top-down model of knowledge transfer but involves student participation and educating for climate change can be less challenging in a top-down method.

Fraser et al. (2006) and Wi (2019) support a bottom-up approach in education as it promotes creativity and ownership of joint involvement and action between students, faculty and staff, allowing for a leveraging of specialized knowledge and experiences contributed by them individually. However, Wi explains that the top-down approaches has its own advantages like efficiency in execution by easier mobility of resources and spreading awareness to a larger target audience which saves time. Finally, he argues that bridging the gap between top-down and bottom-up approaches is the successful strategy that would provide optimum results for Climate Change Education. Van der Linden et al. (2015) posits that the Academic institutions portray developmental inertia because the professoriate remains in familiar and comfortable patterns. Being in a comfort space due to set conditions and resisting change is innate human nature which keeps academy deprived of the passion and persistence required for change. They suggests that a more bilateral relationship between faculty and students might produce different outcomes. In response, this paper discusses the results of an elective course at the University of North Carolina at Charlotte School of Architecture that attempts to unravel the notion that high-performance buildings are expensive and mechanically complex, engaging student designers in bottom-up innovation practices. While it is important to understand these issues at a greater social level, “High-Performance, Low-Tech” is an interdisciplinary course that works with students to instill these ideas through a

cohesive pedagogy. The course explores the vernacular strategies associated with rapidly urbanizing tropical regions in order to translate their character, physical qualities and thermal capabilities to a commercial scale, reducing the reliance on energy-intensive mechanical systems while developing a new, climate and culture-specific urban identity.

2.0 METHOD

The integration of digital simulation and energy modeling instruments in education can empower innovation, yet these increasingly user-friendly tools enable an already tech-savvy generation to lean on digital outputs without a solid understanding of the physical metrics. Additionally, advanced computational methods can be inaccessible to those not versed in the software or those without access to computers. In the spirit of affordable, low-tech and climate-specific enclosure systems, this class employed accessible physical testing methods to make building technology innovation more accessible and democratize the innovation process. Additionally, this course mixed historical referencing with physical experimentation to teach building performance metrics and explore the ways that the building systems could engage and empower the occupant. The course is open to both undergraduate and graduate students and as attracted students from civil engineering and environmental studies. This section describes the course structure.

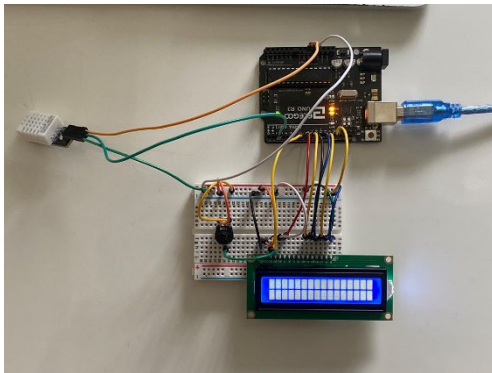

Figure 1: Electronics Setup, photo by author.

2.1 Research & Translation

Students chose a region identified by the United Nations as rapidly developing, mentioned above. They studied both traditional and modern building styles to establish a vernacular typology for that particular region. From there, they studied the thermodynamic principles that apply to the identified systems within the social and cultural context of their chosen region. Through lectures and hands-on demonstrations, students explored a number of basic topics (convection, conduction and radiation; psychrometrics) as well as some more advanced and emerging ideas (phase change materials, thermal bridging, etc.). Proper research methods and scientific writing were also discussed as students developed their research question. After a research methods seminar presented by library staff, students conducted a thorough literature review in order to situate their work within the greater dialogue of their particular topic.

2.2 Fabrication & Experimentation

Within early level architectural design education, work flows tend toward digital means and media-driven, production-based representation. Instead, an integral part of this course was to develop low-tech experimental devices and procedures that examine the physical impacts of their strategies. This pivotal step encouraged students to develop a fluency in thermodynamic principles while acknowledging the cultural history and implications of a particular phenomenon. Research shows that there is a strong correlation between 'hands-on' projects and 'deep learning'. Specifically, this course builds on the successes learned from the 'design/build' structure – a pedagogical approach that exposes students to the technical and material implications of their designs from conception to construction. This course used hands-on learning with low-tech, low-cost experimental procedures to improve students' understanding of basic principles and technologies in buildings.

2.3 Communication & Representation

The goal of this phase was to teach students to communicate complex principles with simple and graphically tangible means. Students explored data management software such as Microsoft Excel and Tableau, as well as Adobe Illustrator, Premiere and AfterEffects for visualization. Software training was also supplemented with lectures and workshops that address the design principles behind graphical excellence and data communication.

3.0 RESULTS

3.1 Cooler Windcatcher by Sandhya Mahendiran (MARCH '23)

Sandhya sought to understand the cooling potential of vernacular courtyards in coastal cities of India. Locally called *muttram*, these courtyards are at the center of social space in many dwellings. Apart from being a multi-purpose space,

it is one of the most important strategies used to mitigate the hot climate in the region. The courtyard works using the principle that is universally known as stack effect. When coupled with a windcatcher, these elements results in the ultimate passive solution to reduce heat. To explore this phenomenon, Sandhya developed a small-scale testing apparatus to explore courtyard geometries (shown in Figure 2) in a simple and economic way using readily available materials to reinforce its importance and propose alternative solutions for passive cooling. The aim of the study was to understand the concept and propose alternative uses to the iconic windcatcher used in these houses so that it would become a common aspect of every house in today's coastal cities and reduce their reliance on air-conditioning for living comfortably.

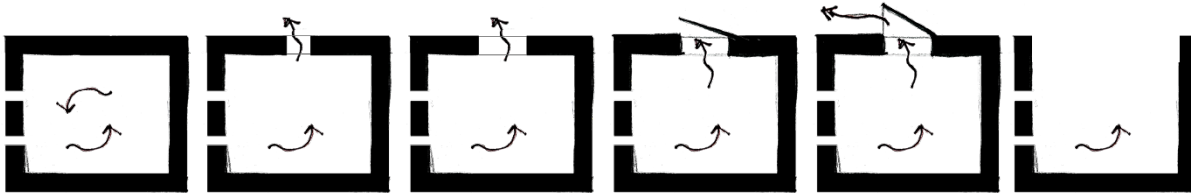

Figure 2: Roof Geometry Options, image by Sandhya Mahendiran



Figure 3: Apparatus Setup, photos by Sandhya Mahendiran

The experiment involved understanding the capacity of the windcatcher in heat reduction within the interior of a room. Therefore, similar conditions were simulated using a scaled model of a courtyarded room, shown in Figure 3. Firstly, the test box was preconditioned for 40 minutes by placing the heat source (light bulb) at an approximate distance of 1' from the box. During the preconditioning process, the electronic configuration including the LCD monitor that displayed data and a computer were setup to be ready for data collection. The heat sensor was placed inside the box at a designated spot, and recorded at an interval of 5 minutes. The closed box and open box were considered the control setting for the minimum and maximum temperature range. The procedure was repeated several times until consistent temperature data was recorded.

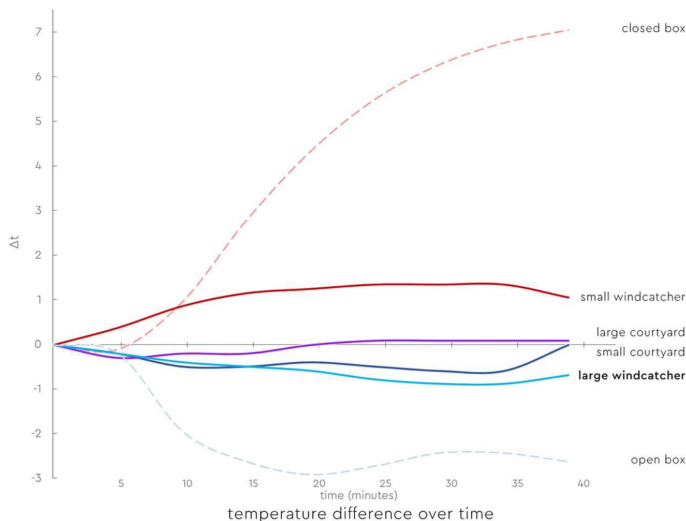

Figure 4: Experiment Results, by Sandhya Mahendiran

The temperature difference from the beginning of each of the configured experiments (small courtyard, large courtyard, small windcatcher, large windcatcher) and the control settings (closed box, open box) were documented. The ambient temperature was maintained at 31°C with the heat lamp. The result of the experiment is shown in Figure 4 to demonstrate the heat reduction capacities of each condition. After consolidating the data, Sandhya discovered that the condition with the large windcatcher had the best heat reduction and the small windcatcher had the worst heat reduction capacity. Additionally, she observed that the heat was reduced in all configurations except for the closed box, but the speed of heat reduction varied between settings. A peak cooling point was observed in each setting and the speed of heat absorption after that point is also different between the configurations.

Sandhya's experiment was successful in isolating the element of study and reducing variables that could cause noise and deviation in its results. The construction of the apparatus was simple enough for any person without a background in research or fabrication to understand, replicate and synthesize. Although producing quantifiable results, the test box could be further improved by precise dimensioning, and joining techniques of parts to avoid any heat loss. Further testing could be done by incorporating wind condition simulation and understanding the movement of heat. Also, understanding the pattern and duration of heat loss and gain between the different conditions over prolonged periods of time involving natural situations like the phenomenon of day and night and including heat sources not only outside the test box (symbolizing the sun), but also inside the box to replicate the activities conducted inside the house that produce heat like cooking, use of appliances, body heat and so on. Finally, further studies involving the understanding of proportions of size and ratios of openings to space would be helpful in determining size and potentially positioning of courtyards within the home. Furthermore, creating the enclosure using everyday building materials such as concrete or brick instead of foam (which is impractical as a building material) to create a more relatable environment which could be scaled up for real world comparison would be effective.

3.2 Passive Refrigeration by Thomas Allegretto (BA '24)

At the time of this course, Thomas was in the second year of his undergraduate education, with limited experience in either building science or fabrication. However, he was still able to complete a successful testing device. He was interested in low/no energy food storing elements in developing regions powered by evaporative cooling. In the realm of food storage, low-tech options already exist for developing regions, such as ZECC, a Zero Energy Cooling Chamber that has been tested to increase the shelf-life of vegetables by keeping them in a cool environment. Each of the four composite sides of the ZECC consisted of two inter-spaced walls and this jacketed type room has the advantage of preventing heat leakage into the storage cabin (Rayaguru et al. 2010). Water was used to cool the space which is why it's crucial to be near a source of water, as it requires water to be added 3 to 4 times a day for optimum cooling. In testing, they found "the average temperature values reduced from an ambient condition of 34 to 27 °C in summer and 21 to 17°C in winter" (Ibid). They also found the optimum water content needs to vary during the winter and summer months to create an optimum result and they were also able to study the need to change the amount of water depending on the region's climate. To capture this effect and explore this phenomenon, Thomas needed to understand the energetic components of water and heat which could work in tandem to cool the environment.

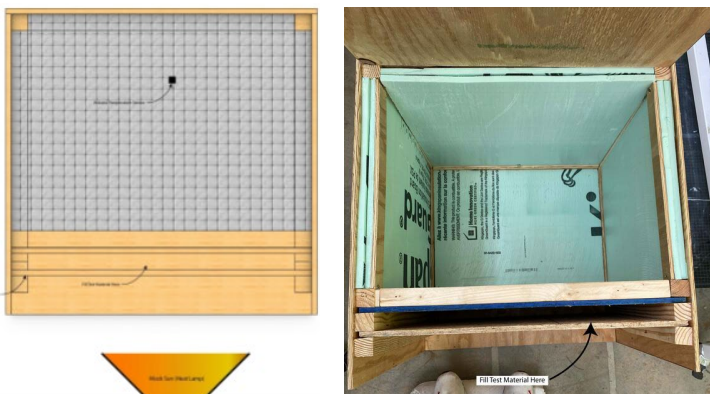

Figure 5: Testing diagram (left) and apparatus photo (right), images by Thomas Allegretto

In order to test the energy storage (and release) properties, Thomas created a chamber in which different cavity-fill materials, including sand, dirt, gravel, and air, were tested to see which promotes the best evaporative cooling. He constructed a 2' x 2' chamber with a double-layer on the front panel to fill with the various materials, shown in Figure 5. He then poured pre-conditioned, room-temperature water in the cavity-fill material and applied heat from a heat lamp. He hypothesized that sand and less permeable materials would better store water and promote the greatest decrease in temperature, which was supported by his experimental results, shown in Figure 6. The sand fill provided a maximum 3.060°F decrease in 32 minutes. The dirt fill was next with a maximum of 2.520°F in 23 minutes. The gravel fill was 1.440°F in 14 minutes and the air fill (empty chamber) only decreased 0.180°F in 8 minutes. Figure 6 shows the comparison of the four different cavity materials; air, sand, dirt, & gravel, in how their use in the test chamber testing has allowed the temperature of the testing box to decrease over time. It shows how low the temperature got for each

test material as well as how long until the temperature begins to increase. His results showed that air was the worst at cooling the box, followed by gravel then dirt. Sand had the best result with the coolest temperature over the study duration. This experiment found sand to be the best material to promote evaporative cooling in this condition.

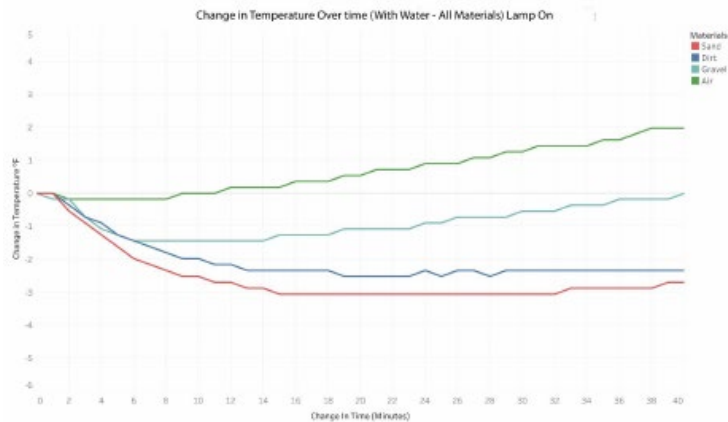

Figure 6: Experimental Results, by Thomas Allegretto

Though he was specifically looking at food preservation methods in this course, his larger goal was to develop this technology to cool larger human spaces as well. While all of his tests were conducted in a 2' x 2' chamber, he believes that it would be possible to scale up the device to test at the human/home scale, potentially with a 10' by 10' enclosure where a single wall would use 250 pounds of sand. While a heat lamp was used in his initial tests, it could be possible to use the sun as the heat source. With the combination of a rainwater collection system and the sun, Thomas believes it is possible to cool a home with evaporative cooling. The experiment shows how low tech can be a way to achieve those goals.

CONCLUSION

The goal of this course was not to develop new technologies for developing regions as the strategies explored by the students were already well documented in the literature. Instead, the goal of the course was to empower students to use low-tech strategies for passive controls instead of relying on the advanced technologies commonly taught in architectural education. Additionally, these projects serve as a model for the types of low-tech thermal testing that could be conducted by building users with wide ranges of knowledge or experience.

The academic course presented in this paper is an overly-simplified approach to the problem of techno-centric innovation and is by no means a solution. Instead, it is one small step in empowering an interdisciplinary group of students to begin to address the greater issues of the world from the bottom up. Through this type of teaching, we hope to develop a cohort of practitioners that embrace simple, low-tech, and accessible innovations, whether they come from an advanced professional or a community member with an idea. To achieve a truly sustainable world, we must embrace all forms of knowledge production, and this course is one step in that direction.

ACKNOWLEDGEMENTS

"High-Performance, Low-Tech" was a recipient of the 2021 Buell Center Course Development Prize in Architecture, Climate Change and Society. The prize, awarded by Columbia University's Temple Hoyne Buell Center for the Study of American Architecture and the Association of Collegiate Schools of Architecture (ACSA), recognizes coursework that focuses on the intersections of climate, infrastructure and architecture. Additionally, this paper uses photos and writing from UNC Charlotte students Sandhya Mahendiran and Thomas Allegretto with their permission.

REFERENCES

- Aldrich, Frances K. 2003. "Smart Homes: Past, Present and Future." In *Inside the Smart Home*, edited by Richard Harper, 17–39. London: Springer. https://doi.org/10.1007/1-85233-854-7_2.
- Anderson, Chris. 2012. *Makers: The New Industrial Revolution*. 1st ed. New York: Crown Business.
- Architecture 2030. n.d. "Why the Building Sector?" Accessed January 13, 2020. https://architecture2030.org/buildings_problem_why/.
- Brand, Ralf, and Andrew Karvonen. 2007. "The Ecosystem of Expertise: Complementary Knowledges for Sustainable Development." *Sustainability: Science, Practice and Policy* 3 (1): 21–31. <https://doi.org/10.1080/15487733.2007.11907989>.
- Coley, David A, and Stefan Schukat. 2002. "Low-Energy Design: Combining Computer-Based Optimisation and Human Judgement." *Building and Environment* 37 (12): 1241–47. [https://doi.org/10.1016/S0360-1323\(01\)00106-8](https://doi.org/10.1016/S0360-1323(01)00106-8).

- Davies, Dan. 2003. *Teaching Science, Design and Technology in the Early Years*. Early Years (London, England). London: David Fulton.
- Fadeeva, Zinaida, Laima Galkute, Clemens Mader, and Geoff Scott. 2014. "Assessment for Transformation — Higher Education Thrives in Redefining Quality Systems." In *Sustainable Development and Quality Assurance in Higher Education: Transformation of Learning and Society*, edited by Zinaida Fadeeva, Laima Galkute, Clemens Mader, and Geoff Scott, 1–22. Palgrave Studies in Global Higher Education. London: Palgrave Macmillan UK. https://doi.org/10.1057/9781137459145_1.
- Fraser, Evan D. G., Andrew J. Dougill, Warren E. Mabee, Mark Reed, and Patrick McAlpine. 2006. "Bottom up and Top down: Analysis of Participatory Processes for Sustainability Indicator Identification as a Pathway to Community Empowerment and Sustainable Environmental Management." *Journal of Environmental Management* 78 (2): 114–27. <https://doi.org/10.1016/j.jenvman.2005.04.009>.
- Gielen, Dolf, Francisco Boshell, and Deger Saygin. 2016. "Climate and Energy Challenges for Materials Science." *Nature Materials* 15 (2): 117–20. <https://doi.org/10.1038/nmat4545>.
- Hoekstra, Jonathan M, and Jennifer L Molnar. 2010. *The Atlas of Global Conservation: Changes, Challenges, and Opportunities to Make a Difference*. Berkeley: University of California Press.
- Huang, Gongqiang, Junjie Yang, and Chunjuan Wei. 2016. "Cost-Effective and Comfort-Aware Electricity Scheduling for Home Energy Management System." In *2016 IEEE International Conferences on Big Data and Cloud Computing (BDCloud), Social Computing and Networking (SocialCom), Sustainable Computing and Communications (SustainCom) (BDCloud-SocialCom-SustainCom)*, 453–60. <https://doi.org/10.1109/BDCloud-SocialCom-SustainCom.2016.73>.
- Linden, Sander van der, Edward Maibach, and Anthony Leiserowitz. 2015. "Improving Public Engagement With Climate Change: Five 'Best Practice' Insights From Psychological Science." *Perspectives on Psychological Science* 10 (6): 758–63. <https://doi.org/10.1177/1745691615598516>.
- Rayaguru, Kalpana, Md K. Khan, and N. R. Sahoo. 2010. "Water Use Optimization in Zero Energy Cool Chambers for Short Term Storage of Fruits and Vegetables in Coastal Area." *Journal of Food Science and Technology* 47 (4): 437–41. <https://doi.org/10.1007/s13197-010-0072-7>.
- Schon, Donald A. 1991. *The Reflective Practitioner: How Professionals Think in Action*. London ; New York : Routledge, 2017. <https://catalog.lib.ncsu.edu/catalog/NCSU4682382>.
- Seyfang, Gill. 2010. "Community Action for Sustainable Housing: Building a Low-Carbon Future." *Energy Policy*, Special Section: Carbon Reduction at Community Scale, 38 (12): 7624–33. <https://doi.org/10.1016/j.enpol.2009.10.027>.
- Varga, Attila, Mária Fu'z Kószó, Michela Mayer, and Willy Sleurs. 2007. "Developing Teacher Competences for Education for Sustainable Development through Reflection: The Environment and School Initiatives Approach." *Journal of Education for Teaching* 33 (2): 241–56. <https://doi.org/10.1080/02607470701259564>.
- Wi, Andy. 2019. "Citizen Participation as a Key Enabler for Successful Public Education Policies in Climate Change Mitigation in Singapore." *International Research in Geographical and Environmental Education* 28 (1): 53–69. <https://doi.org/10.1080/10382046.2018.1430789>.
- Yang, Yifan, Gary Cui, and Christopher Q. Lan. 2019. "Developments in Evaporative Cooling and Enhanced Evaporative Cooling - A Review." *Renewable and Sustainable Energy Reviews* 113 (October): 109230. <https://doi.org/10.1016/j.rser.2019.06.037>.

Making the Side-Yard House; A Passive Mass Housing Model

Craig S. Griffen¹

¹Thomas Jefferson University

ABSTRACT: The Side-Yard House is a multiyear research-design project to create a detached housing model that synergistically combines multiple benefits, typically lacking in today's housing, into a singular design that 1), incorporates passive solar-oriented, energy-efficient design, 2) is adaptable and scalable to a range of urban and suburban site conditions, 3) uses modular prefabricated construction techniques to reduce costs, 4) utilizes resilient lower embodied carbon CLT mass timber construction, and 5) is more affordable to the underserved missing-middle housing market. The key concept for all model variations involves re-proportioning the lot from a backyard model to a *side-yard* model home while maintaining lot density. This arrangement, similar to the Charleston House typology with its long gallery, provides a large side yard off the substantially glazed south facade that is focus of all occupied rooms. The design incorporates many sustainable functions such as passive solar heating, daylighting, natural shading, and PV electricity production, as well as a private, healthy outdoor space that is the focus of the house. Having previously tested the model at the macro urban planning and design scale, the latest research/design focuses inward on construction details to investigate how this house model could be built affordably and sustainably. The design follows Passive House principles, so initial construction costs are typically 5-10% higher. However, to keep this house type affordable to missing-middle housing buyers, methods of prefabricated modular construction are employed that save 10-20% over site built. The results had the goal of testing the feasibility of a *single* house type through a deeper understanding of its sustainable energy strategies, actual construction methods, and cost-saving concepts.

KEYWORDS: Passive Energy, Modular Housing, Mass Timber Construction



Figure 1: Detroit, Michigan – Existing Urban Vacant Lots vs. New Suburban Style Houses. (Google Earth 2022)

INTRODUCTION

Crisis is a word heard too often these days. Along with health, environmental, economic, political, and social crises, we also face a grave housing crisis. Yet, housing design and construction has barely responded. Approximately 98% of single-family house construction is still developer driven and located in the increasingly expanding suburbs. The vast majority of these homes are energy inefficient, unsustainable to build and operate, non-resilient to climate change. They are also unaffordable to many buyers, especially the missing-middle home buyer demographic who make a decent income, but still cannot afford skyrocketing real estate prices.¹ While major US cities have experienced increased growth for the last few decades, that trend is slowing and, in some cities, reversing as buyers are once again leaving the city looking for suburban amenities like more interior and exterior space. Data released by the U.S. Census Bureau show that some 27,000 millennials left big cities in 2018 for the suburbs to combat the ever-increasing housing costs and lack of access to family-friendly amenities.² Between 2019 and 2020, the share of millennials who live in suburbs increased by 4% and this rate accelerated during the pandemic.³ One response by developers to attract and retain city dwellers has been to build detached, single-family, suburban style homes deep within city limits. Some builders already offer suburban amenities in their new urban developments claiming, “the suburban life in the city is what we’re going for.”⁴ While these homes provide some of the suburban amenities buyers are requesting, they reduce the established density of dwelling units per acre and are extremely out of context with the urban setting. Pseudo-colonial homes with 2-car garages, large backyards and even the occasional picket fence are the antithesis of the

former worker row homes they replaced. (e.g. Figure 1) Directly transplanting suburban housing models into the city may bring in desirable suburban qualities, but it also destroys the urban contextual patterns and culture that give the

city its identity, and therefore is not an ideal strategy. Multiunit housing is often touted as the most sustainable way to dwell in the city because of the way in which it shares land, energy, and services. But annual surveys by the National Association of Realtors constantly reveal that 70% of home buyers prefer detached, or single-family, housing and there is an increased preference for walkable communities (one in five people living in a detached home would prefer to live in an attached home if it meant living in a walkable community with a shorter commute).⁵ So to attract buyers into the walkable city, it makes sense to entice them with the type of housing that they are requesting but offer a version that is suitable for the urban context. The Side-Yard House offers hybrid benefits of city living in a detached home that fits its urban context.

Any new housing typology should also address other crises, especially climate change and social/economic disparities, so the Side-Yard House was developed as a proposal for mass, detached housing that addresses multiple issues in one design. Largely through a simple reportioning of the house to lot dimensions, this new model can produce a *Passive, Adaptable, Modular, Resilient and Affordable* home that incorporates some of the best qualities of both urban and suburban environments. The common planning concept for all variations of houses involves reportioning the lot from a long rectangular backyard to a square *side-yard* model home while maintaining existing area and density. Instead of a long, thin backyard that is accessible to few, this arrangement, similar to the Charleston House typology, concentrate the land area in a sunny, large, green space along the entire south side that serves multiple functions. The long southern façade with its shaded “gallery” provides an optimal layout for several solar strategies such as passive solar heating, natural daylighting, and PV power production that, when combined with a highly insulated Passive House envelope, greatly increases energy efficiency and resiliency over standard construction. This private “Garden in the City” also provides a healthy, green environment that reduces heat island effect, increases passive cooling potential, and can serve as a protected place of refuge. (e.g. Figures 2 & 3)

1.0. BACKGROUND URBAN PLANNING RESEARCH

This paper describes the latest step in a multi-year design/research project. Past research has been conducted mainly at the urban planning scale to investigate the home design’s adaptability to a range of urban and suburban settings. A detailed description of how the typology’s different models were tested, using Detroit as a model city and an exurban Philadelphia subdivision as a typical suburban condition, can be found in previous publications, with a comprehensive summation in The Plan Journal⁶. Because it would be very difficult to understand the current research without this background, some of that earlier research is included here for reference and clarity, but this specific paper focuses on current developments conducted within the past year. These recent results, as described below, had the goal of testing the feasibility of a *single* house type through a deeper understanding of its sustainable energy strategies, actual construction methods, and cost-saving concepts.

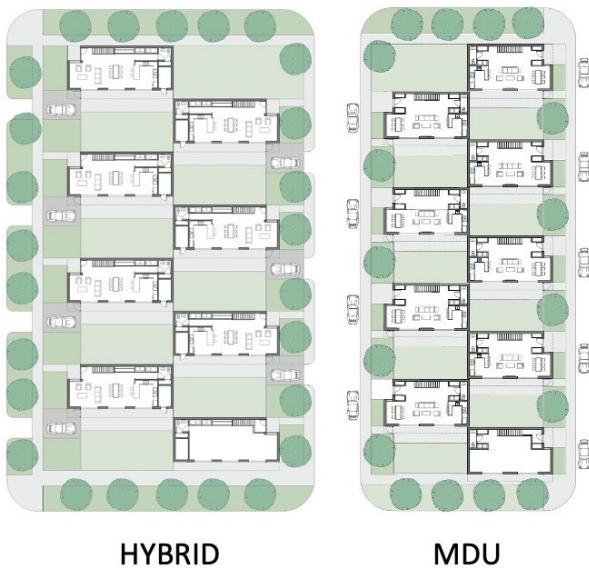

Figure 2: Side Yard House Urban. Plan. (Author 2022).

Figure 3. Exterior Rendering. (Marzea Akter)

2.0. PASSIVE ENERGY STRATEGIES

Current detached developer housing typically meets only the minimum energy efficiency construction standards as defined by local energy codes. However, with a climate crisis upon us, any new housing model should strive to be as carbon neutral as is financially possible. The Side-Yard House would incorporate several passive energy saving strategies to reduce carbon load. First, each home would follow Passive House (Passivhaus) principles to produce an efficient, exterior envelope to the greatest extent feasible by specific budget. Each house incorporates heavily insulated walls and roof with an average R-value of R-50, a tightly sealed envelope, energy efficient windows, and a heat exchanger in attic. Other passive energy saving strategies beyond the efficient envelope are listed below:

Solar Heat Gain – A passive solar home requires abundant glazing which due to the low R-value of window glass can lose significant heat at night and on cloudy days. The additional glass and thermal mass required also add to construction costs, so this project is designed as a Sun Tempered Home which requires a smaller glass to wall area ratio.⁷ This approach uses a similar amount of glazing as a typical home but relocates the majority of windows to the south wall and provides minimal windows on the north, east and west. Because no additional window area is added, the fenestrations costs are similar to a standard home. Sun tempered homes provide less heat than passive solar but the well-insulated envelope requires less. Wood homes have little thermal mass for heat storage so those without a basement use a thickened and insulated concrete floor slab. A concrete topping can be added to all CLT floor slabs to retain heat but must be weighed against the increased amount of embodied carbon.

Sun Shading – The continuous gallery and roof overhangs along the south wall, similar those found in the Charleston House typology, are dimensioned to provide horizontal shading from the high angled summer sun while at the same time allowing in the low angled winter sun. The end wall fins on the second floor also shade from low morning and evening sun along with shielding views of the bedrooms for greater privacy. (e.g. Figure 4)

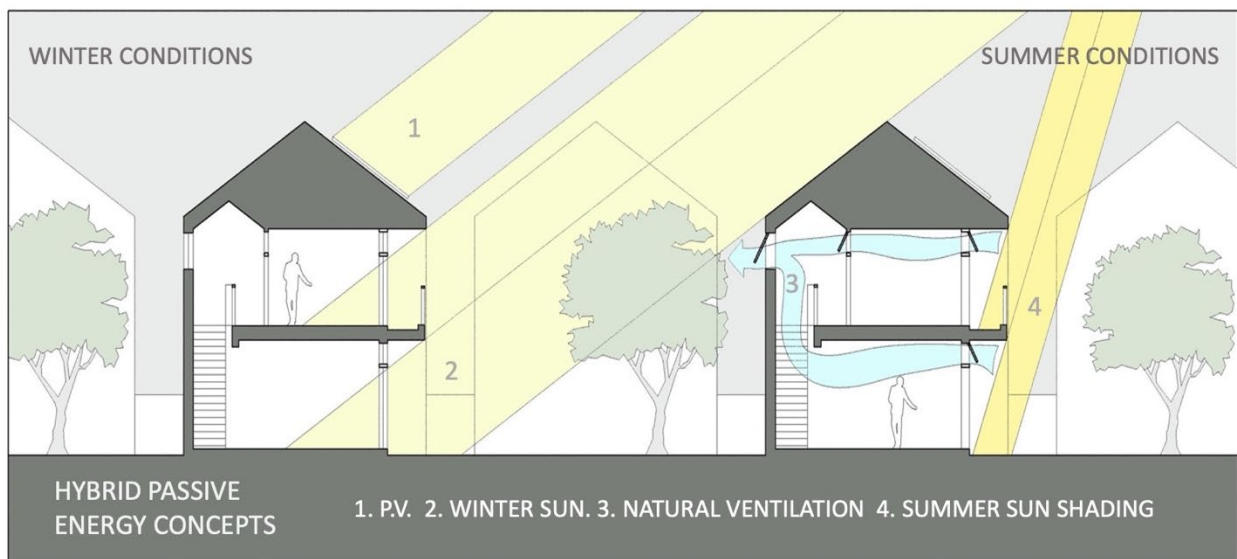

Figure 4. Passive Energy Strategies Sections. (Author 2022)

Natural Cooling - The long, thin and open house promotes natural cross ventilation cooling across its short dimension. Air is drawn up the stair hall and out through the north clerestories. Awning windows are used to allow for the sashes to remain open even when raining. The minimally fenestrated north side deflects winter wind around the building with less infiltration around the window frames. These strategies, along with the sun shading, help reduce mechanical air conditioning unit size, usage and operational costs.

Daylighting – Since this is a thin building, all rooms on the perimeter have windows and clerestories provide additional natural daylight into the center. Beyond the proven health benefits of natural daylight, this also reduces the need for artificial lighting and its associated electric and cooling loads as well as providing light in times of power loss.

Photovoltaic Power and Storage – The long, sloped south-facing roof is an optimal orientation for photovoltaic power generation and battery storage. Preliminary calculations indicate a 400 square foot panel system, which fits comfortably within the roof dimensions, will provide enough power to supply a 7 kW system required for this size house. Beyond future energy savings, this also increases the home's resiliency in times of power outage.

Open Green Space – The vegetated side-yard space, beyond serving as an outdoor room for the house, also reduces heat island effect, increases natural ventilation cooling, provides direct access to fresh air, increases rainwater infiltration, and serves as an area of refuge in times of isolation such as during a pandemic.

To test these proposed passive strategies an initial energy and daylighting analysis was conducted with Sefaira software using ASHRAE criteria for climate zone 5 (Detroit) as a base point. The results showed that after making adjustments to glazing area, roof overhang dimensions, and equipment efficiency, the 2030 Challenge target of 13 kBtu/ft²/yr was reachable. The daylighting analysis demonstrated, not surprisingly, that all main rooms were well-lit and there was sufficient ambient light in remaining spaces to minimize artificial lighting. This indicates a promising start that the basic strategies are working as hoped, but further detailed studies using more precise energy analysis software will need to be conducted to verify the initial results.

3.0. MODULAR CONSTRUCTION

The long, narrow proportions of the Side-Yard House that work well with passive energy strategies also work well with modular construction dimensions, so the house models were designed using methods of factory prefabrication and modular construction to reduce labor and material costs that help offset the increased cost of insulating materials needed for an energy efficient home. Dimensions of the Side-Yard House work well with the production and transportation size requirements of the modular orthogonal boxes. The bulk of the house consists of four modules each sized to fit a standard flat-bed truck but without being too large as to require special legal permission to transport. The module design follows Louis Kahn’s idea of Served vs. Service spaces. The two larger south modules containing the frequently occupied *Served* public spaces and bedrooms are 12 feet wide with minimal interior partitions. The two, smaller technical “wet” pods are 10 feet wide and contain the service elements of the home. This includes all the rooms with plumbing fixtures (baths, laundry), vertical and horizontal mechanical chases, vertical and horizontal circulation, and closet/storage space. By collecting these less occupied *Service* spaces together in one unit, the amount of ducts and pipes required is reduced and the units acts as a thermal buffer on the north side of the house. (Even though the kitchen sink is in the larger module, it backs onto the wet pod chase to provide room for pipes and easy access for repairs). Because the width of the modules needs to be narrow for transport, the width of a single module is still slightly narrow for a public room, so the interior faces of each module are left open to be combined together into larger interior spaces. If the panels needed for the roof and long balcony were attached to the main units, they would not fit within the approved dimensions for transport. So, it is proposed they would be delivered as a flatpack of panels to be erected on site. This way the entire house superstructure could be shipped on a total of five trucks and installed in a very short time by crane. Modular construction consultants were contacted to verify the feasibility of the proposed design and offered some useful guidance such as minimum 10’ wide modules and wet wall requirements. (e.g. Figures 5 & 6)

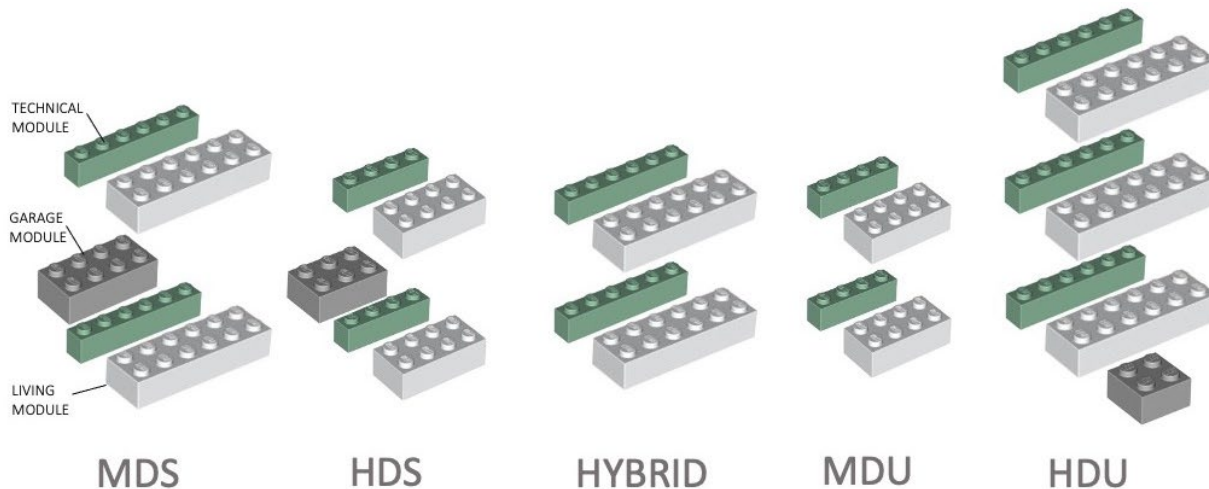

Figure 5: Concept for Adaptability of Module Types to Site/Program Conditions. (Author 2022)

3.1. CLT Mass Timber

Any new housing prototype looking to reduce carbon impact should not only address operational carbon involved with the everyday energy use of the home, it should also address the embodied carbon that goes into the construction of the house itself. Therefore, another branch of the current research has focused on sustainable prefabrication construction methods that could be used to build this house model. Even though both are suitable for modular construction and have similar embodied carbon, mass timber CLT (Cross Laminated Timber) construction was chosen rather than standard light wood framing typically used for prefabrication. The reason was to test the potential of this newer system that has been used extensively in Europe, especially for multi-unit housing, but has limited exposure both in the United States and as detached housing. Because it is a relatively new technique, manufacturer’s modular

CLT construction details published online were used as reference for this unique application. The Stora Enso company of Finland publishes an extensive guide of their CLT modular construction details which were adapted to this design.⁸ Because the building code use group is detached residential, a concrete floor topping would typically not be needed for fire rating as it is for multiunit housing. As the concrete topping is a major carbon contributor to the life cycle analysis of the mass timber system, being able to build without it greatly increases the sustainability of the project but at the same time decreases the thermal mass. The double layered ceiling / floor slab used in CLT modular construction allows for acoustic insulation in the space between to deaden noise which can be a problem with this material. (e.g. Figures 7 & 9)

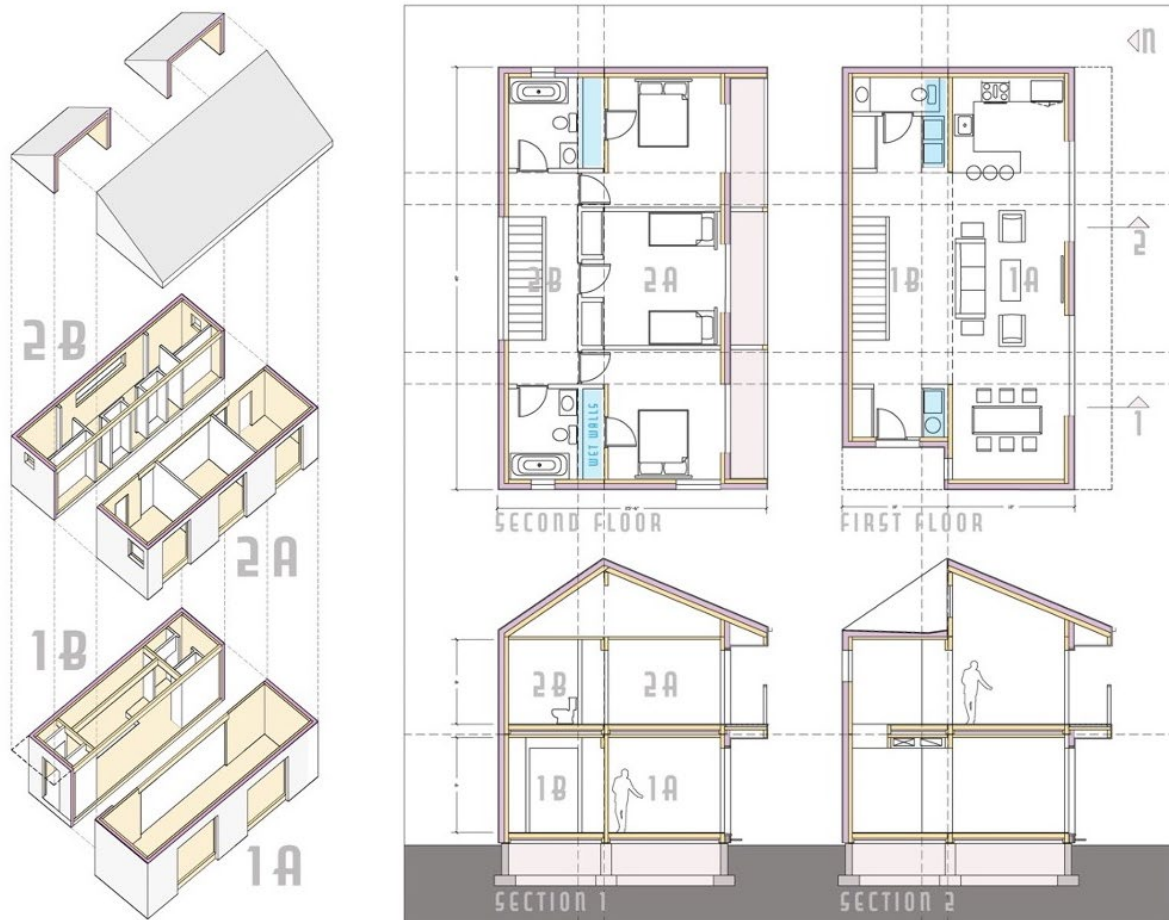

Figure 6: Module Layouts – Axons and Sections. (Author 2022)

3.2. Resilient Design

Several studies have shown wood construction is clearly lower in embodied carbon than steel or concrete production, but the difference between CLT and wood frame is less dramatic. However, another reason CLT construction was chosen is because it provides several Resilient Design features not found in light frame construction. Because they are constructed of solid wood nominally 4" to 7" thick, the CLT panels act as shear walls with ten times the shear strength of plywood (typically used to brace light wood framing) to provide better lateral resistance against seismic and wind loads. The thick CLT panels also provide better protection than hollow light wood framing from airborne debris and falling trees. With the prediction of stronger storms due to climate change, certain areas of the country would greatly benefit from these properties of the materials. The fire resistive quality of solid mass timber CLT panels which char and stay in place rather than burn and collapse, is also an advantage over stick built, especially in areas prone to forest fires. The home also incorporates several Resilient Design features beyond the CLT panels that will protect the home in times of electrical power loss. The highly insulated envelope slows heat transfer, south facing windows provide heat from the sun, the PV panels with battery backup provide a constant source of electricity, and the shading overhangs and natural cross ventilation keep the house cooler without mechanical air conditioning.

4.0 AFFORDABLE CONSTRUCTION

It is important to consider that even though a single-family detached house is attractive to a large population, there is a significant demographic of people who have different needs. The typical home buyer family with 2.5 children often associated with single-family housing is a decreasing percentage of the market while there is a projected increased need for smaller homes for those without children such as empty-nesters and single adults.⁹ Therefore, the Side-Yard House is designed to maximize affordability through prefabrication methods, energy efficiency and smaller house size.

In 1973, the earliest year for which U.S. Census data is currently available, the average square footage of a house in the U.S. was 1,660 square feet. By 2015, the average square footage of a home increased to a whopping 2,687 square feet, although since then, it's begun to drop. In 2019, the most recent year for which data is available, the average square footage of a house dropped to 2,301 square feet. The 1,000+ increase in average square footage comes despite the fact that average household size has dropped from 3.5 to 2.53 people over the same period.¹⁰

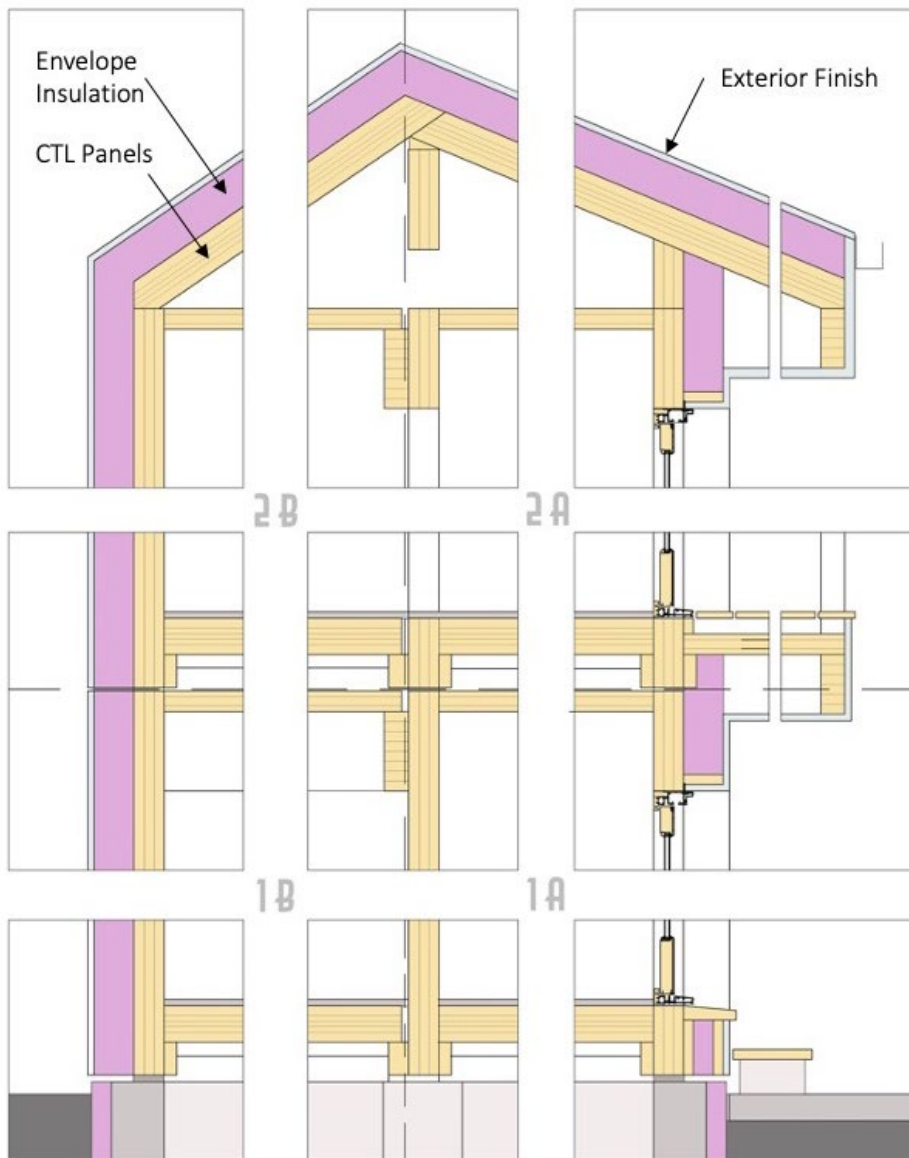

Figure 7: Mass Timber CLT Module Details. (Author 2022)

Reducing the initial construction per-square-foot price of a home starts with reducing the overall size of the house. The need for smaller houses for certain demographics can pair well with the smaller Side-Yard House models. They come in a variety of sizes to adapt to varying contexts, but the Hybrid model is 2000 square feet and the smallest MDU model is under 1700 square feet (and could be less). These areas are both below the US average, but the open plan of the public spaces still prevents the house from feeling overly confining. (e.g. Figure 8)

Even though it has many drawbacks, developer housing incorporates the major benefit of mass production construction methods to make the homes more affordable by saving time and material. The boring cookie cutter repetitions of limited house styles also allows the homes to be partially prefabricated and shipped to the site in precut units to speed construction. Side-yard homes are sized to take advantage of the prefabricated, modular construction methods and assemblies described above that can be delivered by flatbed truck. The units maintain a constant width and height for consistent efficient material preparation, but the module length can vary from 30' to 50' as a type of Mass Customization that adapts to site and space requirements. Since this design adopts *Passivhaus* principles, the construction typically costs more than standard due to the additional envelope insulating materials and more efficient equipment. Preliminary calculations were conducted using the *PHIUS Initial Cost Saving Premium and Source Energy Saving Estimator* which predicted a House of this size in the test market of Detroit would cost \$14 more per square foot, or about 6-10%, to build.¹¹ At the same time, rising construction costs are making new construction unaffordable to all except the wealthy. Typically, a modular home costs 10-20% less than a stick-built home which would cover the 6-10% increase for Passive House.¹² Future reduced energy operational costs would continue those savings. Of course, since land, construction material and labor prices vary greatly between regions, more location specific studies still need to be conducted.

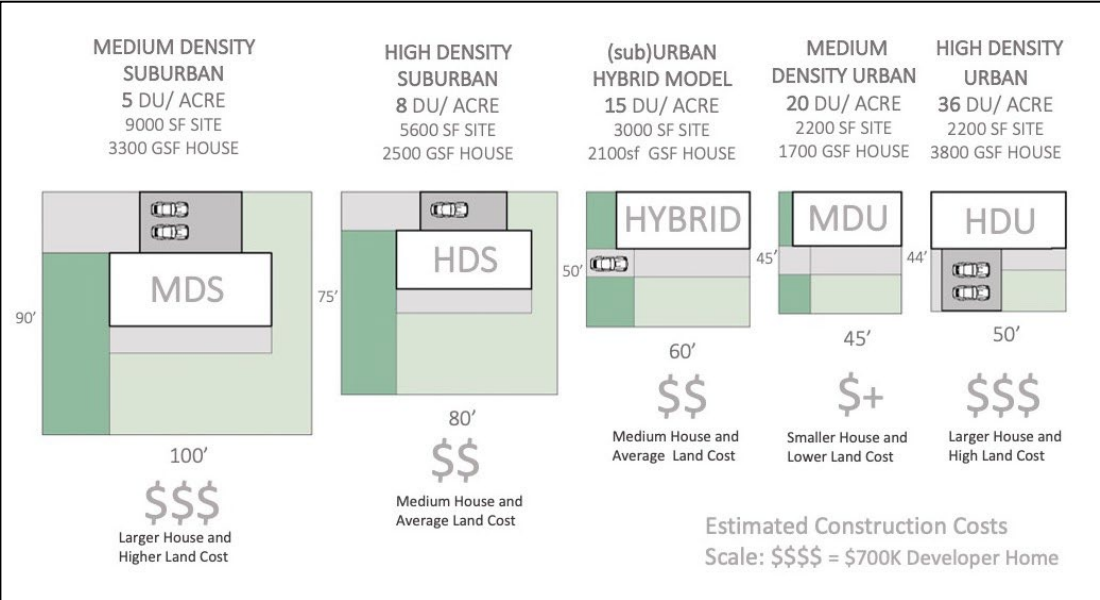

Figure 8: Comparison of Home Model Size and Prices. (Author 2022)

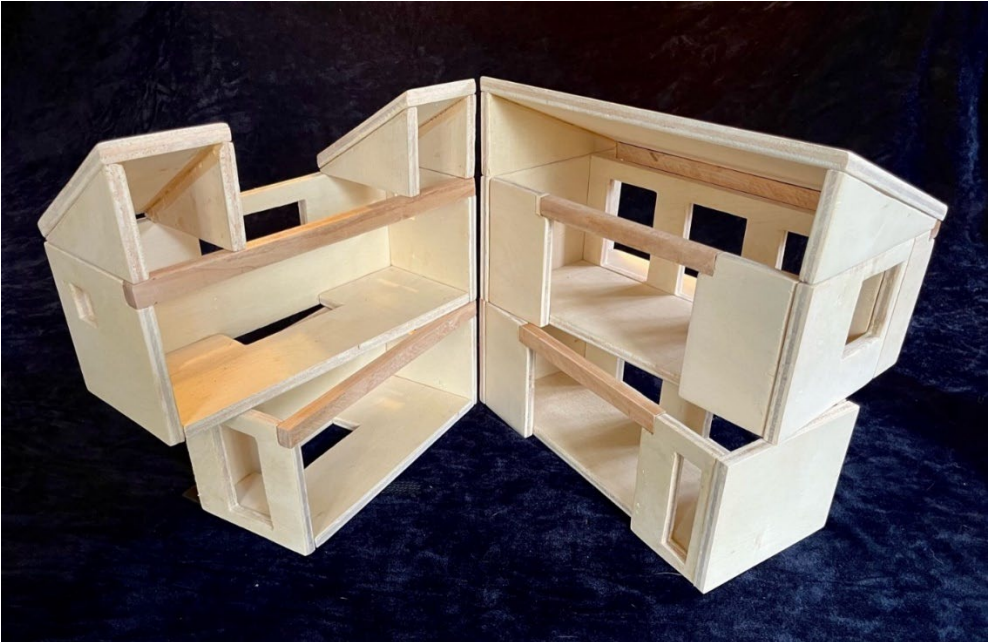

Figure 9: Plywood Structural Model to Explore CLT Construction Method, 1/2" = 1' scale. (Author 2022)

CONCLUSION

The Side-Yard House is not intended to replace traditional affordable housing. The initial prices could not be as low as government subsidized housing but could be in range of the missing-middle housing buyer market, who cannot afford much of new developer housing prices. This market with its diverse range of demographics and increased request for sustainable living, is looking for smaller, more efficient housing to decrease their environmental footprint. Admittedly, finding building opportunities with *all* the right conditions of site orientation, flexible zoning laws, a local CLT module manufacturer and a willing contractor in one place is difficult and limits the potential application of *all* benefits of the Side-Yard House. However, by following key principles, like placing most windows to the south, improving envelope insulation, employing prefabrication methods, and siting the house towards the north edge of the lot, almost any detached housing can incorporate many features and greatly improve its environmental and social impact with housing that is more passive, adaptable, modular, resilient, and affordable.

ENDNOTE

- 1 Daniel Parolek, *Missing Middle Housing*, Island Press, Washington, 2020
- 2 Janet Adamy and Paul Overberg, *Millennials Continue to Leave Big Cities*, Wall Street Journal, Sept. 26, 2019
- 3 Addison Del Mastro, *What if the suburbs were just a first draft?*, The Highlight by Vox, July 26, 2022
- 4 Candace Jackson, *The Suburbs Are Coming to a City Near You*, (New York Times, May 18, 2019)
- 5 *The 2020 NAR Community Preference Survey*, National Association of Realtors, <https://www.nar.realtor/on-common-ground/the-2020-nar-community-preference-survey>
- 6 Craig Griffen, *“(sub)URBAN Hybrid Housing; Rethinking the City with Healthy, Sustainable Housing”*, The Plan Journal, Volume 5.2, 2021, Bologna, Italy
- 7 *What is a Sun-Tempered Home?*, Solar 365 website, <http://www.solar365.com/green-homes/what-sun-tempered-home>
- 8 *Building Systems by Stora Enso*, Stora Enso, Division Wood Products, Version 4.0, December 2016
- 9 Parolek
- 10 Victoria Araj, *What Is The Average Square Footage Of A House? A Guide To House Size*, August 18, 2022, Rocket Website, <https://www.rocketmortgage.com/learn/average-square-footage-of-a-house>, excerpt from US Census Bureau, Housing Characteristics Charts
- 11 PHIUS (Passive House Institute United States) Website, <https://www.phius.org/phius-2018-initial-cost-premium-source-energy-savings>
- 12 Karen Gardner, *Prices of Modular Vs. Stick Built Homes*, <https://budgeting.thenest.com/prefab-housing-disadvantages-24540.html>

Meaningful Technologies in Architecture Education: Three Case Studies

Tulio Resende Alcantara Fernandes¹, Clarissa Ferreira Albrecht¹

¹ Universidade Federal de Vicosa, Minas Gerais, Brazil UFV

ABSTRACT: Bringing together theoretical concepts and practical scenarios, this paper analyzes three learning and design tools. It aims to promote the use of meaningful and diverse technologies in architectural education, while looking for virtues and characteristics that may inform the basis for the development of new design learning tools. To achieve that, the first step in analyzing the learning tools is through its context of usage. The second step is a discussion about the depth of the information each of them carries and how that contributes to the use of it. Finally, the third step is looking for the relationship between the concept and the information each tool communicates. The interactive nature of the three tools studied, and the increasingly digital insertion in the learning process points the direction to develop hybrid learning tools, carrying the tangible interactivity of *Mola Structural Kit*, the synthesis capabilities of *Typology Cards* and the rich technical approach of *projetEEE*. More recent technology advancements can expand even further these possibilities, pointing to a seamlessness in the way we interact with learning interfaces, helping students with both the design and communication challenges of an Architect's career. For that, Virtual Reality, Augmented Reality and web apps represent a possible path for expanding these educational tools for architects.

KEYWORDS: Design Education, Architectural Design, Tangible Interface, Augmented Reality

INTRODUCTION

The architectural practice and construction industry are increasingly transforming and adopting new technologies, while promoting an integration with digital media and tools in all stages of a project lifecycle (Al-Qawasmi 2005). In this context, the approach of design education expands from the interest of students in interactive media, and the possibility of building concepts merging architecture, art, and information technologies. This pursuit of solutions leading to unique architectural objects raises the challenge to develop interdisciplinary subjects and interfaculty dynamics, as well as more advanced and complex projects (Życzkowska and Urbanowicz 2019).

Some of these challenges faced by schools of architecture are developing in the future Architects (1) a solid comprehension of the impacts of their design decisions from a sustainability perspective (Sarhan and Rutherford 2014; Życzkowska and Urbanowicz 2019), and (2) a successful communication and information sharing among stakeholders (Arashpour and Aranda-Mena 2017), based on the reasonable number and diversity of available technologies (Hussien, Waraich, and Paes 2020).

In this context of increasing interdisciplinary demands and media possibilities, table 1 shows some of the opportunities, such as "Interest of students in media and interactive technologies", and challenges, for example, "Developing students' communication skills". Moreover, it is the training for software application that is becoming an ever more integral part of the architectural education, crowding the academic curricula, while educators look for alternative training methods to maximize the usefulness of face-to-face interaction with students (Arashpour and Aranda-Mena 2017; Holzer 2019). To promote the use of meaningful and diverse technologies in the architectural education, bringing together theoretical concepts and practical scenarios, this paper aims to analyze three learning and design tools. The case studies are conducted while looking for the tools virtues and characteristics that may inform the basis for the development of new design learning tools, with two main conceptual hurdles to overcome. The first one is the depth of the information, meaning if we go too much in depth, the student may be better off reading a book on the subject, but with the lack of it comes the risk of not being capable of successfully contribute with the learning process. The second is the relationship between the information carried by the tools and its concept (why use it instead of something else).

Table 1: Opportunities and challenges in architectural education. Source: (Życzkowska and Urbanowicz 2019, 330)

Architectural education	
Opportunities	Challenges
Interest of students in media and interactive technologies	Building interdisciplinary, interfaculty courses
Searching for new solutions on the borders of architecture: art, information technologies and lighting technologies	Searching for media solutions in the context of sustainable development

Pursuit of uniqueness and changeability of architectural objects	Construction of prototypes of new display elements and responsive structures
Interdisciplinary co-operation between students of the faculty of Electronics, Telecommunications, and Informatics	Developing students' communication skills, such as focusing on interactivity and human perception from different users' perspectives
Visualise architectural designs on a 1:1 scale in the immersive 3D Visualisation Laboratory (I3DVL) at Gdansk University of Technology	Visualisation of media and interactive solutions in the I3DVL: a new platform for co-operation between the teacher and the student

1.0 METHOD

Following Robert Yin's definition: a "case study is an empirical inquiry that investigates a contemporary phenomenon within its real-life context, especially when the boundaries between phenomenon and context are not clearly evident" (Groat and Wang 2013, 418). Therefore, the first step in analyzing the learning tools is through their context. The second step is a discussion about the depth of the information each of them carries and how that contributes to the use of it. Finally, the third step is the relationship between the concept and the information it intends to communicate. The three learning tools analyzed in this paper are (1) Mola Structural Kit, (2) Projeteeee, and (3) Typology Cards. They were chosen for their interactivity aspect, serving as extensions to theoretical concepts discussed in the architectural academic curriculum. The *Mola Structural Kit* is an interactive physical model that simulates the behavior of architectural structures through magnetized springs and metal spheres. The modular pieces allows for visualization of the movements and deformations of its elements, and countless combinations built by hand, requiring no prior technical knowledge (Oliveira 2014). The *Typology Cards* were developed to study and discuss, the dislocated relationships between house types and their sites in the United States in the form of a deck of cards. The various cards compile data and information about different types of neighborhoods, sites, and houses in a way that makes it easier to bring up these connections and disconnections (Heyda 2019). Finally, *projeteeee* is a Brazilian web-based platform to help the general public in adopting design strategies and making construction decisions based on the climate of 400 different Brazilian cities, with detailed and accessible technical information (MME 2013).

They also differ from each other in some aspects; the first, being very tactile, physical, and empirical, the second, highly digital, strict, and technical, and, Finally, the third, a unique and provocative approach in the way that it purposefully promotes a fragmented comprehension of an observation of reality that presents itself in an incohesive way. These differences will be addressed in the case studies highlighting the relationship between the concept and the content of the tools.

With the analysis of the context, depth of information and the relationship between a tool design and how it communicates information, the understanding of what an interactive design leaning tool should take in consideration during its early development stages, to be relevant and helpful for architecture students and educators.

2.0 MOLA STRUCTURAL KIT

Placing architecture and engineering knowledge in opposite spectrums causes a lack of proper cooperation between architects and engineers around the world, being them academics or practitioners. That is not helpful for anyone (Oliveira 2008). Therefore, Márcio Oliveira proposed during a graduate program in architecture an approach to deal with topics related to structural systems in a less abstract way than mathematical equations (Mola 2016). Aiming to help with qualitative and intuitive understanding of structural behavior, Mola Structural Kit brings together architecture and engineering fields.

2.1 How Mola Structural Kit works.

The experience of using the Mola Structural Kit is predominantly qualitative. It begins with unboxing the different modules that can be arranged immediately, as they are magnetically held together, in a way that users can freely play along or try to replicate any structure they are interested (Figure 1). an illustrated manual provides Further explanation and suggestions as it carries theoretical concepts on structural design. For the system to work, it is assured that the behavior of the built model is representative in isolated elements such as columns, beams and arches, or more complex structural systems resulted from their combination. This was achieved through a validation process based on computer simulation proving springs and magnetic spheres were able to accurately reproduce structural stability, deformation, influence of the form and element arrangements (Oliveira 2008).

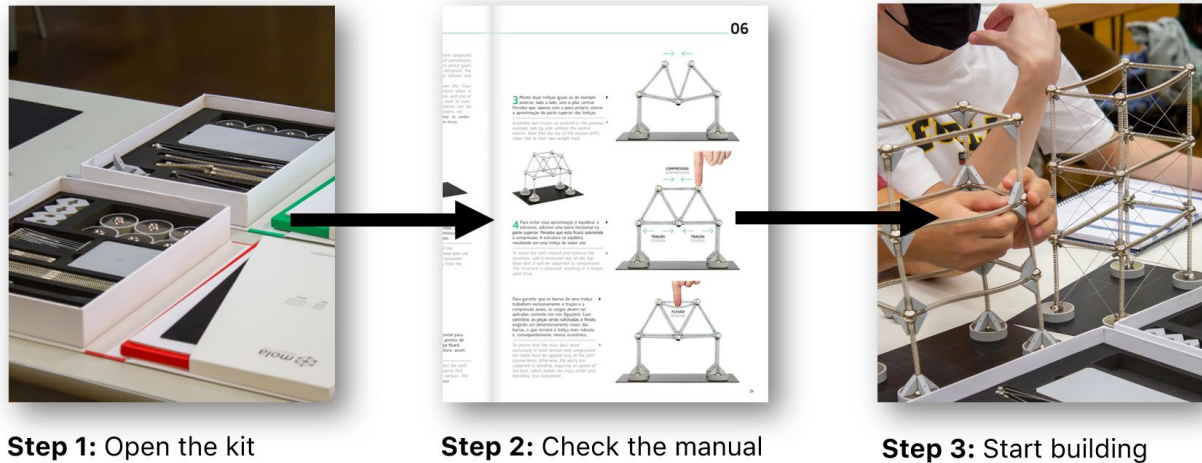

Figure 1: The Mola Structural Kit that comes with modular magnetic pieces to be assembled intuitively or with the help of the manual. Adapted from source: (Mola 2022)

2.2 How the Mola Structural Kit helps with the learning process.

The interactivity, open-ended nature of the kit offers a dynamic and rewarding learning experience. The handling of the parts during the building stages and the act of manually applying forces brings in the influence of human touch to the comprehension of structural rigidity and accomplishes an understanding impossible to register in real structures by people's sensibilities (Oliveira 2008), the goal to bridge the gap between architecture and engineering fields is then achieved through the concept of a responsive scaled model.

Other important aspect to note is the friendly way in which the tool introduces more theoretical concepts, leaving users choose freely when to read the manual to study more about the structures, or simply build more complex ones.

3.0 PROJETEEE

3.1 Promoting a market transformation

In a context of climate change and energy concern, the impact of buildings stands out both at a global scale. Buildings use more than 30% of the energy we produced globally and are responsible for an average yearly energy consumption of 2,5% since 2010 (INTERNATIONAL ENERGY AGENCY 2017). In Brazil, the residential sector used 27% of the total energy produced in 2020, an increase of 3,4% from the previous year (EPE 2021). If combined, the building, commercial, and material production industries (all directly related to architecture), the so called Architecture sector plays a much bigger part on the demand for energy (Mazria 2003).

In addition to that, due to its size and extension, Brazil has a wide variety of climates and ecosystems, so it would be expected to see building adaptations. Updating vernacular construction methods with the help of digital tools, with focus on energy performance, passive strategies from different parts of the world through various materials and techniques (Vazquez, Duarte, and Poerschke 2020).

Few architects, however, incorporate these adaptations, resulting in the climate and local characteristics being mostly ignored by the construction industry, that works independently of the site conditions. This happens for a variety of reasons, from the architect's education all the way to market circumstances (Maciel 2006).

Projeteee was created in 2006 from a cooperation of the Environment Ministry of Brazil (MME), UNPD Brazil, GEF and BID, aiming to contribute to the adoption of energy efficient design strategies and to promote a market transformation in the building industry. It is a web platform with climactic data of over 400 Brazilian cities, and recommends design strategies from a bioclimatic perspective, adequate to each region, detailing practical ways to be adopted in an architecture design. The given information is basic enough to be used at the start of a project cycle.

3.2 Condensing into a webpage

The recommendations are directly related to the NBR 15220: 2005 THERMAL PERFORMANCE IN BUILDINGS, a Brazilian national standard document that provides guidelines for social housing construction (ABNT 2003), that calculates the number of hours in or out the comfort zone in a year based on the ASHRAE 55 standard for adaptive comfort model and recommends the design strategies the bioclimatic chart adapted by Givoni for the Brazilian climate. The website runs the same calculations but presents the tailored results, making it much easier for consulting during the early stages of the design.

3.3 Getting design tips tailored for your climate.

The first step is typing the name of the city, with this input, the user is immediately presented with a panel of the city's climate data. Finally, are the bioclimatic strategies recommended for the chosen city, as shown in Figure 2.

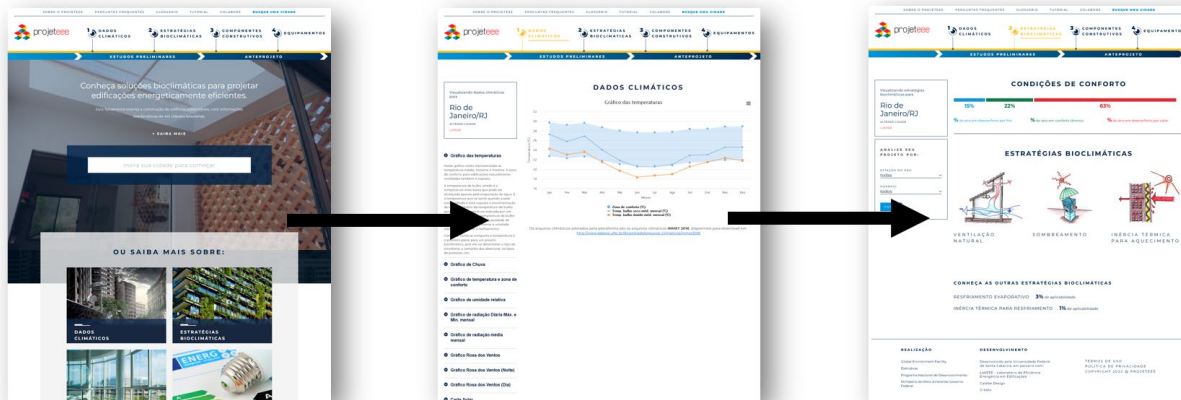

Step 1: Choose a city

Step 2: Climate overview

Step 3: Get design tips

Figure 2: Projeteee help architects make design decisions in line with the site's climate conditions. Adapted from source: (MME 2013)

The concept of getting design tips for specific climates and a wide number of cities is a welcome tool, especially in the context of a disconnection of the architecture and climate in Brazilian construction market. From a student's perspective, it can provide an intuitive introduction to bioclimatic design principles and strategies, helping them recognize and experiment with different strategies and climates.

3.4 Drawbacks and limitations

Since the page was created in 2006 it was mostly focused on a desktop environment, just before a big change in the way people interact with web and computers that was kickstarted in the late 2000s by smartphones, tablets and other mobile devices. It still works well enough in these devices due to updates along the following years but doesn't take advantage of some features that became prevalent such as access to users' location, camera, or a variety of sensors that could be greatly integrated in the platforms concept.

4.0 TYPOLOGY CARDS

Patty Heyda's research maps the politic aspects of houses, properties, people and sustainability aspects of cities in the United States, shown in the Figure 3, so that architects and residents of these areas could rethink design and spatial agency in a context of uneven development and racial, climate and social urgencies(Heyda 2019).

This last case is not focused on the technology, but a more materialistic approach, understanding that the traditional ways of discussing the disconnection between the houses built in the United States, to the cities, place and time they are built on are failing to produce any effect in the construction market. The author presents an attempt to "surrender" to the markets own logic in order to bring attention to this matter by reducing house typologies, neighborhoods, and sites to cards that can be analyzed separately or put together for discussion purposes.



Figure 3: Typology Cards purposefully separates house, property, people and even sustainability types to better understand and communicate its actual separation in real life. Adapted from source: (Heyda 2019)

4.1 Houses in U.S. share the same typologies regardless of the region they are built

Single-family houses are found along any given American metropolitan transect. More often than not, these houses share the same typologies regardless of where in the region they are located—urban, suburban, or exurban neighborhoods (Heyda 2019). The values architects are trained to discover and advance, such as environmental and material integrity, aesthetics, public and private life, and memory and continuity, no longer drive design outcomes. Today's house forms are profitable *because* they dislocate from site specificities. While this reality is known to most contemporary designers, few challenge the status quo. Due to this marketization of design, the values architects are trained to discover and advance, such as environmental and material integrity, aesthetics, public and private life, and memory and continuity, no longer drive design outcomes.

4.2 Applying this logic to technology.

If the architects today are no longer in control of the imaging constructions and subversions of their own designs, perhaps the technology we use to interact and interpret these images could be used to architecture education with the specific intent to get closer to that control. In that sense, the mobile devices could represent the technology ubiquity through which the proposed learning tool should carry the design concepts it intends to teach.

CONCLUSION

The three examples discussed above have important features that can be not only can be incorporated in future learning tools, but also be amplified if put together in a seamless and cohesive way. The interactive nature of these tools, and the increasingly digital insertion in the learning process points the direction to develop hybrid learning tools, carrying the tangible interactivity of *Mola Structural Kit*, the synthesis capabilities of *Typology Cards* and the rich technical approach of *projetEEE*. More recent technology advancements such as mobile devices can expand even further these possibilities, pointing to a more seamlessness in the way we interact with learning interfaces: the cards could come embedded with 3D models interactive through Augmented Reality, providing some of the responsiveness of scale models. Web platforms could also take advantage of sensors, local information, helping students with both the design and communication challenges of an Architect's career.

ACKNOWLEDGEMENTS

This study was financed by the Coordenação de Aperfeiçoamento de Pessoal de Nível Superior – Brasil (CAPES).

REFERENCES

- ABNT. 2003. *NBR 15220 Parte 3: Zoneamento Bioclimático Brasileiro e Diretrizes Construtivas Para Habitações Unifamiliares de Interesse Social*. Rio de Janeiro: Associação Brasileira de Normas Técnicas.
- Al-Qawasmi, Jamal. 2005. "Digital Media in Architectural Design Education: Reflections on the e-Studio Pedagogy." *Art, Design & Communication in Higher Education* 4 (3): 205–22. <https://doi.org/10.1386/ADCH.4.3.205/1>.
- Arashpour, Mehrdad, and Guillermo Aranda-Mena. 2017. "Curriculum Renewal in Architecture, Engineering, and Construction Education: Visualizing Building Information Modeling via Augmented Reality." *ISEC 2017 - 9th International Structural Engineering and Construction Conference: Resilient Structures and Sustainable Construction*, 1–6. <https://doi.org/10.14455/isec.res.2017.54>.
- EPE. 2021. "Balanço Energético Nacional - BEN 2021." *Empresa de Pesquisa Energética*, 268. <https://www.epe.gov.br/pt/publicacoes-dados-abertos/publicacoes/balanco-energetico-nacional-ben>.
- Groat, Linda N., and David Wang. 2013. *Architecture Research Methods*. 2nd ed. New Jersey: Wiley.
- Heyda, Patty. 2019. "What About Typology? An Update for Late Capitalism." *JAE Online*. <http://www.jaeonline.org/articles/design-scholarship/what-about-typology>.

- Holzer, Dominik. 2019. "Teaching Computational Design and BIM in the Age of (Semi)Flipped Classrooms." *Intelligent and Informed - Proceedings of the 24th International Conference on Computer-Aided Architectural Design Research in Asia, CAADRIA 2019* 2: 715–24.
- Hussien, Aseel, Atif Waraich, and Daniel Paes. 2020. "A Review of Mixed-Reality Applications in Construction 4.0." *Construction 4.0*, 131–41. <https://doi.org/10.1201/9780429398100-7>.
- Maciel, Alexandra Albuquerque. 2006. "INTEGRAÇÃO DE CONCEITOS BIOCLIMÁTICOS AO PROJETO ARQUITETÔNICO." Tese (Doutorado em Engenharia Civil), Florianópolis, Brasil: Universidade Federal de Santa Catarina.
- Mazria, Edward. 2003. "It ' s the Architecture , Stupid !" *Solar Today*, 48–51.
- MME. 2013. "Sobre o Projeteee." Ministério de Minas e Energia. Brasília. 2013. <http://projeteee.mma.gov.br/sobre-o-projeteee/>.
- Mola, Community. 2016. "About Us | Molamodel-Us." MOLAMODEL-BR. Perdizes. 2016. <https://molamodel.com/pages/about-us>.
- . 2022. "Como a USP Usa o Mola Para Aprimorar o Ensino de Estruturas | Molamodel-Br." MOLAMODEL-BR. Perdizes. 2022. <https://br.molamodel.com/blogs/mola-blog/how-a-leading-university-uses-mola-to-improve-the-teaching-of-structures>.
- Oliveira, Márcio Sequeira de. 2008. "Modelo Estrutural Qualitativo Para Pré- Avaliação Do Comportamento De Estruturas Metálicas." Dissertação (Mestrado em Engenharia Civil), Ouro Preto: Universidade Federal de Ouro Preto. https://cdn.shopify.com/s/files/1/2107/9061/files/Mola_Master_Thesis_Portuguese_Version.pdf.
- . 2014. "Mola Structural Kit." Catarse. 2014. <https://www.catarse.me/mola>.
- Sarhan, Ahmed, and Peter Rutherford. 2014. "Integrating Sustainability in the Architectural Design Educational Process." *ECAADe* 32 1: 323–32.
- Vazquez, Elena, Jose Duarte, and Ute Poerschke. 2020. "For Design Generation and Environmental Performance Optimization" 8628 (I). <https://doi.org/10.1080/00038628.2020.1749552>.
- Życzkowska, Karolina, and Katarzyna Urbanowicz. 2019. "Architectural Education and Digital Tools: The Challenges and Opportunities." In *World Transactions on Engineering and Technology Education*.

Materials by Design: Seamless & Graded Transitional Interface Between Geopolymer Concrete & Glass

Shadi Nazarian¹, Maryam Hojati², José Duarte¹

¹The Pennsylvania State University, University Park, PA

²University of New Mexico, Albuquerque, NM

ABSTRACT: Just as language is constitutive of thought, functionally graded materials can trigger new architectural ideas, surface conditions, and spatial experiences. They can simplify complex assemblies prevalent in contemporary construction techniques by allowing structures to exhibit formal continuity with varying performative characteristics. For instance, a concrete wall can have varying density or transparency for optimized response to programmatic needs, structural and environmental constraints, and optical requirements. This paper describes research intended to find latent properties of glass and concrete and reimagine them in the context of new technologies, and to inspire innovative architectural solutions. Critical observation of the scientific relationship between glass and concrete generated three research questions: if it is possible to engineer concrete to seamlessly transition to glass; if such seamless transition can be achieved in a graded manner; and if the resulting functionally graded structures can be designed to meet various functional requirements in a single unibody structure. A systematic experimental plan using cast and sintered recycled materials was devised to engineer a variety of geopolymer concrete formulations compatible with the coefficient of thermal expansion of glass. This plan permitted the establishment of reliable making and post-processing procedures and the achievement of proofs of concept, validated by Scanning Electron Microscopy, x-ray tomography, and mechanical test results. The developed technology promotes the use of recycled materials and alternative binders in the production of composite materials. Additionally, it has the potential to impact multiple industries, particularly, the construction industry, as it enables optimized building performance with less embodied and operational energy. Articulation of the recent *Research-Design* aligned methodologies demonstrates that fabrication-aware design-thinking can transform architectural design processes, principles, language, and experience.

KEYWORDS: Functionally Graded Materials; Seamless Interface; Concrete and Glass Interface; Geopolymer Concrete

INTRODUCTION

Innovations in glass and concrete signal exciting new possibilities, especially in the disciplines of Architecture and Industrial Design, where the graded and/or seamless transition between these materials, as presented in this paper, could permit the efficient distribution of the materials based on their function and inert properties. These solutions could be incorporated in the design and construction processes for programmatic and aesthetic purposes, and trigger cost and energy savings. At the core of this research lies yet another intention—that is to reveal the science of materials through built-form and physical objects that demonstrate material matters through haptic and artistic expression.

This paper is focused on the experimental research on concrete and glass, and the opportunities generated by seamless and graded transitional interface conditions between them. The research continues to go through further development in three main areas including: (a) scaling up to building component scale, (b) developing sintering and annealing post-processes at lower temperatures, and (c) creating relevance in the building industry by facilitating its use through 3D-concrete printing as a continuous mode of construction. Research questions are raised in the context of the advances in material science and engineering, particularly if coupled with the affordances and growing relevance of additive construction. A research plan was devised to achieve the following objectives at the laboratory scale: first, to develop alternative environmentally friendly binders with coefficient of thermal expansions close to that of glass; second, to make possible a seamless and transitional interface between concrete and glass; third, to produce functionally graded materials (FGM) using these related but disparate materials; fourth to create unibody concrete prototypes that contain areas of visually transparent glass, without the use of any chemical adhesives or mechanical means to connect the two; and finally to address structural and weatherproofing requirements. Even at the laboratory scale, the findings begin to challenge the status quo by providing viable solutions to a variety of inefficient and complex joints and assemblies that are now prevalent in the contemporary construction techniques.

1.0 CONTEXT

1.1 The Interdependency Between Technology, Architecture, and Design

There are multiple examples throughout history where the impact of the technological evolution of the time was effectively shared and communicated with wide audiences through built form and the expressive language of architecture. The most pivotal example resulted from the development of the preeminent pozzolanic concrete. This

early concrete enabled unitary and long-lasting structures, such as the Pantheon in Rome, to be built with far-reaching influence regarding the design and development of composite materials and structures that demonstrated its unique characteristics and advantages. The Pantheon has been a source of inspiration for centuries as it constitutes a meaningful expression of knowledge in its innovation in design and construction, conservation in the use of materials and other resources, implementation of functionally graded concrete in the roof structure, and holistic unification of architectural design with an optimized structural system and passive environmental control features. Constructed between ca. 118 and 128, the Pantheon exhibits the largest unreinforced concrete dome to this day, with a span of 142 feet in diameter at the base. Its dome is composed of concentric stepping rings and an ingenious coffered structure whereby the weight of layers becomes lighter from the base to the top of the dome, following a graded transition from heavier to lighter pumice aggregates in the concrete (Mark and Hutchinson 1986).

The invention of the lancet arch and the flying buttress made it possible to build tall, light-filled stone Gothic cathedrals. The use of steel in construction paved the way for the emergence of non-load-bearing façades in modern architecture, and high-rise buildings. Although the Romans understood the remarkable properties of concrete, the advent of modern architecture and the development of steel reinforcement triggered exploratory uses of this material in which function was allied with bold expressions of its structural and sculptural capacity. Overall, concrete, steel, and glass transformed the expression of structure in architecture and liberated façades from the burden of bearing structural loads.

In his manifesto, *Towards A New Architecture*, Le Corbusier spoke of the critical, rapid transformations in the development of tools by the industry to meet the new problems of his time. He recognized how a harmonious collaboration of humans and machines and mass production resulted in a culture of precision and interchangeability of parts. He understood that these comprehensive changes would transform “the conception of what architecture is” (Le Corbusier, 1927, 288), and spoke of the necessity to understand the new principles, values, rules, and affordances of new methods of construction. “Construction has undergone innovations so great that the old *styles*, which still obsess us, can no longer clothe it” (Le Corbusier, 1927, 268). He developed a *theoretical study for Maison Dom-ino* to explore the formal and spatial possibilities allowed by structural frames of reinforced concrete, where walls no longer had to be load-bearing, freeing up the façade and the interior plan.

1.2. Alternative Materials

Regarding the mitigation of greenhouse gases such as CO₂ and the advantages of low-CO₂ GP cement, Joseph Davidovits of the Geopolymer Institute (<https://www.geopolymer.org/>) has described the findings of a research study that had originally started at Penn State University's Materials Research Laboratory (MRL) in 1990, and later continued at the European Project GEOCISTEM, as follows:

“The production of one ton of geopolymeric cement generates 0.184 tons of CO₂, from combustion carbon-fuel, compared with 1.00 tons of CO₂ for Portland cement. Geopolymeric cement generates six times less CO₂ during manufacture than Portland cement. This simply means that, in newly industrializing countries, six times more cement for infrastructure and building applications might be manufactured for the same emission of green-house gas CO₂.” (Davidovits, 2002, 7)

1.3. Functionally Graded Materials (FGM): An Overview

FGMs can be found in many natural structures, for instance, in bones. Their varied properties, behaviors, and applications have been replicated in the design of synthetic materials and systems. They can be engineered to optimize functional and mechanical properties, to achieve aesthetic objectives, or to achieve both function and aesthetics in prosthetics and dental crowns and bridges, with a complex set of goals, including functional restoration, improvement of biocompatibility, correction of the bite, and mimicry of natural enamel behaviour and look. FGMs are composites in which the composition and the structure (Hirai 1996) of two or more components vary continuously or in a stepwise manner over the volume. The desired result for the design of FGM is to obtain corresponding changes in the properties of the material (Hirai 1996) and optimize the performance of the material for specific applications. Researchers have recognized the importance of functionally graded composites (FGCs) but given a lack of adequate processing techniques, they could not be achieved (Bever and Duwez 1972; Shen and Bever 1972). It took 30 years before methods of their manufacturing became possible (Lee et al. 1995). In “Functionally Graded Composites: Processing and Applications” published in *Composite Materials* (Kar 2017), Ahankari and Kar explain that the composition of the FGM in a component with a certain volume “can be either continuously graded or stepwise graded over a given volume”. If continuously graded, “the change in composition, microstructure, and hence in the properties occurs with position” along with orientation. While the stepwise-graded materials exhibit a visibly multi-layered structure with a clear interface between layers, both can result in the formation of unitary monolithic specimens, particularly in ceramics when sintered. FGMs offer promising solutions in the development of building components where multiple programmatic requirements must be met in terms of performance and where measures to ensure cost-efficiency are of critical importance.

2.0 PROBLEM AND MOTIVATION

2.1. Premise

The industrial revolution came with radical changes in architecture. New materials were made available at lower costs. New functions, forms, and details promoted the use of prefabricated standard parts, adaptable panel types, sizes, structural elements, and units. Competing building industries needed to agree on reduced numbers of standard shapes and sizes based on modes of transportation, delivery, and assembly techniques. Design thinking and processes were

transformed to integrate and incorporate builders' and manufacturers' requirements. Modularization, mechanical joints, wedge connectors, channels, tracks, and bolts made interchangeability possible. Prefabrication and mass-production of not only parts but whole structures resulted in sales and shipment of packaged homes directly to the site for assembly by the builder. Building trades became more specialized and gained greater control. Architects, on the one hand, were given new and interesting tools that happened to drive the direction of the market, but otherwise seemed to face decreased formal and tectonic choices regarding construction systems if they were to meet budgetary constraints.

In the practice of architecture, a clear vision and thought process must be maintained to unify all aspects of the project from its conception to construction. Formal and conceptual ideas can direct the driving force of an architectural investigation, or they may begin with investigation of materials, and exploration of construction techniques that enable such concept to flourish through formal expression. The latter is a more difficult task as it may require a construction technique that is not facilitated by the mainstream industry, rendering such exploratory techniques impractical and costly. While standardization of processes and practices make financial sense, they may undermine the creativity of the architect and the craftspeople.

In summary, conventional architecture relies on complex joints to bring materials and components together. For instance, a typical masonry wall uses a metal frame to mechanically fasten glass inside a masonry wall. This practice requires an array of smaller or compound joints to meet a number of functional requirements concerning thermal, fluid, vapor, and acoustical barriers and insulating layers, together with multiple layers across the wall's thickness. However, with the proposed technology, many design elements, including the structural load-bearing concrete masonry units (CMUs), thermal and sound insulation, and interior and exterior finish, can be reimagined and simplified. Infrared thermography identifies voids in thermal and pressure boundaries. Such images taken during an energy audit of a typical conventional building reveal that as a consequence of convection and conduction, there is considerable heat loss and air leakage through roofs and around the window frames, the edge-spacers and sash, and from the interior space to the exterior. In addition, although double or even triple glazing can eliminate some unwanted outside noise and help with energy loss. How well such measures work depends on the frames and seals. Against this general background, at the core of this research lies a recognition that we need to rethink and simplify our building conventions.

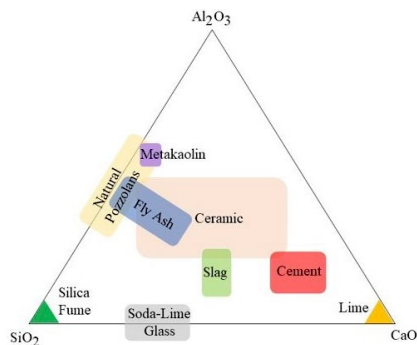

Figure 1: Ternary phase diagram of materials related to the category of ceramics, which can be mixed into composites. These materials can be obtained from three chemical compounds—Aluminum Oxide (Al_2O_3), Calcium Oxide (CaO), and Silica Sand (SiO_2)—indicated by their chemical symbols at the corners of the triangle. Depending on the ratio, maximum heat, and cooling rate, the result can be fly-ash, cement, or glass. (Author 2020)

2.2. Hypotheses and Research Questions

Three interrelated hypotheses, depicted in the ternary phase diagram in Figure 1, guided the development of the project. First, *if it was possible to engineer* a true and seamless bond between composites of related materials, such as glass, cement, and structural ceramics, without the use of a third element, such as a mechanical joint or epoxy; second, if such seamless transition could be achieved in a graded manner; and third, if functionally graded structures can be designed using concrete and glass to meet structural requirements, thermal insulation needs, and optical functions in a single and unibody structure.

The overarching hypothesis was that FGM could be optimized in response to programmatic and functional requirements. For example, a goal can be set to develop a specimen that gradually transitions along its surface from 100% GP-based concrete on the perimeter to an area of 100% transparent glass in the middle, to obtain a fixed window for light and views. It is also possible that a specimen can be developed that transitions through its thickness from 100% structural GP concrete on both sides to include a volume with increased insulative qualities in the middle. The latter example could be achieved by transitioning gradually and seamlessly to incorporate a more porous area of foamed glass, thereby providing the needed level of thermal insulation and sound barrier while removing the need for sandwich layers of insulation between the finished interior and exterior wall panels.

3.0 EXPERIMENTAL PROCEDURES AND METHODOLOGY

3.1. Solid Materials

GP paste in this study was alkali-activated fly ash (AAF), and alkali-activated fly ash-slag (AAFS) binary pastes. solid materials used in this study were: a class F fly ash (FA) meeting ASTM C618-15 requirements, a grade 100 ground granulated blast furnace slag (S) meeting ASTM C989M-12, partially fused metabasalt with uniform grading, and soda lime glass chunks and glass sheets. The composition and physical properties of the raw materials are shown in Table 1. Four different GP mixtures (three AAF together with an AAFS ((S/FA)_{vol} = 10%) were designed according to the previous studies (Hojati and Radlińska (2017)) and tested in this research. All pastes were mixed following ASTM C 305-13, where the dry powder (fly ash or a blend of fly ash and slag) was added into an aqueous activator. The cementitious materials were mixed using three activators with different modulus ($n = (\text{SiO}_2/\text{Na}_2\text{O})_{\text{mol}} = 1.60, 1.10$ or 0.94) and pH values (13.7, 14.44, or 14.63), as shown in Table 2. The liquid (activating solution) to solid binder (fly ash + slag) volumetric ratio of all mixtures was 1. All GPs were heat-cured for the first day after casting at 60°C. Alkali activators were prepared following the method outlined in Hojati et al. (2016). The properties of activators are shown in Table 2. GP1 was activated by using a commercially available aqueous sodium silicate, while GP2, GP3, and GP4 were activated by the aqueous sodium silicate mixing with either 6 M or 10 M sodium hydroxide (NaOH) solution. The commercial aqueous sodium silicate consisted of 18.0% mass Na₂O, 28.8% SiO₂, and 53.2% H₂O, and had a specific gravity of 1.6 g/cm³ at 20°C, and pH = 13.70. The mass ratio of sodium silicate to sodium hydroxide solutions for GP2, GP3, and GP4 mixtures was maintained at 2.0. GP3-B in Table 2 represents the addition of fine partially fused metabasalt to the GP3 powder. Basaltic sand was used to minimize cracking in the GP-rich layers. After demolding GPs, they were dried in the furnace at 200°C for 4 hours, then ground to specific sizes (sieved by sieves # 60 and 140), and, according to Table 3, classified into three grades: Coarse-size GP (C-GP) with particles larger than 250 μm, Medium-size GP (M-GP) with particles coarser than 105 μm and finer than 250 μm, and Fine-size GP (F-GP) with particles smaller than 105 μm. Glass chunks were ground and sieved by sieves # 60 and 140. The gradation of glass powder is displayed in Table 3. Glass chips were prepared by breaking glass sheets and used at the very top layer of the specimen. To prevent contamination, glass sheets, and chunks were cleaned with isopropyl alcohol 70% before the grinding or crushing process.

Table 3: Oxide compositions (mass %) of FA, & GGBFS powders. * Sp.Gr. is specific gravity of each powder

Oxides	SiO ₂	Al ₂ O ₃	CaO	Fe ₂ O ₃	MgO	SO ₃	Na ₂ O _{eq}	LOI	Sp. Gr.
Fly ash	46.69	22.44	4.99	19.43	1.04	0.76	1.74	2.00	2.64
Slag	30.80	11.45	47.50	2.26	3.65	3.03	0.27	2.56	2.85
Glass	63.8	14.4	4.4	-	-	-	-	-	-

Table 4: Activating solution properties and mixture design of GPs.

GP	Mixture ID.	Activator Composition		FA	S	Partially Fused Metabasalt
		pH	$n = (\text{SiO}_2/\text{Na}_2\text{O})$ molar-based			
AAF	GP1	13.70	1.60	100%	0%	No
	GP2	14.44	1.10	100%	0%	No
	GP3	14.63	0.94	100%	0%	No
	GP3-B	14.63	0.94	100%	0%	Yes
AAFS	GP4	14.63	0.94	90%	10%	No

Table 5: Gradation of GP and Glass powders

Size range	GP	Glass Powder
> 205 μm	C-GP	C-G
105 μm - 205 μm	M-GP	M-G
<105 μm	F-GP	F-G

3.2. Preparation of samples

Plaster molds were cast and used for this work. For the first part of this research, small samples were cast to adjust the sintering process; followed by studies focused on the influence of using different GPs (Table 2) for making FGM, five 50×50×50 mm cubes were cast, for each cube, one of the GPs listed in Table 2 was used. Each cube was made of three layers of different binary blends of GP and glass powders. For GP3-B, 20% of GP was replaced by basaltic sand at the bottom layer to restrict the cracking and lower the shrinkage of GP-rich layers. In the following experiments, a binary blend of GP1 and glass powder was used to make 100mm and 400mm columns of FGM. The content of the glass was gradually changed throughout the height of the column from 5% to 100% and there was a layer of glass chips added at the top. In all the research phases, for each layer, the powders (GP, basalt, and glass) were well mixed together before casting the column; then added into the mold, and well compacted, layer by layer. Afterward, the molded

powders were fired in the furnace up to 950°C according to a specific firing schedule (Figure 2). A seamless material was formed with functionally graded properties through this process.

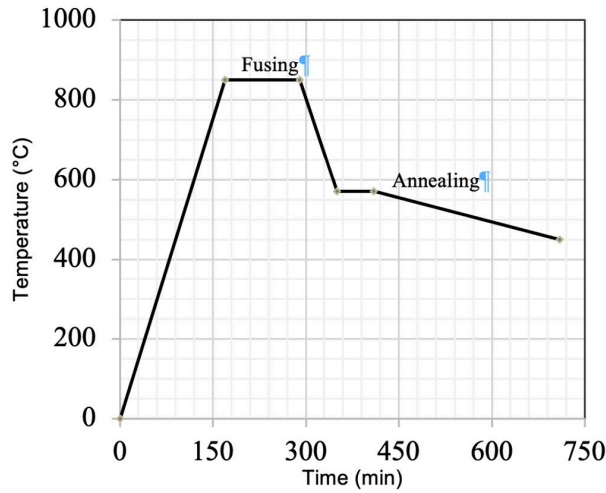

Figure 2: Firing schedule used for fusing different layers and powders (Author 2018)

3.2. Preliminary Experiments to Establish a Sintering Process

To fuse the opaque ceramic to transparent glass without using the third element, materials were fired at high temperatures. Various samples were prepared and tested (Nazarian et al. (2017)). GP was prepared at room temperature, and then fired at temperatures above 600°C, where it transformed into a structural ceramic material with improved properties.

3.3. Preliminary experiments to adjust the chemical composition of glass, layering thickness, and exposure conditions.

The FGM cubes were prepared using the firing schedule in Figure 2. The samples were set aside till they cooled down to room temperature. Then they were demolded. Figure 4 displays the FGMs made of using different GPs in powder form. As described in Section 3, all of these FGMs, were made of three layers of different combinations of glass powder, GP, and basalt. The soda lime glass with low iron was used for this part.

Table 6: a five-layer column of functionally graded material made of low-iron glass powder, GP, and glass chips, while the glass chip layer was exposed to the air (top layer)

Layer#	GP(X%)	Glass Powder (Y%)	Glass Chips	Picture of final product	Schematic picture of functionally graded material
1	0	0	100		
2	5	95	0		
3	10	90			
4	15	85			
5	20	80			

Table 7: a six-layer column of functionally graded material made of soda-lime glass, GP, and the glass chip, while the glass chip layer was exposed to the air (top layer)

Layer#	GP (X%)	Glass Powder (Y%)	Glass Chips	Picture of final product	Schematic picture of functionally graded material
1	0	0	100		
2	20	80	0		
3	40	60			
4	60	40			
5	80	20			
6	100	0			

Table 8: a 5-layer column of functionally graded material made of soda-lime glass, GP, and the glass chips, while the glass chip layer was exposed to the air (top layer)



Layer#	GP (X%)	Glass Powder (Y%)	Glass Chips	Picture of final product	Schematic picture of functionally graded material
1	80	20	0		
2	20	80			
3	10	90			
4	5	95			
5	-	-			

Table 9: a 21-layer column of FGM made of low-iron glass while glass chips was exposed to the air.

Layer#	GP (X%)	Glass Powder (Y%)	Glass Chips	Picture of final product	Schematic picture of functionally graded material
1	0	0	100		
2	0	100	0		
3	5	95			
4	10	90			
5	15	85			
6	20	80			
7	25	75			
8	30	70			
9	35	65			
10	40	60			
11	45	55			
12	50	50			
13	55	45			
14	60	40			
15	65	35			
16	70	30			
17	75	25			
18	80	20			
19	85	15			
20	90	10			
21	95	5			

4.0 RESULTS AND DISCUSSION

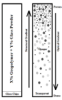
4.1. Results with Different Geopolymers

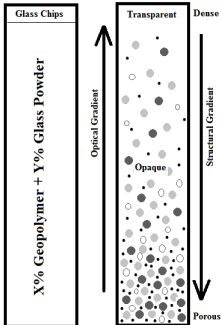
Results show that it is possible to form a strong interface between glass and GP-based structural ceramics through casting and sintering processes at the laboratory scale, achieving a seamless union between these two distinct materials, which are sintered and joined without the presence of a tertiary element. The SEM of the microstructural detail of the interface between the GP and dense soda-lime glass shows that there are no gaps or cracks between the two materials. After achieving a perceptible and sharp but seamless transition, our research focused on the goal of creating a gradual transition by varying degree of GP and soda-lime glass. The resulting FGM parts show increased structural capacity where there is more concentration of GP concrete, increased environmental and thermal capacities due to its closed porosity; and increased optical transparency as they approach 100% glass to GP ratios. To achieve seamless transition (sharp or graded) high temperatures are necessary because only then the interface between glass and GP becomes impermeable, airtight, and watertight.

Figure 3a shows two 2-part FGM samples. The GP to glass sample was produced in the following manner: A geopolymer concrete with very fine aggregates was cured, then crushed into powder and placed in a mold contacting a small piece of transparent sheet-glass. They were then fired together to form a ceramized geopolymer and glass artifact with the desired optical and structural properties. Figure 3c zooms into a selected area of figure 3b. They are images showing Scanning Electron Microscopy (SEM) of the interface between ceramized GP (at the bottom) and glass (at the top). They both show a seamless transition between GP and Glass without any imperfections or cracks. Different firing schedules and preparation procedures were used to achieve the best results.

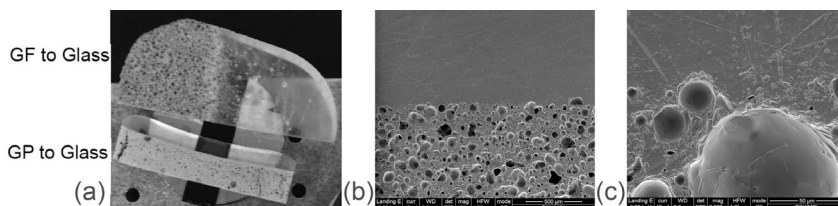

Figure 3: (a) Interface between GP (bottom) and glass (top), (b, c) Scanning Electron Microscopy (SEM) showing Microstructural details of the interface between geopolymer (on the bottom), and soda lime glass (on the top) after firing at 850°C (Author 2016)

4.2. Results of Experiments to Establish a Sintering Process

It was observed that the transparency of glass and the development of cracks are highly dependent on the sintering process. The rate at which the material is heated up and how slowly it is cooled down are also important variables that affect the vitrification and annealing of the glass components in the specimen. After adding layers of glass powder and GP with different proportions into the plaster mold, the mold was placed into a furnace and fired up quickly to 850°C, and kept at that temperature for two hours to fuse together the particles of GP and glass in the composite material and ceramize them. Then the specimen was cooled down to 570°C, at 4.7°C/min cooling rate, and held at 570°C for 1 hour, followed by the annealing stage when the formed object was cooled down from 570°C to 450°C very slowly in 5 hours, to relieve the residual internal stresses that were introduced during the manufacturing process and to prevent cracking. Finally, the furnace was turned off and cooled to room temperature.

4.3. Results of Experiments to adjust the chemical composition of glass, layering thickness, and exposure conditions.

All of the specimens formed a nice seamless interface from ceramized GP to glass. It is notable the FGM prepared by using GP1 formed a flawless ceramic unibody with no visible cracks. However, other GPs formed some cracks, and among them, GP2 formed the most noticeable ones. Comparing GP3 and GP3-B shows that the addition of partially fused metabasalt to GP can prevent cracking. Furthermore, addition of slag to GP3 (to form GP4) lowered the cracking remarkably in the ceramic part of FGMs. To fuse the GP and glass powder together, it is necessary to fire and heat them together at a very high temperature (in this experiment up to 850°C). In order to achieve the best fusion between the initial materials at such a high temperature, their CTE should be close or similar to each other. The difference between CTE of GPs and glass after firing up to 850°C would result in severe cracking of ceramics. Previous studies showed that the properties of GPs are highly dependent on the properties of alkaline solution. According to previous studies (Shelby, J.E. (2005), increasing the alkali content of activating solution (Table 2) in GPs resulted in a higher CTE. The CTEs of different GPs made of metakaolin or fly ash activated with different activating solutions were each measured. In general, the results indicate that the CTE of soda-lime glass and GP are close to each other, and there is a slight difference between them at higher temperatures (> 400°C). The best match between CTEs of GP and glass was observed for the GP1, which is made of the sodium-silicate solution of $n=1.60$ and $pH=13.7$ (i.e., $m=0.2$, $r=1.65$). These FGM cubes were preliminary experiments to find the most compatible GP which can be used with the least amount of cracking, resulting in the best seamless interface between different layers.

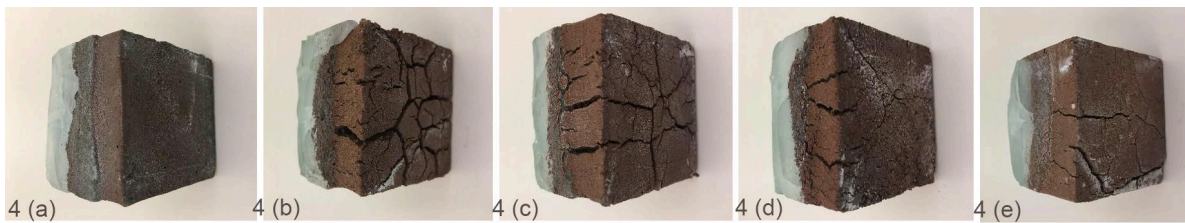

Figure 4: Picture of different cubes ((a) GP1, (b) GP2, (c) GP3, (d) GP3-B, (e) GP4 made of low-iron glass (Author 2019)

4.4. Results of Experiments to Determine the Best Sintering Process

It was observed that 100% GP layer shrunk, and noticeable cracks propagated through the specimen; however, GP1 was used (which exhibited almost similar CTE to the soda lime glass). For the internal layers with a binary mixture of GP and soda-lime glass powder, a slight expansion in the final products was observed, which got larger by increasing the glass powder content. Comparison of Table 4 with Table 5 points out the importance of glass powder composition (low-iron soda-lime vs. ordinary soda-lime glass) and the change of glass powder quantity between successive layers. The specimen in Table 4 led to a nicer FGM column without any notable boundary between different layers, which resulted from slight differences between the composition of successive layers or the use of low-iron glass powder. According to Table 5, 100% GP may shrink and crack at high temperatures. It was also observed that the addition of low content of glass powder (5% or higher) in the structural (GP) layers might prevent this cracking.

In comparison with Table 5, the results showed how the order of layers could influence the final product. In this specimen, the top three layers shrunk, and a distinguished boundary formed between layers 3 and 4. There is no cracking in the GP-rich layers which can be attributed to the inclusion of 20% glass powder instead of a pure GP layer. To scale up the FGM from small cubes to larger columns, there are some considerations that could lead to better results (i.e., FGM):

- By comparing Tables 4 and 5, it is apparent that using low-iron glass led to a more precise product as no considerable volume change (expansion) of glass-rich layers was observed after firing.
- By comparing Table 4 and 6, it is perceivable that when the GP-rich layer was in contact with air it shrunk. Hence, it would be better to put low-iron glass as the top layer.
- To lower significant volume change between layers, it would be practical to increase the number of layers in a given length of a column and change the material composition in smaller increments.

Using 100% GP may result in cracking at a very high temperature, but adding a small amount of glass powder in GP-rich layers can prevent cracking because it balances the CTEs between layers.

CONCLUSION, IMPACTS, AND FUTURE WORK

Research results confirmed the possibility of creating seamless and graded transitions between structural concrete and transparent glass. These results also show the ability to eliminate joints and open the possibility of conceiving and materializing construction details that are innovative, and effective. Figure 5 presents a plan drawing of a proposed structurally and optically graded wall of structural GP concrete with a glass-foam infill for insulation fused to a double-layer glass window. The drawing suggests the possibility of the wall having varying thickness to accommodate variations in load bearing, thermal insulation, and optical needs.

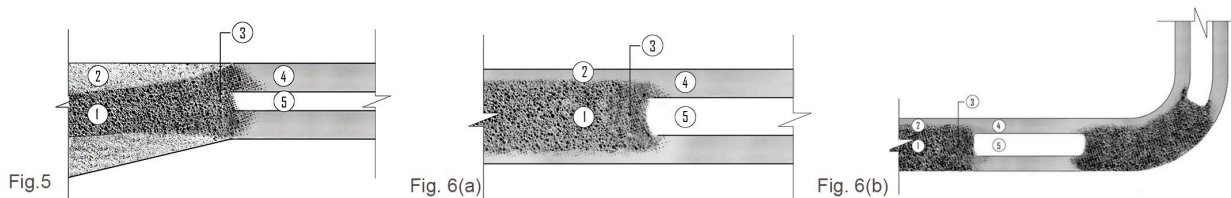

Figure 5: Proposed plan drawing of structurally and optically graded wall comprising: (1) functionally insulating glass foam, (2) structural geopolymer concrete; (3) transition zone; (4) 3/4-inch laminated thermally toughened safety glass; (5) 1/2-inch air space providing additional sound and thermal insulation through the window.

Figures 6 (a + b) Plan drawings showing Glass Foam (GF) sandwiched & bonded between thin layers of glass for added stiffness, strength, and insulation value. (Drawn by Nazarian in 2016)

Although the research described in this paper used casting technologies, we believe that the true benefits of FGMs can be achieved through additive manufacturing or hybrid technologies that combine the two. We have developed and printed with a variety of geopolymer-based concrete mixes. We also have successfully printed functionally graded cork-concrete. Future work will aim to use artificial intelligence for synthesis of data, and development of algorithms to accomplish precise (e.g., voxel by voxel) design and distribution of FGMs. This will make possible the efficient use of materials and labor, the betterment of safety measures in the construction industry, and a decrease in the carbon footprint. The potential result is an increase in the efficiency of the construction industry.

FGMs can also catalyze the adoption of 3D concrete printing, which can facilitate the construction of continuously graded and morphologically varied built forms for improved structural, functional, or aesthetic requirements. In the current state of the technology, post-processing of monocoque structures is limited to the size of the kiln, unless the structure is made of prefabricated components. To overcome this limitation, sintering methods at lower temperatures must take place.

The underlying aim of the described research is to explore from an architectural perspective the affordances of the gradual transition from concrete to glass. The proposed technology has an immediate and fulfilling visual impact that reveals the science of a family of materials (ceramics) and the underlying controlled manufacturing process, while addressing principles of aesthetics and function. Thus, in one breath, one can trigger the curiosity of audiences and reveal information about the essence of the materials used, through the sensorial and spatial experience of the built form. In summary, the role of art or architectural artifacts that exploit this finding is not to make explicit the underlying science, but to display the inner properties of materials, beyond their aesthetic and functional potential—a role worthy of attention for industrial design, sculpture, and architecture, as disciplines that can showcase the affordances of scientific discoveries.

ACKNOWLEDGEMENTS

The authors gratefully acknowledge the financial support from the Material Research Institute (MRI), and Institute of Energy and Environment (PSIEE) joint seed grant program, the Department of Architecture, the Bowers' grant of Department of Architectural Engineering in support of "Materials by Design: From Functionally Graded Materials to Seamless Architecture", and thank Drs. Carlo Pantano, Hailong Ye, and Aleksandra Radlińska for their assistance. All tests were performed at the Transitional Material Interface (TMI) Laboratory, Civil Infrastructure Testing and Evaluation Laboratory (CITEL), and the Materials Research Institute (MRI) of The Pennsylvania State University.

REFERENCES

- Ahankari, S. S., and Kar, K. 2017. *Functionally Graded Composites: Processing and Applications*. Composite Materials edited by K. Kar, 119–168. Berlin & Heidelberg: Springer-Verlag.
- Bever M.B. & Duwez, P.E. 1972. *Gradients in Composite Materials*. Materials Science and Engineering 10(1): 1–8.
- Davidovits, J. 2002. *Environmentally Driven Geopolymer Cement Applications*. Geopolymer Conference Proceedings, October 28–29. Melbourne Australia. 7 .
- Hirai, T. 1996. *Functional Gradient Material*. Ceramics: Part 2, edited by R.J. Brook, Materials Science and Technology, 17B, 293–341. Weinheim: VCH Publishers.
- Hojati, M., and Radlińska, A. 2017. *Shrinkage and strength development of alkali-activated fly ash-slag binary cements*. Construction and Building Materials, Vol. 150, pp. 808–816.

- Hojati, M., Rajabipour, F., and Radlińska, A. 2016. *Drying shrinkage of alkali activated fly ash: effect of activator composition and ambient relative humidity*, 4th International Conference on Sustainable Construction Materials and Technologies (SCMT4). Las Vegas, NV.
- Le Corbusier, 1927. *Towards A New Architecture*. New York: Holt, Rinehart and Winston. P 268
- Ryu, G.S., Y.B Lee, K.T. Koh, and Y.S. Chung. 2013. "The Mechanical Properties of Fly Ash–Based Geopolymer Concrete with Alkaline Activators." *Construction and Building Materials* 47: 409–418
- Mark, R., and Hutchinson, P. 1986. *On the Structure of the Roman Pantheon*. *The Art Bulletin* 68(1): 24–34.
- Nazarian, S., Pantano, C., Colombo, P., and Marangoni, M. 2017. *Seamless architecture: Innovative opaque to transparent material interfaces*. *Challenges for Technology Innovation: An Agenda for the Future*. England: Taylor & Francis.
- Shelby, J.E. 2005. *Introduction to Glass Science and Technology*, Royal Society of Chemistry, 2nd Ed.
- Shen, M., and M.B. Bever. 1972. *Gradients in Polymeric Materials*. *Journal of Materials Science* 7(7): 741–746.

New Schemes of Organized Complexity Based on Quasi-Crystalline Symmetries

Rima Ajlouni¹

¹ University of Utah, Salt Lake City, UT

ABSTRACT: The prevalence of using computational methods for design exploration is profoundly transforming the way in which we conceive, craft and experience our built environment. By imposing a high degree of imbedded conformity to the digital logic, our physical, virtual and perceptual realities are gradually changing. The ability to use algorithms to manipulate form has enabled designers to achieve more complex geometric schemes. In particular, the use of generative-based approaches have rapidly become widespread among many design professionals. This design logic encodes design intent within sequences of processes that are structured to evolve independently beyond the designer's initial input. However, this design approach often incorporates randomness as a self-governed system for generating design response. Unfortunately by incorporating chance into the design process, this irrational design approach often steers the design response towards expressions of disorganized complexities and chaos. In this context, it is critical to emphasize that randomness in the built environment can be harmful to humans. Instead, schemes of organized complexities should be utilized. These organized structured schemes can satisfy the need for complexity while maintaining a global order. Such organized schemes are often derived from natural systems, which can be understood instinctively by humans. To address this need, this paper is proposing a method for generating different schemes of organized complexity by utilizing quasi-crystalline symmetries. The goal is to introduce a methodology for generating complicated geometric schemes with a long-range order that can be used to inform architectural design. The research employs case studies as its main methodology. The general population of the study includes 8-fold, 10-fold and 12-fold quasi-crystalline symmetries.

KEYWORDS: Randomness, Organized Complexity, Quasi-Crystalline, Patterns, Environmental Psychology

INTRODUCTION

The use of computation and digital methods in architecture is actively reshaping our built environment and the way we perceive it. The digitally-driven design logic encodes the design intent within a predefined set of relationships and parameters as a conversation between input and output. Such deductive reasoning logic often steers the design responses toward repetitive patterns or randomly-driven schemes (Ajlouni 2016, 2018). In their effort to achieve more complex geometric schemes, designers are embracing the generative design logic, in which design intent is encoded in sequences of processes that are structured to evolve independently beyond the designer's initial input (Ajlouni 2018). Unfortunately, this design approach often incorporates randomness as a self-governed system for generating design responses (Verbeek 2006). By incorporating chance into the design process, this irrational design approach often steers the design response towards expressions of disorganized complexities and chaos. In this context, it is critical to emphasize that our human sensory and cognitive system can only process what is organized (Salingaros 2015). Humans instinctively try to project order on the chaos in order to seek meaning and make sense of their environment (Salingaros 2015, Mehaffy and Salingaros 2015). Randomness or disorganized complexity in the built environment can be harmful to humans. Organized complexities, on the other hand, are driven from natural systems and can be understood instinctively by humans. (Bar-Hillel and Wagenaar 1991). Therefore, it is important to ask the question of how to generate schemes of organized complexities while maintaining a global long-range order? To respond to this question, this paper proposes a methodology for generating different schemes of organized complexity by utilizing quasi-crystalline symmetries.

The emergence of quasi-crystalline theories in mathematics and material science is revealing an exciting new class of symmetries that has never been explored before. The interest in these mysterious symmetries was triggered by the discovery of quasicrystals in 1984 (Shechtman et al. 1984). This new state of matter exhibits forbidden symmetries, which were thought to be impossible for the crystalline matter in classical crystallography. The atoms in these complicated structures are not arranged according to regularly spaced intervals, similar to traditional crystals, instead, they exhibit a complicated long-range order that is not periodic (Socolar, Steinhardt and Levine 1985, Yamamoto and Takakura 2008). One key ingredient of the quasi-periodic systems is their multi-level hierarchical nature, which allows the same structures to recur at multiple scales. Until recently, these symmetries have been constructed by utilizing complicated mathematics that often do not operate within the real physical (Euclidean) space. However, the discovery of Islamic historical patterns with similar geometric properties is providing new insight into resolving these symmetries; eliminating a major roadblock for many researchers outside the field of crystallography and material science.

New methods are emerging; providing new research into understanding the generating principles behind these complicated patterns (Makovicky 1992, 2007, Lu and Steinhardt 2007, Ajlouni 2012, 2013, 2017). Examples of these patterns can be found on the walls of Gunbad-I Kabud tomb tower in Maragha, Iran (1197 C.E.), the walls of Darb-i Imam shrine and the Friday Mosque in Isfahan, Iran (1453 C.E.), the walls of the Patio of Virgins, at the Royal Alcazar in Seville (1364-1366 C.E.), the walls of the Hall of the Two Sisters, Alhambra (1354-1359 C.E.), and in the medieval Topkapi Scrolls (15th or 16th centuries) in the library of the Topkapi Palace, Istanbul. Derived from the new insights, a methodology for generating the long range order of these global schemes is demonstrated.

1.0 LONG-RANGE NON-PERIODIC ORDER

1.1 Multi-level hierarchies

The process of generating the global long-range non-periodic order is based on building a multi-level hierarchical logic. This process does not rely on defining explicit quantities, angles or distances, instead it highlights the inherent relationships imbedded within the global system itself, enabling a higher level of organization to happen intuitively. The construction process of these complex systems is based on manipulating two main components, an underlying hierarchical grid which is responsible for defining the underlying non-period symmetry and a limited number of seed units which derive the different design variations. By changing the design of the seed units, a wide range of design variations can be attained without changing the underlying symmetry. In this tightly controlled system, the underlying hierarchical grid is the key ingredient for organizing the relational logic in the whole system.

1.2 The underlying hierarchical grid

The process of generating the global long-range non-periodic order starts by constructing an underlying hierarchical grid, which is achieved by building a progression of nested poly-grams. In this progression every hierarchy is proportionally built on the previous one, resulting in a self-similar network. Examples of 8-fold, 10-fold and 12-fold relational underlying networks are shown in Figure 1. These networks can be constructed by drawing rotational lines connecting points or mid-points on the initial polygon, which produces a smaller scale internal polygon. By repeating the same process on the smaller polygon, a new generation of the smaller polygon appears. In this way, a nested poly-grams network emerges that exhibits a unique relational logic and grows based on a fixed ratio (Figures 1a-1c, 1g-1i, 1m-1o). For example, by examining the three networks of nested poly-grams in Figures 1c, 1i, 1o, we find that, if we denote the radius of any poly-gram by r and the next larger radius by $r+1$, then the ratio of $(r+1)/r$ is equal to the irrational factor of $\sqrt{2+1}$ for 8-fold network, the golden ratio $(1+\sqrt{5})/2$ for the 10-fold network and the square irrational factor of $\sqrt{2+\sqrt{3}}$ for the 12-fold network.

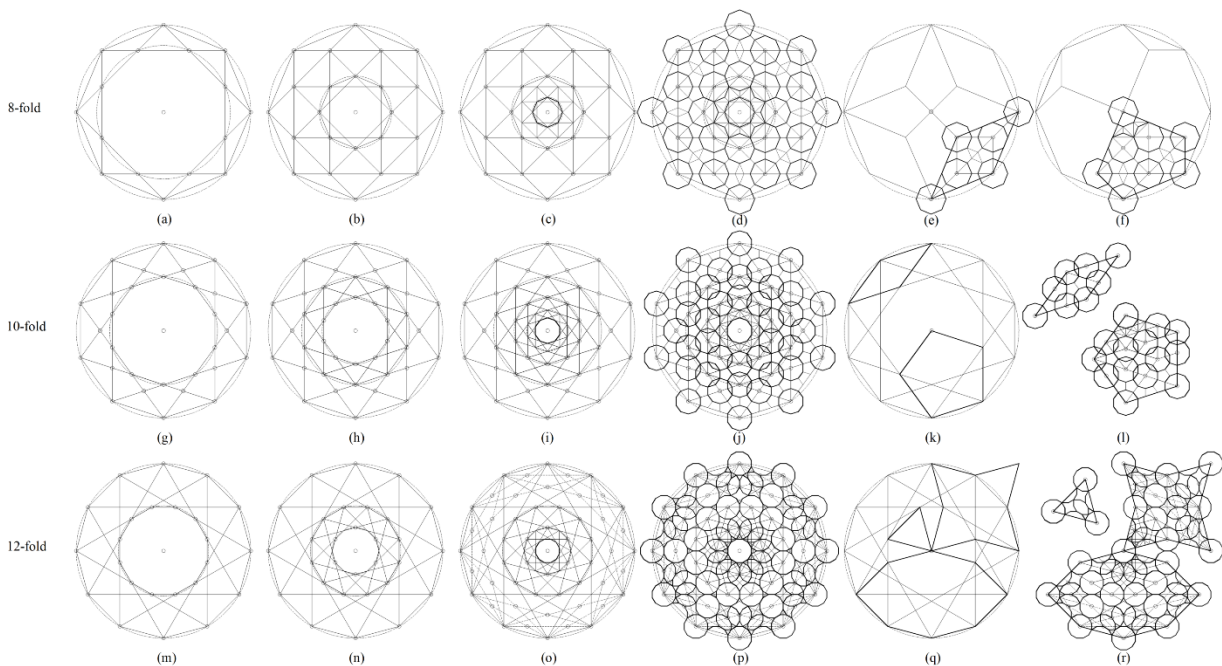

Figure 1: Examples of the frameworks of nested poly-grams for three symmetries, 8-fold, 10-fold and 12-fold. (Ajlouni 2022)

It is possible to design a wide range of the networks of nested poly-grams by manipulating the formations of the connecting lines. Figure 2 shows six different variations of networks of nested octagrams. Such flexibility allows for a wide variety of different complicated non-periodic symmetries to be achieved.

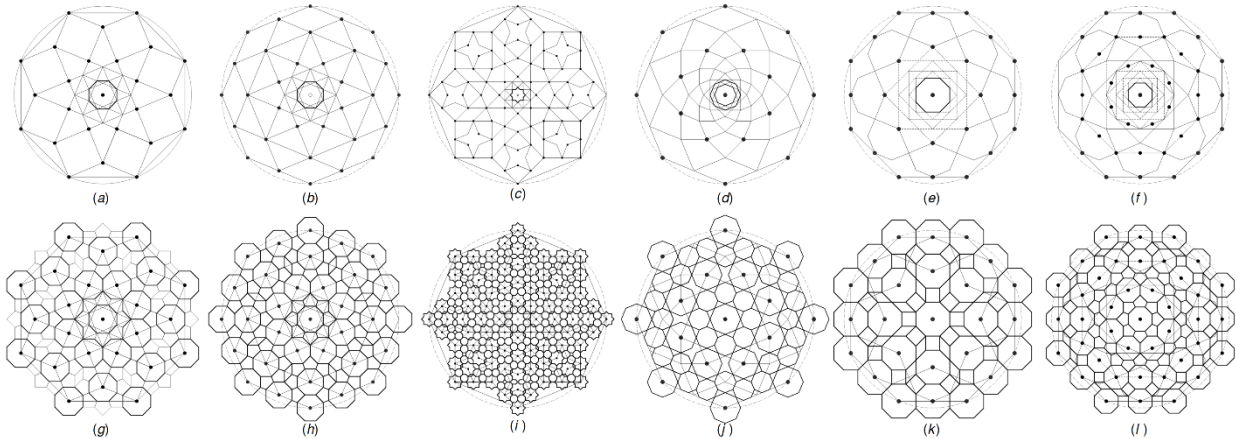

Figure 2: Six variation of the framework of nested octagrams for 8-fold symmetry. (Ajloni 2022)

1.3 The first hierarchy

One unique property of the quasi-periodic relational logic is that the size of each nested polygon is proportional to the whole network and can be used as a seed unit to derive a specific level of hierarchical formation. As shown by Figures 1 and 2, the progression of nested polygrams define the size of the central polygons, which serve as the seed polygons for constructing the first hierarchy of the non-periodic systems. The locations of the seed polygons are mapped by the intersection points of the nested network, allowing all seed polygons to fit in place. The space between the seed units can be filled with connecting polygonal formations that are often derived from dissecting the main seed polygon. This allows for a wide range of formations at different scales of complexities, while keeping a very strict but simple construction maps. These polygonal systems create generalized maps for deriving many variations of non-periodic designs. By manipulating the internal design of the seed units, many creative variations can emerge. In the case that the internal design of the main seed unit mirrors the design of the nested network, a perfect self-similar system is constructed, in which the same pattern occurs at different scales. By manipulating the arrangement of the underlying network and the internal design of the seed units, an unlimited range of design possibilities can emerge.

1.4 The second hierarchy

Constructing the infinite non-periodic structure requires building a progression of multi-level hierarchies, in which every hierarchy is built on the previous one. In this way the non-periodic designs can grow infinitely while always changing its internal formations. Figures 1d, 1j, and 1p show the first-level hierarchy of the generalized polygonal maps of the non-periodic 8-fold, 10-fold and 12-fold symmetries.

To construct the second-level hierarchy, the results from the first-level hierarchy shown in Figure 1 serve as the seed clusters for the second-level hierarchy. In this process a new generation of nested poly-grams are constructed (Figures 3a, 4a and 5a). The new generation of nested poly-grams are used to distribute the seed clusters within the new network (Figures 3c, 4c and 5c). The connecting formations shown in Figures 3d, 4d and 5d are used to fill in the gaps between main seed clusters. To build the third-level hierarchy of the non-periodic structure, we follow the same process. A new generation of the nested poly-grams is constructed and the result of the second hierarchy cluster in Figures 3e, 4e and 5e are used as the seed clusters for the third hierarchy.

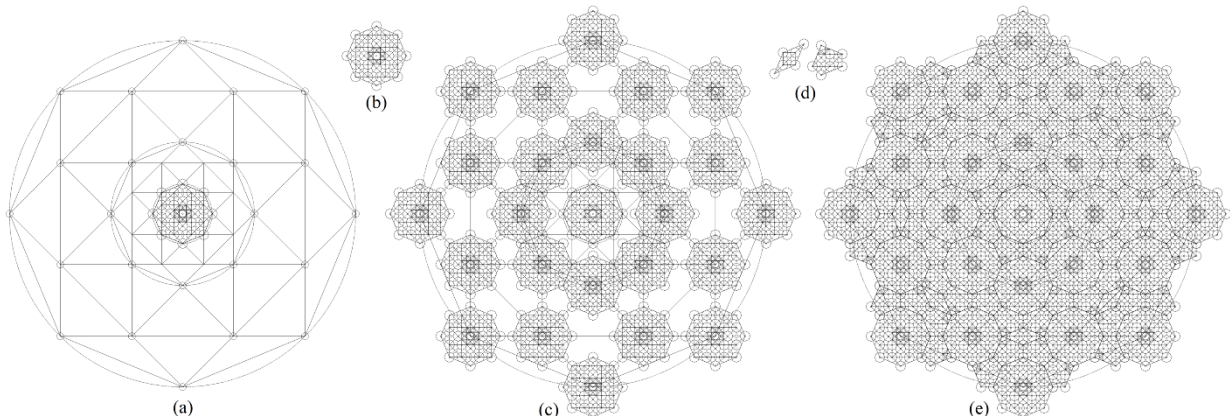

Figure 3: The process of constructing the second-level hierarchy of 8-fold non-periodic pattern. (Ajloni 2022)

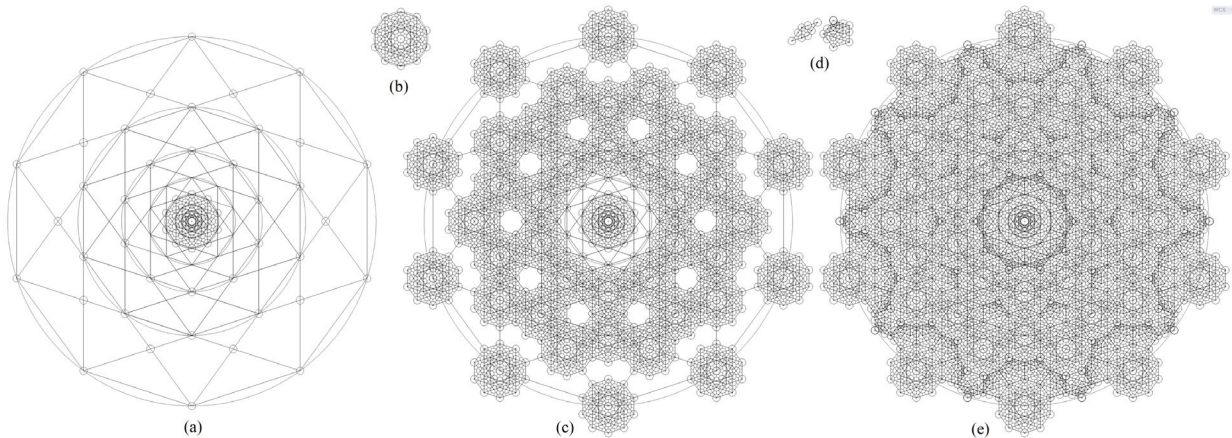

Figure 4: The process of constructing the second-level hierarchy of 10-fold non-periodic pattern. (Ajlouni 2022)

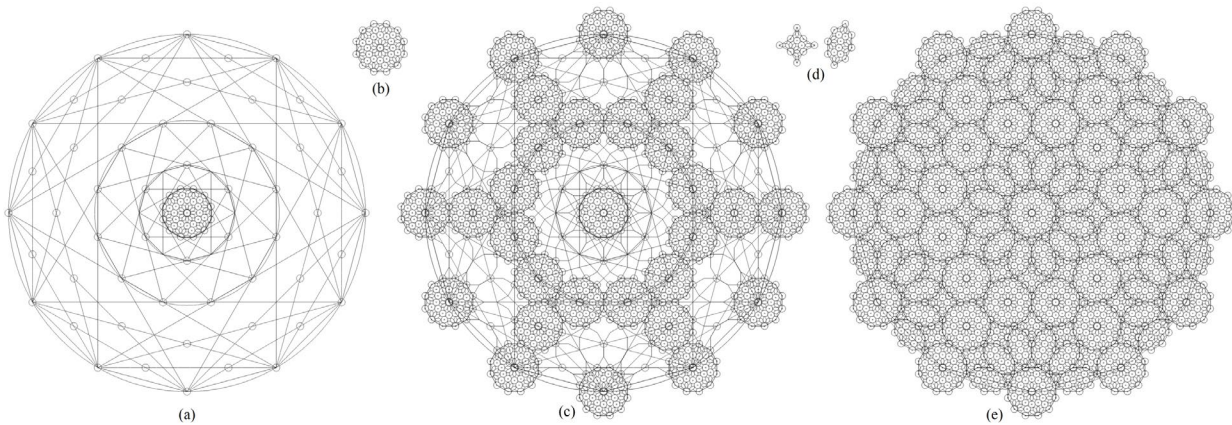

Figure 5: The process of constructing the second-level hierarchy of 12-fold non-periodic pattern. (Ajlouni 2022)

In the next sections, the process of deriving different schemes of organized complexities using the generalized polygonal maps of the second-level hierarchies for 8-fold, 10-fold and 12-fold is demonstrated.

2.0 METHODS

The goal of this research is to introduce a methodology for generating patterns with organized complexities that can be used to inform architectural design schemes. This research employs case studies as the main methodology to demonstrate the process of generating patterns of organized complexity based on the generalized polygonal maps introduced in the first section. The general population of the study includes 5-fold, 8-fold, 10-fold and 12-fold quasi-crystalline symmetries.

2.1 Case study 01: 8-fold-driven schemes of organized complexity

The generalized polygonal map in Figure 3e serves as the blueprint for deriving different schemes of organized complexities for 8-fold non-periodic symmetry. Figure 6 shows three examples derived from this symmetry. The upper left example utilizes the lines of the network of the nested octagrams to derive two self-similar non-periodic sequences of two distances that are based on $\sqrt{2}$ proportion. If we denote the large distance by L and the small distance by S, then the ratio of L/S is equal to the irrational factor of $\sqrt{2}$. The unique quality of this sequence is that it will extend infinitely without repeating the same formations similar to the famous Fibonacci sequence. The upper right example in Figure 6, shows a close-up view of the organized complexity of the generalized polygonal map in Figure 3e. To the untrained eye this formation might seem chaotic or random. However these formations are derived from a very strict proportional system of organized complexity based on the 8-fold non-periodic structure. The last scheme of organized complexity in Figure 6 shows a close up view of the generalized polygonal map in Figure 3e integrated with a star-shaped seed design shown in Figure 6a. By manipulating the internal line design of the seed octagon, it is possible to derive wide variety of organized complexity schemes. Figure 6b shows design of the seed unit that does not preserve the rotational symmetry of the seed octagon.

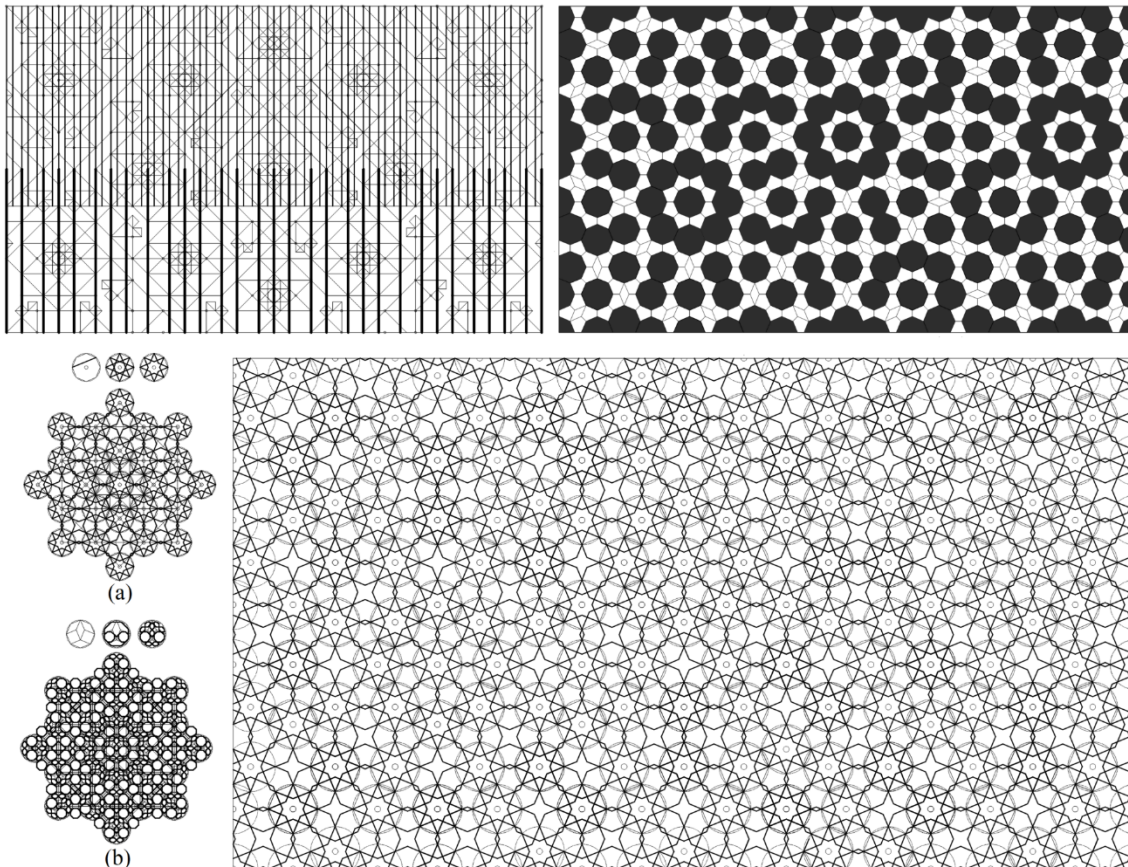

Figure 6: Three examples of organized complexity schemes derived from the 8-fold non-periodic structure in Figure 3c. (Ajlouni 2022)

2.2 Case study 02: 10-fold-driven schemes of organized complexity

The generalized polygonal map in Figure 4e serves as the structural blueprint for generating different schemes of organized complexity based on the 10-fold non-periodic symmetries. Figure 7 highlights three examples derived from this symmetry. The upper left example utilizes the lines of the network of the nested decagrams to derive a multi self-similar non-periodic sequence of two distances that are based on the golden ratio $(1+\sqrt{5})/2$, which is in fact the famous Fibonacci sequence. As we know, this sequence can be extended infinitely without repeating the same order. The sequence can also be extended to form a two-dimensional grid that holds similar non-periodic properties. The upper right example in Figure 7 shows a close-up view of highlighted elements within the generalized polygonal map in Figure 4e. These formations offer many interesting and complex variations that can be utilized for architectural applications. The last scheme of organized complexity in Figure 7 shows a close up view of a non-periodic tiling that is generated by integrating the star-shaped seed design in figure 7a within the generalized polygonal map in Figure 4e. This tiling is indeed a variation of the famous non-periodic Penrose tiling (Penrose 1974). The only difference is that this tiling has three repeating tiling units, instead of two tiling units. As this demonstrates, by manipulating the internal design of the seed decagon, it is possible to derive an unlimited number of organized complexity schemes of 10-fold quasi-crystalline symmetry. Figure 7b demonstrates one other example of the internal design of the seed units that can be utilized to generate a new design variation.

2.3 Case study 03: 12-fold-driven schemes of organized complexity

The generalized polygonal map in Figure 5e serves as the structural blueprint for generating different schemes of organized complexities based on 12-fold non-periodic symmetry. Figure 8 highlights three examples of organized complexity that are derived from this symmetry. The upper left example utilizes the lines of the network of the nested dodecagrams to derive two self-similar non-periodic sequences of two distances that are based on the irrational factor of $\sqrt{3}$. If we denote the large distance by L and the small distance by S, then the ratio of L/S is equal to the irrational factor of $\sqrt{3}$. The unique quality of these sequences is that they will extend infinitely without repeating the same formations similar to the two examples explained in the previous sections. Moreover, the network allows for generating fractal-based sequences that are infinite. The upper right example in Figure 8, shows an interesting formation based on highlighting certain elements within the generalized polygonal map in Figure 5e. To the untrained eye this formation might seem chaotic or random, however as we demonstrated, these formations are derived from a very strict proportional system of organized complexity based on the 12-fold non-periodic structure. The last scheme of organized complexity in Figure 8 demonstrates a close up view of the generalized polygonal map in Figure 5e integrated with a

star-shaped seed design shown in figure 8a. By manipulating the internal line design of the seed dodecagon, it is possible to derive an unlimited number of organized complexity schemes. Figure 8b shows another example of the internal design of the seed unit that can be used to generate a completely different design scheme.

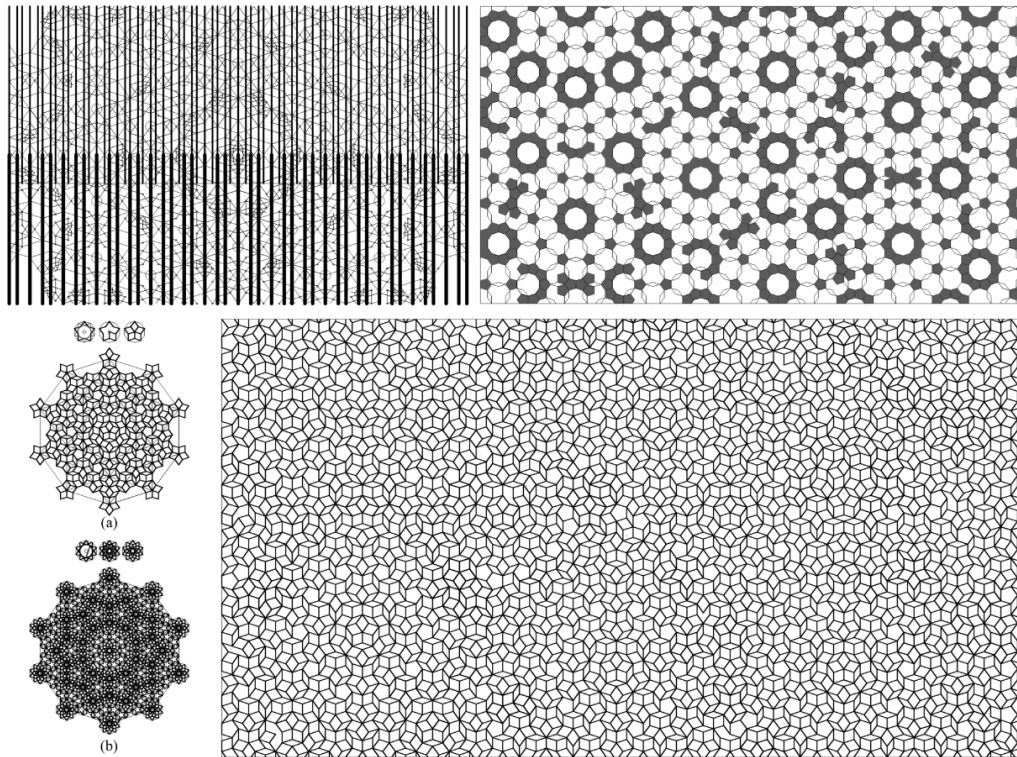

Figure 7: Three examples of organized complexity schemes derived from the 10-fold non-periodic structure in Figure 4c. (Ajlouni 2022)

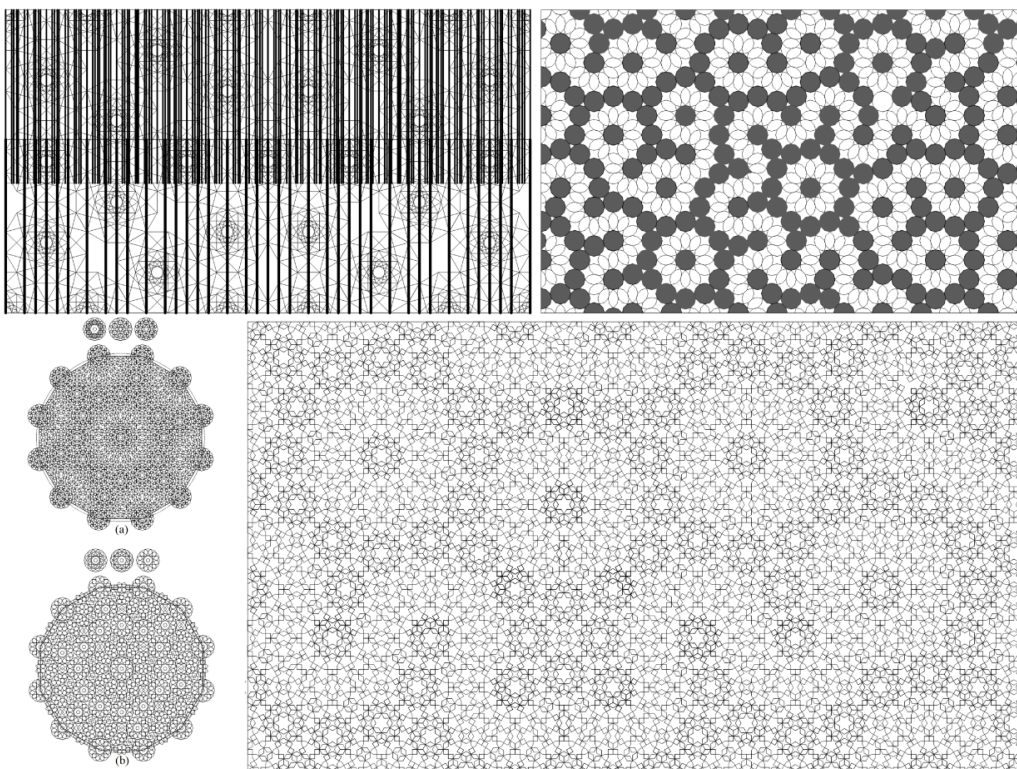

Figure 8: Three examples of organized complexity schemes derived from the 12-fold non-periodic structure in Figure 5c. (Ajlouni 2022)

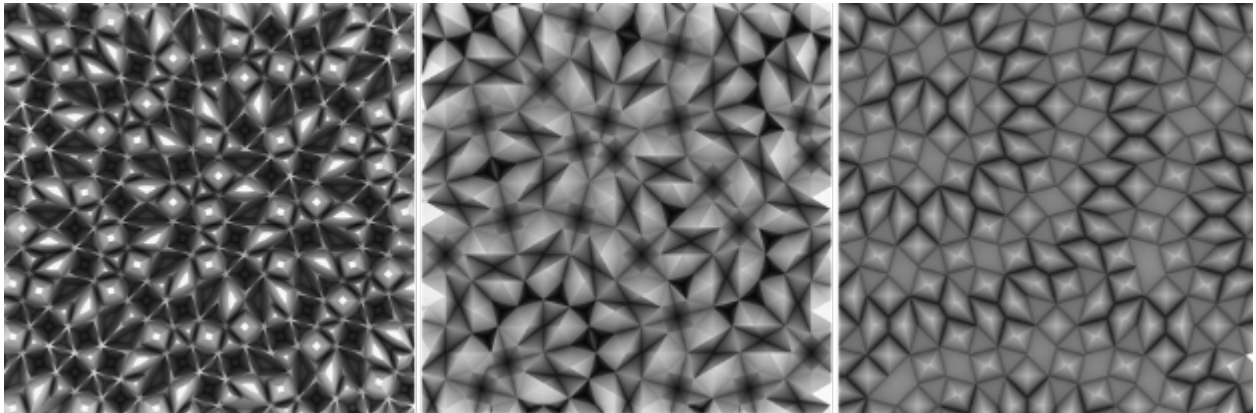

Figure 9: Examples of 3 three-dimensional surfaces derived from the organized complexity scheme of the 12-fold non-periodic structure in Figure 5c. (Ajlouni 2022)

Finally, the three examples in Figure 9 demonstrate the use of the 12-fold quasi-periodic symmetry to generate three-dimensional surface profiles based on the generalized polygonal map in Figure 5e. The ability to generate a wide variety of these complex surfaces can be widely beneficial for architectural applications.

CONCLUSION

To conclude, this paper demonstrated a methodology for generating different schemes of organized complexity by utilizing the generalized polygonal maps of 8-fold, 10-fold and 12-fold quasi-crystalline symmetries. The presented process highlights the flexibility, versatility and adaptability of using this method to generate a wide range of schemes of organized complexity that can be applied to architecture and design. By manipulating both the underlying network of nested poly-grams and the internal design of the seed polygons, an unlimited variety of possibilities can emerge. Because of their complex and unsymmetrical appearance, these schemes can satisfy the designer's need for complexity and originality while at the same time avoid schemes of randomness that can be harmful to the human condition. One of the main advantages of using these organized schemes is that they are easier to manufacture because they are based on a limited number of units. On the other hand, schemes of disorganized complexity use large number of variations that require every single part to be fabricated separately, which makes it challenging and costly to manufacture. Future research should explore the three-dimensional aspects of these complicated long-range order schemes.

REFERENCES

- Ajlouni, R. 2016. *A Contemplative Pause on the Integration of Digital Computational Thinking into Architectural Education*, in Manuel Couceiro da Costa, Filipa Roseta, Joana Pestana Lages and Susana Couceiro da Costa (eds). ARCC Architectural Research Addressing Societal Challenges. Leiden, the Netherlands: CRC Press.
- Ajlouni, R. 2017. *An ancient rule for constructing dodecagonal quasi-periodic formations*. Journal of Physics: Conference Series Volume 809 (1): <http://iopscience.iop.org/article/10.1088/1742-6596/809/1/012028/pdf>.
- Ajlouni, R. 2018. *Digital Conformity*. In Proceedings of ACSA 2018, 106th ACSA Annual Meeting. The Ethical Imperative. March 15-17, 2018. Denver, Colorado. New York: Association of Collegiate Schools of Architecture.
- Al Ajlouni, R. 2012. *The global long-range order of quasi-periodic patterns in Islamic architecture*. Acta Crystallographica A 68, 2, 235-243.
- Al Ajlouni, R. 2013. *Octagon-based quasi-crystalline formations in Islamic architecture*. In: Schmid, S., Withers, R. L., and Lifshitz, R., eds, Aperiodic Crystals, Amsterdam: Springer, 49-58.
- Bar-Hillel, M. and Wagenaar, W. A. 1991. *The Perception of Randomness*. Advances in applied mathematics 12, 428-454.
- Lu, P. J., and Steinhardt, P. J. 2007. *Decagonal and quasi-crystalline tilings in medieval Islamic architecture*. Science 315, 1106-1110.
- Makovicky, E. 1992. *800-year-old pentagonal tiling from Maragha, Iran, and the new varieties of a periodic tiling it inspired*. In: Hargittai, I. ed., Fivefold Symmetry, Singapore: World Scientific Publishing Co Pte Ltd, 67-86.
- Makovicky, E. 2007. *Comment on "decagonal and quasi-crystalline tilings in medieval Islamic architecture"*. Science 318, 1383.
- Mehaffy, M. W., and Salingeros, N. A. 2015. *The Meaning of Complexity*. In Ch 08., Design for a Living Planet: Settlement, Science, & the Human Future, 93-100. DFLAP. Levellers/Sustasis Press and Vajra Publications.
- Penrose, R. 1974. *The role of aesthetics in pure and applied mathematical research*. Bulletin of the Institute of Mathematics and Its Applications, 10, 266-271.
- Salingeros, N. A. 2015. *Adaptive vs. Random Complexity, Parts 1 and 2*. ArchNewsNow. Reprint Edition: Chapter 4 A & B in Architecture's New Scientific Foundations.

- Shechtman, D., I. Blech, Gratiias, D. and Cahn, J. W. 1984. *Metallic phase with long range orientational order and no translation symmetry*. Phys. Rev. Lett. 53(20) 1984, pp. 951-1954.
- Socolar, J., P. Steinhardt, and D. Levine. 1985. *Quasicrystals with arbitrary orientational symmetry*. Phys. Rev. B 32, 5547–5550
- Verbeeck, K. 2006. *Randomness as a Generative Principle in Art and Architecture*. Submitted to the Department of Architecture in Partial Fulfillment of the Requirements for the Degree of Master of Science in Architecture Studies at the Massachusetts Institute of Technology, June 2006.
- Yamamoto, A. and Takakura, H. 2008. *Recent development of quasicrystallography*. in Quasicrystals, T. Fujiwara and Y. Ishii, eds., Elsevier, Amsterdam, 2008.

New Urban Enclaves: The Design of Tech Campuses

Taraneh Meshkani¹

¹Kent State University, Kent, OH

ABSTRACT: Throughout history, technology has always influenced various dynamics of society, including the planning and development of our built environment. With the industrial revolution, the feudal system was transformed into industrial capitalism, which needed new infrastructures for factories and housing for workers. The advent of the automobile and a new system of motorways reshaped the urban fabric by stretching city boundaries and creating suburbia. While automobiles decentralized cities, airplanes brought them even closer, accelerating the process of globalization.

Today, the cloud and new information communication technologies (ICTs) are giving rise to new concepts, infrastructures, and spatialities. A hidden network of material systems makes information and communication possible. Fibers, cables, mobile towers, servers, and data mines are all embedded in places and leave geographic traces. However, aside from these material conditions, the ICT manifests itself in physical space through development projects like smart cities and the construction of mega tech campuses such as Apple Park, Google, Facebook, and Amazon headquarters. These new urban morphologies are typically closed off from the rest of the urban fabric and have their own infrastructures of water, energy, and transportation. Moreover, these tech enclaves often have satellite cities connected to them, and without those, they won't be able to function. One example is the dual relationship between Apple and Foxconn companies. The two companies are intertwined and heavily rely on one another. This paper aims to investigate the intersection between the research on immaterial data and the physical imprints and manifestations of ICTs.

The research methodology focuses on the literature review and study of new cases which best highlight the material manifestations of information and communication technologies, such as tech campuses, smart cities, and data centers. The results of the paper will be categorized into four main sections, including ICT infrastructures, spaces of production, data and urban management, and energy and resources.

KEYWORDS: Information and Communication Technologies, Tech Campuses, Data Centers, Smart Cities

INTRODUCTION

Today, 55% of the world's population lives in urban areas. The year 2006 became critical for this urbanism discourse since UN Habitat made a report called "The State's of the World Cities," which showed that most of the world's population is now living in cities. The world's population is expected to increase to 68% by 2050 (2018 Revision of World Urbanization Prospect). Some scholars call the phenomenon globalization of urbanization (Sassen 2001), while others, following the French urbanist, Henri Lefebvre, call it planetary urbanization (Brenner 2014).

In addition, since 2000, there have been more than five hundred cities with more than a million inhabitants. This number was less than twenty at the beginning of the century. Urbanization is happening at a new scale. There are certain cities in the world that have more than thirty million people (The World Cities in 2018). For instance, a country's population like Canada, which is a little less than thirty-eight million, is comparable with Tokyo or not a lot more than the city of Delhi.

Aside from megacities, there are patterns of thickly populated regions consisting of multiple metropolises. These regions are known as megalopolises, a term coined by Jean Gottmann (Gottmann 1984). In a research conducted by Richard Florida, twenty-nine of these mega-regions were identified (Florida 2019). The notion of economic power related only to nation-states or certain metropolitan areas does not fit the world's economic power dynamics anymore. Megaregions play a role in this dynamic. One example is Bos-Wash, which extends from Boston to New York, Philadelphia, and Washington and generates around four trillion in economic output with fifty million people. [Figure 1]

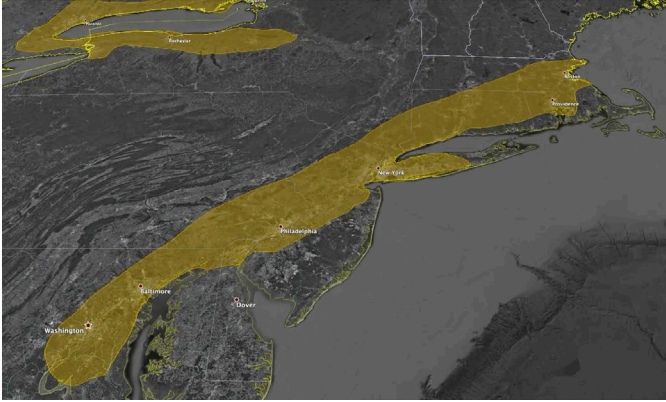

Figure 1: Bos-Wash Megalopolis. Source: (Author 2022)

On the other hand, when talking about the urban question, the dominant scale of analysis is associated with the concentric zone model of Ernest Burgess and Robert Park, founders of the Chicago School (McKenzie, Burgess & Park 1967). [Figure 2] However, these forms of urban intensification are being spatially extended, whether calling them towns, cities, or metro regions. Moreover, the link between globalization and discussions of space and territory needs to be revisited.

These new spatial conditions also link to myriad global scale issues such as questions on energy, either fossils or renewables, political and economic processes linked to the flow of capital and labor, crises such as pandemics and climate change, socio-cultural questions of immigration, diaspora or refugee crises are some examples. In all these instances, globalization should not be considered as a process of deterritorialization but as a force that reconfigures territorial and spatial problems.

One new instance of such spatial processes that are happening on a global scale is the advent of information and communication technologies and their new spaces. This paper asks the question about how do ICTs materialize at local, regional, and global scales? What are the new spatial conceptions that emerge with the rapid deployment of these technologies?

As a result, four categories of such material forms, imprints, processes, and practices of ICTs will be discussed.

THE GROWTH OF THE CITY

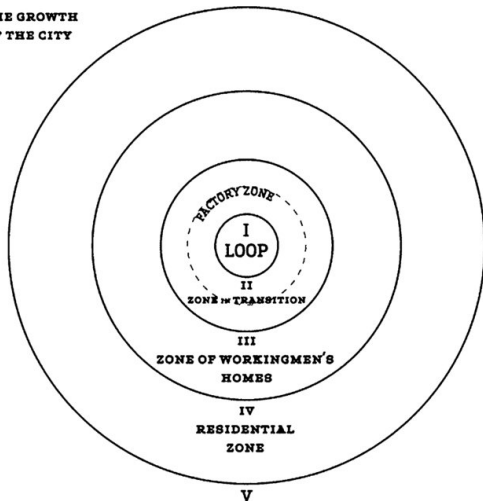

Figure 2: Concentric Zone Theory. Source: (Burgess 1925)

1.0 METHODOLOGY

This paper adopts a qualitative method of study by analyzing case studies relevant to the new spatial manifestations of information and communication technologies. By mapping some of the imprints of these cases, the paper highlights the new global spaces of ICTs. Moreover, there has been a literature review on the questions relevant to smart cities, tech campuses, urban data, and its management, among other topics.

2.0 FINDINGS

2.1. Infrastructures

A hidden network of material systems makes information and communication possible. Fibers, cables, mobile towers, servers, and data mines are all embedded in places and leave geographic traces. This view is contrary to the technologically deterministic assumptions that emerged since the 1960s in the works of Alvin Toffler, Nicholas Negroponte, and William J. Mitchell, which claimed that the flow of bits would substitute the flow of atoms. This view was questioned by many scholars, such as Stephen Graham and Saskia Sassen, who have discussed that not only the material side or cities have not disappeared, but these new networks of ICTs have created unique spatialities and have extended the city lines, even though the material bases on these technologies are not spread evenly and like other processes, are connected to flow and concentration of capital in certain geographies.

One type of ICT imprint is data centers where data backup and storage occur. Some data centers are constructed far away from downtown cores, while others are in city centers as telecom hotels. Today, approximately 8.4 million data centers with different scales exist globally.

This map illustrates the Amazon Data centers, which highlight multiple locations. [Figure 3]

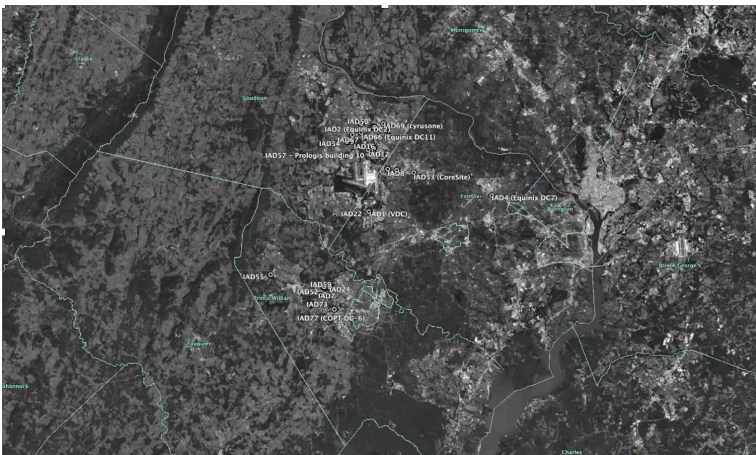

Figure 3: Amazon Data Centers in Virginia. Source: (Author 2022)

Aside from data centers, there are other infrastructures of ICTs. One common misperception is that our data is in the cloud. In fact, data travels in the oceans through hundreds of miles of submarine cables that connect continents. Companies like Microsoft, Google, Facebook, and Amazon are responsible for more than half of the world's underwater internet cables. While most users connect to the internet via WIFI and cellular services, those services will eventually connect to land services connected to underwater cables. Demand for this type of infrastructure will continue to rise as more companies utilize cloud computing.

2.2. Spaces of Production

The second category of ICT spaces is new urban enclaves that have been emerging in the past decade with the same logic as early corporate campuses and parks. These enclaves cannot function as isolated utopias. Similar to the model of a garden city by Ebenezer Howard (Howard 1898), they have satellite cities connected to them, which, without those, they won't be able to function. However, the difference between these satellite cities and Howard's is that they are not close to the main cities. One example of such an association is the dual relationship between Apple and Foxconn companies. The two companies are intertwined and heavily rely on one another. For example, apple manages inventories of core parts at Foxconn, and Apple employees are always present at the factory to ensure product quality.

While these two companies depend on one another, they each have their own facilities and create their own spaces. For example, apple Spaceship, designed by Foster and Partners, is the main headquarters of Apple, where its 12,000 employees work in Cupertino, California. On the other hand, Foxconn has multiple factories, such as the main iPhone production base, Apple City, in Zhengzhou, China.

A 60,000 sq feet of indoor dining facilities, 20,000 sq feet of outdoor dining space, and two outdoor dining cafes can feed the 12,000 Apple employees without them leaving the campus. In addition, the kitchen can serve 14,000 lunches a day, and the plan is to use as much food grown on-site as possible.

Foxconn, one of Apple's manufacturing companies in Asia, in some ways functions very similarly aside from their scale of operation. The Foxconn plant that manufactures iPhones is located on the outskirts of Zhengzhou.

Within two years, the company transformed a series of villages into a manufactory city with over 200,000 employees. Like Apple, Foxconn also provides its employees with food. Although because of the poor quality, employees tend to eat out at pop-up style food bazaars. Moreover, entertainment and housing are also provided at the site. Foxconn is one of many suppliers of Apple. There are hundreds of Apple suppliers across the world. In 2018, Foxconn announced that it would be building a manufacturing plant in Wisconsin to produce display panels. The original aim was to hire up to 13,000 workers in exchange for three billion in subsidies. However, they switched goals and are now shifting from production to data technology.

2.3. Data and Urban Management

The next spatial category deals with the ubiquity of smart city narratives and how they have become the main discussion of urban development in less than a decade. Today, we are noticing a rapid proliferation of such initiatives, many cities, including Cleveland, have proposed and adopted smart strategies for managing or planning cities. This phenomenon exists both in the global north and south.

The proposals and projects like Sidewalk Lab of Alphabet, the sister company of Google, Songdo International business district in South Korea, and Masdar City in Dubai are initiatives by private entities and corporations.

The main criticism of these projects is the involvement of specific stakeholders in collecting and managing urban data and development. In addition, many discussions consider data as a new form of capital; thus, its access and control have become essential topics.

But it is crucial to mention that the smart city is not just a discourse. As stated by David Harvey, like other grand urban visions, it needs to negotiate with spatiality and the geography of the place. ICTs infrastructures are different from the 19th and 20th century "networked city" ideals of industrialization. As stated by Antoine Picon, contrary to networked cities exclusively dealing with mastery of flows, whether related to water or transportation infrastructure, smart cities give greater importance to events on different scales (Picon 2008)

2.4. Energy and Resources

Energy and resources are an integral part of ICT technologies and have multi-scalar spatial manifestations. The future of mobility is one crucial example. Autonomous vehicles will rely on and be built on the ICT infrastructure with significant reliance on data storage and management.

All the leading mobility companies, such as Tesla, Google, and even Apple, are building electric vehicles. There appears to be no future for combustion engines. As a result, even traditional car companies like GM are shifting toward EVs.

The acceleration of climate change and the demand for sustainability are the primary drivers for the electric vehicle (EV) trend. Social climate movements are pressuring governments to set emission standards and ambitious goals. As

a result, governments are introducing incentives and subsidies to tackle their emissions output. China has set the goal of having 20% of its auto sales be hybrid or EVs by 2025. Similarly, the EU has set the goal of reducing transport emissions by 60% to 1990 levels by 2050. As a result, the EV market will be worth 20M in 2025 compared to 1M in 2017. Tesla has built a supercharger network of over 20,000 stations across the globe. [Figure 4] The intent is to allow its vehicle owners to charge their cars while crisscrossing the country. Tesla owners can use autopilot and navigate from one supercharger station to another on their route to their destination. Tesla offers free and full unlimited access to its supercharger station as an incentive for its line of electric vehicles.

The rise in demand for electric vehicles means a rise in demand for four elements that are essential to battery production. They include Lithium, Cobalt, Nickel, and Graphite. Mining operations are a major part of the electric vehicle footprint that spans the world from Chile to Congo and from Indonesia to Turkey. With the demand for such minerals, the issues of human and labor rights and environmental sustainability arise.

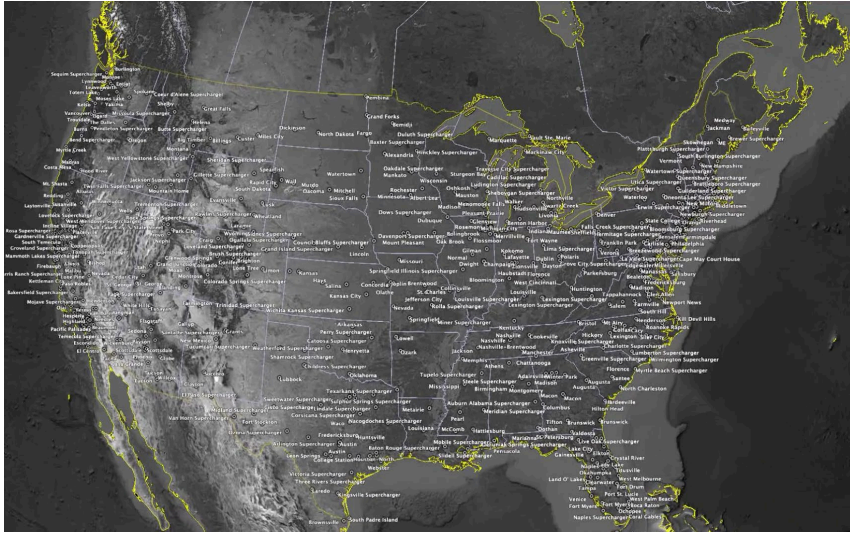

Figure 4: Tesla US supercharger network. Source: (Author 2022)

CONCLUSION

Today, we are witnessing new patterns and scales of urbanization and processes. The advent of new information and communication technologies creates new spatialities that are forming on various scales. The study of the ICT imprints such as tech campuses, data centers, and smart cities in relation to questions regarding data control, privacy and management, and ICTs energy consumption is necessary for understanding the future of cities. Moreover, the socio-spatial dimension of these technologies and questions regarding access and equality should be further investigated by designers and urban planners.

REFERENCES

- Brenner, Neil. 2014. *Implosions/explosions: Towards a Study of Planetary Urbanization*. Berlin: JOVIS.
- Florida, Richard. "The Real Powerhouses That Drive the World's Economy." *Bloomberg*, February 2019.
- Gottmann, Jean. 1964. *Megalopolis: the Urbanized Northeastern Seaboard of the United States*. Cambridge, Massachusetts: MIT Press.
- Howard, Ebenezer. *Garden cities of tomorrow*. London: Faber, 1946.
- Park, Robert Ezra, E. W. Burgess, and Roderick Duncan McKenzie. 1967. *The City*. Chicago: University of Chicago Press.
- Picon, Antoine. 2008. "Towards a City of Events. Digital Media and Urbanity." *New Geographies*, 32–43.
- Sassen, Saskia. *The global city: New york, london, tokyo*. Princeton University Press, 2013.
- "2018 Revision of World Urbanization Prospects." *United Nations*, 2018.

Parametric Study and Multi-Objective Optimization of Deployable Scissor-Like Bamboo Arch Structures

Anastasia Maurina^{1,2}, Vincent Y. Blouin³

¹Planning, Design, and Built Environment, Clemson University, Clemson, SC

²Department of Architecture, Universitas Katolik Parahyangan, Bandung, Indonesia

³School of Architecture, Clemson University, Clemson, SC

ABSTRACT: Deployable structures can be easily transported and installed as they have the ability to transform from compact configurations to predetermined layouts of various sizes and shapes. As a result, they have the great potential to be developed for post-disaster reconstruction. However, materials procurement is sometimes an issue, specifically in remote areas impacted by heavy loss of infrastructure by storms and earthquakes. Thus, developing deployable structures using local materials such as bamboo, which is widely available in tropical countries, is preferable. Most research efforts on deployable structures in architecture applications focus on design exploration of typology, geometry, and kinematics. Discourse on structural behavior and optimization is lacking and research on deployable bamboo structures is mostly limited to trial-and-error design experiments. Thus, there is inadequate knowledge on design of deployable bamboo structures, and even more on how to get optimal design.

This paper is part of the research on developing design guidelines for deployable scissor-like bamboo structures to be applied in post-disaster reconstruction, particularly in developing countries. The main goal is to allow laypeople design and build shelters by themselves by implementing proven design guidelines. The guidelines aim to provide design knowledge of deployable scissor-like bamboo arch structures, specifically on the effects of design parameters on performance, to inform designers (even laypeople) in the early stages of design to make advanced design decisions. For this paper, three specific research objectives are considered: (1) define optimal combinations of design parameters to reach the desired set of performances, (2) identify essential design principles in achieving a particular set of performances, and (3) define guidelines for designing an optimal deployable scissor-like bamboo structure.

The deployable bamboo structure considered in this study has the general shape of an arch and is made of scissor-like units, where each unit is composed of two bars connected by a pin. The structure is defined in terms of four design parameters: depth-to-span ratio, number of scissor-like units, bamboo diameter, and number of bamboo layers. Varying these design parameters results in numerous possible cases. All cases were analyzed numerically on Rhino/Grasshopper and the plugin Karamba3D for analyzing the structural behavior. A full-factorial parametric study of all possible designs was done and the entire data was transferred to MATLAB for further analysis and optimization. Three performance criteria are considered: (1) structural performance, which is the structure's ability to comply with the main structural requirements, i.e., strength and stiffness; (2) design flexibility, which is the structure's ability to generate numerous design variations in size and shape in terms of arrange-ability, expandability, configurability, and functionality; and (3) constructability, which is the structure's ability to achieve ease of construction in terms of materiality, fabricability, transportability, and install-ability. A weighted sum approach is used to compute performance score of each design and Pareto fronts are generated to extract the optimum solutions based on various tradeoff preferences. Design principle and guidelines are formulated and inform designers on how to achieve the best possible deployable scissor-like bamboo arch structures.

KEYWORDS: deployable bamboo structures, parametric study, multi-objective optimization, flexibility, constructability

INTRODUCTION

Deployable structures can be easily transported and installed as they have the ability to transform from a compact to a predetermined configuration. A scissor-like structure, which consists of two bars connected with a pin, is the most common mechanism for deployable structures. In terms of transportability (i.e., light and compact) and installability (i.e., quick and easy), deployable scissor-like structures have a great potential to be developed for post-disaster reconstruction even for a remote area, which has limited or zero access to experts (Mira et al. 2014; Merchan 1987; Farrokhsiar et al. 2020). Additionally, the structure's transformability provides design flexibility, which is the ability to generate more than one predetermined configuration of various spans and shapes, allowing the structure to be adapted to different site conditions and various building functions. Several researchers and designers explored the design of deployable structures for post-disaster reconstruction; however, most are developed using industrialized materials and customized fabrication. Despite their benefit in transformability, transportability, and installability, critical challenges with deployable structures are (1) materials procurement, specifically in remote areas impacted by heavy loss of infrastructure during a disaster, and (2) the availability of skilled labor (Farrokhsiar et al. 2020). Therefore, developing deployable structures using local materials and appropriate technology is preferable. In this study, bamboo is chosen as the main structural material because of its wide availability, especially in tropical countries, which happen to be in

many developing countries where skilled labor is also missing. Developing deployable scissor-like bamboo structures needs to consider laypeople as designers and builders with limited expert intervention. Unfortunately, most research on deployable structures in architecture applications focuses on the design exploration of typology, geometry, and kinematics. Discourse on the performance and optimization of deployable structures is lacking, and research on deployable bamboo structures is mainly limited to trial-and-error design experiments. Thus, there is inadequate knowledge on designing deployable bamboo structures (and even more on getting optimal designs) that laypeople can use to design and build structures by themselves. A comprehensive study on deployable scissor-like bamboo structures is needed to generate design principles and develop design guidelines, especially in defining design parameters and performance of the structures. Due to limited projects in the practical realm, a parametric study can help simulate a large number of cases with various combinations of design parameters and compute their performances. In this study, four design parameters and three main performances are considered. The design parameters are depth-to-span ratio, number of scissor-like units, bamboo diameter, and number of bamboo layers. The three main performances are structural performance, design flexibility, and constructability. A multi-objective optimization approach is used to identify optimal solutions. Based on this study, design principles and guidelines are generated to help designers make informed design decision in the early stages of the design process, which is very beneficial.

This paper is part of the research on developing design guidelines for deployable scissor-like bamboo structures to be applied in post-disaster reconstruction, particularly in developing countries. The main goal is to allow laypeople to design and build shelters by themselves. The guidelines aim to provide design knowledge of deployable scissor-like bamboo arch structures, specifically on the effects of design parameters on performance, to inform designers in the early stages of design. For this paper, three specific research objectives are considered: (1) define optimal combinations of design parameters to reach desired performances, (2) identify design principles for achieving performances, and (3) define design guidelines for designing an optimal deployable scissor-like bamboo structure.

1.0 LITERATURE REVIEW

1.1. Deployable scissor-like structures for post-disaster reconstruction

Deployable structures have been developed for certain situations, one of them is as a construction method in post-disaster reconstruction for their suitability in remote areas that possibly lack skilled labor (Merchan 1987). Hoberman and Davis (2010) developed and patented a deployable shelter with self-locking mechanism for military use and crisis relief, called Rapidly Deployable Shelter (RDS). Instead of focusing only on typical deployable structures with industrialized materials, researchers added value, such as reconfigurability using parallelogram mechanisms (Ataer 2014) and using local materials (Farrokhsiar et al. 2020). Farrokhsiar et al. (2020) utilized local materials to increase usability in various areas and circumstances.

1.2. Deployable bamboo structures

Using bamboo as a material for deployable structures is not common in the realm of applications and research. Moreover, all research on deployable bamboo structures focuses on design exploration of geometric, kinematic, and joinery. Some researchers explored single-layer surface deployable structures, known as pantographic structures, using a flexible connection (Seixas et al. 2014; 2017; 2021). Maurina et al. developed a reconfigurable deployable structure and also experimented with other geometries, such as cylindrical/hyperbolic deployable structures, reconfigurable pantographic structures, spatial deployable structures, and reciprocal deployable structures (Maurina and Prastyatama 2019; Charnele and Maurina 2020; Dwiana and Maurina 2019). Torres (2019) tested different materials, including bamboo, for a deployable bamboo dome. Overall, structural analysis and optimization of deployable bamboo structures are rarely discussed, and no design principles and guidelines have been discoursed.

1.3. Parametric study and optimization of deployable structures

Parametric study using generative algorithm modeling, Rhino/Grasshopper, are widely used among researchers to generate geometry and compute specific performances, such as strength, deflection, and weight, by using an additional plugins, i.e., Karamba3D (Mira et al. 2015; Arnouts et al. 2020; Akgün et al. 2020). Most researchers focus on particular shape of deployable structures, such as planar (2D) beam (Akgün et al 2020), planar (2D) arch shape (Mira et al. 2015), spatial (3D) unit (Arnouts et al. 2020), and double layer plate / barrel vault / dome (Salar et al. 2019; Dragoljevic et al. 2021). The main objective of a parametric study is to find the effect of design parameters to performances, mostly focused on structural performance (strength and stiffness) and weight. The design parameters, which are frequently studied, are the different geometry of scissor-like elements (SLE) either unit-based (polar, translational, and angulated) or loop-based (parallelogram, rhombus, kite and dart loops); height-to-span ratio of SLE units; number of SLE units in a structure; and cross-section of each SLE beam (Mira et al. 2015; Arnouts et al. 2020; Akgün et al. 2020; Maden et al. 2019). Materials take an important place in those studies. Some research focus on one type of material, such as steel, and other research (Akgün et al. 2020) focus on comparing two or more materials, such as steel versus aluminum. The discussion on performance such as strength, stiffness, and mass, is limited. However, other performances, such as expandability, fabrication process and duration, compact size, installation process and duration, are of general interest. There are several optimization techniques that have been applied to identify optimum solutions for deployable scissor-like structures and achieve some particular performance. Moy et al. (2022) stated that Genetic Algorithm (GA) and Nondominated Sorting Genetic Algorithm II (NSGA-II) are commonly used to optimize deployable structures. Multi-Objective of Colliding Bodies Optimization (MOCBO) can give different and a wider range of solutions (Moy et al. 2022). It cannot be proven, however, that these techniques give the absolute optimum solution. Thus, in this study, a full

factorial experiment is conducted using generative algorithm modeling, and Pareto solutions are extracted from the whole data set.

2.0 METHODOLOGY

2.1. Design Parameters and Performance Scores

The deployable bamboo structure considered in this study has the shape of an arch and is made of scissor-like elements (i.e., SLE units), where each unit is composed of two bars connected by a pin, as shown in Figure 1. The arch shape is a self-standing structure that can integrate walls and roofs into a single element (Farrokhsiar et al. 2020). Moreover, it has a higher percentage of usable area than other self-standing structures, such as triangular shapes (Mira et al. 2014). The arch shape in this study has an 8-meters (26 feet 3 inches) span and 4 meters (13 feet 1 ½ inch) height. The structure is defined in terms of four design parameters: depth-to-span ratio, number of scissor-like element (SLE) units, bamboo diameter, and number of bamboo layers. Varying these design parameters results in numerous possible cases. Table 1 describes each design parameter's range and the number of levels, resulting in the number of cases to simulate being 20,736. Note that, for convenience, X1 is defined as the denominator of the depth-to-span ratio. For instance, for X1 = 4, the depth-to-span ratio corresponds to 1/4, which is 0.25.

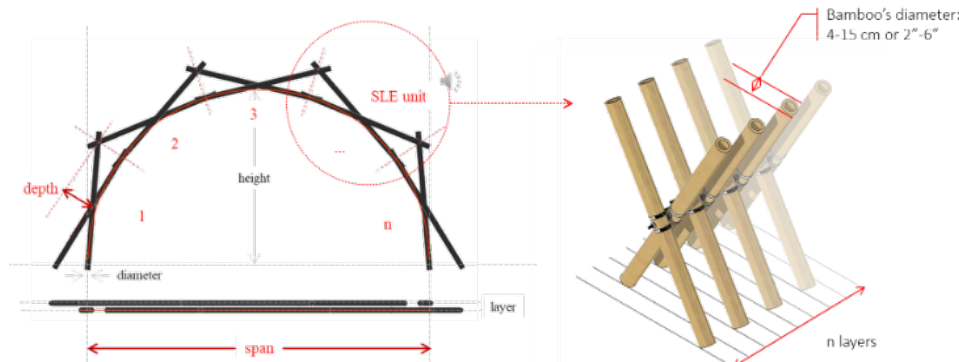

Figure 7: Arch deployable structure defined by depth-to-span ratio, number of scissor-like elements (i.e., SLE units), bamboo diameter, and number of bamboo layers (i.e., n layers). Source: (Author 2022)

Table 10: Range and number of levels of each of the four design parameters

Design parameters	Lower limit	Steps	Upper limit	Number of levels
X1: Depth-to-span ratio (denominator value)	4	1	15	12
X2: Number of SLE units	4	1	15	12
X3: Bamboo diameter (cm)	4	1	15	12
X4: number of bamboo layers	2	1	13	12

Three performance criteria are considered: (1) structural performance, which is the structure's ability to comply with the main structural requirements; (2) design flexibility, which is the structure's ability to generate numerous design variations in size and shape; and (3) constructability, which is the structure's ability to achieve ease of construction. The three performance criteria are defined by a total of fifteen (15) measures: structural performance has two measures (S1-S2), design flexibility has four measures (F1-F4), and constructability has nine measures (C1-C9), which are:

1. Safety factor (S1), calculated using the Modified-1 Mohr failure theory (Hosford, 2009);
2. Deflection percentage (S2), a percentage of deflection-to-span ratio due to a load specified by code;
3. Arrangeability (F1), a number of possible formal arrangements, i.e., centralized, linear, and/or cantilever;
4. Expandability (F2), a ratio between the range of span (defined as maximum span minus minimum span) and the average span (defined as maximum span plus minimum span divided by two) as a percentage;
5. Reconfigurability (F3), a number of degrees of freedom minus the degrees of freedom at the footing pedestal.
6. Space-usability (F4), a ratio between range of the usable width (with at least 3-meters or 10 feet vertical clearance) and the initial span (in this study, the initial span is 8-meters or 26 feet 3 inches);
7. Material efficiency (C1), percentage of bamboo used per unit length of available bamboo (in this study, the available bamboo in market has 6-meter or 20 feet long);
8. Joinery complexity (C2), a number of degrees of freedom of the most complex connection among all connections in a structural module;
9. Modularity (C3), a ratio of the number of bar variants and connection variants in the structural module and the number of SLE units;
10. Fabrication time (C4), a sum of the total duration for measuring, coding, cutting, and drilling bamboo poles, assembling connections, and assembling the structural module;
11. Fabrication process (C5), a score reflecting the required tools (the highest score for handy tools, the middle score for power tools, and the lowest score for professional tools) and the method of assembly (the highest score for horizontal on the ground, the lowest score for vertical 3D assembly);

12. Weight (C6), the weight of the structural module;
13. Compactness (C7), the sum of the length, width, and height of the compacted module;
14. Erection time (C8), a sum of the duration of erecting the structural module (or sections when applicable) on the footings and joining the sections; and
15. Installation process (C9), a sum of the scores reflecting the required tools (high score for handy tools, middle score for power tools, and low score for professional tools) and the number of steps of the assembly method.

Each measure is normalized. Then the performance score for each performance (structural performance, S_i^{score} , flexibility score, F_i^{score} , and the constructability score C_i^{score}) is calculated using a weighted sum defined in equation [1].

$$S_i^{score} = \sum_{j=1}^2 w_{Sj} s_{ij} ; F_i^{score} = \sum_{j=1}^4 w_{Fj} f_{ij} ; C_i^{score} = \sum_{j=1}^9 w_{Cj} c_{ij} \quad [1]$$

where w_{Sj} is a relative weight of importance of the measure S_j for structural performance; w_{Fj} is a relative weight of importance of the measure F_j for flexibility; and w_{Cj} is a relative weight of importance of the measure C_j for constructability. The sum of all relative weights is equal to 1.0 for all measures. s_{ij} , f_{ij} , and c_{ij} are the normalized measures associated with structural performance, flexibility, and constructability, respectively, for case i .

2.2. Parametric Study

A parametric study is conducted by varying design parameters, presented in Table 1, using a full factorial approach. Rhino/Grasshopper is used to analyze geometrically and numerically each performance. A plugin, Karamba3D, is used to analyze structural performance, while algorithms for design flexibility and constructability were written based on defined measures, as described in 3.1, and previous constructed prototype (Maurina and Blouin 2022). The Grasshopper framework, shown in Figure 2, includes three stages: (1) geometrical modeling based on design parameters; (2) computing of all performance measures; and (3) normalizing and calculating each performance score. All simulated data corresponding to a predefined set of parametric values is recorded and transferred to MATLAB to be analyzed further with a correlation analysis, a frequency analysis, and multi-objective optimization.

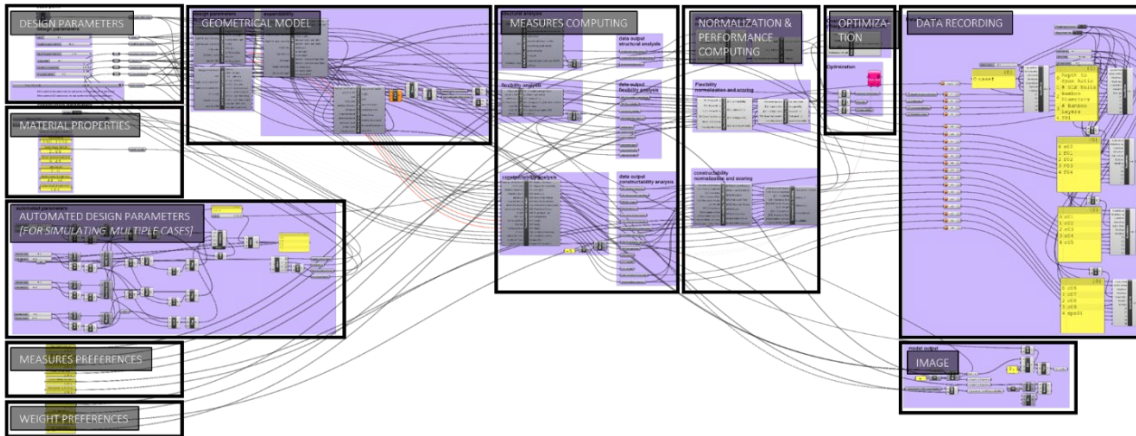

Figure 8: Grasshopper Algorithm Model. Source: (Author 2023)

2.3. Multi-Objective Optimization

All 20,736 simulated cases (X) are filtered to retain only the cases that comply with the structural performance requirements, i.e., the safety factor (as defined by the ratio of the material’s strength to the greatest stress value within the structure) has to be equal to or greater than one, and the greatest deflection value within the structure is not more than 0.33 percent of the structural span. Through this filter, only 2,841 cases are retained (x^*). Based on the objectives, the performance scores of these compliant cases are plotted to define a Pareto front, i.e., the set of non-dominated solutions, also called “best tradeoff solutions”. Three optimization scenarios are considered. In the list below, the “excessiveness of structural performance” refers to the possibility of over-designing a structure. On the one hand, a structure should be sufficiently strong and stiff to satisfy the structural requirements. On the other hand, it should not be so strong that it ends up being unnecessarily over-designed. Therefore, it is generally desired to minimize the excessiveness of structural performance.

1. maximize flexibility and minimize excessiveness of structural performance (see equation 2),
2. maximize constructability and minimize excessiveness of structural performance (see equation 3), and
3. maximize constructability and maximize flexibility (see equation 4).

$$F_i^{score}(x^j) > F_i^{score}(x^*) \text{ and } S_i^{score}(x^j) < S_i^{score}(x^*), \text{ for all } j \in \{1,2, \dots, 2841\} \quad [2]$$

$$C_i^{score}(x^j) > C_i^{score}(x^*) \text{ and } S_i^{score}(x^j) < S_i^{score}(x^*), \text{ for all } j \in \{1,2, \dots, 2841\} \quad [3]$$

$$F_i^{score}(x^j) > F_i^{score}(x^*) \text{ and } C_i^{score}(x^j) > C_i^{score}(x^*), \text{ for all } j \in \{1,2, \dots, 2841\} \quad [4]$$

3.0 RESULTS AND DISCUSSION

3.1. Trade-off between Performances

All 2,841 feasible cases are plotted pairwise: (1) structural performance and flexibility; (2) structural performance and constructability; and (3) flexibility and constructability, as shown in Figure 3. Those figures show that an increase in structural performance tends to be complemented by a greater increase in flexibility than a decrease in constructability. A correlation coefficient is calculated to quantify the tradeoff among performances: (1) Structural performance and flexibility have a medium positive correlation, with a 0.40 correlation coefficient; (2) Structural performance and constructability have a medium negative correlation, with a -0.44 correlation coefficient; and (3) Flexibility and constructability have a weak negative correlation, with a -0.14 correlation coefficient.

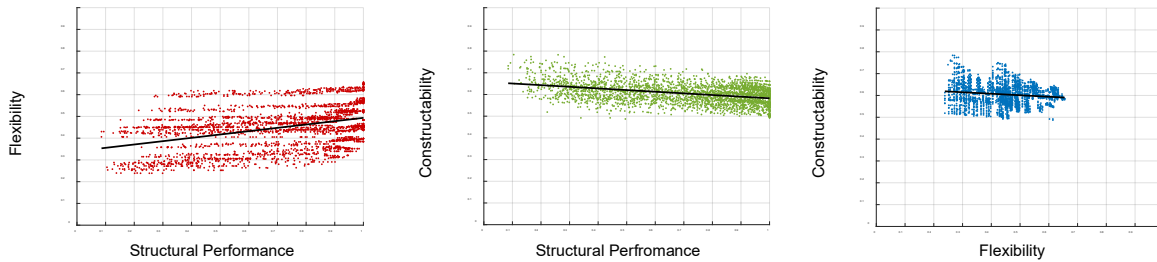

Figure 9: Tradeoff between performances: Structural Performance & Flexibility (left), Structural Performance & Constructability (center), and Flexibility & Constructability (right). Source: (Author 2023)

3.2. Significance of Design Parameters to Performances

Based on Pearson's correlation coefficient analysis, the most significant design parameter linearly affecting performance is the number of bamboo layers, with a 0.59, 0.41, -0.57 correlation coefficient with structural performance, flexibility, and constructability, respectively. Diameter bamboo affects structural performance moderately with a correlation coefficient of 0.31. The other two design parameters (depth-to-span ratio and number of SLE units) are indicated to have a very weak correlation to any performance but are significantly correlated. So, the correlation between the depth-to-span ratio and the number of SLE units to any performance is not linear or depends on the value of other design parameters.

3.3. Feasible Range of Design Parameters

In order to facilitate the design process for layman people, it would be helpful to know the ranges of design parameter values that have the most feasible cases. This would provide a guideline for quickly selecting design parameters. In Figure 4 (a), the horizontal axis is the reciprocal of the depth-to-span ratio ranging from 4 to 15, and the vertical axis is the percentage of cases among all 20,736 cases that satisfy the structural performance requirements for a given depth-to-span ratio. For instance, 41% of all cases that have a reciprocal of the depth-to-span ratio of 15 satisfy the structural performance requirements, while only 7% of all cases that have a reciprocal of the depth-to-span ratio of 4 satisfy the structural performance requirements. Figures 4 (b) and (c) correspond to the design parameters number of SLE units and bamboo diameter. Figure 4 (d) is slightly different since the horizontal axis is the bamboo diameter and the vertical axis is the minimum number of bamboo layers. For instance, for a bamboo diameter of 7 cm, at least 11 layers of bamboo are necessary to meet the structural performance requirements. The graphs are also color coded to show five zones. The zones are divided based on quantile percentages (i.e., quantile 1, quantile 2, quantile 3 are the limits between zones green, light green, yellow, and orange), and the red zone corresponds to the set of parameters for which no feasible design exist. In the green zone, 95.8% of these cases meet the structural performance requirements. Similarly, in the light green, yellow, and orange zones, 82.3%, 47.2%, and 26.3% meet the structural performance requirements.

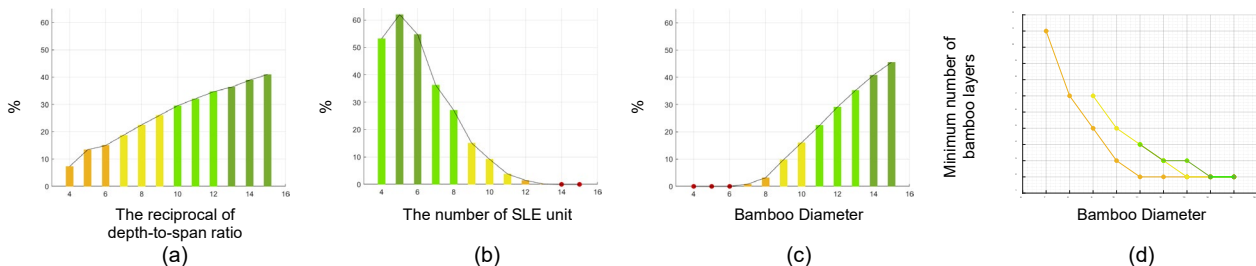

Figure 10: Percentage of cases that comply with structural performance in terms of (a) the reciprocal of the depth-to-span ratio, (b) the number of SLE units, (c) bamboo diameter; and (d) minimum number of bamboo layers for each bamboo diameter (d). Source: (Author 2023)

Table 11: Design Parameters' Range

	<i>Red zone</i>	<i>Orange zone</i>	<i>Yellow zone</i>	<i>Light green zone</i>	<i>Green zone</i>
Depth-to-span ratio		1/4-1/6	1/7-1/9	1/10-1/12	1/13-1/15
Number of SLEs	14-15	12-13	7-11	4, 8	5-6
Bamboo diameter (cm)*	4-6	7-15	9-15	11-15	14-15
Minimum number of layers		Min.2-11	Min.2-7	Min.2-4	Min.2

3.4. Scenario Optimization 1: Max. Flexibility and Min. Excessiveness of Structural Performance

The Pareto front for scenario 1 is shown in Figure 5 (a). The 75 optimal solutions of this Pareto front are the best tradeoff solutions among the 2,841 feasible designs. They are grouped based on the tradeoff between performances: (1) the green group exhibit considerable flexibility with less excessiveness of structural performance; (2) the blue group exhibit moderate flexibility and excessiveness; and (3) the red zone exhibit high flexibility. The combination of design parameters of each group is shown in Figure 5 (b-d).

3.5. Scenario Optimization 2: Max. Constructability and Min. Excessiveness of Structural Performance

The Pareto front set for this scenario is shown in Figure 6 (a). There are only two optimal solutions for this scenario, described in Table 3. The combination of design parameter of each group is shown in Figure 6 (b).

3.6. Scenario Optimization 3: Maximum Flexibility and Maximum Constructability

The Pareto front for scenario 3 is shown in Figure 7 (a). There are 46 optimal solutions, which are grouped based on the tradeoff between performance: (1) blue group, high constructability with considerable flexibility; (2) green group, moderate tradeoff between flexibility and constructability; and (3) magenta group, high flexibility with considerable constructability. The combination of design parameters of each group is shown in Figure 7 (b-d). In the figures labelled (b) to (d), the four vertical axes correspond to the depth-to-span ratio, number of SLE units, bamboo diameter, and number of bamboo layers, respectively.

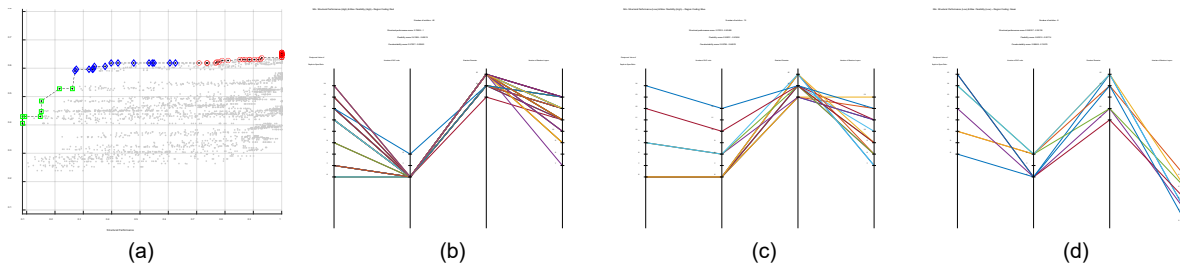

Figure 11: Scenario 1: (a) Pareto front and optimum combination of design parameters: (b) red, (c) blue, and (d) green region. Source: (Author 2023)

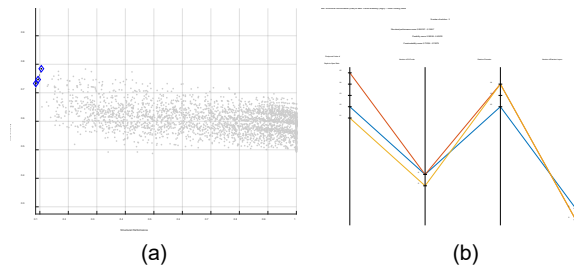

Figure 12: Scenario 2: (a) Pareto front and (b) optimum combination of design parameter. Source: (Author 2023)

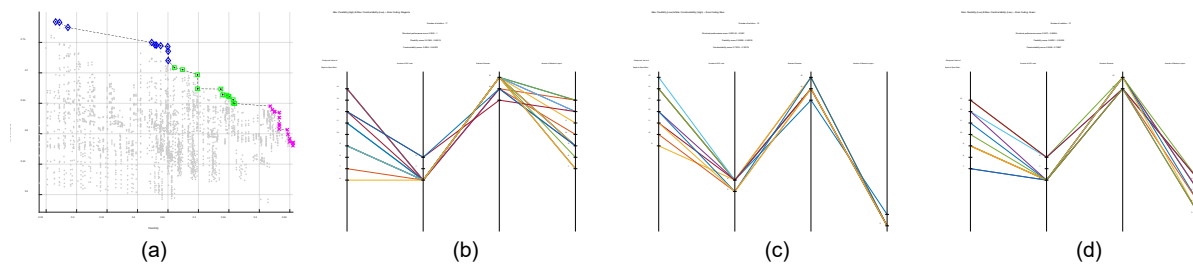

Figure 13: Scenario 3: (a) Pareto front and (b) optimum combination of design parameters: (b) magenta, (c) blue, and (d) green region. Source: (Author 2023)

4.0 APPLICATION

4.1. Design Principles

According to the results of the correlation analysis and optimization, three design principles can be concluded:

1. Increasing structural performance tends to increase flexibility and decrease constructability. Thus, there is a tradeoff between flexibility and constructability.
2. The most significant design parameter linearly affecting performance is the number of bamboo layers, then bamboo diameter. While the depth-to-span ratio and the number of SLE units affect performance significantly but not linearly.
3. The range of design parameters and rules-of-thumb are described in Table 6. Optimum combinations of design parameters are shown in sections 4.4 – 4.6.

Table 12: Range of Design Parameters and Rules-of-Thumb

	Possible Ranges	Preferred ranges	Pairwise Objective		
			Scenario #1	Scenario #2	Scenario #3
X1. Depth-to-span ratio	1/4 – 1/15	1/9 – 1/15	1/9 – 1/15	1/12 – 1/15	1/9 – 1/15
X2. Number of SLE units	4 – 13	4 – 8	5-8	5	5-8
X3. Bamboo diameter (X4. Number of bamboo layers)	7-15 cm (2-11 layers)	12 – 15 cm (min. 2 layers)	12-15 (4-13 layers)	12-13 (4 layers)	12-15 (4-13 layers)
Rules of Thumbs of bamboo diameter-to-span ratio		1/67 (min. 2 layers)	1/67 (min. 4 layers)	1/67 (min. 4 layers)	1/67 (min. 4 layers)

4.2. Design Guidelines on Defining Design Parameters

The following step-by-step procedure can help select the design parameters to achieve specific performance objectives:

Step 1: Set the performance objectives based on design circumstances: (a) maximize flexibility and minimize excessiveness of structural performance – constructability is ignored; (b) maximize constructability and minimize excessiveness of structural performance – flexibility is ignored; (c) maximize constructability and maximize flexibility – excessiveness of structural performance is ignored.

Step 2: Decide the trade-off group among the optimum solutions for specific objective (see Figure 5 - Figure 8).

Step 3: Choose one combination (colour-wise) of design parameters.

4.3. Examples

Design exercise 1. A large number of emergency shelters are needed in a very short period of time. Constructability becomes the main objective in this situation. Thus, due to a goal of maximizing constructability and minimizing excessiveness of structural performance (see Figure 6 (b)) and a consideration of available bamboo dimensions, a deployable arch is formed with a 1/11 depth-to-span ratio (a 67 cm depth), five SLE units, and two layers of 14 cm bamboo poles. A structural module and arrangement of several modules are depicted in Figure 8. Based on simulation generated in Rhino/Grasshopper, the measures of this module’s performance are: (1) safety factor: 1.56, (2) deflection-to-span ratio: 0.0054, (3) number of arrangements: 1, (4) Expandability: 10.84 (8.00 – 9.3 meters), (5) Reconfigurability: 0, (6) Space-usability: 81 %, (7) Bamboo Efficiency: 100, (8) Joinery complexity: 2, (9) Modularity: 0.2, (10) Fabrication duration: 160 minutes, (11) Fabrication process: 0.75, (12) Weight: 116 kg, (13) Compactness: 4.4 meter, (14) Installation time: 25 minutes, and (15) installation process: 0.1875.

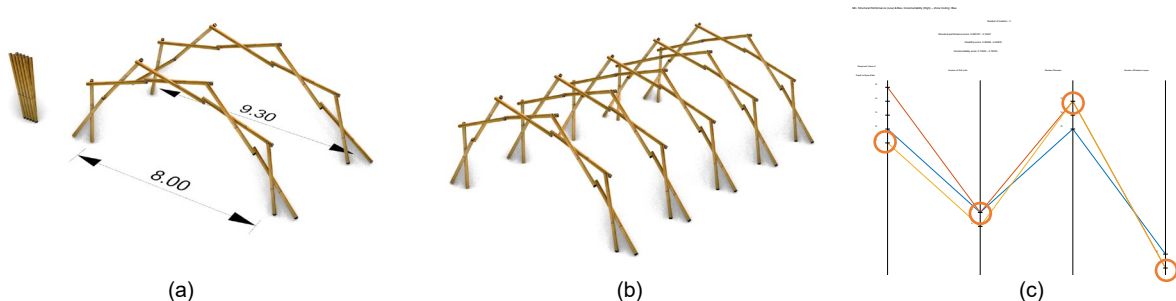

Figure 14: Design Exercise 1: (a) Structural Module, (b) Linear Arrangement, (c) and Graph from Figure 6.b. Source: (Author 2023)

Design exercise 2. Transitional shelters are needed to facilitate various building functions in different land sizes. Design flexibility becomes the main objective in this situation. Thus, due to a goal of maximizing flexibility and maximizing constructability (see Figure 7(d)) and a consideration of available bamboo dimensions, a deployable arch is formed with a 1/12 depth-to-span ratio (a 80 cm depth), eight SLE units, and four layers of 15 cm bamboo poles. A structural module and arrangement of several modules are depicted in Figure 9. Based on simulation generated in Rhino/Grasshopper, the measures of this module’s performance are: (1) safety factor: 1.91, (2) deflection-to-span ratio:

0.0055, (3) number of arrangements: 3, (4) Expandability: 41.86 (4.70 – 8.00 meters), (5) Reconfigurability: 0, (6) Space-usability: 81 %, (7) Bamboo Efficiency: 70, (8) Joinery complexity: 2, (9) Modularity: 0.0625, (10) Fabrication duration: 513 minutes, (11) Fabrication process: 0.75, (12) Weight: 295 kg, (13) Compactness: 4.5 meter, (14) Installation time: 25 minutes, and (15) installation process: 0.1875.

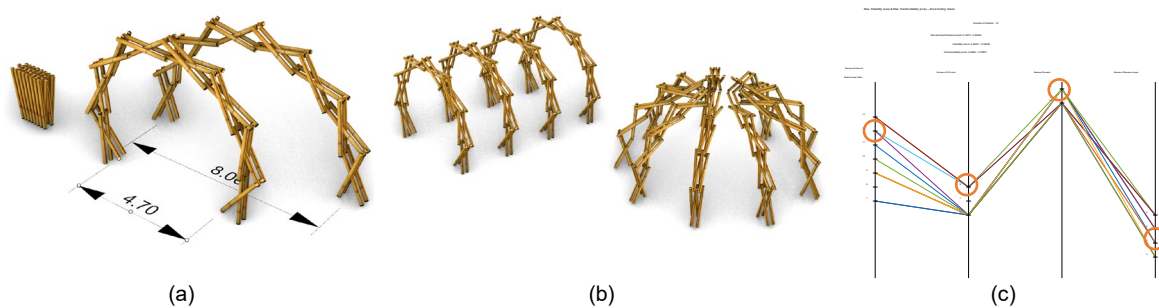

Figure 15: Design Exercise 2: (a) Structural Module, (b) Linear and Centralized Arrangement, (c) and Graph from Figure 7-d.
Source: (Author 2023)

CONCLUSION

Design parameters of deployable scissor-like bamboo arch structures, complying with structural performance, can be narrowed down by parametric study. The combination of design parameters can be precisely defined for particular objectives (structural performance, flexibility, and/or constructability) by multi-objective optimization. Designers and/or laypeople, as co-designers, are expected to be able to utilize the generated design principles and design guidelines as demonstrated through two examples. The complexity of multi-measures (fifteen measures for three performances) can be lessened by calculating the performance score using the weighted-sum approach. Then, the Pareto front is generated based on three primary performances. However, using the weighted-sum approach, user or research preference takes part in defining the weight of each measure, which can lead to a different result. Those preferences can be customized using the provided algorithm in Rhino/Grasshopper and MATLAB, which allows designers or researchers to reconstruct geometrically and numerically with different preferences. This research results expand the discourse on the performances of deployable scissor-like arch structures and the useability of the structures using local materials. This research, which focuses on arch shapes consisting of typical SLE units, can be extended by using different shapes (either planar/2D or spatial/3D), different types of SLE units (e.g., reconfigurable SLE units), and comparing with other materials (e.g., steel and/or aluminum).

ACKNOWLEDGEMENTS

This paper is a part of a dissertation research conducted at Clemson University, and financially supported by Universitas Katolik Parahyangan, Fulbright, Philanthropic Education Organization (PEO), and Association of American University Women (AAUW). Moreover, the participation of the main author at the ARCC conference is partially funded by the Graduate Travel Grant (GTG) from the Graduate Student Government (GSG) at Clemson University and the ARCC Graduate Student Scholarship.

REFERENCES

- Akgün, Yenal, Feray Maden, and Erinc Yıldırım. 2020. "Weight and Material Optimization of Scissor-Hinge Linkages According to Given Span Length." *Procedia Manufacturing*, The 1st International Conference on Optimization-Driven Architectural Design (OPTARCH 2019), 44 (January): 387–93.
- Alegria Mira, L., R. Filomeno Coelho, A. P. Thrall, and N. De Temmerman. 2015. "Parametric Evaluation of Deployable Scissor Arches." *Engineering Structures* 99 (September): 479–91.
- Alegria Mira, Lara, Ashley P. Thrall, and Niels De Temmerman. 2014. "Deployable Scissor Arch for Transitional Shelters." *Automation in Construction* 43 (July): 123–31.
- Arnouts, L. I. W., T. J. Massart, N. De Temmerman, and P. Z. Berke. 2020. "Multi-Objective Optimisation of Deployable Bistable Scissor Structures." *Automation in Construction* 114 (June): 103154.
- Ataer, Fulya. 2014. "Design of a Reconfigurable Deployable Structure for Post Disaster Housing." M.Sc., Turkey: Izmir Institute of Technology (Turkey).
- Charnele, Charnele, and Anastasia Maurina. 2020. "Eksplorasi Konstruksi Bambu Reciprocal-Deployable Gridshell." *Riset Arsitektur (RISA)* 4 (03): 205–33.
- Dragoljevic, Milan, Salvatore Viscuso, and Alessandra Zanelli. 2021. "Data-Driven Design of Deployable Structures: Literature Review and Multi-Criteria Optimization Approach." *Curved and Layered Structures* 8 (1): 241–58.
- Dwiana, Yosafat Bakti, and Anastasia Maurina. 2019. "Modular Bamboo Structure Design Exploration with Deployable Construction System." *Riset Arsitektur (RISA)* 3 (04): 381–97.
- Farrokhsiar, Paniz, Homeira Mirhosseini, and A Saeedfar. 2020. *Proposing A Deployable Post-Disaster Modular Temporary Shelter Using Vernacular Materials*.
- Hernández Merchan, Carlos Henrique. 1987. "Deployable Structures." Massachusetts Institute of Technology.

- Hoberman, Charles, and Davis, Matthew. 2010. Synchronized Four-Bar Linkages (US-7644721-B2). U.S. Patent and Trademark Office.
- Maden, Feray, Y. Akgün, G. Kiper, Ş. Gür, M. Yar, and K. Korkmaz. 2019. "A Critical Review on Classification and Terminology of Scissor Structures." *Int. Assoc. for Shell and Spatial Structures* 60(1): 47–64.
- Maurina, Anastasia, and Vincent Blouin. 2022. "Modular Deployable Bamboo Structures: Enabling User Participation to Self-Design-and-Build in Developing Countries." Presented at the Environmental Design Research Association (EDRA) 53 Conference, Greenville, South Carolina, June 2.
- Maurina, Anastasia, and Budianastas Prastyatama. 2019. "Bamboo Deployable Structural Systems: An Exploration Study in Responding to Rapid Alteration Challenges." In *18th International Conference on Sustainable Environment and Architecture (SENVAR 2018)*, 56–64. Atlantis Press.
- Moy, Jian Jun, Cher Siang Tan, Shahrin Mohammad, and Ahmad Razin Zainal Abidin. 2022. "State-of-Art Review on Deployable Scissor Structure in Construction." *Structures* 42 (August): 160–80.
- Salar, M., M. R. Ghasemi, and B. Dizangian. 2019. "Practical Optimization of Deployable and Scissor-like Structures Using a Fast GA Method." *Frontiers of Structural and Civil Engineering* 13 (3): 557–68.
- Seixas, Mario Augusto, José Luiz Mendes Ripper, and Khosrow Ghavami. 2014. "Prefabricated Bamboo Structure and Textile Canvas Pavilions." *Proceedings of IASS Annual Symposia* 2014 (1): 1–12.
- Seixas, Mario, João Bina, Patrick Stoffel, José Luiz Ripper, Luís E. Moreira, and Khosrow Ghavami. 2017. "Active Bending and Tensile Pantographic Bamboo Hybrid Amphitheater Structure." *Journal of the International Association for Shell and Spatial Structures* 58 (3): 239–52.
- Seixas, Mario, Luís E. Moreira, Patrick Stoffel, and João Bina. 2021. "Form Finding and Analysis of an Active Bending-Pantographic Bamboo Space Structure." *Int. Assoc. for Shell and Spatial Structures* 62(3): 206–22.
- Torres, Natalia, Eliana Cortes-Paez, Ramon Sastre, Xavier Gimferrer, Francisco Intriari, and Isaac González. "Deployable bamboo dome." In *Proceedings of IASS Annual Symposia*, vol. 2019, no. 5, pp. 1-10. International Association for Shell and Spatial Structures (IASS), 2019.
- William F. Hosford, *Mechanical Behavior of Materials*, 2nd Ed., 2009, Cambridge University Press.

Performance Assessment of a Multifunctional 3D Building Integrated Photovoltaic (BIPV) System

Kyoung Hee Kim¹, Chengde Wu², SeyedeHamideh Hosseiniirani¹, Catty Dan Zhang¹

¹University of North Carolina at Charlotte, Charlotte, NC

²Iowa State University, Ames, IA

ABSTRACT: The rooftop is a default location for photovoltaic solar panels and is often not enough to offset increasing building energy consumption. The vertical surface of urban buildings offers a prime location to harness solar energy. The overall goal of this research is to evaluate power production potentials and multi-functionalities of a 3D building integrated photovoltaic (BIPV) facade system. The traditional BIPV which is laminated with window glass obscures the view-out and limits daylight penetration. Unlike the traditional system, the 3D solar module was configured to reflect the sun path geometry to maximize year-round solar exposure and energy production. In addition, the 3D BIPV facade offers multiple functionalities – solar regulations, daylighting penetration, and view-out, resulting in energy savings from heating, cooling, and artificial lighting load. Its ability to produce solar energy offsets building energy consumption and contributes to net-zero-energy buildings. Both solar simulations and physical prototyping were carried out to investigate the promises and challenges of the 3D BIPV facade system compared to a traditional BIPV system. With climate emergency on the rise and the need for clean, sustainable energy becoming ever more pressing, the 3D BIPV facade in this paper offers a creative approach to tackling the problems of power production, building energy savings, and user health and wellbeing.

KEYWORDS: multifunctional 3D BIPV facade, net zero energy buildings, clean power production, health and wellbeing

INTRODUCTION

Buildings are one of the most important contributors to energy consumption and carbon emissions. The concept of net zero energy architecture and carbon neutrality has been around for a while. Recently, it has been gaining traction among architects, engineers, developers, and stakeholders alike. The net-zero energy architecture aims to produce as much energy as they consume by incorporating bioclimatic design, energy-efficient building service systems, and renewable energy sources such as solar panels. Carbon neutrality means that the carbon footprint of the building is balanced by a pollutant reduction through energy-efficient buildings while also offsetting energy use by renewable energy production systems. In order to reduce the environmental impacts, integrating photovoltaic systems (BIPV) into building designs can provide a sustainable solution toward carbon-neutral, net-zero energy architecture. Building surfaces are the prime location for integrating solar panels which can take any form from walls, roofs, and windows. The overall goal of this project is to develop a multi-functional solar facade for high-rise buildings to reduce carbon emissions and energy use, and improve occupant health and comfort through increased indoor environmental quality (IEQ). The proposed system outperforms traditional BIPV windows by providing maximum solar power output, summer shading, winter solar gain, year-round daylighting, and a view to outside.

1.0 SOLAR ARCHITECTURE

1.1 History of solar architecture

Photovoltaic cells convert solar radiation into direct current electricity. The history of cells can be traced back to the early days of the 20th century but it was not until the 1960s that they were used in a practical way. The first photovoltaic effect that light can generate electricity was discovered by a French scientist called Alexandre-Edmond Becquerel in 1839 (U.S. Department of Energy n.d.). In 1883, an American scientist Charles Fritts conducted the first experiment with solar cells made by placing selenium wafers between two metal plates and applying pressure but the cells were not very efficient and had to be in direct sunlight to work (U.S. DOE n.d.). In 1954, Bell Labs created silicon-based solar cells with a maximum of 11% conversion efficiency, which was a significant breakthrough because it is able to harness the sun to supply everyday electric devices (U.S. DOE n.d.). NASA launched the first satellite powered by a 470-watt photovoltaic array in 1964, beginning a new era for satellites with long-term power supply without recharging (U.S. DOE n.d.). Silicon solar cells are widely used today in most commercial applications of photovoltaic technology to provide sustainable architecture and generate electricity for the building. The US's BIPV market in 2020 was valued at \$1.9 billion and is expected to grow to \$7.8 billion by 2029 (Grand View Research 2020). This growth is largely due to the advent of new BIPV technologies with affordable prices which make BIPV easier to use and integrate into buildings. In addition, new construction markets are large and growing, offering large potential market opportunities for BIPV technology.

1.2 Current state-of-the-art

Conventional BIPVs include crystalline solar cells and thin films laminated with soda-lime glass. Vertical applications of BIPV windows result in power reduction due to the cosine loss as compared to roof or ground installations. The lamination of the PV cells within a window assembly lacks rear ventilation that increases module temperatures and further reduces system performance and longevity (Radziemska 2003). Opaque crystalline BIPV windows are good for shielding summer sun but are not energy efficient because they block winter sunlight into the interior space. The thin film solar cells allow for daylight penetration but their optical clarity is not truly transparent, often obscuring view-out and causing occupant dissatisfaction. Conventional BIPV made of soda-lime glass have been susceptible to shorter longevity and performance degradation due to potential induced degradation (PID) (Naumann et al. 2015). The commercially available BIPV has limited flexibility in architectural aesthetics, limiting a wide range of architectural applications. Table 1 shows potential BIPV solutions in real world deployment. There are opaque cladding and transparent glass applications. The integration of BIPV with glass modules acts like a shading device and renders it possible to minimize solar gain. On the other hand, the view and daylight penetration are minimized.

Table 1: Potential BIPV solutions in real-world applications. Source: (Author 2023)

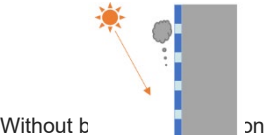
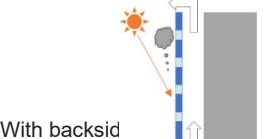
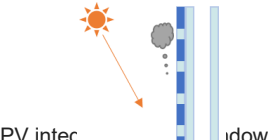
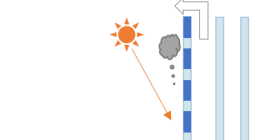
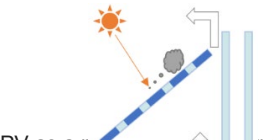
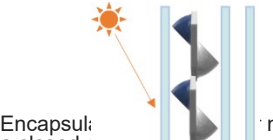
BIPV types	PV integration with building enclosures	Performance characteristics/ Differentiators
BIPV wall		<ul style="list-style-type: none"> ● Cell heat up ● Dust accumulation ● Harsh environmental loading (i.e., rain, sunlight, wind) ● No maximum power output due to cosine loss ● No view-out/ No daylight
		<ul style="list-style-type: none"> ● Less cell heat-up ● Dust accumulation ● Harsh environmental loading ● No maximum power output ● No view-out/No daylight
BIPV window		<ul style="list-style-type: none"> ● Cell heat up/ dust accumulation ● Harsh environmental loading ● Permanent shading (i.e., no winter sun penetration) ● No maximum power output ● Little view-out/ Little daylight penetration
		<ul style="list-style-type: none"> ● Less cell heat up ● Dust accumulation ● Harsh environmental loading ● Permanent shading ● Little daylight penetration ● Little view-out
		<ul style="list-style-type: none"> ● Less cell heat up ● Dust accumulation ● Harsh environmental loading ● Permanent shading ● More view-out
Proposed 3D BIPV system		<ul style="list-style-type: none"> ● Cells are cooled ● No moisture buildup ● No dust accumulation ● Optimized shading and daylighting ● Winter sunlight penetration ● View out

Research data indicated that every 1°K increase in solar cell temperature reduces approximately 0.65% output power and 0.08% conversion efficiency of the PV module (Gok et al. 2020). Every 100 W/m² increase in solar irradiation decreases electrical efficiencies by about 0.33%, 0.51%, and 0.84% for amorphous, polycrystalline, and monocrystalline PV cells, respectively (Ugwuoke et al. 2012). Air cooled modules increase efficiency from 9.75% to

10.41% (Siecker et al. 2017). Wind around PV cells reduces the surface temperature of the module, but it can result in decreased efficiency if the wind lifts dust, creating shading and poor efficiency (Zaihidee et al. 2016). The proposed BIPV system, on the other hand, is functionally innovative in that it is integrated within a closed air cavity system where solar cells are installed in a conditioned air cavity to improve the conversion efficiency and longevity of the solar cell by preventing heat build-up, dust accumulation, and moisture infiltration. The system incorporates a patent-pending solar cell interlayer that balances summer solar blocking, winter solar gain, and year-round daylight illumination.

2.0 3D BIPV SYSTEM

2.1 Proposed BIPV system

Our 3D BIPV facade consists of a single pane glass at the exterior side of the assembly and insulated glass unit (IGU) at the interior side of the assembly and a closed-air cavity created by the external glass pane and the internal IGU. The 3D solar modules – a network of solar cell units – are suspended in the closed-air cavity where the PV cells are protected against harsh outdoor environments. The 3D BIPV facade is configured as a prefabricated curtainwall system for speedy installation and quality control.

The sun constantly moves from the east and west during the day and its altitude and azimuth change across the seasons. The geometry of the solar unit mimics the sun's path to maximize solar exposure to produce electricity while regulating solar gains and penetrating daylight. The solar module blocks the summer sun and admits the winter solar gain. It is hypothesized that the curved solar unit following the sun path diagram yields better energy performance compared to a traditional flat BIPV window. The closed air cavity offers optimum environments for the solar module, keeping away from HAM (heat, air, and moisture) and dust accumulation and leading to the longevity and performance of the solar module.

We observed that while the closed cavity system yields high performance for the PV cell, it causes condensation in the air cavity in winter and heat build-up in summer. We also noted that the air cavity depth and height played a role in energy consumption for the air cavity operation. Therefore, we need to introduce an active system to condition the air cavity while optimizing solar module geometry and cavity dimensions depending on different climate zones and building orientations. We utilized an integrated multi-objective optimization using a genetic algorithm and Energy Plus performance simulation to estimate energy savings and power production. Figure 1 shows an overall configuration of the proposed BIPV system and its potential use for high-rise curtainwall construction.

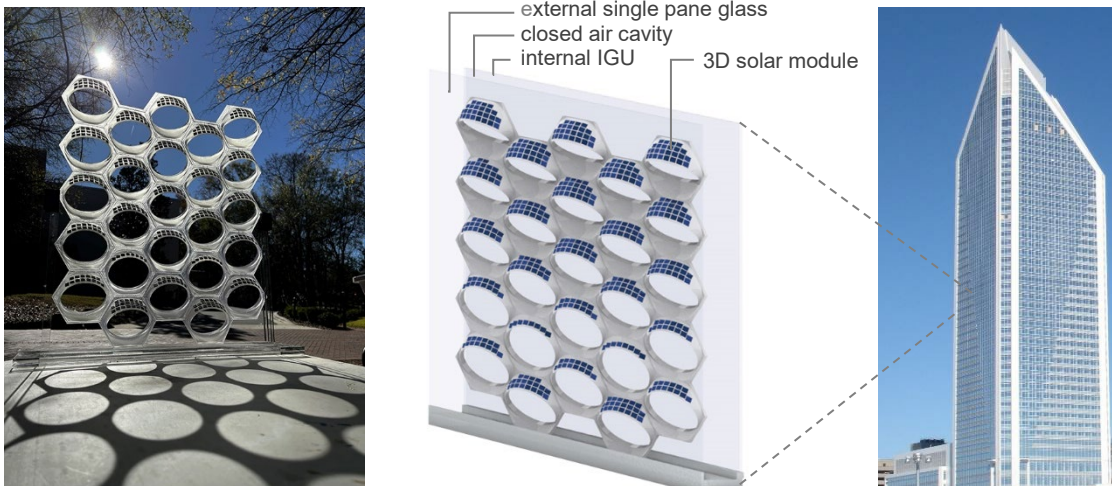

Figure 1: An overview of a multifunctional 3D BIPV system consisting of a 3D solar module, external glass, closed air cavity, and internal IGU; it is configured as a prefabricated curtainwall system for speedy installation and quality control. Source: (Author 2023)

2.2 Geometric rationalization

Building facades provide much more than just visual appearance. Well-designed building facades should provide comfort to the occupants while consuming minimal energy. In this research, we propose a facade system that can balance PV electricity generation, solar heat gain, daylighting, and view-out. This facade system is built on a hexagonal grid with circular openings. The geometries of the 3D solar module are parametrically controlled such that the overall performance can be optimized based on different climate conditions and façade orientations.

It is well known that high performance shading devices can reject solar radiation during summer when sun angle is high while admitting solar heat during winter when sun angle is low. In addition, horizontal shadings are more effective on the south facade while vertical shadings are more effective on east and west when sun angle is low. Figure 2 shows that the proposed 3D solar module combines these solar-responsive design principles to provide optimal shading

efficacy and solar exposures based on orientation. Between the south and east/west facades, the geometries smoothly transform from horizontal to vertical. With this formation, the southern facade functions similar to an overhang while the east and west facade function similar to vertical fins to maximize shading efficacy. In addition to the shading aspect, to provide occupants with maximum view-out, the openings at eye level are larger and gradually reduced to the size for optimum shading and energy production when moving up to the ceiling and down to the floor.

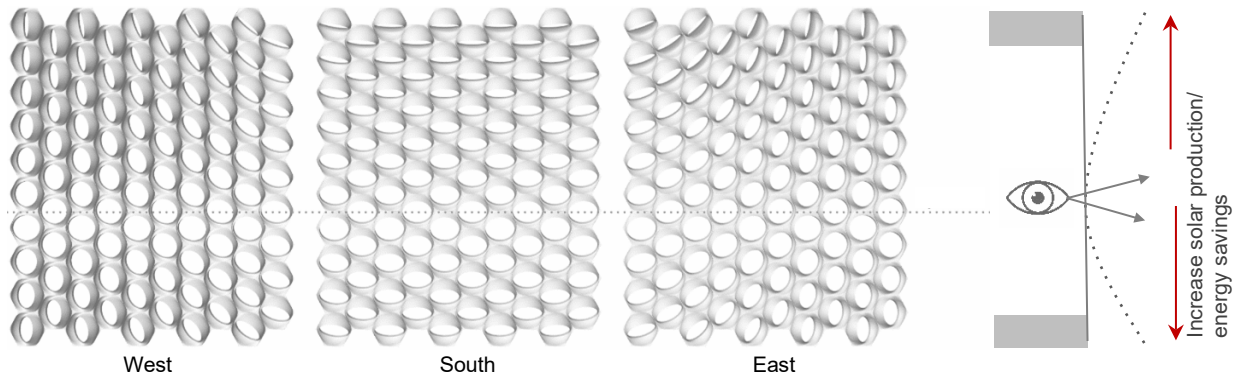

Figure 2: 3D solar module geometries facing different orientations: west (left), south (middle), and east (right) elevations; it balances solar energy production, energy savings, and user satisfaction through solar regulations, year-round daylight penetration, and view to outside. Source: (Author 2023)

As shown in Figure 3, each hexagonal cell contains an upper surface and a lower surface. The upper surface functions as a shading device while generating electricity with PV cells that are installed on the top of the surface. The curvature of the upper surface is parametrically controlled to optimize electricity generation based on the solar altitude of the building location. In Figure 3, the blue rectangles represent sections of PV cells and the arrows represent the normal direction of the cells. When the normal of the PV cells is aligned with the sun angle, the PV cells are at their maximum efficiency. Therefore, the curvature of the upper surface can be effectively changed depending on solar positions when each cell can produce the maximum electricity. Detailed performance analysis for electricity generation is explained in section 3 below. Although this system is a static system, meaning that the geometry of the facade does not change once manufactured and installed, the curvature of the upper surface and the lower surface vary based on the solar angle and climate conditions of the site. The optimum surface curvature can be determined by running optimization algorithms such as exhaustive search or Genetic Algorithm.

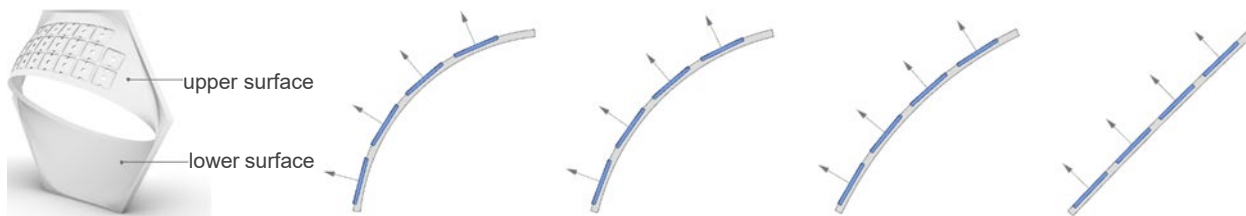

Figure 3: Various curvatures of the upper surface integrated with PV cells to adapt to different façade orientations and climate conditions. Source: (Author 2023)

The lower surface of the hexagonal solar unit can function as a light shelf to redirect visible light deeper into the space. For a traditional light shelf, the sunlight landing on a flat panel is reflected onto the ceiling, and is reflected again by the ceiling deeper into the space (Figure 4, left). In this research, the curvature of the lower surface is parametrically controlled to improve the daylighting quality. As shown in Figure 4, convex and concave light shelves can bring daylight into the space deeper with wider spread compared to conventional flat light shelves. The curvature of the convex or concave surfaces can be adjusted to redirect more light toward where it is needed. In figure 4, while the convex light shelf can effectively bring light deeper into the space, the curvature of the concave light shelf is designed to distribute more light toward the space further away from the window where more daylight is needed. This can be seen in figure 4 that the reflected arrows on the concave light shelf are denser toward the deeper end of the space. This shows that this facade system has potential to effectively distribute daylight to where it is needed.

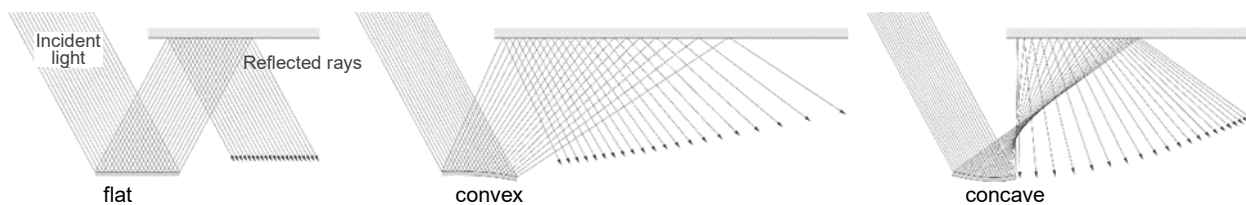

Figure 4: Curvatures of lower surface and their efficiency as light shelves. Source: (Author 2023)

2.3 Prototyping

To verify the energy performance of the façade design and test solar cell installation, we used additive manufacturing technology to prototype twenty-five oculi units. Using this prototyping technique, we were able to produce a performance mock-up with higher accuracy and precision which would have been difficult with traditional methods. Selected from the overall computational result of the geometry rationalization discussed in Section 2.2, each hexagonal solar unit measures 12.20 cm (h) x 14.22 cm (w) and is interconnected to form a network of the multi-functional solar module. Solar units have adjustable opening sizes for view-out and the upper surface of the unit allows a maximum of twenty-six and a minimum of eight 1cm x 1cm micro solar cells to be installed. In order to ensure the proper placement of micro solar cells and their wiring, we have developed a novel approach that incorporates inset surfaces and grooves. These geometric features provide a precise registration point that allows the solar cells to be installed in the correct locations while ensuring secure soldering connections.

Although additive manufacturing and laser cutting are allowing for precise and accurate tolerance, construction tolerance is an important consideration to ensure solar cell installation within the inset surface. To accommodate material and fabrication tolerances, the insets on the physical model for the solar cells to be inserted into are 110% of the cell size (Figure 5 middle), with connecting grooves on all sides which allow various configurations of cell soldering connections. In addition, a 0.22cm wide groove for the wire path is embedded along the border of each oculi unit (Figure 5 right). Due to the unique geometry of each of the solar units, 3D printing the entire prototype was selected as the method for physical prototyping. The units were printed one at a time by a Form 2 printer (FormLabs) using clear resin. The thickness of the units is optimized both for achieving a short printing time and ensuring surface properties for assembly. The average printing time for the prototype is 5.5 hr/unit, and each unit needs an average of 60 ml liquid resin including model supports automatically generated for printing.

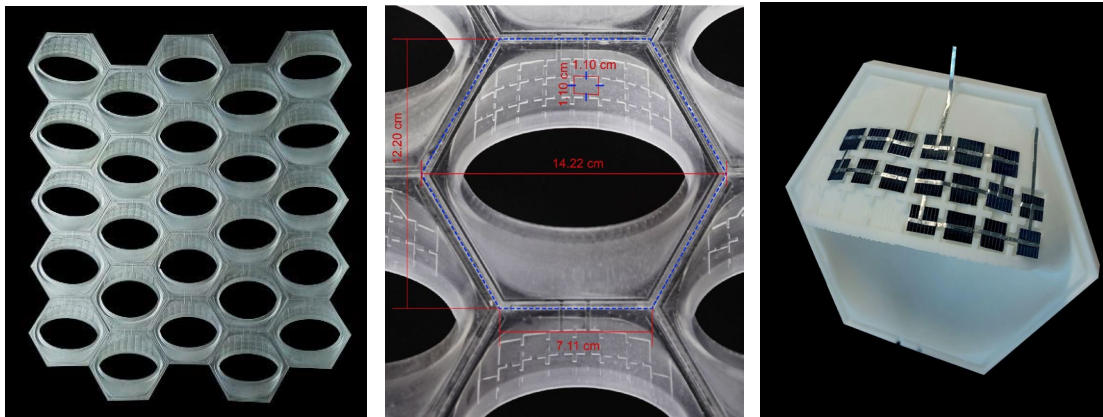

Figure 5: 3D printed 25 solar units using clear resin (left), a detailed view with dimension (middle) and a 1cm square micro solar cell with ribbon wire test-fit on a 3D printed white PLA module (right). Source: (Author 2023)

3.0 ENERGY PERFORMANCE

3.1 Simulation set-up

Two generic office buildings with a 3D BIPV façade and a flat vertical BIPV façade on the south-facing wall were modeled in Rhino software to simulate how the 3D BIPV façade outperforms the flat vertical BIPV on power production. To compare the power output results of the 3D BIPV façade with the traditional BIPV flat window, a vertical PV surface facing towards the south, with an area equal to the total PV cells area in the 3D BIPV window was modeled. The geographical location of the analysis building was set to be the city of Charlotte in the state of North Carolina, U.S.

Equinoxes and solstices are four key days during the year that can provide insight into the solar power potential of the BIPV façades, and therefore, these four days were chosen for the analysis period. By analyzing these four seasonal days, we can gain an understanding of the amount of solar energy produced by the system throughout the year. Hourly average irradiance on the PV cells was simulated in those four days, using Grasshopper, Ladybug (LB), and ClimateStudio (CS) plugins. The analysis grid size of the LB incident radiation component was set to 1 cm which is exactly the same size as the PV cells of the physical prototype, allowing for accurate results and fast simulation process (Figure 6).

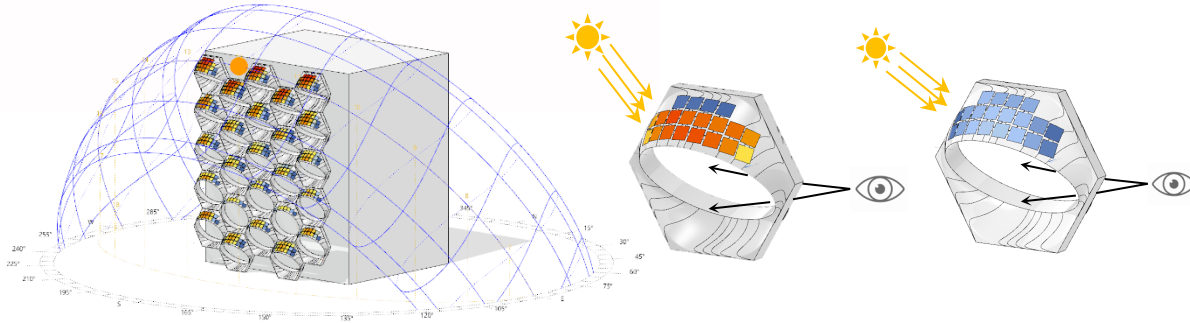

Figure 6: Simulation set-up of the solar modules facing the south orientation (left); irradiance levels on fall equinox at 1 pm (left), summer solstice at 1pm (middle), and winter solstice at 1pm (right). Source: (Author 2023)

3.2 Performance simulations

Higher conversion efficiency of the solar module and its improved longevity result in lower electricity costs and a quick return on investment. In other words, the initial investment in BIPV systems can be quickly recouped through substantially lower electricity bills during the building use phase, contributing to economic and environmental sustainability. Conventional BIPV windows have been placed in vertical surfaces for years, but their power production has been limited due to the cosine effect. The cosine effect reduces conversion efficiency when sunlight is not perpendicular to the surface of the BIPV, limiting the amount of energy that can be collected and converted into usable electricity. To minimize cosine loss and maximize annual energy production, the proposed 3D BIPV system incorporates sun path-like curved geometries, which are optimized for the more prevalent summer design day. This new approach promises to be more energy-efficient than the traditional BIPV system

Our analysis results indicated that the 3D BIPV façade on the south orientation outperformed across the seasons and the power production improvement was significantly higher during summer. In comparison to a conventional vertical BIPV system, the proposed BIPV facades yielded 72% greater power production during the summer solstice, about 25% during the equinox days, and similar power production during the winter solstice. Assuming that the PV cells have 15% efficiency, the 3D BIPV facade can output a daily average of 450 Wh/m² energy while the traditional vertical PVs generated 350 Wh/m² per day. Yearly solar energy comparison has shown that 3D BIPV offers 30% more electricity generation compared to the vertical BIPV, and produces 7% less energy than a horizontal BIPV.

The analysis has revealed that a BIPV system with 3D-shapes that reflects the different positions of the sun significantly enhances energetic performances while being able to provide daylight provision and views to the outside. The 3D curved geometry maximizes their exposure to the sun and therefore, increases power production. Additional energy savings are achieved by providing shading in the summer and solar heating in the winter. The solar cell geometry is configured in response to the climate and environment depending on the site location and façade orientation, balancing solar exposure, shade in cooling seasons, winter solar gain, and daylight illumination. Figure 6 presents energy production comparisons between the 3D BIPV façade and a BIPV vertical façade.

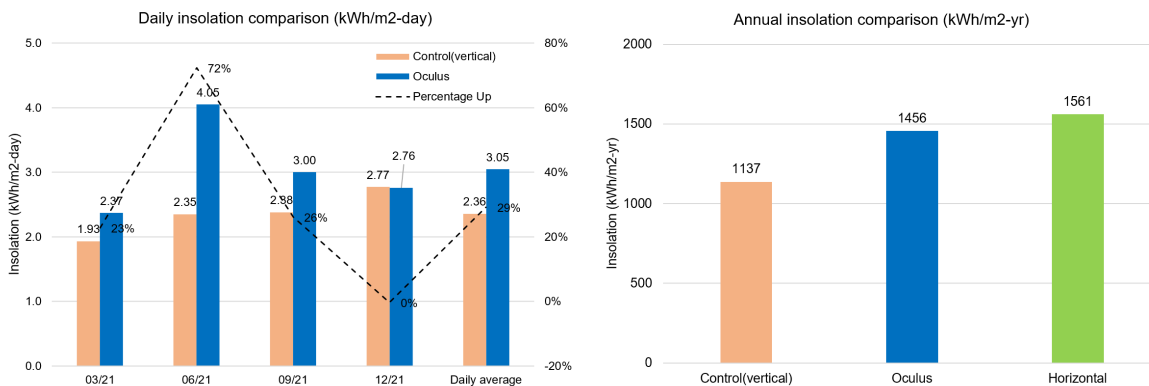

Figure 6: 3D BIPV and traditional BIPV power output comparison: Daily insolation (left) and annual insolation (right). Source: (Author 2023)

CONCLUSION

Buildings are primary contributors to fossil fuel consumption and pollutant emissions. BIPV facades can provide a sustainable solution to reduce their carbon footprint and achieve a net zero energy goal. Low-performing windows, in particular, are important in indoor environmental quality, energy bills, and occupant comfort. By integrating solar

modules within a window assembly, the BIPV facade not only provides energy savings but also improves the comfort level of their interior spaces. We proposed a 3D BIPV facade as an innovative way to achieve carbon-neutral net zero energy buildings.

The proposed 3D BIPV system consists of a network of solar units with varying angles that balance power production, building energy efficiency, and view out. Because the path of the sun moves along with the spherical surface, our solar unit geometry takes into account the path of the sun, allowing maximum sun exposure throughout the day and across all seasons. The proposed BIPV facades on the south orientation yielded an average of 30% more power production year-round compared to a vertical BIPV. During summer seasons, the 3D BIPV facades produced 70% more power than a conventional BIPV system, 25% more during equinox seasons, and similar energy production during winter seasons.

The system offers a unique approach to solar module protection by installing them in a closed cavity air created between two panes of glass. This closed air cavity is conditioned to prevent heat build-up, moisture penetration, and dust accumulation on solar cells, thus providing the solar modules with higher power production and system longevity. In addition, it is expected to yield high thermal attributes, shading efficacy, and daylighting penetration, reducing heating, cooling, and artificial lighting load respectively. Unlike a traditional BIPV facade, the 3D BIPV façade offers an improved user experience by providing view contact with the outside and better sound insulation.

Clean power production, building energy conservation, and user healthy and well-being are hallmarks of the proposed solution.

Further investigation is necessary to run comparative simulations for all building orientations and different sites. This will help provide a more comprehensive understanding of energy production potentials from the 3D BIPV system. In addition, field experiments are necessary to validate the simulation data. This data validation will result in a more reliable and accurate prediction of power production. Finally, the use of simulation and experimentation makes it possible to create a decision support tool, which helps evaluate the holistic energy performance of the 3D BIPVs in different facade orientations and site locations.

ACKNOWLEDGEMENTS

The research has been funded by the National Science Foundation (Award number: 2122014). The Authors would like to thank Dr. Abasifreke Ebong and Tyler Palmer for their guidance and assistance regarding solar cell integration and lab testing.

REFERENCES

- Gok, Abdulkerim, Ebrar Ozkalay, Gabi Friesen, and Francesco Frontini. "The Influence of Operating Temperature on the Performance of BIPV Modules." *IEEE Journal of Photovoltaics* 10, no. 5 (2020): 1371-1378.
- Grand View Research "Building Integrated Photovoltaic Market Growth & Trends" Published Date: August, 2020, accessed Jan 2023, <https://www.grandviewresearch.com/industry-analysis/global-flat-glass-market>
- Naumann, Volker, Dominik Lausch, and Christian Hagendorf. "Sodium decoration of PID-s crystal defects after corona induced degradation of bare silicon solar cells." *Energy procedia* 77 (2015): 397-401.
- Radziemska, E. "The effect of temperature on the power drop in crystalline silicon solar cells." *Renewable energy* 28, no. 1 (2003): 1-12.
- Siecker, J., K. Kusakana, and B. P. Numbi. "A review of solar photovoltaic systems cooling technologies." *Renewable and Sustainable Energy Reviews* 79 (2017): 192-203.
- Ugwuoke, P. E., and C. E. Okeke. "Performance assessment of three different pv modules as a function of solar insolation in South Eastern Nigeria." *International Journal of Applied Science and Technology* 2, no. 3 (2012): 319-327.
- U.S. Department of Energy. n.d. "Solar Timeline." Accessed December 29, 2022. https://www1.eere.energy.gov/solar/pdfs/solar_timeline.pdf.
- Zaihidee, Fardila Mohd, Saad Mekhilef, Mehdi Seyedmahmoudian, and Ben Horan. "Dust as an unalterable deteriorative factor affecting PV panel's efficiency: Why and how." *Renewable and Sustainable Energy Reviews* 65 (2016): 1267-1278.

Rethinking The Architectural Review Through Immersive Virtual Reality

John Stack Ross¹

¹Mississippi State University, School of Architecture, Mississippi State, MS

ABSTRACT: Architectural design reviews via the traditional critique play a significant role in the learning experience of students during formative and summative assessments. However, traditional critique arrangements often suggest a hierarchical relationship between critics and students, which has the capacity to shift the focus away from an assessment serving as a learning activity. This research aims firstly to identify some of the existing problems in more traditional methods and arrangements of a design review, and secondly, reconsider these arrangements, and pedagogical objectives, through the use of emerging technology in representation and presentation techniques (immersive virtual reality via CAVE technology). How can a design review, if seen as a learning activity and not merely a critique, facilitate a more constructive learning opportunity, which shifts the hierarchy in traditional design reviews, in order to facilitate active learning during an assessment and accommodate a greater diversity of students? Furthermore, how can more novel methods of representation and presentation, such as immersive virtual reality, play a part in reorganizing a design review to achieve these goals?

Emerging technologies, such as immersive virtual reality, have the capacity to change the way we present and communicate architectural projects and should have their place within design reviews. Both the academic and professional aspects of architectural design are increasingly influenced by digital methods, where virtual reality is emerging as a method to supplement more traditional design presentation and representation techniques. Immersive virtual reality allows for an experience in architectural designs at a 1:1 scale. This has the capacity to focus on the objectives of a design project as a 3-dimensional, temporal experience. The technology incorporates time and movement in a presentation which is essential in understanding an architectural design. The pedagogical advantages are also aided by having critics and students side by side in an immersive virtual environment. With projects being projected within a multidimensional environment the attention shifts from a unidirectional critique, where students feel “on stage” to an environment that offers students to more actively guide critics through architectural designs. Students and critics become partners within an assessment that focuses on a more explorative process of understanding the spatial qualities of the design. Shifting the traditional spatial arrangement of a design review through the use of immersive virtual reality can prove effective in its ability to create a more engaging and active assessment environment for both students and critics. Students are immediately more active in the way they navigate through their digital models and communicate their design process and ideas.

KEYWORDS: Virtual Reality, Pedagogy, Digital Modeling, Digital Simulation, Active Learning

TRADITIONAL DESIGN REVIEW / CRITIQUE FORMAT

In traditional review formats critics are typically seated in a front row to hear and see the presentation clearly. The student (or group of students) stands in front / to the side of work either presented through digital projections / slideshows, printed material and / or physical models and the rest of the audience is typically seated behind the critics. (see Figure 1 and Images 1)

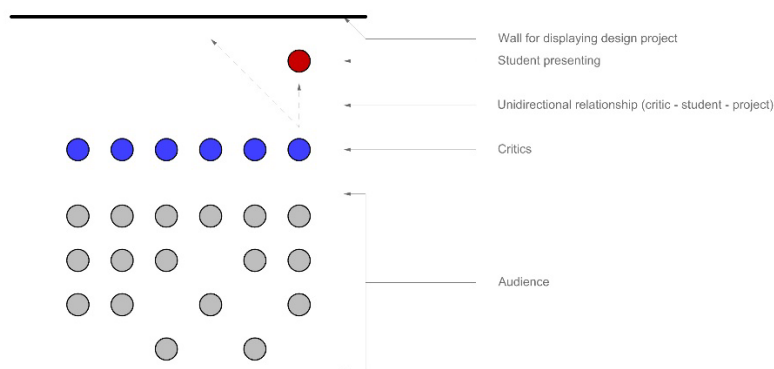

Figure 1: Traditional design review layout (Diagram by author)

There is a necessity to this arrangement based on the key assessments being provided by the critics and their need to hear and see the work clearly based on traditional presentation techniques. However, this format has the capacity to create a one-sided conversation and hierarchal spatial arrangements where students feel put on the spot and occasionally suffer a “deer in the headlights” syndrome. This often results in students being somewhat hesitant to speak out to either explain and / or defend their design ideas. It is dependent on the personality of each student as well. Some students are more comfortable speaking in front of groups while others are not, which occasionally leads to some students feeling more interrogated than constructively critiqued.

Thus, for the student, the focus becomes a situation of avoiding “abject terror”. The student becomes preoccupied with the outcome and merely surviving the review and not seeing the design review as an opportunity for constructive feedback. (Kugel, 1993)

In addition, there is a need for design reviews to reflect an ability of teaching and assessment methods to embrace strategies that accommodate a greater diversity of student personalities and shift the focus from teaching to learning, were the student becomes more receptive and active within the assessment process itself. (Kugel, 1993)

Therefore, how can a design review, if seen as a learning activity and not merely a critique, facilitate a more constructive learning opportunity, which shifts the hierarchy in traditional design reviews, to facilitate active learning during an assessment and accommodate a greater diversity of students? And how can more novel methods of representation and presentation, such as immersive virtual reality, play a part in reorganizing a design review to achieve these goals?



Images 1: Arrangement of traditional review. (Photos by author).

Intended Learning Outcomes

The learning outcomes of this project are driven by how students will engage in immersive virtual reality as a novel presentation method and how this method reconfigures the traditional organization of a design review. The students should reflect on how it shifts an assessment to a learning activity and the effectiveness of immersive virtual reality within a review to shift the hierarchy between student and critic, thus fostering a more active and constructive assessment environment.

- Describe and Communicate architectural designs through immersive virtual reality.
- Analyze and Compare this approach to conventional assessment strategies in an architectural design review.
- Evaluate the effectiveness of immersive virtual reality in communicating architectural concepts and designs.
- Reflect on the use of immersive virtual reality in its capacity to shift an assessment to a learning activity.

The Design Review as Active Learning

The idea of shifting an assessment to a learning experience reflects the idea that, “Assessment is not simply an end-of-course exercise to determine student grades.” (McKeachie and Svinicki, 2011, p. 74) My understanding is that McKeachie and Svinicki are referring more to formative assessments that “throughout a course communicates your goals to students so that they can learn more effectively...” (McKeachie and Svinicki, 2011, p. 74)

However, I believe that summative/end-of-course assessments can serve as active learning experiences and continue as a part of teaching practices “that become the fulcrum for better learning as well as institutional improvement.” (McKeachie and Svinicki, 2011, p. 76)

A design review can be used at many stages in the development of an architectural project and is useful as both a summative and formative assessment technique. However, this project, as mentioned previously, focuses on the design review as a summative assessment technique at the completion of a design project, which has the capacity to become a teaching and learning activity.

The project restructures a typical review format, where students tend to become passive listeners to a panel of critics, to a format that allows students to engage in a more active role in the presentation method and design discussion through the use of immersive virtual reality.

Emerging technologies, such as immersive virtual reality, have the capacity to change the way we present and communicate architectural projects and should have their place within design reviews. Both the academic and professional aspects of architectural design are increasingly influenced by digital methods, where virtual reality is emerging as a method to supplement more traditional design presentation and representation techniques.

Immersive virtual reality allows for an experience in digital architectural designs at a 1:1 scale. This has the capacity to shift the review discussion to focus on the design objectives of a design project as a three-dimensional experience. The technology further incorporates time and movement in the presentation which is essential in understanding an architectural design project. This change in presentation method shifts the assessment process from a tendency to overly rely on rhetoric and on representation techniques that are more abstracted from the reality of the architectural intentions. Subsequently, the assessment process becomes much more related to the way we experience the built environment and focuses the discussion on such.

The pedagogical advantages are also aided by having critics and students side by side in an immersive virtual environment. Projects being presented within a multi-dimensional environment allow the student to guide critics more actively through architectural designs. Students and critics become partners within an assessment that focuses on a more explorative process of understanding the spatial qualities of the design. This changes the student from a passive listener of a critic's opinion to an active participant in the assessment conversation. This focus on the student's ability to guide an assessment process puts an emphasis on learning where the student becomes active and independent. (Kugel, 1993) (See Figure 2 and Images 2)

In this project two students participated in a review using the immersive virtual reality technology CAVE (Cave Automated Virtual Environment). It was important to have two distinctly different design projects to evaluate the pedagogical advantages of using immersive virtual reality as it related to the general review format and not something specific to a type of design. One project (student 1) was a research lab on Mars and the other (student 2) was a library in South America. Both students had existing digital models of their projects that needed to be imported into the software Unity, which is a cross-platform game engine that allows for the development of interactive digital models and commonly used for virtual reality. Students were able to add such things as collision detection and gravity to their digital models to create a more realistic virtual environment.

It was important to evaluate how much of the review conversation would rely on speaking about the technology versus discussing the architectural designs. In both reviews the discussion of the technology was focused more on its ability to give both students and critics a better overall understanding of the design project. Using handheld controllers, like the type found with video game consoles, students and critics were able to navigate through the three-dimensional designs at a 1:1 scale.

There was a freedom of movement based on curiosity and critique, where the discussion became more pertinent and focused on what had been designed. Students and critics were virtually entering the designs for the first time and the primary focus was on what had been achieved architecturally.

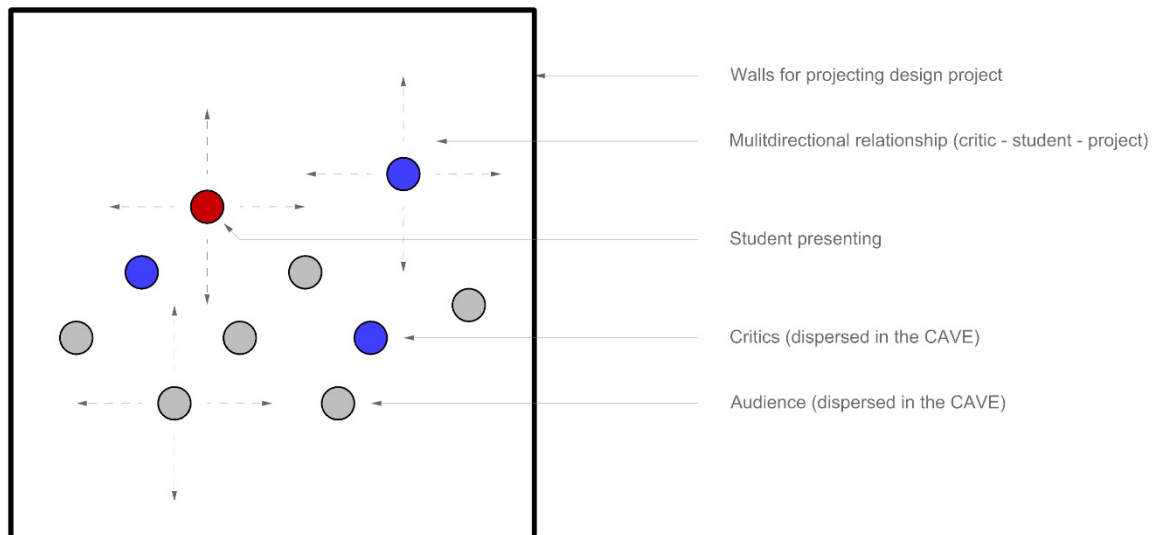
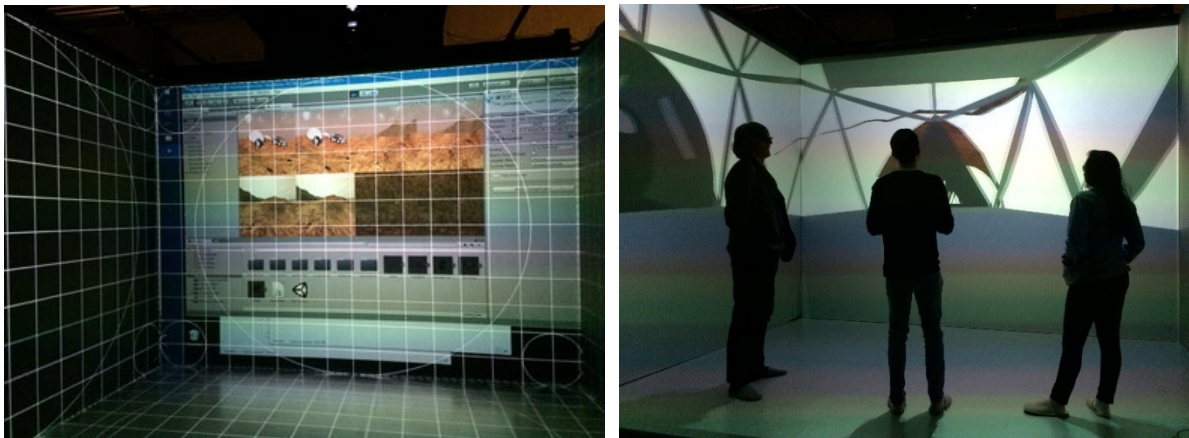

Figure 2: Design review layout using VR/CAVE (Diagram by author)



Images 2: Arrangement of review using VR/CAVE. (Photos by author).

Assessing an Assessment as a Learning Activity

To assess whether the learning outcomes had been achieved and what needed to be known about how the students experienced assessment as a teaching and learning process, students were asked to reflect critically on how virtual reality changed their presentation techniques and changed the relationship between presenter and critic.

A questionnaire was essential in assessing an assessment as a learning activity as it helped the students, and myself, reflect on devising measures of complex, higher-level objectives that may help break away from conventional forms of assessment and influence student motivation and learning. (McKeachie and Svinicki, 2011)

Questions were formulated regarding how the use of the technology, and a novel, multidimensional spatial arrangement, within the presentation offered new assessment methods that could facilitate more constructive critique and learning environments.

- Can immersive, full-scale, multidirectional environments, when presenting architectural projects, foster more conversational and constructive feedback from jurors?
- Do dynamic presentation environments offer more than static ones?
- Does such technology distract from the presentation by becoming too much of the focus (a gimmick)?

- Is the use of such technology merely contesting other methods of presenting or can these more novel environments supplement more traditional ones?

Can immersive, full-scale, multidirectional environments, when presenting architectural projects, foster more conversational and constructive feedback from jurors?

Student 1: "It felt very engaging. I observed that as the project was being presented, questions were just being asked spontaneously and without formalities. While in a more traditional presentation the burning question has to be very "burning" in order to be asked during the presentation. It did definitely make it easier for both jurors and the student to communicate during the presentation. Questions were very much pointed and directed to specific details in the model whereas in a conventional presentation there is always a level of abstraction involved. As architect students we are to practice the presentation of our claim in our designs. Every architectural project has a point, idea, vision, or a statement. Without these there is nothing to discuss. VR is one those tools that helps to create the vision of the designer as closest possible to the reality of the project for the audience. Therefore, there is much less effort needed to describe the idea. We let the audience themselves basically experience the idea that the student has envisioned. The questions were clearer and more in-line with the design itself and therefore offered a better criticism."

Student 2: "Absolutely. I have experienced many reviews where, unfortunately, the feedback from the jurors was not helpful at all. This has happened when the project is not the main object of discussion, but instead focused on layout or technicalities of the graphics. Also, it's important to remember that constructive feedback does not only come from the jurors, but also from your peers. But it's hard to get feedback from your classmates when they are practically segregated behind the jurors where they can barely see anything from the person who is presenting. Therefore, in an immersive, full scale multi directional environment you are engaging the entire audience in your project. This, in my opinion, is where the hierarchies disappeared."

Do dynamic presentation environments offer more than static ones?

Student 1: The amount of the information (visuals) which is given in the VR format is very much overwhelming. Many spots, many details and so many perspectives lead the presentation to feel kind of heavy. Sometimes more feels a bit less. Maybe the lack of clear planning during the presentation causes a feeling like there is so much more that could be understood during the presentation but somehow got lost in between all the visual information. For example, I couldn't refer to the layout of the building since it wasn't shown. Also, I wanted to discuss more about the context of the building and how the design responded. At the same times this issue is not impossible to solve. I can imagine additional layers of information and graphics easily incorporated into the presentation to clarify other aspects of the project.

Student 2: Architecture narrows down to the creation of three-dimensional spaces. Somehow the standard architectural methods of representations nowadays purely consist of two-dimensional drawings. Through this process the project loses at least a third of its complexity. In traditional static environments it's easy to get lost in the architectural discourse which can enhance or weaken the project itself. Since the project is presented just in two dimensions, the third dimension is left to the imagination of the jurors, and this again, can enhance or weaken a project.

Does such technology distract from the presentation by becoming too much of the focus (i.e., a gimmick)?

Student 1: "I can imagine that this type of presentation if more accessible would lose its "wow factor" and feel more natural in a short amount of time. Formalities in conventional methods sometimes build up a barrier between the audience and presenter. Virtual reality offered a less formal environment where everyone could look in multiple directions and still receive information about the presentation. To have such a presentation where everyone can walk around the design and observe from their own perspective, versus some perfectly situated image, makes the interaction between presenter and audience more natural."

Student 2: "I do think that at first this type of technology distracts from the presentation, but it is just a matter of getting used to it."

Is the use of such technology merely contesting other methods of presenting or can these more novel environments supplement more traditional ones?

Student 1: "I think the tools we are using for our presentations are based on our decisions as designer and decisions can be based on the topic, target audience or the amount of time for the presentation. Models, panels and digital projections are all part of the toolbox. Sometimes a project can be explained simply by a drawing. Sometimes it needs extensive illustrations together with technical information. Virtual reality for me is a tool in parallel to the others that helps explain the vision of the student. Considering the amount of time and effort in creating a virtual reality presentation, perhaps it's more applicable to projects where extensive details and illustrations are needed."

Student 2: "I think that the use of this technology as it is right now is only supplementing traditional methods of presenting, but when developed further they are definitely going to be contesting. For me, it is really exciting to imagine how the use of this technology will transform architectural representation and presentation."

CONCLUSION

Shifting the traditional spatial arrangement of a design review using immersive virtual reality proved effective in its ability to create a more engaging and active assessment environment for both students and critics. Students were immediately more active in the way they navigated through their digital models and explained their design process and ideas. This

ability to guide the review process and conversation was additionally advantageous in its ability to foster an ongoing, informal dialogue of assessing and reflecting during the assessment process itself and, in my opinion, reflects some of the ideas by Ramsden regarding moving beyond simple models of assessment. (Ramsden, 2003)

The restructuring of a design review, to foster active learning in an assessment itself, further reflects an “assessment that is the servant rather than the master of the educational process.” (Ramsden, 2003, p. 180) With a more active role within the assessment process, students became increasingly analytical and reflective within their own work during the assessment process.

Another aspect of this project’s approach to assessment as a learning experience is an assessment’s ability to emphasize, and focus on, “functional knowledge”. Both the student and critic were virtually entering and assessing the design for the first time together and students took on a somewhat more objective role in evaluating their own designs.

This idea of experiencing and learning simultaneously was evident in the assessment conversation and reiterates “functioning knowledge” being “based on the idea of performances of understanding” and a knowledge that is “within the experience of the learner.” Not in so much as the application of declarative knowledge, but more in the idea that students are engaging in a qualitative phase of learning within the assessment process. (Biggs, 2003)

REFERENCES

- Biggs, J. (2003). *Teaching for Quality Learning at University*. New York: The Society for Research into Higher Education and Open University Press.
- Kugel, P. (1993). *How Professors Develop as Teachers*. In *Studies in Higher Education*, Volume 18, No. 3, 315-328
- McKeachie, W. J., & Svinicki, M. (2011). *McKeachie’s Teaching Tips: Strategies, research, and theory for college and university teachers*. Andover: Wadsworth Cengage Learning.
- Ramsden, P. (2003). *Assessing for Understanding*. In *Learning to Teach in Higher Education*, Second edition, 177-206

Rethinking Housing: Researching The Promise, And Limits, Of Emerging Technologies On Home Construction in the US

Scott Gerald Shall¹

¹Lawrence Technological University, Southfield, MI

ABSTRACT: The US housing market is filled with unaffordable, inefficient, and unsustainable homes. In 1965, potential homeowners would need to spend less than three times their annual salary to purchase a house; by 2021, this figure had almost doubled. During this same period, the environmental footprint of US homes, in terms of both waste generated and energy used, had increased by an even greater percentage.¹ These costs have rendered home ownership an impossibility for many, forcing huge swaths of the country into rentership – a situation which has driven up rental costs, making it nearly impossible for those who rent to save enough funds to stop doing so.

To upset this cycle of dependent rentership requires new, more sustainable approaches to financing, designing and constructing homes. Fortunately, emerging technologies offer intriguing promise to this end. This paper will assess this potential through a comparative analysis of three soon-to-be-completed homes, each of which was realized through the deployment of one or more emerging technologies. From generative design to industrial production, 3d-printing to panelization, the proposed study will offer readers a grounded, evidence-based comparison using metrics relevant to the building trades. The resulting conclusions will offer those involved in the housing industry insight into these technologies, so that they might help to create more affordable and sustainable housing for a nation in desperate need of it.

KEYWORDS: Housing, Sustainability, Affordability, Generative Design, Digital Fabrication



Figure 1: Developments such as the Luckey Ranch subdivision outside San Antonio are built from homes that are financially and environmentally unsustainable. (Ball 2022)

1.0 FOUR TRENDS: UNDERSTANDING THE US HOUSING CRISIS

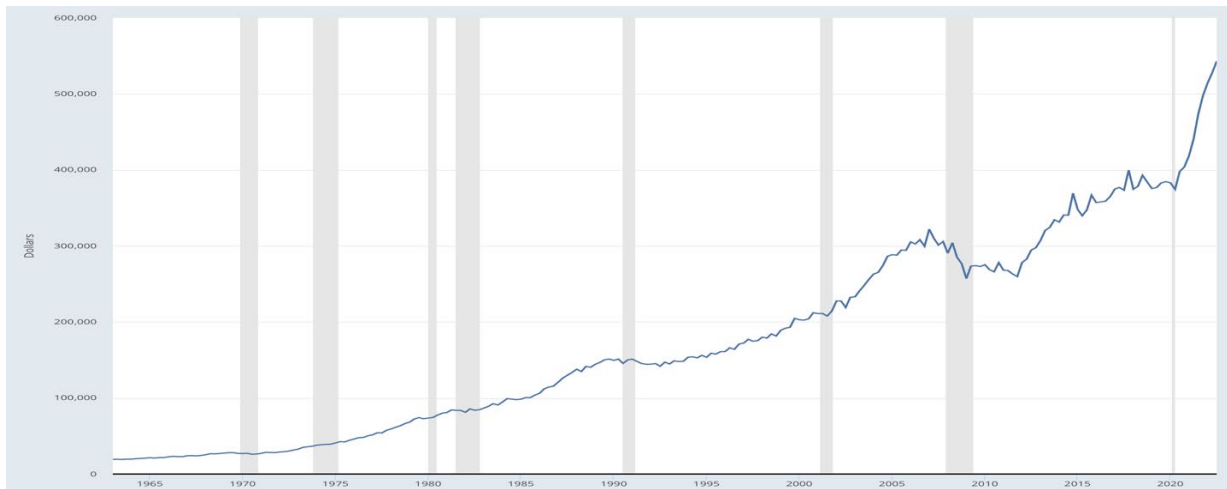

Figure 2: The average price for a home in the US has increased dramatically since 1960, far outpacing inflation. (U.S. Census Bureau and U.S. Department of Housing and Urban Development 2022)

1.1. Cost

Over the last half century, housing in the US has become increasingly unsustainable, economically and environmentally (Figure 1). In 1965, the average US home sold for just under \$172,000, and the median household income was around \$60,000 (adjusted to 2021 dollars); by 2021, the average home price had more than doubled to \$374,000 while household income had risen less than 15% (Figure 2) (Delgado 2021). Cross-referencing these averages with the published interest rates as of October 2022, a 30-year mortgage for a home-buyer who is able to offer 10% of the total price at closing would be \$2020.70 per month. This figure, which does not include local taxes or other escrow costs, is equal to over 47% of the average American's net monthly pay of \$4244 and 35% of their gross pay, both of which are well above than the recommended allocation of 30% - a critical threshold to avoid being cost-burdened. Adding escrow costs and private mortgage insurance for those who cannot afford the 10% down payment, this monthly outlay increases substantially, resulting in the average American homeowner spending over half of their monthly income on housing. As all of these averages are inflated by the salaries of the wealthiest Americans, these data likely understate the dilemma faced by the average home buyer, masking a larger, and more sobering, reality.

1.2. Material Use

The wastefulness and inefficiency of current construction practices are at least partially to blame for this increase. According to a recent study, the amount of waste produced when building a single-family home in the US is between two and four tons. And while 80% of this waste could be recycled, only 30% actually is (Laquatra and Pierce 2011). This wastefulness generates an incredible amount of debris every year – a figure which has grown substantially over the last few decades. To be more specific, in 2018 the amount of waste produced by construction and demolition debris in the US amounted to 600 million tons, or around 40% of the solid waste stream generated by all sources (EPA 2020, 19-23). This number, which includes waste from both the construction and demolition of buildings, roads and bridges, represents an increase of 342% from 1990. More sobering: the rate of wastefulness is actually accelerating, as between 2005 and 2018, construction and demolition waste levels grew more than 10x faster than they did from 1990 to 2005 (EPA 2021).

1.3. Energy Use

From the standpoint of energy consumption, however, the environmental footprint associated with construction and demolition is actually quite modest compared with that of operation, as around 90% of a home's life cycle energy consumption can be attributed to the latter (Blanchard and Reppe 1998). To be more specific: in 2021, the residential sector in the US consumed 3.79 trillion kWh of electricity. Breaking this figure down to individual structures, the average house in the US consumes around 147 kWh/m², or over 46,500 BTU/H/SF every year (Goldstein et al. 2020). Both of these numbers represent a sharp increase from previous decades, as energy consumption within the housing sector has increased 13-fold between 1950 and 2021 (Figure 3) (U.S. EIA 2022). Although the increased use of technology within the home can account for some of this increase, most of it is attributable to the energy needed to heat and cool these structures – a remarkable testament to the inability of contemporary housing to provide comfort through intelligent design, instead of the infusion of energy.

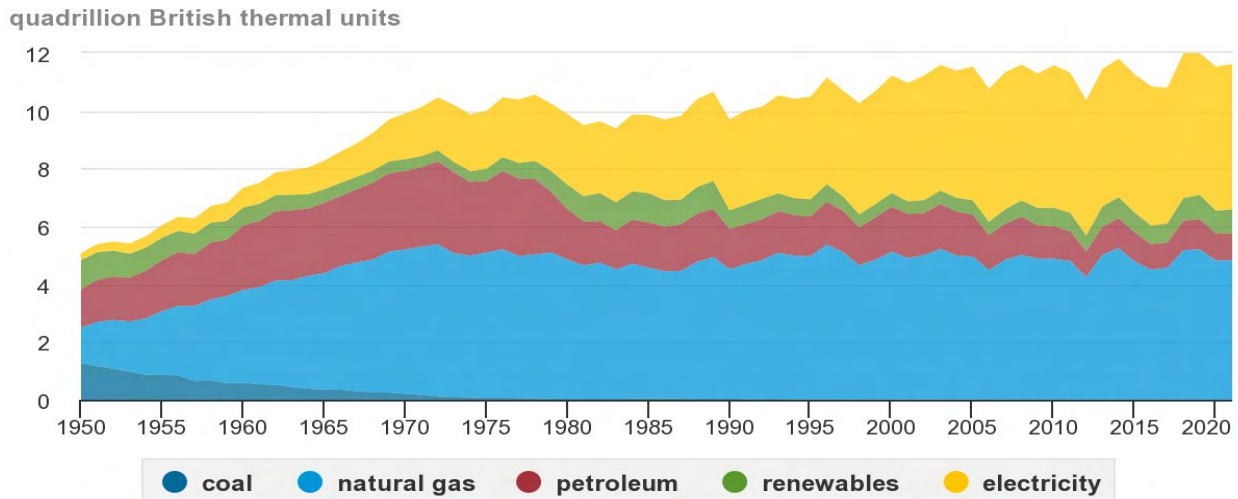

Figure 3: The energy consumed by housing in the US has increased dramatically since 1950. (US Energy Information Administration 2021)

1.4. Ownership

Based upon these data, it is not difficult to see how the cost of housing, registered in both environmental and economic terms, has made home ownership an impossibility for many, compelling more and more Americans to rent their primary residence. Whereas between 2006 and 2016, the share of US homeowners was largely flat, the share of US renters had increased from 34.6 million households to 43.3 million households, or just over 36% of all households (Figure 4). This represents the largest percentage increase in renters since 1965 (Cilluffo et al, 2020). Predictably, the increasing number of renters, combined with a relative stagnation in the number of rentable properties, has driven up rental costs considerably. This makes it almost impossible for the average renter to save enough funds to purchase a home, creating a cycle of dependent rentership, which has significant, long-term repercussions for those trapped within it (Harvard 2022). Recent inflationary pressures, and current economic projections, indicate that these trends will become more pronounced over the next few years.

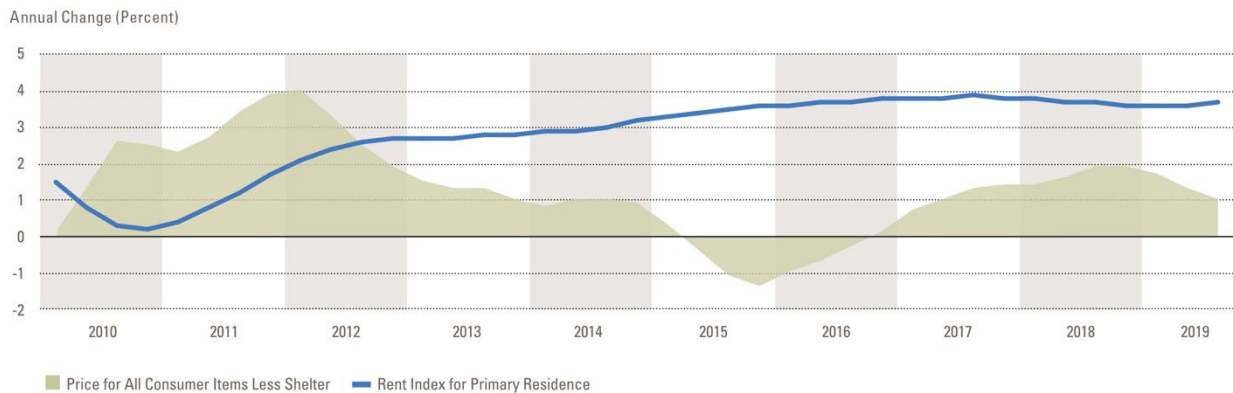

Figure 4: Rental prices continue to outpace inflation, leading to a significant increase in the number of renters who are considered cost burdened. (Harvard 2022)

1.5. Emerging Technologies

Reversing these patterns requires new, more sustainable approaches to the financing, design and construction of housing. Fortunately, emerging technologies offer some promise to this end, providing designers, builders and financiers powerful, new tools to more sustainably fund, design, construct, and analyze housing (The Urban Institute 2019). In terms of financing, big data and predictive analytics has the potential to radically expand the housing market by allowing funding providers to provide mortgage lenders with more diverse and accurate data. The insight offered by these data could help combat fraud, streamline account servicing, accelerate assessments and offer a more inclusive lending framework. These refinements could have a significant on the 62 million people, including Millennials, immigrants and other marginalized constituencies in the US who have thin credit files, as well as the 26 million citizens who have no credit at all. By using emerging tools to incorporate new data sets, such as those associated with rental expenditures, utilities and streaming services, lenders may be able to offer loans to these communities in the future (Malik 2021). Not surprisingly, these tools and innovations are also impacting the design of homes, allowing architects

and designers to more capably model, test, and present their ideas. This not only allows potential homeowners to better understand and contribute to the design process, it also allows designers to more accurately assess the financial and environmental impact of their work. Similarly, drones and 3d scanners have the capacity to offer designers a more accurate and comprehensive understanding of complex sites and existing contexts, decreasing the time and cost associated with engaging these contexts (Brown 2021). Finally, emerging tools and technology are also impacting the construction industry, prompting vendors to supplement traditional approaches to home construction with those enabled by 3d printing, modular construction, digital fabrication and industrial-scale production. Although the impact of emerging technology on each of the three aspects of the housing delivery system described above is potentially significant, this study will focus upon the impact on this final category – construction – as it is arguably the most wasteful part of the process. Thus, it is also the phase with the most to gain through the incorporation of new tools and technologies.

2.0 FOUR HOMES: ASSESSING THE PROMISE OF EMERGING TECHNOLOGY

2.1. Methodologies

To understand the potential impact of emerging technologies upon the residential construction process in the US, the study presented by this writing will feature a comparative analysis of three recently completed homes, each of which was realized through the deployment of one or more of these tools. So that this comparative analysis might offer a fair comparison, several controls were established before determining which homes to study. First, as there are significant regional differences in the housing industry, the researchers determined that all selected homes had to be from the same area. Although any specific location could suffice, this study chose to focus on housing in the Detroit metropolitan area – a center of manufacturing innovation and a city powerfully impacted by the current housing crisis. Second, as demonstrated by the data described earlier, the trends analyzed can change significantly over time. Because of this, the researchers had to establish a specific time period for the study. As the offered study was to focus upon the impact of emerging technologies, only houses currently under construction, slated to be complete one year or less from the time of this writing, were included. Third, although multi-family housing offers significant advantages relative to many of the factors considered above, only single-family homes and duplexes were considered in this study. This control was established due to the emphasis of the US consumer on these housing types, the massive wastefulness of this particular sector, and the potential gains that could be realized by refining it (Sarkar 2011).² Fourth, and perhaps most obviously given the focus of the study, each of the selected studies had to represent an innovative approach to housing delivery, based upon one or more emerging tools or technologies.

2.2. Comparative Baseline

Once these selection parameters were determined, a baseline for comparison had to be established. First, from a financial perspective, housing in Detroit can be an expensive endeavor, at least relative to other Midwestern cities. The average home in Detroit costs around \$230,000 to construct – a cost that is the second highest in Michigan (Home Builders Digest 2022).³ Dividing the Detroit housing market into tiers, the following trends emerge: standard stick-frame homes cost around \$225 per SF, high-end contemporary homes start at \$260 per SF, high-end provincial style homes start at \$320 per SF and modern homes cost at least \$500 per SF.⁴ These figures, which include both hard and soft costs, are all around 7% higher than the national average (Estimation Qs 2022). Soft costs, which include elements such as land, permits and design fees, are modest in comparison to the hard costs. They are also largely, excepting design fees, outside the control of the architect. Thus, this study focuses upon the hard costs, which, once parsed, reveal important differences in market segments: standard home construction runs at between \$100 and \$140 per square foot; premium grade construction costs between \$140 and \$180 per square foot, while luxury grade construction can cost as much as \$220 per square foot (Home Builders Digest 2022). Although all these averages are drawn from a recent, 2021 study, current inflationary trends require that the figures provided be adjusted to reflect current costs for the study. Using an 8% figure to account for inflation, the previously stated hard costs increase to between \$108 and \$151/SF for standard grade construction and \$151 to \$194/SF for premium grade. As the homes selected for this study would all be considered either high-end standard or low-end premium \$160 per SF in hard costs and \$240 per SF total was accepted as a baseline for comparison. In terms of time investment, according to the US Census Bureau it takes, on average, 9.4 months to build a single-family, contractor-built home in 2021 - an increase of 135% from 1971 - and 12.1 months to complete an owner-built home (US Census Bureau 2022). These numbers decrease a bit in the Midwest, where 8.3 months is required to complete a contractor-built home and 10.8 months for an owner-built home - numbers which include all phases of construction, from planning and permitting to construction and final walkthrough. As the homes included in this paper were all contractor-built, 9 months will be used as a benchmark. Finally, regarding environmental footprint, this study will use 4.4 pounds of waste per square foot of construction and 46,500 BTU/H/SF as a baseline, both of which are figures established as averages by the EPA (Center for Sustainable Systems 2021).

With these parameters and controls established, the case study subjects could be selected. So as to represent a range of approaches, and produce a more inclusive comparative analysis, each of the selected study subjects had to deploy a distinct, emerging technology as a primary vehicle for construction. Based upon this, and the concerns described earlier, three homes were selected, one of which is to be constructed using modular, reclaimed components, one using 3d printing, robotics and panelization and one utilizing digital fabrication and industrial-scale production.



Figure 5: The Elmhurst Duplex by Three Squared International leverages the use of reclaimed shipping containers to reduce the cost and time needed for construction. (Image courtesy of Three Squared International.)

2.3. Study 01: Elmhurst Duplex, Three Squared Incorporated (TSI, <https://www.threesquaredinc.com>)

Featured Technology: Modular Construction using Reclaimed Shipping Containers

Project Location: 2680 Elmhurst Street, Detroit, MI 48206

The first study subject is a duplex residence designed by Three Squared Incorporated (TSI), a Detroit-based firm specializing in cargo architecture. The Elmhurst Duplex, which is located in Detroit's Linwood Neighborhood, is a 2-story structure that provides 1,920 square feet of living space – an amount which is divided evenly between a 2-bedroom, 2-bathroom unit on the first floor and a nearly identical unit on the second level (Figure 5). As the Elmhurst Duplex is targeted for a veteran audience, the budget for the project had to be modest, prompting TSI to deploy several strategies to reduce cost, including building the entire project using reclaimed shipping containers. This is a subtle shift from most TSI projects, the vast majority of which include sections that are built using traditional, light-frame construction. In contrast, for this work, TSI elected to use only shipping containers to construct the project envelope – a limitation which had the potential to simplify their construction process and reduce the cost of construction. Judging from the current \$384,000 estimate to complete the Elmhurst Duplex, these efforts were at least somewhat successful, as the \$200/square foot price falls below the average for most TSI projects. It is also, importantly, 20% lower than the average cost for housing in the area, as established within the earlier section. In terms of timeline, although the repetitive nature of the floorplans likely reduced the timeline for the design phase, the current schedule indicates a 9-month construction process, which is well-aligned with industry averages. Relative to environmental savings, the TSI project will likely realize a significant reduction in the waste associated with construction due to its emphasis on prefabrication, as current studies indicate that this mode of working can eliminate 25% of construction debris (Ruibo et al 2022). However, the true environmental benefit for this work is likely associated with air exchange, as shipping containers are designed to be completely wind- and water-tight. This results in the vast majority of container-based projects, including the project on Elmhurst, outperforming the industry average in terms of air infiltration. In fact, the Elmhurst Duplex, like most TSI projects, will likely be so air-tight that fresh air returns will be required. This will likely allow the Elmhurst Duplex to outperform other comparable homes in the areas, in terms of both thermal comfort and energy use during occupation.



Figure 6: The components for the Sheridan Residence - the first project realized by Citizen Robotics and the first 3d printed home in Detroit – will be fabricated off-site and then shipped for installation. Over time, this method could greatly decrease the costs associated with home construction. (Image courtesy of Citizen Robotics)

2.4. Study 02: Sheridan Residence, Citizen Robotics (<https://www.citizenrobotics.org>)

Featured Technology: 3D-Printing, Robotics and Panelization

Location: 1444 Sheridan Street, Detroit, MI 48214

The second study focuses on a single-family home designed and fabricated by Citizen Robotics, a recent Detroit-based start-up that seeks to reduce the cost of housing by integrating robotics into the building delivery process (Figure 6). The Sheridan Residence is this firm's first built work, and the first 3d-printed home in Detroit. Designed by architect Bryan Cook of developARCHITECTURE, this one-story structure offers occupants 995 square feet of living space, including two bedrooms and a full bath. The walls for this structure are fabricated using 3d-printed elements, which are designed to be covered in stucco after installation. The roof will be made from SIPs, which will be fabricated by Insulspan, a Michigan-based company. In terms of cost, the Sheridan Residence is currently operating under an estimate of \$229,000. This equals \$230 per square foot – a number that is 4% less than current industry averages. This figure, however, likely masks the true economic benefit of the approach used in constructing the home, as robotics and 3d-printing are both technologies that scale well, potentially resulting in significant savings when developing multiple units at once. It is also an approach that is in its infancy, and thus ripe with opportunities to refine and make more efficient. This is a claim that obviously cannot be made by traditional, stick-built construction which, as a mature industry based upon approaches that have been around for almost a century, has little room to innovate. In contrast, robotics and 3d-printing will likely develop significantly over the next few years, allowing the associated construction techniques to become more efficient in the future. Even today, it is fairly clear how this approach might create greater efficiency. First, the digitized process privileged by robotics allows for a much more robust transfer of knowledge from one work to the next than does traditional construction. Second, as manifest in the building sections printed by Citizen Robotics, the accuracy of the prefabricated componentry generated by robotics allow for more work to be done off-site. In the case of the Sheridan Residence, all of the components delivered by Citizen Robotics are practically complete when they arrive on site, minimizing the cost associated with activities like rough carpentry and electrical work. This will allow firms using these technologies to reduce not only the financial footprint of housing in the future, but realize a significant savings in terms of timeline today. To be specific, current estimates indicate that the Sheridan Residence will be completed in just over six months, a 33% savings from current industry averages. From an environmental standpoint, the Sheridan Residence features a HERS (Home Energy Rating System) Index Score of 50, with an annual cost estimate for energy of \$1415, a savings of around \$1850 from the average home in the US.⁵ This is a noteworthy HERS rating, as a typical resale home scores 130 on the same scale. Using this as a comparison, the Sheridan Residence will use less than half the energy of an average home, resulting in not only a reduced environmental footprint, but significant financial savings for the homeowner. Importantly, this savings will likely only grow in the future, as the

technology and associated processes are refined in the next few years. The same can likely be said of other the energy benefits offered by this approach.



Figure 7: hoom, a recent, Detroit-based startup, leverages digital fabrication, generative design and industrial-scale production to reduce the economic and environmental cost of housing. Their first project, the Crandell Residence, will be completed in the spring of 2023. (Image courtesy of hoom)

2.5. Study 03: Crandell Residence, hoom (<https://ourhoom.com>)

Featured Technology: Digital Fabrication, Flat Pack, Industrial Production, Generative Design

Location: 3013 Cochran Street, Detroit, MI

The third, and final, case study analyzes a 1,930 square foot single-family home by hoom, a two-year old, Detroit-based design firm that uses digital fabrication, generative design and industrial-scale production to reduce the economic and environmental cost of housing. The Crandell Residence, which will be the first realized project by hoom, is a four-bedroom, three-bath structure, including both the main home and a connected, one-bedroom/one-bath auxiliary structure (Figure 7). The design of this home features a rigid, portal frame structural system with an industrially-produced metal envelope and a digitally-fabricated core containing all services, including kitchens, bathrooms, stairs and laundry. The current bid for this project, as provided by the general contractor, establishes a total project cost of \$380,000, or \$196.89 per square foot. This figure represents an over 20% savings when compared with current housing costs. The timeline for the project, once again provided by the contractor, stipulates a six-month timeline for construction – a number that is roughly 33% less than the current industry average in Detroit. Relative to environmental savings, the robust use of digital fabrication in this work, like the project by TSI, will likely reduce the waste associated with construction by between 20% and 25% (Ruibo et al 2022). In terms of energy use, the Crandell Residence will benefit from a high-performance thermal envelope, energy-star rated systems, and the inclusion of numerous passive heating and cooling strategies. It should be noted that these latter features were supported by the aforementioned generative design tools and simulations, allowing the design to maximize lumens while minimizing harmful heat gain. Arguably, these financial and environmental benefits, like those realized by the Sheridan Residence, should become more pronounced over time, as the technology utilized becomes more sophisticated and the associated processes more refined.

CONCLUSION

Based upon the comparative analysis above, it seems that all of the selected homes can accurately claim to provide more financially- and environmentally-sustainable approaches to housing production. More importantly, as each of the featured technologies and associated processes are still relatively new, it is highly likely that any future homes built using these approaches will realize even greater savings, in terms of cost, time, waste and energy. Thus, although the current audit indicates that the final approach studied, which realizes greater economic benefit than the other two projects while maintaining the efficiencies of production offered by robotics and waste offered by reclaimed containers,

one cannot state whether this approach will maintain this advantage over time. Thus, the conclusions offered by this study are likely better positioned as provisional, designed to offer understanding, not advocacy.

REFERENCES

- American Home Shield (AHS). 2022. "The 2022 American Home Size Index." Last modified May 2022. <https://www.ahs.com/home-matters/real-estate/the-2022-american-home-size-index/>
- Ball, Scott. 2022. "Luckey Ranch Subdivision." In Biediger, Shari. "Castroville Looks To Shape Encroaching Sprawl, Preserve Its Heritage." San Antonio Report, October 9, 2022. <https://sanantonioreport.org/castroville-sprawl-development-zoning/>
- Blanchard, S. Reppe, R. 1998. *Life Cycle Analysis of a Residential Home in Michigan*. Center for Sustainable Systems, Report Number CSS98-05, University of Michigan: Ann Arbor.
- Brown, John. 2021. "The Future of 3D Scanning: Predictions for 2021 and Beyond." Construction Executive, February 12, 2021. <https://constructionexec.com/article/the-future-of-3d-scanning-predictions-for-2021-and-beyond>
- Cilluffo, Anthony, A.W. Geiger, and Richard Fry. 2017. "More U.S. Households Are Renting than at Any Point in 50 Years." *Pew Research Center*, July 19, 2017. <http://pewrsrcr.ch/2vBv11C>
- Delgado, Michelle. "U.S. House Prices Are Rising Exponentially Faster than Income (2021 Data)." Real Estate Witch, May 18, 2022. <https://www.realestatewitch.com/house-price-to-income-ratio-2021/>
- Estimation Qs. 2022. "Building Costs Per Square Foot in the City of Detroit (MI), USA." Accessed September 14, 2022. <https://estimationqs.com/building-costs-per-square-foot-in-the-city-of-detroit-mi-usa/>
- Goldstein, Benjamin, Dimitrios Gounaridis, and Joshua P. Newell. 2020. "The Carbon Footprint of Household Energy Use in the United States." *Proceedings of the National Academy of Sciences*, edited by M. Granger Morgan. <https://www.pnas.org/doi/10.1073/pnas.1922205117>
- Home Builders Digest. 2022. "How Much Does it Cost to Build a House in Detroit?" Accessed July 15, 2022. <https://www.homebuilderdigest.com/cost-guide/michigan-cost-guides/how-much-does-it-cost-to-build-a-house-in-detroit/>
- Joint Center for Housing Studies at Harvard University. 2020. "America's Rental Housing 2020." Accessed June 22, 2022. https://www.jchs.harvard.edu/sites/default/files/reports/files/Harvard_JCHS_Americas_Rental_Housing_2020.pdf
- Laquatra, Joseph and Mark Pierce. 2011. "Waste Management at the Construction Site." In *Integrated Waste Management*, edited by Sunil Kumar. DOI: 10.5772/16501. <https://www.intechopen.com/chapters/17441>
- Malik, Sanjoy. 2021. "How Technology Is Breathing New Life Into the Mortgage Industry." *Forbes*, April 13, 2021. <https://www.forbes.com/sites/forbestechcouncil/2021/04/13/how-technology-is-breathing-life-into-the-mortgage-industry/?sh=6d18b849242e>
- Office for Policy Development and Research. 2017. "Leveraging Building Innovations for Housing Affordability." *Evidence Matters*, Spring 2017. Accessed June 30, 2022. <https://www.huduser.gov/portal/periodicals/em/spring17/highlight1.html>
- RESNET Home Energy Rating System (HERS). 2021. "Understanding the HERS Index." Accessed November 7, 2022. <https://www.hersindex.com/hers-index/understanding-hers-index/>
- Ruibo Hu, Ke Chen, Weili Fang, Linzi Zheng, Jinying Xu. 2022. "The Technology-Environment Relationship Revisited: Evidence From The Impact Of Prefabrication On Reducing Construction Waste." *Journal of Cleaner Production*, Volume 341. ISSN 0959-6526. https://www.sciencedirect.com/science/article/pii/S0959652622005212?casa_token=DG-Tz4MWTzQAAAAA:zesFBh6YpvNjY9Bnn7s7DU23KTHYqqVtHxxabIUxYk7lkinNCdQT8iF6z-HNdYsLiBdd7961cNo
- Sarkar, Mousumi. 2011. "How American Homes Vary By the Year They Were Built." Working Paper Number 2011-18. U.S. Census Bureau. June 2011. <https://www.census.gov/content/dam/Census/programs-surveys/ahs/working-papers/Housing-by-Year-Built.pdf>
- The Center for Sustainable Systems at the University of Michigan. 2021. "Residential Buildings Factsheet." Pub. No. CSS01-08. Accessed October 1, 2022. <https://css.umich.edu/publications/factsheets/built-environment/residential-buildings-factsheet>
- U.S. Census Bureau and U.S. Department of Housing and Urban Development. 2022. "Average Sales Price of Houses Sold for the United States [ASPUS]." Retrieved from the Federal Reserve Bank of St. Louis on November 16, 2022. <https://fred.stlouisfed.org/series/ASPUS>
- U.S. Census Bureau. 2022. "Average Length of Time from Start to Completion of New Privately Owned Residential Buildings." Accessed October 14, 2022. https://www.census.gov/construction/nrc/pdf/avg_starttocomp.pdf
- U.S. Energy Information Administration (EIA). 2022. "Electricity Explained: Use of Electricity." Last modified May 3, 2022. <https://www.eia.gov/energyexplained/electricity/use-of-electricity.php>
- U.S. Energy Information Administration (EIA). 2021. "Electricity Use in Homes." Last modified June 14, 2021. <https://www.eia.gov/energyexplained/use-of-energy/homes.php>
- U.S. Environmental Protection Agency (EPA). 2020. "Advancing Sustainable Materials Management: 2018 Fact Sheet." December 2020. https://www.epa.gov/sites/default/files/2021-01/documents/2018_ff_fact_sheet_dec_2020_fnl_508.pdf

- U.S. Environmental Protection Agency (EPA). 2021. "Construction and Demolition Debris: Material-Specific Data." Last modified December 21, 2021. <https://www.epa.gov/facts-and-figures-about-materials-waste-and-recycling/construction-and-demolition-debris-material>
- U.S. Environmental Protection Agency (EPA). 2009. "Estimating 2003 Building-Related Construction and Demolition Materials Amounts." Accessed October 1, 2022. <https://www.epa.gov/sites/default/files/2017-09/documents/estimating2003buildingrelatedcanddmaterialsamounts.pdf>
- Williams, Sarita and Sheryl Pardo. 2019. "Four Ways Technology Is Addressing the Housing Affordability Crisis." *Urban Institute*, November 14, 2019. <https://www.urban.org/urban-wire/four-ways-technology-addressing-housing-affordability-crisis>

ENDNOTES

¹ According to a recent analysis by the US Energy Information Administration, the number of British Thermal Units (BTUs) used by US housing increased from 5.08 quadrillion units in 1950 to 11.63 quadrillion units in 2021. Most of this energy is used to heat and cool these homes – a remarkable testament to the inability of these structures to provide comfort through intelligent design, instead of the infusion of additional energy (US Energy Information Administration 2021).

² According to the US Census, almost 80% of new homes constructed in the US are single family. This percentage has increased steadily since 1970, when just under 60% of new homes were single family (Sakar 2011).

³ Compared with other cities in Michigan, building a home in Detroit can be more costly. The average Detroit home is priced at \$234,090 — which is second to Grand Rapids with an average price of \$253,980. Flint is noted as the cheapest city in the state to construct a home with an average building cost of \$159,120. (Home Builders Digest 2022)

⁴ Tony McGuckin of the Trademark Building Company provided prices for their various tiers of custom home builds. Modular homes tend to start at around \$185 per square foot for a 1500-square-foot home. Mid-range homes, modular homes with high-end finishes, standard stick-built homes start at \$225 per square foot for a 2000-square-foot home. High-end custom homes can be further divided into three types – contemporary or ranch homes, which start at \$260 per square foot; high-end European provincial style homes, which often have modern looks and masonry exteriors, which are in the \$320 per square foot range; and finally, full modern homes, which cost \$500 per square foot and up. Another study indicates a similar breakdown: luxury single family \$369.03 per SF to \$565.71 per SF, with the average being \$435.51 per SF; semi-luxury single family \$224.28 per SF to \$343.79 per SF, with the average being \$264.68 per SF; best standard single family \$144.99 per SF to \$220.22 per SF, with the average being \$169.75 per SF; good standard single family \$105.81 per SF to \$162.27 per SF, with the average being \$124.88 per SF; minimum standard single family \$85.89 per SF to \$131.54 per SF, with the average being \$101.28 per SF.

⁵ More information about the HERS rating system can be found at <https://www.hersindex.com/hers-index/understanding-hers-index/>

Rules of Thumb for Sizing Horizontal, Diagonal, and Vertical Components of Parallel-Chord Steel Trusses

Cesar A. Cruz¹

¹Ball State University, Muncie, IN

ABSTRACT: Rules of thumb (ROT) are the most accessible calculations that an architect can use to determine initial size requirements for discrete structural components. In the architecture classroom, rule-of-thumb calculations can be highly valuable in demonstrating to students a direct correlation between a rudimentary physical dimension (e.g., the span of a beam or truss, or a column's height and tributary area) and that structural component's requisite size. When properly applied in studio projects, ROTs can demonstrate a higher level of technical competence, realism, and comprehensive thinking on the part of a designer.

An unusual gap in this area is that there are no ROTs for sizing the internal elements of a truss, that is, for the height and width of the top and bottom chords, diagonals, and verticals of a truss. The research behind this paper aims at developing ROTs for the horizontal, diagonal, and vertical components for a parallel-chord (i.e., flat), steel, roof truss. This is an ongoing research project with further refinements planned before its inclusion in a future book project, and its use in the field and architecture classroom.

The methodology behind this investigation began with a baseline or test truss that was subjected to randomly selected spans and loads. The crucial product from the analyses of the test trusses was a first set of ROTs. This set of rules were then tested against other truss types (Howe and Pratt trusses) subject to randomly selected spans and roof loadings. The end product from this study has been two types of ROTs: one type specifying a minimum and maximum range for the sizes of the individual truss pieces, and another type with only a single rule for those same individual truss pieces. Additionally, there are a small set of guidelines for the use of either type of rules.

KEYWORDS: steel truss design, rules of thumb

INTRODUCTION

The purpose of this paper is to develop a set of shorthand calculations (rules of thumb, or ROTs) for sizing the discrete components of one of the most basic truss types – the flat, long-span, steel, roof truss. On the way to formulating these technical aids, this paper first addresses the utility of ROTs for the designer engaged in the schematic design of a building, and for the architecture student and instructor in the classroom. Second, we review the available literature on structural ROTs, with a specific eye towards sizing steel trusses. Third, the paper outlines the boundary conditions, variables, and methods used to derive the sought-after ROTs for our truss type. Fourth, we present the outcomes of selected tests and the findings derived from them. Lastly, we will cover the grounds for further refinement of this study, and the potential for further research and application.

The expected outcome of this study has been the ability to relate the length from node-to-node of three central parts of a truss (i.e., that truss's top chord, bottom chord, and diagonal or vertical component) to that element's key cross-sectional dimension (its height). This is an ongoing research project with further refinements in mind before eventual publication and use in the field and architecture classroom. When finalized, however, the intended audience for these ROTs are practicing architects engaged in schematic design of the structures for their buildings, as well as architecture students and instructors working in the design studio, and seminar courses on structures or building systems.

1.0 RULES OF THUMB

1.1. The Utility of Rules of Thumb

The purpose of a rule of thumb (ROT) is to help the architect or engineer determine the initial size of any of a number of building components. Such preliminary sizing assumptions will be useful during the schematic design of a building, for example, in realistically demonstrating the thickness of a floor or load bearing wall, the depth and width of a beam or girder, or the cross-sectional dimensions of a column. If these initial sizing determinations can make their way into a designer's 3D computer model or sketch plans, they can begin to transform a proposed building or space from a diagram to a more robust work of architecture. Put another way, the proper application of ROTs demonstrates a level of physical and material awareness in the mind's eye of the architect or engineer who can differentiate between a floor that is a pencil-line's thickness in diagram and one that shows an understanding of the relationship between that floor's span, materiality, and thickness.

Beyond the schematic design phase of a building project, the determination of all structural sizes will necessarily transition from the realm of the conceptual stage in the architect's computer or sketch pad to the rigorous calculations of the structural engineer. A host of reasons demand this transfer of responsibility, chief among them being legal liability, project cost, and safety. Nevertheless, though the structural design is primarily and ultimately the purview of the engineer and not the architect, it does not absolve the latter from designing without structures in mind. An architect should not and cannot (at least for the purposes of the Architectural Record Exam) design without some concern for his or her building's structures. To design without such regard is to be willfully ignorant. Furthermore, examples of the well-rounded and structurally minded contemporary architect abound, with Jeanne Gang, Shigeru Ban, Norman Foster, Renzo Piano, and Kenzo Tange, among others, coming to mind. Additionally, structural engineers-architects such as Pier Luigi Nervi and Santiago Calatrava have elevated to stratospheric levels the synthesis of structure and architecture.

As an architectural educator, I have found additional rationales for the utility of rules of thumb. Two overarching aims in my structures courses is not only to help students learn the technical details of building structures but also to develop an intuitive sense for the subject. The point of this dual strategy is for students to see beyond the facts, figures, numbers, and calculations. The point is to help students to see, as expressed by the Swiss architect Peter Zumthor in his book *Thinking Architecture*, "the basic things architecture is made from: material, structure, construction, bearing and being borne" (Zumthor 2006, 33). To this end, rules of thumb play an important part, as they can be highly valuable in demonstrating to students a direct correlation between a rudimentary physical dimension (e.g., a beam or truss span, or a column's height and tributary area) and that structural component's requisite size. When properly applied in studio projects, ROTs can demonstrate a higher level of technical competence, realism, and comprehensive thinking on the part of a designer.

1.2 Rules of Thumb for Structural Planning

In the realm of architectural building structures, there are two primary sources for rules of thumb, Schodek's *Structures*, and Allen and Iano's *The Architect's Studio Companion* (Allen and Iano 2012, and Schodek 2001). Though the technical approaches in *Structures* and *The Architect's Studio Companion* differ slightly, either approach is quickly grasped by anyone able to read and interpret a table or chart of basic technical data. However, since this study seeks to apply some of the best approaches of both sources, we will briefly orient the reader to both approaches.

The ROTs in Schodek's *Structures* rely on formulas that use the span L of a horizontal spanning system in order to calculate a minimum and maximum height for that structure (see Figure 1). For example, the height of a steel W-Shape beam lies between $L/18$ and $L/28$, where L is that beam's span length. So, a steel beam where $L = 24$ ft would yield a beam height of between 10.3 inches (for $L/28$) and 16 inches (for $L/18$). Schodek provides similar ROTs for a long list of horizontal-spanning structures in wood, steel, and concrete, such as space frames, plate girders, open-web joists, arches, domes, waffle slabs, etc. In any case, formulas such as these are among the simplest and fastest ways to determine an initial structural size for any of a number of structures. Additional information would be beneficial, such as guidance on beam widths and standard dimensions, so as to fully determine a structural cross-section for our desired beam. Such information is readily available in *The Architecture Studio Companion*.

Allen's and Iano's *The Architect's Studio Companion* utilizes a series of charts and graphs (see Figure 2) that will yield similar information to the formulas in *Structures*. The two authors provide several different chart and graph types, but to follow the beam example in the previous paragraph, within this approach a vertical line (corresponding with the beam span) will rise vertically from the bottom of the graph. That line will then intersect in two points a curve at the center of the graph. Those two intersecting points are to be followed to the left of the chart, and where they land on the left-hand side will determine the maximum and minimum range for that beam's height. In this case, a steel beam with a 24-foot span (represented along the bottom of the graph) would lead to a beam height between 12 and 14 inches (indicated by the figures on the left side of the graph).

Typically, the chart such as the one shown in Figure 2 is accompanied on the same page of *The Architect's Studio Companion* by several explanatory notes. For a steel beam this includes notes on standard structural sizes (e.g., increments of 2 inches for W-Shapes up to 18 inches tall, then in increments of 3 inches) and the relationship between a beam height and its width (i.e., a beam's width is normally $1/3$ to $1/2$ of its height). With one page dedicated to each kind of structure in a particular building material (i.e., wood, steel, reinforced concrete, and masonry), Allen's and Iano's data sheets amount to a thorough tutorial on sizing most any kind of structure in a variety of material options.

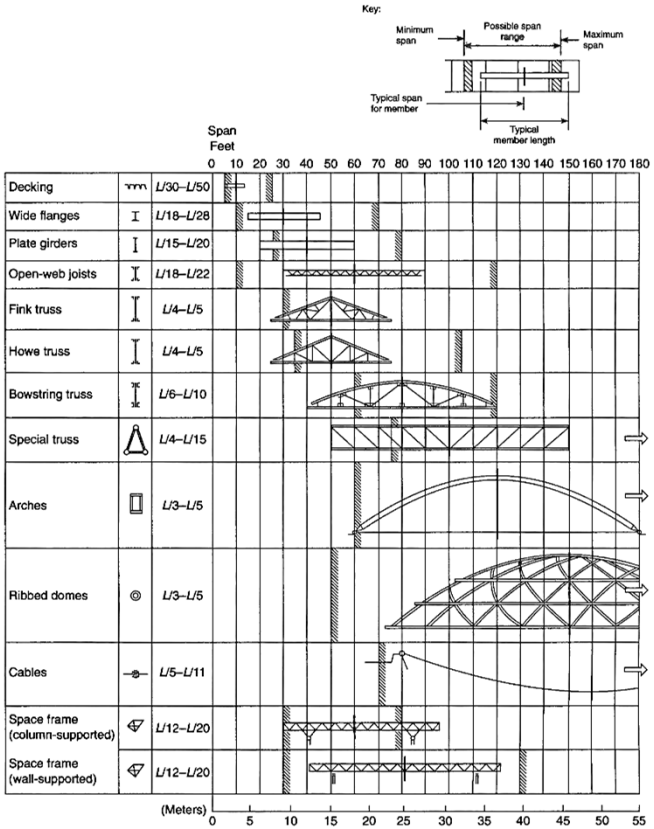

Figure 1: Rules of thumb for steel structures in Schodek's Structures (Schodek 2001).

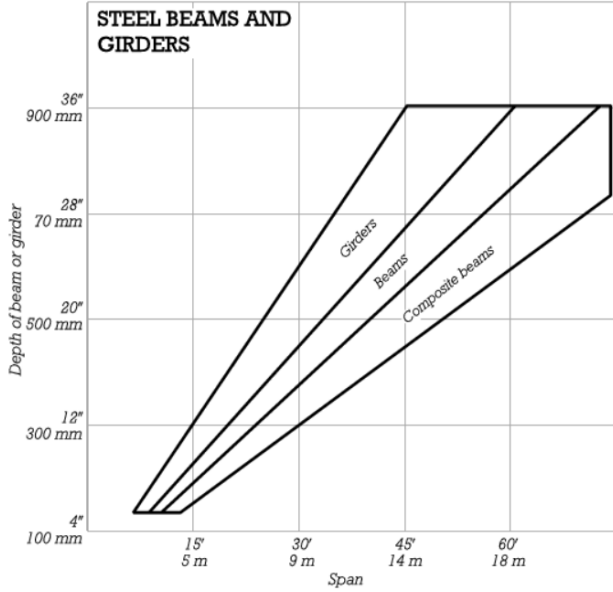

Figure 2: Rules of Thumb for steel beams and girders in Allen and Iano's The Architect's Studio Companion (Allen and Iano 2012).

1.3. Truss Rules of Thumb

As I have often remarked in my structures courses, there seem to be no limits as to what a truss can look like. There are, however, a great many standard truss shapes and configurations. Furthermore, each shape and configuration comes with its own rule-of-thumb formulas. The height for the truss under consideration here varies in some texts between $L/10$ and $L/15$ (Benjamin 1991; Eggen and Sandaker 1995). Schodek expands that range to between $L/10$ and $L/20$ (Schodek 2001). The most common referenced, including by each of the authors already cited in this

paragraph, is $L/10$ (Melaragno 1981; Silver, McLean, and Evans 2013). Being based on a unit of 10, this ROT lends itself quite well to ten square panels and 45-degree diagonals across the span of any truss. Due to its wide acceptance and ease of use, the work in this paper utilizes the ROT $H = L/10$.

An unusual gap in the area of structural planning is that there are no ROTs for sizing the height and width of the top and bottom chords, diagonals, and verticals of any truss. This gap in our knowledge has been pointed out by students engaged in studio assignments and semester projects in my own structures courses. Hence this study.

2.0 BOUNDARY CONDITIONS, VARIABLES AND FORMULAS, AND METHODS OF ANALYSIS

2.1. Study Boundary Conditions

Project assumptions are divided into two categories: (1) a set of general considerations and (2) a smaller set of considerations for the design of the test truss.

General project considerations consisted of the following:

- This study will rely on Load Resistance Factor Design methods rather than Allowable Stress Design due to the limiting nature of truss components in compression and to LRFD's simplified approach to axially-loaded compression members.
- Trusses must support a combination of dead, snow, and wind loads as per the 2021 International Building Code and the American Society of Civil Engineers Standard No. 7-16.
- Spans under investigation will range between 100 and 200 feet.
- Truss depths or height H will conform to the rule of thumb $H = L/10$, where L is the truss span.
- A point load will bear upon every node along the length of the top chord, thus point loads will also be spaced at an interval of $L/10$.
- Sizing for each truss component will follow the standard convention of the basic stress equation $f = P/A$ for tensile members and a slenderness ratio KL/r analysis for compressive members.
- Each structural component of a truss (each truss's top chord, diagonals and verticals, and bottom chords) will be sized uniformly depending on the largest compressive or tensile load being carried by each component type. Put another way, for example, the top chord of a truss will be a uniform size along its length despite different segments of the top chord will carry differing loads or forces.

Test trusses are trial runs with an eye to formulating baseline rules of thumb. In sections 2.2 and 2.3 below, Test Truss Trial No. 3 (TTT#3) will serve as the illustrative example. The variables used in each formula and calculation are listed in Table 1. The considerations behind the test truss are as follows:

- The baseline test truss is a Warren truss with diagonals at 45 degrees and verticals at an interval of $L/5$, that is, every other node (see Figure 3).
- The vertical pieces are in place to mitigate buckling in the top chord segments, all of which are in compression.
- This test truss is presumed to be one in a series of trusses parallel to each other in order to support a notional roof that is of an indefinite length. The width of the roof would equate to the span length of each truss.
- The roof's structural plane will rest on a series of roof beams that themselves rest on each of the nodes on the truss's top chord. Thus, those beam reactions turn into the point loads on the test truss.
- The spacing or interval in between two trusses will be $1.5X$ the truss height. This spacing also equates to each beam's span.
- Each point load on the truss will be a combination of the Total Load $T.L.$ as well as the weight of the roof beams attached to the truss at those nodes.

2.2. Truss Loadings and the Determination of a Point Load on a Truss

As per the 2021 IBC, the principal planning loads or Total Load $T.L.$ for any roof are its Dead, Snow, and Wind loads, determined by the maximum of one of two possible combinations,

$$T.L. = 1.2 D + 1.6 S + 0.5 W \quad [1]$$

$$T.L. = 1.2 D + W + 0.5 S \quad [2]$$

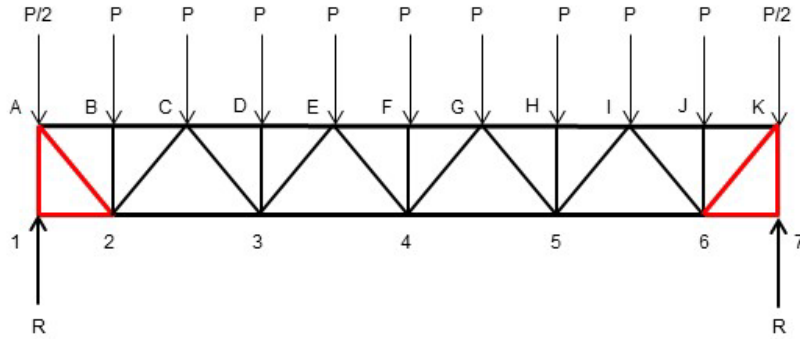

Figure 3. The general Test Truss. Segments A1, A2, K6, and K7 shown in red are considered to be part of the truss end supports, and thus outside the scope of this study. No attempts were made to size these components. Segments 12 and 67 are zero-force members, and thus also not germane to this study. After an initial round of tests, calculations, and member sizing, zero-force verticals (not shown) were added underneath nodes C, E, G, and I in order to match the segment lengths between the top and bottom chords. (Image by the author.)

Table 1: Project variables.

Variable	Description
D	roof dead load, in lbs/ft ² or psf
S	roof snow load, in lbs/ft ² or psf
V	design wind speed, in lbs/ft ² or psf
W	wind load, in mi/h or mph
T.L.	total roof load, in lbs/ft ² or psf
L _T	truss span, in ft
H	truss height, in ft
i	interval in between trusses (also equal to L _B), in ft
L _B	span of roof beam in between two trusses, in ft
w	uniformly distributed load upon a roof beam, in lbs/ft or k/ft
t.w.	tributary width of a roof beam in between two trusses, in ft
R _B	beam reactions, in kips
P	external point load on a truss node, in kips
Z _x	beam Plastic Section Modulus
P'	external point loads plus the weight of roof beams in between trusses, in kips
l	node-to-node length of an individual truss segment, in ft
h	the height of a strut or tie in a truss, in inches

The Dead Load *D* for each truss was set at 10 lbs/ft² for a “conventional built-up roof” (Allen and Iano 2004, 616). Material weights for this Dead Load were sourced from Ambrose and Tripeny’s *Simplified Engineering for Architects and Builders* (Ambrose and Tripeny 2016). The randomly selected span *L_T* for TTT#3 was 178 feet. Its randomly assigned location was the state of North Dakota, with a maximum Snow Load *S* of 60 lbs/ft², a maximum design wind speed *V* of 110 mi/h, and consequently a Wind Load *W* of 30.98 lbs/ft². The latter was determined through the following wind load equation:

$$W = 0.00256 V^2 \tag{3}$$

For TTT#3, the maximum Total Load *T.L.* is 123.52 Kips, a snow-heavy loading determined by Formula no. 1 over Formula no. 2. To finally determine each point load *P* on the truss, there are a series of calculations related to the roof beams. These include the beam length or span *L_B* (equal to the truss interval *i* between trusses), the beam tributary width *t.w.*, uniform load *w*, and reactions *R_B*, and the point load *P* that is finally transferred unto the truss. All of these are related to the truss height *H*.

$$H = L_T/10 \tag{4}$$

$$L_B = i = 1.5 H \tag{5}$$

$$t.w. = H \tag{6}$$

$$w = (T.L.)(t.w.) \tag{7}$$

$$R_B = (L_B)(w) / 2 \tag{8}$$

$$P = 2 R_B = (L_B)(w) = (L_B)(T.L.)(t.w.) = (L_B)(T.L.)(H) \tag{9}$$

All of these calculations lead to the following:

- a truss height (H) of 17.8 ft
- beam length or span (L_B) of 26.7 ft
- beam tributary width (t.w.) of 10 ft
- uniform load (w) of 1,234.9 lbs/ft
- beam reactions (R_B) of 29.35 kips
- a point load (P) of 58.69 kips on each top chord node

One final load calculation is an adjustment to the point load P' , which is to also include the self-weight of the roof beam. This particular roof beam yields a Plastic Section Modulus Z_x of 52.23 in³, resulting in a W 16 x 31 steel beam. When we incorporate the weight of this beam atop the previously calculated point load, we get an adjusted point load P' of 59.52 kips. This point load falls atop TTT#3 nine times with additional half loads at the ends due to the roof beams having half tributary widths and the roof's edge.

2.3. Calculating the internal forces of a truss, and sizing the chords, diagonals and verticals

With the value of the adjusted point load P' on hand, we can solve for the internal truss forces, size the individual truss components, and determine the applicable ROTs for TTT#3. The first part is accomplished through the application of the method of joints, whereby each truss node is transferred into a concurrent force system and the unknown forces are resolved through a series of equilibrium equations – a standard exercise in our basic structures courses. That is repeated from one node to the next until all internal forces are resolved.

The key pieces under consideration were the maximum forces acting upon the top chord, the diagonals in compression, and the bottom chord. (In terms of the truss verticals and other diagonals, the test trusses demonstrated that the compression diagonals drove the sizing of all of these internal pieces, so the verticals in compression and tension diagonals did not factor into the sizing considerations.) For TTT#3, these forces amounted to 744 kips for top chord segments EF and FG, 294.61 kips for diagonals C2 and I6, and 714.24 kips for bottom chord segments 34 and 45. As compression members, the top chord and diagonal segments were subjected to a slenderness ratio analysis in order to find the right combination of member length, cross-sectional area, and compressive stress to handle the given internal force. This analysis yielded a Rectangular Hollow Structural Section (HSS) of 16 X 8 X ½ for the top chord and a Square HSS of 8 X 8 X ½ for the compression diagonal.

At the bottom chord the maximum internal force was 714.24 kips at segments 34 and 45. The required cross-sectional areas for these segments were determined through the reworked stress equation, $A = f \times P$, where f was an allowable tensile stress of 45 kips/in² (assuming a steel yield stress F_y of 50 kips/in²) and P amounted to the aforementioned 714.24 kips. This process led to a Rectangular HSS with a required cross-sectional area of 15.87 in², resulting in a Rectangular HSS of 10 X 8 X ½.

The final piece to the TTT#3 puzzle was to turn this sizing information into workable ROTs. The desired format was a ratio of segment length l to its height h . For the top chord segment, with a length of 17.8 feet (or 213.6 inches) and a height of 16 inches, it led to a ROT of $h = l/13.35$, or more simply $h = l/13$. For the compression diagonal in TTT#3, $h = l/38$, and for the bottom chord segment $h = l/43$.

3.0 TEST RESULTS AND FINDINGS

The process described in sections 2.2 and 2.3, and through formulas nos. 1-9, was repeated with the test trusses 28 times. Halfway through these trials, however, the widths of the top and bottom chords selected were occasionally narrower than the widths of the diagonals, thus creating an assembly issue. This invalidated several trial runs and their associated ROTs. Also, halfway through the test trials, we added additional vertical segments, now spaced every 17.8 feet, to nominally divide the bottom chord segments in half. After these changes there remained 23, 28, and 14 valid trials from which to form initial conclusions about top chords, diagonals, and bottom chords.

Subsequent to the test truss trials, similar analyses were conducted with Howe and Pratt trusses (see Figure 4 and Table 2). Results for the compression diagonals for the Howe trusses closely followed the test trusses, as a Howe truss is characterized by all of its diagonals being in compression. The range for the ROTs for the top and bottom chords expanded incrementally. In the cases of the Pratt trusses, there was yet another incremental change for all of the ROTs, with a trend towards marginally larger truss components.

Given the results in Table 2, we may now make a set of modest recommendations. When relying on ROTs for sizing a truss, the designer is advised to follow these simple steps:

1. Determine the truss height based on the well-established ROT $H = L/10$.
2. Partition the truss into ten square panels or top chord segments, with diagonals at 45 degrees.
3. Apply any of a number of standard truss patterns for the truss geometry (e.g., Pratt, Howe, or Warren with verticals).
4. When sizing the individual truss components, begin with the diagonals and verticals. Apply either a range for h between $l/32$ and $l/48$, or a median value where $h = l/38$. Size this segment as a Steel Square Hollow Structural

- Section. Use one size for all of the diagonals and verticals of the truss, with that size based on the length of the longest diagonal.
- Utilize a Rectangular HSS for the top chord. Size the top chord with a height according to the range for h between $l/12$ and $l/24$, or a median value of $h = l/18$, and a width equal to or greater than one side of the Square HSS used for the compression diagonal (arrived at in Step 4 above).
 - Though the ROTs for the bottom chord vary slightly from that of the top chord, the designer should feel free to use for the bottom chord the same Rectangular HSS as the top chord.

Note: The ROTs specified in the six steps above are based on the most restrictive case of the Test Trusses rather than the more lenient ROTs for the trial Howe and Pratt trusses.

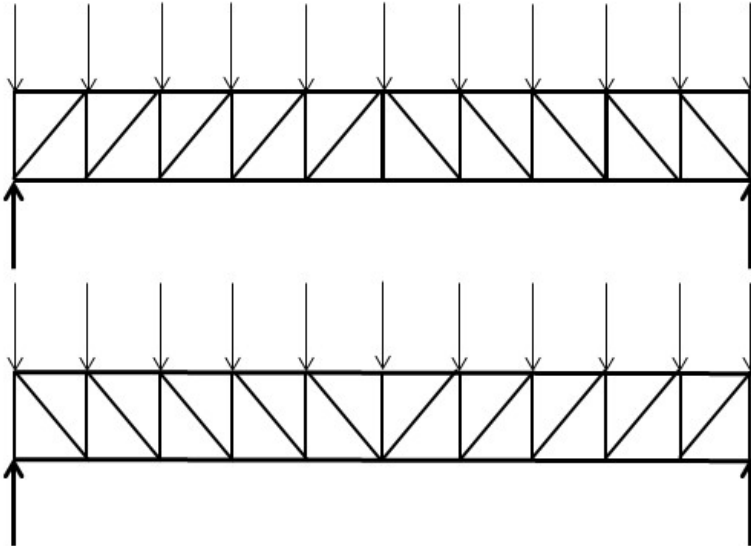

Figure 4. Howe (top) and Pratt (bottom) truss configurations. (Image by the author.)

Table 2. Rules of thumb emerging from three truss types.

Truss Type	Truss segment	no. of trials	ROT Range	Average ROT
Test Truss	Top Chord	23	$l/12 - l/24$	$l/17$
	Diagonal in compression	28	$l/32 - l/48$	$l/40$
	Bottom Chord	14	$l/12 - l/24$	$l/19$
Howe	Top Chord	14	$l/9 - l/24$	$l/17$
	Diagonal in compression	14	$l/22 - l/48$	$l/36$
	Bottom Chord	14	$l/9 - l/24$	$l/18$
Pratt	Top Chord	14	$l/9 - l/29$	$l/19$
	Vertical in compression	14	$l/22 - l/41$	$l/32$
	Bottom Chord	14	$l/12 - l/29$	$l/21$

4.0 FURTHER WORK ON ROTs FOR STEEL TRUSSES

This study remains a work in progress. A key additional task for this project is to integrate into the study other truss designs, particularly a true Warren truss, with diagonals at 60 degrees and no verticals. This was originally planned for the study, but time constraints and other competing priorities precluded the inclusion of a Warren truss or trusses.

Next, a more robust statistical analysis over a greater number of test trials should be conducted to determine more precise ranges of ROTs for the different truss components. Such ranges will allow the designer to more carefully and thoughtfully consider factors such as long or short spans, or light or heavy roof loads into their sizing determinations.

One final area of further investigation is the ability to transfer the knowledge presented here to other trussing systems, such as a space frame, diagrid, or a trussed cantilever. These structures possess endless flexibility in terms of form making, structural expression, and – in the case of cantilever spaces – daring attempts at violating of the laws of gravity.

If our ROTs may be applied to the complexity of triangulated structures, which are more ambitious than the simple steel roof truss, it would be a valuable tool in the hands and mind of the ambitious architect or student with an eye towards the bold and experimental integration of architecture and structures.

REFERENCES

- Allen, Edward, and Iano, Joseph. 2012. *The Architect's Studio Companion, 5th Edition*. Hoboken, New Jersey: John Wiley and Sons.
- Allen, Edward, and Iano, Joseph. 2004. *Fundamentals of Building Construction, 4th Edition*. Hoboken, New Jersey: John Wiley and Sons.
- Ambrose, James, and Tripeny, Patrick. 2016. *Simplified Engineering for Architects and Builders, 12th Edition*. Hoboken, New Jersey: John Wiley and Sons.
- The American Society of Civil Engineers. 2016. *ASCE/SEI 7-16, Minimum Design Loads and Associated Criteria for Buildings and Other Structures*. Reston, Virginia: The American Society of Civil Engineers.
- Benjamin, B.S. 1991. *Statics, Strengths and Structures for Architects*. Lawrence, Kansas: Ashnorzen Bezaleel Publishing Co.
- Eggen, Arne Petter and Sandaker, Bjorn Normann. 1995. *Steel, Structure, and Architecture*. London, England: Phaidon Press.
- The International Code Council. 2021. *2021 International Building Code (IBC)*. Country Club Hills, Illinois: ICC Publications.
- Melaragno, Michele. 1981. *Simplified Truss Design*. New York, New York: Van Nostrand Reinhold Company.
- Schodek, Daniel. 2001. *Structures, 4th Edition*. Upper Saddle River, New Jersey: Pearson.
- Silver, Pete; McLean, Will; and Evans, Peter. 2013. *Structural Engineering for Architects: A Handbook*. London, England: Lawrence King Publishing Inc.
- Zumthor, Peter. 2006. *Thinking Architecture*. Basel, Switzerland: Birkhauser.

Simulation Parsing for Optimal Daylight and Radiation Thresholds: A Case Study

Eiman Graiz¹, Keith Van de Riet¹

¹The University of Kansas, Lawrence, KS

ABSTRACT: Increasingly, design decisions are being made in association with targeted needs for improved sustainability and performance in the built environment. As a result, simulation and analysis tools are more accessible than ever to the architect/designer. However, there often exists a knowledge gap that arises in the application of these tools and the translation of output data into usable design criteria. In this regard, effective simulation tools that streamline data to inform design decisions within a variety of complex contextual conditions have become critical, yet the bridge between scientific data and practical application remains in many cases. Environmental challenges, such as urban heat island and losses in biodiversity, have become essential to planning for long-term sustainable (and regenerative) cities. More holistic management of urban ecosystems requires tools that support better-informed regulations and design guidelines to promote the integration of various approaches toward healthy, diverse, and integrated natural systems, as well as optimized energetic needs. This paper investigated the translation of output data from daylighting and radiation simulations into partitioned thresholds that align with specific applications pertaining to urban greenery and energy harvest in cities. More specifically, we established a systematic framework using The Ladybug Tools (Ladybug) for Rhino and Grasshopper to generate daylight and radiation maps that contain parsed threshold data that can be paired with specific design criteria. The study introduces a concept for applying this parsing approach to urban greenery, where plants can be categorized as shade, partial shade, or full sun tolerant and can be coupled with simulation results for strategic planting across urban landscapes. Similarly, radiation maps that were parsed for specific photovoltaic system thresholds were generated with the tool. We applied the concept to case studies in New York City to demonstrate the tool within dense urban contexts and to visualize the latent energy potential of surfaces within a large city. The simulation tool can generally improve sustainability within the built environment at multiple scales, ranging from single building and plot applications to urban design and landscapes.

KEYWORDS: ladybug, simulation, urban greenery, environmental design.

INTRODUCTION

More than half of the people in the world and more than 80% of people in the United States and Canada live in cities and their suburbs (Brown and Corry 2020). United Nations estimates that by 2050, the world's urban population will reach around 67% (Raji, Tenpierik, and van den Dobbelsteen 2015; Wei et al. 2021). Urban areas are characterized by a small proportion of green space and a large proportion of artificial and impervious surfaces, leading to many environmental issues such as urban heat island (UHI) and heat waves. The air temperature in urban areas can be 6°C warmer than the air in rural areas since the material of buildings and paved surfaces absorb, retain, and reradiate more solar energy than natural vegetation (Raji, Tenpierik, and van den Dobbelsteen 2015; Sheweka and Magdy 2011; Fikfak et al. 2020). Researchers found that the average temperature difference reached 1–7 °C between urban greenspaces and the surrounding areas (Zhou, Cao, and Wang 2019). Moreover, the UHI in dense urban areas can be related to one or more factors, such as canyon geometry (urban canyon), building materials, greenhouse effect, anthropogenic heat source, and wind pattern. Furthermore, the lack of evaporative cooling methods in cities, such as that resulting from vegetation, is also a significant cause of UHI (Sheweka and Magdy 2011).

According to Yeang and Powell, the balance between biotic and abiotic in the built environment should be maintained throughout the planning and design process (Yeang and Powell 2007). That could be achieved by improving biomass levels and biodiversity and making ecological connections in the built environment (Raji, Tenpierik, and van den Dobbelsteen 2015; Yeang and Powell 2007). Moreover, if cities are looking to accommodate a large group of people in one specific area by building upward, then the optimum design requires replicating the ground floor atmosphere up in the sky, including green spaces and sidewalks (Fikfak et al. 2020). In some cities, and due to geographical constraints and political boundaries, it is impossible to expand horizontally, so planners had to extend the cities vertically, causing increased building density. This situation compounded the shading from the adjacent buildings, decreased the amount of natural lighting that reached these areas, and worsened the ventilation quality (Goharian, Daneshjoo, and Yeganeh 2022). Moreover, buildings offer a large area of surfaces that could serve as spaces for vegetation in urban cities. Planting on roofs and walls has become one of the most innovative and rapidly developing fields in ecology and the built environment (Wong et al. 2010).

This paper investigates the ability to parse the output data of daylight and solar radiation simulations to improve urban greenery in dense cities. We used a simulation methodology by considering the sun as a weather variable, while future studies will consider other weather variables, such as wind, rain, and humidity.

1.0 BACKGROUND

Urban areas have many categories of hard surfaces, which increase the urban heat island and negatively impact the environment. However, these surfaces can respond to environmental problems; the city's hard surfaces could regulate temperature, filter the air, and generate energy. The surface area of roofs accounts for nearly 20–25% of overall urban surface areas, and the building façades cover vast amounts of square footage, which reach 20 times the roof surface area in highrise buildings (Besir and Cuce 2018). Therefore, the building façade could be repurposed to reduce UHI by offering a base to accommodate different sustainable concepts.

Vegetation has different benefits in the urban environment; it can improve the microclimate, conserve biodiversity, reduce air pollution, improve the aesthetic value, influence the psychological behavior of city dwellers and improve human health (Wei et al. 2021). The microclimate in an urban space is affected by the adjacent buildings and landscape elements and by the complex interactions between them, which could affect the amount and quality of light in a specific area. The microclimate created by sun and shade patterns could affect the temperature, soil moisture content, and plant growth (Johnson County Extension Master Gardeners 2002). For example, researchers found that a shaded area can be 1–4 °C cooler than a sunny area in different geographical areas such as Singapore, Tokyo, and Mexico City (Hamada and Ohta 2010). However, the type of shade can be described by the light intensity falling on a specific area. Thus, the shade pattern can be classified into three main categories: (1) full shade areas that receive fewer than two hours of light, and some reflected ambient light from the surrounding surfaces, (2) partial shade areas receive between two and six hours of light, and (3) full-sun areas that receive direct sunlight for more than six hours daily (Carey 2017). Each category can host different vegetation types and accommodate different sustainability concepts.

The greenery systems are still the most appropriate and the most efficient sustainable solutions to resolve urban heat island-related problems. The most common concepts for building greenery are green roofs, green walls, green balconies, sky gardens, and indoor sky gardens. However, most published articles focus on rooftop gardens and green walls more than the other greenery concepts (Wong et al. 2010; Besir and Cuce 2018). Another contemporary concept regarding greenery is "bioclimatic design," which has become popular recently. According to Ken Yeang, bioclimatic design is the passive low-energy design approach that uses the ambient energies of the local climate that create conditions of comfort for the building users (Yeang, 1999). Yeang also redefined the skyscraper as a building that could be ecological instead of a symbol of aggressive consumption.

Moreover, the bioclimatic design's main objective is to be energy efficient and improve user comfort. The bioclimatic concept becomes essential in the design of highrise buildings, where the problems coupled with changes in microclimate increase with height (Pietrzak 2015). Designing a bioclimatic building depends on analyzing all factors of the local microclimate and their daily and seasonal changes. However, the essential parameters to study are solar radiation, temperature, air circulation, and water balance (Zielonko-Jung, 2013). Furthermore, selecting adaptive plants more efficiently based on their ecological needs has become a research focus and challenge (Wei et al. 2021).

Numerous researchers have utilized simulations to study the integration of urban greenery. For example, a simulation study was conducted to improve the urban vegetation at the campus of Glasgow School of Art. The campus has limited outdoor area and a lack of greenery, and therefore has a need to reduce the hard urban surfaces. Researchers studied the campus's building orientations, sun path, daylighting, and sun shading patterns. The result showed that the daylight and the shadow pattern allow for an effective green roof system. The simulation showed that the green roof could reduce CO₂ levels by over 10%, primarily through energy savings in building operation (Roongta and Noguchi 2009). Another study evaluated the energy savings of full-scale facade greening at six urban blocks. Each block had a different density and height. Two green-facade scenarios with 35% and 65% greening ratios and one baseline bare-facade scenario were proposed. The results showed that by adding greenery to the facades, the daily energy savings reached 3.2–11%. Among the six urban blocks, the mid-rise with low density and buildings with 65% greenery have the highest daily energy saving. Thus, shading provided by plants and substrates is the main reason for the energy-saving (Peng et al. 2020).

Renewable and clean energy sources within dense urban environments have become more critical. Simulation tools that maximize the return on investment for these technologies are becoming essential for their adoption. One example of an integrated greenery system is an algae-building technology. For instance, The BIQ house in Hamburg, Germany, is a four-story residential building with a penthouse and a gross floor area of approximately 1600m². The building integrates 200m² of closed photobioreactors in 120 facade-mounted boards generating algal biomass and solar thermal heat energy (Biloria and Thakkar 2020). This heat has 38% efficiency compared to 60–65% for a conventional solar thermal source, and the biomass has 10% efficiency compared to 12–15% with a traditional PV (Biloria and Thakkar 2020; Wilkinson et al. 2017). As microalgae absorb sunlight, the bioreactors act as dynamic shading devices for the building, thus increasing the system's benefits. The density of the algae depends on the algal species, the harvesting regime, and available carbon dioxide, as well as the available sunlight and the temperature of the growing solution

inside the bioreactors. The geographical site and the climatic conditions are essential factors as well. Furthermore, the algae grow faster when exposed to more sunlight providing more shading for the building. The algae façade created a thermally controlled microclimate around the building, reduced noise, and provided dynamic shading. In addition, the façade removes up to six tonnes annually of carbon dioxide (Wilkinson et al. 2017).

Researchers at Rensselaer Polytechnic Institute developed two technologies to improve solar energy utilization in glazed facades. The first project is the Building Integrated Concentrating Solar Façade System, a building-integrated photovoltaic system within a 'double-skin' facade. The main objective of this façade was to maximize the use of solar energy to reduce the energy consumption of the building by generating energy using PV cells, enhancing daylighting inside the building, and reducing the solar gain. The system consists of multiple concentrator modules within a glass façade or glass atrium roof of a building and are mounted on a highly accurate tracking mechanism. The system showed efficiency in producing energy, improving daylight, and reducing solar gain. In addition, the system's payback period is less than the existing solar systems (Dyson et al. 2007). The second project is Building Envelope System for Water Recycling, Purification, and Thermal Comfort, a stationary concentrating solar-driven hybrid system. The project's main goal is to reclaim the greywater in the building while decreasing the energy consumption and solar heat gain in glazed building facades. The system consists of Modular cast glass geometries with specific shapes to redirect and capture solar radiation, which provides interior shading and diffuse daylight spatial conditions. At the same time, the system is coupled with multi-barriers that decontaminate the building greywater effluent by inactivating pathogenic contaminants (Dyson et al. 2015). In both cases, the technologies rely on coupling the available solar resource with energy production and water remediation for increased sustainable performance of buildings. In this regard, a simulation tool for optimizing the deployment of such technologies would provide an increased return on investment.

Urban greening and forestry have recently received increasing attention, and plant selection in urban areas depends on numerous factors, such as soil, moisture, sunshine, climate, air pollution, pests, and diseases. Researchers at the University of Minnesota Extension Department expressed their concerns regarding the adaptability of urban plants, provided suggestions for tree selection, and aimed to improve plants' adaptability to the city (Wei et al. 2021). Moreover, scholars developed the Citree database that gives users the ability to study site characteristics and natural distribution, tree appearance, ecosystem services, management activities, and the risks and interferences caused by urban woody plants (Vogt et al. 2017). Using this database can lead to better ecological and economic costs. In addition, improving the concept of "the right plant for the right location" will enhance the floristic biodiversity within urban plantings. Furthermore, the adaptation of different plants to the local environment was explored in Utah and Michigan. The result showed that solar radiation and sunlight are essential for plant selection (Wei et al. 2021), and urban built-up areas affect the distribution of solar radiation and sunlight, which could affect the type and amount of vegetation in these areas.

As shown above, urban greenery can reduce urban heat island and improve the quality of the urban spaces in dense areas. At the same time, urban greenery selection criteria still needs more investigation. However, simulation tools do not easily translate available solar resources into species-specific design criteria, which presents challenges for designers that are not experts in these topics. This paper will follow a systematic framework showing the importance of classifying the building surface area into sub-areas depending on climatic parameters such as daylight and solar radiation to improve sustainability.

2.0 METHODOLOGY

Since computer simulation programs are accessible to designers and scholars, this study adapts one of the common and free simulation tools as the main method to conduct the research. This simulation uses The Ladybug Tool (Ladybug) 1.5 for Rhinoceros and Grasshopper to generate daylight and radiation maps that contain parsed threshold data that can be paired with specific design criteria. Ladybug is an open-source plug-in for Grasshopper/Rhino used to evaluate environmental performance and run energy simulations based on the U.S. Department of Energy (DOE) EnergyPlus engine, one of the industry's most effective simulation operators. Ladybug as EnergyPlus interface imports standard weather files (.EPW) of a specific location into Grasshopper. Utilizing this workflow, this research consists of three main steps: (1) contextual modeling, (2) solar radiation and daylighting analysis, and (3) parsing the result into different zones for specific value thresholds.

2.1 Contextual Modelling

According to the New York regulation guide, there are more than 80 types of commercial districts in New York. These districts are classified from C1-C8 with a wide range of uses, various densities, and scales ranging from one-story buildings to high towers. Each category has different building regulations depending on the use. Thus, C1 and C2 are neighborhood commercial districts, while C3, C7, and C8 are commercial districts with special commercial needs. C4, C5, and C6 serve a population larger than a single neighborhood and permit a wide range of commercial uses, including large retail stores, office buildings, hotels, and movie theaters. The floor area ratio (FAR) permitted in C4, C5, and C6 districts ranges from 1 to 15.0, and there is no limit for building heights. This paper will test C4, C5, and C6 districts since they include a wide range of building uses, heights, and densities. To run the simulation, we modeled an urban block of an area of 90,000 sq. ft (200 *450F), consisting of six identical mid-rise buildings (8 stories), with FAR of (3.4, 4, and 6) representing C4, C5, and C6 respectively (Table 1). The identical buildings have a North-South orientation and are aligned and evenly distributed.

2.2. Simulation of Daylight and Radiation

After modeling the blocks for each district, we set up the simulation conditions, which consist of the weather data, the analysis period, target geometries, context geometries, and the size of the analysis grid. New York City weather data was utilized, and all the buildings in the block were selected as the context geometries, which may cast shadow on the targeted buildings. Moreover, each tested surface was divided into 3x3 ft grids with a test point offset of 0.1 from the base surface. The simulation ran four times, each with one day analysis period for the solstices and equinoxes. Moreover, the same settings were used to simulate the annual solar radiation, and a cumulative sky matrix was generated.

Table 13: The simulation model specifications.

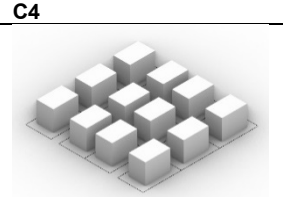
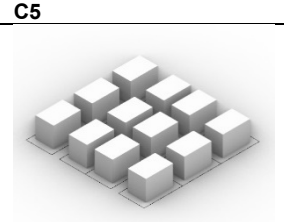
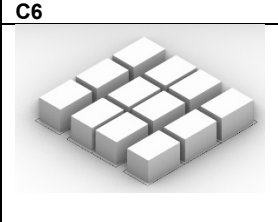
	C4	C5	C6
Building			
FAR	3.4	4	6
Floor area (sq. ft)	6,375	7,500	11,250
Total building area (sq. ft)	51,000	60,000	90,000
Number of floors	8	8	8
Building height (Feet)	80	80	80

2.3 Parsing Systems

After running the direct sun hours analysis, we divided the areas into the full shade (receive less than 2 hours of direct sun), partial shade (receive between 2-6 hours of direct sun), and full sun (receive more than 6 hours of direct sun). The simulation result showed that the annual solar radiation reached the simulated buildings ranges between 150-1450 kWh/m². Moreover, to divide the solar radiation areas, we considered two solar concepts; the photovoltaic system, which can be installed on facades that get at least 800 kWh/m², while 400 kWh/m² of solar radiation considered a reasonable threshold for solar thermal collectors (Lee, Lee, and Lee 2016). Thus, we divided the solar radiation areas into three main zones; areas with low radiation, less than 400 kWh/m². Areas with medium radiation, 400-800 kWh/m², and areas with high radiation, more than 800 kWh/m².

3.0 SIMULATION RESULTS

Each building façade was exposed to the sun for different hours depending on the facade orientation and the surrounding environments, which could cast shadows on the tested buildings. For example, the building could be located on the edge of the block, which makes the outward-facing façade at the edge get more sunlight hours than other buildings. In contrast, the building could be in the middle of the block and surrounded by other buildings, which increase the amount of shadow on the target building. In general, all the tested buildings have areas exposed to the sun for at least 1 hour and at most 15 hours for all tested periods (Table 2). Therefore, each district has a different percentage of sunlight on each façade. C6 has the largest percentage of fully shaded areas for all the tested periods, followed by C5 and C4, respectively. The highest percentage of the fully shaded area was on December 21, followed by September and March 21, and the least was in June for all the tested districts.

In contrast, C4 has the highest percentage of fully sunny and partly shaded areas, followed by C5 and C6, respectively, for all the simulation periods except for December, where C6 has slightly more full sun areas than C5 and C4, respectively. Moreover, the exact process was used to simulate the cumulative solar radiation that reached each district. As a result, C6 district received the highest percentage of high and low radiation areas, followed by C5 and C4, respectively. In contrast, C4 received the highest percentage of areas with medium solar radiation.

4.0 DISCUSSION

In general, rooftop areas have significantly higher solar radiation and direct sunlight than the façade areas. At the same time, buildings on the edge of the district block have higher radiation and sunlight than those in the middle of the block resulting from the shadow created by the surrounding environment. Moreover, the FAR of each district plays an essential role in increasing or decreasing the space between the buildings, affecting the amount of sunlight reaching the building facades. Each building has a different ratio of shaded area (Figure 1). Each area can be used to implement a unique concept to improve the building's sustainability. For example, algae-based technologies need direct sunlight to grow.

Furthermore, the return on investment for this type of technology declines with decreasing solar exposure characterized here as partly and fully shaded areas. In contrast, full sun areas will be the best to grow algae and get the optimum

performance, where the available sunlight affects the algae density. In this case, the building façade can improve the microclimate around the building, provide shading, and reduce noise. In the case of solar radiation, the spread of the three categories is different than the sunlight since solar radiation depends on the building's surface area. Thus, C6 received more radiation than C5 and C4, respectively, since buildings surface areas in this district are higher. By parsing solar radiation reaching each surface, it would be easier for landscape architects to select the best type of greenery in each radiation area. As well as other sustainable concepts could be implemented efficiently, such as mounting PV cells on the building façade.

Table 14. The simulation results for direct sun hours and total radiation on June 21, followed by parsed value maps for low, medium, and high exposures.

	C4	C5	C6		C4	C5	C6
Sunlight Result				Total Radiation			
Full Shade Area				Low Radiation Area			
Part Shade Area				Medium Radiation Area			
Full Sun Area				High Radiation Area			

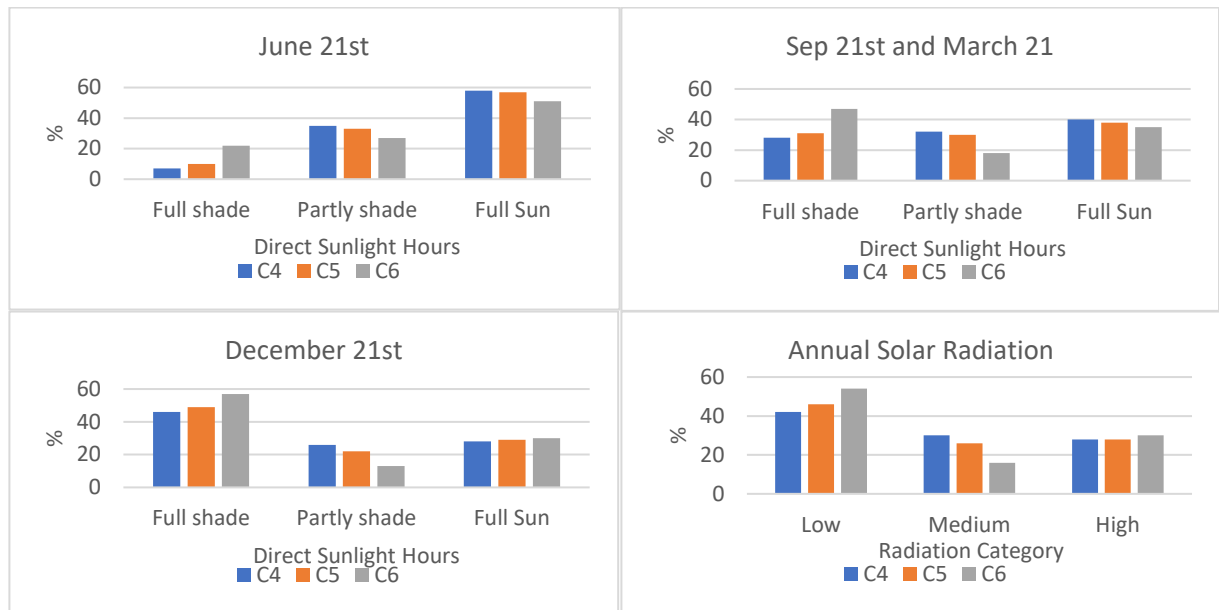

Figure 16: The percentage of sunlight areas in each simulated district in the solstices and equinoxes on the upper left and right, and lower left. The percentage of the annual solar radiation reaches each district on the lower right. Source (Authers 2023)

Recently, New York City released new climate legislation that new and existing buildings of more than 25,000 square feet should follow to limit greenhouse gas emissions. The vision of the law is to cut CO² emissions by 80% by 2050. Moreover, many iconic buildings in New York City required façade renovations within the past decade, such as 10 Jay Street in Brooklyn, United Nations Secretariat Building in Manhattan, and 63 Madison Avenue in Manhattan. Each building was renovated to achieve a specific goal and be more sustainable. The question is how these building facades could look in case the proposed parsing system was applied before the renovation? To answer this question, the proposed method was applied to the selected buildings.

4.1. Case study 1: 10 Jay Street

10 Jay Street was built in 1898 in Manhattan, consisting of ten floors and surrounded by mid-rise buildings from the west and south sides, the river from the north, and the harbor from the east. Due to these contextual conditions, the building's north and east facades are fully exposed to the sun, while the west and south facades get shadows from the surrounding buildings. Renovation was completed in 2019 by ODA to give it a modern sensibility and make it a landmark. Thus, the east, west, and south facades restored their historical masonry condition, while the north façade was renovated using glass and steel. Applying the parsing concept to this building showed that the building gets different amounts of sunlight and solar radiation (Table 3). The building façade surface area is around 114,241 sq. ft. (the area is approximate, as no data was available on the building).

The simulation results showed that 70% of the building facades and roof areas get full sun on June 21, 35% on September and March 21, and 15% on December 21. Moreover, the area which consider as partly shaded reached 18%, 16%, 15%, and 8% on March, September, December, and June, respectively. In contrast, during December, 70% of the building is fully shaded, followed by 50%, 48%, and 21% in September, March, and June, respectively (Figure 2). On the other hand, 39% of the building fall under the low solar radiation category, followed by 35% and 26% for medium and high radiation, respectively.

4.2. Case study 2: United Nations Secretariat Building

The UN Secretariat Building was built in 1952, consisting of 39 stories, and was renovated in 2012. One of the main goals for the tower renovation was to improve its energy efficiency and sustainability. Even though the building is located in a dense urban area, the distance between the tower and the nearest highrise building is more than 400 feet from all sides. This means the building façades get exposed to sunlight for a long time throughout the year. The building façade surface area is around 410,019 sq. ft. (the area is approximated from virtual survey).

The simulation results showed that a large percentage of the building facades and roof fall under the full sun category, reaching 90% and 81% for June and both September and March, respectively. Moreover, 67% of the building is partly shaded during December. In contrast, 17% is fully shaded for September, December, and March and decreased to 8% in June. On the other hand, 72% of the building fall under the high solar radiation category, followed by 15% and 13% for low and medium radiation, respectively.

4.3. Case study 3: 63 Madison Avenue

63 Madison was built in the 1960s in Manhattan, consisting of 15 stories with an area of 860,000 sq. ft. The building is located between 27th Street and 28th Street, which means it is surrounded by towers from all sides that cast shadows on the building's facades and roof and affect the amount of sunlight and solar radiation the building receives. In 2020, 63 Madison Avenue went through a design competition to explore ways to improve the building's environmental performance and sustainability. The vision was to cut building carbon emissions by half by 2030. The building façade surface area is around 262,647 sq. ft. (the area is approximated from a virtual survey).

The simulation results showed 42% of the building facades and roof areas get full sun on June 21, 17% in September, and 14% in March, while there is no sunny area through December 21 (Figure 3). Moreover, the area considered partly shaded reached around 20% for all tested dates except for December, which decreased to 10%. In contrast, most of the building façade and roof areas fall under the fully shaded category for all the tested dates except for June, which reached 38%. On the other hand, 70% of the building fall under the low solar radiation category, followed by 22% and 8% for medium and high radiation, respectively.

In general, the United Nations building has the largest façade area that could be used to apply green-faced concepts or use it to generate energy by applying algae concepts, PV systems, or any greenery for most of the year—followed by 10 Jay Street and 63 Madison, respectively. However, these buildings leave approximately 296,342 sq. ft, 298,45 sq. ft, and 197,40 sq. ft of surface area that receives more than 800 kWh/m² and could host PV systems. For example, if 300 Watt solar panels covered the previous areas, the buildings could produce approximately 35560.74, 3581.37, and 2368.78 kWh/ daily. At the same time, the buildings have 580,84 sq. ft, 519,93 sq. ft, and 394,85 sq. ft of areas that receive 400-800 kWh/m², which could help apply solar thermal collectors for 63 Madison, United Nations, and 10 Jay Street, respectively. Therefore, these buildings reflect the significant resources available on many buildings in a dense urban fabric like Manhattan.

On the other hand, the tested buildings get 42%, 71%, and 90% of full sun area during summer, which means 365,10 sq. ft, 392,20 sq. ft, 335,638 sq. ft of 63 Madison, 10 Jay Street, and the United Nations, respectively, which could be used to host different types of greenery, such as the algae systems introduced above. This vegetation could reduce the temperature in the urban context and decrease the solar gain inside the building.

Table 15. Sunlight simulation and parsing results for September 21st for the selected case studies.

	Urban form	Building	Daylight simulation	Full shade	Partly shade	Full sun	Proposed idea
10 Jay Street							
United Nation Building							
63 Madison							

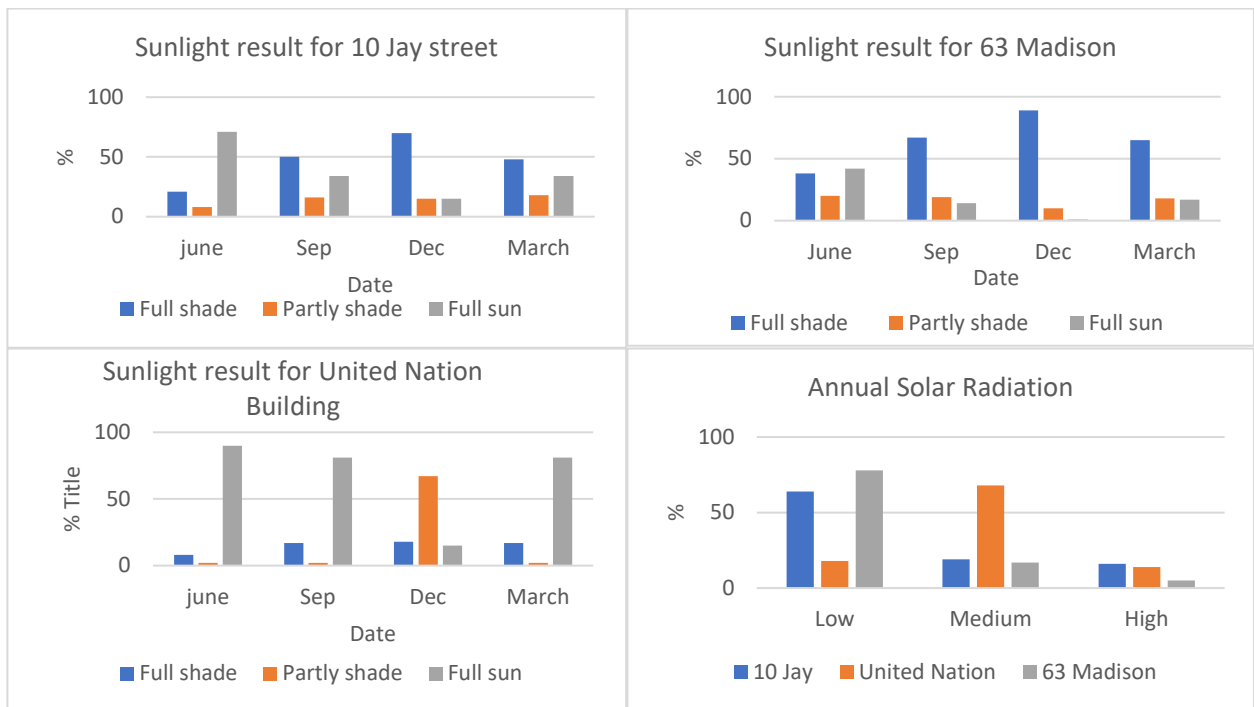

Figure 17: the percentage of sunlight and Solar radiation reaching each building during the solstices and equinoxes. Source (Authers 2023)

CONCLUSION

Dense urban areas and highrise buildings increase the built surface area and influence the ambient temperature, leading to many environmental issues and worsening global warming. This research showed that the parsing tool has future potential for improving building sustainability and enhancing design decisions. The proposed tool used software available for all designers and scholars despite their level of expertise, making it easy to use and applicable to implement.

This paper presented a parsing tool for design decisions related to how much solar radiation and sunlight reach each façade of each simulated building. The tool showed that the result could help decision-makers and designers improve their designs, with lifecycle performance as part of the process, and make their buildings more sustainable.

Furthermore, this tool connects design and botany and shortens the gap between industry and academia. By following this tool and adding it to the design process, designers could make better decisions on where to apply green walls and roofs and increase or decrease the area of glazed facades. Moreover, this tool simplifies the process of selecting the type of greenery in different architectural applications, where designers can choose from any climate-relevant greenery and tree database the ones categorized as full shade tolerance, part shade tolerance, or full sun tolerance and apply them on the correct location of the building. Thus, the tool is powerful and could be expanded to study many design concepts, such as cost-energy tradeoff analysis on improving the building glazing system (triple vs. double, Low-E, etc.), window frit location and design, building massing studies, shading louvers, exterior vegetation mounting systems, energy harvest systems, building façade retrofit, and program placement within a building for access to quality daylight. Future studies will test weather variables like wind speed and direction, and humidity, in addition to calculating the savings in energy and CO² emission.

REFERENCES

- Besir, Ahmet B., and Erdem Cuce. 2018. "Green Roofs and Facades: A Comprehensive Review." *Renewable and Sustainable Energy Reviews* 82 (February): 915–39. <https://doi.org/10.1016/j.rser.2017.09.106>.
- Biloria, Nimish, and Yashkumar Thakkar. 2020. "Integrating Algae Building Technology in the Built Environment: A Cost and Benefit Perspective." *Frontiers of Architectural Research* 9 (2): 370–84. <https://doi.org/10.1016/j.foar.2019.12.004>.
- Brown, Robert D., and Robert C. Corry. 2020. "Evidence-Based Landscape Architecture for Human Health and Well-Being." *Sustainability* 12 (4): 1360. <https://doi.org/10.3390/su12041360>.
- Carey, Jenny Rose. 2017. "Shade of Shades." *The American Gardener*, 2017.
- Dyson, Anna, Michael Jensen, Rensselaer Polytechnic Institute, Peter Stark, and Harvard Medical School. 2007. "Integrated Concentrating (IC) Solar Façade System."
- Dyson, Anna, Jason Vollen, Mark Mistur, Peter Stark, Kristin Malone, and Matt Gindlesparger. 2015. Solar Enclosure for Water Reuse. US 9090486 B2, filed November 30, 2011, and issued July 28, 2015.
- Fikfak, Alenka, Kristijan Lavtizar, Janez Peter Grom, Saja Kosanović, and Martina Zbašnik-Senegačnik. 2020. "Study of Urban Greenery Models to Prevent Overheating of Parked Vehicles in P + R Facilities in Ljubljana, Slovenia." *Sustainability* 12 (12): 5160. <https://doi.org/10.3390/su12125160>.
- Goharian, Ali, Khosro Daneshjoo, and Mansour Yeganeh. 2022. "Standardization of Methodology for Optimizing the Well Aperture as Device (Reflector) for Light-Well; A Novel Approach Using Honeybee & Ladybug Plugins." *Energy Reports* 8 (November): 3096–3114. <https://doi.org/10.1016/j.egyr.2022.01.176>.
- Hamada, Shuko, and Takeshi Ohta. 2010. "Seasonal Variations in the Cooling Effect of Urban Green Areas on Surrounding Urban Areas." *Urban Forestry & Urban Greening* 9 (1): 15–24. <https://doi.org/10.1016/j.ufug.2009.10.002>.
- Johnson County Extension Master Gardeners. 2002. "Knowing Your Yard's Sun and Shade Patterns."
- Lee, Kyung Sun, Jae Wook Lee, and Jae Seung Lee. 2016. "Feasibility Study on the Relation between Housing Density and Solar Accessibility and Potential Uses." *Renewable Energy* 85 (January): 749–58. <https://doi.org/10.1016/j.renene.2015.06.070>.
- Peng, Lilliana L. H., Zhidian Jiang, Xiaoshan Yang, Qingqing Wang, Yunfei He, and Sophia Shuang Chen. 2020. "Energy Savings of Block-Scale Façade Greening for Different Urban Forms." *Applied Energy* 279 (December): 115844. <https://doi.org/10.1016/j.apenergy.2020.115844>.
- Pietrzak, Joanna. 2015. "Recent Trends in Shaping Bioclimatic Skyscrapers in Europe." *PhD Interdisciplinary Journal*, 57–66.
- Raji, Babak, Martin J. Tenpierik, and Andy van den Dobbelen. 2015. "The Impact of Greening Systems on Building Energy Performance: A Literature Review." *Renewable and Sustainable Energy Reviews* 45 (May): 610–23. <https://doi.org/10.1016/j.rser.2015.02.011>.
- Roongta, Pragya, and Masa Noguchi. 2009. "A Feasibility Study for Greening the Glasgow School of Art's Bourdon Building Underused Rooftop Towards the Enhancement of Urban Vegetation in Glasgow," 5.
- Sheweka, Samar, and Nourhan Magdy. 2011. "The Living Walls as an Approach for a Healthy Urban Environment." *Energy Procedia* 6: 592–99. <https://doi.org/10.1016/j.egypro.2011.05.068>.
- Vogt, Juliane, Sten Gillner, Mathias Hofmann, Andreas Tharang, Sebastian Dettmann, Tina Gerstenberg, Catrin Schmidt, et al. 2017. "Citree: A Database Supporting Tree Selection for Urban Areas in Temperate Climate." *Landscape and Urban Planning* 157 (January): 14–25. <https://doi.org/10.1016/j.landurbplan.2016.06.005>.
- Wei, Heyi, Wenhua Jiang, Xuejun Liu, and Bo Huang. 2021. "A Digital Framework to Predict the Sunshine Requirements of Landscape Plants." *Applied Sciences* 11 (5): 2098. <https://doi.org/10.3390/app11052098>.
- Wilkinson, Sara, Paul Stoller, Peter Ralph, Brenton Hamdorf, Laila Navarro Catana, and Gabriela Santana Kuzava. 2017. "Exploring the Feasibility of Algae Building Technology in NSW." *Procedia Engineering* 180: 1121–30. <https://doi.org/10.1016/j.proeng.2017.04.272>.
- Wong, Nyuk Hien, Alex Yong Kwang Tan, Yu Chen, Kannagi Sekar, Puay Yok Tan, Derek Chan, Kelly Chiang, and Ngian Chung Wong. 2010. "Thermal Evaluation of Vertical Greenery Systems for Building Walls." *Building and Environment* 45 (3): 663–72. <https://doi.org/10.1016/j.buildenv.2009.08.005>.
- Yeang, Ken, and Robert Powell. 2007. "Designing the Ecoskyscraper: Premises for Tall Building Design." *The Structural Design of Tall and Special Buildings* 16 (4): 411–27. <https://doi.org/10.1002/tal.414>.
- Zhou, Wen, Fuliang Cao, and Guibin Wang. 2019. "Effects of Spatial Pattern of Forest Vegetation on Urban Cooling in a Compact Megacity." *Forests* 10 (3): 282. <https://doi.org/10.3390/f10030282>.

Soft Robotic Tessellated Origami Surface

Youness Yousefi¹, Vera Parlac²

¹University of Calgary, Calgary, AB

²New Jersey Institute of Technology, Newark, NJ

ABSTRACT: This project investigates the kinetic capacity of a tessellated origami surface by integrating pneumatic muscles into its pattern and structure. To become kinetic, architectural surfaces require an actuation system. Most often, actuation systems are mechanical or hydraulic. This project explores a pneumatic actuation system adapted from soft robotics to activate an origami surface and explore its kinetic capacity. Origami surfaces are inherently dynamic and offer an opportunity to design new dynamic spatial geometries that could transform in real-time. However, implementing this transformation requires rigorous experimentation and research in origami kinematics and its surface materialization. The research project presented in this paper proposes a novel approach to activate a tessellated origami surface by integrating pneumatic muscles into the origami structure unit modules. This study has two parts. During the first phase, the folding mechanism of a triangular tessellated origami surface is explored parametrically by utilizing Kangaroo and Grasshopper platforms. Phase two involves physical experimentation with a focus on developing and integrating pneumatic silicone actuators. The physical prototype has 12 embedded soft actuators. Its movement potential is studied through the inflation and deflation of different actuator groups (from 1 to 12 units) to generate a variety of geometric configurations. These soft actuators enable an intricate multi-directional movement of the origami surface without the complexity of a typical mechanical system. This research aims to understand the relationship between the surface geometry (unit module), the position of the actuator within a larger surface system, and the spatial configuration of the structure by comparing the digital and physical models. These three factors impacted the performance of actuators, and the global deformation of the surface determined a dynamic potential of an origami surface and its potential for use.

KEYWORDS: Responsive architecture, Kinetic, Soft robotics, Origami surface

INTRODUCTION

Historically, architectural surfaces are designed for stability and stasis. Consequently, conventional construction techniques strive to resist the influence of the changing environment, which often results in buildings that stand against and are independent of the environment. However, the next generation of buildings is expected to respond to the surrounding environmental conditions more effectively and even to contribute to sustainability by harvesting energy or water. Further, this contemporary trend towards responsive architecture can benefit from kinetic systems, which are a fundamental means to adapt to ever-changing environmental conditions and evolving occupants' needs (Kolarevic, 2015). However, designing and manufacturing kinetic systems depend on two factors: the movability of the element within the structure and the actuation that produces the movement (Kolarevic and Parlac, 2015).

Folding surfaces such as origami are intrinsically dynamic and promising for creating kinetic systems. To date, the potential of folding has not been widely employed in creating dynamic building surfaces. Nevertheless, the folding structure is becoming more attractive for engineering solutions and architecture, primarily because it is deployable and self-supporting. On the other hand, designers are increasingly fascinated by the adaptive potential of origami. Origami, the traditional Japanese art of folding uncut sheets of paper, offers continuous motion between the flat and folded state of pre-determined folding pleats (Comstock, 1963). This continuity enables origami to accomplish a smooth shape transformation, a characteristic used to create adaptive shading systems or deployable shelters (Fox and Kemp, 2009). For example, the Mashrabiah facade on the Al-Bahar tower in Abu Dhabi is an abstracted kinetic version of a tessellated origami.

Mechanizing large-scale folding motion in a building is challenging since most traditional materials and connections do not have an intrinsic propensity for movement. In contrast, the folding action of an origami surface, such as in a triangular tessellated pattern, produces a surface that moves in all three axes (3D). To move such a surface using traditional mechanical components would require a complicated assembly of linear mechanical actuators. This would also make the structure heavier, consume more energy as it moves, and require robust maintenance (Körner et al., 2017). Pneumatic soft actuators are flexible and can move in all three axes through particular inflation and deflation pattern (Whitesides, 2018). Strategically positioned inflatable components could support the complex movement trajectories of an origami surface. Unlike mechanical linear actuators, a single soft robotic actuator can deliver intricate movements. However, the design of these systems is complicated due to their nonlinear behaviour.

The project described in this paper explores the integration of soft pneumatic actuators into an origami-based surface. The first part of the project explores the geometric rules of the folding mechanism. The Grasshopper visual scripting environment was used to generate an origami-based folded plate, while Kangaroo (a physics engine) was used to simulate and parametrically explore the folded triangular tessellation pattern. The second part of the project focuses on

developing a pneumatic soft robotic actuator capable of multi-directional movement. Last, a final design prototype was fabricated and tested to evaluate the actuator's efficacy in animating the tessellated origami surface.

1.0 BACKGROUND

1.1. Tessellation Structures

In this project, we used one of the triangular tessellations from Ronald Resch's series (Resch and Christiansen, 1970). He defined tessellated structures as systems with two essential characteristics. First, they were a whole structure that could be broken down into modular units, and second, they offered infinite variable dispositions simply by changing the angles between the faces. Modularity provides a significant advantage in the fabrication and constructability of the surface since it decreases the complexity and the cost of manufacturing (Mathieu Huard et al., 2015). Also, folded tessellations are structurally stable due to the rigidity and inertia when erected. This means they can create large structures that maintain flexibility and movability (Lee, 2013; Baerlecken et al., 2014). Furthermore, due to their structure, folding tessellations can bend and twist in different directions simultaneously, enabling them to form a saddle or spherical-shape Gaussian curvature (Schenk and Guest, 2011).

The foldability of the paper origami relies on the comparatively small thickness of the paper. The best strategy for translating origami into larger-scale performative structures is to integrate the rigid and thick panels as a continuous surface with a 3D profile. To achieve the foldability of thick panels, two approaches can be considered: shifting the rotational axis to the edges, as in Figure 1 (a), and trimming the solid of each facet by bisector planes of dihedral angles between adjacent parts, as in Figure 1 (b) Tachi (2011).

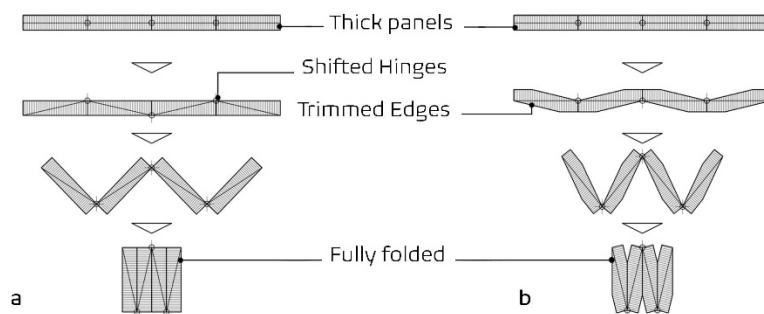

Figure 18. Optimizing foldability of thick panels in origami structures (Tachi, 2011).

Thün et al. (2012) translated the kinetic properties of Resch's triangular tessellation origami into a functional prototype of a folding structure for a responsive acoustic envelope system. The "Resonant Chamber" is a dynamic acoustic environment. Like Tachi (2011), they developed a joint detail between rigid panels and used a laminated membrane for the hinges. Thün et al. (2012) employed mechanical linear actuators to motorize the folding of the panels, which allowed them to generate pre-programmed spatial configurations based on acoustic analysis of the sound performance in the space.

In another study, Mazzucchi (2018) presented a digitally derived approach to investigate the kinematics of a single unit module of the triangular tessellation pattern through a customized computational simulation. He proposed two types of hinges to facilitate the foldability of the rigid panels in each unit cell. In the first method, similar to Tachi (2011) and Thün et al. (2012), he developed a system with hinges at the outer edges of the tapered panels. The hinge in this method operated with the same mechanism found in projection hinges. In the second method, he offered a hinge based on a pin-joint mechanism that did not support the concept of continuous surface origami.

1.2. Soft Robotics and Pneumatic Systems

The early air structures in architecture are the large air-supported shell structures developed in the 1950s and invented by Walter Bird and Victor Lundy. These included pneumatic "bubble" enclosures for tennis courts and swimming pools (McLean and Silver, 2015). Exploration of the air-filled structures at a smaller scale (as in soft robotics) showed that air-filled components could create movement in addition to supporting inflatable structures, thus replacing mechanical actuators with soft air muscles.

It could be said that pneumatic muscles are biologically inspired by inflatable elements. They have been used primarily in soft robotics to create pliable robots and soft actuators; their flexibility, inflatability, high elasticity, and tensile strength have added new performance capabilities to complex 3D movements. In addition, they can be more fluidly integrated with other moving components and accomplish intricate movements with a single action. By doing this, they can outperform multiple electromechanical actuators for a similar task. In contrast to mechanical actuators, the multi-directional movement of soft actuators simplifies the actuation mechanism, requires fewer mechanical parts, and reduces the manufacturing cost, assembly time and operation energy consumption (Whitesides, 2018). These characteristics make them a promising candidate for application in kinetic architecture.

Recently, significant developments have been achieved in soft pneumatic actuators that improve their functional behaviour. For example, the composition of elastomer materials can produce elastomers with different mechanical

properties (Ilievski et al., 2011); embedding of flexible sheet materials into the actuators, such as paper, textiles, mesh, and glass fibres (Galloway et al., 2013) can change their behaviour; and modifications to the actuators' network of internal air chambers (Mosadegh et al., 2014) can change the directionality of its movement. These soft pneumatic actuators can be used in two different ways: as embedded actuators to trigger the movable parts (Ahluquist et al., 2017; Körner et al., 2017) or as functional kinetic bodies that create interactive architectural systems (Park and Bechthold, 2013; Rossi et al., 2014; Fougere et al., 2015). Besides offering new functionalities, soft robotics contributes to the fluidity and safety of human and machine interaction due to their life-like behaviour (Whitesides, 2018).

2.0 METHODS

2.1. Folding Kinematics Simulation

In this project, origami tessellation is based on an array of unit modules (Figure 2-a). The geometry of the unit module, along with its folding kinematics, determines the range of deformations of the folded origami tessellation. In order to achieve stiffness and structural stability, the facets of the unit module are made of thick rigid panels connected along their edges by hinges. The movement of one unit module can be digitally modelled to represent its kinematics; accordingly, a digital model of the entire surface pattern can be simulated. In the first phase of this project, the folding mechanism of a single unit module of Resch's triangular tessellation was simulated by converting it into a network of spring elements using the Kangaroo plugin – the physics engine that runs within the Grasshopper environment in Rhino. Kangaroo allows the application of virtual forces, such as gravity (weight of the system), translational, and rotational limitations to the spring model, that help control the folded pattern's global deformation.

A digital workflow was developed to parametrically generate the folding pattern of the tessellation and apply bending forces on the origami surface. This process generated a simulation of a 3D folded surface. This virtual simulation led to a better understanding of the behaviour of global surface geometry under various inflation-pattern scenarios. The folding angles of the unit module, triggered by various inflation rates, led to different deformations of the origami surface. In the project's second phase, a physical prototype of this origami structure was fabricated, as an aggregation of the designed unit modules, to verify the functionality of the folding system.

2.2. Folding Mechanism

The folding and unfolding of a tessellated structure require force. Through primary analysis of the kinetic mechanism of the unit module, two main folding directions were recognized. For the origami structure to move between flat and folded states, angles α and β (Figure 2-b) must be increased or decreased. To move or stabilize the folding panels, up to nine mechanical linear actuators must connect the panels on both sides of each hinge of the unit module (Figure 2-c).

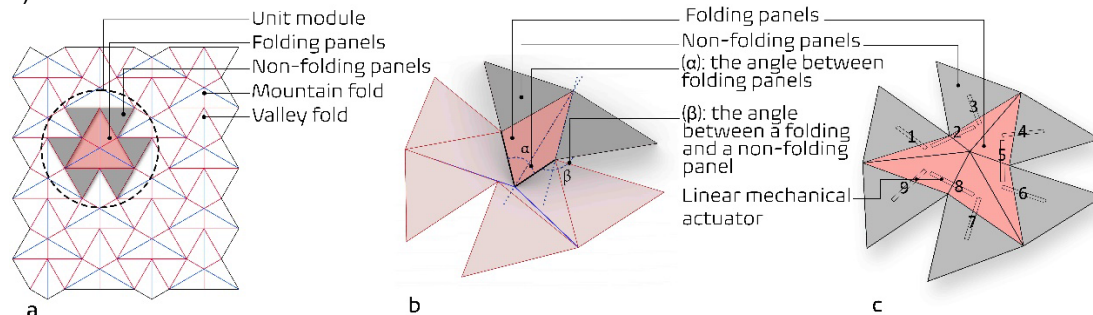

Figure 19. (a): The Resch's triangular tessellation with an isolated unit module. (b): diagram of unit module folding mechanism. (c): possible locations of linear actuators necessary for the module movement (Youness Yousefi, 2023).

The main objective of this project was to eliminate the linear actuators and, in turn, explore the folding/unfolding of all unit module panels by a single soft robotic system. Therefore, a soft silicone actuator was integrated into the single origami module to actuate its complex shape. The actuator was designed to avoid interfering with the origami pattern and folding mechanism by considering the position of mountain and valley folds and the geometry of the unit module when folded. Two silicone actuators were developed based on two functions: (A) pushing and (B) pulling. Type A actuator is placed inside the folding panels. When actuated, it pushes folding panels to unfold. Type B actuator is attached to the back of the folding panels and pulls them to unfold.

2.3. Materials and Fabrication

The triangular panels of the tessellated origami were laser-cut from a 3 mm-thick plywood sheet. Wood panels were then laminated to a thick two-way stretch fabric matrix following the Resch's origami pattern. In this composite system, the fabric is a matrix that facilitates hinging and continuity of the surface. Soft actuators were designed utilizing the same tessellated pattern of a module and cast from the designed mould using "Dragon SkinTM 10 Slow" silicone. Actuators were integrated into a wooden tessellation surface using the fabric matrix to create strong bonds between the surface and the silicone actuators.

2.3.1. Silicon Actuators

Actuator A was designed to fit into the folding tessellation pattern. It consisted of three fins corresponding in size and shape to the unit module geometry. The fins contained three interconnected air chambers to provide airflow. A three-piece plastic mould was 3D-printed and used to cast the silicone actuator (Figure 3-A). The casting procedure included two parts: the main silicone body and the cap. Once the main body was cured, it was removed from the mould and placed inversely in the 3 mm-deep liquid silicone to close the air chambers. To fit the three-fin silicone actuator to the folding pattern of the unit module, a 10 mm-wide gap was created between folding panels. Using silicone as an adhesive, each fin of the soft actuator was attached to the fabric at the bottom of each crease, between every two folding facets. A polyurethane tube connected to the actuator from the back of the unit module delivered air for inflation. Actuator B was designed to fit on the backside of the surface unit module. Similar to actuator A, its shape and size were related to the triangular origami pattern. However, unlike type A, each fin was divided into two sub-fins, with separate air chambers attaching to both sides of the folding panels from the outside. This structure provided larger areas for stronger bonding to the panels. Although it had two chambers in each fin, modifying the shape of the unit module was unnecessary. The unit module and the silicone actuator were fabricated in one step using a five-piece 3D-printed mould (Figure 3-B).

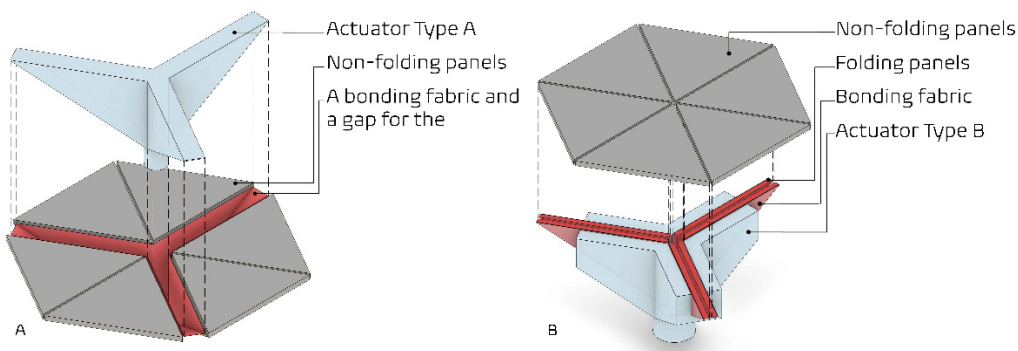

Figure 20. A and B actuators and their placement in a unit module of Resch's origami (Youness Yousefi, 2023).

In order to control the inflation and achieve desired 3D movement of the six chambers, a restricting layer of fabric was attached over the pneumatic actuator. This directed the movement towards the module's centre, concentrated the force needed to unfold the panels, and resulted in significantly lower air pressure requirements (Figure 4).

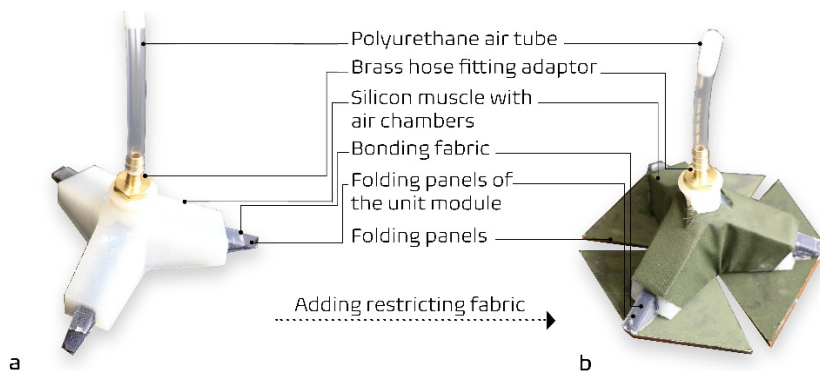

Figure 21. A restricting layer of fabric was attached over the pneumatic actuator (Youness Yousefi, 2023).

2.4. Prototyping and Control System

The size of triangular plywood elements and the hinge system were determined by the plywood thickness (Tachi, 2011; Thün et al., 2012). A prototype of 32 fully folded unit modules was fabricated in a 4 × 8 grid (Figure 5-a). Twelve units were manufactured with embedded type B actuators (Figure 5-b) and distributed in an origami pattern. This configuration was used to explore the relationship between the folding mechanism and the local and global deformation of the origami surface. The non-actuated unit modules were kept in a folded position by embedded silicone clamps (Figure 5-b). The entire tessellated structure was mounted on a 90 cm x 30 cm wood chassis, with two 30 cm and 60 cm-high walls on its two adjacent sides.

The actuators were divided into six sets, each connected separately to an air supply tube using pneumatic solenoid valves, connected to an air compressor with a built-in air pressure sensor. They were controlled by an Arduino

microcontroller with a MOSFET driver module shield (metal-oxide-semiconductor field-effect transistor) (Figure 5-c). We programmed solenoid valves with a pulse-width modulation technique to run six inflation patterns in a loop.

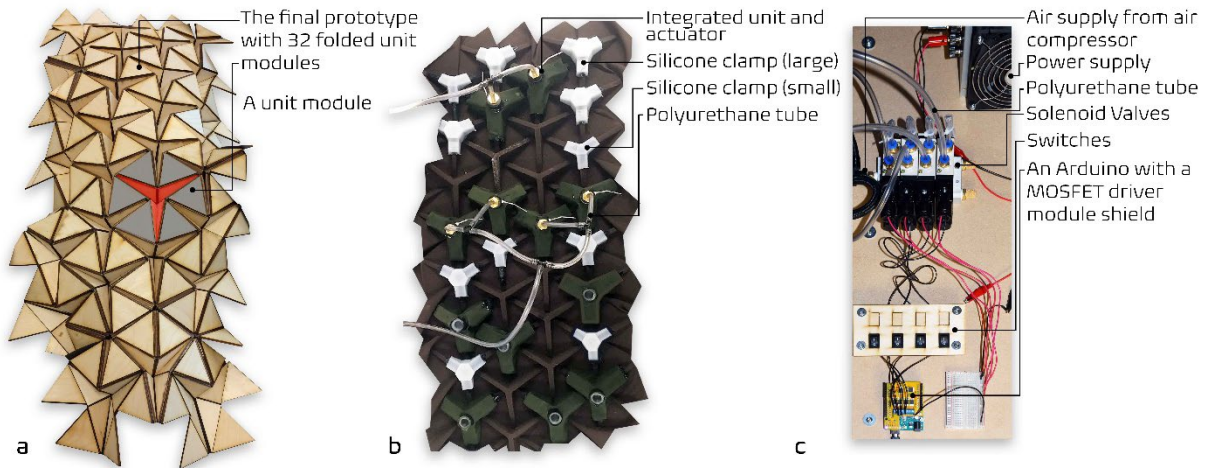

Figure 22. (a): the upper face of the final prototype of the Resch's origami surface. (b): the backside of the final prototype shows the actuators' positions and clamps. (c): the control board with Arduino and solenoid valves managing the air supply to the actuators (Youness Yousefi, 2023).

3.0 RESULTS AND DISCUSSION

3.1. Simulation

The folding mechanism of the origami tessellation was simulated with the Kangaroo plugin in vertical and horizontal positions, Figure 6. The simulation allowed for an easy change of the unit size within the surface. Scaling down the unit module increased the number of unit modules and, thus, the number of folds and actuators on the surface. More folds led to more varied deformation with more dramatic folding patterns on the origami surface that could be more easily calibrated. However, the increased number of unit modules compromised the structural stability of the surface. On the other hand, a reduced number of unit modules in a surface decreased the number of folds and actuators. This resulted in less varied deformation of the surface but more structural stability.

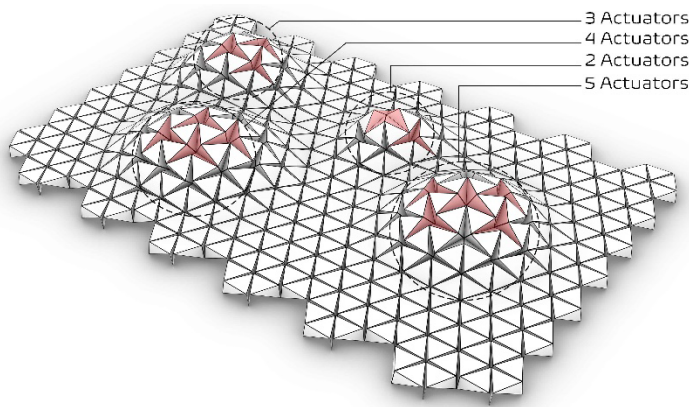

Figure 23. Simulation of specific inflation patterns of actuators showing the behaviour of the surface in a horizontal position (Youness Yousefi, 2023).

3.2. Prototyping

During the actuator inflation, several things were noted. Actuator A failed to fully open the unit module, as its inflation force was not fully utilized. Increasing the air pressure inflated the actuator in the opposite direction instead of increasing the pushing force. Because of its placement on the upper surface of the origami structure, this actuator would be exposed to possible damage (Figure 7-A). These observations obtained during the fabrication phase led to the design of the type B actuator.

Unlike actuator A, actuator B was fabricated as an integral part of the unit module's folding panels and placed under the surface. During the initial inflation test, the unit opened only partially, indicating that the actuator force must be more

precisely directed. Applying a non-flexible fabric on the actuator enabled full inflation force towards the centre of the folding panels; thus, the amplified and directed force of the air unfolded the module (Figure 7-B).

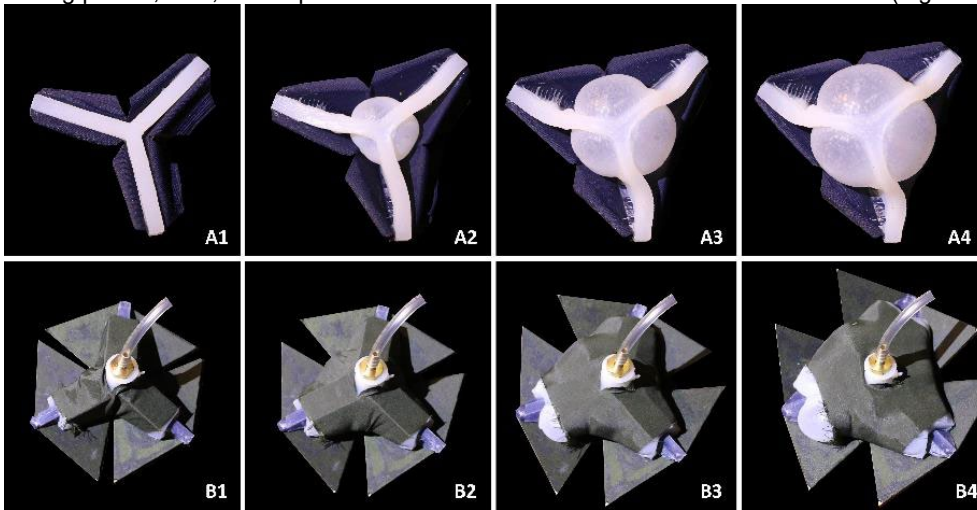

Figure 24. (A): Type A actuator opening sequence. (B): type B actuator opening sequence (Youness Yousefi, 2023).

The final origami prototype consisted of 12 integrated actuators, while the rest of the unit modules remained closed with silicone clamps to provide the structural stability of the origami surface. Two sizes of silicone clamps were used on 11 non-actuated modules to help stabilize the origami surface in the folded state. The clamps allowed a minor folding/unfolding of each non-actuated module to enable a smooth global deformation of the entire origami surface. The size of the silicone clamps and their gripping force was critical in calibrating the surface deformation. If too large, clamps reduced the actuation force and caused a slight deformation, while small clamps resulted in structurally compromised and non-stable deformation.

The inflation tests were carried out by orienting the prototype horizontally and vertically. Various inflation patterns created different geometrical configurations, which helped examine the functionality of the actuators under the force of gravity. Although the actuators performed better in the vertical position, the folded units at the upper rows of the origami (where it was attached to the wood chassis) tended to unfold due to the structure's weight. In contrast, the origami structure tended to remain in its folded state in a horizontal position. As depicted in Figure 8, the angle (α) between folding panels in each unit was smaller towards the lower edges of the deformation arch during the horizontal test, indicating a more compressive load at lower units under their own weight.

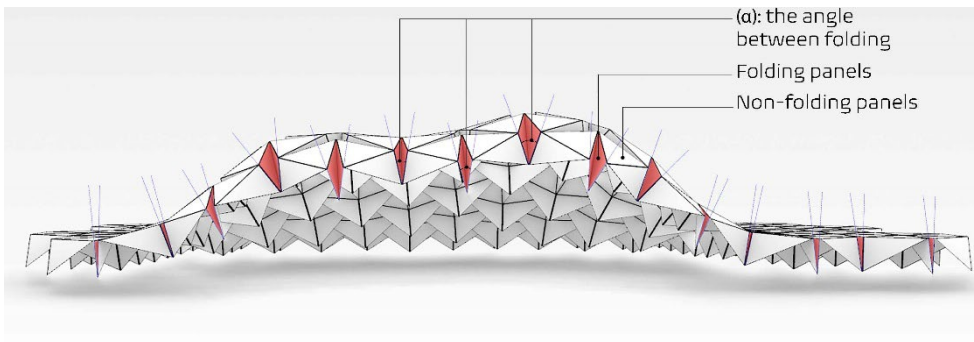

Figure 25. The angle (α) between folding panels was smaller towards the edges of the arch in each deformation (Youness Yousefi, 2023).

Consequently, inflating the actuators and unfolding the units -when the surface was horizontal- required higher air pressure. By analyzing the origami deformations in both positions, it was determined that a smoother deformation would require more actuators. Eventually, the prototype was evaluated while attached to a chassis and positioned vertically and horizontally (Figures 9 and 10).

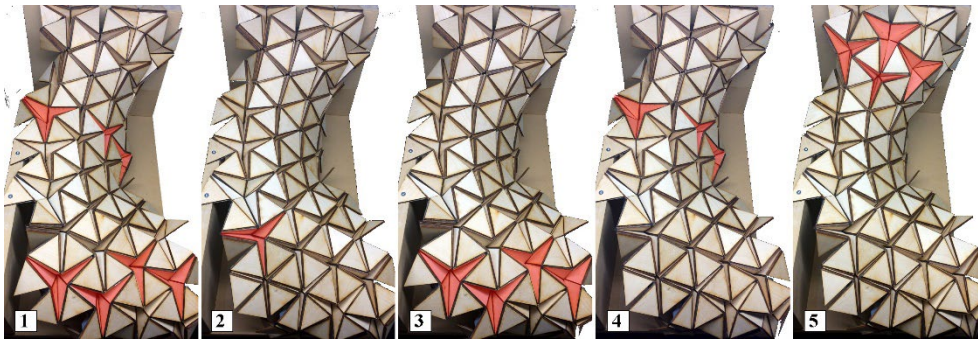

Figure 26. Prototype in a vertical position showing various inflation patterns (Youness Yousefi, 2023).

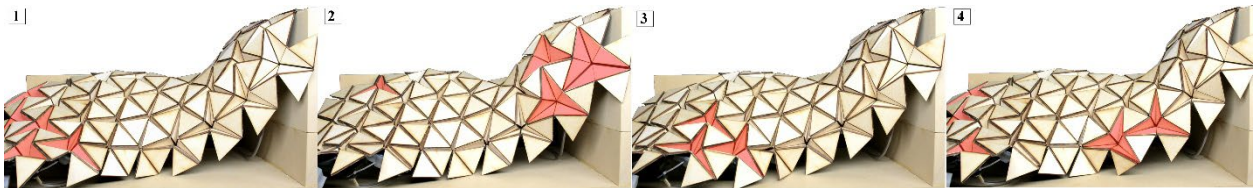

Figure 27. Prototype in horizontal position showing various inflation patterns (Youness Yousefi, 2023).

CONCLUSION

This prototype-based research study is focused on integrating soft robotics with Resch's triangular tessellation to engage the kinetic property of origami structures. Compared to the linear actuation of the origami surface presented in the Resonant Chamber project (Thün et al., 2012), it was concluded that a single silicone actuator could replace up to six linear electromechanical actuators. Considering its folding kinematics, each unit module was divided into two parts: folding panels and non-folding panels. The final design embedded the folding panels in a soft actuator, enabling a one-step fabrication of the new module and actuator. Performing the inflation tests on the final prototype, equipped with 12 embedded actuators, highlighted the significant influence of gravity on the surface deformation, its structural stability, and the unfolding function of the actuators. Designing an origami surface must account for its two intrinsic characteristics: flexibility and structural stability. The project strives to maintain both by integrating a soft actuator within a unit module of the origami pattern.

The outcome of this research highlights the possibility of making a tessellated origami structure kinetic by embedding soft robotics systems. Structures like these that include moving elements can be used in diverse architectural applications, such as adaptive facades or deployable shelters. For example, as a prefabricated deployable module, this design can aid in creating shelters for the survivors of natural disasters. The advantage of this folding system is that its prefabricated modules can be shipped to remote sites and assembled without any skilled labour. Once activated by specific air pressure, they will rapidly form a structurally stable shell.

ACKNOWLEDGEMENTS

The second phase of this project was a collaborative group effort for a course on responsive architecture offered at the School of Architecture, Planning, and Landscape at the University of Calgary. The authors would like to thank Joseph Kaplan, Faraz Aghajafari, and Yanjinkham Tumurbaatar for contributing to the fabrication of an early prototype.

REFERENCES

- Ahlquist, S., McGee, W. and Sharmin, S., 2017. *PneumaKnit: Actuated Architectures Through Wale- and Course-Wise Tubular Knit-Constrained Pneumatic Systems*. ACADIA 2017: DISCIPLINES & DISRUPTION, Proceedings of the 37th Annual Conference of the Association for Computer Aided Design in Architecture, Cambridge, MA, ACADIA.
- Baerlecken, D., Gentry, R., Swarts, M. and Wonoto, N., 2014. *Structural, Deployable Folds — Design and Simulation of Biological Inspired Folded Structures*. International Journal of Architectural Computing 12(3): 243-262.
- Comstock, G. L., 1963. *Moisture diffusion coefficients in wood as calculated from adsorption, desorption and steady state data*. Forest Products Journal 13(3): 97-103.
- Fougere, D., Goold, R. and Velikov, K., 2015. *Pneuma-Technics: Methods for Soft Adaptive Environments*. ACADIA 2105: Computational Ecologies: Design in the Anthropocene, Proceedings of the 35th Annual Conference of the Association for Computer Aided Design in Architecture, Cincinnati, Ohio, US, ACADIA.
- Fox, M. and Kemp, M., 2009. *Interactive architecture*, New York, Princeton Architectural Press.
- Galloway, K. C., Polygerinos, P., Walsh, C. J. and Wood, R. J., 2013. *Mechanically programmable bend radius for fiber-reinforced soft actuators*. Advanced Robotics (ICAR), 2013 16th International Conference on, IEEE.

- Ilievski, F., Mazzeo, A. D., Shepherd, R. F., Chen, X. and Whitesides, G. M., 2011. *Soft robotics for chemists*. *Angewandte Chemie (International ed. in English)* 50(8): 1890-1895.
- Kolarevic, B., 2015. *Towards Architecture of Change*. B. Kolarevic and V. Parlac.(Eds), *Building dynamics: exploring architecture of change*. London & New York. Taylor and Francis.
- Kolarevic, B. and Parlac, V., 2015. *Adaptive, Responsive Building Skins*. B. Kolarevic and V. Parlac.(Eds), *Building dynamics: exploring architecture of change*. London;New York;. Routledge. 69-89.
- Körner, A., Born, L., Mader, A., Sachse, R., Saffarian, S., Westermeier, A., Poppinga, S., Bischoff, M., Gresser, G. and Milwich, M., 2017. *Flectofold—a biomimetic compliant shading device for complex free form facades*. *Smart Materials and Structures* 27(1): 017001.
- Lee, D., 2013. *Self-Organizing Origami Structures (Research Poster)*. ACADIA 13: Adaptive Architecture [Proceedings of the 33rd Annual Conference of the Association for Computer Aided Design in Architecture (ACADIA) ISBN 978-1-926724-22-5] Cambridge 24-26 October, 2013), pp. 421-422.
- Mathieu Huard, Michael Eigensatz and Bompas, P., 2015. *Planar Panelization with Extreme Repetition*. P. Block, J. Knippers, N. J. Mitra, L. e. M. Springer and Statistics.(Eds), *In Book: Advances in Architectural Geometry 2014*. Cham. Springer International Publishing. 233-241.
- Mazzucchi, A., 2018. *A Kinetic Module for Modular Structures Based on Rigid Origami*. *Nexus Network Journal* 20(1): 41-57.
- McLean, W. and Silver, P., 2015. *Air structures*, London, Laurence King Publishing.
- Mosadegh, B., Polygerinos, P., Keplinger, C., Wennstedt, S., Shepherd, R. F., Gupta, U., Shim, J., Bertoldi, K., Walsh, C. J. and Whitesides, G. M., 2014. *Pneumatic Networks for Soft Robotics that Actuate Rapidly*. *Advanced Functional Materials* 24(15): 2163-2170.
- Park, D. and Bechthold, M., 2013. *Designing Biologically-Inspired Smart Building Systems: Processes and Guidelines*. *International Journal of Architectural Computing* 11(4): 437-463.
- Resch, R. and Christiansen, H. N., 1970. *The design and analysis of kinematic folded plate systems*. Proceedings of IASS Symposium on Folded Plates and Prismatic Structures, 1970.
- Rossi, D., Nagy, Z. and Schlueter, A., 2014. *Soft Robotics for Architects: Integrating Soft Robotics Education in an Architectural Context*. *Soft Robotics* 1(2): 147-153.
- Schenk, M. and Guest, S. D., 2011. *Origami folding: A structural engineering approach*. Origami 5: Fifth International Meeting of Origami Science, Mathematics, and Education, CRC Press, Boca Raton, FL.
- Tachi, T., 2011. *Rigid-Foldable Thick Origami*. Origami 5: Fifth International Meeting of Origami Science, Mathematics, and Education, CRC Press.
- Thün, G., Velikov, K., Ripley, C., Sauv e, L. and McGee, W., 2012. *Soundspheres: Resonant Chamber*. Leonardo, MIT Press.
- Whitesides, G. M., 2018. *Soft Robotics*. *Angewandte Chemie International Edition* 57(16): 4258-4273.

The Impact of Ceiling and Door Design on Building Fire Safety

Chengde Wu¹

¹Iowa State University, Ames, Iowa

ABSTRACT: This research investigates how various parameters of ceiling and door design affect building fire safety. The main hypothesis of this research is that opening up ceilings can delay smoke propagation by utilizing plenum space to hold more smoke during a building fire, and thus provides more time for occupants to evacuate the fire scene safely. To investigate this hypothesis, a digital model with four connected rooms was modeled in Fire Dynamic Simulator (FDS), an open-source fire/smoke simulation tool developed by the National Institute of Standards and Technology based on a computational fluid dynamics model of fire-driven fluid flow. Nine smoke sensors were placed in each room to measure smoke height, toxicant concentration, oxygen concentration, and temperature. The design variables include ceiling opening ratio, opening size, opening distribution, plenum height, and door height. The simulation results showed that 1) opening 16-50% of the ceiling has the maximum smoke-delaying effect which can delay smoke propagation time by up to 60%; 2) The size of the openings has little influence on smoke propagation when the openings are evenly distributed and the total area remains constant; 3) Different opening distributions showed different smoke propagation time. 4) The higher the plenum space, the longer the smoke propagation time. The relation between plenum height and smoke propagation time is approximately linear; 5) The taller the doors, the shorter the smoke propagation time. The relation between door height and smoke propagation time is approximately linear. These findings are expected to provide guidance for designers to understand the implications of ceiling and door design regarding building fire safety.

KEYWORDS: Building fire safety, Smoke Propagation Simulation, Fire Dynamic Simulator (FDS)

INTRODUCTION

Building fires cause many fatalities worldwide each year, more than the deaths caused by all natural disasters combined. From 2007 to 2009, there were more than 10,000 building fire deaths each year in 27 industrialized countries, an average of 8.3 deaths per million population (Figure 1, WFSC 2012). In addition, expanding populations are increasingly moving to cities and living in high-density development areas where fire risks are greater. Many studies have been done to understand the direct causes of building fire deaths. Berky et al. (1979) conducted autopsies of 398 fire fatalities and concluded that the primary causes of deaths in building fires are the toxicants in smoke (80%) and severe burn (11%). Among various toxicants, carbon monoxide is the only one that is proven to directly cause deaths, while others may contribute to early decapitation. Given that smoke accounts for the vast majority of fire deaths, delaying smoke propagation in a building can improve building fire safety by providing occupants more time to evacuate in case of a building fire.

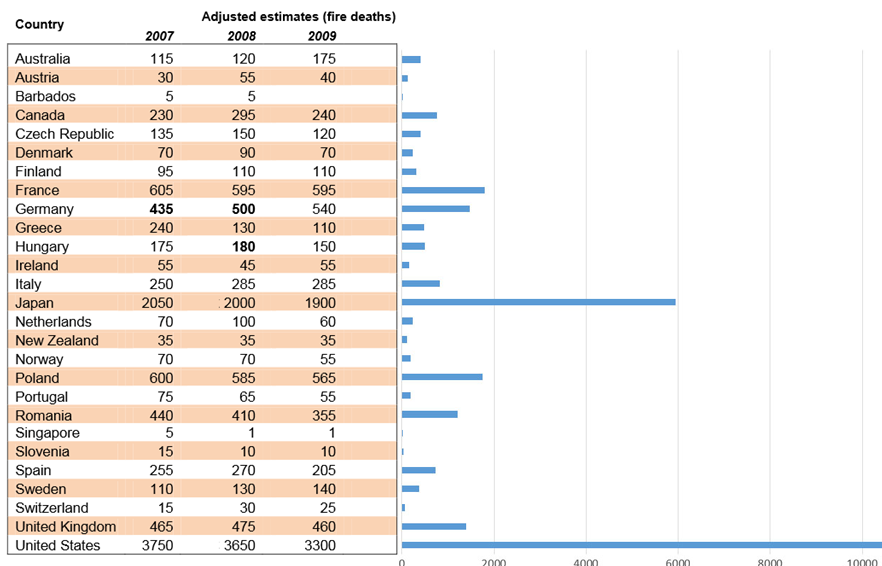

Figure 1: The number of fire deaths in 27 industrialized countries from 2007 to 2009 (WFSC 2012). Source: Author

When a building fire starts in a space, a hot plume of smoke rises to the ceiling and fills up the upper part of the space. As fire further develops, more smoke accumulates in the upper space and pushes the smoke line, the interface between the hot smoke at the top and cool fresh air at the bottom, lower and lower. When the smoke line reaches the top of an opening, such as a door, smoke propagates to the next room, fills up its ceiling space, and repeats the propagation process. This leads to an observation that if certain building design elements alter the volume at the upper portion of each space, it can either delay or accelerate smoke propagation. This study explores the building components that can affect smoke propagation. Oftentimes, ceilings are installed in many buildings to hide HVAC ducts and provide an acoustic dampening function. One hypothesis is that if the plenum space is opened to the room space through ceiling grills, the plenum space can be used for holding smoke and delaying smoke propagation. A plenum space is a space between the ceiling and the floor slab above it as shown in Figure 2. Another observation is that door design can also affect smoke propagation. Distance d shown in Figure 2 affects the valid volume that can hold smoke before it propagates to the next room. Changing the height of the door effectively changes the volume that can hold smoke before it propagate to the next room. Thus, this study aims to investigate how ceiling and door designs affect smoke propagation time.

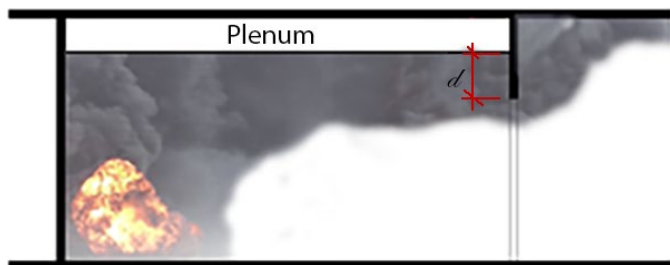

Figure 2: Location of plenum and the valid volume for delaying smoke propagation to the next room. Source: Author

1.0 LITERATURE ON BUILDING FIRE SIMULATION

Building fire simulation has been studied since the 1970s. Numerous experiments have been done to understand the physical characteristics of fire and smoke in buildings, including the ignition behavior of various flammable materials such as cardboard, newspaper, canvas, cotton cloth, rubber strip, polyurethane foam (Smith 1970, Ohlemiller1971), different types of polymeric materials (Kishore1980), different types of wood (Moghtaderi1997), and so on. While conducting these experiments, many parameters were monitored, including ignition temperature, time to ignite, Heat Release Rate (HRR), yields of combustion, toxicity of each type of gas, oxygen depletion. As these physical characteristics of fire have been revealed with countless experiments, researchers strived to model building fires using mathematical equations and computer simulations to simulate fire and smoke propagation. Smoke propagation models can be classified into either a zone model or a field model, also known as CFD (Computer Fluid Dynamic) model (Wu 2015). A CFD model discretizes a continuous space into a myriad of small cuboids, and the concentration of the gases and the temperature of each cuboid are simulated by solving the Navier-Stokes equations. Compared to zone models, CFD models generate more accurate results, but the downside is that CFD models require much longer simulation run time.

Fire Dynamics Simulator (FDS), a CFD-based fire simulation model developed by the National Institute of Standards and Technology, contains a pyrolysis model, a combustion model, a hydrodynamic model, and a radiation transport model. The pyrolysis model in FDS simulates the decomposition of solid fuels such as building materials and furniture. The FDS combustion model simulates the chemical reaction of decomposed fuel and the oxygen in the air. The FDS hydrodynamic model simulates low-speed, thermally driven air flow emphasizing the smoke and heat transport from a fire. The term low-speed is used to exclude situations similar to explosions. The FDS radiation transport model simulates the heat transfer by radiation through the gas-soot mixture using approximately 100 discrete angles. The result of combining these models is that FDS can simulate the fine distribution of gas concentration and the temperatures in a space. In addition, FDS also calculates soot density and visibility. The FDS model has been extensively studied and validated by many independent researchers through comparing physical experiments results with simulation FDS simulation results (NIST 2022).

2.0 RESEARCH FRAMEWORK

2.1 Research questions

The primary research questions of this study are:

- Is plenum spaces useful for delaying smoke propagation when opening up ceilings?
- If so, what are the parameters that impact the effectiveness of delaying smoke propagation?
- Do taller doors accelerate smoke propagation?

2.2. Research hypotheses

This study investigates the two hypotheses stated below:

- Opening up ceilings allows plenum spaces to hold more smoke before propagating to the next room and thus delays smoke propagation.
- Taller doors reduce the effective volume that can hold smoke before propagating to the next room, and thus shorten the smoke propagation time.

2.3. Research methodology

To answer the research questions and investigate the hypotheses, a series of fire simulations were conducted using FDS. Firstly, a building model with four of 6m x 6m rooms is modeled (Figure 3). Rooms A, B, C, and D represent four different room conditions by the relative location to the fire source: room A contains the fire source (denoted as a hatched red square in Figure 3); room B represents the rooms that smoke passes by; room C represents the rooms that only have incoming smoke flow but no outgoing smoke flow; room D represents the rooms that are directly connected to the exterior. Grills are modeled on the ceiling with various parameters to allow plenum space to hold smoke during simulation. The simulation results are then compared with the baseline of the closed ceiling model. To evaluate how fast smoke propagates, the average time for the smoke line to reach 1.5 - 2m above the floor is used as the metric. Stratification occurs during a building fire, and it separates the hot smoke in the upper space and the cool fresh air in the lower space. When the smoke line reaches 1.5 - 2m, the occupants are threatened to inhale the toxicants in the smoke during evacuation. Comparing the time for the smoke line to reach 1.5 - 2.0m can reveal whether utilizing plenum space would impact smoke propagation time.

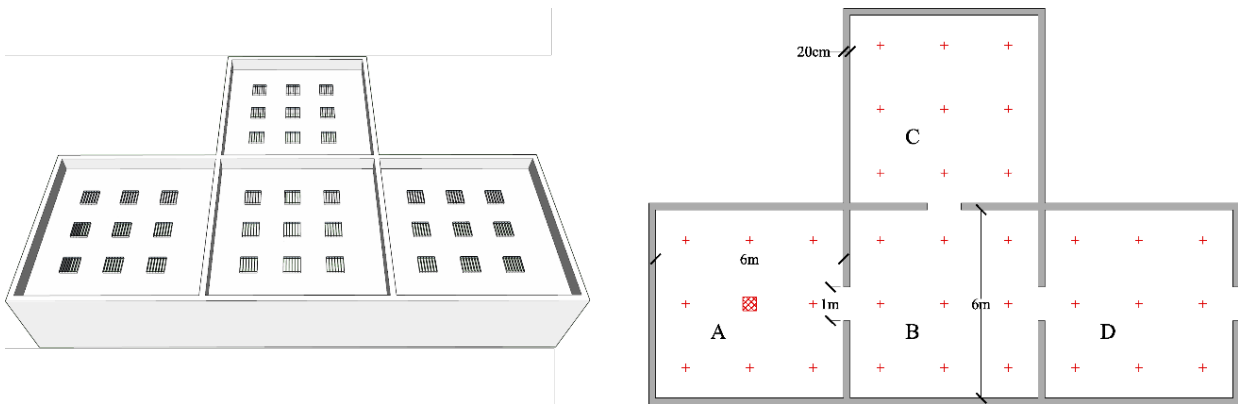

Figure 3: Perspective (left) and the floor plan (right) of the base model for the simulations. Source: Author

3.0 SIMULATIONS

3.1. Simulation settings

Ceiling and door design can affect smoke propagation in many ways. In this study, five parameters were selected to investigate their impact on smoke propagation. To isolate the impact of each parameter, a model was built as the base model, and each time only one of the parameters was changed while the others remained constant. As shown in Figure 3, the base model has four rooms. In the perspective drawing the slabs at the top and the bottom are hidden for presentation purposes. The only way for smoke to propagate from one room to the next is through the doors. Room A contains the fire source at its center, and room D is connected to the exterior. Each room has nine evenly distributed sensors (red cross signs) except for room A which has eight sensors with the fire source located at its center. The size of each room is set to 6m x 6m. The ceiling height of each room for the base model is set to 2.8m, and the floor height is set to 3.6m. The size of each door is set to 1m x 2m (W x H) as shown in Figure 4.

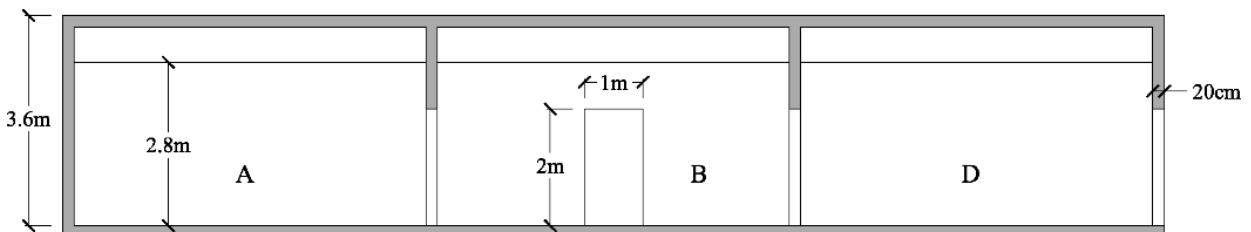

Figure 4: Section of the base model. Source: Author

The resolution of all FDS simulations is set to 10cm and therefore the height of the grilles and the spacing of the grilles are also set to 10cm. Each grille fin is represented using a single surface without thickness. The length and the width of the grilles are set to 60cm (Figure 5, left).

3.2. Opening ratios

Putting openings on the ceiling induces smoke into plenum space and subsequently delays smoke propagation. How effectively openings delay smoke propagation is likely to be affected by the ratio between the total opening area and the ceiling area. To investigate precisely how opening ratios affect smoke propagation, a set of models with different opening ratios were simulated using FDS. Figure 5 (right) shows the ceiling plan of one of the rooms in the model with the grilles. Each ceiling has nine identical square openings with varying sizes L . The sizes of the openings of each model are listed in Table 1.

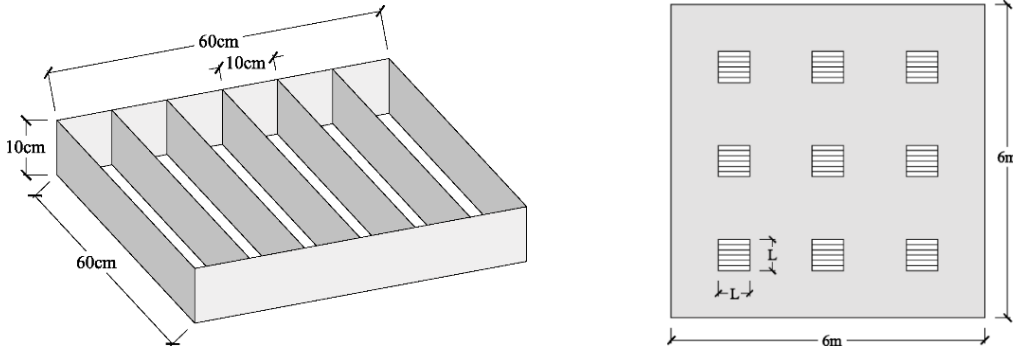

Figure 5: Grille dimensions of the base model (left), and the ceiling plan with the grilles (right). Source: Author

Table 1: List of grille sizes

Grille Size L (m)	Opening Ratio (%)
0.2	1
0.4	4
0.6	9
0.8	16
1.0	25
1.2	36
1.4	49
1.6	64
1.8	81
open	100

The openings of the models are evenly distributed with the center points of the openings of each model unchanged. The model with a 100% opening ratio means that it does not have a ceiling. The average time to reach the 1.5m-2m zone is summarized from the simulation results and shown in Figure 6.

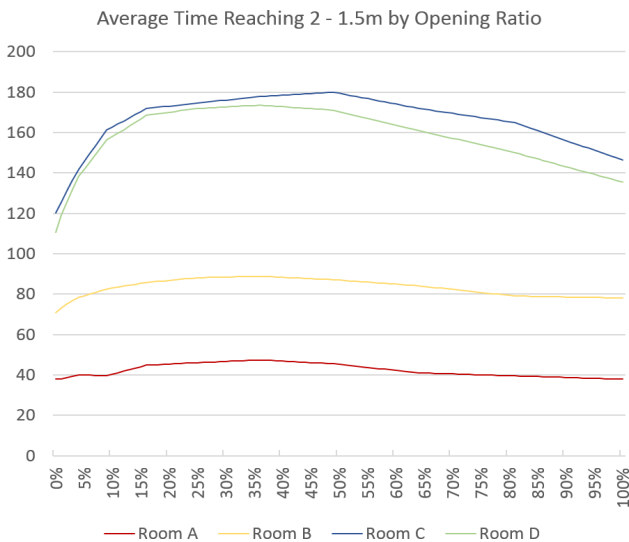

Figure 6: Simulation results by opening ratio. The X axis denotes the opening ratio, and the Y axis denotes the average time (in seconds) for smoke to reach the 1.5m-2m zone. Source: Author

The simulation results are very interesting. When gradually opening up the ceiling from 0% to 16%, the time delay of smoke propagation increases dramatically. The rate of time delay increases at a much shallower slope from the opening ratios of 16% to 49%, and starts to decrease from 49% to 100%. Room A, which contains the fire source, showed up to a 20% increase in time delay while rooms C and D, which are far away from the fire source, showed up to a 60% increase in time delay. The reason why opening up more than 50% of the ceiling diminishes the smoke-delaying effect needs further investigation.

3.3. Opening size

Opening size may also affect smoke propagation. To investigate the influence of various opening sizes on smoke propagation, a set of models with different opening sizes were modeled and simulated using FDS (Figure 7 left). In each model, the openings are evenly distributed and the total area of the openings is constant. The model with an opening size of 40cm used smaller openings for the leftover rows to match the total opening area. The simulation results are shown in Figure 7 (right). The X axis denotes the opening size and the Y axis denotes the average simulation time (in seconds) to reach the 1.5m-2m zone. The results show that the size of the grille has a limited influence on smoke propagation time.

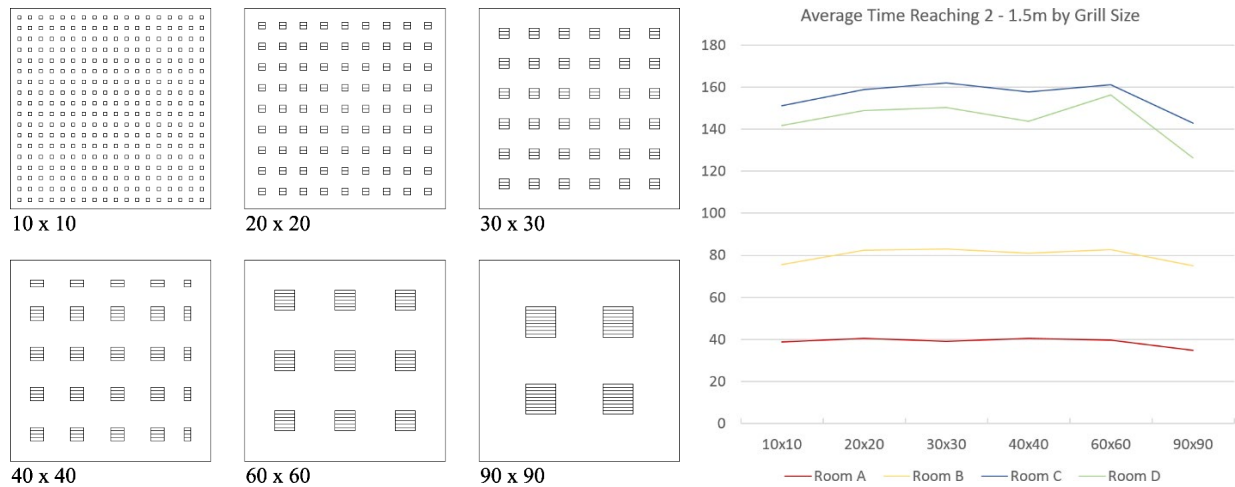

Figure 7: Ceiling plans of the models with different grille sizes (left) and simulation results by grille size (right). Source: Author

3.4. Opening Distribution

The distribution of openings may also affect smoke propagation. To investigate how opening distribution influences smoke propagation, a set of models with different types of distribution were simulated in FDS (Figure 8). The total area of the openings in each model is constant. The simulation results show that A and C types are most effective in delaying smoke propagation, and D, E, and G types are least effective (Figure 9). Combined with the observation of the distribution drawings, it is speculated that evenly distributed openings are more effective in delaying smoke propagation. To validate and generalize this speculation, more extensive simulations are needed.

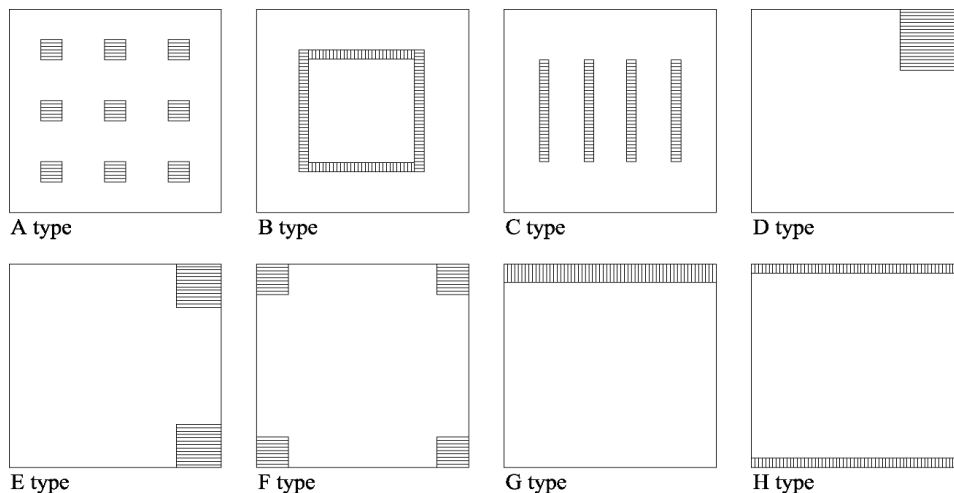

Figure 8: Different types of grille distribution. Source: Author

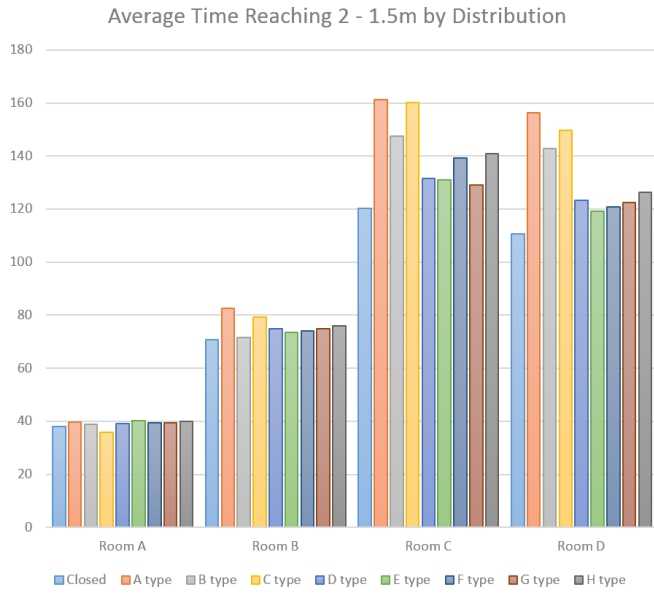

Figure 9: Simulation results by grille distribution type. Source: Author

3.5. Plenum height

To investigate how plenum height affects smoke propagation, a set of models with different plenum height were simulated using FDS. Figure 10 (left) shows the section of the simulated models. The ceiling height was kept at 2.8m while the plenum height H varied in each model. There are a total of nine models with the lowest plenum height at 0.2m, with an increment of 0.1m, and the highest plenum height of 1.0 m. In other words, the floor height of the models changes by 0.1m incrementally in each model. Floor height is usually decided by many other important design factors, such as construction costs, building codes, mechanical systems, the quality of the space, etc. However, these simulations are for pure research purposes of investigating the relation between plenum height and smoke propagation.

Simulation results show that plenum height has little influence on rooms A and B (Figure 10 right). On the other hand, in the rooms that are located further away from the fire source, i.e., rooms C and D, the time for the smoke to reach the 1.5 –2m zone is roughly linearly proportional to the height of the plenum.

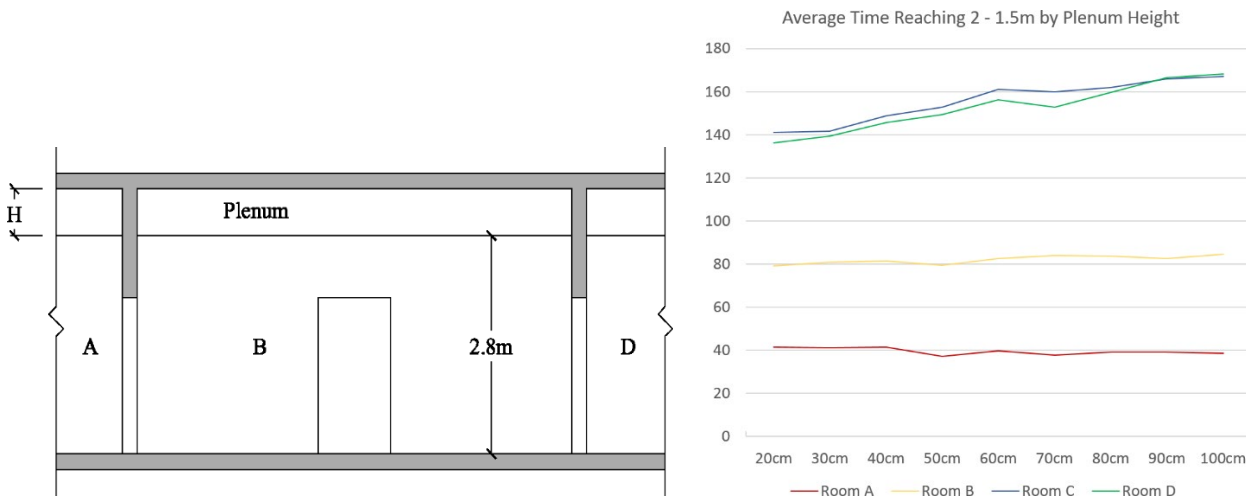

Figure 10: Section of the model showing the plenum height (left), and the simulation results (right). Source: Author

3.6. Door height

It is hypothesized that the taller the doors, the faster smoke propagates to the next room. To validate this hypothesis, a set of models with various door height were simulated using FDS. There are a total of 11 models with the lowest door height at 1.8m, with an increment of 0.1m, and the highest door height at 2.8m. The simulation results show that smoke propagation time is roughly inversely proportional to door height except for the fire of origin (Figure 11).

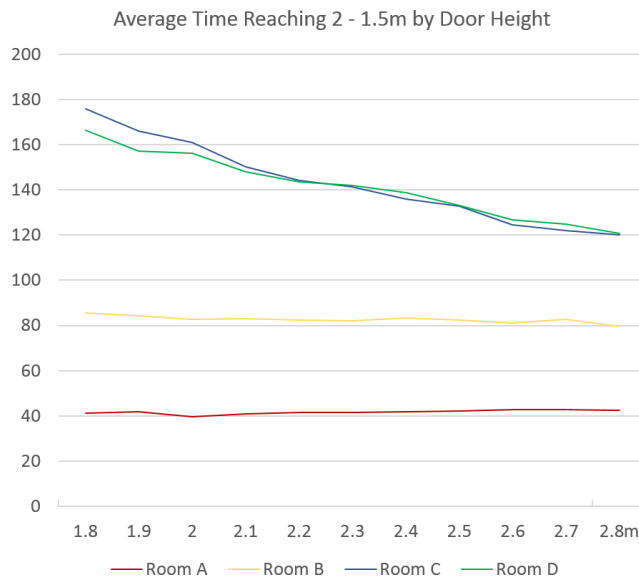

Figure 11: Simulation results by door height. Source: Author

CONCLUSION

This research investigated how ceiling design with grilles and door design affect smoke propagation. The smoke propagation time of a building model was simulated with varying parameters, including ceiling opening ratio, opening size, opening distribution, plenum height, and door height. The simulation results were then compared to a baseline model that has a closed ceiling. The primary findings of this research are:

1. Opening 16-50% of the ceiling has the maximum smoke-delaying effect which can delay smoke propagation time by up to 60%.
2. The size of the ceiling openings has little influence on smoke propagation when the openings are evenly distributed and the total area remains constant.
3. Different opening distributions have different smoke propagation time. Evenly distributed openings are likely to have a better smoke-delaying effect. To confirm and generalize this claim, more extensive simulation data is needed.
4. The higher the plenum space, the longer the smoke propagation time. The relation between plenum height and smoke propagation time is approximately linear.
5. The taller the doors, the shorter the smoke propagation time. The relation between door height and smoke propagation time is approximately linear.

Fire safety is one of the primary responsibilities of architects when designing a building. In the design process, architects primarily rely on building fire codes to evaluate the building fire safety of their design. This research presented findings that can improve building fire safety but are not yet codified. These findings are expected to provide guidance for designers to understand the implications of ceiling and door design regarding building fire safety.

ACKNOWLEDGEMENTS

This research includes the findings from the author's dissertation (Wu 2017).

REFERENCES

- Birky, M. M., Halpin, B. M., Caplan, Y. H., Fisher, R. S., McAllister, J. M., and Dixon, A. M. 1979. *Fire fatality study*. Fire and Materials, 3(4), 211–217. <http://doi.org/10.1002/fam.810030406>
- Kishore, K. and Mohan Das, K. 1980. *Flammability index of polymeric materials*. Colloid & Polymer Science, 258(1), 95–98.
- Ohlemiller, T. J. and Summerfield, M. 1971. *Radiative ignition of polymeric materials in oxygen/nitrogen mixtures*. Symposium (International) on Combustion, 13(1), 1087–1094. [http://doi.org/10.1016/S0082-0784\(71\)80106-6](http://doi.org/10.1016/S0082-0784(71)80106-6)
- Moghtaderi, B., Novozhilov, V., Fletcher, D. F., and Kent, J. H. 1997. *A new correlation for bench-scale piloted ignition data of wood*. Fire Safety Journal, 29(1), 41–59. [http://doi.org/10.1016/S0379-7112\(97\)00004-0](http://doi.org/10.1016/S0379-7112(97)00004-0)
- NIST. 2022. FDS validation test reports. Retrieved from <https://pages.nist.gov/fds-smv/>. Last accessed on Nov. 30, 2022.

- Smith, W. K. and King, J. B. 1970. *Surface temperatures of materials during radiant heating to ignition*. Journal of Fire and Flammability, 1(4), 272–288.
- WFSC. 2012. World Fire Statistics Centre Bulletin vol. 28. Retrieved at <https://www.genevaassociation.org/media/186703/ga2012-fire28.pdf>
- Wu, C., Zarrinmehr, S., Rahmani Asl, M., and Clayton, M. J. 2015. *Facilitating fire and smoke simulation using building information modeling*. In International conference on computer-aided architectural design futures, pp. 366-382. Springer, Berlin, Heidelberg.
- Wu, C. (2017). *A System Architecture for the Integration of Smoke Propagation Simulation, Evacuation Simulation, and Building Information Modeling* (Doctoral dissertation). Texas A&M University

Using Virtual Reality to Visualize Sea Level Rise Impact and Mitigation

Sang Bum Park¹, David Kaul², Ana Orosco¹, Andrew Chin¹

¹Florida A&M University, Tallahassee, Florida

²Albright College, Reading, Pennsylvania

ABSTRACT: The impact of climate change on historic heritage and coastal communities is vast and complex. St. Augustine, Florida is prone to flooding, storm surges, and erosion as a low-lying coastal city. The city's aging infrastructure gets compromised even in light rainstorms, with nuisance flooding regularly closing streets in the historic districts. Communicating the realness and immediacy of the climate threat is a challenge. Climate change also challenges those trying to prepare for its impacts. Raising environmental literacy, awareness, and engagement from coastal community members and stakeholders is essential to start a conversation and help the stakeholders visualize the impacts of climate change on historic sites and the potential solutions. Researchers have investigated a positive correlation between experiencing environmental issues and risk perception, behavior, and attitudes toward them. They have used an immersive experience using virtual reality (VR) technology to promote behavioral or attitudinal change because of its effectiveness in representing the direct experience of an environmental issue. This paper first investigates how the sea-level rise (SLR) caused by climate change has an impact on the St. Augustine historic districts, considering nuisance flooding and storm surges. It creates a VR environment to visualize SLR impacts on three sites in the historic districts and provide visual learning information about potential mitigation plans. It uses 3D laser scanning and photogrammetry to generate 3D textured mesh models of the three structures and the Unity game engine to create a non-immersive and fully immersive VR environment.

KEYWORDS: Virtual Reality, Sea Level Rise, Climate Change, Environmental Literacy, St. Augustine

INTRODUCTION

Virtual reality (VR) technologies have grown and have been constantly evolving over the past few decades. It provided an interesting, attractive, and productive means to educate a wide range of audiences about a variety of topics. Historic preservationists use these technologies to represent, restore, reconstruct and educate cultural heritage (Soto-Martin, Fuentes-Porto, and Martin-Gutierrez 2020; Ibañez-Etxeberria et al. 2020; Abdelhameed 2021; Ehtemami et al. 2021; Lescop et al. 2021). Social scientists use them to conduct research by letting subjects directly experience realistic and multisensory scenarios in a controlled environment to study social interactions and human behavior (Blascovich et al. 2002; Hine et al. 2013; McLean, Taladay, and Dong 2020). Environmental scientists use them to produce highly engaging experiences which can lead to greater focus on the learning topic (Bricken and Byrne 1993; O'Neill and Whitmarsh 2009; Watson et al. 2015). People perceive environmental issues psychologically closer to immersive VR (Schuldt, McComas, and Byrne 2016; Guest, Lotze, and Wallace 2015; Man, Poon, and Lam 2013). When they feel fully immersed in a virtual world, virtual interventions were significantly effective in increasing environmental awareness and enhancing general altruistic behavior (Shriram, Oh, and Bailenson 2017).

VR also became a feasible option for training, clinical research, and neurorehabilitation. It significantly increases cognitive flexibility, shifting skills, and selective attention, leading to better behavioral outcomes in brain-injured patients (De Luca et al. 2019; Georgiev et al. 2021). Improvement in selective memory processes and problem-solving skills facilitates social reintegration and leads to better vocational outcomes (Man, Poon, and Lam 2013; Georgiev et al. 2021).

In this paper, VR was used to increase public interest and awareness about Sea Level Rise (SLR). Although many climate scientists believe that the sea level is rising due to climate change, general public responses are inconsistent (Hine et al. 2013), their engagement with the climate change issue is low, and only few people are adopting mitigating actions (Pidgeon 2012; O'Neill and Whitmarsh 2009). It is mainly because people perceive climate change as psychologically distant: "a set of uncertain events that may or may not occur in the future" (Jones, Hine, and Marks 2017).

The fundamental goal of the present research is to study the effectiveness of a fully immersive virtual reality compared to a webpage-based learning experience and a non-immersive virtual reality experience working with personal computers. The current paper focuses on creating SLR learning content and three VR environments visualizing SLR impact and mitigation.

1.0 SLR LEARNING CONTENT

1.1. St. Augustine in Florida

Florida has low-lying topography and has developed a long coastal line (longer than 1,931 km (1,200 miles)), which results in making the state more vulnerable to the effects of SLR and needed to promote and execute SLR adaptation planning. Approximately 75% of Floridians (19.5 million population) live in coastal counties (Wilson and Fischetti 2010) that generate 79% of the state’s total annual economy (*Climate Change and Sea-Level Rise in Florida* 2010).

According to the National Oceanic and Atmospheric Administration (NOAA), sea level rise began accelerating in Florida 30 years ago. In 2006, the rate significantly increased again as sea levels rose by more than 8.45 mm (1/3 inch) annually along with certain parts of the Floridian coast. Based on a 2010 report by the Florida Oceans and Coastal Council (FOCC), the rapid rate of SLR could lead to 25 times more flooding capable of causing significant risks to life and property. The report also states that virtually none of Florida’s infrastructure was built to accommodate significant sea level rise. Much of the current infrastructure of coastal Florida will need to be replaced or improved as the sea level rises. As a result, Florida’s historic properties face potential degradation or destruction.

The history of St. Augustine, Florida, the oldest, continuously occupied settlement of European origin in the continental United States, began in 1565 when it was founded by the Spanish admiral, Pedro Menéndez de Avilés. St. Augustine is a low-lying city, crisscrossed by waterways. Along with the SLR trend and recent hurricanes that became more frequent and intense, the City of St. Augustine has faced the vulnerability of many historic properties over the past four decades.

1.2. Global and regional sea level trends

Global sea level (July 30, 2022) has risen about 102.8 mm, with an exponential trend of about 3.4 mm per year since 1993, according to NASA’s satellite sea level observations (Figure 1). SLR is estimated to increase an additional 305 mm to 1,220 mm by 2100 (Melillo, Richmond, and Yohe 2014).

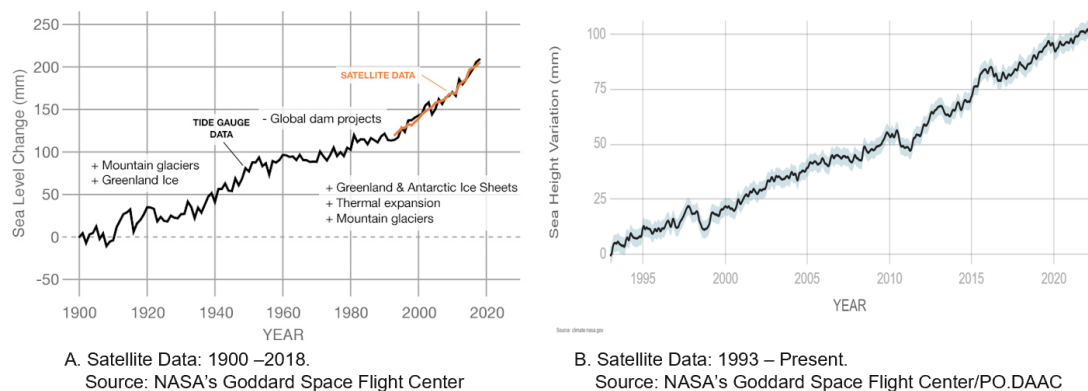

Figure 28: Sea level trends from 1990 to the present. Source (NASA’s Goddard Space Flight Center)

When considering global warming, SLR refers to “Global” SLR, which is a planetary average. In the sense that SLR is not globally uniform across the planet but varies regionally, one needs to take a close look at the SLR specific to the local scale. The differences are related to geographical features, ocean currents, wind patterns, etc. Throughout the current paper, SLR refers to “Local or Relative” SLR specific to St. Augustine, Florida (Goodison, Knowles, and Whiteford 2016).

SLR is caused primarily by the added water from melting ice sheets and glaciers and the thermal expansion of seawater as it warms. The Earth’s oceans absorb approximately 90% of the heat trapped by excess greenhouse gases in the atmosphere. About 40% of the historically observed SLR can be attributed to thermal expansion from ocean warming, while 60% can be attributed to glacial and ice sheet melt (Melillo, Richmond, and Yohe 2014). Because the City of St. Augustine is a low-lying coastal city, it is particularly vulnerable to the impact of SLR. There are two tide stations near St. Augustine: Fernandina Beach and Mayport. The Fernandina Beach tide gauge records at NOAA show SLR of about 200 mm in the last 100 years (20 mm per decade), which is similar to the global trend, while the Mayport rate is about 20% higher (25 mm per decade).

1.3. SLR projection

SLR projections are suggested based on reports from NOAA, FLDEO, a Sea-Grant study by the University of Florida, and Climate Central. Sea level trends are used with models of future SLR scenarios to estimate what sea levels might be at a given point in the future. The trends are overlaid with sets of future sea level projections for evaluation and mapping, such as the US Army Corps of Engineers (USACE) and the National Climate Assessment, commonly referred to as the NOAA projections.

Research has used a bathtub method for mapping SLR on top of high tide (Mean Higher High Water (MHHW) – tidal datum) with a Digital Elevation Model (DEM), generated from laser-based Lidar data, to identify low-lying areas. Florida Department of Economic Opportunity (FLDEO) released a Coastal Vulnerability Assessment for the City of St. Augustine, Florida in 2016. SLR is predicted as 0.12 m to 0.58 m for short-term (2045) and 0.21 m to 1.58 m for long-term (2085) (Table 1). “Low scenario” represents a continuation of historical observations, while “High scenario” considers the maximum possible glacier and ice sheet loss by the end of the century.

Table 16: SLR projections at Mayport, FL gage based on NOAA/NCA Projections. Increases are in units of feet relative to local mean sea level and calculated from the mid-point of the existing National Tidal Datum Epoch (1992). Source (FLDEO 2016)

Time Horizon	Low	Intermediate-Low	Intermediate-High	High
Short-term (2045)	0.12 m	0.21 m	0.37 m	0.58 m
Long-term (2085)	0.21m	0.46 m	0.98 m	1.58 m

Considering Intermediate-High projection, SLR is one-foot (0.30 m) in 2040 and three feet (0.91 m) in the 2080s. Similarly, the UF Resilient Community Initiative used one-foot, three-foot, and five-foot (1.52 m) scenarios on top of MHHW in the study (Goodison, Knowles, and Whiteford 2016). A scenario of one-foot of SLR would affect approximately 25% of the City’s area and is projected to occur as early as 2030, or as late as 2070. A three-foot SLR scenario would affect approximately 42% of the City and is projected to occur as early as 2070, or as late as 2100. A five-foot SLR scenario would affect approximately 68% of the City and is projected to occur no earlier than 2085. While the impacts to the City under this scenario are the greatest, the time frame for potential impacts is towards the end of this century.

Three types of coastal flood events were considered: MHHW, nuisance flooding, and the 1% annual chance floodplain. The coastal flood hazard events are projected by increasing the present-day base surface elevation through the addition of each SLR scenario increment to the base flood conditions. Simply, MHHW is the current water elevation, nuisance flooding is the water level possible to reach occasionally due to tides and small coastal storms, and a 1% annual chance floodplain is the worst case possible to occur once 100 years.

Based on the UF study (Table 2 and Figure 2), 25% of the City can be inundated with 0.30 m of SLR above MHHW, which can occur as early as 2030, or as late as 2070. When SLR reaches 0.91 m, 42% of the City can be inundated as early as 2070, or as late as 2100. When SLR is 1.52 m, it impacts 69% of the City, which can occur no earlier than 2085.

Table 17: Area of St. Augustine impacted for three relative SLR scenarios over MHHW. Source (Goodison, Knowles, and Whiteford 2016)

RSLR Above MHHW (Meter)	Time Frame (Year)	City Area (Sq. Kilometer)	Area Inundated (Sq. Kilometer)	(% of City)
0.30	2030 – 2070	21.7	5.48	25.22%
0.91	2070 – 2100+	21.7	9.15	42.15%
1.52	2085 – 2100+	21.7	14.86	68.48%

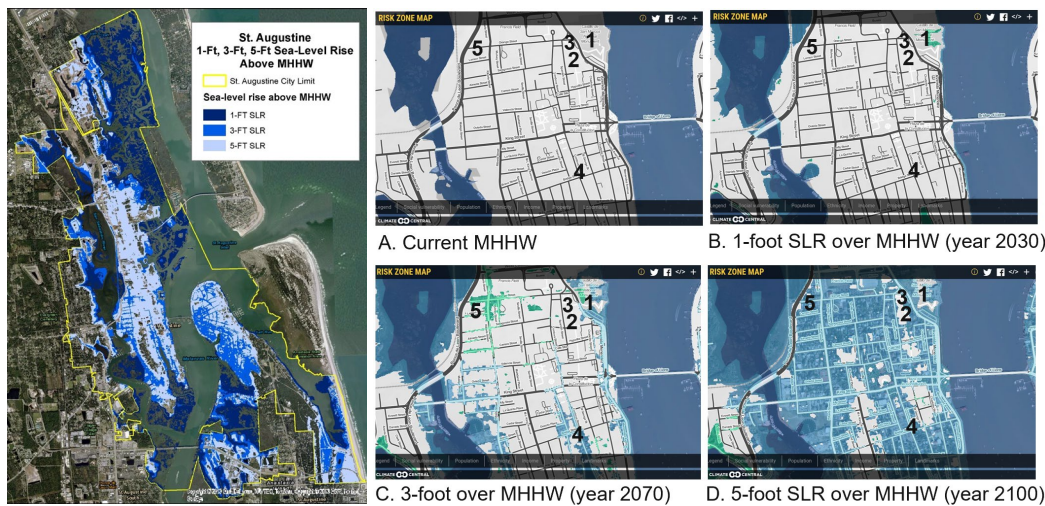

Figure 29: One-foot (0.30 m), three-foot (0.91 m), and five-foot (1.52 m) SLR scenarios over MHHW in the City of St. Augustine. A to D were generated using Climate Center’s Surging Sea Risk Zone Map, showing the focus areas in the St. Augustine historic district: 1. Castillo de San Marcos, 2. Oldest Wooden School House, 3. Old City Gate, 4. Cordova St., and 5. Orange St. Source (Climate Central website).

Particularly, salt marsh areas have a significant impact even from the 0.30 m (one-foot) SLR projection. It is projected that 60% of the salt marsh can be sunk with the one-foot SLR projection. In the sense that these salt marshes provide critical ecosystem services for the area, it may diminish the protective storm surge buffering function they currently serve after 2030. Furthermore, approximately 922 and 2,291 historic structures among 3,288 are potentially affected by three-foot and five-foot SLR respectively, while four private historic structures are impacted by one-foot SLR.

1.4. Storm surge effects

Storm surge can be considered as the case of a 1% annual chance floodplain and is often the greatest threat to life and property along the coast from a hurricane. A problem is that hurricanes get more frequent and become stronger over the past four decades. Storm surge is an abnormal rise of water generated by a storm, over and above the predicted astronomical tides. It is defined as the water level rise due to the combination of storm surge and the tide. The rise in water level can cause extreme flooding in coastal areas particularly when storm surge coincides with normal high tide, resulting in storm tides reaching up to 6.1 m or more in some cases.

Storms are divided into different categories, representing three feet of water surge for Category 1, and up to 2.7 m of water surge for Category 3 in the St. Augustine area based on NOAA. Storm surge from the Cat-2 hurricane potentially impacts most of the historic structures in the City with greater than 0.91 m of water level above ground.

1.5. Adaptation strategies

General adaptation strategies, based on the Intergovernmental Panel on Climate Change's (IPCC) 2019 report, are 1) Projection, 2) Accommodation, 3) Advance, 4) Retreat, and 5) Ecosystem-based adaptation (EbA). Protection strategies are applicable to valued assets with significant location dependence, which are unsuitable for infrastructure alteration or relocation. Hard protection (e.g., dikes, seawalls, breakwaters, barriers and barrages) and advance (building into the sea) are economically efficient in most urban contexts facing land scarcity but can lead to increased exposure in the long term. Where sufficient space is available, EbA can both reduce coastal risks and provide multiple other benefits. Accommodation strategies, such as flood-proofing buildings are applicable to valued assets which are suitable to alteration to reach sufficient elevation thresholds to avoid scenario-based inundation risks. Advance strategies create new land by building seaward, reducing coastal risks for the hinterland and the newly elevated land. Retreat strategies, such as voluntary setbacks and easements, are applicable to extendable assets with higher vulnerability to SLR and coastal hazards. EbA strategies provide a combination of protect and advance benefits based on the sustainable management, conservation and restoration of ecosystems, such as wetlands and reefs. Each adaptation strategy would be graphically presented in the VR environments.

2.0 METHOD

The current paper created three virtual environments: a webpage-based environment, a non-immersive VR environment, and a fully immersive VR environment, which will be discussed in greater detail below. 3D laser scanning and photogrammetry were used to create textured mesh models of three historic structures in the St. Augustine Historic District: Oldest Wooden School House (OSH), Old City Gate (OCG), and Castillo de San Marcos (CSM). Autodesk Infraworks and Google Maps were used to create a 3d textured model showing an overview of the City of St. Augustine. Unity 3D game engine software was used to create the non-immersive and fully immersive VR experience that is compatible with the Meta Quest VR headset.

2.1. Data collection: 3D Laser scanning and photogrammetry

Faro Focus M70, a terrestrial laser scanner, sends an infrared laser beam into the center of its rotating mirror which deflects the laser beam at varying angles in azimuth and elevations. M70 uses the "Time of Flight Measurement" to measure range distances calculating the amount of time it takes for the emitted laser light to return to the scanner. The raw data from the laser scanning were a point cloud with RGB data and a panoramic color image per scan. The point cloud is a dataset that represents the external surface of an object or a space in the form of X, Y, and Z geometric coordinates in computer graphics (CS) (Wang et al. 2018).

Photogrammetry is a technique that has been used to make measurements from photographs since the mid-nineteenth century (Albota 1976). It can produce 3d models by aligning multiple photographs of an object to extract 3D information from them. Its raw data are a point cloud and the images' color data. The photographs can either be 2D photographs or 3D photographs. The current paper explored both cases using Apple iPhone 6S for 2D photography and Ricoh Z1 for 3D photography.

2.2. Data transformation

Both laser scanning and photogrammetry generate millions of points as their raw data and the files can be several gigabytes in size for each structure. It was necessary to transfer the raw data to something that requires less computing power and memory. The current paper used meshes and textures. A polygon mesh in CS is a collection of polygons that define the external surface of an object. A higher number of polygons allows more precision in the surface representation but also increases the size of the dataset. When the point cloud is available, it is converted into structured data in the form of a polygonal mesh to produce the best representation of the object (Remondino 2011). 2D textures are images that are applied to a set of the polygons of an object to show the colors and shades.

The raw data collected from laser scanning and photogrammetry were ordered point clouds. To create photo-realistic 3D models, the current paper used Faro Scene software to generate 3D meshes and textures from laser scan data while it used Agisoft Metashape to create 3D textured meshes from photogrammetry. A challenge was to find an optimal mesh (optimum number of polygons) that is neither too dense nor too simple to visualize the photo-realistic textures of the three historic structures to maintain the quality of the VR experience in a cost-effective manner. The 3D textured mesh models generated were imported into Autodesk Maya for additional edits and were merged into a model for each structure, which later was exported in a fbx format with separate textures (jpeg). The graphic edits included some techniques, such as creating volumetric objects, UV maps, normal maps, etc. The basic workflow to generate 3D textured mesh models (Figure 3).

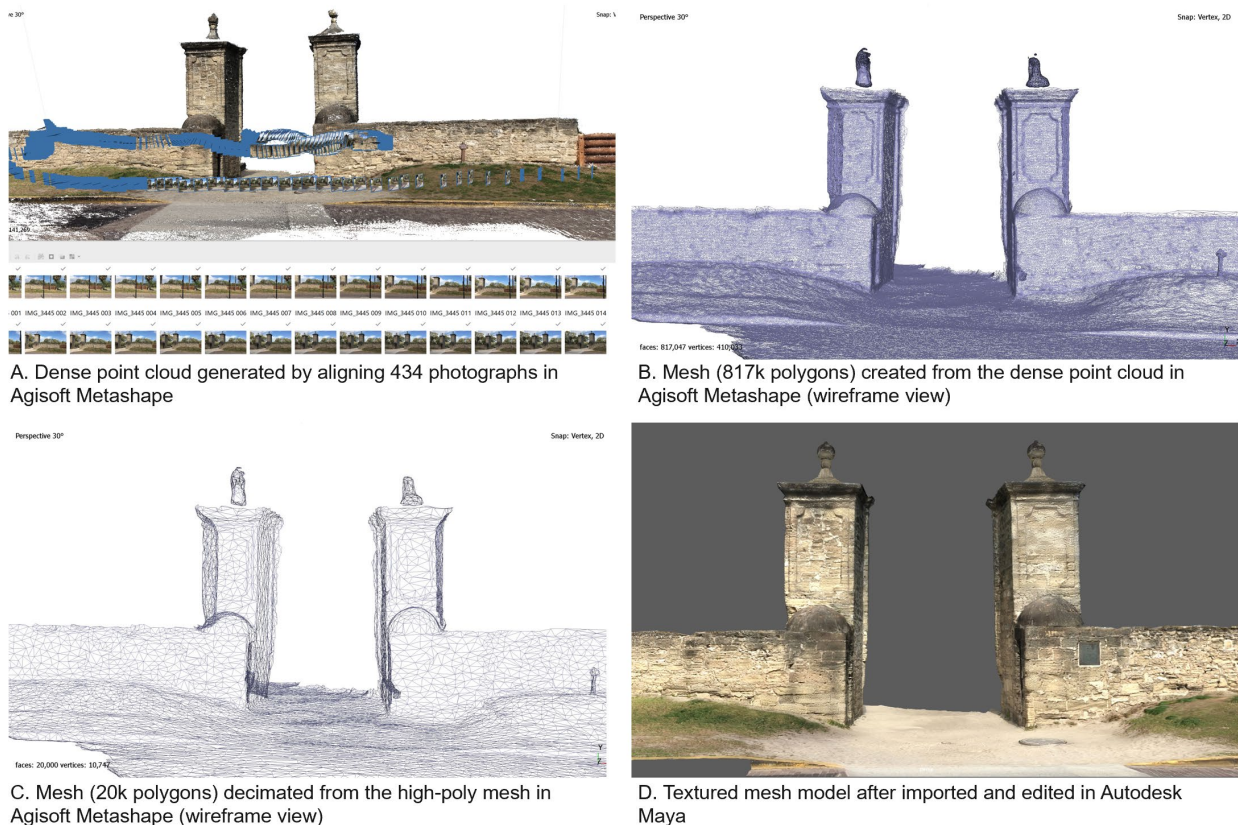

Figure 30: General workflow of photogrammetry to create the textured mesh model of St. Augustine's Old City Gate: aligning photographs, generating a (dense) point cloud, creating a high-poly mesh model from the dense point cloud, creating a low-poly mesh model decimated from the high-poly mesh model, building a texture map from the image data, and editing and finalizing the textured mesh model. Source (Park 2022).

2.3. VR Development

Many platforms offer the ability to combine visual, physics, and interactivity. These platforms or game engines are development environments and consist of three smaller engines: math engine, rendering engine, and physics engine (Ehtemami et al. 2021). Some game engines like Unity and Unreal support 3D graphics that can be used for developing VR projects.

The current paper used Unity to create a non-immersive VR environment and a fully immersive VR environment. Unity has been rated one of the most high-performance VR game engines and is well known for its platform independency. It allows developers to develop a non-immersive VR environment working with personal computers and a fully immersive VR environment compatible with Meta Quest 1 and 2. Quest headsets operate autonomously and do not require external sensors to locate themselves in space, unlike HTC Vive. Quest 1 and 2 provide graphic resolutions of 1440 x 1600 and 1832 x 1920; refresh rates of 72 Hz and 90 Hz; and 4GB and 6GB of RAM, respectively.

3.0 WEBPAGE-BASED ENVIRONMENT

The current paper created a webpage-based environment. It provides an informative environment where people can easily access the SLR learning content discussed earlier which includes texts, images, video links, etc. The main page consists of five sections starting with the summary of the visualizing SLR project (Figure 4). The other four sections are to open another webpage tab for the SLR learning content; download a compressed zip file that contains an executable non-immersive VR application for Windows computers; see the instruction on how to navigate the non-immersive VR

environment; and download a fully immersive VR application for Meta Quest headsets. It has been hosted via the author's school homepage.

Visualizing Sea Level Rise



Figure 31: Overview of webpage-based environment content. Source (Park and Kaul 2022).

4.0 NON-IMMERSIVE VR ENVIRONMENT

There are three scenes in a non-immersive VR: Initial scene, Main scene, and Quiz scene. Once the VR application is executed in a personal computer (Windows), users see the initial scene where it plays an animated scene that a camera hovers over an overview 3D textured model particularly showing the area near Lightner Museum and Flagler College in St. Augustine with documentary-themed music. Pressing any key on the keyboard transfer the users to the main scene where they can find four menu buttons in the window: READ, QUIZ, SWAP MODEL, and UPDATE WATER LEVEL. It was designed to let the users 1) read the SLR content, 2) experience water level simulations for the three structures in the St. Augustine historic district, and 3) take the quizzes about questions related to the SLR learning content.

The learning experience of the SLR content encourages more engagement and action than the webpage-based product. It incorporated different background music and audio effects to create different soundscapes and feeling in the initial scene and the main scene from the quiz scene which sounds more exciting and uplifting. Moreover, because it used 3D models with photo-realistic textures and animated ocean shaders, the SLR simulations appeared more realistic in the non-immersive VR product than those in the webpage-based product. Allowing the users to walk around the historic buildings submerged by the water is expected to reduce the psychological distance to the SLR event, which can result in raising awareness of the seriousness of SLR. Figure 5 shows the overall structure and navigation keys of the non-immersive VR environment developed by using the Unity game engine. The non-immersive VR environment is available for free download at the author's school homepage.

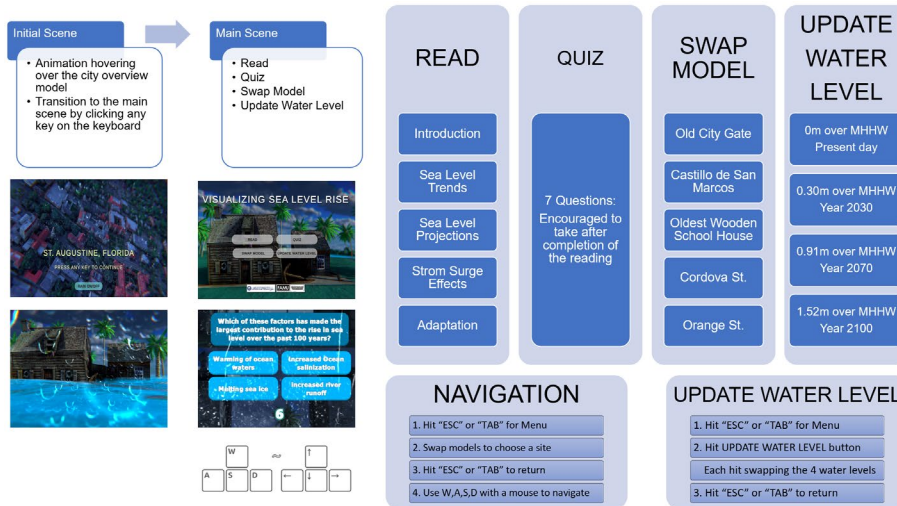

Figure 32: Overview of the non-immersive VR environment working with a personal Windows computer created by using Unity. Source (Park 2022).

5.0 FULLY IMMERSIVE VR ENVIRONMENT

A fully immersive VR product consists of an initial scene and the main scene. Users can learn the SLR content and take the quiz questions, however, its current focus was to create a realistic experience of SLR with storm surge flooding at the three historic structures during tropical storms or hurricanes.

The rain effect and the fast-moving water created a super realistic virtual scene in that people can experience the extreme weather in a safe and controlled virtual environment (Figure 6). It looked extreme but was alike the storm surge at Fort Myers in Florida caused by Hurricane Ian last October 2022.

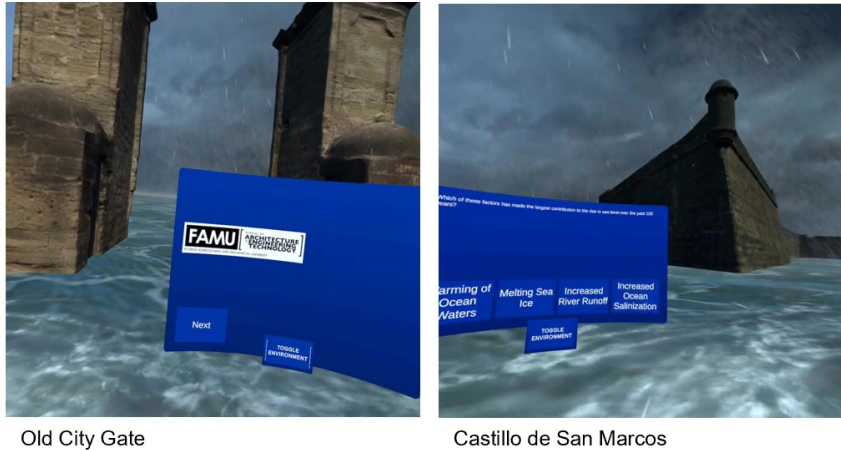

Figure 33: Screen-captured images during the fully immersive VR environment. Source (Park and Kaul 2022).

DISCUSSION AND CONCLUSION

The current paper explored three environments to increase public interest and awareness about SLR, particularly in St. Augustine, Florida. A webpage-based environment was easy and effective to display SLR learning content. A non-immersive VR environment provided a realistic 3D experience using photo-realistic 3D textured mesh models and a game-like environment working with a Windows personal computer. The fully immersive VR environment provided users with a 3D environment where they can be fully immersed in the photo-realistic textured mesh models and rain and water flow effects.

To address the visualization of the SLR impact in VR, further VR developments will be followed. It includes more interactive VR components and a time-based scenario that shows the consequences of the users' decisions associated with the mitigation strategies for the SLR impact.

The general consensus among the test users was that the fully immersive VR environment was the most attractive to view the SLR impact and reduce the psychological distance from SLR. In order to appropriately test its effectiveness, a statistical study needs to conduct in the future. Based on statistical experiment design, a power study with pre- and post-VR experience with 3 groups for each environment requires 28 subjects per group for 90% confidence, 22 subjects for 80%, and 18 subjects for 70% at the large level of effective size.

ACKNOWLEDGEMENTS

The current paper was funded by the Florida Department of State Historical Resources Small Matching grants (22.h.sm.300.152). The authors thank Dr. Mahsan Mohsenin for assistance with SLR data collection and Mr. Sunny Atwal for guidance with coding during the VR production.

REFERENCES

- Abdelhameed, Wael A. 2021. *VR in Heritage Documentation: Using Microsimulation Modelling*. In *Intelligent Computing*, edited by Kohei Arai, 1115–23. Cham: Springer International Publishing.
- Albota, MG. 1976. *Short Chronological History of Photogrammetry*. In *Proc of XIII Congress of the Inter. Soc. for Photogrammetry*.
- Blascovich, Jim, Jack Loomis, Andrew Beall, Kimberly Swinth, Crystal Hoyt, and Jeremy Bailenson. 2002. *Immersive Virtual Environment Technology as a Methodological Tool for Social Psychology*. *Psychol. Inq* 13 (August).
- Bricken, Meredith, and Chris M. Byrne. 1993. *Chapter 9 - Summer Students in Virtual Reality: A Pilot Study on Educational Applications of Virtual Reality Technology* © 1992 Washington Technology Center. Sponsored by the US West Foundation, the Washington Technology Center, and the Pacific Science Center. In *Virtual Reality*, edited by ALAN WEXELBLAT, 199–217. Academic Press.
- De Luca, Rosaria, Maria Grazia Maggio, Giuseppa Maresca, Desiree Latella, Antonino Cannavò, Francesca Sciarone, Emanuele Lo Voi, Maria Accorinti, Placido Bramanti, and Rocco Salvatore Calabrò. 2019. *Improving Cognitive Function after Traumatic Brain Injury: A Clinical Trial on the Potential Use of the Semi-Immersive Virtual Reality*. *Behavioural Neurology* 2019 (July): 9268179.
- Ehtemami, Anahid, Sang Bum Park, Shonda Bernadin, Laurent Lescop, and Andrew Chin. 2021. *Review of Visualizing Historical Architectural Knowledge through Virtual Reality*. In *IEEE VR 21 Conference on Virtual Reality and 3D User Interfaces*, March 27-April 3, Virtual. Lisbon, Portugal: IEEE. <https://hal.archives-ouvertes.fr/hal-03121591>.
- Florida Oceans and Coastal Council. 2010. *Climate Change and Sea-Level Rise in Florida: An Update of the Effects of Climate Change on Florida's Ocean & Coastal Resources*. Florida Oceans and Coastal Council.
- Georgiev, Danko D., Iva Georgieva, Zhengya Gong, Vijayakumar Nanjappan, and Georgi V. Georgiev. 2021. *Virtual Reality for Neurorehabilitation and Cognitive Enhancement*. *Brain Sciences* 11 (2).
- Goodison, Crystal, Hal S. Knowles, and William C. Whiteford. 2016. *Adapting to Rising Tides| Coastal Resilience in St. Augustine: Baseline of Our Past, Beacon for Our Future*. The University of Florida Resilient Communities Initiative.
- Guest, Haley, Heike K. Lotze, and Douglas Wallace. 2015. *Youth and the Sea: Ocean Literacy in Nova Scotia, Canada*. *Marine Policy* 58: 98–107.
- Hine, Donald W., Joseph P. Reser, Wendy J. Phillips, Ray Cooksey, Anthony D.G. Marks, Patrick Nunn, Susan E. Watt, Graham L. Bradley, and A. Ian Glendon. 2013. *Identifying Climate Change Interpretive Communities in a Large Australian Sample*. *Journal of Environmental Psychology* 36 (December): 229–39.
- Ibañez-Etxeberria, Alex, Cosme J. Gómez-Carrasco, Olaia Fontal, and Silvia García-Ceballos. 2020. *Virtual Environments and Augmented Reality Applied to Heritage Education. An Evaluative Study*. *Applied Sciences* 2020, 10, 2352.
- Jones, Charlotte, Donald W. Hine, and Anthony D. G. Marks. 2017. *The Future Is Now: Reducing Psychological Distance to Increase Public Engagement with Climate Change*. *Risk Analysis: An Official Publication of the Society for Risk Analysis* 37 (2): 331–41.
- Lescop, Laurent, Andrew Chin, Sang Bum Park, Anahid Ehtemami, and Shonda Bernardin. 2021. *FAMU Digital Documentation, a VR Narrative for Architectural Education*. In *15th Biennial International Conference of the European Architectural Envisioning Association EAEA15*, 483–94.
- Man, David Wai Kwong, Wai Sang Poon, and Chow Lam. 2013. *The Effectiveness of Artificial Intelligent 3-D Virtual Reality Vocational Problem-Solving Training in Enhancing Employment Opportunities for People with Traumatic Brain Injury*. *Brain Injury* 27 (9): 1016–25.
- McLean, Jared H., Katie Taladay, and Jin Dong. 2020. *A VR Environment for Demonstrating the Impact of Sea Level Rise on Hawai'i*. In *Practice and Experience in Advanced Research Computing*, 553–54. PEARC '20. New York, NY, USA: Association for Computing Machinery.
- Melillo, Jerry M., Terese (T.C.) Richmond, and Gary W. Yohe. 2014. *Climate Change Impacts in the United States: The Third National Climate Assessment. U.S. Global Change Research Program, 841 Pp*. U.S. Government Printing Office.
- O'Neill, Saffron, and Lorraine Whitmarsh. 2009. *Encouraging Climate Change Engagement through Affective Connections*. *IOP Conference Series: Earth and Environmental Science* 6 (February): 572003.
- Pidgeon, Nick. 2012. *Climate Change Risk Perception and Communication: Addressing a Critical Moment?*. *Risk Analysis* 32 (6): 951–56.
- Remondino, Fabio. 2011. *Heritage Recording and 3D Modeling with Photogrammetry and 3D Scanning*. *Remote Sensing* 3 (December): 1104–38.

- Schuldt, Jonathon P., Katherine A. McComas, and Sahara E. Byrne. 2016. *Communicating about Ocean Health: Theoretical and Practical Considerations*. *Philosophical Transactions of the Royal Society B: Biological Sciences* 371 (1689): 20150214.
- Shriram, Ketaki, Soon Youn Oh, and Jeremy Bailenson. 2017. *Virtual Reality and Prosocial Behavior*. In *Social Signal Processing*, edited by Judee K. Burgoon, Nadia Magnenat-Thalmann, Maja Pantic, and Alessandro Vinciarelli, 304–16.
- Soto-Martin, Ovidia, Alba Fuentes-Porto, and Jorge Martin-Gutierrez. 2020. *A Digital Reconstruction of a Historical Building and Virtual Reintegration of Mural Paintings to Create an Interactive and Immersive Experience in Virtual Reality*. *Applied Sciences* 2020, 10, 597.
- Wang, Yue, Yongbin Sun, Ziwei Liu, Sanjay E. Sarma, Michael M. Bronstein, and Justin M. Solomon. 2018. *Dynamic Graph CNN for Learning on Point Clouds*. arXiv:1801.07829.
- Watson, G. J., J. M. Murray, M. Schaefer, and A. Bonner. 2015. *Successful Local Marine Conservation Requires Appropriate Educational Methods and Adequate Enforcement*. *Marine Policy* 52: 59–67.
- Wilson, Steven G., and Thoams R. Fischetti. 2010. *Coastline Population Trends in the United States: 1960 to 2008*. U.S. Census Bureau.

ARCC 2023 RESEARCH PAPERS

Architecture & Humanities Track

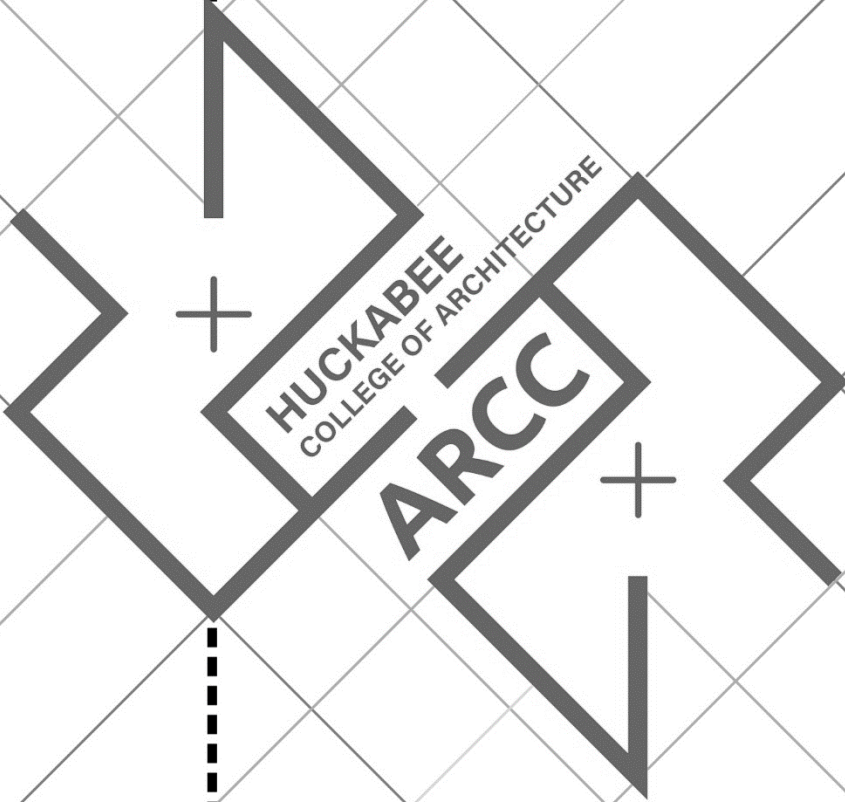

Design Excellence Reset: Shifting Values and Interrogating Value in a Dramatically Different World

Dr. Brian R. Sinclair ¹

¹ University of Calgary + sinclairstudio inc., Calgary, Canada

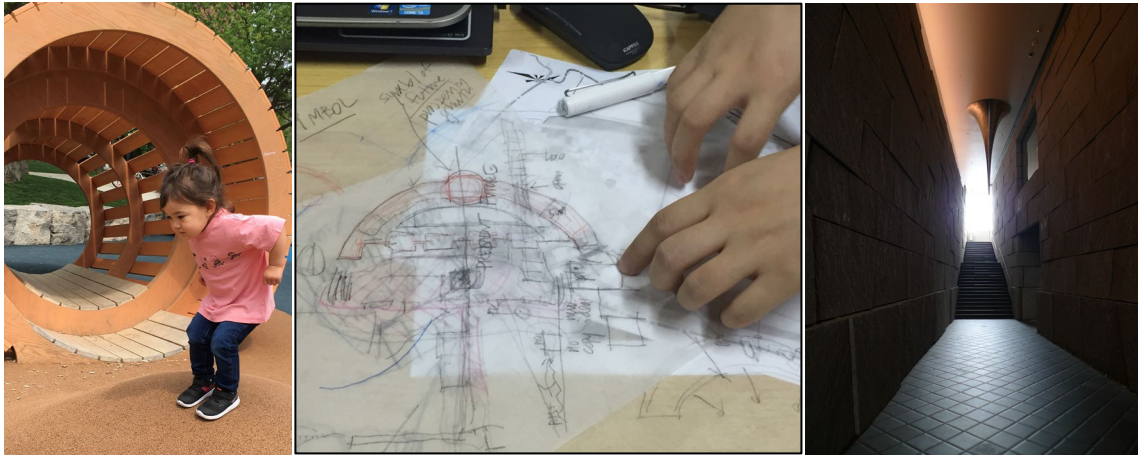

Source: brian r sinclair © 2023

ABSTRACT: In the short span of several decades, undeniably boosted by an array of recent and intense global crises – including climate change, health calamities, financial turbulence, social inequity, and international conflict, to name but a few -- societal views concerning the evaluation and determination of architecture and the built environment's place, position & price has been under intense scrutiny. Within realms of architectural education and practice, a common reflex, historically, was to focus on the formal dimensions of 'architecture as art' to set metrics around success. Aesthetics proved fundamental to this quest - that is, beauty as the primary measure of fine design. Building awards, as judged by peers, commonly emphasized look and feel beyond other, and in hindsight equally or more vital, qualities of the built environment. Relegated too frequently to the shadows were qualities that impacted health, environment, social value, Indigeneity, and sustainability – to note but a few of the more salient features that only now fall into serious view. However, with societies around the globe now encountering major shifts in core values, our awareness & assessment of design excellence is in question and under intense scrutiny. Cost Benefit Analyses (CBA) and Return-On-Investment (ROI) calculations need major reconsideration and radical reform. Moving beyond image, internationally we are witnessing architects, clients, authorities with jurisdiction, and the public, demanding a broadening of assessment, and a deepening of meaning, concerning design quality. Transcending beauty as narrowly understood, contemporary definitions of design excellence are expanding to embrace equity, diversity, justice, inclusion, worth, and responsibility, as crucial. The research, an initial exploratory exercise that comprises a preliminary exercise within a larger national inter-sectoral multi-year study, involved an environmental scan examining the ways in which design excellence is presently defined and operationalized in various sectors and societies internationally. A key area under consideration was national architecture policies - that is, country-level documents delineating aspirations for 'good design'. Numerous such policies, from countries around the globe, were studied to reveal common ground as well as distinctions. Other policies, targeting design quality and shaped by professions, clients, and authorities with jurisdiction, were identified, explored, and analyzed. Building from this work, which involved case studies and logical argumentation, a conceptual framework for design excellence was developed -- with a goal to provoke thinking around new ways that we might better see, define, execute, and realize design quality in the built environment. Central to this research was the interrogation of both values and value as fundamental to our shared understanding of quality (e.g., quality of design, quality of construction, quality of life, etc.). The author argues that a significant reset is needed, concerning architectural education, practice, advocacy & regulation, to better respond to dramatically different conditions, expectations, desires, demands, obligations, and opportunities.

KEYWORDS: architecture, quality, systems-thinking, innovation, values, lived experience

1.0 PREAMBLE

“While we endeavor to provide spaces and places that are functional, durable and dependable, the real magic of design and planning lies in those aspects that move us well beyond. Strong design and planning accept the pragmatic as a given while aggressively pursuing the inclusion of the poetic. It is in this intricate balance of pragmatic and poetic that the spiritual is most likely to manifest. With basic needs realized, users of our spaces and places can then have the opportunity to experience beauty, encounter solitude, attain flow and achieve meaning in ways that enhance emotions, accentuate perception, and heighten pleasure.” (Sinclair, 2019)

“Through a growing capacity to tolerate uncertainty, vagueness, lack of definition and precisions, momentary illogic and open-endedness, one gradually learns the skill of cooperating with one’s work, and allowing the work to make its suggestions and take its own unexpected turns and moves.” (Pallasmaa, 2009)

Quality is an obsession for many professions, and professionals, in our contemporary world. While it is often argued that we live in an era that is losing sight of quality, in both process and product, there are contrarians that stress quality has never been so important and essential. The challenge of course, and it is significant, is that quality means different things to different people, diverse organizations, distinct cultures, and so forth. Things become more complicated when we attempt to measure quality – and especially in the context of architecture, landscape, and the built environment. Modern society’s mantra is often “If you can’t count it, it doesn’t count.” Such reductionistic thinking is problematic – it is arguably perilous and even damaging when it moves from rhetoric into regulation. In other words, despite our obsession with bottom-line pretense, it proves somewhat daunting to somehow quantify design excellence. Another sticky issue relates to where the authority over excellence dwells. Who decides when a design is good? And based on what knowledge or yardsticks? What are the criteria for assessment? And if we can agree on a definition of quality in the built environment, how is this goal delineated, enshrined, & enforced? How are lived experiences of users factored into our thinking? Are guidelines, for example intended for consumption by design professionals, adequate to realize quality? Or are potent policies and rigorous regulations required to ensure compliance around quality? These are all very real concerns, and ones that are increasingly confronted across many spheres of our communities, cities, and countries. The present research, preliminary in extent and an initial component of a much larger and longer (5-year) research project, begins the thorny work of interrogating quality.

2.0 BACKGROUND

“How does architecture create value? What kinds of value? How much and for whom? For how long and at what cost? These are the fundamental questions that all too often are being left unanswered, with loss of value and resources as a result.” (Danish Association of Architectural Firms, 2019)

“At some point architecture lost its mission to change society. It is largely because architecture has become a tool of capital. But I believe that, limited as it may be, architecture still has a power to propose something to society, or has some role to play in society.” (Toyo Ito, 2012)

When we contemplate quality, for example in architecture and design, we are often focused on traditional understanding of merit and conventional definitions of ‘excellence’. In many instances these approaches have been inculcated through architectural education – such as Vitruvian notions around perfection & completeness or Bauhausian views on design craft & culture. More often than not, our attention has been directed at low hanging ‘disciplinary’ fruit, such as aesthetics, form, and formality. Beauty is front of mind, with ideals informed by the Golden Section or other mystic geometry, geomancy and/or proportion-based modes of measuring success. The split of the architectural education into the Ecole Polytechnique and the Ecole de Beaux Arts added confusion through the increasing distinction and separation of the pragmatic from the poetic, the objective from the subjective, and the scientific from the artistic. While these dualities are rather generalized, and perhaps unfair, there are many biting realities connected to the separation of duties and the specialization of fields. In the end, society’s escalating departmentalization of knowledge, and our world’s obsession with “a place for everything and everything in its place”, may be severely hindering our ability to grasp, delineate and realize quality in both means (process | design) and ends (product | building).

For the past few decades, and certainly since the millennium, our world has been subjected to extraordinary changes, challenges and, with more frequency, catastrophes (see, for example, UN Environment & International Energy Agency, 2018; Irfan, 2019; Pak, 2019; Imam, 2020). Following on the heels of an unprecedented period of international order, stability, and peace, we have seen in contemporary times growing uncertainty, indeterminacy, and chaos. Nowadays many systems are under strain, many organizations are in upheaval, and many individuals are encountering stress (Sinclair, 2021). The demands on long established means and ways prove intense and undue, with erosion and collapse more common and more tragic. From human-made structures, such as financial and political bodies, to natural systems, such as ecological and environmental spheres, we are witnessing incomprehensible upheaval. Impacts of broad and endemic instability, mutation and failure are grave (Sinclair, 2020). Implications, costs, and effects of spectacular shifts, including societal disorder, pain and suffering prove exceptional. Clearly the consequences of inaction are alarming. That said and given the sheer magnitude of many of turns in context and circumstances, we battle to find appropriate routes forward. Included in such reformation must be revised metrics for mapping success -- for example, Cost Benefit

Analyses (CBA) and Return-On-Investment (ROI) calculations need major reconsideration and revolutionary reform. Tackling unfamiliar problems using existing tools and outdated models will be ineffective and impotent.

Issues around defining and attaining quality -- in buildings, landscapes, and the urban milieu -- are magnified through misalignments between local, regional, national, and international standards and norms around quality. Again, we need to query who has authority, dominion, or domain when it comes to setting and achieving quality goals. Procurement is clearly a big part of the equation, as is design and construction. Less clear, and perhaps less understood, are the roles of citizens and civil society in defining and demanding quality in the built environment. With growing emphasis over the past century on professionals, and self-regulating professions, serious agency was granted to those with education, knowledge, and the support of statute (i.e., legislative protection over scope and/or title). For much of that century the models for self-regulation, and the exchange of legislative protection in exchange for competency assurances, worked quite well. However, in recent years knowledge has become more pervasive and publicly accessible -- with an associated and growing 'crisis of confidence'. Disasters at the hands of specialized professionals -- such as turbulence in financial systems, transport problems, supply chain dysfunction, structural collapses, nuclear disasters, environmental degradation, health threats, etc. -- all contribute to a public that is increasingly skeptical, cautious, and concerned. Assaults on the efficacy of science and the value of truth further erode public certainty and raise questions around safety, security, reliability and the like. In such a quagmire determining where to go with quality is sticky and messy.

The present paper presents initial views and findings on the pilot stages of a much larger and longer national study into the issues of quality in the built environment. This first phase, constituting an environmental scan and opening assessment of 'national architecture policies' (NAP), sampled from around the globe, helped build awareness and set the stage for a much deeper and broader 5-year study (recently approved by a major granting agency and now underway). This paper should be seen as a series of considerations, and provocations, aimed at identifying key issues concerning quality and precipitating action in further research. It is abundantly clear that the need is urgent to address quality, to bring people together into shared understanding, to implement means to improve quality in the built environment, and, critically by extension, to heighten quality of life in our cities and towns (regardless of location, jurisdiction, power, privilege, and politics).

3.0 PILOT EXPLORATION | PRIMING THE PUMP

"Architecture directly determines the quality of our environment, and thereby also the dignity of human existence. Architecture shapes public taste, influences moods and forms culture, and is in this respect extremely important for social cohesion. The architect creates space and spirit -- this is the way the natural and built environment becomes an integral part of national culture. The buildings, public spaces, public works of art, engineering structures, the settlements and the natural environment together form the cultural landscape, which is our common national value." (Hungarian National Architecture Policy, 2015)

"Architecture often ignores its role of making a place with purpose." (Cedric Price, 2003)

As part of a much larger (multi-million dollar) and longer-term (5-year) intersectoral (approximately 140 participants) national study into quality in the built environment, a start-up grant was provided by a major government funding agency (Social Sciences and Humanities Research Council of Canada) to initiate early explorations into relevant topics that would subsequently be tackled by a bigger and more robust interdisciplinary and inter-institutional research team. To capitalize on these initial funds the author structured two inter-related activities to consider quality in the built environment: a sweeping environmental scan to identify issues and actions globally pertaining to design excellence, and a comprehensive analysis of National Architecture Policies (drawn from a rather large array of published and operationalized documents). The goal of the initial research was to build greater awareness and increase understanding of the multitude of forces and factors in play, in numerous locales, concerning the pursuit of heightened design quality. Related to this quest was an effort to identify vital subject areas covered by, and frequently common to, said National Architecture Policies.

A serious number of countries around the world have, over the past several decades, been shaping, detailing and enacting these National Architecture Policies with aspirations to raise the bar on the quality of the built environment. These efforts have in many cases involved broad public engagement to reflect common values, and expectations, around buildings, landscapes, spaces and places. While the focus has, understandably, been on the public realm there are many implications for and lessons to the private sphere. In many instances sensibilities have moved from the symbolic, permanent, and monumental to other ways of tackling how we conceive, construct then occupy environments. While matters of 'formal' design still have gravity, other concerns are arising that are perhaps more ephemeral and intangible. Emphasis, for example, on culture, history and health, can be readily seen in many policies. The present project, pilot in scope and intention, considered several dozen National Architecture Policies in an effort to scan the milieu of design change, reaction and response to new forces and factors in our countries and their cities. Each policy document was critically examined with respect to fundamental features, while also seeking to better understand downstream impacts on urban & architectural design. In some cases, the policies were very developed, delineated, robust and resilient. In other cases, the policies were less mature and more schematic (or suggestive). Some policies placed greater emphasis on urban design while others aimed more centrally at building design. For the purposes of

the present paper, the goal was to begin to paint a high-level picture connecting policy to product (or lines from aspirations around quality to improved architecture). In this way we might begin to grasp how quality might be better defined and refined, and how the systems for procuring and delivering better built environments might be reset and redesigned.

The ensuing National Architecture Policies were secured and appraised in this initial exploration – while the list is not exhaustive and complete, it did provide the researchers with a wide-ranging and enlightening spectrum of approaches and issues to contemplate: Australia, Austria, Belgium, Croatia, Czech Republic, Denmark, Estonia, France, Germany, Hungary, India, Ireland, Lithuania, Malaysia, Norway, Portugal, Romania, Saudi Arabia, Scotland, Singapore, Slovenia, Sweden, The Netherlands, United Kingdom (UK), and the USA.

The key topics culled out of the analysis of National Architecture Policies, as noted below, begin to illuminate the ways in which the built environment, and most notably as manifest in buildings, are valued and prioritized around the globe. The list is not comprehensive, but rather illustrative -- and not all aspects are considered or realized in all constructed environments. It is important, however, that the array of topics is both diverse and, in many cases, quite novel. In earlier times, as the profession was emerging in North America, a focus would have been most demonstrably on form and aesthetics. Now, considering rather dramatic societal shifts, we witness the arrival of design concerns that are more user-centered (e.g., equity, public and population health, culture and identity, etc.) and migrate beyond the boundaries of individual building sites (i.e., encompassing environmental systems, heritage planning, etc.). The spectrum of these concerns shines light on realms for reform and reset in both architectural education and architectural practice. Future research by the author will be exploring how such emergent qualities can be more effectively and meaningfully injected and operationalized within said education and practice.

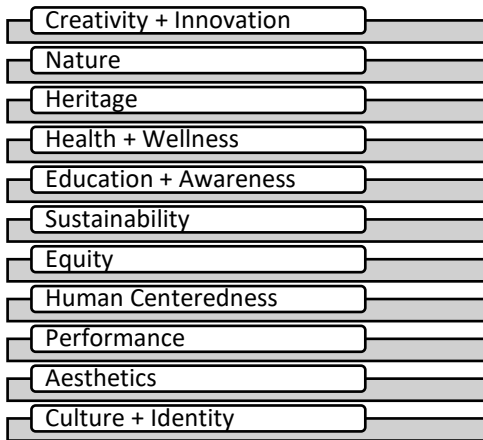

Figure 1. Features and Facets Prevalent in National Architecture Policies (Sinclair + Esmaeili, 2022)

Certainly, this list of topics that influence and impact design quality proves intimidating, especially considering the complexity of design in our modern times. While on one hand the regulatory ethos for architecture and urban design is deep and daunting, on the other hand the stakes are high with regard to the ways the built environment impacts people and place. Decisions we make on design of the built environment have long-lasting consequences – and it is our responsibility, in large measure as architects, to direct results in good ways. When the decisions are ill-considered, we all suffer – poor health, rising pollution, resource depletion, species extinction, global warming, increased crime, heightened fear, deferred maintenance, and so forth. When we get the equation right (or at least better than it may be now), the positive effects can be significant. Cities are hard to quickly redesign, reform and reconstruct. Buildings tend to be somewhat solid and enduring. Mistakes made in the name of cost-cutting, or expediency, or short-term gain, inevitably have profound and troubling ramifications to city and building dwellers. In critically considering the rich & impressive assortment of National Architecture Policies collected in the present study, it becomes apparent that such approaches have many lessons to offer and that all cities should be crafting and enacting same. While the present paper only presents policy features and facets in a rudimentary fashion, further research will explore each in greater depth and detail with a view to devising more integrated and holistic means of proffering design guidance for architects, developers, government, and citizens intent on improving the Quality of Life (QoL) in our spaces, places, blocks, buildings, communities and cities.

4.0 RETHINKING, RESETTING, REDESIGNING | THE BIGGER PICTURE

“In that context, and in practice, the process of individual creativity was imbued with a certain utopian potential and intrinsic positive value and universal social dimensions. Today, however, that ‘creativity’ is reduced to a caricature of aesthetic forms, expressionistic objects or sculpture – and is mobilized in the service of the dominant power structures.” (MacDonald, 2014)

“Appropriate solutions to some of our most daunting problems will arise through the concerted efforts, open dialogue, and collective wisdom of the wide array of stakeholders, professionals, politicians, decision makers, and citizens (both engaged and disenfranchised) who have the will and wherewithal to make a difference and to make the world safer, healthier, and better. It seems vital for us to critically examine, and question, our belief systems and their connections to the ways we define, refine, and realize progress.” (Sinclair, 2015)

Engaging in the pilot investigation, anticipating the more comprehensive and far-reaching national research project, proved insightful and valuable on many fronts. While the research was preliminary in nature, it was catalytic in revealing the need to commit to further interdisciplinarity views, to enact more holistic approaches, to foster greater collaborative practices, and to be willing to transect sectors of society that are often isolated, separated and detached from one another. For generations, the assessment of quality in architecture, or urban environments, was entrusted, fundamentally, to the regulated professions and to well-trained professionals. In manifold ways such posturing, from a historic vantage point, is understandable. Society granted certain privileges to competent professionals in exchange for assurances around safety, health, and welfare. And for countless years this approach debatably worked quite well. However, over time our societies have become ever more complex, and our systems increasingly complicated, with knowledge burgeoning, communication confounding, and problems thickening. While the growth and development of information systems has proved a blessing, it has also often been rendered as a bane. Technology, in this sense, is both solution and problem. Into such a messy mix the present research, including the larger and longer-term national study of quality in the built environment, aims to gain some clarity on shared definitions of excellence that can be embraced, enacted, and, hopefully, ensured.

A major objective within the ongoing inquiry is to invite & involve a bigger swath of sectors into the equation – that is, to cooperatively unite players from many corners of society in order to better ascertain a collective understanding of design excellence. For example, a contractor responsible for erecting a building may see quality in different ways than would downstream occupants. Or a municipal government may define design excellence via more quantitative methods and measurable means than might, for comparison purposes, a community organization that is dealing with lived experiences for disenfranchised populations. In such examples, we see collisions of values, priorities, perspectives, needs and desires. In our current times it is, of course, essential to pursue more equitable, fair, diverse, and inclusive ways of seeing, thinking, and acting. While at one time in our distant history our populations may have been more homogenous and our expectations more aligned, today we must accept, accommodate, and celebrate different views, distinct needs, and divergent aspirations. One size definitely does not fit all. Without a doubt such a multiplicity of viewpoints and a wide range of players translates into a pressing need to design our built environments in dramatically different ways. The present research tackles such objectives in an arguably innovative, unconventional, and precedent-setting fashion.

To achieve change in ways that society, and its constituent populations, subsets, and subsystems, can better address quality in the built environment will undeniably require considerable disruption – a radical reset. Many of our ‘values,’ and our approaches to ‘value’ (or worth), demand reexamination given new and emerging circumstances. The author argues that such change cannot transpire via minor tweaks and minimal adjustments – rather, it will necessitate a severe overhaul. A radical reset is essential to enable and ensure environments that are responsive, responsible, restorative, and regenerative. At present the ‘quality’ of buildings may be viewed as more directed towards the superficial (often speculative) than the substantive, and more about the visual than the visceral. In many cases quality is defined by checklists, or celebrated by awards with limited criteria and often little means to prove performance (for example, via post occupancy evaluation). However, as we are now beginning to comprehend with more clarity existential threats to our existence, rapid deterioration of our environment, significant assaults on public health, and the growing complexity & incomprehensibility of our systems, our efforts to shape our built environments in more potent and positive ways matter. Our actions as architects have real, and often grave, consequences on biology, psychology, sociology, ecology, and society writ-large.

To this end, a profound, drastic and radical reset, concerning quality, must be doggedly pursued – it should be multipronged, collaborative, and concomitant over numerous areas (Sinclair & Esmaeili, 2022)

4.1 Education

In many ways our educational systems – from K-12 and post-secondary to professional and societal education – need attention in order to effectively change things culturally, sociologically and societally. The values in place now are arguably in need of realignment – they have, of course, driven much of the design and construction we witness in our towns and cities. Often speculative and commonly fueled by a need for profits before people, the policies and processes for development may have worked over the last century – when unbridled growth was an assumption, unlimited resources were a given, and more was always deemed better. However, as our problems have exploded in number and scale, and our awareness of downstream implications of poor decisions has grown, it is urgent to see, think and act in very different ways. With regard to reform, while all levels of education should see change, this paper is most concerned with environmental design education. To attend to quality in the built environment, in serious ways and with real traction, the curricula in schools of architecture will need to be rethought. While this is underway in many places, the nature of crises demands a much clearer and more concerted effort within the landscapes of design education

globally. As design education sees reform, and a shared vision is forged, more attention can be directed to K-12 and public (citizen) education – to alter the status quo and instill new values that better grasp the profound connections between the ways we design, build and live in our spaces and places. The author has written extensively (see Sinclair) on the need for greater attention and learning, to address serious deficits in architectural education – most notably in areas of human behavior, business, and research. All these deficits have connections to this paper’s quest for paths to better quality in the built environment.

4.2 Regulation

The regulatory milieu is where good ideas gain weight and consequences. If architects envision novel and creative ways of approaching design with quality front of mind, this will mean little without the teeth and traction of solid, well-structured, and implementable policy. When we think about quality in the built environment, including of course buildings, architects and planners are increasingly becoming more aware of long-standing requirements and emerging needs - -whether related to look + feel, materiality + construction, capital costs + operational expenses, health consequences, urban design contributions, environmental impacts, etc. However, even with innovative research proffering meaningful evidence, policy transformation can be an uphill climb. Of course, wildly complicating matters are the intense issues of politics, power, and privilege. Influence matters, and especially within our established modes of operating in cities – whether private or public sector, whether profit or non-profit, whether government or corporation. These players have tremendous opportunities and obligations to contribute to solutions, domains and dimensions that can usher in improved quality of the built environment, and, de-factor, improved quality of life. It is important to underscore that meaningful change will necessitate, and arise from, cooperation and collaboration over sectoral borders – in other words, through the productive, concerted and sincere inter-sectoral efforts of academics, professionals, government and citizens. The days have long passed where a sole person, or single discipline, or a specific department, can alone sort out and solve seriously wicked problems.

4.3 Research

Architecture, as both discipline and profession, has an arguably thin and inadequate culture of research, and especially when cast in comparison to other professions such as medicine and engineering. Our current situation is in part a vestige of an historic decision to split apart the master builder into two streams, each with unique knowledge territories – the architect (École des Beaux-Arts) and the engineer (École Polytechnique). With the architect leaning towards the art side, with more subjectivity, poetics and intuition deployed, came reliance on and subscription to the ‘black box’ of creativity and imagination. Rather than the engineer’s right or wrong mathematical calculation to size a structural member, the architect was liberated to deal with proportion, harmony, balance, and so on. While both the art and science sides of building creation are vital, the architect’s willingness to operate in many cases without ‘evidence’ has created a unique series of dilemmas. In contemporary architectural education, many schools have limited or no curricula addressing research in any serious manner – that is, instilling an understanding and ability concerning the conduct of research, the design of methods, the rigorous pursuit of knowledge + ‘facts’, and the ability to have confidence that decision making is sound, valid, reliable and predictable. In pursuing quality over recent decades, there has been an emphasis on the formal, the visual, the sensorial, and so forth. However, in our present times, where lived experience must have equal footing with aesthetics, there are pressures on the profession to solve problems, and derive solutions, based on many realities both internal and external to a given building project. Schools must inculcate research acumen in students. And these students need to graduate and move into practice with a respect of, and toolsets for, research. Quality in the built environment will be most meaningfully achieved if the architect is leading processes that benefit from sound understanding of the variables in play in a project – including matters artistic, scientific, psychological, sociological, cultural, spiritual, legal, financial, and so forth. Governments do not extend self-regulation and professional status to architects in the name of only art and beauty. While these are elevated aspirations, meeting the lower levels of Maslow’s pyramid is equally needed and certainly a compelling imperative. On a very optimistic note, more firms are proactively, assertively, and successfully founding research arms within their companies – with staffing by not only architects, but also urban sociologists, cultural anthropologists, environmental psychologists, medical doctors, chemists & physicists, and others. These research arms often operate on their own externally oriented funded research projects while concurrently and synergistically contributing to and collaborating with the design side of the company.

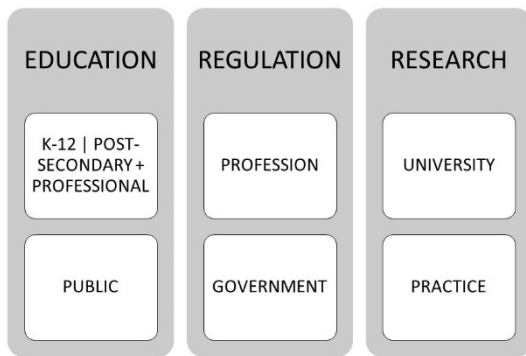

Figure 2: Strategy to Promote Awareness of Quality Design (Sinclair + Esmaeili, 2022)

In many ways the novelty of the present research approach lies in its commitment to incorporate views from a wide variety of players, stakeholders, actors, and agencies connected to the conception, creation, occupation and upkeep of the spaces and places in our communities and of our cities. When such diverse actors are on the same stage, then some real progress can be realized. Contemporary times, for many and often comprehensible (and even justifiable) reasons, have ushered in intense fragmentation. Our ways of viewing and valuing quality in the built environment have fallen victim to such endemic division – of people, of politics, of processes, of budgets, of governance, and even of living. We now know with real certainty that our built environments impact our behavior, our health, our psychology, our sociology, and even our happiness. We know that daylight can amplify productivity. We know green space can enhance wellness. We know that views can impact healing. On the other side, we know negative environments can contribute to much dysfunction and many ills, including but not limited to obesity, asthma, poisoning, loneliness, sadness and even suicide. So, without any doubt, there are convincing reasons – pertaining to humanity, economy, ecology, and the like – to get the design of our world as ‘correct’ and as ‘comforting’ as possible. We now painfully know the outcomes of unhealthy, oppressive, divisive, and discriminatory spaces and places. Architects are only now beginning to more fully grasp the agency and ability that they need to tackle some of the challenges on our doorstep, to operate across disciplinary borders, and to help reverse the downward slide on many fronts (Couzens, Sinclair & Klumper, 2022). Today there are many powerful reasons, but most notably ethical imperatives, to get design ‘right’.

5.0 SYNOPSIS | A BRIGHTER TOMORROW

“Interweaving of humanist principles and architectural design appears to be a fruitful and optimistic path for designers.” (Lyon, 2017)

“Considering architecture in the context of the massive changes currently taking place reveals that our profession is more reactionary and conservative than the rest of the world might suspect.” (M. Shamiyeh, 2007)

Quality is a critically important, yet increasingly allusive, aspect of our buildings and blocks, spaces and places, communities, and cities. While on one hand we know with growing certainty the impacts (both negative and positive) of the environment on people, on the other hand the burdensome and complicated societal systems act in many ways to subvert success in achieving design excellence. The present paper, presenting initial environmental and policy scans, aimed to identify and illuminate some key subjects, and pressing issues, concerning our pursuit of higher design quality, and quality of life, in our built environments. Using National Architecture Policies (NAPs) as a window into matters of design quality, the research explored subjects deemed by many countries to be of paramount value. In some ways some of these subjects were anticipated, while in other cases they proved novel and unanticipated. Together this diet of determinants – namely, creativity + innovation, nature, heritage, health + wellness, education + awareness, sustainability, equity, human centeredness, performance, aesthetics, and culture + identity – give the present research a solid footing as quality in the built environment is further examined. This array of subjects undeniably, and meaningfully, transcends more traditional and formal means for assessing quality, and awarding design excellence, in our cities. While several facets, such as human centeredness, has no doubt been on the minds of architects conceiving and crafting buildings, they nonetheless need to be more explicitly called out and more overtly embraced. And, as the present research underscores, the conversations need to aggressively move beyond architectural circles to include community groups, scholars, educators, allied professionals, builders, and authorities with jurisdiction (to name but a few of the many individuals and organizations with stakes in the game). As the large and longer-term project develops and unfolds, the researchers are very mindful of the need to deploy methods, such as participatory approaches, that welcome all voices to the table in safe, sensitive, and ethical ways. The pan-Canadian network of researchers embraces a potent array of players, drawn from multiple sectors: the academy, the design professions, the construction industry, community organizations and government. The composition of the author’s research team (1 of 14 across the country), exemplifying a commitment to multidisciplinary engagement, includes architects, landscape architects, community health scholars, sociologists, social workers, and others. Problem seeking and solving, and design innovation, today

needs to use vastly different means to arrive and more appropriate, more diverse, more inclusive, more accessible, more sustainable, and better quality built environments. Environments which, while attending to conventional aspirations around form, function, beauty and delight, must also respect and respond to the varied needs, unique aspirations, and rich lived-experiences of all in our communities.

Over the past decade, most notably, we have come to understand that the built environment is not neutral. In fact, in countless cases, it has been intentionally (and, of course, in many cases inadvertently) designed to control, manipulate, oppress, or contain targeted populations within society. Disturbingly, yet not surprisingly, many of these populations are communities of colour or groups otherwise discriminated against. Architects cannot ignore the potency of design to either empower or to oppress. They also cannot operate in a bubble, disconnected from users of buildings and occupants of the city. To the contrary, it is an opportune time to reconsider how design and construction can be realigned to better hear more voices and invite more people to the table. The author (Sinclair, 2022) has recently put out a call for architects to aggressively migrate from the provision of luxury services (serving power, politics, and privilege) to the delivery of essential services (serving the greater public, including the disadvantaged and disempowered). Buildings, and landscapes + urban spaces, involve massive investment of capital and are constructed to last. Given such investments and relative permanence, and in light of emergent awareness around promoting human rights, cultivating respect, and affording dignity to one another (i.e., regardless of race, orientation, beliefs, or station in life), it is critical to reset the systems in place that fund, fuel, conceive, and construct our built environments. Change is daunting and difficult, especially when the stakes are high, and the agendas are narrow. All of this said, things are unquestionably off course. Arguably, it is inappropriate (if not immoral) not to push hard – against professional, educational, and governmental entrenchment – in order to right the ship. People first. Design follows. Quality counts.



photograph brian r sinclair © 2023

REFERENCES

- Architect: Document Your Value Creation. Danish Association of Architectural Firms, 2019. Page 5.
- Couzens, D., Sinclair, B.R. & Klumper, B. Rebellion, Robotics and a Radical Reboot: Emergent Processes in Turbulent Times. Resilient City: Physical, Social and Economic Perspectives. ARCC-EAAE 2022 International Conference. Architectural Research Centers Consortium + European Association for Architectural Education. Miami, Florida, USA, 2022.
- Imam, S., BUILDING Magazine: Coronavirus and the Road to Climate Change Recovery. 2020. [Online] Available at: <https://building.ca/feature/coronavirus-and-the-road-to-climate-change-recovery/>
- Irfan, U., Vox. 113 degrees in France: why Europe is so vulnerable to extreme heat. All-time temperature records have been broken in the heat wave sweeping the continent.-2019-europe-france-germany-spain. 2019.
- Ito, Toyo. Forces of Nature. Princeton Architectural Press: New York. 2012.
- Lyon, Corbett. "Humanistic Principles, Sustainable Design and Salutogenics." In Design for Health: Sustainable Approaches to Therapeutic Architecture. Editor: Terri Peters. Architectural Design. No 146, March/April 2017. Pp 56-65
- MacDonald, Robert. Foreword. In: Design for a Complex World: Challenges in Practice and Education. Graham Cairns – Editor. Libri Publishing: Oxfordshire. 2014. Page vii.
- Nemzeti Építészeti politika. Hungarian National Architecture Policy. 2015. Page 9.
- Pak, A., Embodied Carbon: The Blindspot of the Buildings Industry. 2019. [Online] Available at: <https://www.canadianarchitect.com/embodied-carbon-the-blindspot-of-the-buildings-industry/>
- Pallasmaa, Juhani. The Thinking Hand: Existential + Embodied Wisdom in Architecture. W.Sussex UK: Wiley. 2009. pp.111
- Price Cedric. Re:CP. Basel: Birkhauser. 2003.
- Shamiyeh, Michael. Organizing for Change. Basel: Birkhauser. 2007. pp 11.
- Sinclair, Brian R. Salutogenesis + design: pursuing an architecture of wellness in an age of illness. Performative Environments: ARCC Conference 2021. Architectural Research Centers Consortium. Tucson, Arizona, USA 2021.
- Sinclair, Brian R. Walking the wire - sustainability + design in an uncertain ethos. Foreword to 'Sustainable Architecture: Between Measurement and Meaning'. Editors: Carmela Cucuzzella and Sherif Goubran. Vernon Press: Delaware, USA. 2020.

- Sinclair, Brian R. "Spirituality and the City". Book chapter: *The Routledge International Handbook of Spirituality in Society and the Professions*. Edited by Laszlo Zsolnai and Bernadette Flanagan. Routledge: Oxon, UK. 2019. Pp 93-102.
- Sinclair, Brian R. "Integration | Innovation | Inclusion: Values, Variables and the Design of Human Environments." *Cybernetics and Systems: An International Journal*, 46:6-7, 2015. Pp 554-579.
- Sinclair & Esmaeili, Nooshin. *Design Quality Reset: Interrogating Definition, Delineation, Measurement and Meaning in a Shifting Ethos*. *Advances in Architecture, Urbanity and Social Sustainability*. Volume XII. International Institute for Advanced Studies in Systems Research and Cybernetics (IIAS), Ottawa, Canada 2022.
- Sinclair, Brian R. *AWOL: psychology, business + research in contemporary architectural education*. EAAE-ARCC International Conference. European Association for Architectural Education + the Architectural Research Centers Consortium. *The Architect and the City*. 2nd Valencia International Biennale of Research in Architecture. Valencia, Spain. Editorial Universitat Politècnica de València, 2020.
- UN Environment and International Energy Agency. *Towards a zero-emission, efficient, and resilient buildings and construction sector*. Global Status Report. 2018.

Developing a Visual Tool to Encourage Public Participation in Decision-Making Processes for Intervening in an Urban Historical Context

Najmeh Malekpour Bahabadi¹, Mahyar Hadighi²

¹ Texas Tech University, Lubbock, TX

² Texas Tech University, El Paso, TX

ABSTRACT: Citizens can be meaningfully involved in multiple phases of the urban planning process from decision-making to implementation via a dedicated online platform through which they can interact with planners and decision-makers. In historical contexts, local people are essential resources for decision-makers seeking critical local information needed for effective planning and intervention—including what those citizens recall from the past about the area's social values and the built environment and what they imagine and hope for their neighborhood's future. This public knowledge, collected through storytelling and mapping, can play a fundamental role in shaping the framework for neighborhood rehabilitation plans. As a foundation for designing an online visual questionnaire to collect local knowledge and understand the views and expectations of local people, this study focuses on theoretical ideas to define a framework for an online visual questionnaire tool. The tool presented provides a common visual language that people can easily understand and use whatever their social class, education, or background. It also has the benefit of enabling citizens and planners to interact directly regardless of their geographical location.

To proposing a framework for the online visual questionnaire, the first step was to review some existing visual tools and methods, including analog used for community engagement and digital used in urban planning to encourage and support public participation. Through an analysis of these methods, some important variables and criteria were identified that further our understanding of citizens' perceptions of their neighborhoods. The next step, as part of a larger study, will be examining a historical public space, including a bazaar, hammam, and cistern—located in the historical context of Yazd—a central city in Iran registered as a cultural heritage site by UNESCO—as a case study with the larger goal of identifying some specific criteria, based on the culture and the vernacular architecture patterns, to inform the questionnaire's framework.

KEYWORDS: Visual questionnaire, Public participation, Local knowledge, Urban historical context.

INTRODUCTION

In his book, *The Deliberative Practitioner*, John Forester states that city planners can shape public learning and public action by consulting with city residents. Planners can also play an important role in promoting citizens' hopes or deepening their resignation in regard to the future and functionality of the area where they live by "sharing or withholding information, encouraging or discouraging public participation" (Forester 1999, 4). According to Barbham (2009), "interdisciplinary and participatory design collaborations" in the design disciplines including urban planning constitute the best and most democratic way of solving the societal problems of the digital, postindustrial age. In addition to seeing public participation in urban planning as a democratic process, he argues that citizens' involvement in the planning and design process will render the plan more acceptable to its future users of the place by taking their knowledge, perspectives, and insights into account. In a study focused on defining a typology for geoparticipation, Zhang makes a similar argument: "Ideally, a participation project seeks to achieve a high level of citizen engagement where citizens may have the power to influence the processes and outcomes of decision-making" (2019, 40). Further, Nelessen challenges standard planning practices as follows: "The non-traditional planning and design process will not bear fruit if we cannot bring people—municipal officials and developers, engineers and planners, the community at large and the body politic—together to effect real choice" (Nelessen 1994, 81). Nelessen also notes that participation not only makes the planning process more fluent but also reassures the community that its preferences will be considered. In terms of an urban historical context with local communities, employing social science is perhaps even more critical than in other environments, especially when the planners are not local. In these contexts, due to their sense of belonging, particularly if they have lived in the area a long time, people are more likely to participate in the planning process in order to share their stories about the past and their ideas for the future. The information they share about the social, cultural, and symbolic meanings of the built environment can inform planners' decisions on the direction of the neighborhood's future. Yet, although involving citizens in decision-making processes is vital, they are not urban planning professionals or experts; therefore, as Al-Kodmany (2000) has argued, their engagement will be meaningless if they cannot understand the plans or express their ideas. For this reason, finding common ground between local people and planners or designers is necessary to bridge this knowledge gap. To achieve this goal, it is incumbent on planners and designers to determine—based on their evaluation of the culture and the context—the most effective ways to interact with local

people and the best ways to exchange ideas. Also, “in order for decisions to be made in a democratic fashion, structural mechanisms and tools must be developed through which personal wishes can be brought to the surface to reach a consensus” (Al-Kodmany 2000, 220). Among the communication tools to consider for this purpose is visualization. Al-Kodmany argues that “visualization, which can take many forms, is highly effective for drawing out the public’s concerns and opinions” (Al-Kodmany 2000, 220).

To help people share their knowledge, information, and perceptions of the built environment, this paper investigates how to define a framework as a basis for designing an online visual questionnaire. While we confirm that “effective visualization is the key for communicating ideas and engaging public participation, the question then centers on identifying the most effective techniques in a given planning situation. “The answer will depend on the skills and experience of the participants, the size of the geographic area being analyzed, the resources of the leadership team, and the stage a group are at in the planning process” (Al-Kodmany 2000, 222). To answer this question, the design process comprises two main steps: First, a fundamental framework is put in place to facilitate data collection. Second, the questionnaire content is determined and a way to visualize the historical context’s qualities and prioritize the information needed for future planning are set as a basis for deciding on some criteria for the questionnaire’s content. In reference to the first step, in this paper, visualization methods and tools that are well-established in community development and urban planning are considered. In reference to the second step, a historical public space in the historical context of Yazd, Iran, is investigated. Next, a discussion is presented focused on connecting the results of the two steps to facilitate the design process of online visual tools in the future.

1.0 VISUAL TOOLS AND PEOPLE’S PERCEPTIONS

The built environment as the context of everyday life conveys meaning far beyond what we can see. It has significance that both stems from and supports social life and culture. By studying the built environment, designers and researchers can identify signs of cultural and social life and hidden meanings by working with residents who have lived in and, therefore, are familiar with the current physical environment. Planners and residents need to find a common language—one that is not necessarily verbal—so that they can understand. According to Sannof (1991):

“Perceiving and interpreting the physical environment is a complex process involving the interaction of human physiology, development, experience, and cultural sets and values with outside stimuli. In making sense of the visual world, we rely on a number of physical characteristics which define objects and their relationships in three-dimensional space. (Sannof 1991, 14).

Pointing to the “difficulty with materializing the abstracted reality of planning proposals” and the challenge of communicating changes that are introduced as planning proceeds, Wilson proposed “visualizing these developments through augmented reality to demonstrate the visual impact of proposals, turning abstracted technical drawings into photo-realistic images that are more easily understood by people” (Wilson 2019, 184). Echoing the importance of visual data, Jang and Kim commented that check-in locations and photographic images constitute “the two most commonly used types of data in measuring and quantifying people’s spatial perceptions” (Jang 2019, 3). Further, researchers have shown that visual tools enable broader participation in the planning process, opening it up to, for example, “people with physical or cognitive disabilities” (Glegg, 2019, 302), and that such tools can help “address language barriers across cultures and literacy levels” (Oliveira & Partidário, 2020). “Visualization, on the other hand, is any technique for creating images to communicate a message. The use of immersive visualization and more natural interaction increases the sense of presence, creating an enhanced game experience” (Varinlioğlu, et al. 2022). Rene Davis, Professor of Architecture and Urban Design at University of California, Berkeley, talks about the storyboard as a preliminary design tool in film making, and investigates its possible role in architectural education. He also discusses “the dominance of visual culture in progress since the advent of television” (Davids 1999, 239). Corrie van der Lelie, faculty of Industrial engineering at Delft University, also discusses storyboard and its role in the product design, and the way “this visual script integrates all parties involved in the production” (Lelie 2006, 159).

In order to involve people in a given community in the decision-making process and to help them interpret their physical environment and share their knowledge, planners employ diverse visualization and mapping methods, as it will be discussed in the following sections. Some of the tools and methods such as photo interviewing and the Ten Seed Technique are analog and appropriate for working with local communities, whereas others are primarily place-based and facilitate the process of gathering critical information directly from the environment. “Digital mapping applications are often used in consultative geo participation projects to collect local spatial knowledge regarding public perceptions of local environments; and participants are actively involved with commenting [on] and discussing place-based issues regarding specific planning and development projects” (Zhang 2019, 40). Some research draws on a mix of analog and digital tools, such as the case of Pilsen in Chicago by Al-Kodmany (2000). Through a review of these methods and tools, a holistic overview is presented in the next section as a context for designing a framework for a visual questionnaire.

2.0 EXISTING VISUALIZATION METHODS

This section focuses on a review of the existing visual tools and methods developed and tested in different contexts, including the US, the UK, and China. The reviewed tools are divided into three categories: (1) analog tools and methods used by municipalities to determine principles and regulations or to develop guidelines for community development, (2) computerized visualization methods that are common in urban planning, and (3) tools that combine high- and low-tech methods.

2.1. Analog tools and methods

In *Visual Research Methods in Design*, Sanoff (1991) proposes two visual methods: photo interviewing and “knowledge of emerging environmental preservation strategies (KEEPS). The first method “Photo interviewing” is used to explore residents’ perceptions of their community in the residential community of Twin Rivers, New York. The research conducted by asking two sets of questions related to location and meaning in relation to photographs of the area and the residents’ evaluative comments on the photographs. The second method “knowledge of emerging environmental preservation strategies” (KEEPS), used in the town of Murfreesboro, North Carolina, focuses on “Identifying environmental qualities, formulating community goals, and matching the appropriate strategies to the goals” (Sanoff 1991, 165), as the three important phases of the process. In the first phase, three drawings depicting the past, present, and a suggested future of the neighborhood without the action of the residents are shown to the residents. The residents then share their notes on the qualities of the neighborhood depictions and their opinions of each. The residents then state and prioritize their goals for the neighborhood and the strategies and methods for implementing each of these. Anton Nelessen (1994), in *Visions for a New American Dream*, discusses visualization techniques to promote democratic design and planning, including visual preference survey (VPS). The purpose of VPS, which includes photographs, evaluation forms, and a questionnaire (optional) as a basis for analysis, is to help residents express their views on the present community image and come to an agreement about its future character. In vision Planning Survey, the visual and spatial qualities as well as the functional characteristics of the neighborhood in its current state are presented as images to residents who are asked to rate them as acceptable or unacceptable on a scale of -10 to +10. “The images must reflect what people see when they move through the study area, along streets, sidewalks, and public spaces, all of the integral components of the public viewshed” (Nelessen 1994, 84). Through an analysis of the VPS, some design features are extracted to include in the master plan. These features, which could pertain to specifications for walls and materials, net density, setbacks, decorative elements, roof pitches, etc., can serve as a guide for architects in designing buildings that reflect the character of the vision.

The Ten Seed Technique is a qualitative tool developed by Jayakaran (2002) to investigate how members of a community view various issues. The technique “can be used to explore perceptions on many topics, ranging from equity in distribution and access to motivation for taking certain actions” (*The Ten Seed Technique: Learning How The Community Sees Itself* 2002, 14). The technique has the benefit of being very flexible such that it can be used in combination with other techniques. Jayakaran used the technique as a Participatory Learning and Action exercise to understand the relative importance a community places on a given factor in relation to others to through gathering qualitative information on issues “especially related to the perceptions of the community and the way people see themselves in relation to others” (2002, 6) such as wholistic worldview analysis, which as Jayakaran argues further is a productive way of “understanding how the community sees itself and the rest of the world” (2007, 42). As shown in Figure 1, the process relies on broad participation: the innermost circle represents areas where the community is influential, the middle circle areas where outsiders associated with the community can be influential, and the outermost circle areas that are outside the control of these groups. The circles are further divided into segments (Figure 2), each representing a particular issue, which is where the Ten Seed Technique operates. According to Jayakaran, the technique “involves asking the participants to distribute ten seeds into each segment allotted to an issue, to show which aspects were within the control of the community, dependent on outsiders, or totally out of everyone’s control” (2007, 43).

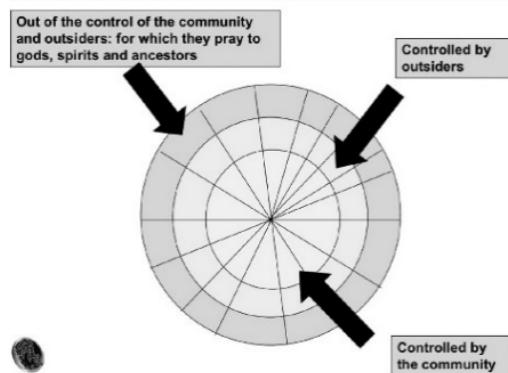

Figure 1. Wholistic Worldview Analysis (WWVA) diagram. (Jayakaran, 2007)

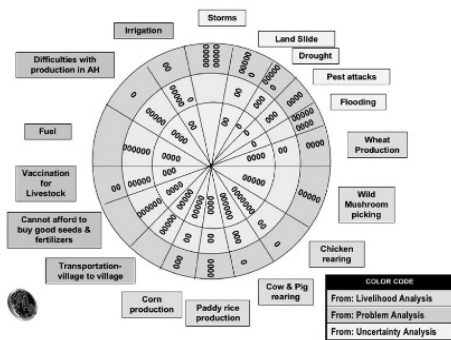

Figure 2. WWVA + Ten seed technique- People's evaluation of their influence on the community's issues. (Jayakaran: 2007)

2.2. Computerized methods

Arno van der Hoeven in his article argues that “social media can function as platforms where the values attached to historic urban landscapes are represented through the narrative practices of storytelling and mapping” (Hoeven 2019, 61). By confirming that text data gathered from social media effectively demonstrate people’s behaviors and perceptions related to a place, in their research Jang & Kim (2019), proposed a novel method to create a visual representation of urban identity—a “crowd-sourced cognitive map”. They employed the method to improve the conventional cognitive mapping method to depict the collective identity of a city and drew a cognitive map through a computational method based on crowd-sourced opinions collected from social media. Location, activity, and meaning are three important factors used by them. “The cognitive map does not necessarily display all locations of the site; rather, selective locations of focus are displayed with descriptive explanations” (Jang and Kim 2019, 8). ChangeExplore is a smart watch app with opportunities for citizen participation in the local planning process; Developed in Newcastle by Wilson (2019), this in-situ app sends notifications and provides information to participants as they move through the place and collects data by asking them about their experiences. Nineteen citizens and three professional planners were asked to pilot the app and provide feedback on their experiences. Wilson found that the app enhanced critical thinking about the built environment and notifications sent from the app increased the participants’ engagement with the place, encouraged them to think about the changes they would like to see there, and gave rise to a sense of power in relation to understanding the place. Based on these findings, the app strengthened the participants’ sense of belonging to the place. The participants’ responses to the notifications allowed the app to find the issues on time. However, Wilson also found that the app elicited issue reporting rather than encouraging citizen participation in creating the future of their built environment.

In a paper presentation, co-authored with Robert Olszewski and Agnieszka Turek (Warsaw University of Technology, Poland), Bogna Kietlińska presented the results of a geo-questionnaire—a tool designed to support social participation—with a sample of 154 respondents answering questions about public perceptions of a recently revitalized street in the city of Płock. The questionnaire provided an opportunity for respondents to geolocate their answers, thereby rendering them less abstract and more suitable for direct use in spatial planning (open geoinformation society). Through the geo-questionnaire, people were able to mark things they liked and things they disliked and respond to open questions. The geo-questionnaire, however, does have limitations, among which are the possibility of confronting inadequate internet access and limited digital skills on the part of users, both of which undermine the tool’s ability to be representative of local citizens (Haklay, Jankowski and Zwoliński 2018, 138).

2.3. Combination of High and Low- tech methods

In their work in Pilsen neighborhood, a Mexican- American community with a long history, Al- Kodmani (2000) and his research team from University of Illinois in Chicago studied the new visualization technology to find out how to clarify the planning process for residents. The team aimed to help residents to express their knowledge and science of the community in a productive and meaningful way, understandable for both planners and residents to promote a successful democratic design and planning process. The researchers, therefore, employed GIS to collect critical information in the form of maps and images, and a designer to provide the residents with sketches of their ideas, Overall, communicating in this interactive way resulted in a fluid, contextual design process that promoted community involvement. To collect the data, the research team conducted a workshop in the Pilsen neighborhood, including by inviting local residents to voice their concerns and share their ideas about the future of the neighborhood. The team then incorporated the ideas into GIS plans and the designer drew sketches based on the residents’ ideas and asked the residents their opinions of specific changes proposed. The team indicated that a combination of visualization techniques, both traditional and computerized, proved to be effective in eliciting public participation: “The visual images and maps from the GIS and the responsive sketching by the artist provided a common language to which all members of the community—young and old, poor and rich, powerless and powerful—could relate” (Al- Kodmani 2000, 227).

The JigsAudio developed by Wilson (2019) is an ex-situ physical technology device designed to encourage people to express themselves through drawing and talking. The device is a hardware tool used to collect data from participants including their drawings and recorded voices, which are then presented together on a website. In Wilson’s study, 223

people used the device, and the deployments occurred in partnership with selected hosts in order to test the devices. Systematic observations and informal discussions with participants were used rather than interviews, which were deemed time-consuming and hindered people's participation. Because of the informal nature of the participation and communication method through drawing and recording the ideas, it was difficult to conduct formal interviews with the participants. For this reason, the researchers interviewed the person who collected the JigsAudio data. The app was used for five projects over a period of eleven months, which revealed that the mixture of drawing and talking was effective in engaging participants in expressing and understanding complicated visions that would have been difficult if not impossible to achieve using just one medium. The mix of tools also had the benefit of affording participants opportunities to be more creative and expressive in discussing their views and feelings. The device had a low-tech appearance, which led the participants to feel comfortable using it, which is an important consideration given that it is not uncommon for people to experience stress when asked to work with digital technologies. Pánek demonstrated a mapping web-application system developed in Olomouc in the Czech Republic that "allows a subjective layer of emotional mapping of the city on top of thematic mapping" (Haklay, Jankowski and Zwoliński 2018, 137). The system draws on the concept of emotional understanding of space and place and includes maps to collect emotional data and also a way to capture emotions about using maps. Pointing to the importance of learning from failure, Pánek argued that using an analog approach employing pen and paper can be helpful for people to express themselves but does not work for mapping. However, digital methods through which people can draw points, lines, or polygons are not entirely helpful. Therefore, Haklay et al. combined paper and digital maps as a way to "record details about who collected the information and also to record participant demographic data" (Haklay, Jankowski and Zwoliński 2018, 137).

3.0 DISCUSSION

Although in gathering local information the importance of in-person discussions and arguments in the form of a workshop or traditional hall gatherings cannot be denied, scholars have argued that though still helpful are no longer helpful these methods should be supplemented or in some cases even replaced with online methods. According to Bobbio (2019), online participation is more effective than townhall-type gatherings for collecting information from citizens, including suggestions, proposals, and ideas. Bobbio referred to the use of the online platform Decidim (Let's decide) on the part of the municipal administration in Barcelona as an example: in 2016, the administration received approximately 10,000 proposals in a period of just a few months. In Brabham's (2009) view, efforts to elicit citizens' participation using web-based strategies benefit from the speed, reach, asynchrony, anonymity, and interactivity of the web as well as its ability to present multiple kinds of content. Furthermore, he emphasizes the web's global reach, which can be used to enable people regardless of location to communicate. According to Wilson (2019), local governments experienced pressure to use digital technologies and as a consequence established engagement methods, such as town hall meetings and consultation events, have given way in favor of online methods that facilitate communication between planners and citizens.

According to Jang and Kim (2019), online tools and georeferenced picture tags help researchers to create a mental map of the neighborhood and capture various aspects of the urban environment, including activities, ambiance, and senses. "This power in computing has allowed for new opportunities in producing interactive content, such as photo-realistic images and web technologies used for engaging people in place changes" (Wilson 2019, 87).

Overall, apps and websites are widely employed to enable citizen participation, and in this context the proposed visual questionnaire would be in the form of a photograph-based web page with three main sections: section 1: the participants' perceptions; section 2: the participants' role; and section 3: the participants' evaluation of the questionnaire. The first section will provide the participants with the opportunity to share information, evaluation, and ideas on three categories: related to past, present, and the future of the neighborhood. For defining their roles and responsibilities participants will be asked to rate their responsibilities regarding each plausible future alteration, in the second part, by employing charts instead of photos. Through the responses in this section, the participants clarify their status in regard to the community's issues and their relationship with the government. This section will be framed based on the Ten Seed Technique combined with the wholistic worldview analysis diagram. As the technique relies on right-brain function activated by visuals such as pictures, the full potential of the brain for perceptive analysis can be elicited (Jayakaran 2002, 7). In section 3, the participants will be asked to respond to a set of questions designed to elicit their ideas regarding working with the visual questionnaire, which will be used to inform the future development of the tool.

The first section of the questionnaire concerning the participants' perception will be defined by reviewing "the three basic elements of place identity proposed by Relp: physical settings, activities, and meaning" (Jang & Kim 2019, 2), and "the "gestalt-like" concept consisting of multiple dimensions that include physical distinctiveness, social imageability, emotional attachment, and satisfaction" (Jang & Kim 2019, 2), and in line with Lynch (1960), considering the shape, color, or arrangement as facilitators to make a vividly identified, powerfully structured, and beneficial mental images of the environment. To capture the participants' perceptions of the context, three main areas of interest are investigated: built environment, significance, and activities. The participants' ideas pertaining to each area will be investigated based on key variables (Figure 3).

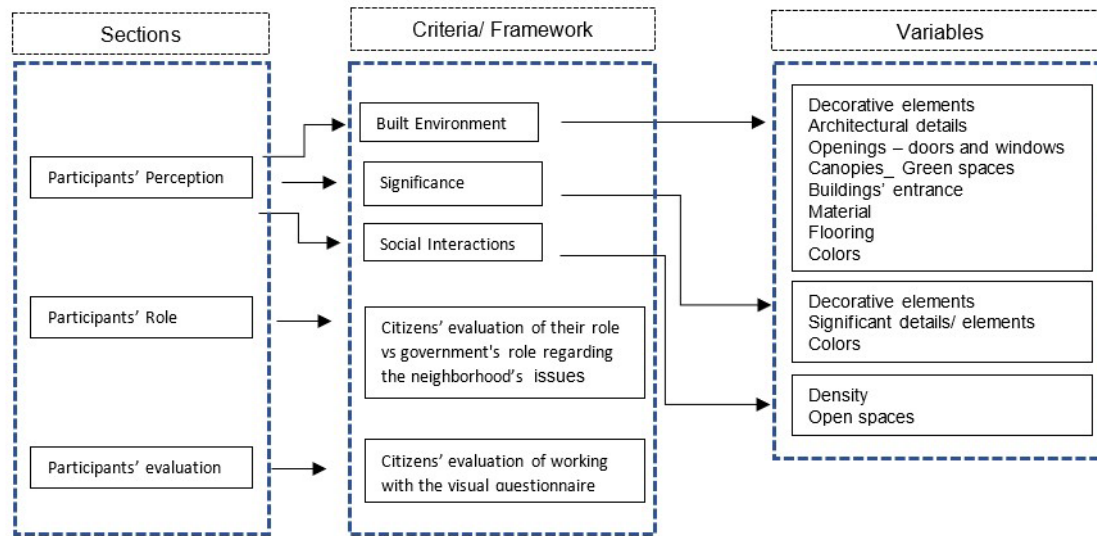

Figure 3. The questionnaire's sections and framework. (Author, 2022)

For each variable, related photographs will be provided to help the participants reflect on the context. As Haklay et al. (2018) noted, there is a need to integrate new methods and techniques with old methodologies such as sketching. Therefore, in order to collect information pertaining to the past life of the locale, the tool will offer participants the chance to attach photographs and sketches and even to record their own voices as they tell their stories about the past as a contribution to envisioning the future. It will be instructive to consider the evaluative images and other attached files as a source for planners, as Al-Kodmany (2001) stated, in relation to deriving valuable information about how to improve the physical form of their communities. Additionally, an investigation of the images can also help define new variables for future development. The tool is expected to provide a common visual language that people can easily understand and use regardless of social class, education, and background, an opportunity for nonlocal planners and designers to learn about residents' perceptions and expectations, and (3) an opportunity for both citizens and planners to interact regardless of their geographical location at any given time.

REFERENCES

- Aladalah, Mohammed, Yen Cheung , and Vincent Lee. 2015. "Enabling Citizen Participation in Gov 2.0: An Empowerment perspective." *Electronic Journal of e-Government* 77-93.
- Al-Kodmany, Kheir. 2001. "Online Tools for Public Participation." *Government Information* 329- 341.
- Al-Kodmany, Kheir. 2000. "Public Participation: Technology and Democracy." *Journal of Architectural Education* 220-228.
- Bobbio, Luigi. 2019. "Designing effective public participation." *Policy and Society, VOL. 38, NO. 1* 41–57.
- Brabham, Daren C. 2009. "Crowdsourcing the Public Participation Process for Planning Projects." *Planning Theory* 242- 262.
- Davids, Rene. 1999. "Serial Vision: Storyboards In The Design Studio." *87th ACSA ANNUAL MEETING*.
- Forester, John. 1999. *The Deliberative Practitioner; Encouraging Participatory Planning Process*. The MIT Press.
- Foth, Marcus, Bhishna Bajracharya, Ross Brown, and Greg Hearn. 2009. "The Second Life of urban planning? Using NeoGeography tools for community." *Location Based Services*.
- Glegg, Stephanie M. N. 2019. "Facilitating Interviews in Qualitative Research With Visual Tools: A Typology." *Qualitative Health Research, Vol 29* 301- 310.
- Haklay, Muki, Piotr Jankowski, and Zbigniew Zwoliński. 2018. "SELECTED MODERN METHODS AND TOOLS FOR PUBLIC PARTICIPATION IN URBAN PLANNING – A REVIEW." *QAESTIONES GEOGRAPHICAE* 127-149.
- Hoeven, Arno van der. 2019. "Historic urban landscapes on social media: The contributions of online narrative practices to urban heritage conservation." *City, Culture and Society* 17 61- 68.
- Jang, Kee Moon, and Youngchul Kim. 2019. "Crowd-sourced cognitive mapping: A new way of displaying people's cognitive perception of urban upace." *Plos One, 14*.
- Jayakaran, Ravi. 2002. *The Ten Seed Technique*.
- Jayakaran, Ravi. 2007. "Wholistic worldview analysis: understanding community realities." In *Participatory Learning and Action*, 41-48.
- Lelie, Corrie van der. 2006. "The value of storyboards in the product design process." *Pers Ubiquit Comput* 159–162.
- Lynch, Kevin. 1960. *The Image of the City*. Cambridge: MIT Press.
- Nelessen, Anton Clarence. 1994. *Visions For a New American Dream*. Chicago: Planners Press.
- Oliveira, Ana Roque de, and Maria Partidário. 2020. "You see what I mean? – A review of visual tools for inclusive public participation in EIA decision-making processes." *Environmental Impact Assessment Review*.

- Sannof, Henry. 1991. *Visual Reserch Method In Design*. New York.
2002. "The Ten Seed Technique: Learning How The Community Sees Itself." *Child Survival Connections*.
- UNESCO. 2011. "RECOMMENDATION ON THE HISTORIC URBAN LANDSCAPE." Paris.
- Varinlioğlu, G., Sepehr Vaez Afshar, Sarvin Eshaghi Balaban, and Ö., & Naga. 2022. "GIS-Based Educational Game through Low-Cost Virtual Tour Experience." *27th International Conference of the Association for Computer-Aided Architectural Design Research in Asia: Post Carbon, CAADRIA*. 69-78.
- Wilson, Alexander. 2019. *Technology-enabled planning participation: Designing & deploying digital technology to encourage citizen participation in urban planning*.
- Zhang, Shanqi. 2019. "Public participation in the Geoweb era: Defining a typology for geoparticipation in local governments." *Cities* 38-50.

Forced Migration and Housing Design in Receiver Communities

Forough Foroutan Jahromi¹, Jeffrey Carney¹

¹University of Florida, Gainesville, FL

ABSTRACT: The increasing number of people who are forcibly migrating from their place of dwelling due to different factors such as climate change, war, and political, and religious persecution has recently risen the attention to the subject of migration and resettlement. Migration of people who are displaced against their will, either internally or internationally, induced by any sort of reason can pose challenges of identity discontinuity, cultural dilution, poverty and social degradation, discrimination, difficulties in religious and cultural practice, and communal integration for the people who are being relocated, as well as community disintegration for the host community that is accepting newcomers. It also causes disruption in the migrant's everyday dwelling.

Many efforts to address these problems and revive the production of identity begin with migrant housing. Migrant housing is an existential and cultural production which is influenced by everyday dwelling as an evolving development of migrant housing. Migrants face their continued journey upon arrival by contributing to their housing through modification, addition, extension, and even construction of new house forms to create a house with symbolic materiality, creative expression, and a point of connection in the new context. Immigrants' homes can be an effective medium for preserving local customs and rituals, as well as a sense of cultural belonging for the migrant. It will also help to build powerful ties between new migrants and the rest of the population.

Migration and its various aspects including demographic, social, psychological, political, economic, and developmental characteristics have been studied by scholars. Despite the availability of rich material on migration, there is a lack of systematic reviews covering housing design for migrants. Therefore, the central objective of this study is to review existing efforts on the design of housing for migrants through different case studies of forced migration and their host community, to examine housing as the architectural construct of settlement in the processes of migration.

This study tries to answer the question of what role can architecture play in achieving an equitable outcome for forced migration, both at the scale of individual dwellings and large-scale buildings, and how migrants' everyday dwellings can help characterize their housing architecture? The aim of this study is to comprehend how to create a "place" for forcibly displaced individuals that ensures an equitable transition and provides a more enlightened perspective on housing design, with the goal of preventing intrusive interventions in their dwellings. The study is limited to the process of involuntary migration, which refers to resettling in a new community without previous awareness or connection to it. Physically, the study centers on the dwelling places including various typologies of housing in the host community.

The research reconceptualizes "place", as understood in housing and community design, to be inclusive of the perspective of displaced persons. With greater displacement than ever before, this research will offer insights into the design of housing and communities that can support the transitional needs of displaced people.

KEYWORDS: Forced Migration, Climate Migration, Housing, Dwelling, Receiver Community.

INTRODUCTION

The largest human displacement ever recorded in modern history has forced millions of people to flee their homes. An estimated 103 million individuals have been forcefully displaced from their homes by the end of June 2022 as a result of persecution, war, violence, violations of human rights, and incidents substantially disrupting public order. (UNHCR 2022). Natural disasters are one of the two primary factors, along with violent conflict, that drive huge populations to abandon their homes and migrate in search of safer settings (Domínguez-Amarillo et al. 2021). According to a report by Christian Aid ("Human Tide: The Real Migration Crisis" 2007) due to climate change, one billion people will be uprooted from their homes by 2050, either internally or across international boundaries.

While migrants may benefit the host community by contributing to its economic and social growth via market expansion, the importation of new talents, and the establishment of transitional linkages, (Alhusban, Alhusban, and Al-Betawi 2019), the receiver community can still face disintegration. Even though it's critical to comprehend the immigrant's motivation for moving, the distinction that matters most and has the biggest impact is the level of authority that each person has over migration, which determines whether forcible migration occurs or not. Migration of people who are forcibly relocated, either internally or internationally, for any reason can pose challenges of identity discontinuity, cultural dilution, poverty and social degradation, discrimination, difficulties in religious and cultural practice, and communal integration for the relocating population. The "new home" in the country of arrival is a foundation on which migrants might begin to establish a membership for their successful settling. (Romoli et al. 2022).

A significant number of scholars have focused on the subject of displacement and examined the phenomenon from psychological, social, cultural, and other perspectives (Brake 2019; Perdomo, Sánchez, and Blanco 2021; Siriwardhana

and Wickramage 2014). Elizabeth Brake in her article explores the issue from a political perspective and argues that equal opportunity justifies assistance in recovery, at least for disadvantaged citizens. Perdomo outlines the outcomes of an intervention program that employs community resilience as a reference framework, as well as the psychological, social, and subjective well-being of victims of forced relocation (Perdomo, Sánchez, and Blanco 2021). Sridarran (Sridarran, Keraminiyage, and Fernando 2018) has studied the host community acceptance and mentions some of the immediate effects of resettlements including a social breakdown and extreme deprivation, which impact not only the relocated population but also the host community. Anthropologists have also investigated how the entrance of a significant number of refugees or other displaced individuals affects the host community (Salem-Murdock 1989). Other effects of migration include labeling, identity management, border creation and maintenance, reciprocity management, myth manipulation, and social control (Colson 2003). However, when it comes to displaced groups, the body of knowledge around home-making processes is rather limited (Hadjiyanni 2009).

While some publications stress shelter as the essential requirement of refugees in the early phases of displacement (Aburamadan Rania 2022; Elnaschie et al. 2021), few delve into depth about the home and the identity challenges it may relieve or trigger in migrant adaptation (Alhusban, Alhusban, and Al-Betawi 2019; Hadjiyanni 2007; 2009; Levin 2012). As climate change causes more people to relocate from their homes, a key question for this study is: what kinds of design elements should be taken into account when creating new dwellings for climate refugees? The goal of this article is to critically examine research on the topic of migrants' homes and their design in shaping their identity in their country of arrival. The present systematic review used the PRISMA methodology to evaluate the literature concerning migrants' homemaking. Data were drawn from 47 studies. The authors looked through different ranges of shelters including refugee camps to housing and home due to the lack the sources. The article investigates forced migration, either directly or indirectly, and the destination of the migration is not restricted to a specific country or geographical place or ethnicity, or group of people.

The review demonstrates that, among the studies of the migration phenomenon, a comprehensive design guide for designers and architects to actively design and create a "home" for migrants as an essential step in establishing identity and a gateway to integrating into the receiving community is essential.

1.0 METHODOLOGY

A systematic literature review can verify a hypothesis, research question or a body of knowledge gap by giving a thorough summary of the scholarly evidence. The goal is to make a review that can be kept track of and used for future reference and growth (Brisotto and Carney 2022). The authors used Covidenve¹ as the platform to conduct the systematic review, following the PRISMA methodology (Moher et al. 2009), mapping key concepts that reflect home-making within a migratory context. On August 10, 2022, given that the idea of "home" was investigated across a wide range of scientific fields, we examined published literature from eleven databases². We used all publications and studies in English from 2000 that were peer-reviewed, as well as conference proceedings, whether quantitative only, qualitative only or of a mixed-method design. We sought to obtain as many studies as possible.

We defined the search keywords based on the area we wanted to include. Thus, our final search strategy through the databases was: ("House" OR "Housing" OR "home" OR "Dwelling" OR "place" OR "Habitus") AND ("Architect*" OR "building design" OR "architectural design" OR "interior design" OR "design" OR "place making") AND ("Migrat*" OR "Migrant" OR "refugee" OR "Emigrant" OR "emigrat*" OR "immigra*" OR "resettl*" OR "relocate*" OR "Climate migra*" OR "climate refugee" OR "environmental refugee" OR "environmental migra*") AND ("Sense of place" OR "belonging" OR "Identity" OR "Resilien*" OR "Equit*").

The results went under review three times: (1) review of the titles, (2) review of the abstract, and (3) review of the full text (See figure 1). The latter was included in the narrative of this paper. The authors also excluded studies that were investigating place-making only on an urban scale as were less aligned with the goals of this paper. Finally, the authors disregarded studies that concentrated on psychological factors, social aspects of migration, or any other publications unrelated to housing.

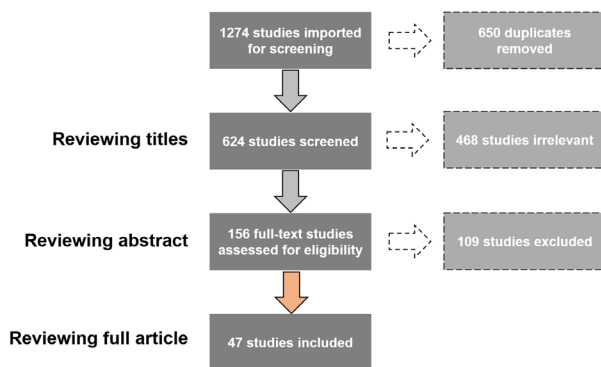

Figure 1: Selection process for reviewing articles. Source: (Authors 2022)

1274 references were imported for screening, then 650 duplicates were removed. 624 studies screened against title and abstract and 468 studies were excluded. Next, 156 studies were assessed for full-text eligibility, and 109 studies were excluded based on the exclusion criteria (See figure 1 and table 1). 47 studies were ultimately extracted.

Table 1: Exclusion criteria. Source: (Authors 2022)

The number of references excluded	Exclusion criteria
39	Not related to housing
28	Urban scale
18	Social aspect
12	Not migration
7	Religious spaces
5	Psychological aspect

2.0 FINDINGS

The writers compiled and classified the review's results according to the different kinds of architectural practices and the tactics either recommended in the references or applied by migrants via case studies (See table 2).

Table 2: Review findings categorized based on the architectural practices recommended. Source: (Authors 2022)

Architectural Practice Type Based on the Building	Identified Strategy	Modification Motivations
Exterior	<ul style="list-style-type: none"> - Reluctance to express oneself via outside design (Hadjiyanni 2009; Willems, De Smet, and Heylighen 2020) vs the desire to differentiate through exterior design - (Alhusban, Alhusban, and Al-Betawi 2019). - Closed curtain as an expression of difference visible from outside (Hadjiyanni 2009) - Visual access and control over the outdoor area (Speller and Twigger-Ross 2009) - Visual connection to a recognizable scene (Daniels and Steinberg 2006). - Availability of familiar plants species in the landscape (Traganou 2011) 	<ul style="list-style-type: none"> - Being Uncomfortable with Publicly Expressing Difference (Hadjiyanni 2009). - The exterior of the home is seen as the primary factor of the home differences (Datta 2008). - The desire to engender meaning through the exterior view (Hadjiyanni 2009). - An interior practice rooted in the feeling of privacy. - It brings a level of control over the living place and creates a sense of safety and community engagement at the same time (Speller and Twigger-Ross 2009). - Provides a psychological link to the previous familiar dwelling (Daniels and Steinberg 2006). - Helps the feeling of being at home for the migrants (Traganou 2011).
Interior	<ul style="list-style-type: none"> - "A large, continuous wall surface" (Hadjiyanni 2009). - Wall color change (Hadjiyanni 2009) - Decoration Including window's curtains, area rugs, furniture, flag, paintings, decorative objects, ... - Front room decoration matters (Horst 2011). 	<ul style="list-style-type: none"> - Ability to showcase sacred possessions to maintain tradition (Hadjiyanni 2009). - Cultural reference (in case of home ownership) (Hadjiyanni 2009) - Provide meaning and value to living and socializing areas (Hadjiyanni 2009). - Personalize the home (Hadjiyanni 2009) - Cultural expression (Hadjiyanni 2009) - Religious expression (Hadjiyanni 2009) - Enabling migrants to reconstruct their identity (Horst 2011). - Display Respectability (Horst 2011)
Spatial	<ul style="list-style-type: none"> - The kitchen is to be located in a well-ventilated cooking area - Larger size kitchen to fit multiple cooks (Hadjiyanni 2009; Soikkeli 2019). - Properly connected to the rest of the home (Sabie, Sabie, and Ahmed 2020). - An open-air courtyard to be surrounded by the rooms (Sabie, Sabie, and Ahmed 2020). - Larger living area (Hadjiyanni 2009) - Spaces with functional design and adaptable 	<ul style="list-style-type: none"> - Food and cooking as a cultural indicator - Offers privacy as you can be outside but away from strangers' eyes (Sabie, Sabie, and Ahmed 2020). - The home needs to shelter everyone including kids, and the living area should cover all the needs and activities (Hadjiyanni 2009; Rodrigues et al. 2015; Sabie, Sabie, and Ahmed 2020). - Accommodate cultural and religious practices (Elnaschie et

	structure (Kurniawan, Suhanto, and Angelia 2020; Sabie, Sabie, and Ahmed 2020).	al. 2021; Kurniawan, Suhanto, and Angelia 2020)
	- The separation between the public and private areas of the house (Sabie, Sabie, and Ahmed 2020).	- Acquiring privacy, - Religious considerations
	- Importance of the front room	- As a space to communicate and cultivate the sense of having "arrived," literally and figuratively (Horst 2011).
	- Desire to use outdoor space vs reluctance to use and preference to have more functional interior spaces.	- Cultural considerations that contains more indoor activities (Lung-Amam 2013)
Material	- The importance of front room choice of material (Horst 2011).	- Displays respectability (Horst 2011).
	- Reproduction of portable elements of material culture and leaving the non-portable elements out (Paz 2009).	- Portability and doability of alternations.
	- Material object creation	- In the memory of the place of origin and symbol of the shared experience of displacement (Paz 2009).
	- The easiness of cleaning in the choice of material (Hadjiyanni 2009).	- Religious practice
	- Material cost	- Cheaper materials can offer affordable houses for refugee inflow. (Alhusban, Alhusban, and Al-Betawi 2019; Romoli et al. 2022).
Form	- The desire for "un-cubism" forms with multiple edges (Sabie, Sabie, and Ahmed 2020).	- The form can remove dullness and add uniqueness to the façade (Sabie, Sabie, and Ahmed 2020).
	- Change in the opening size	- Climate- and vernacular-influenced architectural forms in the home community (Allis, Fitra, and Suryani Sri 2021).
Typology	- Demand for apartments vs single-family homes (Alhusban, Alhusban, and Al-Betawi 2019), or no major change to the type.	- Housing cost, - Local housing policy.
	- Various housing unit types	- To meet the needs for all individuals (Rockwood and Tran 2016).
Structure	- Use of conventional building materials	- The sense of security
	- Change in the construction methods	

3.0 DISCUSSION

When fleeing persecution, war, or natural disaster, refugees experience a range of losses in search of safety. Among the losses are their homes, which formerly supported their family structure, social standing, culture, rituals, religion, and sense of self — in a word, their identity (Hadjiyanni 2007). It would be impossible to rebuild a previously extinct architectural style in their host country due to the interconnected nature of architecture with other factors such as the natural environment, the technological state of the world, the political climate, and cultural and social norms (Altman and Chemers 1980). Similarly, the minimal money allocated to refugee rehousing initiatives is often attached to substandard temporary housing (Miyares 1997). In consequence, refugees find themselves living in residences that bear little (if any) resemblance to either the homes they were forced to leave or the accepted housing norms of the host community (Hadjiyanni 2007) which causes "corrosion" of individual character" (Hoey 2010).

Where places may be both nourishing and challenging, it is a pivotal point in the formation of identity. (Hoey 2010; Shadar 2004; Speller and Twigger-Ross 2009). Place is understood as more than just a physical space. It is a place that has been altered by the daily routines and emotions of its inhabitants. When space feels thoroughly familiar it has become place. In this context, "place" refers to more than just its physical location. Space becomes a place when it becomes embedded in a person's daily life and becomes a source of comfort and familiarity (Moores and Metykova 2010). As Sabie mentions "place as a container of experiences (Sabie, Sabie, and Ahmed 2020) and culturally meaningful (Hoey 2010). Antoniak (Antoniak 2020) notes that place combines elements of nature, social relations, and meaning (Blackwell, Rosa, and Aranda 2021). Place identity is a component of self-identity made up of concepts of behavior and experience that take place in particular places as well as memories, emotions, ideas, meanings, attitudes, sentiments, and preferences (Mazumdar, Docuyanan, and McLaughlin 2000; Nasr and Soghman 2019). "There is no self without place; sociality is always emplaced and embodied." (Ivanova 2022)

People use meanings that they attribute to places to define themselves, and they interpret themselves through place attachment (Alhusban, Alhusban, and Al-Betawi 2019; Blackwell, Rosa, and Aranda 2021). So, being aware of place can mean also being aware of aspects of one's identity (Blackwell, Rosa, and Aranda 2021). Restoring a feeling of place and reliving previous experiences in the present is a driving force behind the transformation of "home" to represent cultural identities in the setting of transnational communities. By allowing the maker to express something about themselves and their life via the things they build, this "homemaking" process naturally arouses memories of people, relationships, places, events, and activities, bringing them closer to their "self" (Sabie, Sabie, and Ahmed 2020). The term "home" has been defined by a wide range of academics. from a phenomenological perspective, "home" can be described as a multi-layered container of feelings including orientation, security, comfort, order, privacy, intimacy, identity and belonging (Cassiman 2008; Cruz and Buchanan-Oliver 2020; Mazumdar, Docuyanan, and McLaughlin 2000; Romoli et al. 2022). In the context of migration, while "home" is considered as a "process", not simply a "product"

(Aburamadan Rania 2022; Ratenesh Anand Sharma and Murphy 2015), Blackwell lists five notions of home among migrants: family, identification, pleasure, community, and plausibility (Blackwell, Rosa, and Aranda 2021). He notes that the house is a dynamic space that governs social life actively. Home is not only a container for possessions; it is also a place where activities take place and an environment that influences essential parts of our daily life (Blackwell, Rosa, and Aranda 2021). Home-making is an ongoing task that is inherently intertwined with behaviors (Cassiman 2008; Hadjiyanni 2009; Willems, De Smet, and Heylighen 2020) and considers as a way to express migrants' community identity (Alhusban, Alhusban, and Al-Betawi 2019). Home holds relationships, especially with family, and for migrants "home" refers to "being with family" (Curtin et al. 2017; Nasr and Soghman 2019).

Mobile individuals are considered uprooted since they have no ties to a certain place and their "identities are deterritorialized" (Nowicka 2007). As a result of mobility and movement, the concept of a permanent location as a place to call "home" is challenged.

Supporting the desired lifestyle via the built environment may promote well-being, but a disparity between the two can cause stress (Willems, De Smet, and Heylighen 2020). Architects incorporate values and attitudes into their designs (Willems, De Smet, and Heylighen 2020). In the context of migration, architecture becomes an instrument or an agent of communication that helps create a sense of place or community." (Mazumdar, Docuayan, and McLaughlin 2000)

3.1. Migrant Housing Adaptations

Migrants are not passive recipients of culturally inappropriate efforts by "others", as constructors and agencies in the host community, therefore they can modify conventional perceptions of what defines suitable housing to better meet their own cultural and economic circumstances, even if resources are limited. (Jennifer Erica Duyn Barenstein 2015; Sabie, Sabie, and Ahmed 2020). Correspondingly, the "new home" in the nation of arrival has the potential to serve as a foundation upon which migrants might begin to construct a membership for their successful settling (Romoli et al. 2022). This literature review article identifies seven realms of modifications, based on the building component, within the refugees' housing.

3.1.1. Exterior Components

The outside of the migrants' house is the primary component that shares the sense of difference (Datta 2008) and communicates the connections between the house, the neighborhood, and the built environment. In the case of Syrian refugees in Al-Mafragh, refugees carry their previous knowledge and experience and recreate their exterior to engender meaning through exterior view, which may lead to a chaotic architectural characteristic in the receiver community's fabric (Alhusban, Alhusban, and Al-Betawi 2019). While in the case of Somali refugees in Minnesota, concerns about "standing out" prevented refugees from visually expressing their sense of difference on the exterior as publicly visible parts of their home (Hadjiyanni 2009). Visual access, on the other hand, offers a measure of control over one's living place, leading to a sense of safety and privacy (Speller and Twigger-Ross 2009) while creating a recognized scene for the migrants, such as familiar landscaping and plant species, also offers a visual link to the experience of being at home (Daniels and Steinberg 2006; Traganou 2011).

3.1.2. Interior Components

Decorations displayed throughout the home, from shelves to walls and built-ins, serve a vital role in anchoring migrant culture and adding significance (Hadjiyanni 2009). Decorative objects assist migrants in personalizing their "homes" (Horst 2011) and are seen as cultural and religious expressions that allow them to recreate themselves. Beliefs and traditions may influence the amount of significance of ornamental artifacts, giving them significance. The Hmong, for instance, believe that things hold guardian spirits that protect the family's well-being. In this case, Hadjiyanni mentions that finding proper placement for locating these decorative objects is important and offers that providing a large, continuous wall surface gives the ability to showcase sacred possessions like collections of photographs. Horst also emphasizes front room decorations and mentions that it may "display respectability" at their material level and their level of signification (Horst 2011). In the case of house ownership, wall color, and texture may be regarded as a choice that is not only a question of personal taste but also evokes memories and nourishes the home's character (Hadjiyanni 2009).

3.1.3. Spatial Aspect

The objective of the process of homemaking is to preserve the migrants' everyday life. Probably the most important aspect of housing design for migrants' resilience is the housing's spatial layout and circulation. Spatial characteristics restrict and enable various behavior patterns, emphasizing the critical role of the physical environment and demonstrating the fundamentally dynamic link between person, group, and place (Speller and Twigger-Ross 2009). In the context of migration, the majority of cases demonstrate that in the early stages, although the housing size is smaller than the original, the "home" must still accommodate everyone (Hadjiyanni 2009; Rodrigues et al. 2015). Hadjiyanni mentions the importance of providing a spacious living area that can accommodate a variety of household activities and needs (Hadjiyanni 2009). By offering a gathering place with language connections, the living space plays a vital role in passing on culture to the children. However, Sabie notes that the multifunctionality of the space contributed to a sense of temporary residence. (Sabie, Sabie, and Ahmed 2020). Kurniawan (Kurniawan, Suhanto, and Angelia 2020) asserts that it is vital to construct functionally and physically flexible environments that can accommodate migrants' cultural and religious practices.

The emphasis on the kitchen layout is evident among all the elements of the house (Sabie, Sabie, and Ahmed 2020; Soikkeli 2019). In the case of Somali refugees in Minnesota, although the aroma of food cooking is enjoyable and

reminds them of being at home”, mediating the smell by providing a separated and well-ventilated cooking area or even supplying an external kitchen was preferred (Hadjiyanni 2009; Jennifer Erica Duyne Barenstein 2015). While in modern housing design the open plan is ideal, providing this feature is critical for migrant housing. Furthermore, based on the cultural background of the migrant in some cases, cooking was a collective activity that need a larger area to support multiple cooks (Sabie, Sabie, and Ahmed 2020).

The desired spatial design is not always parallel with the host environmental architectural requirements. In the case of Mexican refugees in Minnesota, studied by Hadjiyanni, a typical courtyard-type housing was preferred by the migrants where all the rooms are arranged around an open-air courtyard. While it is uncommon in Minnesota, where winter is rigid and long, the desire was translated into an interior courtyard through a painted sky on the ceiling. In Lung-Amam's research on Chinese immigrants to the United States, the extent of outdoor space was a point of contention between locals and immigrants. While the local population utilizes outside space, migrants want a house with a playroom, piano room, and guest room (Lung-Amam 2013). Refugees also value privacy. Providing a physical separation between the house's public and private spaces not only addresses the need for privacy, but also facilitates religious activity (Sabie, Sabie, and Ahmed 2020).

3.1.4. Material

Migrants are restricted in their ability to choose and replicate particular portable elements of culture, whereas non-portable architectural features will be excluded (Paz 2009). Therefore, many of the features characterizing houses in their places of origin are not found in their new place. The choice of material is closely intertwined with aesthetics, perceptions of safety, cultural manifestation, and religious practice (Hadjiyanni 2009; Paz 2009). For floor finishes Somali migrants' material preference was typically tied to cleanliness and preferred wood floors (Hadjiyanni 2009). In the context of migration, it is important to consider responding to the increasing demand for reasonable price housing units which most of the time leads to low-quality material and at the same time more affordable housing (Alhusban, Alhusban, and Al-Betawi 2019). On the other hand, it may involve decreasing the sense of belonging to the “home” and security within the dwellings for the migrants due to the lower quality (Romoli et al. 2022).

3.1.5. Form

The receiver community's capacity in providing a proper context for the migrants to shape their identity through their dwelling style is different based on the literature. In the case of Syrian refugees in Lebanon, the Syrian refugees were able _allowed_ to compose new forms unlike the conventional style of residential buildings. Although the reason behind this transformation is partially rooted in the rigidity and poorness of the migrants as the two main characteristics identified, the lack of homogeneity and balance in both shape and proportions of the huge masses created, was evident. The effort to make a difference through form was visible in the façade design, building size, and the recognizable decrease in the use of decoration elements as well (Alhusban, Alhusban, and Al-Betawi 2019). Alhusban mentions “The sizes of residential buildings were larger in height and layout in comparison to the original residential buildings.” The same modifications were observed in the case of Israeli refugees flooding from various parts of the world creating a united nation. The building form is also influenced by culture as Willems mentions in her article that an “un-cubism” form with multiple edges was preferred among the migrants (Willems, De Smet, and Heylighen 2020).

3.1.6. Typology

The housing typology has the greatest impact on housing costs, allowing migrants to change their ownership status, which may have a significant impact on their capacity to adapt their houses to their requirements. Alhusban asserts that an increase in demand for apartment typology in comparison to single detached housing, among the refugees is visible (Alhusban, Alhusban, and Al-Betawi 2019). However, it's necessary to offer a variety of housing types to meet the demands of any conceivable family. Changing the housing typology in a way that works for migrants depends in large part on the capacity of the receiving community. In certain instances, as Alhusban mentions, migrants' new home type was coerced into conforming to the preexisting built environment (Alhusban, Alhusban, and Al-Betawi 2019).

3.1.7. Structure

In the adaptation process structure might be seen as the last component that migrants examine. The research indicates that structural elements create a feeling of safety. According to Shadar, in the case of Israeli migrants, who were all migrating from various parts of the world, including Europe, the use of stone, which was the local building material in their previous home, was preferred over wood, which was prevalent in the new geographical area to which they relocated (Shadar 2004). The literature demonstrates that a migrant's home-making process was not only dependent on the aesthetics and architectural style of their dwelling. Datta argues, using the instance of Polish migrants in London as an example, that articulation of how houses are constructed in specific geographic and national settings is a method to establish the distinctions, while having consequences for a subjective experience of residence (Datta 2008).

4.0 LIMITATIONS

The ability of the migrants to personalize their homes based on their everyday living routine and shape their cultural identity is constrained through religious beliefs, regulations, income limits, construction norms, and market restrictions, and the availability of decorative objects to purchase. All these factors suppress their attempts to create a preferred aesthetic and threaten in the process the group's cultural identity definition. (Hadjiyanni 2009).

Professionals in the field of planning and design as well as the procedures and rules that govern the industry may have a disproportionate influence on migrants and refugees as minorities by erasing their values, meanings, and wishes for their houses and communities (Lung-Amam 2013). Migrants must take into account the impact of receiving community regulation on dwelling size, external design, and housing typology.

One of the most significant constraints is undoubtedly the fact of ownership. Property ownership evokes symbolic meaning and creates a sense of belonging to the place as well as conveys a sense of independence (Horst 2011; Ratenesh Anand Sharma and Murphy 2015; Sinatti 2009). Ownership allows individuals to be rooted in place with strength and permanence. Homeownership is a representation of accomplishment and success, as well as a place of "emotional, cultural, and social" belonging (Horst 2011). Homeowners view their homes as a financial investment rather than just as a place to live (Ratenesh Anand Sharma and Murphy 2015; Sinatti 2009). For migrants, owning a property widens their possibilities for any form of modification, while this is restricted for renters, and gives them a psychological lift from being able to develop and modify their living environment as they see appropriate.

CONCLUSION

The results of this systematic literature demonstrate how housing changes contribute to the development of immigrant identities and enhance community resilience by better enabling immigrant integration into the receiver community. Migration entails an uprooting of the meaning system (Falicov 2015) and "home" is one of the first environments in which migrants recreate meaning and deal with loss via action. When people leave their homeland, their houses take on new significance as containers for the "meanings" they want to convey.

The motivations for migrants' housing preferences and their seemingly endless alternation process span counteracting negative previous housing experiences, enhancing positive future housing prospects and assimilating into the host community (Alhusban, Alhusban, and Al-Betawi 2019). The interaction of cultural rituals, social factors, and religious considerations with architectural practices promotes the re-establishment of migrants' "homes." Furthermore, the relevance of ownership status plays a role in the process of homemaking. It is around the home that migrants construct and experience their identities and relationships, making it a site rich with potential symbolic value.

This systematic literature review laid the groundwork for more extensive studies of the concept of "home" among migratory communities. Actions to promote migrants' well-being in the receiver community may benefit from a better knowledge of the home-making process by which they create their identity. This study demonstrates that few studies have explored the influence of new residential architecture on the adaptation process of refugee groups and their effort to define a new identity. The study also emphasizes the need for a comprehensive study on how to design for refugees and what the toolkits in the process of place-making for the specific user of refugee as someone who not only has gone through traumatic situations but also might be a stranger to the new context of social and cultural. To fully comprehend the significant aspects that are crucial throughout the home-making process, further research into the motivations behind the house adjustments is required.

REFERENCES

- Aburamadan Rania. 2022. "Refugee-Led Socio-Spatial Organization in Al Baqa'a Camp, Jordan." *City, Territory and Architecture* 9 (1). <https://doi.org/10.1186/s40410-021-00145-y>.
- Alhusban, Ahmad A, Safa A Alhusban, and Yamen N Al-Betawi. 2019. "Assessing the Impact of Urban Syrian Refugees on the Urban Fabric of Al Mafraq City Architecturally and Socially." *International Journal of Disaster Resilience in the Built Environment* 10 (2/3): 99–129. <https://doi.org/10.1108/IJDRBE-09-2018-0039>.
- Allis, Nurdini, Hadio Nur Fitra, and Suryani Sri. 2021. "Emerging Housing Choices for Community Resilience Capacity in Flood-Prone Areas of Bandung Regency, Indonesia." *Journal of Housing and the Built Environment* 36 (4): 1563–83. <https://doi.org/10.1007/s10901-020-09809-6>.
- Altman, Irwin, and Martin M. Chemers. 1980. *Culture and Environment*. Brooks/Cole Basic Concepts in Environment and Behavior Series. Monterey, Calif.: Brooks/Cole Pub. Co.
- Antoniak, Joanna. 2020. "TAKING ROOT IN FLOATING CITIES – SPACE, ENVIRONMENT, AND IMMIGRANT IDENTITY IN KERRI SAKAMOTO'S FLOATING CITY." *Studia Anglica Posnaniensia* 55: 445–64. <https://doi.org/10.2478/stap-2020-0022>.
- Blackwell, Rebecca, Alessandra Rosa, and Elizabeth Aranda. 2021. "¿Nuestro Nuevo Hogar? [Our New Home?]: Examining Puerto Rican Migration and Conceptions of Home, Place-Making, and Belonging." *Women, Gender, and Families of Color* 9 (2): 208-229,245.
- Brake, Elizabeth. 2019. "Rebuilding after Disaster: Inequality and the Political Importance of Place." *Social Theory and Practice* 45 (2): 179–204.
- Brisotto, Carla, and Jeffrey Carney. 2022. "Co-Design Strategies to Achieve Trust in Urban Living Lab: A Systematic Literature Review." In ARCC. http://www.arcc-arch.org/wp-content/uploads/2022/09/ARCC-EAAE-2022_Proceedings_Digital-Version.pdf.
- Cassiman, A. 2008. "Home and Away: Mental Geographies of Young Migrant Workers and Their Belonging to the Family House in Northern Ghana." *Housing, Theory and Society* 25 (1): 14–30. <https://doi.org/10.1080/14036090601151210>.
- Colson, Elizabeth. 2003. "Forced Migration and the Anthropological Response." *Journal of Refugee Studies* 16 (1): 1–18. <https://doi.org/10.1093/jrs/16.1.1>.
- Cruz, Angela Gracia B, and Margo Buchanan-Oliver. 2020. "Home Culture Consumption as Ambivalent Embodied Experience." *European Journal of Marketing* 54 (6): 1325–53. <https://doi.org/10.1108/EJM-02-2018-0081>.

- Curtin, Alicia, Diane C Martins, Catharina Gillsjo, and Donna Schwartz-Barcott. 2017. "Ageing out of Place: The Meaning of Home among Hispanic Older Persons Living in the United States." *International Journal of Older People Nursing* 12 (3). <https://doi.org/10.1111/opn.12150>.
- Daniels, T.L., and H. Steinberg. 2006. "Lessons from Sri Lanka." In *Rebuilding Urban Places After Disaster: Lessons from Hurricane Katrina*, 244–55. <https://www.scopus.com/inward/record.uri?eid=2-s2.0-84903670207&partnerID=40&md5=ccd60a7035cf9911ec228704e54e1ce7>.
- Datta, Ayona. 2008. "Building Differences: Material Geographies of Home(s) among Polish Builders in London." *Transactions of the Institute of British Geographers* 33 (4): 518–31.
- Domínguez-Amarillo, S., Á. Rosa-García, J. Fernández-Agüera, and N. Escobar-Castrillón. 2021. "Architecture of the Scope: Thermal Assessment of Refugee Shelter Design in the Extremes Climates of Jordan, Afghanistan and South Sudan." *Journal of Building Engineering* 42. <https://doi.org/10.1016/j.jobe.2021.102396>.
- Elnaschie, Shareen, Febe Viaene, Yana De Reu, Rani De Becker, and Angeliki Paidakaki. 2021. "How Can Community Architects Build Socially Resilient Refugee Camps? Lessons from the Office of Displaced Designers in Lesvos, Greece." *ArchNet - IJAR: International Journal of Architectural Research* 15 (3): 800–822.
- Falicov, Celia Jaes. 2015. "The Multiculturalism and Diversity of Families." In *Handbook of Family Therapy*. Routledge.
- Hadjiyanni, Tasoulla. 2007. "Bounded Choices: Somali Women Constructing Difference in Minnesota Housing." *Journal of Interior Design* 32 (2): 13–27.
- . 2009. "Aesthetics in Displacement -- Hmong, Somali and Mexican Home-Making Practices in Minnesota." *International Journal of Consumer Studies* 33 (5): 541–49. <https://doi.org/10.1111/j.1470-6431.2009.00806.x>.
- Hoey, B.A. 2010. "Place for Personhood: Individual and Local Character in Lifestyle Migration." *City and Society* 22 (2): 237–61. <https://doi.org/10.1111/j.1548-744X.2010.01041.x>.
- Horst, Heather A. 2011. "Reclaiming Place: The Architecture of Home, Family and Migration." *Anthropologica* 53 (1): 29–39.
- "Human Tide: The Real Migration Crisis." 2007. Christian Aid. <https://reliefweb.int/report/colombia/human-tide-real-migration-crisis-christian-aid-report>.
- Ivanova, Dara. 2022. "(Un)Folding Places with Care: Migrant Caregivers 'Dwelling-in-Folds.'" *Global Networks* 22 (2): 211–25. <https://doi.org/10.1111/glob.12340>.
- Jennifer Erica Duyne Barenstein. 2015. "Continuity and Change in Housing and Settlement Patterns in Post-Earthquake Gujarat, India." *International Journal of Disaster Resilience in the Built Environment* 6 (2): 140–55. <https://doi.org/10.1108/IJDRBE-01-2014-0009>.
- Kurniawan, K.R., K.A.G. Suhanto, and D.P. Angelia. 2020. "From Boluf to Kampung: Spatial Changes in The Korowai Traditional Settlements." *ISVS E-Journal* 7 (1): 12–20.
- Levin, Iris. 2012. "Chinese Migrants in Melbourne and Their House Choices." *Australian Geographer* 43 (3): 303–20.
- Lung-Amam, Willow. 2013. "That 'monster House' Is My Home: The Social and Cultural Politics of Design Reviews and Regulations." *Journal of Urban Design* 18 (2): 220–41. <https://doi.org/10.1080/13574809.2013.772880>.
- Mazumdar, S, F Docuyan, and C M McLaughlin. 2000. "Creating a Sense of Place: The Vietnamese-Americans and Little Saigon." *Journal of Environmental Psychology* 20 (4): 319–33.
- Miyares, Ines M. 1997. "Changing Perceptions of Space and Place as Measures of Hmong Acculturation." *The Professional Geographer* 49 (2): 214–24. <https://doi.org/10.1111/0033-0124.00071>.
- Moher, David, Alessandro Liberati, Jennifer Tetzlaff, Douglas G. Altman, and The PRISMA Group. 2009. "Preferred Reporting Items for Systematic Reviews and Meta-Analyses: The PRISMA Statement." *PLOS Medicine* 6 (7): e1000097. <https://doi.org/10.1371/journal.pmed.1000097>.
- Moores, S., and M. Metykova. 2010. "'I Didn't Realize How Attached i Am': On the Environmental Experiences of Trans-European Migrants." *European Journal of Cultural Studies* 13 (2): 171–89. <https://doi.org/10.1177/1367549409352278>.
- Nasr, Noel, and Jacqueline Soghman. 2019. "The Deeper Significance of Living Design in Syrian Refugee Camps in Lebanon." *International Journal of Design in Society* 13 (3): 31–44.
- Nowicka, Magdalena. 2007. "Mobile Locations: Construction of Home in a Group of Mobile Transnational Professionals." *Global Networks* 7 (1): 69–86. <https://doi.org/10.1111/j.1471-0374.2006.00157.x>.
- Paz, S. 2009. "A Home Away from Home? The Settlement of Early Transcaucasian Migrants at Tel Bet Yerxsah." *Tel Aviv* 36 (2): 196–217. <https://doi.org/10.1179/033443509x12506723940721>.
- Perdomo, Mónica, Flor Sánchez, and Amalio Blanco. 2021. "Effects of a Community Resilience Intervention Program on Victims of Forced Displacement: A Case Study." *Journal of Community Psychology* 49 (6): 1630–47. <https://doi.org/10.1002/jcop.22499>.
- Ratenesh Anand Sharma, and Laurence Murphy. 2015. "The Housing Experiences of Fijian Migrants in Auckland." *International Journal of Housing Markets and Analysis* 8 (3): 396–411. <https://doi.org/10.1108/IJHMA-11-2014-0046>.
- Rockwood, D., and D.Q. Tran. 2016. "Urban Immigrant Worker Housing Research and Design for Da Nang, Viet Nam." *Sustainable Cities and Society* 26: 108–18. <https://doi.org/10.1016/j.scs.2016.06.008>.
- Rodrigues, Priscila Raffi, Rafaella Gatis Galvao, Nara Almeida, Eliana Cristina Barreto Monteiro, and Priscilla Elisa de Azevedo Basto. 2015. "Post Occupancy Evaluation of Popular Housing Estate of Cordeiro in Recife (Pernambuco, Brazil)." *Electronic Journal of Geotechnical Engineering* 20 (23): 12449–58.
- Romoli, Vittoria, Paola Cardinali, Joseph R Ferrari, and Laura Migliorini. 2022. "Migrant Perceptions of Psychological Home: A Scoping Review." *International Journal of Intercultural Relations: IJIR* 86: 14. <https://doi.org/10.1016/j.ijintrel.2021.10.009>.

- Sabie, D., S. Sabie, and S.I. Ahmed. 2020. "Memory through Design: Supporting Cultural Identity for Immigrants through a Paper-Based Home Drafting Tool." In . <https://doi.org/10.1145/3313831.3376636>.
- Salem-Murdock, Muneera. 1989. *Arabs and Nubians in New Halfa: A Study of Settlement and Irrigation*. Salt Lake City: University of Utah Press.
- Shadar, H. 2004. "Between East and West: Immigrants, Critical Regionalism and Public Housing." *Journal of Architecture* 9 (1): 23–48. <https://doi.org/10.1080/1360236042000197862>.
- Sinatti, G. 2009. "Home Is Where the Heart Abides Migration, Return and Housing in Dakar, Senegal." *Open House International* 34 (3): 49–56.
- Siriwardhana, Chesmal, and Kolitha Wickramage. 2014. "Conflict, Forced Displacement and Health in Sri Lanka: A Review of the Research Landscape." *Conflict and Health* 8 (1): 22. <https://doi.org/10.1186/1752-1505-8-22>.
- Soikkeli, Anu. 2019. "Finnish Planning and Housing Models Molding Skolt Culture in the 20th Century." *Arctic Anthropology* 56 (2): 84–99.
- Speller, Gerda M., and Clare L. Twigger-Ross. 2009. "CULTURAL AND SOCIAL DISCONNECTION IN THE CONTEXT OF A CHANGED PHYSICAL ENVIRONMENT." *Geografiska Annaler Series B: Human Geography* 91 (4): 355–69.
- Sridarran, Pournima, Kaushal Keraminiyage, and Nishara Fernando. 2018. "Acceptance to Be the Host of a Resettlement Programme: A Literature Review." *Procedia Engineering*, 7th International Conference on Building Resilience: Using scientific knowledge to inform policy and practice in disaster risk reduction, 212 (January): 962–69. <https://doi.org/10.1016/j.proeng.2018.01.124>.
- Traganou, Jilly. 2011. "Migratory Homes: Redesigning Group Identity, Prototyping Social Change." *Journal of New Frontiers in Spatial Concepts* 3: 43–55.
- UNHCR, The UN Refugee Agency. 2022. "HNUCR Mid-Year Trends." <https://www.unhcr.org/mid-year-trends.html>.
- Willems, Sara, Henk De Smet, and Ann Heylighen. 2020. "Seeking a Balance between Privacy and Connectedness in Housing for Refugees." *Journal of Housing and the Built Environment* 35 (1): 45–64. <https://doi.org/10.1007/s10901-020-09727-7>.

ENDNOTES

¹ Covidence is the principal instrument for screening and extracting data used by Cochrane authors performing standard intervention reviews. For your reference: <https://www.covidence.org/>

² Art & Architecture Source (30), Academic Search Premier (103), Scopus (539), Web of Science (179), ProQuest (387), Avery index to architectural periodicals (18), Taylor Francis Online (12), Psychology & Behavioral Sciences Collection (5), Psychology Collection (1).

From form to formless

Arief Setiawan¹

¹Kennesaw State University, Marietta, GA

ABSTRACT: The design of the built environment relates to the larger forces that shape and organize our world. In this line of thought, the economic forces informed our urban and suburban environment. They are characterized by buildings based on cheap, fast, standardized, mass-produced building materials and techniques. Indeed, while much of our daily lives have shifted from physical to online activities, built structures that accommodated physical needs are still very ubiquitous around us. They create a banal environment in which we live in. Recent works in architecture literature and theories have engaged such issues, for examples Rem Koolhaas' *Junkspace* and *Countryside (2002)*, or Stan Allen's *Field Condition*. This research builds upon a survey of the everyday built environment to develop a taxonomy of typology and morphology based on formal, spatial, techniques and materials, programmatic, and performative aspects. Further, it investigates the compositional or organizational strategy as well as inquires materials and method of constructions. Looking into the genealogy of this taxonomy forms a crucial part of this research. The aim of the research is to gear the understanding of these phenomena as sources for generative principles and ideas in architectural design. Further, these design approaches should problematize the relentless forces of the post-industrial society without being nostalgic or retro-oriented. The learning objectives of this research include: to link design and history, theory, and criticism; to raise critical questions about the qualities of everyday space; and to explore typology and morphology in architecture.

KEYWORDS: typology, morphology, generative principles, non-place

INTRODUCTION

In a world dominated by modern capitalist systems, this system plays fundamental roles in informing the built environment that we live in. In the United States, examples of these include the proliferations of suburban strip malls, large shopping malls, typical offices, and apartments buildings. These generic and banal space demonstrates features such as the relentless efficiency of the construction of space, low-cost materials, infinite flexibility of spatial configurations, unlimited range of scales, and multitude mutations and permutations. On the other hand, they also have characteristics including blandness, a limited lifespan, and neutrality. They form generic typology based on standardized, nondescript space, and banal construction methods. In short, these are banal space that characterized our built environment. They are an environment that is very familiar to us, yet, at the same time, we tend to be indifferent to them. We live in this setting and take them for granted as a background of our daily lives. With such acceptance, they escape our attentions. We consider them as everyday buildings, as opposed to high architecture. In this vein, this design research suspends this distinction between everyday building and architecture and aim to investigate their potentials to generate architectural designs. What if architects see these phenomena as sources for generative principles and ideas in architectural design, looking into their formal, spatial, tectonic, and programmatic configurations?

It continues the line of design explorations that engages everyday built environment. Robert Venturi and Denise Scott-Brown(1997) , for examples, concentrated on the formal aspects of everyday buildings in the country. They linked these formal dimensions with the notion of semiotics in architecture, in which everyday buildings serve as signs that communicate to the public. Similar approach also informed architects such as SITE. Rem Koolhaas looked at the spatial dimensions of everyday buildings and linked that with the development of materials, techniques of construction, and building systems commonly used in practice. In this vein, this design research approaches the everyday environment through the lens of typology and morphology. In short, it frames these built environments as a problem of form. Further, this project aims to investigate this problem of form through design experimentations. In this line of thought, Fraser (2014) defined architectural design research as experimentations through design activities.ⁱ This project engages creations of design artifacts, including diagrams, models, and drawings, as a means to analyze, synthesize, and speculate. It relates to the pedagogical goals of this inquiry. This inquiry takes a part of suburban Atlanta as its area of study. It assumes that this area represents a typical built environment in the country. Further, this area is the location of the school and most of our students come from and still live in this setting.

1.0 FRAMEWORK

1.1. Existing Literature

Studies of architecture that focuses on the proliferations of retail space in the built environment has a long history, in which this research referred to some of them. In American architecture, Robert Venturi and Denise Scott-Brown developed an influential body of work, starting from *Complexity and Contradiction in Architecture* and followed by *Learning from Las Vegas*.ⁱⁱ They argued that architects would benefit from turning their attentions from classical

European architecture and started to look up for sources of design from American popular built-environment. These studies called architects to look at ordinary built environment as the source of architectural design, instead of long-standing classical theories based on geometry, proportions, and order. In this vein, they particularly shone light on Las Vegas strips as the quintessential manifestations of popular buildings in America. In essence, they are built environment that existed for commercial activities. This attitude of learning from the modern, contemporary vernacular buildings echoed similar mid-century tendencies, such as in pop-art. Along this line of thought, Reyner Banham (2009) surveyed Los Angeles and identified varieties of architecture in the city.ⁱⁱⁱ Banham celebrated these contemporary vernaculars, instead of celebrating monumental and high-architecture in Los Angeles.

In recent time, Koolhaas has coined the term “junkspace” that encapsulated his fascination and observations of contemporary built environment, that continues the trajectory above.^{iv} In essence, the subjects of his observations and conceptualization are common structures that are accommodate and facilitate commercial activities. His definition and descriptions of this type of space basically embodies the primacy of the creation of a sealed space or a bubble.^v However, this bubble is a mutable one. Indeed, the mutability of this type is its most fascinating characteristics. It could expand indefinitely; it could adapt to endless programmatic requirements; it could project the nature of activity inside through clothing; it could adapt to varieties of topographic conditions; it could take on varieties of form; it could accommodate endless permutations of programs and forms. Indeed, Koolhaas noted that this type of space can only get bigger and bigger and not limited by scales.^{vi} It takes advantages of standardizations, mass-productions, and integrations of inventions in building elements, including escalator and HVAC systems.^{vii} This space creates a comfortable space facilitated by these infrastructures bounded within the seal. This seal, in turn, could take any shape and expression. Venturi and Scott-Brown (1997) framed their fascinations with the everyday built-environment through the semiotic lens, playing with meanings of architecture through playful investigations of visual elements derived from everyday buildings, such as strip malls. In contrast, Koolhaas explored the issue of the production of space, in which he tied the proliferations of the banal space to the development of materials and techniques of construction.

Koolhaas made a point that this space displayed characteristics that were the opposite of those are the virtues of modern architecture. It could be that this space is also the antithesis of the utopian dreams of modern architecture. In this line of thought, it resonated with heterotopia. Foucault (1997) pointed out that heterotopia is the opposite of utopia, and he discussed many definitions of this conception.^{viii} One of the characteristics of heterotopia is its capabilities to juxtapose different spaces that might not be compatible with each other. Commercial spaces, such as strip malls and shopping malls, demonstrated this phenomenon. Retailers could sit side-by-side with dining space or offices. Spaces that expressed different cultures and ethnicities share the same site. Spaces for automobiles coexisted with space for humans. In a way, these phenomena relate to another characteristics, that is, an alternative space. A business that sells cultural products created an imaginary realm of a space from other places in the world, a juxtaposition of local and global. Foucault pointed out that heterotopia tends to create illusions. These situations emerged out of fragments of different times and places. It is a situation in which particularities exist alongside repetitions, distinctness with banality. The study of the retail space revealed that space as a quintessential sample of the current built environment. In other word, this space is the space of the everyday. Along this line, Henri Lefebvre (1997) made his distinctions of lived space, conceived space, and perceived space.^{ix} The first refers to the environment in which we inhabit in days-in and days-out. It is the real space that surrounds us. The second term points to the built environment as designed and conceived by design professionals, including planners, engineers, and architects. The last notion describes space in terms of experiences that its inhabitants perceived and going through. In this line of thought, the proliferations of these types of space and structure that created our built environment that surround us serve as the setting for our lived and perceived space. These setting conditioned our habits in our daily life. However, Lefebvre also pointed out that architecture to building is similar to festival to daily life.^x This statement points to the potentials to develop design approaches from the everyday built environment. Indeed, the aim of the research is to gear the understanding of these phenomena as sources for generative principles and ideas in architectural design.

1.2. Methodology

I designed this research as a design-research studio in our institution, a five-year professional program. This studio is the last of the series of nine regular studios throughout our curriculum before students enroll in the thesis studio for their final semester. The intent of this design-research studio is to link design and history, theory, and criticism through design research. The methodology of this design research studio started from Fredric Jameson’s method (1981) that he elaborated in his essay “On Interpretation: Literature as a Socially Symbolic Act”.^{xi} His methodology followed deep analysis of three aspects, each is embedded within the other, forming concentric rings. The first circle is studies to describe the object of inquiry through formal analysis. “Formal” in this sense relates to “form” in philosophical terms, instead of literal “form.” The second circle inquires the local conditions in which the object of inquiry resides. It includes phenomena similar to the object of inquiry. It does not mean that the object of inquiry is a reflection of the context. Rather, this object demonstrates similar factors that operate in that milieu. The third circle explore the global network around the object of inquiry. For example, if the object of inquiry is a work of architecture, the second circle could include work of art, urban setting, and socio-cultural conditions.

In this line of thoughts, the descriptions the formal structure and characteristics forms the basis of the design research. Based on premises above, the structure of this design research follows a series of steps, which includes class activities, group works, and individual experimentations. The studio began with a survey of retail space around the campus which

was located in typical suburban areas. These include gas station, strip mall, big-box retail, and parking garages. The intent is to abstract the findings to generate an extensive catalogue of typologies and morphology of these buildings, based on form, space, construction systems, materials, and activities inside. In the following part, the studio asked students to research each category in two areas. First, it tasks students to investigate the compositional or organizational strategy. Second, it tasked students to research materials and method of constructions. To provide a framework for the inquiry, the studio provided a set of readings and this pairing intended to stimulate dialogues between textual and visual data. The last part of the studio will challenge students to engage in a series of speculative design experiments, exploring findings from the survey and analysis.

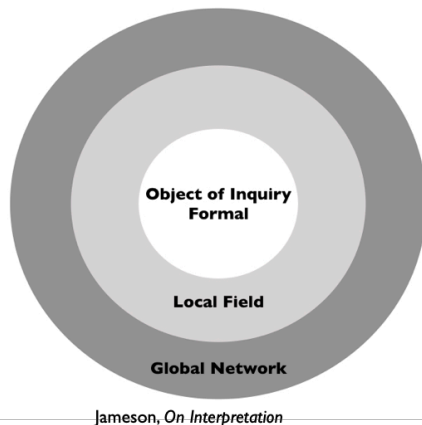

Figure 1: Diagrams of Jameson's methodology. Source: (Author 2022)

This methodology is a sequence that starts from the descriptions of form based on data collected from direct observations. The next sequence engages the textual data that informed the design of the built environment, such as legal, technical, and historical framework. The last sequence maps the inquiry within the contexts of the body of knowledge in architecture. In this vein, this inquiry locates the findings within the conception of form, morphology, and typology. This sequence of formal descriptions, textual background, and discursive maps serves as a translation from Jameson's model. It also allows for applications for further design research. In this line of thought, the rigor in describing formal features and structure provides a pivotal basis for the investigation. It requires the breadth of the data and depth of the descriptions. Establishing connections between these descriptions with the textual contexts and discursive map will allow to open up possibilities for design experimentations, beyond a collection of data and analysis.

2.0 DESIGN RESEARCH

2.1. Research Process

The design-research began with the studio gathering visual data from the survey and then categorize these data into different groups. The initial observations suggested that these commercial spaces are very flexible in terms of their uses, as the turnaround of tenants are common. Nevertheless, they retain consistent formal and spatial features. The overview of visual observations of the built environment yielded a set of categories, which include free-standing and aggregate buildings. Further, each of these categories was divided up based on scales into small, medium, and large. To describe their formal structure, the studio investigated and analyzed the basic properties of each category in formal, spatial, materials and structure, experiences, and contexts terms. In analyzing the first criterion, space and form, the analysis focused on identifying the basic formal components and then describing them in terms of geometry, scale, and proportions. These identifications lent into articulating the set of formal rules that govern these structures. The studio continued to inquire the descriptions of space of these structures to explore the spatial properties of each category and its spatiality. From the collected data, the inquiry considered the extent of space in those structures, along with their spatial definitions, based in some fundamentals in architectural design, including geometry, scales, proportions, and directionality. Then, the studio observed and analyzed materials and construction technics the were used in these structures. The next criterion shifted from tangible, physical, and measurable aspects to intangible dimensions of commercial space. It inquired the experiences and experiential qualities of these spaces, registering feelings and sensorial encounters with space. The last criterion studied the configurations of these spaces within the landscape of suburban America. This inquiry shifted the scales, from the scale of a building to the scale of neighborhood, and explored buildings, the site, and infrastructures. In each criterion, students experimented through a short design exercise to explore possibilities to generate design based on findings in each category.

The next sets of analyses shifted from direct observations of the built environment to data gathering and analyses of textual materials. This part of the research investigated the invisible hands that shape contemporary built environment, focusing on codes and regulations, standards, and historical development and evolution of these structures. It extracted particular aspects of those data that were relevant to the subject matter. The research then synthesized the findings from these analyses and relate them to relevant literature in architecture. It went through a series of comparisons and

contrasts, highlighting similarities and differences within each criterion and documented through a series of diagrams that highlight the thread and variations. It yielded into examining these findings within the framework of major discourses in architecture, particularly through the filters of architecture typology and morphology. The findings and understanding of this synthesis served as a basis for testing and experimentations in the form of a design exercise. The research stressed on developing design principles out of this process.

2.2. Findings

This process yielded a wide array of findings. In terms of formal, spatial, and materials and construction systems, the study translated data into diagrams, both two-dimensional in orthographic and three-dimensional in axonometric, sectional perspectives, and models. It also produced matrix that categorized and organized formal and spatial properties, including volumes, surfaces, parts/elements, graphics, colours, and configurations. In terms of experiences, the challenges laid in transforming data into intelligible information. The study produced composite drawings and explored possible media, including virtual reality to model experiences. With regards to contexts, the study went through series of mapping, including placement of a structure on its site, relationships to traffic patterns that is, vehicular, pedestrians, parking, relationship to other buildings, urban grains, figure-ground maps, and diagrammatic site sections. Further, in mapping the framework, the study explores the geometry of the codes and regulation or the standards. In terms of forms and space, these analyses demonstrated that basic geometry of form and space is a rectangular prism. However, this rectangular prism yielded variants. It tended to extend in the horizontal direction, creating a long, linear form that followed the length rather than the width. The linearity prevailed over the verticality, in which the multi-story structures never went beyond two-story height. In fact, this linearity lent to the primary characteristics of the formal and spatial order. Further, the linear order also informed the organization of space inside these structures. Common features were parallel linear paths or a long, winding path, around which the space inside the building were arranged. In small and medium scales structures, the rectangular basic form demonstrated common variations, including corner cuts and additions of smaller geometries. These added elements tended to be placed on axis. On large and very-large scale structures, the linear, rectangular geometry showed variants, including bending and staggering. On elevations, this basic rectangular form served as a frame on which elements were added, including triangular forms that resembled roof gable or large rectangular forms that reminded of large billboards. Besides a frame on which elements are attached, these basic forms were clad in any type of materials, ranging from stucco panels to metal panels to large, glass panes. The varieties of materials lent to a wide array of texture and colours, primarily bright colours. The colour schemes, materials, and textures formed the basic elements of the standardization of the facades of the building. These scheme, obviously, communicated the corporate brand of which the buildings belonged to. Indeed, typography was an integral element of this branding. In this vein, the tendency was that the typography took a third of the height of the building.

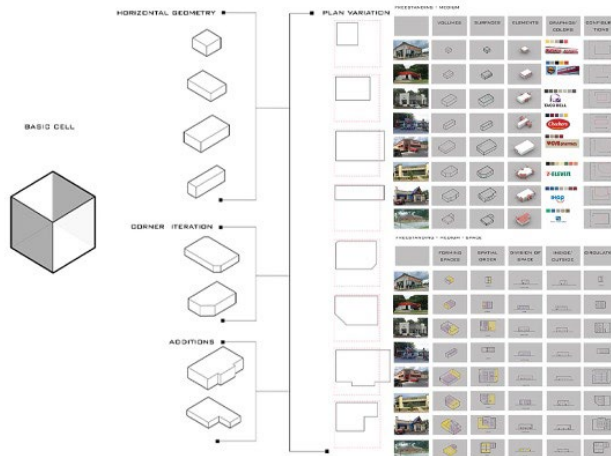

Figure 2: Formal descriptions, students: Jennifer Adame, Ana Valdez Tello. Source: (Studio work documentation 2022)

In terms of constructions and materials, these structures shared the commonality of being constructed based on modular, steel frame. This basic module set the depth of the space. The construction of these structures replicated these basic modules throughout the depth and the length of the building. These replications correlate with the formal and spatial organization. It was limited in the depth of the building; however, the basic module could be replicated as long as it needed to be. The basic module itself was a very simple system of columns, frames, and trusses. The cladding that enclosed these structures followed the logic of standardized and mass-produced materials. The ways the constructions were put together demonstrate the emphasis on speed and efficiency. These buildings were often put together in a very haphazard manner and details and fine elements were absent from the final appearance of the building. Cladding articulated the meaning of the word itself, simply covering and hiding these haphazard assemblies. With regards to experiences of spaces inside these structures and the entailed ambience, the research demonstrated a similar tendency to the aspects of formal, spatial, and materials and constructions. It observed samples of restaurants, stores, and financial services in these setting. The samples of the restaurant showed the intent of recreating the

ambience and atmosphere of mid-century diner or a home kitchen through visual means, such as types of materials, spatial elements, colour schemes, types of enclosure. However, they were also formed by the spatial configurations of kitchen and dining area. These configurations led to specific sounds and smell. However, these sensorial perceptions form a typical set of experiences and ambience that represent the corporate brand of a restaurant. Similar approaches also happened in stores and financial services. Each of these types of use a set of codified spatial experiences and ambience, using similar design approaches and strategies. These sets played on familiar experience of those uses. Those, the standardizations and mass production are not limited to only the tangible aspects of form, space, and structures, but also the intangible elements of human experiences.

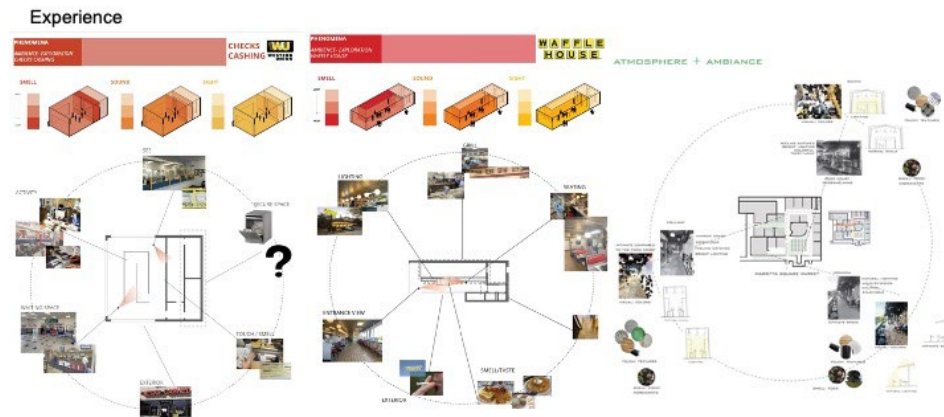

Figure 3: Ambience, students: Simona Floyd, Rolando Joseph. Source: (Studio work documentation 2022)

In terms of the relationship to contexts, these fit into the basic infrastructural system of the built-environment of the suburban-scape. Cars and highway formed the basic block of this system. Accordingly, these structures followed the linearity of the highway lanes. Indeed, the linear formal and spatial characteristics of these structures neatly related to this system. In three-dimensional space, the predominantly low-rise structure creates a horizontal datum and enhances the linearity. Further, these structures are free-standing structures in the middle of a sea of asphalt. These characteristics exemplified another accommodation to the automobile. The typical organization in a lot often include a linear organization that bent to define the boundaries of a parking lot. This linear organization is often combined with a single, large rectangular mass. The intersection between two lanes of road tends to be favourable place for development of retail space. In this vein, standard, codes, and regulation relate to these formal, spatial, structural, and contextual characteristics. Indeed, they tied to the standardizations of these characteristics and offered geometric definitions. This part of the research directed students to review “The Harvard GSD Guide to Shopping” by Koolhaas(2001) and his team, in particular their documentation of the history of shopping malls and impact of the evolutions of elements such as escalator and HVAC.^{xii} This literature review offered a historical perspective of the development of commercial space.

Findings from these series of observations, analysis, and diagramming, besides yielding abstraction, also lead to series of questions. Those include: what is the form of this space? What is the form of experiences? What is the structural systems of these space? How do they relate to their surroundings? What is the form of relationship? What regulates these relationships? These questions offered opportunities to experiment through a series of short design exercises. To facilitate these experimentations, the inquiry integrates cross-references to learn the ways other fields, primarily work of architecture and art, related similar phenomena. In experimenting with the formal and spatial aspects, the research looked into examples from pop-art. This experimentation asked to find a small scale, everyday object, cut them in a half, and document space inside orthographic, axonometric, and perspective drawings. The study transformed this space into a habitable one. In experimenting with materials and structures, the inquiry collected building materials that are commonly used in constructions of everyday structures, with an emphasis in the most common and most economical materials. It called for assembly of an artifact that articulated joints and properties of materials. To explore findings from experiential qualities, the experiment identified a set of ambience and experiences from an existing space, then proposed scenarios that altered those conditions. Design iterations aimed at thinking about the mechanism to construct such a different ambience. To explore the contextual relationship, the design explorations took form of designing a game to simulate these findings. This experimentation defined a game as system that consisted of a family of elements and a set of rules that govern the game. The rules should be able to accommodate different scenarios or conditions.

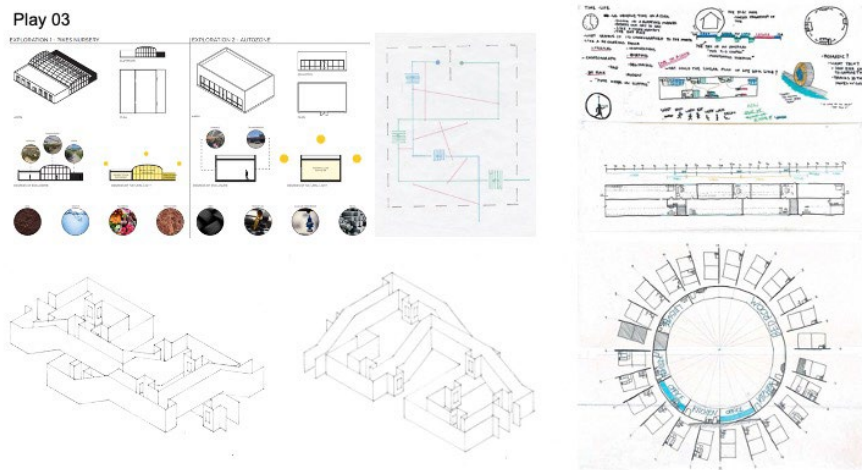

Figure 4: Design experimentations, students: Bailey Kijek, Tim Gatto. Source: (Studio work documentation 2022).

2.3. Synthesis and Design Explorations

The final part of the research devoted to test findings from experimentations and literature through design iterations of a structure or structures. It was a series of design iterations to test possibilities to translate and transform those findings into generative principles in design. One experiment focused on the ubiquity of standardization and branding through form, space, and experiences. These standardizations led to a set of building types. This experiment mashed up different these building types. Beside building up on the mutability and fleetingness of uses, these experimentations also looked into juxtapositions of iconographic elements as well as typical constructions methods. Further, it also explores juxtapositions of experiences and ambiances. Another experiment explored the notion of the formlessness of the types. It led to the argument of the disappearance of architecture, in which an architectural design no longer aimed to create recognizable, typical forms. Instead, this experiment stressed on the findings of the assembly of typical elements. This iteration reduces these elements into a single, simple element that are fabricated out of typical materials. The design iterations aim to explore possible systems to arrange this simple element in multiple directions, horizontally and vertically.



Figure 5: Final explorations, student Tim Gatto, Ana Valdez Tello. Source: (Studio work documentation 2022)

The research developed a body of descriptions of these space in terms of form, space, materials and constructions, settings, and standards. Design explorations benefits from rigor in describing through categories. These sets of description serve as a means to explore the notion of typology in architecture. These findings provide a way to comprehend, through direct observations and analysis, the distinctions that Quatremere de Quincy made between type as an idea that inform designs and model as a template that would be copied and imply formal resemblance.^{xiii} Along this line, Forty (2000) stated that typological classifications follow two possible schemes, either by use or by morphology.^{xiv} Further, although the space observed vary in uses, the formal and spatial characteristics are similar. Our observations demonstrate the primacy of morphology, which led to the descriptions of form. This aspect links this research to the notion of “form.” Forty further pointed out to the ambiguity of “form” as “shape” and as “an idea or essence.”^{xv} Indeed, he noted the pre-occupation of modernism in architecture with “form,” which stressed on the primacy

of recognizable form as the precondition for the intelligibility of the built environment.^{xvi} This primacy of form relates to the argument of the absent of relationship between form and functions or meaning, as exemplified in architecture of F.L. Wright, Peter Eisenman, Herman Hertzberger, or Aldo Rossi.^{xvii} As Vidler (1977) pointed out, the emergence of the primacy of the geometric descriptions of form led to the considerations of architectural style as simply a cladding over a basic geometric form.^{xviii} Experimentations to generate design principles from the findings play upon these notions of "form." Indeed, these design experiments explored the questions of the forms of formless, which led to several design responses. The first is through explorations of ambiguous forms, which capitalized on non-conventional geometry. Another design responses defined formless as flexible and adaptable space and forms, both in terms of the shapes of the space and their organizations. Formless also led to the conception of the disappearance of architecture as mentioned above. Some of the design explorations interpreted it as a modular system that entail open-ended configurations.

CONCLUSION

The first pedagogical values of this process is in framing design as research. Our program is a professional program that trains students in architectural design as problem-solving activities through programmatic, formal, spatial, and technical organizations. Instead, this design-research develop and cultivate the ability to see the built-environment with critical eyes and curiosities. Crucial in this mode is suspending prejudices and bias, for examples, in ideological or and cultural terms. Rather, these intellectual awareness serves to investigate the environment around us as sources for generative principles and ideas in architectural design. In this line of thought, it engages the notion of criticality in architecture. Critical architecture seeks to distance architecture from the real world; a position that has led to varieties of responses. Teddy Cruz (2014), among others, argues the need to reengage the real world. Further, it cultivates the ability to develop rigorous methodology and conducting such research following that methodology. The premise of this design-research revolves the notion of engaging the built-environment around us.

This engagement with the real world relates to the next pedagogical aim, that is, linking design and history, theory, and criticism. It structured this objective by exploring everyday space in terms of typology and morphology in architecture. These design experimentations engage possibilities of flexibility in formal and spatial terms, which led to either metaphorical or literal transformations. This inquiry revisits Quatremere de Quincy's discussion on types and models, type as ideas as opposed to model as a template to repeated. In this sense, a type opens possibilities for design explorations. In this investigation, the notion of type revolves around the problems of form. The subject matter of this inquiry highlights the notion of formlessness. Thus, this project engages formlessness as ambiguous forms, as flexible and adaptable forms, and as the disappearance of architecture. On the other hand, this design research had shortcomings in its archival and textual research. This would serve as opportunities for continuing this research, in particular, in exploring this data and findings as a design generator.

ACKNOWLEDGEMENTS

The author hereby gratefully acknowledged the contributions of students of this design-research studio: Jennifer Adame, Kim Banh, Chomzy Ezeobi, Simona Floyd, Tim Gatto, John Goddard, Rolando Joseph, Bailey Kijek, Keilani Patton, Noah Stogner, Ana Valdez Tello, Joana Waliuba, Sam Walden, Reesa Winters.

REFERENCES

- Banham, R., 2009, *Los Angeles: Architecture of the Four Ecologies, 2nd edition*, Berkeley, CA: University of California Press.
- Cruz, T., "Returning Duchamp Urinal to the Bathroom? On the Reconnection Between Artistic Experimentation, Social Responsibility and Institutional Transformation." In *Design Research in Architecture: An Overview*, edited by Murray Fraser, 205-216, London: Routledge, 2014.
- Forty, A., 2000, *Words and Buildings: A Vocabulary of Modern Architecture*, New York: Thames & Hudson.
- Foucault, M., "Of Other Space: Utopias and Heterotopia," in *Rethinking Architecture: A Reader in Cultural Theory*, edited by Neil Leach, 329 -36, London: Routledge, 1997.
- Fraser, M., "Introduction." In *Design Research in Architecture: An Overview*, edited by Murray Fraser, 1-14, London: Routledge, 2014.
- Fredric, J., "On Interpretation: Literature as a Socially Symbolic Act." In *The Political Unconscious*, edited by Fredric Jameson, 17-102, New York: Cornell Univ. Press, 1981.
- Koolhaas, R., "Junkspace," *October, Vol. 100, Obsolescence*. (Spring, 2002): 175-190.
- Koolhaas, R., Inaba, J., Leong, S.T., Chung, C.J., et. al, 2001, *Harvard Design School Guide to Shopping*, Cologne: Taschen.
- Lefebvre, H., "The Production of Space, excerpts", in *Rethinking Architecture: A Reader in Cultural Theory*, edited by Neil Leach, 132 - 139, London: Routledge, 1997.
- Venturi, R., 1977, *Complexity and Contradiction in Architecture, 2nd edition*, New York: The Museum of Modern Art, New York.
- Venturi, R., Scott-Brown, D., Izenour, S., 1977, *Learning from Las Vegas, revised edition*, Cambridge, Mass.: The MIT Press.
- Vidler, A., "The Idea of Types: The Transformation of the Architectural Ideal, 1750-1830, *Opposition*, no. 8 (Spring 1977): 95 - 115.

ENDNOTES

ⁱ “the processes and outcomes of inquiries in which architects use the creation of projects, or broader contributions toward design thinking, as the central constituent in a process which also involves the more generalized research activities.” Murray Fraser, “Introduction,” 1

ⁱⁱ Venturi, *Complexity and Contradiction in Architecture*; Venturi, Scott-Brown, Izenour, *Learning from Las Vegas*

ⁱⁱⁱ Banham, *Los Angeles: Architecture of the Four Ecologies*

^{iv} Koolhaas, “Junkspace,” 175-190

^v *ibid.*, 151

^{vi} *ibid.*, 147

^{vii} *ibid.*, 151

^{viii} Foucault, “Of Other Space: Utopias and Heterotopia,” 333 - 35

^{ix} Lefebvre, “The Production of Space, excerpts,” 136

^x *Ibid.*, 135

^{xi} Fredric Jameson, “On Interpretation: Literature as a Socially Symbolic Act,” 17 - 102

^{xii} Koolhaas, Inaba, Leong, Chung et. al. *Harvard Design School Guide to Shopping*

^{xiii} Forty, *Words and Buildings: A Vocabulary of Modern Architecture*, 304; Vidler, “The Idea of Types,” 104 -05

^{xiv} Forty, *Words and Buildings: A Vocabulary of Modern Architecture*, 304

^{xv} *ibid.*, 149

^{xvi} *ibid.*, 162 - 63

^{xvii} *ibid.*, 165 - 69

^{xviii} Vidler, “The Idea of Types,” 108 – 10

How Do We Remember? A Data-Driven Approach to the Design of Monuments in Public Spaces

Tiffany Lin ¹, Emilie Taylor Welty ¹, Lisa Molix ²

¹Tulane University School of Architecture, New Orleans, LA

² Tulane University School of Science & Engineering, New Orleans, LA

ABSTRACT: Across the United States, monuments to racism and social inequity are being toppled and communities are imagining more inclusive public spaces. Within this context, an interdisciplinary team of architects and a social psychologist from Tulane University collaborated to improve understanding of how perceptions of current monuments can influence the design of new forms of commemoration in New Orleans. The team conducted a national survey of people who identified as design professionals or as lay people to investigate public opinions of existing monuments, and led a research seminar and design studio to explore new forms of collective memory on a local site marked by racial injustice. In sum, this research revealed a common desire for monuments and memorials that reflect the communities where they exist, and a desire amongst survey and community-based participatory action research participants to engage in the creation of new public monuments and memorials. Further, the research conducted by our team including an examination of precedent sources showed that the local and national monument landscape does not accurately reflect the people, places, and values of their current or past sites. This subsequent design studio underscored that the specifics of what memories are marked, whose stories are told, and who is doing the storytelling are all critical aspects to consider as designers work to tell more inclusive histories in our public spaces. The data and design speculations were woven into a public exhibition entitled: *How Do We Remember?*

KEYWORDS: Monuments, memorials, public space, racial bias, social psychology

INTRODUCTION

Monuments have been the focus of national conversations because of who and what they honor, and how their design memorializes the truth (or fiction) of our collective past (Alderman 2020). Monuments and memorials in public spaces, particularly those that highlight a legacy of racial injustice (Block 2020), have become public stages for expressing the need for social change and backdrops for rallies to either keep or remove these contested objects. As Figure 1 shows, the city of New Orleans has seen its share of protesting, vandalizing, and monument removals (Hunt 2021) –and we are now left with the opportunity to reimagine, rename, and recontextualize this collective history. One such site is the pedestal to the former Jefferson Davis monument in Mid-city (removed in May 2017) which presents a vacant urban stage set where impromptu gatherings and installations have inspired conversations surrounding public memory and social justice.

Although these topics are becoming integrated into architectural pedagogy and design practice, very little of the empirical work on the recontextualization of public spaces has included the voices of the communities in which these spaces exist, and the architecture profession does not typically reflect the communities for whom public spaces are designed (NCARB 2020). In order to address this omission, our interdisciplinary research project examines differences in perceptions of public monuments and aims to equip designers with the skill set to engage with communities to create equitable, inclusive and historically accurate forms of collective commemoration. With the support of a SOM Foundation Prize, our team conducted a research seminar, a national survey, and a design/build studio with a community partner that resulted in a public exhibition.

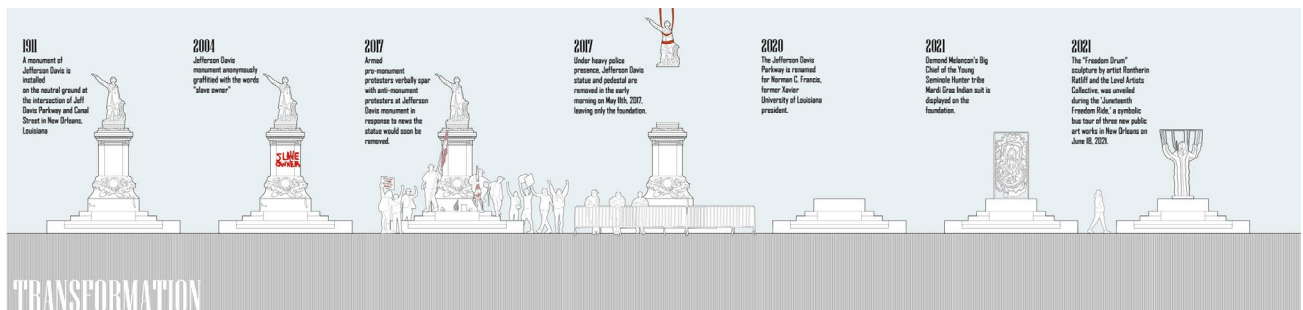

Figure 1: Transformation of the Jefferson Davis monument in New Orleans, removed in May 2017 after much protest. The remaining statue base has been repurposed by local artists. Source: (Authors 2022)

1.0 RESEARCH SEMINAR

A key element in the execution of this project was the cooperative development of a set of tools for use in the reconceptualization of contested public spaces. To this end, our team conducted an architecture seminar in the Fall of 2021 that invited students to examine existing public spaces, monuments, and memorials—and collaborate on developing a framework for future design. The course included the diverse interdisciplinary perspectives necessary to inform and then create such a framework. For example, students learned fundamental scientific methodologies and protocols used in social psychological research including the ethics and compliance training required by the Institutional Review Board for working with human subjects. They also learned about intergroup relations theory and research with a focus on explicit and implicit bias.

Enriching the interdisciplinary perspectives of our team, guest speakers were instrumental in extending our frame of reference for discussing monuments and memorials and leading class discussions in the context of the national movement. Speakers included:

- Jha D. Amazi: Co-Director of the Public Memory and Memorial Lab at MASS Design Group;
- Rachel Breunlin: ethnographer and co-founder of the Neighborhood Story Project;
- Jose Cotto: local artist and photographer;
- C.J. Hunt: comedy writer and director of *The Neutral Ground* documentary;
- Bryan Lee: architect and founder of the Design Justice Platform and Colloqate Design;
- Sue Mobley: Senior Research Scholar at Monument Lab;
- Dr. Ibrahima Seck: historian and Research Director at the Whitney Plantation Museum

Building upon the distinct perspectives of each invited speaker, along with exposure to social psychology and racial justice literature, the team generated the framework for community discussions and content for public surveys. The class work combined input from these sources to complete a number of important assignments, putting into practice the necessary considerations of the impacted community. In concert with the development of the research materials (e.g. survey, recruitment posters, community talking points), students produced a catalog of existing monuments/memorials/rituals and analyzed each case study in terms of formal and perceptual characteristics. They worked in groups to diagram and catalog existing monuments and memorials in terms of type, subject matter, formal characteristics, and temporality. These studies generated an index of existing monuments and memorials in the Greater New Orleans region in order to expose students to the multiplicity of monuments and the associated potential complexities of community opinions.

This exercise served to both educate the students about memorials and also provide a collaborative and educational design opportunity for the class that could help to address the previously identified knowledge gap among architectural professionals. Figure 2 shows this interactive catalog of existing monuments exhibited at the American Institute of Architects Design Center in New Orleans. Engaging a wall of operable panels, participants were invited to note whether they had seen the monument, whether they knew what it was about, and whether or not they liked it—which served as additional data on perceptions of public spaces, monuments, and memorials. The location of these case studies were marked with red dots on a city map adhered to the ground, with a prompt asking participants to indicate their own awareness of other monuments by inviting them to extend this catalog to areas our team has yet to include. In addition to educating the visitors, this installation project prompted self-reflection as well.



Figure 2: *How Do We Remember?* Exhibition wall of case studies: Each monument/memorial presented as an operable panel that invited visitors to share their opinions of the piece. (Source: Authors 2022)

The final element of the course design included field trips and site visits to relevant spaces. In addition to tours of local museums and monument sites, the students and instructional team traveled to Montgomery, Alabama to visit the National Memorial for Peace and Justice. We included this site in the course in order to offset students' sometimes narrow references and expectations for what a monument/memorial *should* be. The abstract spatial experience choreographed by Mass Design Group is in stark contrast to the typical object-on-plinth typology common to existing monuments and memorials, challenging students to reorient their previous conceptions about monuments and memorials (e.g. Figure 3). The highly organized experience exposed students to a highly designed, yet alternative way of remembering. During the visit, we traversed a vast array of steel figures engraved with accounts of lynchings cataloged by counties. As the circumambulatory ramp drops down, the steel boxes become suspended in mid-air relative to the viewer, evoking the visceral atrocity in our collective memory. The decidedly sequential experience, with a clear and intentional beginning and end, ultimately informed the group's speculative design proposal for the exhibit described above. Inspired by this experience, students also identified a need to develop an awareness of other contemporary monuments and memorials that challenge existing typologies of the monument landscape in order to effectively incorporate diverse perspectives into an understanding of the current landscape. They then created a catalog of those monuments and memorials as part of their work in the course.

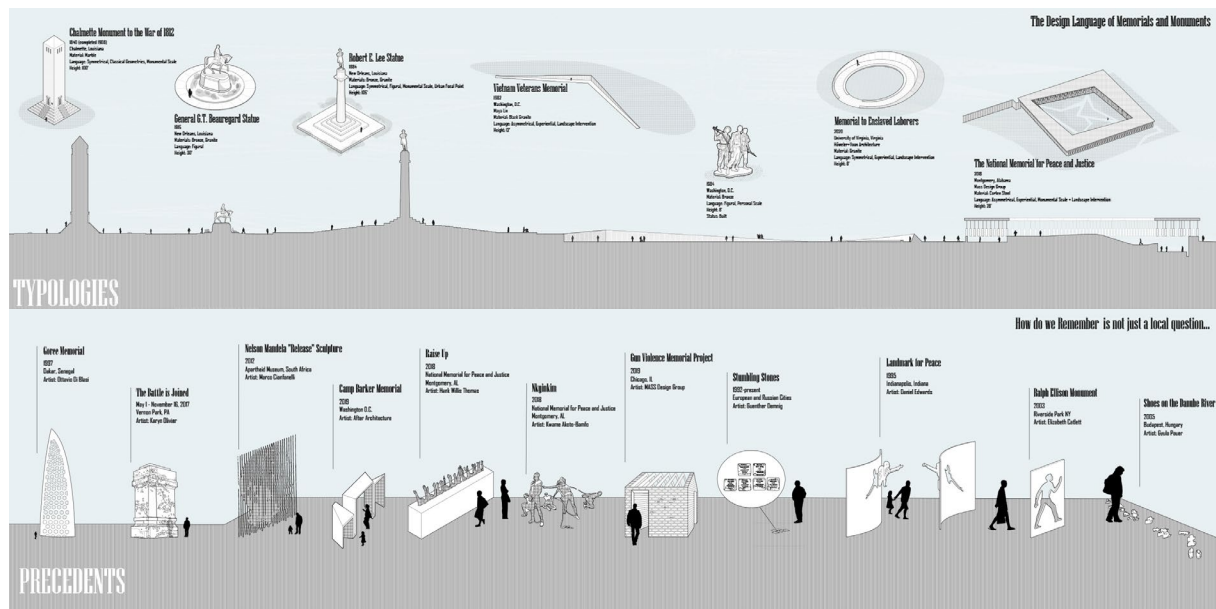

Figure 3: Monument Typology & Precedent Panels: students cataloged and analyzed existing monument types and contemporary precedents that challenge the typical understanding of monuments and memorials. (Source: Authors 2022)

2.0 NATIONAL SURVEY

Because our research seminar and studio would result in an exhibition in a contested space, the team identified the need for a survey to gather the data that should inform a project such as ours. This survey data was used in our work and can also serve as a template for data collection that may be done by future architects and designers as they embark on similar projects. We identified important questions to be answered that would be vital in helping us design our project. The primary research goal of our IRB approved national survey study was to quantitatively examine the relationship between social group memberships, individual differences in social dominance orientation (attitudes toward social hierarchies and beliefs about whether one's groups should dominate other groups), (Pratto 2013) color-blind ideology (denial of racial differences by emphasizing sameness and denial of racism by emphasizing equal opportunities) (Neville 2013), community esteem or a sense of community (Bettencourt 2003) (Nichols 2013) and participants' opinions about which the elements of design are relevant or desirable in community spaces. Over 400 participants completed the 30-minute survey as of April 2022. The survey data contains perspectives from across the United States, including people who self-identified as designers and those who do not identify as designers.

Although participants generally endorsed all objects as important (M =4.05 on 7 point Likert scale), the initial data suggests that there are differences in opinion between non-designers and designers on what elements of design are ideal in public spaces. For example, those who did not self-identify as designers rated trees/bushes/flowers/objects, shade, parking, playgrounds, and art as being more important than those who self-identified as design professionals. In addition, both those who did not self-identify as design professionals and design professionals strongly endorsed the idea that public monuments and memorials should reflect the communities where they exist. Most participants (89%) reported that they would enjoy public spaces and monuments more if they participated in creating it.

The graphic representations in Figure 4 highlight some findings from the survey, including initial data showing statistically significant differences between designers and non-designers. Specifically, non-designers reported lower social dominance orientation (SDO), endorsement of color blind ideology, and esteem for their community when compared to design professionals. To date, there is no previous empirical research examining the personality or worldviews of those who identify as design professionals. Due to the novelty of this data, the pattern of results elicits more questions than answers. Why are the worldviews of the design professionals in this data set different (e.g., less egalitarian, endorse colorblind ideology) from the non-designers? Are these differences related to their choice of vocation or training? Despite an increased focus on equity, diversity, and inclusion across the discipline remains homogeneous (NCARB 2020). Indeed, increasing representation at all levels and improving the effectiveness of architectural education and accreditation via best practices will be necessary to achieve a more equitable, diverse, and inclusive field. Future research should aim to examine these relationships, the relationship between individual differences in worldviews, representation, and more inclusive training practices.

National Survey

key findings from sample survey questions

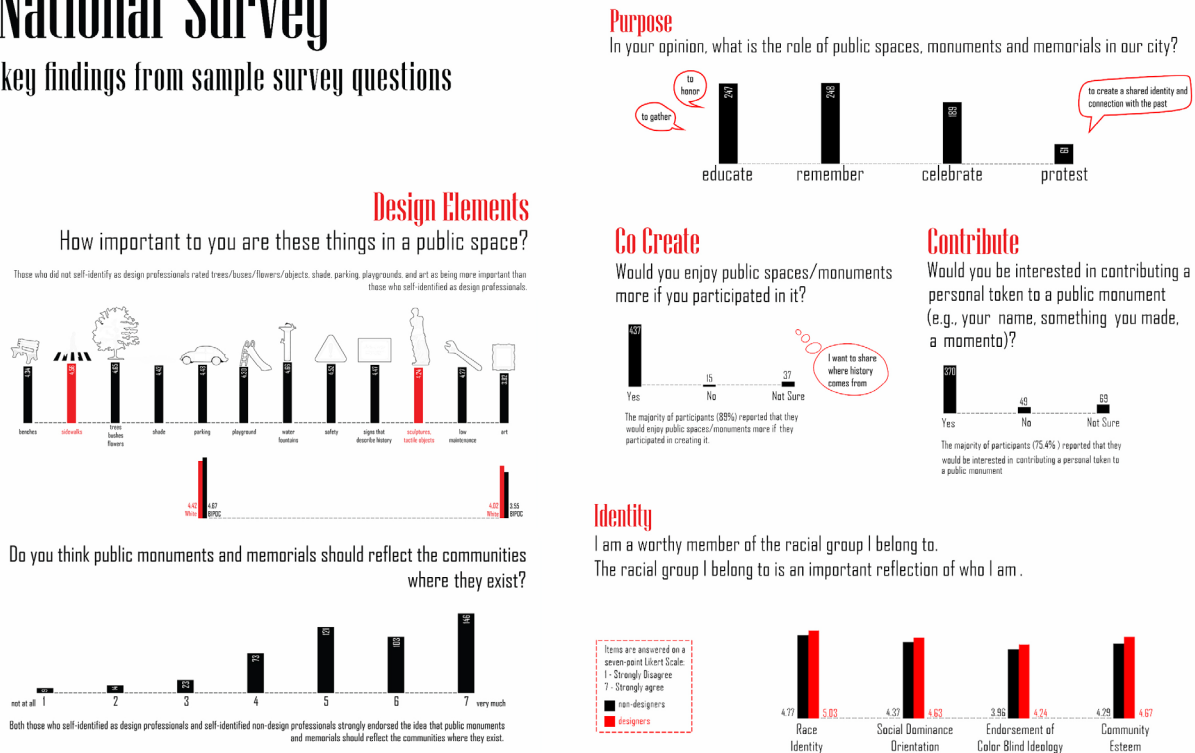

Figure 4: Graphic highlights from the Public Space and Monuments national survey results. (Source: Authors 2022)

In an effort to collect more qualitative data, our survey asked several open response questions such as: “Are there any personal thoughts you want to share related to the topic of public spaces/ monuments in your city?” Several participants took time to write in comments in these open fields. Some thoughtful responses that resonated with our team and informed students’ design proposals included:

“Monuments are important tools for shaping social values and identities.”

“It is great for the community to build a public place which enhances the social status of the community and also gathers people’s popularity. I believe people will regard the community as a comfort zone to jointly maintain, and the monument should be engraved with history so that people can remember and remember the history.”

“I think there needs to be inscriptions, memorials, records of where the community came from and what happened.”

“I think it is incredibly important for public spaces to be a place where people can relax, connect to their community, learn, and experience nature. They should be spaces that are accessible and welcoming to all inclusive of race, ability, age, language, or any other factors that make us a diverse community.”

“The monument bears the memory of the city and the will of the nation.”

"Monuments are often huge, towering structures that inspire awe by reminding people of their insignificance on an unusual scale. It reminds the world not to forget those who sacrificed their blood and lives for us, and not to forget the lessons that nature and society have taught us. It also inspires us to move forward."

In order to effectively use such data in a design project, the researchers must be keenly aware of sequencing. The time constraints (e.g., funding timeline, IRB review process, university schedule) on our project limited our ability to achieve all of our milestones. While our students were extremely helpful in building the national survey, the survey itself was not conducted in time to directly inform the entire design process. In future iterations of a project such as this, the instructors may have to decide to collect data prior to the start of the semester, rather than using class time to have students co-create the survey. Despite this shortcoming, the students still learned the importance of developing such a tool and the associated methods required to do so proficiently.

3.0 RESEARCH STUDIO

The research seminar and studio associated with this project offered our students an opportunity to put theory into practice. Through the courses, students reconsidered design pedagogy and had a chance to welcome a broad coalition of stakeholders to collaborate on a community-engaged or participatory action research method of marking memory in public space. In the Spring of 2022, our team led a group of architecture students through the process of prototyping a public memorial for the Lafitte Greenway—a linear park that transverses six urban neighborhoods of Central City New Orleans. We collaborated with a community partner, Friends of the Lafitte Greenway, a non-profit organization with the goal of generating a community-engaged process that would inform the design of a new public memorial. Our team took every opportunity to incorporate relevant data and community input in the conceptualization of the project in order to develop a template for other designers doing similar work.

The specific site we selected is a public park that used to house a segregated playground. (Campanella 2017) Currently the park is frequented by adults, children, locals and tourists of all races, enjoying the space for recreation and fitness, but there is no recognition of its history in the location's online presence or physical space. Our team generated design proposals that acknowledged this divided history, and worked to advance conversations regarding the need to co-design public spaces and memorials that reflect the communities in which they exist. We coached our students through conversations with local elders and helped them understand how to use this qualitative information as well as the data from the survey to help the team shape the program for this site-specific proposal and translate the desire for communicating layered community histories. Working with a community partner with deep-seated knowledge of the site and its conflicted history allowed our design studio to test strategies for more inclusive site engagement and designs. For example, we erected temporary panels asking passersby to write what they thought would "make this place better" and whether they had a "story to share" about the site. Figure 5 shows a collage of engagement with the panels that were erected on site and left for three weeks, during which our team hosted activities to encourage conversations with those who frequent the park. We also held design process reviews on these site panels, inviting community input and critique. Students working in our social psychology lab transcribed and coded the data from these boards, which is graphically summarized in Figure 6.



Figure 5: Site Engagement activities collage. Source: (Authors 2022)

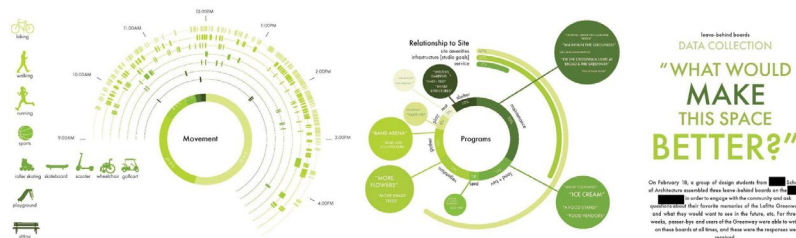

Figure 6: Graphic summary of park use as observed by the research team during site visits. (Authors 2022)

Students gained exposure to the complex nature of community opinion and the possible tensions or synergies between community engagement and survey data. During conversations with community elders who grew up adjacent to this park, stories of important local leaders, social activists, and cultural events were shared. These meetings helped us better understand community members' strong desire to have a space to recall their memories of this park and to contend with the stark, and relatively recent, transformations along the Lafitte Greenway. Many community members expressed a clear sentiment that the families who inhabited the housing complexes near the park were displaced due to gentrification. They also lamented that the current conditions of the park no longer reflected the community who helped build and care for it. The compilation of this feedback marked an important lesson for our students. While a project may be well-researched and a designer well-intentioned, information may become available that thwarts forward progress. We realized that, in order to fully recognize and respect this history— and properly record and preserve these stories— the timeline to collect and appropriately incorporate personal stories into a public monument was in conflict with the short calendar of an academic design/build studio and iterative IRB processes. Students were able to witness and participate in true dialogue with the community that resulted in a necessary outcome - a pause on the project - rather than a short-sighted move to barrel forward without considering the consequences.

Rather than crafting a design in the space, our team pivoted to the creation of an exhibition which aimed to share and extend our collaborative process with the public at the semester's end. We invited community stakeholders to this space as an opportunity to critique our work and the process in order to further the conversation. Designing this exhibition and a physical prototype offered a pause to reflect upon the design process, and further design development conversations and decision making processes with our community partners. To this end, our team designed a series of abstract folded modules as a point of departure, able to adapt to the content desired by the community and be arranged into various different configurations.

These placeholder modules can be aggregated in various orientations to create sculptural gateways. In the proposed scenario presented at the exhibition, the gateways align to connect the historic gate of the black-only playground to the iconic oak tree on the site. With branches spanning over 100-feet in diameter, this tree served as a natural landmark and shaded destination to culminate the folded gateways. These spatial frames were also designed to support benches and tables— informal gathering spaces desired by the community as we learned from our site conversations and data-collection boards. The proposal consisted of eight folded corten steel panels that can outline profiles of local figures to be honored, be inscribed with local histories, and serve as a physical timeline that records the park's transformation. Figures 7-9 show the speculative design proposal that was developed and rendered as a vehicle for advancing conversations about what could be an appropriate form of remembrance on this site.

While this exhibition was not the original goal of the course, students learned that if they sincerely wish to incorporate community feedback, they may need to shift their goals in order to better align them with the feelings of impacted citizens. This lesson is vital if architecture and design professionals wish to incorporate equitable practices into their public work.

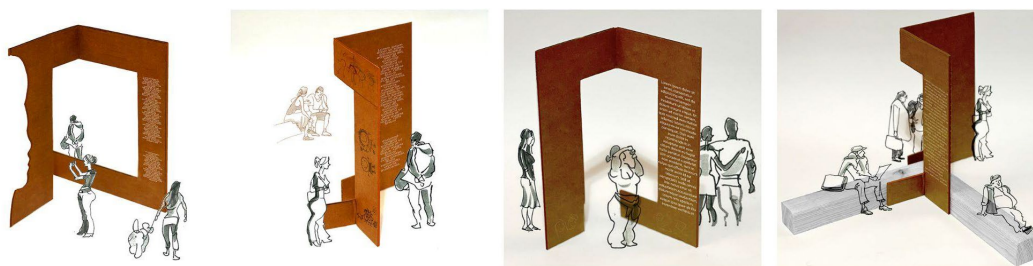

Figure 7: Landscape module studies inscribed with historical site data. Source: Authors 2022



Figure 8 & 9 : (left) View of site proposal showing path and remembrance modules that are situated in a formerly segregated playground. The path runs from a neighboring historic housing complex to an active park. (right) Site view of landscape modules culminating under an iconic oak tree; mural of local faces by artist BMike in the background. Source: Authors 2022

4.0 EXHIBITION

The culminating event of this project was the exhibition of this body of work at the AIA New Orleans Design Center—a charged venue that is in front of an approximately 75-foot empty pedestal that held a 16'6" statue of Robert E. Lee until it was removed on May 19, 2017. Its storefront windows also face the city's Civil War museum. Interactive panels invited visitors to contribute to the content of this exhibit and engage in conversations surrounding the design of monuments and memorials. Photos from the event show the final exhibition which incorporated content from the national survey, research seminar, and design studio—weaving together precedent analysis, monument typologies, our speculative proposal, and data from the National Monument Audit by Monument Lab (Monument Lab 2021). Finally, Figure 10 shows the full-scale mock-up in the exhibition space which served as a prototype for the landscape modules. It is inscribed with our overarching aim for the design proposal:

*What if a monument is an experience:
something you can walk through;
and see yourself in;
you can sit with;
that teaches you the history of the place?*

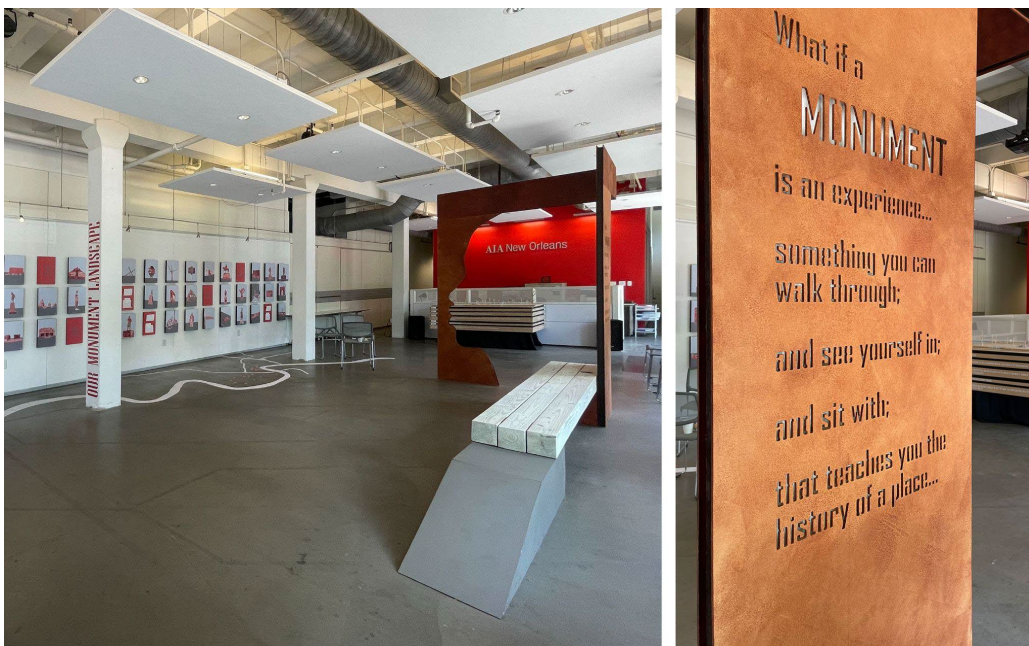

Figure 10: View of exhibition with closeup of prototype panel text. Source: Authors 2022

CONCLUSION

This constellation of research involved a national survey that assessed participants' perceptions of memorials and public spaces in relation to their social groups and worldviews, and local community-based participatory action research methods. The survey data showed that regardless of training background, participants strongly endorsed a belief that monuments and memorials should be a reflection of the communities where they exist – which recent data from the National Monument Audit shows is not our current state of monuments in the U.S. Survey participants, including designers and non-designers, see the primary functions of memorials as spaces to educate and mark memory. Furthermore, there was a clear desire to participate in the creation of new public monuments and memorials, including strong interest in contributing personal items to the creation of a memorial. What was also clear from this research and associated design studio is that the specifics of what memories are marked, whose stories are told, and who is doing the telling are all critical questions for designers to consider as they work to tell more inclusive histories in our public spaces.

As educators who work to teach design values and practices that build a more equitable future, we hope that projects such as this can help both students and professionals in design fields gain a deeper understanding of and commitment to the relationship between design and social justice. Our work strengthened our belief in the need for interdisciplinary collaboration to gather insightful data and the buy-in of community members if we want to create meaningful public monuments and memorials. From speaking with the community elders, we were humbled by the extensive personal histories that preceded us and the need for more time and vested engagement to truly respect the immediate community input and craft a process for deciding which stories are told and how. We revealed that the time needed for this thoughtful engagement was at odds with academic and grant cycles, creating some internal friction between the desire to act and the need for more conversation and collaboration.

Furthermore, the initial data gleaned from our national survey taught us that designers may have a higher social dominance orientation (SDO) and be more likely to endorse colorblind ideology than non-designers. This underscores the need for community input when designing for public spaces and programs. In addition, we hope the survey results and engagement tactics we used can be referenced by other practitioners, artists, and academics working on similar projects.

ACKNOWLEDGEMENTS

This project was sponsored by the SOM Foundation. Special thanks to the Tulane School of Architecture and the Department of Psychology for supporting interdisciplinary research at Tulane University. We would also like to acknowledge our students from the seminar and the studio for their thoughtful engagement: Rachel Abrahams, Leah Bohatch, Yardley Borton, Hayden Boyce, Zachary Braaten, Hayley Burroughs, Tahlor Cleveland, Andreea Dan, Alex DiSimone, Kareem Elsandouby, Lovia Feliscar, Paola Foresti Pinto, Joelle Friedman, Laura Isabel Gonzalez Rosenberg, Vivien Hartin, Camille Kreisel, Seth Laskin, Mei-Ling Malecki, Talazia Manuel, Gabriella Maze, Brooke Mehney, Andres Eduardo Perez Yopez, Malina Pickard, Leonardo Sequerra Koogan Breitman, Bruno Soria, Miriam Taylor, Tiger Thepkanjana, Joseph Townsend

REFERENCES

- Alderman, Derek H and Jordan P Brasher, "Memorials and Monuments." *International Encyclopedia of Human Geography, 2nd edition*. 2020, 39–47.
- Bettencourt, B. Ann, and Author. "Satisfaction with health care and community esteem among rural women." *Analyses of social issues and public policy* 3, no. 1, 2003. 1-14.
- Block, Melissa. "Push to Remove Confederate Monuments Opens Debate on Other Honored Historical Figures," *National Public Radio*, July 2, 2020.
- Campanella, Richard. "Today's Lafitte Greenway Was Spanish New Orleans' Carondelet Canal." *The Times Picayune Cityscapes: A Geographer's View of the New Orleans Area*. November 17, 2017.
- Hunt, CJ, director. *The Neutral Ground*. PBS, 2021. 90 minutes. <https://vimeo.com/ondemand/theneutralground>
- Monument Lab. "National Monument Audit." 2021 www.monumentlab.com/audit
- National Council of Architectural Registration Boards (NCARB), 2020 NCARB by the Numbers, Demographics, 2020, 59.
- Neville, Helen A et al. "Color-blind racial ideology: theory, training, and measurement implications in psychology." *The American psychologist* vol. 68,6 (2013): 455-66. doi:10.1037/a0033282
- Nichols, Author and Charles P. "Satisfaction of basic psychological needs as a mediator of the relationship between community esteem and wellbeing." *International Journal of Wellbeing* 3, no. 1 (2013).
- Pratto, Felicia, Atilla Çidam, Andrew L. Stewart, Fouad Bou Zeineddine, María Aranda, Antonio Aiello, Xenia Chrysoschoou et al. "Social dominance in context and in individuals: Contextual moderation of robust effects of social dominance orientation in 15 languages and 20 countries." *Social Psychological and Personality Science* 4, no. 5: 2013, 587-599.

Portcityscapes as Liminal Spaces: Building Resilient Communities Through Parasitic Architecture in Port Cities

Asma Mehan¹, Sina Mostafavi¹

¹ Huckabee College of Architecture, Texas Tech University, Lubbock, TX

ABSTRACT: Port Cities are historically the places for paradigm shifts, radical changes, and socio-economic transitions. In particular, the interaction zone between the port infrastructure and urban activities creates liminal spaces at the forefront of many contemporary challenges. In these liminal spaces, the port's flows, form, and function intertwine with urban contexts and conflict with the living conditions. Conceptualizing the portcityscape and harborscape as liminal space and urban thresholds leads to (re)thinking about innovative participatory methods and technologies for building community resilience in port cities. Additionally, inevitable constant development in port cities requires adaptability and resilience from the waterfronts to the hinterlands and city centers. Such confrontation of port infrastructures and urbanization is socio-politically and spatially challenging, specifically in historic port cities. Therefore, as the approach to exploiting energy and human resources changes over time, the physicality of the built environment in port cities and how we (re)use the resources need to be redefined. This research investigates key socio-spatial features and challenges of port cities by examining how the port's proximity to the city requires coordination, collaboration, transparency, and community dialogue. The introduction and background literature discuss three domains and notions of port city studies, building community resiliency through participatory frameworks, and parasitic architecture. By building upon this analytical framework, the paper presents case studies developed within the research-led design studio focusing on building resilient communities in four port cities, including Amsterdam, Constanta, Alexandria, and Rio De Janeiro. This research focus on the community-enabled application of emerging technologies, innovative approaches, and co-designing and co-building participatory methods. The selected case studies introduce an integrative and multi-scalar pedagogical framework for building resilient communities in liminal spaces of port cities.

KEYWORDS: Port Cities, Resilient Communities, Liminal Spaces, Parasitic Architecture, Industrial Infrastructure

INTRODUCTION

The spatial logic of port cities provokes the appearance of liminal spaces and transitional urban thresholds. Perceiving portcityscape and harborscape as liminal spaces throughout the city, from the waterfront to the hinterlands, leads us to (re)think about the proximity of urban living ecosystems next to port city activities. While the juxtaposition of the two (Urban and Port) may provide opportunities for the adaptive reuse of port infrastructure, it may also result in challenging conditions and sometimes disastrous incidents. Cases such as the Beirut Blast that happened on 5 August 2020 show how a coherent understanding of the interplay of spatial, social, economic, and cultural dimensions in a dense and historic port city is critical for urban planning and design (Mehan & Jansen 2020). With so many casualties among citizens, the disaster painfully indicates the proximity of a port to the city requires coordination, collaboration, transparency, and community dialogue. Beirut's massive explosion has shown us -once again- the impact a port disaster can have on a city and its inhabitants—spatially, socially, economically, and culturally (Mehan et. al 2022; Hauser et. al 2021). Conceptualizing liminal spaces as part of the portcityscape (spatially and socio-culturally) allows for an alternative understanding of resilient communities and the advanced application of collaborative design practices. The characteristics of liminality can be explained through both objective parameters such as spatial, geographical, and administrative and as well as subjective criteria based on traditions, social norms, and everyday practices. For port city citizens, the essential liminal border concerns the boundary between the port and the city, between the waterfronts and the hinterlands (Teschner 2018). This research is built upon the premises that it is possible to reconsider the conventional dichotomy of 'city-port' by outlining a vision in which the port city is a *forma Urbis* in progress: a composite, plural, and open figure affected by the speed of changing processes and influenced by the many factors that every day are embodied in its socio-spatial setting (Mehan & Abdul Razak 2022a; 2022b). The body of this article includes a literature review, research methods, and pedagogical case studies that together provide frameworks for analyzing and designing liminal spaces of portcityscapes. The case studies utilize the notion and concept of parasitic architecture as an adaptive reuse strategy that can blur the boundaries between port and city. In this context, parasitic architecture is conceived as a transitional form of architecture that is associated with integrating new structures into existing buildings and infrastructures (Fard and Mehan 2018). Moreover, the study addresses challenges and presents examples of integrated design-to-production workflows for resilient communities in socio-spatial port cities.

1.0 LITERATURE REVIEW

The literature review covers three main areas: port cityscapes and liminality, building resilient communities, and parasitic architecture as adaptive reuse, spatial analysis, and design strategy.

1.1. Port Cityscapes as Liminal Spaces

Port cities are seen as interconnected networks which have historically been gateways for cultural change and windows to the wider world (Hoyle 2002, 14). Especially the emergence of Globalization studies over the past twenty years has been seen as the primary catalyst of attention for the significance of port geography to bridging worlds, which stimulated the circulation of people, goods, ideas, technology, and global connectivity (Sassen 2012, 918-937). Port cities are sensitive to larger political, economic, and technical transformations. Therefore, any serious analysis of port cities must take an integrated approach to the complex interactions between a port city's-built environment, metropolitan spatial form, urban planning actors, and economic and commercial land and sea networks (ibid, 805). Port cities are paradigmatic and constitutive liminal spaces and places of otherness. In particular, the area where the port and city, or the port and the surrounding landscape engage with each other – requires focused study and new planning concepts. Scholars from humanities, social, and design sciences have proposed different terms to identify this port city-state in different disciplines, such as seascape (Bentley et al. 2007), harborscape (Russo 2016), portcityscape (Hein 2016), portuality (Moretti 2019), and maritime cultural landscape (Westerdahl 1992).

The urban coastal land and waterfronts in decaying port facilities have been globally recreated as public spaces in numerous redevelopment efforts. Such liminal spaces hold the potential to play a key role in improving the quality of urban life, intrinsic to vital, sustainable urban communities, and a platform for diverse activities (Degen & Garcia 2012). And a more global port city, the more widespread within its fabric are what may be referred to as 'liminal urban spaces.' These 'liminal urban spaces' act as trans-border and transnational social networks for ethnic communities that emerge in spatial development, economic exchange, or political structures (Krathke & Lanz 2012, 33). It is important to examine the material manifestations of liminality in port cityscapes, its consequences for the physical transformation of spaces as arenas for the diverse development actors and trans-border activities, on the emergence of social and economic networks, and on the creation of narrative and discursive spaces that are born out of adaptable space production and the emerging technologies.

1.2. Building Resilient Communities in Port Cities

Ports, cities, and surrounding regions are striving to find solutions to the global and local challenges they face. These challenges include but are not limited to climate change, the economic shock related to the coronavirus pandemic, rapid automatization, sociocultural transformation, and energy transitions. To respond effectively, rapidly, and meaningfully to upcoming port city challenges, diversified stakeholders in the port city region, such as port authorities, governance agencies, educational institutions, legal entities, cultural organizations, private and public actors, as well as Non-Governmental Organizations (NGOs), and residents are required to provide coordinated responses. Providing the holistic and multi-benefit response from this wide variety of actors with different interests to a diverse, complex, and sometimes unpredictable range of changes is a major challenge to overcome, but opportunities do co-exist (Mehan & Mostafavi 2022; Mehan 2020). The thrive to building resiliency has a long history in the port cities' local communities. Such efforts are embedded in the port city culture around shared values based on a strong and dedicated collaboration among various groups of public and private actors from different backgrounds on diverse social and environmental challenges (Garcia 2019; Dahl 2019). Enhancing the adaptive capacity of the communities over time is crucial to respond to the growing uncertainties and complexities associated with major threats and hazards in port cities (such as environmental, political, and economic). Consequently, the concept of resiliency is continuously evolving to appropriately respond to the societal, political, cultural, and ecological needs of the people and society (Mehan & Mehan 2022; Repellino et al 2016). In another definition, community resilience is the "capacity of a distinct community to absorb disturbance and reorganize while changing to retain vital key elements of structure and identity that preserve its distinctness" (Fleming & Ledogar, 2008). So, in this definition, maintaining the collective identity is critical in resilient systems. This will lead to the co-creating of scenarios and future-proof design strategies for sustainable and resilient coexistence in the port city regions (Mehan & Abdul Razak 2022c). Considering contemporary challenges and to provide a close examination of socio-cultural impacts and the integration of port and city regions, new holistic development approaches and spatial design solutions are required to ensure resilient development in the port-city region. Through various case studies in four port cities of Amsterdam, Constanta, Alexandria, and Rio de Janeiro, this research utilizes innovative methods such as the parasitic architecture approach and adaptive reuse strategies to respond spatially and socially to these challenges.

1.3. Parasitic Architecture and Adaptive Reuse

The term "parasitic architecture" is usually explained as "fill-in architecture" and "informal architecture," which have a parasitic origin and evolve through time to become mutually beneficial for the host or the old and the expansion or the new (two refs). In the context of this research and the following case studies, the notion of parasitic architecture is used as a strategy for the adaptive reuse of port infrastructure and harbor thresholds. Often parasitic architecture is synonymous with extensions and annexed architectures and adaptations. In this sense, parasitic architecture can be defined as an approach to developing a symbiosis of the existing built and natural environment with the new

architecture. The descriptions broadly define parasitic architecture as a new room or building attached to an existing larger structure, while there is a difference between the two. This is limiting as parasitic architecture is thrown around to describe unusual expansions or something that solely benefits the host building. However, parasitic architecture can be thought of as more complex and as something that has the potential to affect the entire city and, in the context of this research portcityscapes.

In his article, Given (2021) uses the case study of train lines in Tokyo to seek the true definition of parasitic architecture and specify the concepts and foundation of this term. While the host shelters the parasite, the parasite draws attention and interaction to the site. At first, a one-way benefit for the parasite, the symbiosis of the two begins to spark communities and commercialism within an existing urban area. Due to the tendency of Japanese railway companies to build their tracks above ground, there exists a new zone between the trains and the ground. This possibility allowed for the parasite, which drew more commercialism to a frequently used area, benefiting its host. Given (2021) adds:

“Focusing on how parasitic architecture has produced urban growth and development of a community within Tokyo as the primary case study, the reclassification is based on pre-existing architectural development and the nature of actual, living parasites. This reclassification of architectural parasites produces three separate types of parasites; the ‘structured,’ ‘symbiotic,’ and the ‘hyper transient.’ Through redefinition and reclassification, parasites in an architectural or urban planning context can then be manipulated as a tool for propagation within the existing built environment (Given 2021, 164).”

Another case study brought up by Given (2021) to distinguish parasitic symbiosis versus open parasitic architecture is the Shard and London Bridge Station. Unlike the Ameya-Yokochō case study, this case shows a community of parasitic additions with mutually beneficial and singularly beneficial examples. The Shard draws interest to the area and constantly attracts droves of people, acting as the general host. Symbiotically, the Bridge Station and restaurants used this influx of people to gain business and, in turn, further promote attraction to the site. To put it clearly, the Shard originates the interest; the symbiotic parasites use existing interest to develop a foothold and eventually become semi-hosts. The transient parasites come in to draw attention to themselves exclusively, rarely drawing people to the site as a standalone business and often detracting attention from the symbiotic relationship present. These stores, coffee shops, and hotels singularly benefit and fit into the more widely spread definition of a parasite. Similarly, Baroš and Katunský (2020) discuss how parasites fundamentally create diversity in their environments and either lead to the extinction of the host or stimulate the host's immune system and growth rate. This concept is also genuine for parasitic architecture, where the parasite diverts resources from the host and changes the energy flow through a system, altogether affecting the function of a building. On one side, a host building may lose attention to its parasites, but on the other hand, the parasitic additions may funnel more attention to the building. He also describes how when the scale is increased. Most architecture may seem to have parasitic expressions compared to the neighboring built environment. Baroš and Katunský (2020) put forward the idea of urban acupuncture as “the idea of micro intervention in the urban structure to improve the overall functioning of urban organisms.” The concept of urban acupuncture is to work in tandem with designers and the community to highlight areas of stress in the built environment accurately. Just as acupuncture eases tension in the body, urban acupuncture eases tension in the city. This acupuncture is slotting a system within an existing urban environment, specifically to be of aid, which classifies as parasitic symbiosis. This acupuncture can be defined as the urban porosity allows to shed light on the intricate interplay between the formation of urban form and its subsequent capacity to “include” diverse forms of urban life (Stevens 2020, 61). The parasite “respects the host and at the same time enriches it,” leading to a beneficial relationship (Baroš and Katunský 2020, 21). In this way, the fewer materials and more design-based approach focus on parasitic architecture could lead to the least negative impact compared to its benefit.

2.0 RESEARCH-DESIGN METHODOLOGIES AND STRATEGIES

With the provided background and literature above, this research reports and discusses the outcomes of a research-led architectural design studio conducted at graduate level at the Bauhaus university. The projects examine the spatial and experiential potentials of building resilient communities in port cities through parasitic architecture with a special focus on, adaptive reuse, resiliency, and application of integrated participatory design-to-production systems. This studio intended to explore the adaptability and resiliency in port cities at the forefront of climate change challenges, technological progress, and socio-economic paradigm shifts. The studio projects started by looking into port cities that need adaptive reuse and community resilience building. To respond to this urgent need, the theoretical framework of design studio focused on the spatial definition of ‘symbiosis’: where two organisms living in one system benefit from each other without any adverse effects (Kozłowski et al. 2020). This liminal, binary, and hybrid conceptualization of portcityscape would allow the port and the city to grow and expand to sustain the urban fabric without harming each other. Here the port infrastructures are defined as the material forms that allow for the possibility of an exchange over space. They are the physical networks through which goods, ideas, waste, power, people, and finance are trafficked (Larkin 2013). To keep and maintain the existing infrastructure while intensifying land uses and building the void, there is an urgent need to embody specific characteristics in the system to be more flexible and resilient in front of unexpected challenges and environmental threats. The parasitic architecture approach has been selected to decode and adapt to the existing infrastructure and create a new flow system juxtaposed with the current typology, aligning the need for creating resilient infrastructures and freeing the port city tensions (Mostafavi and Mehan, 2023). In this way, the idea of symbiosis and parasitic approach would allow for more sustainable infrastructural developments in port cities’ liminal spaces.

The studio design workflow has been framed around four scales: mega, macro, meso, and micro. In mega-to-macro scales, projects start with mapping site-specific port-related socio-spatial challenges and potentials and then continue with exploring layout design and developing modular systems that, by considering different user profiles, create interactions between portcityscapes and urban thresholds. Moreover, projects are looking into existing port infrastructures and waterfront thresholds as potential host contexts for parasitic architecture proposals. From the macro-to-meso scale, the projects are looking into environmental and structural performance analysis to effectively integrate into the host building and respond to site analysis and the surrounding hosts' facades for future extensions, additions, and development. In meso-to-micro scale projects are looking into material tectonic and circular and innovative design materialization strategies using local resources and communities. The following section will focus on four port city projects as part of the graduate level studio titled 'Cobotic Production of Resilient Communities in Port Cities' taught at Dessau Institute of Architecture at Bauhaus located in Amsterdam, Alexandria, Constanta, and Rio de Janeiro.

3.0 CASE STUDIES

In the following section, in four case studies, socio-spatial challenges in different port cities are highlighted, and corresponding solutions are explained. Additionally, each project has developed an integrated computational design workflow for participatory fabrication, which this paper will not discuss in detail. Descriptions are divided into two parts: background, where site-specific socio-spatial factors are identified, and design strategies to address the liminality and the threshold of port and city.

3.1. Amsterdam: Background

In the past, ports and their cities have seen substantial spatial change. Over time, both spatially and functionally, they became increasingly separated. The port has evolved from a distinct space to a single, fixed, and spatial entity. A Port is a place "where synchronic forces strive for common internal and external goals among a pluralistic port community" the case of Amsterdam shows that the Port Authority in Amsterdam is stabilizing the amount of land in the port area available for expansion of firms. At the same time, the Municipality of Amsterdam has a substantial target to build houses in the existing built-up area. In spatial terms, this means that while the expansion of the port area has stopped, urban development is gradually encroaching on the current and fixed harbor area. As a result, there are many challenges and conflicts over the land supply, future growth, and the development of the existing activities in the port city of Amsterdam, besides the environmental issues. The main aim is to study and design an adaptable parasitic architecture by providing a circular system for assembly and disassembly. This research brings new life into the portcityscape of Amsterdam through parasitic architecture.

Bearing the above-mentioned challenges in mind regarding densification and lack of available land for residential units, the location choice of the project is based on the critical transitions and mix-used development raised in Houthaven docklands in west Amsterdam. Houthaven was originally established as a trading hub and seaport in 1876 connected to the North Sea. Its contemporary look (with several modern buildings) contradicts that history. Houthavens is notable for its piers stretching out into the River IJ and the Pontsteiger building. The sites are typified by a mixture of old and new functions and structures, which makes the urban threshold unique in terms of the proximity of modern and historical textures.

3.1.1. 'Urban Plug-In' Project: Design Strategies

In response to the density of the site context, the starting point of design strategy was to find the most optimum unit model for future expansions. As the result, the truncated-octahedral unit was selected due to the number and type of faces (total 14 faces, 6 square faces, and eight hexagonal faces) and the three-dimensional growth and size variations. Thus, two main typologies of this unit have been addressed in terms of sizes and due to the functional spaces and their requirements in the Amsterdam port city interface. One cluster consisting of twelve modules in two different sizes was chosen for structural analysis and optimized the thickness variations of the timber beams for better performance and use of the material. Then, some mutated modules were added on the cluster to release the load and distribute it effectively to reduce the wide range of thickness between beams at the end.

Due to high radiation and view analysis, the passive external wooden skin system was introduced. This skin system is designed to minimize the effects of the sun on the modules and supports natural ventilation and energy consumption. The passive shading system reacts to the daily sun path to shade the interior of the modules from intense radiation. A wooden surface structure that adapts its porosity to changing humidity levels has been developed. While studying the pattern, the sun's radiance on each cluster's surface has been analyzed. As a result, the parasitic surfaces have been divided into two groups: the ones that get more radiance for responsiveness and those that get less radiance for fixed opening. Moreover, the cross-ventilation has been provided through the lower opening on one side and the upper on another in each module.

3.2. Alexandria: Background

Since antiquity, Alexandria has been the intellectual and cultural center of the region, and it is considered Egypt's second capital. For the study, the project site was chosen near the corniche, where most of Alexandria's contemporary port city challenges exist. The corniche is a waterfront promenade that runs along the eastern harbor, as one of the major traffic corridors in Alexandria. This site is occupied by buildings and industrial heavy infrastructures that have disconnected the people from the sea. This has resulted in overcrowding of people especially in the roads which have

access to the shore. Due to the lay of the land, rising sea levels, and constant erosions, the site is always under threat of being flooded by rain or high tides. Also, the dramatic uneven urban development along the shore caused saltwater intrusion, which contaminated the region's freshwater resources.

3.2.1. 'Upturned Jeopardy': Towards a Resilient Waterfront in Alexandria: Design Strategies

To achieve community participation and engagement in the design process, the focus of design strategies is co-creating a resilient port city community. A parasitic system that could spread through Alexandria was envisioned on the mega-scale. The first attempt was to create a growing system that could produce 'chaos' to show the port city's existing challenges. The component system has been suggested to make various alternatives and adapt to the context using a parasitic approach. The chaos was designed by point cloud to be adaptable and extendable to multiple contexts. The team optimized and evaluated the design process to assess the potential of adding more spatial constraints. As a result, the design process was initiated with a base grid based on zoning, program planning, and site access (Husar et al, 2023). In addition, this base grid has been defined to build the primary masonry concrete compression-only structure by simulating a funicular structure. In the next step, local artisans introduced a wooden frame using traditional shipbuilding techniques to enclose the space. As a result, an architectural living parasitic structure has been designed based on environmental, functional, structural, and societal factors.



Figures 1 & 2: Urban Plug-In Project, Houthaven, Amsterdam, The Netherlands. Source: Authors.

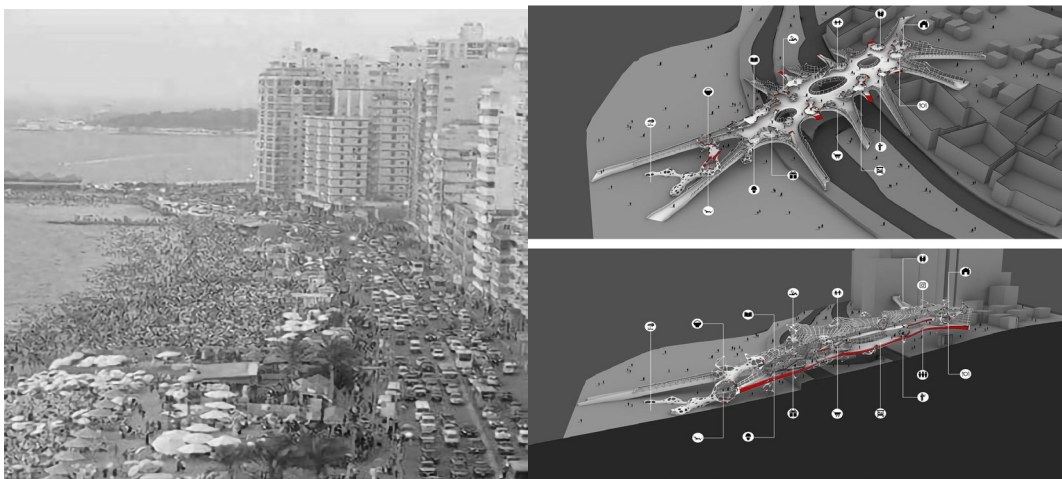

Figure 3 & 4: 'Upturned Jeopardy': Towards a resilient waterfront in Corniche, Alexandria, Egypt. Source: Authors

3.3. Constanta: Background

The Port city of Constanta, located on the East side of Romania, has become the subject of interest because of its favorable geographical position and the importance of its port, the largest on the Black Sea and the 17th largest in Europe. The location choice of the project was based on the particular interest in East European studies and the need for this historic port city's development strategies. Also, because of Constanta's numerous port city challenges such as migration, climate change and abandoned industrial sites and infrastructures, it gives room for various directions to choose and adapt improvement solutions. The site for the project is in the middle of Constanta, the part separated from

the rest of the city by railway connections but in close reachability from the main railway station; in the area, where a chaotic settlement of Roma people is based, currently surrounded mostly by abandoned post-industrial territories with leftovers of concrete silos previously used for oil storage.

3.3.1. 'Path of Roma' Project: Design Strategies

The project "Path of the Roma" was created as an answer to one of the crises points of Constanta, namely the discrimination of the Roma people community. A high amount of homeless people, their occupation of abandoned industrial and historical sites and buildings, and constant social conflict between the city and the ethnic groups make it a significant obstacle to Constanta's future development. The project's point is to create a space for Roma people where they can have their community and a particular lifestyle to sustain themselves, with the possibility of interaction with people outside of their community. The design idea lies in using existing silos and complementing them with parasitic parts to make the space habitable. Four silos of two types (600 m² and 300 m²) were selected as the focus of the project site. Inside and outside the silos, solid free-form geometries were created for the co-habitation of the Roma People community. Closed spaces with openings that have the function of doors and windows consist of 4 elevations of different planning and area sizes. Outside the silos, the semi-opened structure is created, represented as a path that will manage the flow of people's movement and spaces for interaction. The free-form wooden structure with a weaving basket-like pattern provides a temporary space for the Roma Community to adapt. The project has two types of parasitic systems: The first type of parasitic architecture is the Solid Spaces, which are the permanent areas that are 3d-printed with mud. For reinforcement, prefabricated wooden layers are milled with robots and provided in pieces. These parts are fabricated in the lab into chunks to be transported easily. The layers bear more as the structure is created with cross-laminated timber, while the other layers can be created out of recycled plywood. Small pickets are provided to develop spans between layers and space for the extruder to print the mud between them. As a result, the semi-closed area is created from a structure of frames and a weaving basket skin.



Figures 5 & 6: Path of Roma, empowering marginalized communities in the Port City of Constanta in Romania. Source: Authors

3.4. Rio de Janeiro: Background

Throughout Rio de Janeiro's development, this port city has experienced abrupt transitions to modern life, regulations, and constant changes in urban government. As a result of the uneven port city developments, a marginalized immigrant group couldn't find a place in the port city and built houses in slums called favelas. Largely ignored by local government, the favelas residents are defined as marginalized and underrepresented communities hence their basic needs, such as clean water, and employment issues, are left poorly attended to (de-Lima-Santos and Mesquita, 2021). The research for a parasitic architecture that could help the favelas was intended for this project, and Vidigal – a neighborhood and a favela in Rio De Janeiro close to the sea- was selected as a project site or a close scope. This overpopulated area has several flaws in that their houses are stacked on top of one another without proper construction methods and are disorganized. Lack of government intervention led to inefficient sewage systems, inaccessible potable water, electricity, and waste management systems. However, their strengths are that Favela occupants are survivors and highly independent. They could stack houses on top of one another by using local materials. Favelas are popular tourist places, and they capture several potential opportunities in agricultural and water-harvesting.

3.4.1. 'Cube Clouds of Rio' Project: Design Strategies

The parasitic design approach will likely adopt potential strengths and opportunities that this site holds, starting with a small pocket urban farm in the favelas that will envision multiple clusters of programmable urban areas in the future. This process flows in stages from analyzing the site potentials, sourcing supplies, construction on-site, local assembly,

and creating local job opportunities in this small economy of urban pocket farms. The 'Cubes of Rio' project proposes a programmable system for the participatory revitalization of marginalized favelas in Brazil's port city of Rio de Janeiro. With sets of user-driven inputs and quantitative environmental analysis data, the proposed system searches for multiple optimum solutions a customizable, aiming to turn research scarcity and socio-spatial challenges into opportunities for the regeneration and revitalization of favelas through urban farming.

The first step in executing design on the site is to create a solid base of the load-bearing capacity structure that connects to host buildings around the central pocket area. The base structure should act in a way that it appears as if it is 'engulfing' the host buildings. The application of the pavilion as a new layer in design is to provide shade for the urban farm, especially for the core circulation in the center of the urban farm. The distribution of the vegetation planter box is placed along the exterior wall of the parasitic units, which faces the sea, and on the ground planter box. These plants are classified by color codes of their ideal temperature habitat. The relationship with the agricultural production was designed based on 'Market Hall,' which is an opportunity to attract public attention and local communities to the site, benefiting economic and social sustainability. There are only four types of voxels throughout the design, categorized by their function. The overall design is based on applying these four sizes of voxels to create a principal uniform format, making variety in a uniform method. Water catchments are being placed on the top of the pavilion voxel, a perfect site to collect the rainwater and storm water as it goes down the pavilion and will be directed to the main pipe towards ten units of water tanks. This method is cost saving in production and maintenance, making it feasible and sustainable.



Figures 7 & 8: Cubes of Rio: Programmable and participatory design to production systems in Vidigal favela neighborhood, Port City of Rio De Janeiro, Brazil. Source: Authors

CONCLUSION

Through the different case studies, a new spatial typology is designed and analyzed through a parasitic architecture approach to resist the existing conflict and show the hybridity beneath the port and city relationships. By focusing comparatively on four port cities, including Amsterdam, Constanta, Alexandria, and Rio De Janeiro, this research represents the parasitic architecture approach to tackle the existing contemporary challenges and build resilient communities in liminal spaces of port cities (Mehan 2022). In addition to the work presented in this paper, a series of one-to-one prototyping exercises were conducted as supplementary research in a course called "Cobotic Matters." The outcomes of these exercises are examined in a separate paper that specifically addresses the technical and methodological aspects of human-robot collaborations (Mostafavi et al., 2023). While the parasitic systems in Amsterdam and Alexandria's projects responded to the densification and space scarcity in the historical port city and liminal spaces developments, Rio de Janeiro and Constanta's design strategies mainly focused on responding effectively to the local community needs and urgencies within the favela neighborhoods and Roma People community. Using the comparative and analytical frameworks, parasitic architecture in this article is represented as a transitional form in liminal port city space associated with integrating and adapting new structures into existing buildings and infrastructures. The results of this research introduce an integrative and multi-scalar adaptive framework for building resilient communities in liminal spaces of port cities across different contexts.

ACKNOWLEDGEMENTS

This research is the outcome of a graduate level studio titled 'Cobotic Production of Resilient Communities in Port Cities' led by Sina Mostafavi taught at Dessau Institute of Architecture at Bauhaus in 2020. We would like to give special recognition to Duygu Çöplü, Wasimul Alam and Bibi Najwa (Rio De Janeiro team), Alia Yaseen, Mehrnoush Nabizadeh,

Hekuran Musli, and Shahriar Mannan (Amsterdam team), Hosam Abdelghany Mahmoud, Ibrahim Elhakim and Loay Abdelmotaleb (Alexandria team), Kateryna Kapushchak, Tannaz Balazadeh, Ali Etemdai and Sayan Chatterjee (Constanta team).

REFERENCES

- Baroš, T. and Katunský, D. (2020). "Parasitic architecture" *Selected Scientific Papers - Journal of Civil Engineering* 15(1): 19-28.
- Bentley, I., Alcock, A., Murrain, P., McGlynn, S., & Smith, G. (2007). *Responsive Environments: A Manual for Designers*. Taylor & Francis.
- Dahl, J. (2019). "Agents of Change in a Changing World: Treaty Port Nagasaki and the Limitations of Local Resilience." *Journal of Urban History*.
- De Lima Santos M.F. & Mesquita L. (2021): Data Journalism in favela: Made by, for, and about Forgotten and Marginalized Communities, *Journalism Practice*
- Degen, M., & Garcia, M. (2012). The transformation of the "Barcelona model": An analysis of culture, urban regeneration, and governance. *International Journal of Urban and Regional Research*, 36(5), 1022–1038.
- Fard, H. R., & Mehan, A. (2018). Adaptive reuse of abandoned buildings for refugees: lessons from European context. *Suspended Living in Temporary Space: Emergencies in the Mediterranean Region*, 5, 188.
- Fleming, J., & Ledogar, R. J. (2008). Resilience, an evolving concept: A review of literature relevant to aboriginal research. *Pimatisiwin*, 6(2), 7–23.
- Garcia, P. R. (2019). "The Lisbon Waterfront: Perspectives on Resilience in the Transition from the Twentieth to the Twenty-First Century." *Journal of Urban History*.
- Given, D. (2021) "Developing parasitic architecture as a tool for propagation within cities," *Journal of Architecture and Urbanism* 45(2), pp. 164–170.
- Hauser, S., Zhu, P., & Mehan, A. (2021). 160 Years of Borders Evolution in Dunkirk: Petroleum, Permeability, and Porosity. *Urban Planning*, 6(3), 58-69.
- Hein, C. (2016). Port Cityscapes: conference and research contributions on port cities. *Planning Perspectives*, 31(2), 313-326.
- Hoyle, B. (2002). 'Fields of tension. Development dynamics at the port city interface', in David Cesarani (ed.), *Port Jews in cosmopolitan maritime trading centers, 1550–1950*, 14.
- Husar, S.C.V., Mehan, A., Erkan, R., Gall, T., Allkja, L., Husar, M., & Hendawy, M. (2023). What's next? Some priorities for young planning scholars to tackle tomorrow's complex challenges. *European Planning Studies*. Advance online publication. <https://doi.org/10.1080/09654313.2023.2218417>
- Kratke, K.W. & Lanz, S. (2012). *Transnationalism and Urbanism*. London: Routledge.
- Kozłowski, M., Mehan, A., & Nawratek, K. (2020). *Kuala Lumpur: Community, infrastructure, and urban inclusivity*. Routledge.
- Larkin, B. (2013). The politics and Poetics of Infrastructure. *Annual Review of Anthropology*. Vol. 42 pp. 327-343.
- Mehan, A. (2022). *Tehran: From Sacred to Radical*. Taylor & Francis.
- Mehan, A., Nawratek, K., & Tahar, F. (2022). Beyond Community Inclusivity through Spatial Interventions. *Writingplace*, (6), 136-147.
- Mehan, A., & Mostafavi, S. (2022). Building Resilient Communities Over Time. In *the Palgrave Encyclopedia of Urban and Regional Futures*. Palgrave McMillan.
- Mehan, A., & Mehan, M. (2022). Conceptualizing the Urban Commons. In *the Palgrave Encyclopedia of Urban and Regional Futures*. Palgrave McMillan.
- Mehan, A., & Abdul Razak, R. (2022a). Oil Heritage in Iran and Malaysia: The Future Energy Legacy in the Persian Gulf and the South China Sea. In *New Metropolitan Perspectives: Post COVID Dynamics: Green and Digital Transition, between Metropolitan and Return to Villages Perspectives* (pp. 2607-2616). Cham: Springer International Publishing.
- Mehan, A., & Abdul Razak, R. (2022b). LA FUTURA EREDITÀ ENERGETICA NEL GOLFO PERSICO E NEL MAR CINESE MERIDIONALE: IL CASO DEL PATRIMONIO PETROLIFERO IN IRAN E MALESIA. *LaborEst*, (24), 57-63.
- Mehan, A., & Abdul Razak, R. (2022c). After oil: what Malaysia and Iran may look like in a post-fossil-fuel future. *The Conversation (France)*, 1-6.
- Mehan, A., & Jansen, M. (2020). Beirut Blast: A Port City in Crisis. The Port City Futures Blog. Leiden. Delft. Erasmus (LDE) Initiative.
- Mehan, A. (2020). The Port City's 'Cine-scapes'. The Port City Futures Blog. Leiden. Delft. Erasmus (LDE) Initiative.
- Moretti, S. (2019). Portuality: Conceptualizing the spaces of global connectivity. *Journal of Urban Design*, 24(2), 187-206.
- Mostafavi, S., Kemper, B. N., Kretzer, M., Etemadi, A., Mahmoud, H. A., Yaseen, A., Nabizadeh, M., Balazadeh, T., & Chatterjee, S. (2023). Cobotic Matters – Collaborative Robots and Discrete Assembly Design: From Stacking to Self-Interlocking of Reciprocal Components. In I. Koh, D. Reinhardt, M. Makki, M. Khakhar, & N. Bao (Eds.), *HUMAN-CENTRIC - CAADRIA*, Ahmedabad, (pp. 241-250). <https://doi.org/10.52842/conf.caadria.2023.2.241>
- Mostafavi, S., & Mehan, A. (2023). De-Coding Visual Cliches and Verbal Biases: Hybrid Intelligence and Data Justice. In *De-Coding Visual Cliches and Verbal Biases: Hybrid Intelligence and Data Justice* (pp. 320). Wiley.

- Repellino, M. P., Martini, L., & Mehan, A. (2016). Growing Environment Culture Through Urban Design Processes 城市设计促进环境文化. *Nanfang Jianzhu*, 2(2), 67-73.
- Russo, M. (2016). *Harbourscape: Between Specialization and Public Space*. In: Carta, M., Rounsaville, D. (eds) *The Fluid City Paradigm*. Springer, Cham.
- Stevens, J. (2020). Urban Porosity: a chronicle of spatial inclusion in Matonge, Brussels. *Journal of Urbanism: International Research on Placemaking and Urban Sustainability* 15(1), 61-83.
- Teschner, N. (2018). The battle over commons in port cities. *Urban Geography* 40 (7), 918-937.
- Westerdahl, C. (1992). The Maritime Cultural Landscape. *International Journal of Nautical Archaeology* 21, no. 1: 5-14.

Sensitive Cultural Site as Center for Community and Education of Older Adults

Mary English¹

¹Auburn University, Auburn, AL

ABSTRACT: An organization which provides individuals over the age of 50 with opportunities for community and learning is interested in expanding their facilities on their existing site. The site is a sensitive cultural site, a former plantation which utilized enslaved laborers. The site, program and client for this second-year undergraduate studio project are real. The studio has run for 3 semesters and collected various typologies as answers to these nuanced questions. The team of faculty has honed various approaches to guide the beginning design students through this complex project.

To guide the students to an appropriate solution, the analysis of good precedents was essential. One precedent analyzed was David Chipperfield's Neues Museum which was selected for its historical context coupled with a program with certain characteristics. The program of this precedent is a museum however the content of the museum was unrelated to the history of the site. The question of what program is appropriate for a former plantation was addressed. If what was being designed was a memorial the narrative would be an inherent part of the design. Instead, the program was an educational facility so narrative is not necessarily a part of the design. A conceptual precedent was selected from the art world to provide conceptual ideation and vocabulary. That precedent was Guido Guidi's photographic series of the Brion Cemetery by Carlo Scarpa.

KEYWORDS: Beginning Design, History, Racial Justice, Social Context, Narrative in Design, Conceptual Precedent

INTRODUCTION

An organization which provides individuals over the age of 50 with opportunities for community and learning is interested in expanding their facilities on their existing site. The site is a sensitive cultural site, a former plantation which utilized enslaved laborers. The site, program and client for this second-year undergraduate studio project are real. The studio has run for 3 semesters and collected various typologies as answers to these nuanced questions. The team of faculty has honed various approaches to guide the beginning design students through this complex project.

The site is a sensitive landscape and context with an old pecan grove, rolling hills and a house, an antebellum Greek Revival style cottage built circa 1850. Other plantations in town have undergone renovation without consideration for their history. Our faculty hoped to guide the students through a process of exploring various approaches to building the campus that includes the existing house in a way that recognizes the nature of its history. As architects, we take the thread from the past, with all that this implies, we design and build for our current use with the knowledge that what we build will continue to exist in a future context.

Taking students through the design process means guiding the students to determine what is an appropriate response to the context. Analyzing precedents proved useful in a variety of ways, one of which is the relationship of the program to the history of the existing site. Another use of precedent was in clarifying the conceptual approach. The precedents also facilitated a conversation about the role of narrative in the design.

1.0 GUIDING STUDENTS THROUGH THE DESIGN PROCESS

1.1 Guiding Students Through the Design Process

When I guide the students through the design process, I am aware of how much to guide and how much freedom to let them find their way. This is particularly important in guiding them to propose a response to a historically sensitive site. With a typical student project, I would not give the student enough freedom to make an ill-considered design, I feel it is my job to give them stronger guidance than that. Likewise, I would not give a student freedom in this project to make an ill-considered or insensitive response to the questions posed by this historically sensitive site. To guide the students to an appropriate solution I need to know what I feel is an appropriate solution. A good precedent is useful, I can read what the architect says about their intentions for the project and see if their ideas are applicable to the project that I am considering. There are many memorials and museums that are built at historically significant sites but in this case the program of the project is not related to the history of the place, which is a significant difference. This results in some ambiguity as to what is appropriate.

1.2. Precedent Research

One precedent that I found to be useful was the renovation of the Neues Museum in Berlin by David Chipperfield. While it is a museum, the materials that are on display are not directly related to its history. The Neues Museum was constructed in Berlin to house the expanding collection of pre-history, early human civilizations, and the Egyptians collections of the Altes Museum. The Neues Museum was heavily damaged during World War II and sat for over half a century for multiple reasons including financial constraints. David Chipperfield was awarded the commission to reconstruct the museum. Chipperfield worked closely with architects that specialized in restoration. Some elements were perfectly restored, some elements retained their characteristics of partial ruin, and some new elements were constructed. The museum has clear legible evidence of the physical and social operations from the past. The additions are clean, light and simple and this enhances the antiquity of the existing situation. The museum is a merging of old and new, arrested decomposition and minimal insertions. The attitude towards the existing situation is neither mournful nor celebratory but it is in dialogue with the insertion of contemporary elements to read as a whole.

1.3. New Dialogues with the Existing Situation

In the book *Thinking Architecture*, Peter Zumthor states,

Every new work of architecture intervenes in a specific historical situation. It is essential to the quality of the intervention that the new building should embrace qualities which can enter into a meaningful dialogue with the existing situation. For it the intervention is to find its place, it must make us see what already exists in a new light. We throw a stone into the water. Sand swirls up and settles again. The stir was necessary. The stone has found its place. But the pond is no longer the same. (Zumthor, 2010, 26)

The students explored a variety of different approaches for dialoguing with the existing house. As Zumthor said, "For if the intervention is to find its place, it must make us see what already exists in a new light." (Zumthor, 2010, 26) The students were adding several buildings to the campus. In consideration was scale, roof profile, site circulation to name a few characteristics. More than knowing how to dialogue with the existing plantation house, some expressed ways they knew were not appropriate. They said that they did not want to put the existing house on a pedestal by placing the other structures in a way that focused the visitor's attention on the existing house. Students were deterred from mimicking the architecture of the house, which is a questionable design motivation, this is especially true in this case. They could not deny its existence, but they should not exalt its history.

In the precedent David Chipperfield had a way to show the history of the building which was through keeping some evidence of the damage and ruin. If one wanted to have the narrative of the former plantation the only remaining physical evidence is the house. To add something that was previously there to fulfill the narrative is insensitive. To rebuild something that was there previously would constitute either mimicking or exalting. Zumthor says, places and landscapes act as memory banks and an architect should actively interpret the memory stored in these landscapes to design that would be responsive beyond the spectacular form. (Zumthor, 2018, 32)

1.4. Appropriate Program

For the question of program that is appropriate for a former plantation, I can say what I know is inappropriate. There is a former plantation in town that has been renovated to host events, especially weddings. This sends a clear message that the suffering of the black population is something to be erased or celebrated.

The program that was being proposed by the Osher Lifelong Learning Institute (OLLI) was a place of education, a place to seek new knowledge. This program means rather than erasing the history of the plantation, it would be one of the subject areas taught to the people using the facility. There is the opportunity (and the responsibility) to acknowledge the history through education. So if the narrative is not communicated through the design how can the designer design an appropriate response to a site of historical sensitivity. If what was being designed was a memorial the narrative would be an inherent part of the design. Because narrative is not a part of the design the experience is what remains. The narrative is not always accurate or truthful, but the experience could offer something meaningful to the visitors. Narrative can be problematic as any information that is not included in the narrative makes it untruthful. If it is appropriate to tell the story it is necessary to tell the full story. Another consideration about including narrative in design is that including it changes the experience of the built work.

1.5. Without Narrative

Photographer Uta Barth says,

Narrative in art makes us think about all sorts of interesting things, but it derails the engagement with a visual experience. Narrative asks for interpretation, for us – to spend our time making meaning out of what we are looking at. Narrative seems a quick and easy diversion from the difficult and more interesting challenge and adventure of actually trying to see. (Olivares, 2007, 87)

So applied to this project there is an opportunity to communicate something more nuanced than the narrative of the history of the site. The visitor can experience the built work more directly without the need to interpret the narrative. Does a visitor to a place, pass through the built work as an artifact? Or does the visitor's experience and dialog with a place influence them in a less superficial way? I imagine it depends on the nature of the built work. I believe that encouraging the students to think about these questions for their design is taking the history of the site and working with it to help them arrive at a more sophisticated solution.

1.6. Precedent – Conceptually Driven Interrogation

Precedents from the world of art can be clearly legible with respect to conceptual ideas. When selecting a precedent from the art world, selecting one that has been described by the artist and has been analyzed by theoreticians is important. The precedent is then understandable and useful in other contexts. Architects gain perspective when analyzing a subject outside of the world of architecture. Artists and art theoreticians work conceptually as a central principal of their process. The conceptual precedent that was used was a series of photographs taken over a decade by the Italian photographer Guido Guidi whose subject was the Brion Cemetery by Carlo Scarpa (Figure 1). Conceptually the series of photographs do not tell a story rather they set the stage for questioning and reflecting. For this reason, the series is a strong conceptual precedent for the studio project.

Antonello Frongia said of the photographs,

In spite of their apparent anonymity, Guidi's photographs always imply the subjectivity of both the artist and the viewer, each being engaged in a conceptually driven process of interrogation. Like Scarpa's architecture, to borrow Francesco Dal Co's illuminating words about the architect's work, Guidi's photography "manifests the memory and arrests the gaze at the instant when the question emerges" (Frongia, 2011, 30)

The author discusses how light, color, form and space and time can serve conceptually. The idea can apply directly to the design process of the studio project.

Guidi's photographs conceptualize similar issues of light, color, form, space and time that are implicit in Scarpa's architecture. Developed as series, they defy the immobility of the image and the monumentality of architecture in the attempt to deconstruct the architect's formative process and to carve out a space of contemplation for the viewer.

To generate an impulse to see, to create space for contemplation of form and space, these are formidable goals but will take the design exploration in a positive direction.

There are no better words with which to speak of Guidi's attempt to photograph the Brion Cemetery as a space of perduring life. This visual field is never static, never definitely beheld; rather, it generates an impulse to see, which places the viewer both outside and inside the scene. (Frongia, 2011, 28)

The Brion Tomb and Guido Guidi's series of photographs are conceptually similar. They do not present a story but rather invite one to engage in an interrogation. They are said to leave space for contemplation. In this way they are conceptual precedents for the studio project.



Figure 1 Guido Guidi, Preganziol, 1983, C-prints, 18.3x18.5 cm each. Source: (Frongia, 2011)

CONCLUSION

Our team of faculty questioned ourselves as to whether we were asking too much from a beginning design student. Just solving the program on the site without the historical context was already a big challenge. Also, the community being served by the facility were from a different time and place than that of our architecture students and faculty, further complicating the dynamic. Our conclusion was that to not include the historical context would be to condone forgetting. There is no level of education that fully prepares one to incorporate the complexity of historical context such as a former plantation, so better to allow these questions to be part of the conversation from the beginning.

Faculty members met with the directors of the organization and formulated a program that would meet their needs. The students had the opportunity to meet with the directors and understand their desires and ask questions about the organization. The director provided the students with insights into the needs and desires of the community. The program, although it was not determined by us, was the subject of a discussion with the students as to what programmatic characteristics are appropriate for a culturally sensitive site. We came to the conclusion that there are some programs, such as a wedding venue, that does not leave space for the reflection of the difficult history while other programs, while not narrating the history, lend themselves to the conceptual ideas that recognize the built work in dialog with its past and with its future.

The use of precedents as a framework to understand some specific ideas was a good lesson for the students. Students often feel that they need one perfect precedent but it is often beneficial to use multiple precedents to understand different things. The students and faculty also learned how to talk about a history that we are not adept at discussing

and are not sure about what is an appropriate response. Each student found a way to answer the difficult design questions through decisions based on conceptual ideas that do not forget the history but do not narrate the story.

There were many threads of exploration that came directly or indirectly out of the sensitive nature of the history of the site. The use of precedents was essential to the successful process of guiding the students through the design process. The precedent of the Neues Museum by David Chipperfield was selected because the existing situation and history were not to be forgotten, however, the museum was not full of objects that tell that story. The program was not related to the history of the place. The design gave students a good example of how inserting something new into an existing situation can enhance/change the existing elements. The precedent was central in conversations with the students about the concept of not relying on narrative for their design. Reading what architects, artists and theoreticians wrote about their subjects provided the vocabulary and conceptual foundation for our conversations.

The conceptual precedent of the photographic series of the Brion Cemetery by Guido Guidi was also effective for the students to understand an approach different than narrative. This precedent was an example of how the series of photographs provoked a response of reflection or interrogation. Without a clear precedent this would be more challenging for the students to understand.

ACKNOWLEDGEMENTS

I would like to acknowledge the other faculty that lead the students through the design studio project described in this paper. From the Spring Semester of 2020 the faculty are Deborah Ku, Joanna Bidani, David Kennedy and Robert Sproull. For the Spring Semester of 2021 the faculty are Deborah Ku, Kevin Moore, David Kennedy and Anthony Tindill. I would also like to acknowledge the director of the Osher Lifelong Learning Institutes (OLLI) organization, Scott Bishop.

REFERENCES

- Dal Co, F. , Mazzarion, G. 1984. Carlo Scarpa: The Complete Works. Milano/NY: Electa/Rizzoli
- Francesco Dal Co, "The Architecture of Carlo Scarpa," in Carlo Scarpa: The Complete Works, p. 37
- Frongia, A. 2011. Guido Guidi: Carlo Scarpa's Tomba Brion. Ostfildern, Germany: Hatje Cantz Verlag
- Frongia, A. 2011, Everything Becomes True in the Light of Sun: Carlo Scarpa and Guido Guidi at San Vitodi Altivole. Ostfildern, Germany: Hatje Cantz Verlag
- Olivares, R. 2007. Exit –Image & Culture– Through the Window. Madrid: Olivares & Associates, S.L.
- Zumthor, P. 2006. Atmospheres : Architectural Environments, Surrounding Objects. Basel, Switzerland: Birkhäuser.
- Zumthor, P. 2010. Thinking Architecture. Basel, Switzerland: Birkhäuser.
- Zumthor, P. Lending, M., Binet, H. 2018. A Feeling of History. Translated by Esther Kinsky. Zürich: Scheidegger & Spiess.

Social Currency: Alternative Home Economics

Gabriel Fries-Briggs¹, César A. Lopez¹

¹The University of New Mexico, School of Architecture + Planning, Albuquerque, NM

ABSTRACT: Central and branch banks play a significant role in shaping neighborhoods by determining who has access to capital and who does not. Banks and financial policy have created unequal investment, and disinvestment, in communities through redlining, blacklisting, and price discrimination. However, if we take a bank not just as a financial institution but as the container of community assets and resources, what role can 'banking' play in sustaining access to homes and home ownership? How can a home be reformatted to share or exchange resources fueled by communal solidarity?

This paper unpacks a graduate design-research studio taught at the University of New Mexico, School of Architecture + Planning (UNM SA+P) called *Social Currency*, which explored how alternative forms of managing economic, environmental, and housing assets can instigate new architectural typological models of the *bank* and the *home*. The category of 'alternative economies' refers to a loose constellation of production, exchange, and consumption processes that differ from dominant or 'mainstream' forms of capitalism, many of which draw on historically suppressed and non-Western economic systems. The studio focused on sites of alternative economic structures in the home and shared resources via new forms of supportive banking.

The projects in this studio are situated in the city of Merced in the California Central Valley, which is rooted in agricultural production and produces roughly one-quarter of US food by exploiting its environment, resources, and migrant labor. By examining the role that architecture can play in supporting the management of assets across homes and communities in this context, this graduate research studio explored models for sustaining housing-based infrastructures of solidarity. This paper presents grounded research speculations that untether the architectural production, speculation, and education from dominant economic models to rethink established housing and banking typologies—not through capital and profit—but through social and environmental value.

KEYWORDS: Alternative Economies, Institutional, Housing, Pedagogy, Community

INTRODUCTION

Driving down the California Golden State Highway, the distance between Los Angeles and the Bay Area gives one a clear sense of the state's other working populations and industries. Clusters of small towns, oil fields, logistic centers, and agricultural fields string along the highways and make up the landscape between California's two more emblematic ends. At the center is the city of Merced, a low-rise city entirely dwarfed by the Sierra Mountains, which act as an eastern backdrop. Its small grid-street core—filled with busy strip malls, box stores, fast food joints, and gas stations—abruptly transitions to long internal spine suburban streets, lined by bungalow-style homes situated on long-fenced parcels pushing up against the agricultural fields (USGS 2022). This geography draws a clear contrast from the coastal areas emblematic of California. While the coastal side of the states is a major hub for technology, entertainment, and tourism, the Central Valley is responsible for the growth and distribution of roughly a quarter of the nation's produce. And yet, the interdependencies the Central Valley shares with the rest of the state and the country contribute to the exploitation of its environment, resources, and populations alike. This paper presents studio design research and a pedagogical approach that untethers architectural production, speculation, and education from dominant economic models by asking students to rethink established architectural typologies—not through the lens of capital and profit—but through social and environmental value in Merced, CA.

1.0 STABILIZING INDUSTRY WITH PRECARIOUS WORK

While geographically remote, the Mexico-United States Border determines the city of Merced's demographics and economy. The United States has codified foreign workers into the California Central Valley's agricultural industry to combat labor shortages that began in the World War II era. Policies and agreements like the Braceros Program and the Emergency Farm Labor Program encouraged Mexican workers to cross open borders to ease labor shortages that jeopardized the farm industry. Despite these programs requiring worker registration and permits, this influx of laborers effectively increased legal and illegal immigration (Gutiérrez 1995). While many of these initial programs were terminated by the mid-1960s, policies such as the 1986 Immigration Reform and Control Act continued to make unsanctioned immigration of Mexican laborers—legal or otherwise—possible in the agricultural industry should a labor shortage emerge (Committee on the Judiciary 2007).

Today, what began as a policy designed to mitigate high industry demands with low-paid jobs has transformed the demographic composition of areas like Merced County and other cities in the Central Valley. The subsequent generations of undocumented migrant farmworkers have sustained the agricultural industry with cheap labor. An estimated ten percent of Merced's population are unauthorized immigrants. Nearly a quarter of children residing in Merced have at least one unauthorized immigrant parent, setting up a generational cycle of poverty. While facing political and economic precarity, immigrant populations are often deeply rooted in their communities. Nearly half of the immigrants in Merced have been members of their communities for over a decade (Marcelli and Pastore, 2022). Within this narrative of economic precarity, it's important to note the history of activism and worker mobilization embedded in the California Central Valley. In the 1960s and 70s, the area was a center of activity for the National Farm Workers Association. This partly explains how the region continues to be a destination point for farm workers and seasonal laborers seeking work and refuge. According to the National Center for Farmworker Health, 20,000 farmworkers reside in Merced County, half of which are undocumented (National Center for Farmworker Health 2021). In many ways, the city of Merced and its people have been the agents for transformative social movements, challenges to exploitative economic models, and self-determined structures of solidarity.

Despite the politically charged debate around legal and illegal immigrant workers, this population is a welcomed sight for the agricultural industry in dire need of affordable labor to sustain itself in an economy with rising demands and production costs. Unemployment, lack of access to healthcare, and food deserts are widespread within the population and geography vital to the agricultural industry and the country's food supply. The exploitation and depletion of one geography's environment, resources, and labor force to sustain distant markets and economies are symptomatic of capitalism (Moore 2016). These issues provoke the following urgent questions: how can alternative economic models support the Central Valley's most valuable assets and people? What established typologies might be reconfigured to structure solidarity and economic empowerment by our discipline? This studio argues that an alternative economy re-envisioned by new architectural models for the home and the bank can support this community and engage its organizing history.

2.0 ALTERNATIVE ECONOMIES

The category of 'alternative economies' refers to a loose constellation of production, exchange, and consumption processes that differ from dominant or 'mainstream' forms of capitalism (Healy 2020). The basis for many alternative economic models is not new and draws on pre-capitalist, historically suppressed, and non-Western economic systems. However, these models have received expanded attention, particularly in relation to growing inequality, awareness of intersections of capitalism and racism, and environmental degradation. International social movements like the solidarity economy, credit commons, commodity regionalism, and the rapid rise of mutual-aid groups during the COVID-19 pandemic address human needs for provision and care, reciprocity and democratic values, and collective action (Bauhardt 2014) while redefining economics in ways that take account of the environment (Emmett and Nye 2017).

Acknowledging that, as Manfredo Tafuri described it, "the fate of capitalist society is not at all extraneous to architectural design" (Tafuri 1976, 179), how can architects learn from meaningful infrastructures of sharing to destabilize the discipline's relationship to the harmful effects of economic systems? As the socio-ecological crises of California's Central Valley stem in part from the nexus of cheap labor and cheap nature (Moore 2016), what can we learn from economic alternatives that foster social equity and reduce environmental exploitation? How can we conceive of an architectural project that, in turn, sustains these economic models? The potential for learning from alternative forms of managing economic, environmental, and social assets to instigate new architectural typologies for the *bank* and the *home* was the basis for the graduate research studio *Social Currency*, a graduate design-research studio taught across two sections at the University of New Mexico, School of Architecture + Planning (UNM SA+P) in the Fall of 2021.¹

3.0 BANKING ASSETS AND HOME ECONOMICS

Central and branch banks shape neighborhoods by determining who has access to capital and who does not. Banks and financial policy have been instrumental in creating an unequal investment, and disinvestment, in communities through redlining, blacklisting, and price discrimination. While the number of unbanked households (in which no person in a household has a checking, savings, or money market account) has been cut in half over the past fifteen years, 4.5% of households remain unbanked, and an additional 14.1% are underbanked (FDIC 2021). Immigrant populations are much less likely to be connected to mainstream financial services. Whereas 76 percent of US native-born household heads have a checking account, only 63 percent of immigrant household heads have a checking account (Brookings 2006). The share of undocumented immigrants with access to mainstream banks and financial services is significantly lower, with bank account ownership of undocumented immigrants from Mexico at only 7% of household heads (Chin 2011). Financial access is an indicator of the overall economic and social well-being of a community (Brookings 2006), with limited access perpetuating economic instability and precarity. While credit unions and community land trusts have made advancements in equity sharing and access to ownership, the relationship of homes to corporate capital accumulation and financial instruments has remained largely intact despite its role in the 2008 financial crisis. However, if we take a bank not only as a financial institution but as the container of community assets and resources, what role can 'banking' play in sustaining alternative economies? How would new economic systems reformat the home from a political unit and social container to a communal realm grounded in solidarity?

Researching along the lines of these questions, students investigated how banks and homes could sustain different distributions and experiences of shared resources. The studio started with a transcalar spatial study of economic assets and systems that often tether resource banking and the home. These assets ranged from tangible to intangible: *agriculture, art, atmosphere, capital, food, habitat, power, childcare, technology, time, and water*. These studies bridged the bank and home studio sections by pairing a student from each to examine how the asset formats domestic space; and how it can be managed as a community resource or banked. These assets were unpacked through a series of techniques that mapped them through time and space to find moments where new architectural devices can increase access for vulnerable populations in the Merced area. It was also important to focus on techniques for how non-architectural subjects could be unpacked through architectural and urban mapping, giving way to the interdisciplinary use of their skills.

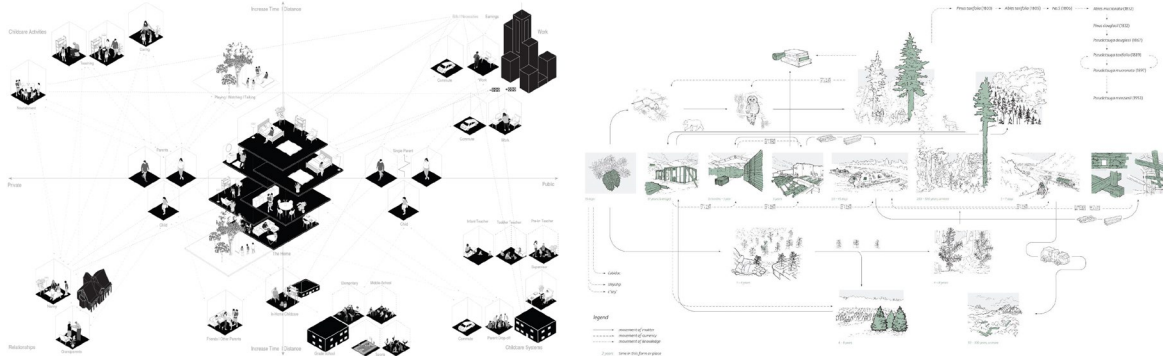

Figure 1: On the left is a mapping of spaces, labor, and value associated with childcare networks by Courtney Begay and Fatemeh Jafari. On the right are the economies and ecologies of Douglas fir habitats by Emily Griffin Kim.

Students structured each analysis relative to alternative economic models, like the solidarity economy, to develop their definition of assets between commodities (produced for sale) and commons (produced to be shared). Within this framework, Courtney Begay and Fatemeh Jafari studied the various formats of childcare and the dependent labor and spaces. The study revealed childcare as an asset requiring overlapping negotiations of time, space, and dependent networks, establishing perimeters for intervening in economies of childcare. The intent was for students to leverage an understanding of the asset to frame collateral groups and their environment to position the need for intervention outside traditional access to capital. While some assets are inherently human-oriented, others can be traced through pluralistic habitats, geographies, and temporal scales. Emily Griffin Kim's map of Douglas fir traced the agency of the tree's matter to organize economies as it moved from forest ecology to mill, building industry, and landfill (Figure 1). Over the course of the material's lifespan, Douglas fir performs as both captured carbon and captured assets capable of being banked in the form of real estate, matter, and infrastructures of life-making (Bhattacharya 2019).

This pedagogical approach effectively removes the *client* as a looming and subjective presence from the studio; students could explore the asset and any collateral groups stemming from its labor or consumption as their subjects. As Daniel Abramson suggests in his study of obsolescence, for contemporary architecture to work under capitalism, "The architect would try to do more than serve for a brief time a building's legal and economic owner. She or he would instead try to sustain the building's usefulness and meaningfulness throughout its life, for its inhabitants, for its community, and for its society" (Abramson 2012, 169). While redefining the notion of client and client relationship in the studio is often a productive space for reimagining architecture and equity, this framework shifts focus from the economic model through which a building is made to the economic model and assets that a building sustains. In this way, speculation and problem-posing are open to a broader and more portable set of challenges organized around assets and economic inequality, public health, environmental justice, and climate change, ultimately allowing students to identify new constituencies through the following threads of work. Two primary themes emerged as students began to propose new models for the bank and home—collectivizing aid and infrastructures of solidarity.

4.0 THE BANK: COLLECTIVIZING AID

Within the range of models considered within alternative economies, mutual aid often addresses explicitly local forms of care and support. A central tenet of mutual aid in many definitions is that it does not function according to a logic of morality (Red Bloom Communist Collective 2021), avoiding saviorism and "decolonial" fetishism" (Benally 2020, 190), and emphasizes social movements demanding transformative change beyond survival (Spade 2020). Indigenous Mutual Aid, in particular, challenges "charity" models of organizing that treat communities as "victims" and rejects the non-profit commodification of mutual aid (Indigenous Mutual Aid and Indigenous Action 2009). In the context of Merced, support is collectivized through groups like the Merced County Immigrant Relief Fund, Pop-Up People's Pantry, and the Central Valley Mutual Aid / Ayuda Mutua del Valle Central. The systems of care mobilized by existing networks formed a basis for students to develop spatial frameworks that promote resource sharing and well-being. Before articulating these frameworks at a larger scale, students designed moments of "transaction" in which commons of

mutual aid displaced monetary transactions. Oliver Holmes’s artist-run cafe deploys a table as a continuous trade and provisions infrastructure to meet immediate and long-term needs (Figure 2). The table operates at a scale between furniture and building, spatializing an everyday site of gathering, communalism, and exchange. The large open space on the lower right serves as the kitchen in which labor-time is an exchanged good that feeds the art bank as well as distributes meals to local communities. Food, books, and supplies are freely shared within the larger project of an ‘art bank’ that distributes revenue to its contributors and structures mutual aid for local populations.

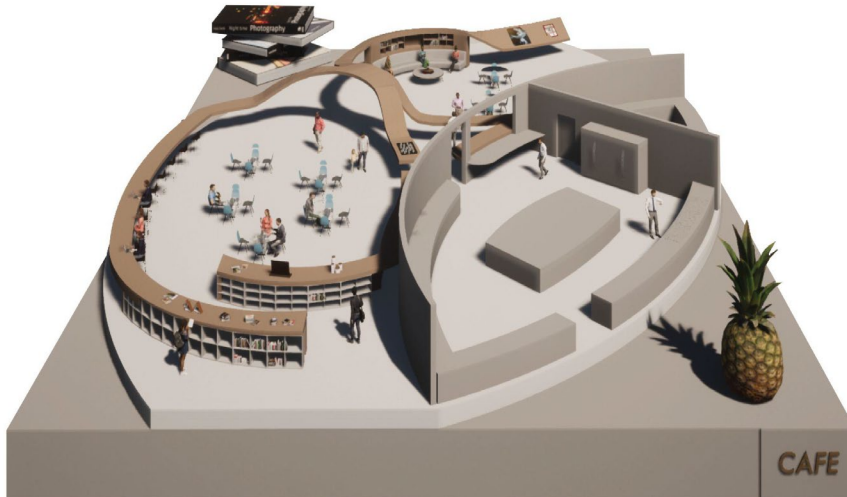

Figure 2: Artist-run cafe and community kitchen with a proposed “Department of Art Merced.” (Drawing by Oliver Holmes).

The popularization of the term ‘Mutual Aid’ may be traced back to Peter Kropotkin’s proposition that cooperation was at least equal to competition in the process of evolution. Adapting evolutionary theory, he advocated that, “The fittest are not the physically strongest, nor the cunningest, but those who learn to combine so as mutually to support each other, strong and weak alike, for the welfare of the community” (Kropotkin 2020). Given the central role of cooperation in many alternative economic models, the studio work of architecturally sustaining shared assets led to a resurfacing of labor structures like worker cooperatives. *The Maker Exchange Center*, by Natalie Stephens, blended familiar types of maker spaces with a cooperative model in which tools, materials, and skills create a shared pool of assets for the maker-owners (Figure 3). The proposal collectivizes the resources and infrastructure for artisan producers that might otherwise require individually navigating spaces of manufacturing, shipping, marketing, and material procurement. This hybrid entrepreneurial-cooperative system is sustained through the sale of goods both onsite and through collaboratively managed distribution (Figure 4).

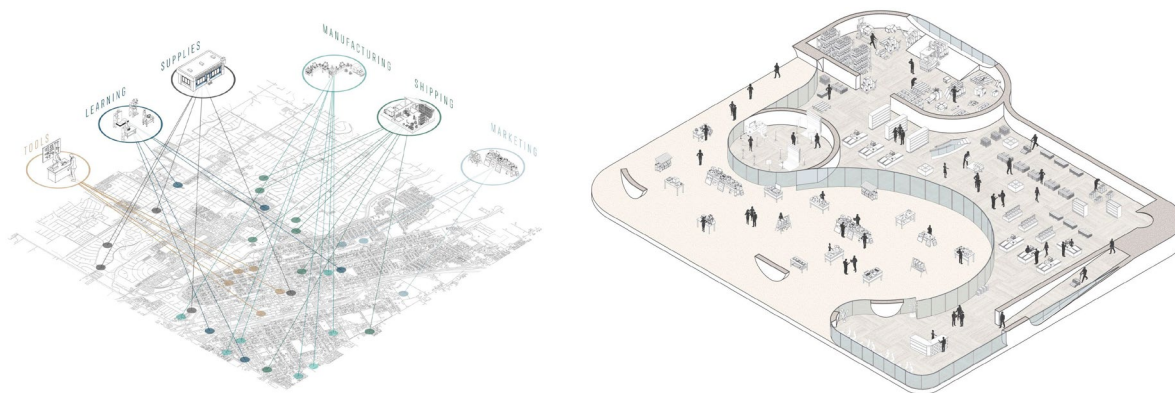

Figure 3 and 4: (left) Mapping sites of transactions for artisan producers in Merced. (Drawing by Natalie Stephens). (right) Ground floor of “The Maker Exchange Center” showing spaces for collective material storage and selling, photography, and shipping goods. (Drawing by Natalie Stephens)

5.0 THE HOME: LATENT SOLIDARITY

While the fortification of the Mexico-United States border wall serves as the flashpoint for immigration debates, the stability of the transborder economy relies on the movement of trade and cheap labor across a loose political geography. The border is a capitalist instrument structure to benefit labor industries and financial institutions well

beyond its limits (Walia 2021, 137-145). One of the collateral groups that emerge is undocumented farmworkers and mixed-status families who experience the unique economic and social precarity that stems from unilateral labor and immigration policies and the divisive politics they produce. These experiences led to inclusion/exclusion dynamics that made them reluctant to participate outside their disparate communities (Standing 2011, 113-114). Furthermore, the agricultural industry combines low wages and long hours at distant sites, which leaves many in these communities needing access to affordable childcare and education for their children. This lack of child rearing and education prevents them from breaking generational cycles of poverty. Simultaneously, tensions grow within mixed-status communities as undocumented parents who do not find access to care and education struggle to remain connected to Mexican-American children who begin to move away from traditional customs and identities (Gutiérrez 1995, 119-120). From this perspective, we can frame a broader group of people who are subjects of the border but don't necessarily need to reside or cross the border.

Courteney Begay's proposal called *Migrant (Housing) Field* restructured the standard bunker-style migrant housing models in the Central Valley into a field of intersecting rows that framed new communal zones for sharing and negotiating resources. The adjacencies that emerged in the plan enabled childcare to become a community-binding asset. (Figure 5) In particular, elderly members in the labor community, who don't typically retire due to a lack of options for retirement, can instead support younger families by providing childcare, thereby offsetting the costs that often cripple lower-income families. Begay's research centers on childcare as a means toward generational economic progress while ensuring that these communities can maintain identity and customs in the next generation's everyday life for the next generation.

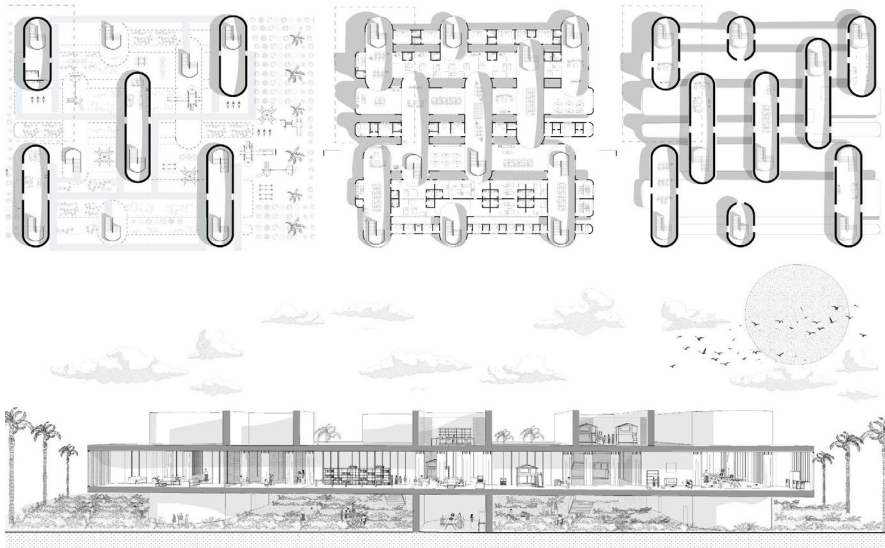

Figure 5: Migrant (Housing) Field, plan/section drawing displaying an intersected field of units and amenity spaces enabling nested spaces for communal exchanges. (Drawing by Courteney Begay)

Naomi Nagurski's proposal, *Below Boundaries*, recognizes undocumented workers' constant fear of raids, deportation, and sudden loss of work to their mobility and visibility (Figure 6). Nagurski proposed a discrete social housing model in Merced suburbs, where households strained by job loss use their ample, unused backyards to situate subterranean housing units along and below the ubiquitous cinderblock fence walls marking parcel lines. These migrant homes blend into the image of walled-off suburban yards and empty green spaces left over by sprawl. The protective status of parcel boundaries conceals undocumented residents from the national boundary that politicizes and endangers them. This project acknowledges that legal-status residents can be just as economically marginalized as undocumented residents in the Central Valley, where jobs predominantly come from low-wage industries.

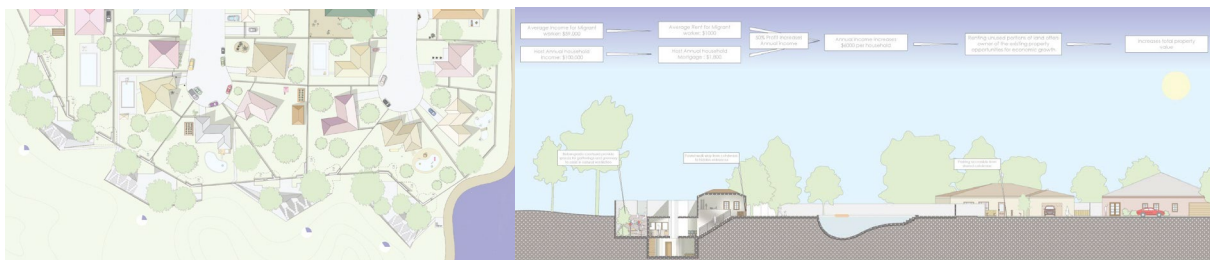

Figure 6: Below Boundaries, plan (left) and section (right) drawings situate a discrete new zone for social housing in Merced, where precarious migrant populations are concealed by struggling households. (Drawing by Naomi Nagurski)

When considering the type of publicness that might frame a population reluctant to be public, it's critical to leverage scales of association through which they already operate. Therefore, both Couertyen Begay and Naomi Nagurski's projects explored zones within or closely tied to the domestic realm to situate a new collective framework and speculate on the solidarity that comes from combining resources to overcome their struggles.

CONCLUSION

Our discipline's role in fostering social and environmental justice remains limited without rethinking economic exploitation in architectural education. Student engagement in the course's subject matter and its value for them in part stemmed from parallels in the geography and concerns between Merced, California, and Albuquerque, New Mexico. Like Merced, the city of Albuquerque and the Central New Mexico region experience higher unemployment and poverty rates than the national average. Both regions are major immigration landing states due to respective industries whose stability is contingent on the labor force. Furthermore, many of the collateral groups who were identified in the research and became a primary subject focus in design proposals also mirrored many of the students in the UNM SA+P, in that they are first-generation U.S.-born citizens, come from mixed-status families or communities and have experienced similar economic disadvantages living in the Central New Mexico region. The UNM SA+P is one of the most affordable schools of architecture in the region, meaning that our students come from underrepresented communities that are systematically limited in access to political and economic capital. Rather than solely studying a geography, population, and economic networks from a distance, students drew parallels with their contexts and locals to build common ground and design proposals in solidarity with more than "for" architectural clients.

The pedagogical approach and work of the research studio aimed to destabilize the economic systems shaping communities and design practices. In establishing a framework for research projects to explore how banking resources and homes can sustain supportive economies, students are asked to situate their own politics and the spatial politics of building. This framework casts the studio environment as a site for reimagining the nature of value in building practices. Rather than orient studios around charitable building types and economic systems, alternative and solidarity economies suggest ways architects can creatively support self-determined systems of mutual aid, well-being, and resource sharing.

REFERENCES

- Daniel M. Abramson. 2012. "Obsolescence: notes towards a history," *Building Systems: Design Technology and Society*. London: Routledge.
- Christine Bauhardt. 2014. "Solutions to the Crisis? The Green New Deal, Degrowth, and the Solidarity Economy: Alternatives to the capitalist growth economy from an ecofeminist economics perspective," in *Ecological Economics*.
- Klee Benally. 2020. "Turtle Island, Interview by Carla Bergman and Magalí Rabasa with Ariella Patchen and Seyma Özdemir", in *Pandemic Solidarity: Mutual Aid during the COVID-19 Crisis*. London: Pluto Press.
- Tithi Bhattacharya. 2019. "Feminism for the 99%," *The Dig Podcast* with Daniel Denvir.
- The Brookings Institute. 2006. *Financial Access for Immigrants: Lessons from Diverse Perspectives*. https://www.brookings.edu/wp-content/uploads/2016/06/20060504_financialaccess.pdf
- Aimee Chin, Léonie Karkoviata, and Nathaniel Wilcox. 2011. "Impact of Bank Accounts on Migrant Savings and Remittances: Evidence from a Field Experiment," The University of Houston Working Paper. http://www.uh.edu/~achin/research/ckw_banking_june2011.pdf, 2011.
- Committee on the Judiciary, Subcommittee on Immigration, Citizenship, Refugees, Border Security, and International Law, "Shortfalls of the 1986 Immigration Reform Legislation: Hearing before the Subcommittee on Immigration, Citizenship, Refugees, Border Security, and International Law of the Committee on the Judiciary," The United States House of Representatives, April 19, 2007, <https://lccn.loc.gov/2008354494>
- Robert S. Emmett and David E. Nye. 2017. *The Environmental Humanities: A Critical Introduction*,. Cambridge: The MIT Press.
- Federal Deposit Insurance Corporation (FDIC). 2021. *2021 FDIC National Survey of Unbanked and Underbanked Households*. <https://www.fdic.gov/analysis/household-survey/2021report.pdf>
- David Gutiérrez., 1995. *Walls and Mirrors : Mexican Americans, Mexican Immigrants, and the Politics of Ethnicity*. Berkeley: University of California Press.
- Stephen Healy. 2020. "Alternative Economies," in *International Encyclopedia of Human Geography*. Amsterdam: Elsevier.
- Indigenous Mutual Aid and Indigenous Action. 2009. *Zine: How to Start an Indigenous Mutual Aid COVID-19 Relief Project*. <https://www.indigenousmutualaid.org/zine-how-to-start-an-indigenous-mutual-aid-covid-19-relief-project/>
- Peter Kropotkin. 2020. *Mutual Aid: A Factor in Evolution*. London: Freedom Press. <https://www.opendemocracy.net/en/can-europe-make-it/why-mutual-aid-social-solidarity-not-charity/>
- Enrico A. Marcelli and Manuel Pastor, "Unauthorized and Uninsured" San Diego State University and the University of Southern California, January 19, 2022, https://dornsife.usc.edu/assets/sites/731/docs/Web_10_Southwest_East_Merced_Merced_County_Final2.pdf

- Jason W. Moore. 2016. *Anthropocene or Capitalocene? Nature, History, and the Crisis of Capitalism*. Oakland: PM Press.
- National Center for Farmworker Health, "Migratory & Seasonal Farmworker Population Estimates," January 19, 2021, <http://www.ncfh.org/number-of-ag-workers.html>
- Red Bloom Communist Collective. 2021. *Art Workers' Inquiry, Art Work During a Pandemic*. Red Bloom Communist Collective and Common Notions.
- Dean Spade. 2020. *Mutual Aid: Building Solidarity during this Crisis (And the Next)*. New York: Verso.
- Guy Standing. 2011. *The Precariat: The New Dangerous Class*. London: Bloomsbury.
- Manfredo Tafuri. 1976. *Architecture and Utopia: Design and Capitalist Development*. Cambridge: The MIT Press.
- United States Geological Survey, California Water Science Center. 2022. "California's Central Valley," <https://ca.water.usgs.gov/projects/central-valley/about-central-valley.html>.
- Harsha Walia. 2021. *Border and Rule: Global Migration, Capitalism, and the Rise of Racist Nationalism*. United States: Haymarket Books.

ENDNOTES

1. It's important to note that the studio described in this paper has a unique place in the UNM SA+P graduate Master of Architecture curriculum. Studio ARCH 601 Masters Architectural Design I is offered in the Fall term of the second year. It integrates 3-year graduate students with no architectural education and 2-year graduate students with previous architectural education. This studio is intended to situate research as a generator for complex design projects.
2. This information was sourced from the United States Census Bureau by comparing demographic, income/poverty, and economic statistics between Merced, CA, and Albuquerque, NM.

Spurensuche: On The Trail Of Seven Contemporary European Chapels

Andreas Luescher¹

¹Bowling Green State University, Bowling Green, OH

ABSTRACT: This research was inspired by an opportunity to tour seven contemporary chapels in 2021 designed by six German architects and one English architect in the region along the Danube, Europe's second-longest river. The client for those chapels ran a successful timber industry for many decades before deciding to build seven places of sanctuary spaced apart on a beautiful cycle path through the state-owned woods. The Siegfried und Elfriede Denzel Foundation chose the number seven because it is a frequent symbol used in the Judeo-Christian tradition (for example: creation, virtues, spiritual gifts) and therefore offers a suggestion regarding content. The seven wooden chapels should be interpreted both as landmarks and architectural symbols in the landscape, further advancing the tradition and typology of chapels in contemporary design. The only requirement was that the architects incorporate a specific design that addresses the symbolic nature of the cross. The field research furthermore explores functionality as a precedence for how architecture and art contribute to the creation of a place of silence, prayer, peace, and inner joy. This paper analyzes the poetic quality of these seven award-winning chapels based on the human, personal, and emotional experiences one may have visiting them, as well as having the opportunity to develop an appreciation of the physical, spatial, and atmospheric components of them as places. To conclude, the paper articulates a specific relational network (*Beziehungsgeflecht*) between three facets of contemporary design in chapels in connection with the following three modes of the poetic: bodily spatial experience; immersive experience of nature; and the atmosphere created by sound and light.

KEYWORDS: atmospheric, chapel, cross, relational network, timber

INTRODUCTION

1.0 BACKGROUND

Not since the creation of the Sacro Monte di Varese and its construction of a series of fourteen chapels, which represented the sequence of the rosary, between 1604 and 1698 has a new version originated—that is, until Timber industry entrepreneur Siegfried and his wife decided to plan and build seven wayside chapels.¹ Designed by six German architects and one British architect, the resulting structures, which are very different from one another, act like *Tankstellen für die Seele* (charging stations of the soul) along newly created cycle paths, with a focus on the district of Dillingen.²

These seven contemporary chapels must be framed and understood within the context of the Danube region, which is rich in cultural and natural heritage. Until the nineteenth century, the paths and streets in Catholic southern Germany were mapped and structured in the Christian tradition. Chapels, shrines, wayside shrines, and wayside crosses were constructed at special crossroads and served as guides to organize religious commemorations. Paths had various spiritual and religious connotations, provided orientation for travelers, and acted as landmarks. This network of paths lent a highly artistic quality to the spiritual/cultural landscape of the Swabian Danube valley, in contrast to today's technical and standardized layout of infrastructure.³

In the initiator intention these seven chapels should help to further develop the tradition of chapel design, becoming landmarks through their setting and architectural statement of form. The Finnish architect Juhani Pallasmaa describes this kind of imaginative design thinking best: "Architectural works reach beyond visual aesthetics towards the enigma of human existence itself" (2009a, 21). District curator Peter Fassl developed the project in February 2017 on behalf of Siegfried und Elfriede Denzel Stiftung phrasing his most important stipulation to the architects thusly: "In each chapel, a cross is given in terms of design."⁴ In addition, the chapels are required to provide seating that invites guests to rest, with timber as the building material, an obvious choice as the chapels are to be sustainable, durable, and easy to repair and care for. The straightforwardness of the design brief, furthermore, plays an important role in inspiring modest but not primitive or noble designs—just those that are *sachlich*, in German (objective and factual—without emotional attachment).⁵ There is almost nothing spectacular about these seven chapels except their interiors, which integrate perceptual immediacy and spirituality.⁶ The interrelationships of the seven chapels build on

earlier times when religious signs gave measure and orientation to the network of paths. This spiritual mapping became the inspiration for the seven chapels project.⁷

1.1 Showing the way

Early chapels were not freestanding structures; rather, they were spaces, known as a chambers, dedicated as sacred within churches and monasteries. The chapel’s purpose—for people to have a space to pray or worship on their own—has remained unchanged over time: There is no pastor or priest, no permanent congregation assigned. It’s all about the physical space.

A variety of chapel types and styles have developed over the centuries. One example is the bridge chapel, built either on or immediately adjacent to a road bridge, commonly established during the pre-Reformation medieval era in Europe. Alberto Pérez-Gómez says that such places contain a collective cultural memory of a society, which has been created based on how individuals construct their metaphors of themselves within the societal context.

Architecture is manifest in those rare places that speak back to us and resonate with our dreams, it incites us to real mediation, to personal thought and imagination, opening up the “space of desire” that allows us to be “at home” while remaining always “incomplete” and open to our personal death, unveiling a glimpse of the sense of existence. (2011, 576)

These seven unique sanctuaries, constructed between mid-2018 and the end of 2020, allow the visitor to experience at once the transparency of sacred architecture and the richness of the surrounding landscape. The architects, four regional—Hans Engel from Augsburg, Wilhelm Huber from Betzigau, Alen Jasarevic from Mering and Frank Latke from Augsburg—and three nonlocal—Volker Staab from Berlin, Christoph Mäckler from Frankfurt am Main, and John Pawson from London, use a minimalist design approach to create purity and simplicity of function.⁸ The structures’ variety of wooden elevations allow the foliage of the surrounding landscape to penetrate the chambers and become a part of them. At the same time, the sanctified interiors are illuminated and beautified by the warm glow emanating from ceilings that are either vaulted or sloped (see table 1).

Table 1. Overview of the basic facts of the seven chapels.

#	Chapel Name and Address	Architect	Year	Footprint (approx.)	Brief Description
1	Kapelle Unterliezheim, Mühlstraße, 89440 Lutzingen, Germany	John Pawson Architect, London, UK http://www.johnpawson.com/	2018	30 m ² 323 ft ²	<ul style="list-style-type: none"> Made of thick Douglas fir logs Reminiscent of log houses in Canada
2	Kapelle Kesselostheim, unnamed road, 86657 Bissingen, Germany	Staab Architects, Berlin, Germany https://www.staab-architekten.com/de/	2020	16 m ² 172 ft ²	<ul style="list-style-type: none"> Made of individual wooden slats Reminiscent of the Jenga game of skill, in which wooden blocks are stacked to form a tower
3	Kapelle Ludwigschwaige, 86647 Buttenwiesen, Germany	Jasarevic Architects, Mering, Germany https://www.b-au.com/	2020	21 m ² 226 ft ²	<ul style="list-style-type: none"> Shaped like a tent rising 40 feet into the sky Based on the concept of hands folded in prayer
4	Kapelle Oberthürheim, unnamed road, 86647 Buttenwiesen, Germany	Mäckler Architects, Frankfurt am Main, Germany https://chm.de/en/	2020	24 m ² 258 ft ²	<ul style="list-style-type: none"> Suggestive of a Gothic cathedral, 40 feet tall Cast in deep blue light by 172 small colored pieces of glass
5	Kapelle Emersacker, unnamed road, 86494 Emersacker, Germany	Architectural Office Huber, Kempten and Leiterberg, Germany https://architekturbuero-huber.de/	2018	28 m ² 300 ft ²	<ul style="list-style-type: none"> Reminiscent of a huge organ Drenched in ethereal atmosphere by a handblown glass skylight
6	Kapelle Gundelfingen, Offinger Str., 89423 Gundelfingen an der Donau, Germany	Hans Engel Architect, Augsburg, Germany	2018	31 m ² 333 ft ²	<ul style="list-style-type: none"> 12 round columns comprise a cruciform floor plan

					<ul style="list-style-type: none"> • 3 large glass walls focus on religion and philosophy related to nature
7	<p>Kapelle Oberbechingen, unnamed road, 89429 Bachhagel, Germany</p>	<p>Lattke Architects, Augsburg, Germany https://www.lattkearchitekten.de/</p>	2019	<p>23 m² 247 ft²</p>	<ul style="list-style-type: none"> • Square in plan with steep rafters soaring above • Simple cross illuminated by soft light falling from high above

From the fertile soil of history grew seven very diverse and individual interpretations of the *Wegkapelle* (roadside chapel).⁹ These sacred waymarks, as an architectural statement, advance the architectural typology of the notion of chapel. They not only comprise a testimonial to the belief in pilgrimage, heritage, and landscape but also contribute to the discussion of the concept, in defining their particular type of spatial thinking through both physicality and a materiality.

In a brief overview, starting with John Pawson's design and following the cycle path clockwise, this minimalist log structure seems completely opposite to the usual definition of a chapel.¹⁰ At first glance, it looks like logs stacked on top of one another to dry. Next, Volker Staab's chapel strikes one as both towering and lanternlike. Its permeable shell consists of individual horizontal wooden slats that fan out toward the sky like a flapping wing. The chapel space is delimited at the top by a cross that draws the wooden supporting structure into the opening. Alex Jasarevic's contribution, which is intended to symbolize two hands folded in prayer, also points upward. Clad in clapboard on the outside, the building has inner walls made of plywood, gouged to create a textured surface that interacts with the light. Visually, Christoph Mäckler's composition, the consecration of which shortly before Christmas 2020 completed the seven-chapel project, most closely resembles a classic wayside chapel. However, it is proportionally compressed and thus receives a strong vertical emphasis, which the architect intended as a reminiscence of a Gothic church. Light comes in through 172 square blue-glazed openings, and a golden-yellow cross penetrates the western gable wall. In contrast, the idiosyncratic form of the architectural design by Wilhelm Huber resembles an explicit pointer to the sky. The sacred interior is illuminated by a skylight with a blue mosaic pattern. Hans Engel's pavilionlike building, with its cross-shaped floor plan, looks like a small Roman temple: twelve turned round columns support a flat roof. Three glass panes decorated with graphic motifs are the only walls that delimit the open space. Last, Frank Lattke's design is a space with a square floor plan spanned by a high, steeply diagonal roof. Exposure is via vertical window slits (fig. 1).

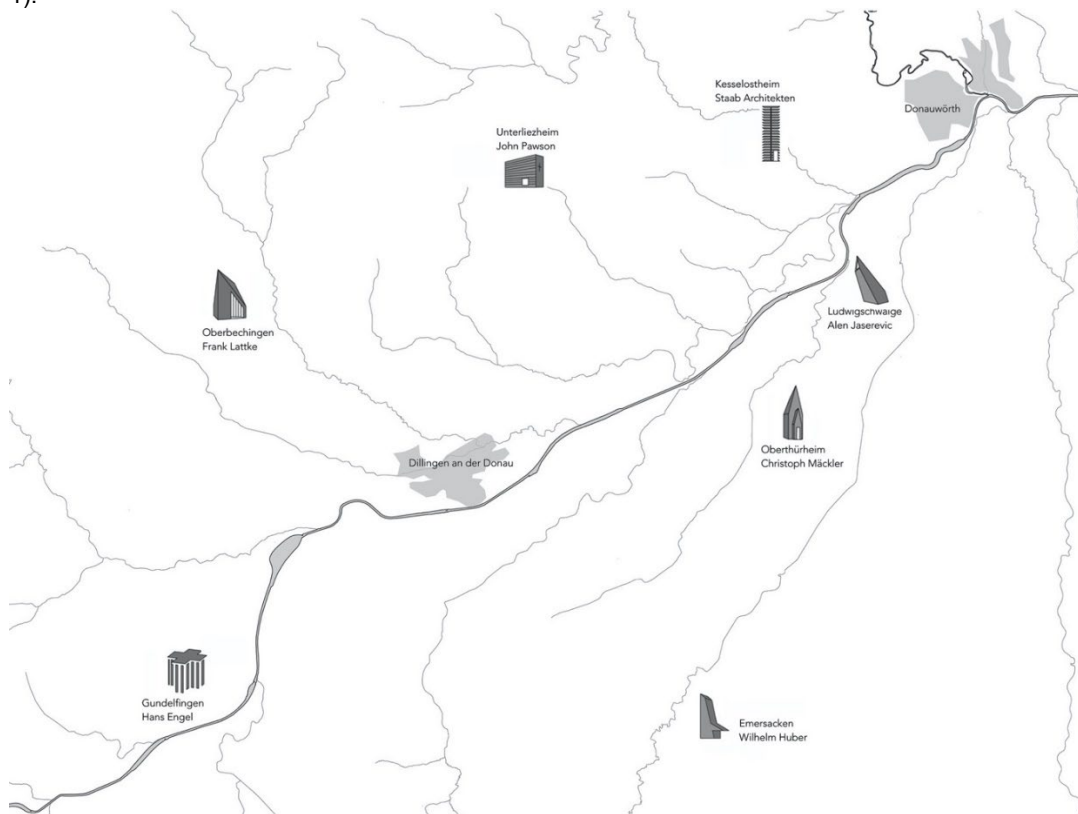

Figure 1. Map showing placement of the seven chapels in relation to town Dillingen at the Danube and the river Danube in Swabia, Bavaria, Germany. Source: author.

2.0 ANALYSIS

2.1 One room, one chapel, one God Source: Author.

In the beginning, God created the heavens and the earth (Genesis). What followed was even more interesting as the interpretation and meaning of those words continued to evolve. The Denzel Foundation in 2018 invited ten architects to submit designs for a temporary Pavilion of the Holy See in a wooded area on the Venetian island of San Giorgio Maggiore. This was the first time the Vatican contributed to a Venice Architecture Biennale.¹¹ The chapel designs, in fact, were isolated and inserted into an utterly abstract natural setting, characterized only by the way in which the site emerges from the lagoon, with an openness to the water. One of the ten mini chapels was the work of the Pritzker Prize winner Norman Foster, who took inspiration from the most fundamental symbol in Christianity: the cross. Over time, the chapel evolved into a structure of wooden masts and cables locked in tension and compression. This tensegrity structure supports an ethereal, faceted timber lattice that gently meanders through the landscape like a boardwalk. Mr. Foster nestled the chapel into “a green space with two mature trees beautifully framing the view of the lagoon. It was like a small oasis in the big garden, perfect for contemplation,” he wrote in the catalog.¹² Both the Vatican and the Denzel Foundation had same commonality as a design challenge in mind for the architects to articulate their own interpretation of the metaphor of the wandering of life. Juhani Pallasmaa’s words—the spiritual well-being is central to the quality of the built environment—are well reflected in the commissioned chapel designs for the Vatican and the Denzel Foundation.

“In addition to the five senses, experiences of architecture involve, for example, the sensations of gravity and lightness, the counterpoint of horizontality and verticality, movement and balance, sense of centre and focus, tension and ease, time and duration, not to speak of the role of memory and projection of intentional meanings.” (2011, 590)

A chapel, as an architectural type, provides the ideal conditions and accommodation for the four types of intimacy: emotional, mental, spiritual, and physical. There are some marvelous and innovative new chapels by world-renowned architects, like Peter Zumthor, Mario Botta, Steven Holl, Norman Foster, Eduardo Souto de Moura, and Carla Juaçaba. I selected three out of the seven chapels to analyze based on their focus on orientation, visitor’s engagement, support for meditation, and provision of an air of solitude in relationship to space, proportion, light, and materials. Pawson’s peculiar chapel stands out because it provides visual curiosity, presenting the visitor with the chance to peer and probe. On close examination it is obviously not a pile of logs or a matchbox but more closely resembles *de wonderlijke perspectiefkas*, or perspective box (Brusati 2011, 375), which captures painted interior views or a landscape or topographical view (fig. 2).¹³ Similarly, the observer inside in the chapel can look around at unfixed relationships of scale and proportion by divorcing the eye from the body. This exercise in seeing is supported by low light sourced from slim clerestories set high along the length of the chapel on both sides. The controlled influx of natural light, which filters gently downward through space, and the resulting dimness of the interior not only elevate the significance of the cross of colored glass in the end wall but, more important, point to a low, unglazed opening that, acting as a binocular, focuses the gaze on the outside world, graphically framing a wide view of the beautiful landscape and the picturesque rococo church of nearby Unterliezheim.

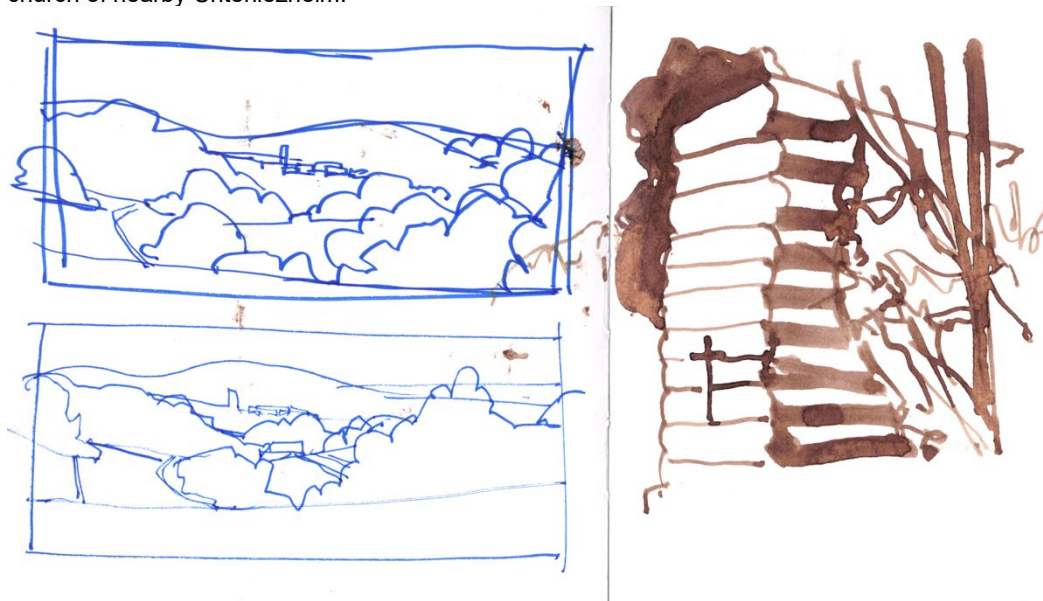

Figure 2: Interpretive sketches borrow language from the perspective box concept. Source: author.

In contrast is local architect Alen Jasarevic’s chapel design, which rises forty feet into the sky and is perfectly located in the Danube floodplains to form an eloquent symbiosis. While the interior has a vessel-like quality, the exterior can be read as an asymmetrical construction symbolizing hands folded in prayer. The transformation into a place of prayer,

devotion, contemplation, and silence is achieved through the placement of three 5.5-inch-thick cross-laminated timber panels that the sculptor Josef Zankl artistically refined over months of work. The hand-carved surfaces, with their notched structure, add depth to the chapel's spatial quality: even a slight change in light entering the triangular door affects the distribution of light and shadow within, sometimes transforming the simple timber panels into what appears to be a shimmering mirror of water. Adding to the mood are a handcrafted cross, candlestick, and holy-water bowl, which not only give an initial visual perspective but also stimulate the senses of touch and smell. Jasarevic's design is a reminder of Le Corbusier's statement upon presenting his plans for the Chapel Ronchamp: "Transfer lyricism to the materials, to the flex and bend them to best serve the design" (Pauly 2008, 87).

The spiritual dimension of air as atmosphere at the Ludwigschwaige Chapel can be traced to the Emersacker Chapel by Wilhelm Huber (fig. 3).¹⁴ Perhaps the name Blue Chapel Laugnatal referred to the harmonizing effect achieved through the merging of the built form with its surroundings, producing a perceptible, strongly atmospheric place of meditation that radiates energy far beyond its confines. The interior's divine ambience, created by a blue handblown skylight designed by Munich glass artist Herbert Kopp, is clear to visitors on entry. It's simple poetic constructions make use of air, light, timber, concrete, and blue color to stimulate multisensorial responses to the space. Further, the admission of white light offers moments of sensorial reflection and promotes an attuned state of well-being. The blue chapel can feel like a room-size church organ as well, through its portrayal of the desire for connection with heaven, or it can simulate an infinite ocean. An interesting correlation is the Rosary Chapel, also known as the Matisse Chapel after its famous designer, which uses light to echo the colors of Provence: blue for the azure sea and sky, green for verdant grasses, and yellow for the plentiful sunlight.



Figure 3. Both chapels Ludwigschwaige and Emersacker create a sense of elemental sacred immanence through the use of beams of light from high above. Source: author.

The door handle is the "handshake" of a building, and this is especially true for both the Ludwigschwaige and the Emersacker chapels. The fortress like doors offer the visitor a unique interaction based on the tactile sense of the handshakes of countless generations (Pallasmaa 2011, 45). This important element transcends the idea of a threshold, applying the notion of senses working *ganzheitlich* (integrally); the chapel doors work together to constitute an architectural and metaphysical impulse evoking feelings and memories, which are to be accessed not necessarily rationally but intuitively. The act of opening and closing the door gives the chapels a deeper sense as an empirical proof that an absolute analogy between outside nature (physical features) and internal nature (human organism) can be experienced. The visitor's participatory role is encouraged through physical interaction with the simple door as an object that can be touched, moved. There are no instructions directing when and how to interact with these monolithic doors. There are no indications as to what the visitor can expect once the door opens to the atmosphere of the space—only an invitation to choreograph their own conscious creative processes (Pallasmaa, 2009b).

CONCLUSION

I have chosen the term *Beziehungsgewebe* (relational network) to describe these seven contemporary chapels. This summary contributes to an understanding of the qualitative relationships between the individual and the atmosphere of the mind, offering a unique sensory experience of being in these chapels. On entering, the visitor can experience sensory immersion through touch, sight, smell, and even sound. Providing a place that allows the mind to refresh and go deeper within itself, these chapels offer an antidote to the stresses of daily life. In *Place and Experience*, the Australian philosopher Jeff Malpas (2018) emphasizes the co-dependency of memory, temporal and spatial, on place. As such, intangible or disembodied memory—that is, memory that is “unplaced,” is no memory at all. The opportunity to experience contemporary architecture as places of sanctuary that stimulate our imagination is a rare phenomenon. In this regard, these seven unique places offer a peculiar landscape experience where there is no forward or backward, no obvious hierarchy except for the chapels themselves as focal points. Moving through the Swabian Danube valley, like swimming in water, leaves one to drift and get lost in this sensation of nonhierarchical space. The design goal of minimal architectural intervention has resulted in structures with highly tactile surfaces displaying the grain of the wood. Physical changes will occur over time as the weather transforms the wooden chapels in perpetuity, making them a part of the land’s natural environment.

Positioned as eucharistic chambers filled with divine atmosphere and expressing the worship of nature in their forms, the seven chapels demonstrate a high degree of originality and innovation. In developing and reinterpreting the tradition of God’s house, these architects have altered our sense of the relational networks and qualities of experience by creating architecture that is more than culturally active “product.” In the best-case scenario, the chapels are loved. Individuals immediately accept them and make them their own because they reflect a shared reference point that transcends by far the internal traditions that define a typical chapel. Becoming an attraction in their own right, the seven chapels share a simple architectural manifest and smallness of scale, a commonality that manages to invoke a mutual cultural point of reference. The chapels’ visual journey, which bodily transports visitors, is totally accepted at the local level since it is intended to pave the way for a diversity of expression; and through its tourist routes, the trail emerges as a cultural destination of pilgrimage.¹⁵

REFERENCES

- Brusati, Celeste. 2011. “Self as Eye: The Perspective Box.” In *Toward a New Interior: An Anthology of Interior Design Theory*. New York, NY: Princeton Architectural Press.
- Pallasmaa, Juhani. 2011. “An Architecture of the Seven Senses” In *Toward a New Interior: An Anthology of Interior Design Theory*. New York, NY: Princeton Architectural Press.
- Pallasmaa, Juhani. 2009a. “Architecture and the Existential Sense: Space, Body, and the Senses. In *Art and the Senses*. Oxford, UK: Oxford University Press.
- Pallasmaa, Juhani. 2009b. “Artistic Generosity, Humility and Expression.” In *Theology in Built Environments: Exploring Religion, Architecture, and Design*. New Brunswick, CA: Transaction.
- Pauly, Danièle. 2008. *Le Corbusier: The Chapel at Ronchamp*. Basel, CH: Birkhauser.
- Pérez-Gómez, Alberto. 2011. “Architecture and the Body.” In *Art and the Senses*. Oxford, UK: Oxford University Press.
- Malpas, Jeff. 2018. *Place and Experience*. Milton Park, Abingdon, Oxon; New York, NY: Routledge.

NOTES

¹ Architect Giuseppe Bernascone, also known as Il Mancino, designed the entire complex: the route, chapels, skilled work, and fountains. From an architectural perspective, the underlying unity and monumentality of his design made the complex the most coherent of all Sacri Monti.

² The seven chapels are located within a thirty-mile radius of the town of Dillingen an der Donau (Dillingen at the Danube). The one-hundred-mile bike path connects all seven chapels in a circular formation, which allows one to experience the most beautiful corners of the riparian forest along Donauried, a river landscape with its species-rich wetland Swabian Donaumoss as well as historic old towns and picturesque village centers. Sieben Kapellen. n.d. “Der Radrundweg.” Accessed September 24, 2022. <https://7kapellen.de>.

³ Exemplifying this is the circular route of traditional nine churches and thirteen chapels in the Buttenwiesen municipality, a short distance from the new Chapel Oberthürheim by Christoph Mäckler.

⁴It was important from to the board of trustees to that they give the architects the necessary freedom and only to roughly mark out the “playing field” — loosely based on Antoine de St. Exupéry: “If you want to build a ship, then don’t drum up men together to procure wood, to assign tasks and to divide up the work, but teach the men to long for the wide, endless sea.” Antoine de Saint-Exupéry, *Oeuvres* (Paris, France: Gallimard, 1959), 687.

⁵ Bauhaus artists and architects analyzed the *sache* (object, subject matter) to determine how best to fulfill its function and serve its user. Terms like *Bauhaus*, *Neues Bauen* (*New Building*), *Neue Sachlichkeit* (*New Objectivity*), and so on aren’t as clearly distinguishable from one another.

⁶ Mies’s chapel at the Illinois Institute of Technology, as a predecessor of historic and aesthetic importance in chapel design, focuses more spiritually inward than on the stoic simplicity of the building’s outer shell.

⁷ The chapels' purpose as way finders that invite cyclists to stop, rest, reflect, and shelter is becoming more important because of the current increase in electromobility. Additionally, the chapels must be always accessible to everyone.

⁸ A budget of 100,000 euros net plus cost development was available for each chapel.

⁹ Wayside chapels (*wegkapellen* in German) are small chapels often found at crossroads or junctions.

¹⁰ Pawson, best known internationally of the seven architects, was chosen by the digital architecture magazine "ArchDaily" as the winner in the category of Religious Architecture 2020.

¹¹ For the first time, at the sixteenth Architecture Biennale (May 26–November 25, 2018), finished structures called Vatican Chapels were presented instead of renderings, models, and sketches documenting the creation of buildings at the national pavilions.

¹² Povoledo, Elisabetta. "The Most Surprising Entry in Venice's Architecture Biennale? The Vaticans." *New York Times*, May 25, 2018. <https://www.nytimes.com/2018/05/25/arts/design/venices-architecture-biennale-the-vatican.html>.

¹³ The exterior of the perspective box was designed to represent a chest, undoubtedly as a reference to *kunstkasten* (collector's cabinets). Koslow, Susan. "De Wonderlijke Perspectyfkas: An Aspect of Seventeenth-Century Dutch Painting." *Oud Holland* 82 (1967): 32–59.

¹⁴ Huber's architectural thinking related to sacral architecture is influenced by having worked for four years for the German Karljosef Schattner as head of the building department for the Diocesan and Catholic Research University in Eichstätt.

¹⁵ A slight similarity in the use of a cultural traveling concept can be found in *The National Tourist Routes in Norway*, a 2005 government initiative that asked architects and designers to design tourist routes in which architectural structures play a role in enhancing travelers' experiences of the stunning Norwegian landscape.

The Black Power Station: Collaborative Research-Design Methods in Makhanda, South Africa

Phoebe Crisman¹

¹University of Virginia, Charlottesville, VA

ABSTRACT: We live in a time of changing climate, widening economic inequality, social and political intolerance, racial injustice, and unprecedented environmental degradation. New types of collaborative, transdisciplinary research-design methods are needed to understand, imagine, and enact a more sustainable shared future. Indigenous peoples are particularly affected, and this research questions how to effectively create art practices and physical places that promote indigenous community thriving, creative economies, and the reclamation of their culture, sovereignty, and sustainability through design. Operating within a situated socio-ecological systems framework, our transdisciplinary team is comprised of University of Virginia faculty and students from four schools and disciplines—Architecture, Music, Global Public Health, and Systems Engineering. We are collaborating with a Xhosa arts activist collective to design a permanent public arts space, The Black Power Station, at an abandoned power station in Makhanda, South Africa. The collective uses music, art, theatre, and other forms of creativity to help Xhosa youth overcome the history of apartheid and its legacies of radical economic and social inequality, high unemployment and poverty, violence, and political alienation. The goal is to put artists at the center of collective social, political, and economic transformations that integrate indigenous Xhosa cultural knowledge and practices. The completed design for a sustainably transformed industrial building and landscape integrates green energy, water, and waste systems with local materials and regenerative agriculture. Already we are co-producing music and art in “sister spaces” in South Africa and the US—stimulating arts education and community development in both locations. This approach is highly iterative, emergent, and attends to deep differences in ontological and epistemological views among collaborators—co-producing architecture where communities see their knowledge and culture represented. The paper analyses the results of this research-design method and locates the findings within the context of ongoing situated socio-ecological systems research in architecture.

KEYWORDS: socio-ecological systems, design research, creative economies, sustainability, decolonization



Figure 1: Flexible community gathering and performance space at The Black Power Station. Source: Crisman studio 2022



Figure 2: View and site plan of The Black Power Station. Source: Crisman studio 2022

INTRODUCTION

New methods for collaborative, transdisciplinary research and design are essential in this time of changing climate, widening economic inequality, social and political intolerance, racial injustice, and dramatic environmental degradation. Partnerships between universities and communities in need are particularly valuable and challenging. Through a case study of The Black Power Station research-design process, this paper explores how intertwined art practices and physical places can promote indigenous community thriving, creative economies, and the reclamation of their culture, sovereignty, and sustainability through design. The project is a partnership between an indigenous Xhosa arts/activist collective, The Black Power Station, in South Africa and a diverse team of University of Virginia researchers and designers in the United States. Together we explored several research questions. How can transdisciplinary, collaborative research-design methods help indigenous communities to understand, imagine, and enact a more sustainable future? And how can we collaboratively design places that promote indigenous community thriving and the reclamation of their culture, sovereignty, and place? Simultaneous with the larger humanities/social science-based research, we co-designed a sustainable public arts, performance, and community healing space in one of the abandoned industrial buildings of a colonial-era power station in Makhanda, South Africa (Figure 2). Even prior to construction, we are already co-producing music and art in “sister spaces” in South Africa and the US—stimulating arts education and community development in both locations (Kester 2011).



Figure 3: Art and music production at The Black Power Station. Source: Research team 2020



Figure 4: A Book'ona reading (left) Research team working in the current space (right). Source: Research team 2020 and 2022

1.0 TRANSDISCIPLINARY RESEARCH METHODS + PROCESS

Faculty and graduate students from four schools and disciplines—Architecture, Music, Global Public Health, and Systems Engineering—shared their disciplinary research and methods, and then together developed an innovative research-design process. We used decolonizing and ethnographic methods of stakeholder interviews and storytelling recordings informed by Richa Nagar's work on co-authorship and storytelling as tools of empowerment (Nagar 2014). We examined the uses and programs of comparable community arts and sister spaces, such as C2O, a community co-working space in Surabaya, Indonesia, and Frontyard, a community space in Sydney, Australia (Bacon 2019). We conducted formal, spatial, and material analysis of indigenous Xhosa architecture and current sustainability strategies (Open Heritage 2016, Frescura 2017). Co-design methods informed the overall process (Schneider 2009, Grand 2012).

Architecture Professor Phoebe Crisman designs and builds sustainable architecture and landscapes with disenfranchised communities in the US and abroad. Her research on situated socio-ecological systems has focused on indigenous knowledge and the specific issues of Native American communities (Kimmerer 2013). This ongoing work with an indigenous South African community in the Global South builds on her recent research with the Sisseton Wahpeton Oyate tribe in South Dakota (Crisman 2022). Music Professor Noel Lobley's research and artistic practice works across the disciplines of music, anthropology, sound art, and composition. The Black Power Station provided the opportunity to investigate a "sonic architecture" that transmits and receives sound into the new space itself. This builds on his efforts developing international and cross-cultural collaborative curatorial residencies for exploring immersive sound environments and "sister spaces." Such practice-driven research enables the collaborative sharing of sound environments both in physical spaces and in experimental studio courses. Global Public Health and Systems Engineering Professor Rupa Valdez locates her research at the intersection of public health, engineering, cultural anthropology, and community engagement. This project extends her research on participatory and user-centered design methodologies with marginalized populations and communities that address social determinants of health.

The research-design process required time building relationships in person in South Africa and the US, as well as weekly virtual meetings. Xolile Madinda, founder of The Black Power Station and Xhosa hip-hop musician and activist, completed two artist residencies at the University of Virginia (UVA), and UVA researchers travelled to Makhanda for extended periods in January 2020 and July 2022. We met with the mayor and economic development leaders of Makhanda, Rhodes University faculty, and directors of their Equity & Institutional Culture office and Civic Engagement programs. We visited the site with the executive director of South Africa's National Arts Festival that happens in Makhanda each year. Learning from the feminist writings of Donna Haraway, Caroline Ramazanoglu, and Sandra Harding, we recognized participants' differing subjectivities, nurtured relationships, and used methods of collaborative knowledge production (Ramazanoglu and Holland 2002; Haraway 1988; Harding 1991). This highly iterative and

emergent process treated all participants as socially and culturally situated. In this way, we have built valuable trusting relationships between both communities.

2.0 CONCEPTUAL FRAMEWORKS

2.1 Indigenous Ecologies and Environmental Justice

Understanding the deep relationship that indigenous peoples have with the ecological systems and places they inhabit is an important foundational concept (Anderson 1996). Like many indigenous groups, Xhosa ecological cosmologies do not separate concepts of nature and culture and relations of kinship often include nonhuman entities. For instance, many native plants contain physical and spiritual properties used in ceremonial practices. Time is often not understood as linear and relationships with ancestors or future generations can be quite immediate. European colonization of South Africa, and later Apartheid policies divided the Xhosa from their land, livelihoods, language, and beliefs. The Black Power Station's programming embraces traditional Xhosa knowledge and practices such as healing ceremonies and improvised Izibongo, or Xhosa praise poetry, which is a distinct form of oral literature that recognizes people, animals, and inanimate objects. The poet, or imbongi, can play a sacred role communicating between the living and the dead, or deliver social criticism in the face of power (Opland 2010).

2.2 Black Consciousness and Imbeko

Xolile Madinda explained the central role of Xhosa anti-apartheid activist Steve Biko and his writings on Black Consciousness to The Black Power Station's mission. They embrace "imbeko," which is the Xhosa word for respect. An important physical element of their imbeko practice, the "Book'ona," is essentially a library and reading place—a combination of book and ikhona, meaning "it is there" in the isiXhosa language. Each gathering at The Black Power Station begins and ends by inviting a guest to select a book, let it fall open, and then read aloud whatever text is revealed for as long as they like. Knowledge literally bookends their events. Their activism extends to "areas of children's rights to a quality education, working towards healthier family and community relationships by supporting womxn feminist associations and men's forums. This is to cultivate healthier relationships among us" (Madinda 2022).

2.3 Arts Activism and Creative Economies

Our team conducted research on creative hubs, arts incubators, and other places of cultural labor that can drive creative economies (Gill 2019). We are now co-producing virtual and in-person performances, art workshops, and community discussions aimed at helping Makhanda residents overcome the history of apartheid and its legacies—radical economic and social inequality, high unemployment, poverty, violence, and political alienation. Understanding current conditions and Xhosa trauma requires knowledge of colonial actions that erased indigenous identity, language, and ways of life, as well as post-apartheid events. Now the Xhosa are defining for themselves how to integrate their own cultural knowledge and practices with their current decolonization efforts. Simultaneously, we laid the groundwork to create a "sister space" in our college town, Charlottesville, Virginia, which has suffered economic and social inequalities for many decades, and its own remarkable violence of late. Echoing the work of The Black Power Station, our local space must also be a space of creativity, social justice, and peaceful coexistence for residents. To paraphrase Angela Davis, sister spaces help us see our own struggles in the struggles of others, and act together to address them. For example, UVA students designed an exhibit of artwork by Black Power Station artists and youth at Charlottesville's McGuffey Arts Center. Along with sharing art and culture, the show raised funds for programs at The Black Power Station. South African artists Xolile Madinda and Bliss Rabeshu joined us for class visits, performances, and public events with local groups working on fair housing, sustainable development, and community-based education—all areas of intervention planned in Makhanda. Together we are connecting the arts, social justice, and community development.



Figure 5: View of main entrance to The Black Power Station. Source: Crisman studio 2022

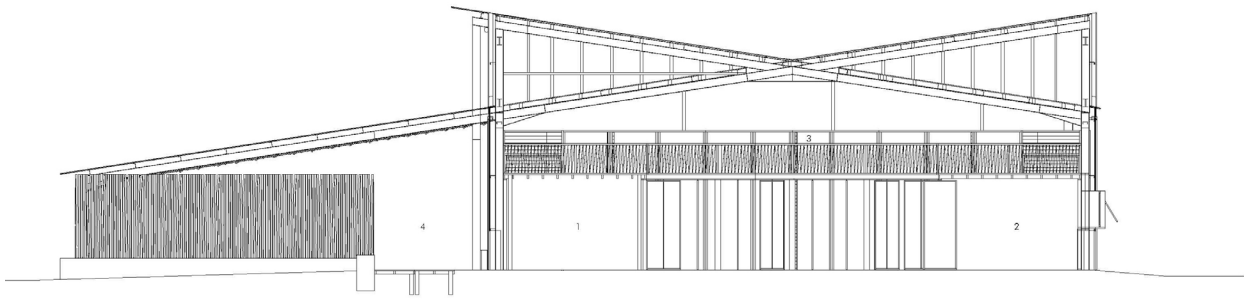

Figure 6: Cross-section of Common Court with new roof monitors and mezzanine. Source: Crisman studio 2022



Figure 7: Common Court with art and recording studios at The Black Power Station. Source: Crisman studio 2022

3.0 ARCHITECTURAL FINDINGS

The coal-burning power station was built in 1922 to provide electricity to the white residents of Grahamstown (Lobley 2022). Closed in the 1970s, the derelict industrial complex is comprised of many large brick and sheet metal buildings with massive interior volumes. A compelling landscape of massive concrete cooling basins and rough lawn is informally occupied by skateboarders and dance performances. Since 2014 Xhosa artists have informally occupied a small part of the ruined complex and created a space filled with found objects and self-made interventions. Their current space is a work of art—an assemblage of things collected and imbued with meaning by the community. That occupation is temporary, however, and now they are gathering resources to create a more permanent, spacious, and self-sustaining home for their activities.

Together we have designed the sustainable transformation of one large industrial building, which will contain a rich array of new spaces and activities situated within a repaired landscape of outdoor gathering places and regenerative gardens. The new initiative addresses South Africa's larger problems of water scarcity, unsustainable energy supply, and the loss of public space and collective identity in a post-colonial, post-apartheid environment. The architectural design integrates sustainable water, energy and waste systems with reused, local materials and regenerative agriculture. The design was guided by several principles that emerged in the engaged research process.

3.1 Care and Repair

Retain and repair the existing industrial shed's steel structure, corrugated steel and brick cladding, corrugated fiberglass apertures, and unassuming exterior expression. Embracing the history, weathering, and aesthetic of the found building aligns with theories of care, continuity, and creative interpretation. The idea of a 'stealth' or quiet intervention emerged, where soft wood and fabric inside was concealed by a hard, relatively closed outside—a magic box of sorts.

3.2 Soft, Handmade Layers

Insert a soft, acoustical interior layer of self-made and sustainable wood, rammed earth, and fabric elements within the existing steel shell. This variable layer adds needed thermal insulation to the rough, steel shed and creates different sonic environments. For instance, in some place the layer is thick and absorptive using bookshelves and books (Figure 1). Handmade quilts using reclaimed fabrics can be affixed to walls, changed, and (re)created over time.

3.3 Connect with the natural world

Connect with the natural world by increasing light and air flow between inside and outside. We designed simple rooftop light monitors to naturally illuminate and ventilate the common court, while providing vertical space to accommodate a new mezzanine level for flexible community work. Existing, massive sliding garage doors will be reclad with clear corrugated fiberglass to bring in daylight and connect with new outdoor spaces.

3.4 Found and locally sourced materials

Use existing, recycled, and locally sourced materials to take a sustainable approach to materials, time, and autonomy. The Black Power Station artists will build sunshades, interior walls, bookshelves, and reconfigurable furniture by using recycled wood pallets and local bamboo. Reclaimed fabrics, rope, and fiber will be used for railings, suspended lights, and seating cushions. A series of Artist-in-Residence dwellings will be community-built using traditional rammed earth, reused glass bottles, and locally sourced grasses for roof thatch. They are designed to reference the vernacular Xhosa rondavel—a cylindrical stone or earthen architecture finished with dung, topped with a conical wood and thatch roof, and traditionally built throughout South Africa’s Eastern Cape region.

3.4 Large and flexible interior spaces

Create two large, flexible spaces that maintain the openness of the existing industrial shed. Connect these with a central greenhouse gallery (Figure 10) that provides passage through the building and brings the outside in. The community and performance space can be used for diverse purposes with moveable seating and a massive sliding garage door to connect interior and exterior spaces (Figure 1). There is enough area for an audience of 150 people. A large stage self-made of recycled wood pallets can be reconfigured into dispersed seating and work surfaces. Walls will be lined with deconstructed wood pallets and soft materials to accommodate books and seating. The “Book’ona” is a central element, a growing library, which provides books for the act that opens and closes all events at The Black Power Station. A guest is invited to select a book, let it fall open, and then read aloud whatever text is revealed for as long as they like. The Common Court is lined with stacked art and recording studios and open computer labs for kids and community (Figure 7). This flexible space can be used in a myriad of ways, even when performances are underway nearby.

3.5 Green exterior gathering spaces

An outdoor theater and performance space connects with the indoor performance space (Figure 9), while the outdoor dining spaces directly adjoin a kitchen and café to serve the community and use produce grown in the adjacent regenerative gardens. We designed a grouping of independent, one-room dwellings for visiting Artists-in-Residence and healing practices around a central exterior ‘kraal’ and surrounded by herb and vegetable gardens. A skatepark and basketball court will be created within the ruined cooling basins.

We explored how arts practices and indigenous knowledge can inform the physical design of these cultural spaces—where artists and audiences see their knowledge, histories, and culture embodied in the place. By co-imagining, designing, and building a liberated arts space, The Black Power Station can begin to extend and sustain its fiercely independent vision.

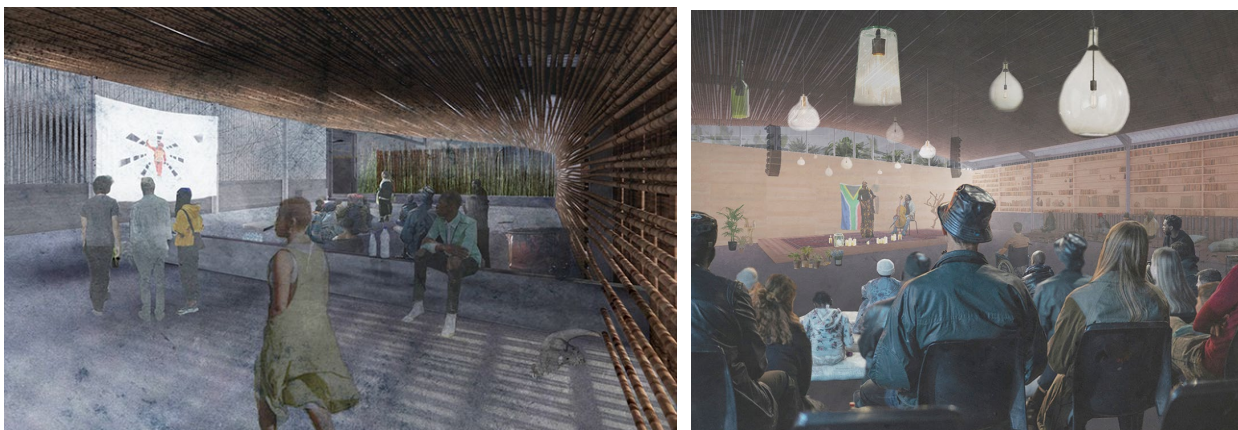

Figures 8 and 9: Outdoor theater and gathering space(Left).Performance space (Right). Source: Crisman studio 2022.

CONCLUSION

While still only existing in drawn form, The Black Power Station is already generating meaningful change. Beyond the physical and socio-technical design, the project generated translatable research from this innovative arts collaboration between an indigenous Xhosa community in South Africa and a transdisciplinary University team in the United States. We have co-produced specific strategies that put indigenous artists at the center of social, political, and economic transformations that integrate Xhosa cultural knowledge and practices. These activities seek to help Xhosa youth and the larger community overcome the history of apartheid and its contemporary legacies of radical economic and social inequality, high unemployment and poverty, violence, and political alienation. And in so doing, they have also created an understanding of how reimagined, co-designed spaces can foster community health and wellbeing. In this way, co-design is a reciprocal act of knowledge creation, sharing, and generosity for all involved.



Figure 10: Community Greenhouse Gallery at The Black Power Station. Source: Crisman studio 2022.

ACKNOWLEDGEMENTS

This research was completed with many collaborators, including University of Virginia Professors Noel Lobley, Rupa Valdez, and David Edmunds, UVA graduate students Eli Sobel, Bucky Gerson, Matias Andres Vilaplana Stark, and Courtney Rogers, and Xolile Madinda and all his brothers and sisters at The Black Power Station.

REFERENCES

- Anderson, E. 1996. *Ecologies of the Heart: Emotion, Belief, and the Environment*. Oxford: Oxford University Press.
- Bacon, L., et.al. 2019. "C2O and Frontyard: Hacking the Archives to Design Community Spaces in Surabaya and Sydney." *Global Knowledge, Memory and Communication* 68, no. 8/9: 712-727.
- Crisman, P. 2022. "Generosity through Co-design: Collaborating with the Sisseton Wahpeton Oyate." In *Generosity and Architecture*, edited by M. McVicar, S. Kite, and C. Drozynski. London: Routledge.
- Frascura, F. and Myeza, J. 2017. *Illustrated Glossary of Southern African Architectural Terms*. Pietermaritzburg: University of KwaZulu-Natal Press.
- Gill, R., Pratt, A., and Virani, T. 2019. *Creative Hubs in Question: Place, Space and Work in the Creative Economy*. Palgrave Macmillan.
- Haraway, D. 1988. "Situated Knowledges: The Science Question in Feminism and the Privilege of Partial Perspective." *Feminist Studies* 14 (3): 575–599.
- Harding, S. 1991. *Whose Science? Whose Knowledge? Thinking from Women's Lives*. New York: Cornell University Press.
- Kester, G.H. 2011. *The One and the Many: Contemporary Collaborative Art in a Global Context*. Durham: Duke University Press.
- Kimmerer, R. 2013. *Braiding Sweetgrass*. Minneapolis, MN: Milkweed Editions.
- Lobley, N. 2022. *Sound Fragments: From Field Recording to African Electronic Stories*. Middletown, CT: Wesleyan University Press.

- Nagar, R. 2014. *Muddying the Waters: Coauthoring Feminisms across Scholarship and Activism*. Champaign, IL: University of Illinois Press.
- Open Heritage, 2016. *Vernacular Architecture of the Eastern Cape*. National Heritage Council of South Africa.
- Opland, J. and McAllister, P. 2010. "The Xhosa *imbongi* as trickster." *Journal of African Cultural Studies* 22, no. 2.
- Ramazanoglu, C. and Holland, J. 2002. *Feminist Methodology: Challenges and Choices*. London: Sage.
- Schneider, T. and Till, J. 2009. "Beyond Discourse: Notes on Spatial Agency." *Footprint: Delft School of Design Journal* 4.

The Virtual St Paul's Cathedral Project: Recreating the Experience of Lost Time and Lost Spaces

John N. Wall¹, David B. Hill¹, Yun Jing²

¹NC State University, Raleigh, NC

²Pennsylvania State University, State College, PA

ABSTRACT: The Virtual St Paul's Cathedral Project (VSPCP) < <https://vpcathedral.chass.ncsu.edu/>> is a collaborative Digital Humanities Project, supported by the National Endowment for the Humanities, that draws on the expertise of researchers from Architecture, Acoustical Engineering, and English Literature. It combines visual and acoustic digital modeling technology to explore the lived religion of London in the post-Reformation period by recreating specific occasions of worship and preaching in St Paul's Cathedral in early modern London. The visual models achieve accuracy by combining data from archaeological excavations of the original foundations left by the Great Fire of London (1666) with contemporary measurements of these buildings' interior dimensions and surviving visual depictions of the cathedral and its surrounding structures. Renderings of these models incorporate data about ages of different structures as well as depictions of weather, time- and season-governed angles of light, and effects of acidic coal burned for cooking and heating. Acoustic models combine basic dimensions of the visual models with the acoustic properties of the materials used in their construction. Within these models, the project brings together literary, religious, musical, and cultural histories of that period to recreate festive and ferial worship services using the liturgies of the Book of Common Prayer and music composed by musicians working at St Paul's, with actors using scripts in original early modern pronunciation and musicians from Jesus College, Cambridge University standing in for their 17th century predecessors. Our project materializes the ephemeral, enabling us to study developments in English religious and cultural history as though we were present in the built environment of the 1620's. In this period, the Cathedral and its surroundings moved from predominantly religious uses to a mixed environment of religious, social, and commercial (chiefly book dealers) spaces, each with its consequences for preexisting and new construction as well as for social interaction.

KEYWORDS: digital reconstruction modeling, auralization, cathedral, worship, virtual reality

INTRODUCTION

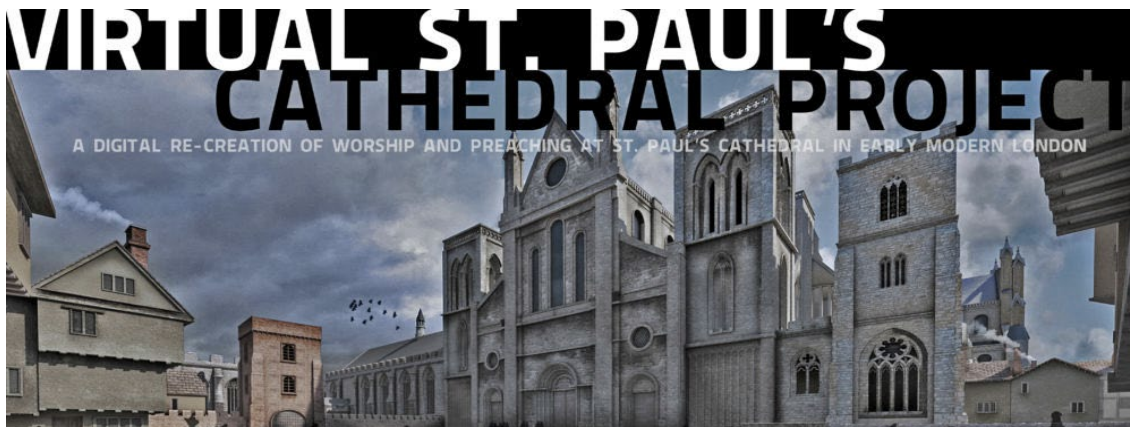

Figure 1: Virtual St Paul's Cathedral website header. Source: (Rendering by research team)

The Virtual St Paul's Cathedral Project (VSPCP) < <https://vpcathedral.chass.ncsu.edu/>> (Figure 1) is a collaborative Digital Humanities Project, supported by the National Endowment for the Humanities, that draws on the expertise of researchers from Architecture, Acoustical Engineering, and English Literature to explore the lived religion of London in the post-Reformation period. The Project unites three-dimensional digital models of St Paul's Cathedral and surrounding structures in Paul's Churchyard with recreations of specific occasions of daily and festival worship, specifically the celebration of Easter Sunday in 1624 and the observance of an ordinary day in November of 1625. These acoustic recreations combine the Church of England's required liturgies, with prayers, creeds, scripture readings and sermons performed in the accents of early modern London English and choral and organ music composed by

musicians at the Cathedral in the 1620s. Together, these spatial and acoustical models enable us to experience the lived religion of post-Reformation England as events that unfold in real time in the spaces in which they were originally performed. Using the VSPCP enables us to study worship and preaching as performances, as lived religious experiences taking place in specific settings, rather than as theological essays read in the privacy of one's study. We explore how the Reformation changed the arrangement of space inside the cathedral, both physically and in terms of how it was used, noting especially how the spaces inside a 14th century building were transformed to facilitate reformed worship in the 16th century.

1.0 GOALS



Figure 2: St Paul's Cathedral, the Choir from above. Source: (Rendering by research team)

The overall goal of the Virtual St Paul's Cathedral Project is to use the tools of visual and acoustic modeling to make available to scholars the experience of public worship as scripted by the Book of Common Prayer as it unfolds in real time in a recreation of one of the most significant worship centers of the Church of England in the early seventeenth century. The VSPCP includes two full days of worship at St Paul's, bringing to life services scripted by the Church of England's Book of Common Prayer and enriched by performances of music composed by the cathedral's musicians in the early seventeenth century as well as sermons delivered by Lancelot Andrewes, Bishop of Winchester, and John Donne while he was Dean of St Paul's (1621-1631).

Our immediate goal in this project is to demonstrate how architectural digital modeling and acoustic recreations of specific events can recreate significant architectural structures and spaces (Figure 2) that have been lost to time, and how these reconstructions provide evidence that contributes to a greater understanding of period-specific events. Our broader goal is to open up for research the distinctive character of post-Reformation lived religion as a series of occasion-specific, deeply contextual, interactive performances that take meaning from the liturgy surrounding them and contribute to the overall action and understanding of the gathered congregation. We also aim to document how the English Reformation changed the arrangement and use of space inside medieval churches and affected the built environment of early modern London by opening up spaces for new construction that responded to the advent of new technologies such as the burgeoning book trade.

2.0 THE VISUAL MODEL

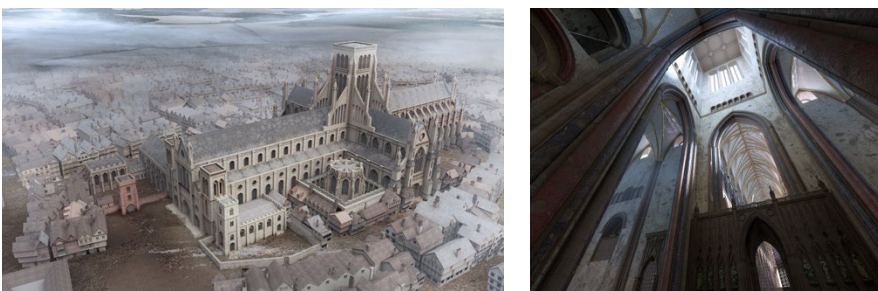

Figure 3: St Paul's Cathedral outside and inside. Source: (Rendering by research team)

The Virtual Cathedral Project draws on the modeling capabilities of digital visualization to create visual models (Figure 3) of buildings destroyed by the Great Fire of London in 1666. The project team has carefully reassembled the cathedral to the highest possible degree of accuracy and authenticity in digital space by using an array of historical evidence,

including archaeological surveys of the original foundations, contemporary measurements of these buildings' interior dimensions (especially by Christopher Wren in his plan of 1662 for renovating the cathedral) and surviving visual depictions of the cathedral and its surrounding structures, especially those done by Bohemian artist Wenceslaus Hollar for William Dugdale's 1650 *History of St Paul's Cathedral* (Dugdale 1658).

Unlike other digital recreations of lost architectural spaces such as Rome Reborn (<https://www.romereborn.org/>), the Cathedral Project recreates specific occasions of worship and preaching in St Paul's Cathedral, events that took place in specific places and on specific occasions in the presence of particular congregations. The rendered models therefore incorporate data about the ages of particular structures as well as about weather, time- and season-governed angles of light, and effects of acidic coal burned for cooking and heating.



Figure 4: St Paul's Cathedral, Domestic Structures in Paul's Churchyard. Source: (Renderings by research team)

We have reviewed traditions of depiction for early modern domestic and commercial structures (Figure 4). These structures used large wood timbers for support. Traditional ways of depicting them—in the world of historic preservation as well as in the world of visual presentation—show these buildings with exposed timbers, usually painted black, and with white plaster filling in between the timbers. This is how we depicted these structures in *The Virtual Paul's Cross Project*. Our review of surviving images of these buildings demonstrates, however, that in the original buildings the plaster completely covered the structural timbers and was more likely to have been painted in pastel colors than in white (Komorowski 2014). As a result, we changed the style of presentation of these structures in the cathedral models.

3.0 THE ACOUSTIC MODEL

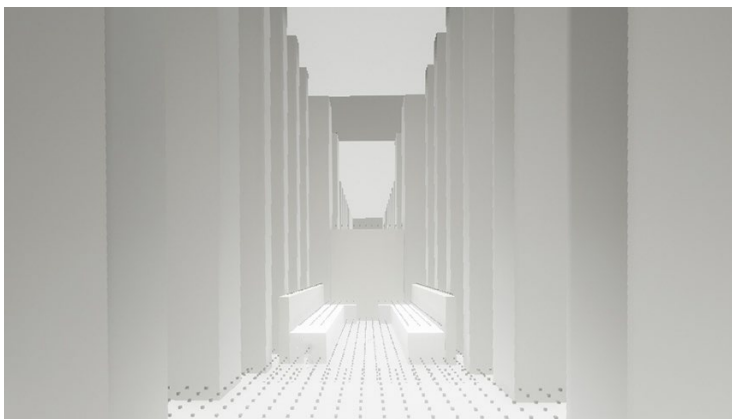

Figure 5: St Paul's Cathedral, the Choir. Source: (Acoustic Model by research team)

The most important aspect of the Virtual Cathedral Project is, however, the acoustic model (Figure 5) and the listening experience it makes possible. Because of it, we may experience worship and preaching in post-Reformation London as events that unfold in real time and in the architectural environments in which they originally took place. Our acoustic model combines basic dimensions of the visual models with the acoustic properties of the materials used in their construction. Within these models, the project brings together literary, religious, musical, and cultural histories of that period to recreate festive and everyday worship services. This is accomplished by using the liturgies of the Book of Common Prayer and music composed by musicians working at St Paul's, with actors using scripts in original early

modern pronunciation, and musicians from Jesus College, Cambridge University standing in for their 17th century predecessors.

The festival celebration of Easter Day 1614 includes the morning services of Matins, the Great Litany, and Holy Communion as well as Evensong in the afternoon. The ferial, or ordinary day—the first Tuesday in the Advent Season in late November—includes only Matins and Evensong. These early modern worship services are auralized (recorded speech and music projected into the digital model) in order to experience sight *and* sound. The sound changes as one moves from one section of the cathedral to another, enabling us to experience these events as they unfold from six different listening positions (Figure 6), sounding to us as they would have sounded when they originally took place. As a result, early modern worship and preaching are no longer available to us simply as printed texts or handwritten manuscripts; they now can be experienced in real time through this project’s multi-media portrayal of period-specific worship music and preaching in the cathedral.

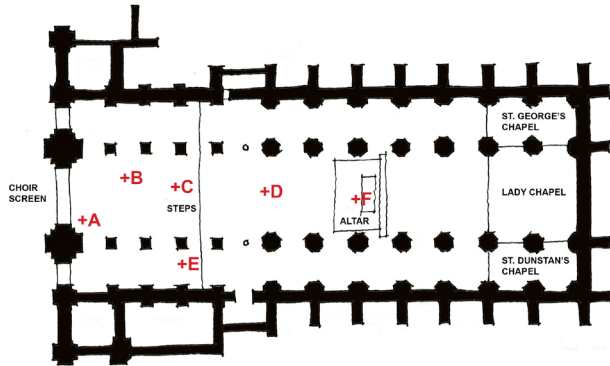

Figure 6: Chart of Listening Positions in the Choir of the Cathedral. Click on the link (<https://youtu.be/Lan48w1Mrls>) for a 2-minute tour of the different listening positions as one listens to the opening of Matins on Easter Sunday 1624. Source: (Research team)

4.0 OUTCOMES

Our project therefore materializes the ephemeral, enabling us to study developments in English religious and cultural history as though we were present in the built environment of the 1620s. In this period, the Cathedral and its surroundings moved from predominantly religious uses to a mixed environment of religious, social, and commercial (chiefly book dealers) spaces, each with its consequences for preexisting and new construction as well as for social interaction. We explore how this reorganized space affected use of the cathedral by merchants, by members of the nobility, and by lawyers and prostitutes who came there to look for clients. We also explore how the cathedral’s churchyard became the location for gatherings of up to 5000 people for public sermons as well as the site for extensive new construction to house the print shops and booksellers’ stalls in England’s burgeoning book trade. We notice how St Peter’s College, just to the west of the cathedral’s West Front built to house Chantry priests, became repurposed after the Reformation, first to house the newly formed Stationers’ Company, then to become home to a pub after the Stationers’ Company moved to its current home in Ave Maria Lane early in the reign of James I.

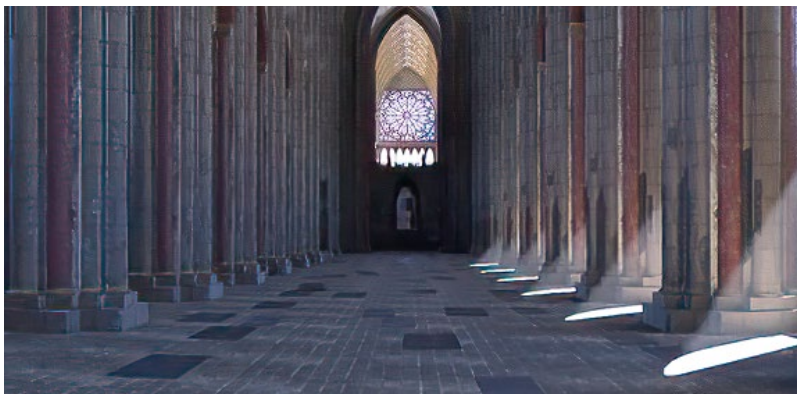

Figure 7: St Paul’s Cathedral, the Nave. Source: (Rendering by research team)

The Nave of St Paul’s Cathedral (Figure 7), which had been lined with altars for Chantry priests to celebrate Mass for the repose of the souls of the departed in Purgatory, now became a place for Londoners and visitors to gather for

conversation. By the end of the 16th century, it had become known as Paul's Walk, because people of means had begun to use it as a place to show off their finery, to consult with lawyers and prostitutes, and to pick up the latest gossip. The noise they made sometimes was audible in the Choir while services were being conducted, to the dismay of the clergy conducting them. The Nave—with its doors on both the north and south sides about midway between the West Front and the Crossing—became a shortcut for tradesmen to cut through Paul's Churchyard while carrying their sides of beef or mutton or other goods for sale in the city's commercial districts.



Figure 8: St Paul's Cathedral, the North Side of the Nave and the Cross Yard. Source: (Rendering by research team)

Outside, merchants built commercial structures alongside the Nave and North Transept to store and sell their wares. In the Cross Yard (Figure 8), the northeast corner of the Churchyard, a medieval Charnel House was torn down, allowing booksellers to build multipurpose buildings housing their bookshops on the ground floor and their domestic lodgings in the stories above.

CONCLUSION

Most of all, however, our concern is with what was happening inside the Choir of St Paul's (Figure 9), where the Bible was read, as structured by the Lectionary, where sermons were preached in the context of Prayer Book worship, where prayers were offered, the creeds were recited, and the sacraments were observed. This practice, this exercise of what one might call "lived religion," helps us recognize the nature of the English Reformation in its creation of a pragmatic tradition, at least hypothetically universalist in its theological outlook. Traces of this kind of Reformation are to be sought in the changes in the arrangements of liturgical space and in the functions they enabled.



Figure 9: St Paul's Cathedral, the Choir. Source: (Rendering by research team)

In this context we are enabled to discuss questions of meaning and significance as becoming important and understandable in process instead of as part of static and enduring formulations. The Virtual St Paul's Cathedral Project and its companion the Virtual Paul's Cross Project remind us that the early modern sermon is primarily an act of

performance, conducted in the relationship between priest and congregation on a specific occasion and in a specific architectural setting. We are also called to recognize that part of the context for every sermon is the matrix of biblical texts appointed for public reading on that day by the lectionaries of the Book of Common Prayer. We can understand more fully the surviving texts of early modern sermons by situating them in reconstructions of their original settings, recognizing that the texts that survive represent, at best, scripts for their performance and, more commonly, only provide traces of the lost original. Sermons now can be viewed as occasion-specific, deeply contextual, interactive performances that take meaning from the liturgy surrounding them and contribute to the overall action and understanding of the gathered congregation.

We therefore propose that the Cathedral Project demonstrates the enduring value of exploring—for any surviving sermon or theological text for which we can determine the exact or approximate date of its composition and, for sermons, the date, time, and place of its original delivery—the following considerations:

1. The importance of the physical space of the event—can we reconstruct the material and acoustic properties of the space? What issues might there be for audibility? For visibility? For atmosphere?
2. The importance of the worship service that forms the context of a sermon—what day is it? What season of the liturgical year? What are the themes of the texts of the service? How does the preacher respond?
3. The importance of the specific Scripture readings read at these services, as well as in the days of sermon preparation
4. The importance of other variable parts of the service, such as the Collect, or prayer, for the Day.
5. The importance of who is in attendance—crowds at a Paul's Cross sermon had a different composition from congregations inside St Paul's, or at the Chapel Royal, or at St Dunstan's, or other parish churches.

Clergy delivering sermons are affected by all of the above factors as well as their own theological biases. Above all, they are affected by the fact that their sermon is a collaborative performance in a specific space and liturgical context and on a specific occasion. Sermons are rhetorical, in that they are more about teaching, delighting, and moving their participants than they are about declaring a theological interpretation apart from their performative context. They are about process, about participating in, responding to, and shaping the experience of process. And in the unfolding of that process they will make, or find, their meaning.

ACKNOWLEDGEMENTS

The Principal Investigators for the Virtual St Paul's Cathedral Project wish to thank the many graduate students in Architecture (notably Austin Corriher, Caroline Cox, Jordan Gray, Grey Isley, and Joshua Stephens) and Engineering (particularly Seth Hollandsworth) without whose efforts this project would not have happened. We also wish to thank Ben Markham and Matt Azevedo of Accentech, in addition to the many linguists, actors, singers, and musicians who brought our scripts to life; without their contributions this project would not have happened. We also thank distinguished architectural historian Dr. John Schofield and the members of our Advisory Committee; without whose support this project would not have happened. We thank the members of our university's administration; without whose support this project would not have happened. We also thank the National Endowment for the Humanities; without whose financial support this project would not have happened.

REFERENCES

- Dugdale, William. 1658. *History of St Paul's Cathedral*. London.
- Komorowski, Waldemar. "Layering of Facades: A Few Comments on the Colour of Krakow's Facades in Earlier and Contemporary Times." *Geology, Geophysics, & Environment* Vol. 40 No. 2 (2014): 171-180.

Witness: Connecting People, Place, and Building

Jori Erdman¹, Becky Beamer²

¹James Madison University, Harrisonburg, VA

²OSLOMET University, Oslo, Norway

ABSTRACT: Through the humanities, we study and build knowledge of human experiences and events. In this case study, we will be sharing a strategy for interdisciplinary collaboration through two stories of people-first, collaborative processes, and methodologies. First, the story of making a socially engaged architectural project in the Deep South spearheaded by the architecture firm of Duvall Decker. The catalytic effect of this story drives the second. In the second, we tell a story about producing a short documentary film that reflects the emotions, archival context and visual connections of the architectural project by an international and interdisciplinary set of researchers. Analyzing the collaborative filmmaking and architecture project development process reveal five shared characteristics that shape the success of these innovative endeavors: project commitment, project definition, role identification, agreed flexibility, and pre-defined and anticipated areas for personal growth and opportunities for project support. In defining these characteristics, we discover the complexities and possibilities in collaborative methodology, processes, and the possibilities for exciting outcomes when the relationships between researchers, clients, users, and architects are fully considered. This case study opens a template for researchers, professionals, and communities who strive to build a stronger community at the intersection of the humanities and the arts.

KEYWORDS: south, documentary, engagement, social justice, place

INTRODUCTION

This paper presents a story within a story. The primary story reveals the nature of interdisciplinary collaborations that are informally conceived among individuals and fostered by disciplinary difference. This is not a novel concept, as Carole Palmer and Laura Neumann point out, "Relying heavily on informal collaborative relationships, scholars manage their interdisciplinary information work by developing strategies for exploring and translating information from unfamiliar domains" (Palmer, 85). Their argument builds on this idea in the studies of the humanities and the sciences of discussing similarities and differences.

The connection between disciplines hinges on collaborative storytelling. Collaborative storytelling is the process of a group of individuals sharing their individual embodied and lived experiences to come up with a shared story. According to Silva and Silva's research a Story Mediator guides individuals and groups through the process and should adeptly consider all nuances while leading the process and outcome (Cleland Silva, 2002). In the case of the two stories presented through our paper, the architecture firm, Duvall Decker served as one story mediator and for the film, the authors are serving as story mediators. The role of the Story Mediator is further evidenced in the interpretation and outcomes of the story project. Our collaborative storytelling narrative between architecture, film, and community tells a more well-rounded story offering a richer understanding of the subject matter with the possibility to reach a much wider audience than we could reach individually.

The role of the Story Mediator as identified by Tricia Cleland Silva and Paulo de Tarso Fonseca Silva is similar to our interpretation of the filmmaker Trinh T. Minh-ha's concept of "witness" or "speaking nearby." The people (architects and filmmakers) responsible for shaping a version of the story must actively resist the urge to control the narrative and story but must allow the story to emerge from the collective without judgement and prejudice to get at the most authentic story.

Our collaborative storytelling project involves three key characters: an architecture firm, the researchers, and a community.

THE FIRM: Duvall Decker is an architecture firm located in Jackson, Mississippi which has spent the last 20+ years engaged in social justice architecture for underserved communities in the state and region. Their engagement strategies work to include all voices in the design process.

THE RESEARCHERS: Researcher 2 (documentary) and Researcher 1 (architecture) are the primary investigators in the film project. Both have previously completed considerable research projects in and about the Deep South.

THE COMMUNITY: All of the stakeholders who have participated in the architectural project as well as the general population and environment of Jackson, Mississippi.

The three main characters communicated over about six months prior to meeting in person to begin to document the processes to design a center for equity and justice in Jackson, Mississippi. Upon reflecting on the gathered media, we have identified five characteristics that shaped the process for our collaborative endeavors:

- Project Commitment - willing engagement by researchers and project community
- Project Definition - discuss timeline, shared values, and aspirations
- Identify roles, responsibilities, and expectations
- Agreement for Flexibility - Allowance for differences
- Define Strengths and Weaknesses - Anticipate areas for improvement and support

These characteristics build on each other to produce surprisingly innovative outcomes.

1.0 ENGAGE WILLINGLY

The collaborative storytelling project began like a typical *road film* (Hurault-Paupe 2014) in which the main characters, seemingly with separate goals, unite to go on one epic journey. One researcher was already working on an architectural history project about Duvall Decker, a small architecture firm in Jackson while another researcher was completing her first full-length documentary about the University of Alabama. They met several years before while teaching at the American University of Sharjah but moved on to the USA and Norway. They stayed in touch and their lives intersected again when the architecture researcher believed that Duvall Decker might be better represented through the storytelling potential of film and thought the two could join forces to examine the South as a place of ongoing racial reckoning. The film researcher agreed and the two set off on an epic road trip to use material culture, specifically the medium of film, as an educational framework for how culture is reflected in the production of buildings and communities. Along the way, the willingness to engage with the project extended to the architectural firm, Duvall Decker, Tougaloo College, and the greater community of Jackson Mississippi. A willingness to engage, a commitment to the project, is one of five characteristics of our collaborative storytelling process template.

2.0 DEFINING THE PROJECT

This project takes place at the intersection of several humanities disciplines allowing for a robust reflection of our society and culture. The disciplines central to this project are architecture, architectural history, oral history, and art. The medium for dissemination is documentary filmmaking. The collective project description is complex and includes an understanding of Mississippi history, the local community, architecture, and documentary filmmaking constraints. All participants needed an understanding of each other's project scope to work together to tell a well-rounded story.

2.1 Scope of the Architecture Project

The community of Jackson, MS defined a need for further research and understanding related to the racial relationships as informed by the context of the region. The local government and Episcopal Church envisioned a center that could accommodate new relationships and open discussions. This environment was originally conceived as the Gray Center for Racial Justice and Reconciliation. The Gray Center was originally designed as a retreat property owned and operated by the Episcopal Diocese of Mississippi. Overtime, the property proved unsustainable and so, the Episcopal Church Building Fund stepped in with an offer to support a feasibility study aimed at turning the property into a space of racial reconciliation or what the church canon calls "Becoming Beloved Community." The feasibility study and community discussions determined the Gray Center was not the best fit for the project and the team turned their eyes to a pillar of the civil rights movement, Tougaloo College. The project transformed into its current state, the Tougaloo Center for Justice and Equity.

2.2 Scope of the Documentary

The documentary film project tells this uniquely Mississippi story about a diverse group of people coming together in the design process through engagement and listening to create a transformative project. Based on financial constraints, the film is designed to be produced with a crew of two people with a total running time of 8-10 minutes. The film will briefly set the historical context of the region, layout of the scope of the architectural project, and offer behind the scenes access to the process of community engagement. Persons related to the architectural project and who hold a deep personal connection to place were interviewed for the documentary.

3.0 METHODS AND PROCESSES

We relied on the creative practice-based method of documentary filmmaking for the interdisciplinary collaboration. The researchers collaborated to outline a process that highlighted the strengths of everyone by defining roles and responsibilities. Throughout the process, the researchers agreed to allow a significant amount of flexibility in the story telling and content based on community engagement. This design was echoed by the architectural project methodology in which discussions with the community, and historical context informed the transformation of the project. A definition of personal responsibility, ability to be flexible, and then a clear line of communication are the remaining characteristics that flesh out our template for collective storytelling.

3.1 Interdisciplinary Storytelling Connections

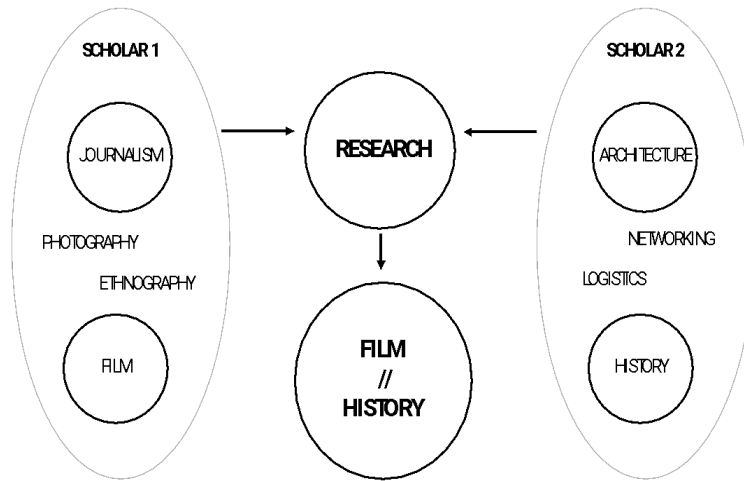

Figure 1: Interdisciplinary expertise and process diagram. Source: (Author 2022)

The researchers discussed terminology and methods that would overlap for creative and collective storytelling methodology and practical delegation of communication with the architectural firm, interviewees, and community sources (Figure 1).



Figure 2: Photograph of Roy Decker, Duvall Decker architecture firm. Source: (Author 2022)

3.2 Methods and Processes – Architecture Project

The architecture firm of Duvall Decker developed an innovative technique for project design centered around community engagement (Figure 2). This process length and participants vary for each project. For the process followed in this project, Duvall Decker, along with a team of community activists and professionals and in partnership with the

Episcopal Church, endeavored to develop ideas of embodied justice and equity. After in-depth historical research, a series of discussions were held. Their efforts resulted in a process of broad and deep engagement on the idea of what this place, a center for equity and justice, can or should be.

As their conversations evolved, the scope and design of the project shifted. By studying history and engaging in conversation they discovered shared values and aspirations, and thus, a more meaningful project definition began to emerge. For example, as a result of the candid conversations and consensus building nature of the community, the name of the project was rejected and the name Center for Justice and Equity came forward to replace it. Then, the physical site location was shifted to better reflect the region and possible uses of the space. While the original team is still intact, the addition of Tougaloo College as a partner was necessary to open new and exciting possibilities for the project.

As of this writing, the project consists of five components that embody the shared values of the group: retreat, academy, re-vest, village, and remembrance. Through open and trusting conversations and mediated storytelling, the group reached consensus about the path forward for the architecture project.

3.3. Methods and Processes - Documentary

Because the project was being created in an open and collaborative manner, the architecture firm was open to collaborative storytelling processes and outputs. We gained access towards the beginning of Duvall Decker's architectural research and design process (Figure 3).



Figure 3: Photograph of Duvall Decker architecture firm illustrating creative practice-based research. Source: (Author 2022)

Generally, the documentary film process is designed following a creative-practiced based research method, in four phases: pre-production, production, post-production, and distribution (Beamer and Gleason 2022). It is impossible to complete a documentary film in isolation so, this working method fits nicely into the collaborative storytelling purpose.

During the pre-production phase, the researchers collaborated and planned production of the film over zoom for about six months prior to spending a week in Mississippi shooting the short film. During this time, the researchers conducted preliminary interviews, wrote a budget, discussed story points, and finalized logistics for the shoot. The length and topics for the documentary were discussed based on the budget and field time. The architectural scholar, who already developed a long standing and trusted relationship with the firm and the community took the lead during this phase.

In the field, during the production phase of the film process, we conducted on-camera interviews, gathered archival media, and built relationships with the local community. Additional time was spent in archival research to further understand and better tell the visual story of this historic project. Interviews and oral histories include current Tougaloo President Dr. Carmen J. Walters, as well as members of the Duvall Decker staff (Figure 4 and 5). We reviewed community meeting recordings. Historical sources include the Tougaloo College archive as well as the Mississippi Department of Archives and History. The industry standard for legal agreements between the documentarians and all subjects, locations, and acquired media is a release or legal document with a signature for the project and all participants signed these documents. The film scholar took the lead during this phase of the creative process. The architectural scholar took on the responsibility of documenting our process and therefore was underrepresented in our production process photographs.



Figure 4: Author interviewing Tougaloo President Dr. Carmen Walters. Source: (Author 2022)



Figure 5: Author documenting the day-to-day process at the firm. Source: (Author 2022)

The next phase of the project is post-production where all materials are cataloged, the storyline is produced, and the materials are edited into the film output. The researchers worked together at all stages of this process but the film scholar took the lead on the technical aspects of the editing process.

The final phase of the documentary process is distribution. The architecture scholar will take the lead on organizing a community screening and panel discussion for the release of the film to the community.

3.4 Flexibility and Support

An important characteristic of the process is being flexible and supportive. Team members need to trust one another enough to reveal weaknesses and recognize strengths. Supporting each team member through the difficult process of being vulnerable through the evolution of a project means that everyone will be included and heard throughout, and the creative process will be more fruitful. For example, the architectural scholar had no experience with filmmaking but was able to provide local coordination, a network of established relationships with interviewees, and knowledge of architecture in the state.

As discussions and the story arc develops, things will inevitably arise that mean change and adaptation. In the process, team members need to continue discussions to make sure that everyone is being heard and the goals of the project are not lost. While the architectural project was challenged during the process with evolving financial concerns, they were able to be flexible in terms of a site and in fact, are more satisfied with the Tougaloo College site.

4.0 OUTCOMES AND FUTURES

With a focus on the development of the racial justice and equity center in Mississippi, both the process and the film highlight the importance of working together with a range of voices, including those that are often marginalized. As the filmmakers came together from our distinct disciplines (architecture, film making, ethnographic studies), we also engaged in a collaborative process that shares the characteristics defined above. The discussed template and collective storytelling project characteristics are designed to assist future interdisciplinary collaborations.

The final creative output, the projected 8-10 minute documentary film, is in the post-production phase with an anticipated completion date in 2023. In addition, the researchers completed a short poetic documentary film ([LINK](#)) capturing the gravity of the history and inspiration of the environment during the planning of the equity and justice center. In collaboration with Tougaloo College, the researchers plan to offer a screening of the film and panel discussion to further engage the community around discussions of race, architecture, and history.

Both researchers worked to access grant funding for the project but, the timeframe and economy limited options for support. The researchers agreed to self-fund the documentary film and limit the scope of the project with future aspirations of support for expanding the documentary to follow the physical manifestation of the architectural project.

The Tougaloo Center for Justice and Equity will continue to develop and transform over time. This is only the beginning, and the researchers acknowledge future opportunities for growth and development of this projects with financial and continuing community support. The researchers acknowledge the biases they have, as outsiders, to Jackson, MS. Additionally, the researchers understand that there are project limitations related to finances and schedule of the architectural project.

CONCLUSION

To be a witness, one must have observed an event or experience and be able to communicate that experience, and the importance of the experience, back to an audience through a medium. Although in some sense, witnessing involves the passive activity of observing, the action of witnessing requires the witness to make a leap between seeing and then conveying what was seen to an unknowing audience. As architects, if we are determined to be responsive to the environment and humanity, we feel called upon to observe sites, people, and culture. In turn, those observations are filtered through professional judgement to create plans and buildings that in some way respect those observations in both form and process. In the case of Duvall Decker, form comes from deep and comprehensive engagement through expansive processes that speak to connections with people and culture.

Another cultural enterprise that strongly associates with the idea of witnessing is journalism and the associated form of documentary filmmaking. Journalists are expected to observe all manner of human activity without interference, and they must reflect what they observe back to the world in a manner that is compelling to the viewer. The audience should be both informed by the story that is being witnessed to them but also moved in some way. The mark of a great journalist, as reflected in the Pulitzer Prizes each year, is to bring great stories to the global community through reporting that is fair, honest, accurate and well-crafted in the interest of the public good. Although this has not been a standard for architect's perhaps it is something the profession should consider.

The documentary filmmaker, Trinh T. Minh-ha has reflected on her approach to the people and cultures she works with as "speaking nearby" rather than speaking for.

Interviewer: I'm also intrigued by your works where you mention "talking nearby instead of talking about" – this is one of the techniques you mention to "make the visible the invisible." How might indirect language do precisely that?

TTM: The link is nicely done; especially between a “speaking nearby” and indirect language. In other words, a speaking that does not objectify, does not point to an object as if it is distant from the speaking subject or absent from the speaking place. A speaking that reflects on itself and can come very close to a subject without, however, seizing or claiming it. A speaking in brief, whose closures are only moments of transition opening up to other possible moments of transition – these are forms of indirectness well understood by anyone in tune with poetic language. Every element constructed in a film refers to the world around it, while having at the same time a life of its own. And this life is precisely what is lacking when one uses word, image, or sound just as an instrument of thought. To say therefore that one prefers not to speak about but rather to speak nearby, is a great challenge. Because actually, this is not just a technique or a statement to be made verbally. It is an attitude in life, a way of positioning oneself in relation to the world. Thus, the challenge is to materialize it all aspects of the film – verbally, musically, visually. That challenge is renewed with every work I realize, whether filmic or written. (Chen, 1992,87)

The way that Duvall Decker approaches community engagement presents an example of how they witness as a form of speaking nearby rather than speaking for. Their process is time and labor intensive. It involves listening from the first moment. They start each session without the typical trappings of community charettes such as maps, post-its, stickers, and charts. They start with each group by sitting around a table, usually with some food and refreshments, to pause with people and get to know each other. They share their story of coming to Jackson and setting up an architecture practice and listen as each member of invited group shares their story of living in their community. They take notes and maybe record the sessions and that is the beginning of building trust and relationships with people. And it is never just one group, it is multiple and varied groups that might include church leaders, parents with small children, elderly residents, and social service agencies. They are quiet and humble, they listen and watch, absorbing the emotions, desires, worries and dreams of each group in turn. As the designs develop, the architects are constantly checking their work against their observations from those early meetings. Often these leads to plans and projects that weren't originally in the scope of what they were asked to do by the “client”.

ACKNOWLEDGEMENTS

The authors gratefully acknowledge Duvall Decker Architects for source material and time volunteered by Anne Marie Decker, Roy Decker, Shannon Gathings, Tougaloo College President Dr. Carmen Walters for in-depth interviews for this project. This research would not be possible without the continuing support by the citizens of Mississippi, Duvall Decker architecture firm, Episcopal Church, Tougaloo College and our associated institutions. All editorial, ethical, and creative decisions remain in the hands of the researchers.

REFERENCES

- Beamer, Becky, and Kimberly C. Gleason. 2022. “Reflections on the Impact of Informal Sector Tourism on Indigenous Namibian Craft Processes.” *Arts and the Market* 12 (1): 1–16. <https://doi.org/10.1108/aam-05-2020-0015>.
- Chen, Nancy. “‘Speaking Nearby:’ A Conversation with Trinh T. Minh-ha.” *Visual Anthropology Review*, vol. 8, no. 1 (1992) pp. 82–91. <https://doi.org/10.1111/var.1992.8.issue-2>.
- Cleland Silva, T., de Tarso Fonseca Silva, P. (2022). *The Work of Story Mediators*. In: *Making Sense of Work Through Collaborative Storytelling*. Palgrave Macmillan, Cham. https://doi.org/10.1007/978-3-030-89446-7_4
- Hurault-Paupe, Anne. 2014. “The Paradoxes of Cinematic Movement: Is the Road Movie a Static Genre?” *Miranda*, no. 10 (December). <https://doi.org/10.4000/miranda.6257>.
- Palmer, Carole and Laura J. Neumann. “The Information Work Of Interdisciplinary Humanities Scholars: Exploration And Translation.” *Library Quarterly*, vol 72, no 1 (2002) pp 85-117.

ARCC 2023 RESEARCH PAPERS
Research and Design Track

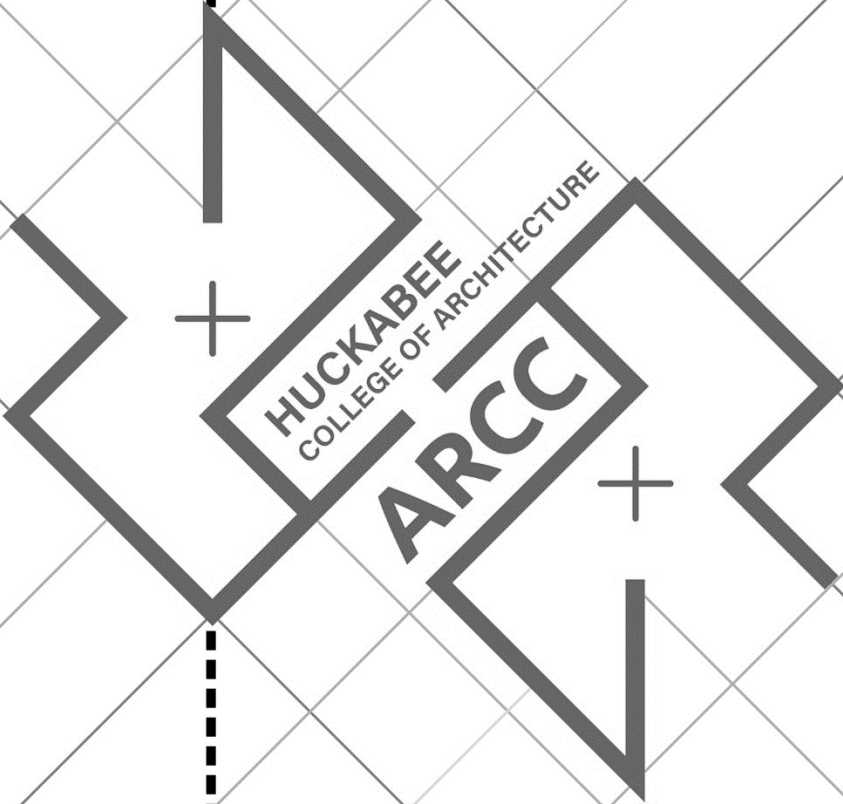

A “Jobs to be Done” Approach to Programming and Design for Diverse Communities

Brian Schermer¹

¹University of Wisconsin-Milwaukee and Workshop Architects, Milwaukee, WI

ABSTRACT: Architectural programming is the process by which practitioners and clients define the scope and nature of a future architectural project. “Problem seeking” as an approach to programming has a long and influential history within the profession. It is a framework to systematically collect and analyze project-related information and identify problems to solve through design. To broaden and empower the range of voices that can inspire programming and design this paper reframes “problem seeking” as identifying “jobs to be done.” This approach is a form of contextual inquiry that focuses on the assumptions and values underlying people’s choices to “hire” a product, procure a service, or in the context of programming and design, choose a place to invest their time. “Jobs to be done” fulfill both functional requirements and social and emotional needs. This paper describes how a “jobs to be done” approach informed the visioning, programming, and design of a new campus center for the Georgia Institute of Technology. The process solicited input from a diverse range of community members about the role of a future campus center. “Jobs to be done” statements were drafted as working hypotheses and then presented in workshops for participants to sort, discuss, debate, and revise. The final strategic vision identified the key “jobs to be done” by the new campus center and inspired the conceptual design for the project. “Jobs to be done” ensures that individual voices are heard while achieving a high degree of consensus. This approach can apply to similar projects that serve diverse communities.

KEYWORDS: programming, planning, diversity, campus design

INTRODUCTION

The purpose of architectural programming, in addition to defining the scope and nature of a future architectural project, is to identify the problem to be solved through architectural design. The architecture firm most associated with establishing a process for programming as “problem seeking” is Caudill Rowlett Scott (CRS).

The CRS approach to architectural programming has had a powerful influence on architectural practice. Now in its fifth edition, *Problem Seeking*, the firm’s primer on the topic, provides a roadmap to conduct the process (Peña, 1969). It describes how information gathered in the initial phase of a project can be organized into a matrix to highlight important findings and avoid “data clog.” Horizontal rows organize data into four categories: form, function, economy, and time. Vertical columns further parse information into additional categories: goals, facts, concepts, needs, and finally, discreet statements of the problem.

Problem seeking evolved as CRS developed efficient pre-design processes to plan and design school buildings during the postwar baby boom (King et al 2002). According to the firm’s lead programmer, William Peña, a key moment occurred in 1950 while the CRS team was working on a high school for Norman, Oklahoma. Firm founder, Bill Caudill displayed the information from his pre-design research on the wall of his hotel room. Later that week, Caudill showed Peña what he discovered. Peña recalled:

“Look what I’ve got,” [he said]. He had six salient considerations for the design of the Norman High School. We didn’t recognize it at the time, but it was a statement of the problem. He asked, “What do you think of this?” He had these six statements not related to the solution, not design solutions. They stated a condition. For example: “Since the students in a high school spend a lot more time in the halls than they do in an elementary school, if you spend ten minutes of every period there and have six periods, you have sixty minutes in the halls. Therefore, the halls should be made part of the teaching process and exciting.” He had six of this kind of statement. Later—much later—we looked back on them and said, “That was the first statement of the problem; Bill had avoided the solution.”

That insight generated a problem statement with clear implications for design. The architects organized the classrooms along wide, single-loaded hallways facing a courtyard. Floor-to-ceiling windows surrounding the courtyard ensured that the time spent between classes would enhance social connection and provide natural light and attractive views. Completed in 1951, the school received a First Honor Award from the American Institute of Architects in 1954.

The virtue of the problem seeking approach, according to its practitioners, is that it is objective while succinctly framing design problems. Yet, problem seeking has been criticized for ignoring critical “architectural values” that are necessary

RESEARCH AND DESIGN

to create inspirational architecture (see Hershberger, 1999) or for failing to reveal “hidden programs” that perpetuate social dysfunction and injustice (Silverstein and Jacobson 1978).

Most architects recognize the importance of identifying the problem to solve through design. Such insights are celebrated in architectural history courses as well as stories that architects share among themselves. How architects discover generating ideas varies. For Caudill, it was a clear display of relevant information. For other architects, it might be insight derived through inspirational conversations with their clients. Consider, for example, Jonas Salk hiring Lou Kahn to design the Salk Institute as “a place he could invite Picasso” (Reed 2002, 126).

A different criticism can be leveled at problem seeking approaches exemplified by architects who use their intuition and design creativity. Concentrating the function of problem seeking in the hands of a powerful and creative few might overlook the needs of people who will use a future building. It can be especially damaging when designing for diverse communities that lack voice and power, and it raises important questions about the nature of authorship and the sourcing of inspiration.

Ideas that generate design solutions, Darke (1987) notes, tend to be subjective, designer-imposed constraints. If generating ideas are subjective, does it matter whether their source is the architect, client, users, or the result of collaboration and co-creation among them? And, if the community for whom the project is designed is diverse, does it not behoove the problem seeking process to accommodate everyone?

1.0 JOBS TO BE DONE APPROACH

This paper describes a “jobs to be done” approach for programming and design for diverse communities. “Jobs to be done” was developed by Harvard Business School’s Clayton Christensen. Christensen is best known for his work in disruption theory described in his book, *The Innovator’s Dilemma* (1997). “Jobs to be done” analysis is a form of contextual inquiry that focuses on the assumptions and values that underlie choices to “hire” a product, procure a service, or for the purposes of architectural programming and design, to invest time in a particular place. “Jobs to be done” addresses both functional requirements and critical social and emotional needs. For example, going to a café to eat clearly fulfills a function. Yet, the choice on the part of people from an underrepresented minority group to eat in a place in which they can connect with people from their own culture may reflect to deep-seated needs for social connection and safety.

The discovery of “jobs to be done” for programming involves drafting a range of working hypotheses. These are presented in workshops for participants to sort, discuss, debate, and revise. Finally, participant comments and collective wisdom are synthesized into statements that articulate why people would choose to invest their time in a setting. The “jobs to be done” writing process weaves the many voices of a diverse community into a cohesive and inclusive vision that provides insights that address shared needs.

2.0 CASE STUDY: GEORGIA TECH CAMPUS CENTER

A “jobs to be done” approach informed this case study: the strategic visioning, programming, and design for a new campus center for the Georgia Institute of Technology. Georgia Tech students represent a broad range of backgrounds, cultures, and interests. At the time of the study, 55% of students were White, about 24% were Asian, 8% were Hispanic, 7% were Black, and 4% identified as Multiracial. About 25% were international students. The overarching goal of this approach was to assist the Georgia Tech community in finding its collective voice in articulating the essential roles that the center should play for students, staff, and faculty.

After reviewing Georgia Tech’s strategic planning documents, the author and his colleagues embarked on a five-day “immersion” visit to Georgia Tech. They arrived with assumptions about the potential roles for a new campus center. Among these was that it might be a place to showcase innovation, highlight technology, promote leadership, and further enhance what the campus called in its strategic plans a live-work-play community. These initial assumptions proved wrong. Nevertheless, initial discussions with student faculty and staff revealed that they were far more interested in creating a place that could be more restorative, support “work-life balance,” and help students experience the outdoors.

Stress reduction was very much on the minds of Georgia Tech students, faculty, and staff. The evidence was more than anecdotal. The student newspaper, *The Technique* reported results from a student government-sponsored survey, which found that a large majority of students (82%) reported feeling a high degree of stress, mostly due to academics. Georgia Tech Staff and administrators were unequivocal about the situation facing their students:

Tech students are ambitious, but they also undervalue happiness.
There is a lot of competitive martyrdom. We talk a lot about work-life balance.
They feel guilty about stepping back from academics.
Students don’t know how to take a break.

The Georgia Tech campus offered few places for students to take breaks. During a collaborative mapping exercise, students identified a limited number of natural settings that could provide the kind of “soft fascination” that restores

attention and reduces stress (Kaplan et al 1989). The existing student center earned only scant attention as a place for restoration. Part of the problem was that students felt too busy to take even a short walk to the Student Center. Georgia Tech students needed a place to “refuel in flight.”

The idea that the new campus center should be a place to restore and refuel was explored further in “jobs to be done” workshops. Based on the results of the first campus visit, the study team identified 17 working hypotheses that emerged during the first visit. The format of each workshop consisted of a sorting task exercise undertaken by small discussion groups, consisting of four to six people each. Four student workshops were held with a total of 72 students who represented a diverse cross-section of the campus population. The students sorted “jobs to be done” statements (which were laser cut onto durable wooden placards) along with stacks of smaller-cut cards with 40 different activities that might be associated with the “jobs to be done.” Additional sessions included graduate students (25 participants) and a group of campus administrators. The sorting task workshops yielded both quantitative and qualitative data. The following is a sample of comments elicited:

- It should be a place to relax, not in the active sense of the Campus Recreation Center, but to hang out with friends and watch a game.
- Students’ lives are already inundated with thinking about career. I don’t know if I want another place to do that because I do that everywhere. I would like a place to relax for a bit.
- Power napping throughout the day—hundreds of people would be using this resource because everyone needs sleep.”
- It would be nice to have a coffee area or contemplation space to relax or chill out.
- Most important: Getting away from the academic part because we get enough of that.
- We need to do something quiet and recharge. There’s no place to do that.



Figure 1: Students sorting “jobs to be done” statements. Source: Workshop Architects

3.0 REFINING “JOBS TO BE DONE”

After the “jobs to be done” workshops, the study team returned to the campus to explore planning and design concepts for the Campus Center. Students participated in a three-dimensional relationship puzzle exercise to enlist their help in exploring optimal site adjacencies and to test alternatives at a diagrammatic level. These sessions included introductory remarks that summarized earlier findings from the “jobs to be done” workshops.

The relationship puzzle consisted of three stacked levels of plexiglass, placed on an abstract site indicating the relative positions of adjacent buildings and outdoor spaces. During one workshop, students mused about how they could use the rooftop of a new building for fun, casual conversations, and as a place to reset:

- The roof of the Campus Center could also be a place that you could use as an event space, a concert, an open mike that’s outdoors and fun....
- And then, having a bar and fireplace for the social/experiential where we can sit and chat....
- That’s our “reset” place, you go up to the roof and reset.



Figure 2: 3D relationship puzzle. Source: (Workshop Architects)

RESEARCH AND DESIGN

These comments crystallized for the study team a critical project imperative: “The Georgia Tech Campus Center should be a place to reset, restore, and refuel.” It also led to an important design concept. Because students lacked time to visit a new centralized campus center, the center should be distributed to bring it closer to them. With the encouragement of campus leadership, the study team developed the concept of an experiential path that would distribute campus center facilities across a quarter-mile swath of the campus.

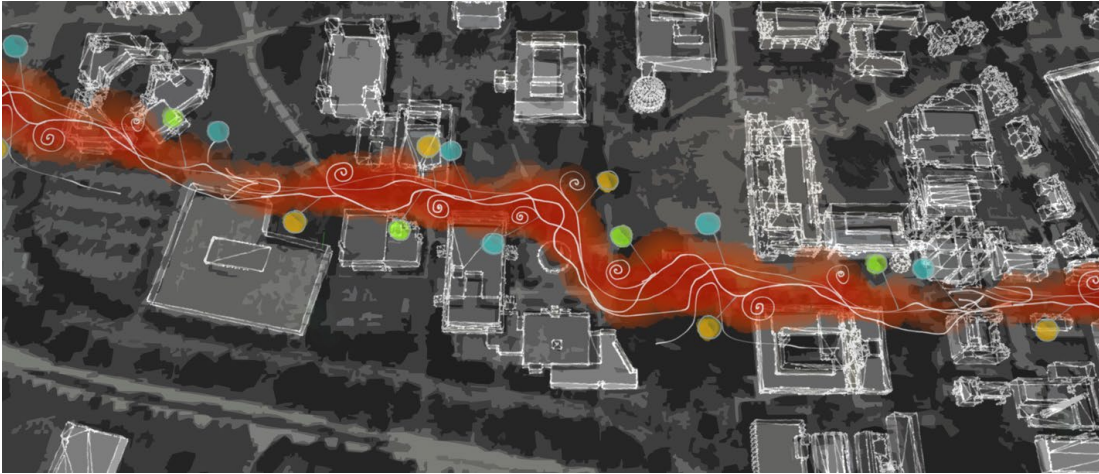

Figure 3: Concept diagram of the campus center distributed along the experiential path. Source: (Workshop Architects)

In addition to “reset, restore, refuel” four other consensus “jobs to be done” emerged. The Georgia Tech Campus Center should be a place to:

- Serve the entire Georgia Tech community: undergrads, grads, staff, and faculty.
- Showcase Georgia Tech’s brand and be a catalyst for creative expression.
- Build friendships and bridge across cultures, disciplines, and interests.
- Promote leadership, involvement, and finding one’s niche.

4.0 IDEAS COMPETITION AND RESULTING PROJECT

In 2017, Georgia Tech invited architecture firms to compete in an Ideas Competition to design the project. The competition brief included the strategic visioning study and its supporting research. The original study from Workshop Architects, along with partner firms Cooper Carry, OLIN, and Gilbane, was selected to implement a design-build project. The winning strategy conceptualized the Campus Center as a “distributed student union” consisting of five buildings located along an experiential path from the Campus Recreation Center eastward to Tech Green. The result is a series of richly articulated buildings, plazas, overlooks, and greenery that provides greater access to nature and affords opportunities for social, creative, and intellectual engagement.

The new Campus Center opened in fall 2022. Before construction, “jobs to be done” was used to establish a pre-occupancy performance benchmark of the old student center. A post-occupancy evaluation is planned for Fall of 2023.



Figure 4: Site plan of the Experiential Path and campus center buildings consisting of, from left to right, Exhibition Hall, Pavilion, Café, John Lewis Student Center (renovation), and Stamps Commons. Source: (Workshop Architects)



Figure 5: View eastward along the Experiential Path from the Arts Plaza toward the renovated John Lewis Center. Source: (Melissa Clark, Workshop Architects)



Figure 6: The view to the new, light-filled Stamps Commons and renovated John Lewis Student Center in the background. Source: (Melissa Clark, Workshop Architects)

CONCLUSION: PROBLEM SEEKING VERSUS “JOBS TO BE DONE”

Both problem seeking and “jobs to be done” focus on defining the scope and nature of a future architectural project. Both approaches focus on identifying the critical issues to address through design. There are some differences, however. Problem seeking is associated with objective problem statements to streamline the programming process. It is essentially neutral about who should be involved and how much they should influence decisions. The “jobs to be done” approach, on the other hand, explicitly engages diverse voices within a community. It honors differences, achieves consensus, and creates a shared vision around which a diverse community can unify.

Since the Georgia Tech study, the “jobs to be done” approach has informed several student-oriented campus projects. For example, at the University of Michigan, it clarified that the Michigan Union should be a place where students could “experience the essence” of the university. At the University of Illinois at Urbana-Champaign, the process clarified that the Illini Union should be for all students, especially the many international students, a “union without borders.” In offering this description, it is hoped that a “jobs to be done” approach will help architects and planners engage diverse communities everywhere more thoughtfully and effectively.

REFERENCES

- Christensen, C. September 2016. Know Your Customers’ Jobs to be Done. *Harvard Business Review*.
- Christensen, C. 1997. *The Innovator’s Dilemma: When New Technologies Cause Great Firms to Fail*. Cambridge, MA: Harvard Business Review Press
- Darke, Jane. (1978). “The Primary Generator and the Design Process.” *Proceedings of the Environmental Design Research Association Conference*, Tucson, Arizona, pp 325-337.
- Hershberger, Robert G. *Architectural Programming and Predesign Manager*. New York: McGraw-Hill, 1999.
- Kaplan R. and Kaplan, S. 1989. *The Experience of Nature: A Psychological Perspective*. Cambridge University Press
- King, Jonathan, and Philip Langdon. *The CRS Team and the Business of Architecture*. College Station: Texas A & M UP, 2002
- Peña, W. *Problem Seeking: An Architectural Programming Primer*. Washington, DC: American Institute of Architects, 1969.
- Reed, P. 2002. In Matilda McQuaid, ed., *Envisioning Architecture: Drawings from The Museum of Modern Art*, New York: The Museum of Modern Art, p. 126.
- Silverstein, M. & Jacobson, M. 1978. Restructuring the Hidden Program: Toward an Architecture of Social Change, in W.F.E. Preiser, ed., *Facility Programming*. New York: Van Nostrand Reinhold, 7-26

Analysis of Donald Judd's Design Language for the "100 untitled works in mill aluminium"

Mehrdad Hadighi¹, Mahyar Hadighi²

¹Pennsylvania State University, University Park, PA

²Texas Tech University, El Paso, TX

ABSTRACT: In this paper, shape grammar is implemented as a design methodology to analyze the design language of Donald Judd's "100 untitled works in mill aluminum"—permanently installed at the Chinati Foundation in Marfa, TX. Judd (1928-1994), an American artist, writer, and critic installed 100 aluminum objects—with the exact same outer dimensions (41"x51"x72") but unique configuration, all made from ½" mill aluminum plates—over a four-year period from 1982 through 1986 in two former artillery sheds of a de-commissioned US military base. The question we are seeking to answer is whether these 100 works belong to a system, and, if so, what that system is and what delimits the system to produce 100 objects. Our hypothesis, having spent considerable time examining the works and exploring the archival materials, is that there is a system, but the system is tempered by improvisational moments at multiple junctures in the project. We are interested in deciphering the system, but also the moments where Judd's artistic vision supersedes the system. We foresee Judd's simultaneous engagement of systemic and improvisational design processes to contribute to an architect's design process and methods.

KEYWORDS: Donald Judd, Design System, Shape Grammars, Serial Art, Serial Order.

INTRODUCTION

Serial Art

Although serial art has existed since the late Nineteenth Century, it was not recognized as such till the mid-Twentieth Century. John Coplans, one of the founding editors of *Artforum*, and later its Editor-in-Chief, curated an exhibition at the Pasadena Art Museum in 1968, titled "Serial Imagery." The exhibition and its corresponding catalog have served to highlight the work, and to fortify the principles that led to their recognition and naming. In the catalog, Coplans not only includes the work in the exhibition, but also an essay he had written for *Artforum*. In the essay, there is no mention of Donald Judd. Coplans expands on the essay in a history section of the exhibition catalog where he specifically notes: "Although the work of such sculptors as Donald Judd has been described as Serial, this is incorrect" (Coplans 1968, 9). In this sentence, Coplans is referring to another essay, written a year earlier by Mel Bochner and also published in *Artforum*. Bochner, an artist of serial works and theorist, in his essay, titled "The Serial Attitude," mentions Donald Judd's "painted wall pieces" as employing serial logic (Bochner 1967, 28.) Recognizing that both essays were written in the context of one of Judd's 'painted wall pieces' from the 1960's, we are interested in exploring a later works, permanently installed at the Chinati Foundation in Marfa, Texas, "100 untitled works in mill aluminum," 1982-1986, in the context of serial works.¹

Coplans in a 1971 interview with Judd asked him: "*You mean that all your ordering of form is arrived at or deduced as a whole in advance?*" In response, Judd said: "Yes, that's what I was going to tell you. You see, the thing about my work is that it is given... You don't walk up to it and understand how it is working, but I think you do understand that there is a scheme there, and that it doesn't look as if it is just done part by part visually. So, it's not conceived part by part, it's done in one shot" (Coplans 1971, 47-49). This statement, also made in an earlier context than the 100 works, clearly affirms Judd's mindset and methods as tending towards the systemic. The question, for us, is one of specificity and nuance, and not generalities. For example, are the systemic methods there by design, in advance of the work and are they uniformly applied and decipherable? Are they exhaustive? And to be able to answer these questions, we will first examine Coplans' and Bochner's definitions of serial art and continue to the analysis of Judd's 100 physical objects. It is important to note that this investigation is a part of a much larger research project on Judd's "100 untitled works in mill aluminum." Elsewhere, we have discussed serial order in more detail, and here, we will provide a summary. In addition, we are conducting archival and theoretical studies in parallel to the object analysis presented here.

Serial Order

John Coplans' *Serial Imagery* traces serial artworks to the late Nineteenth Century and Claude Monet with his seven views of *Gare Saint-Lazare*, 1876 (Coplans 1971). Coplans connects Monet's early serial work to major contemporary discoveries in science and philosophy, in particular, to Dedekind's mathematical theory of the continuous independent variable of 1872 (Coplans 1968, 19). Starting from Monet and moving forward, Coplans names major painters (Jawlensky, Mondrian, Albers, Reinhardt, Bell, Kelly, Klein, Louis, Noland, Stella,) poet (Stein), print-artist (Warhol,

RESEARCH AND DESIGN

and conceptual artist (Duchamp,) covering the entire period till the writing of his essay. What is clear from the list of artists and their work is that although the tendency towards serial works had existed for almost one hundred years, the intensity of the work belonged to the period leading to the two published essays by Coplans and Bochner.

Coplans included his *Artforum* essay, "Serial Imagery" in the Pasadena Art Museum's catalog of the exhibition and renamed the essay "Definition." As the title suggests, he defined the principles by which a work may be considered serial. He opened this section with two quotes from Mondrian and Reinhardt, both emphasizing the relation between pieces rather than the individual artwork. He continued the logic of relations and outlined three principles that define serial works:

1. "Central to Serial Imagery is the concept of macro-structure—that which is apprehended in terms of relational order and of continuity... Meaning is enhanced and the artist's intentions can be more fully decoded when the individual Serial work is seen within the context of its set.... Seriality is identified by a particular inter-relationship, rigorously consistent, of structure and syntax: Serial structures are produced by a single indivisible process that links the internal structure of a work to that of other works within a differentiated whole" (Coplans 1968, 11). Coplans highlights a structure that is outside of, prior to, and encompassing individual works. Rather than placing importance on the artistry and the execution of individual pieces, he emphasizes the relationship between and among them, focusing on the structure that governs all the works in the series rather than individual ones. Coplans' first principle clearly concentrates on the macro-structure and relational order, created by a single indivisible process, outside of and prior to the execution of individual works.
2. "Serial Imagery is a type of repeated form or structure shared equally by each work in a group of related works made by one artist" (Coplans 1968, 10). Here, Coplans concentrates on the repetitive aspect of the form that results from the application of the macro-structure and the equal sharing of that structure by all individual pieces in the series.
3. "There is no limit to the quantity of works in a series other than what is determined by the artist" (Coplans 1968, 11). It is clear that Coplans does not see an upper numeric limit to the number of works in the series, however, elsewhere he has stated that a single work cannot be serial, regardless of the number of parts in the work. We surmise that Coplans' series may include between 2 and an infinite number of objects.

Given Coplans' role as an editor in *Artforum*, he must have been aware of Bochner's essay published in the same journal ten months earlier, with the title "The Serial attitude." In effect, the principles outlined in Coplans' essay must have been in response to Bochner's. We should note that Coplans did not enumerate his principles, rather presented them in prose form. We numbered his principles only to provide a comparative platform with Bochner's three principles. Bochner opened his essay with a quote from Josiah Royce's *Principles of Logic*: "What ordertype is universally present wherever there is any order in the world? The answer is serial order" (Bochner 1967, 28). He then distinguished working in series, making "different versions of a basic theme" from serially ordered works. He outlined three principles for serially ordered work:

1. "The derivation of the terms... of the work is by means of a... systematically predetermined process (permutation, progression, rotation, reversal).
2. The order takes precedence over the execution.
3. The completed work is fundamentally parsimonious and systematically self exhausting" (Bochner 1967, 28).¹

Bochner made an important distinction between working in series and serially ordered work, and also between modular works and serial ones. "Modular works are based on the repetition of a standard unit," he noted (Bochner 1967, 28). Comparing the principles outlined by Coplans and Bochner, we see clear alignment in the first two, but a departure in the third. Bochner provides a much more restrictive definition in principle three with the use of "self exhausting." Coplans, in his exploration of this principle covers self-exhausting as one of four possibilities, making his definition more expansive than Bochner's. So, why did Bochner include Judd's "wall pieces" within serial works, and Coplans not. Coplans provides a clue to his reasoning when he writes:

"Although the work of such sculptors as Donald Judd has been described as Serial, this is incorrect. Judd, for example, replicates parts by having identical units manufactured; they are then positioned to form one sculpture, one unit. Judd's images have a modular structure, and his range of similar sculptures relate more to sculptors' traditional use of editions than to true Serial form" (1968, 9).

The distinction between the two authors in principle three made the difference. Though Bochner's definition was more exclusive and insisted on self-exhaustion, it did include the possibility of a single work with serial parts. Coplans' more expansive definition excluded single works. With these principles, a cursory examination of Judd's "100 untitled works in mill aluminum" shows them oscillating between modularity and seriality. There are 100 similar objects, all 41"x51"x72", which may be classified as modular, yet with unique configurations, they may evoke the systematicity that is in principle one. This will, however, depend on whether the variation in their individual configuration belongs to a macro-structure. The next section is devoted to this exploration.

1.0 THE DESIGN LANGUAGE OF DONALD JUDD'S "100 untitled works in mill aluminum"

Given Bochner's and Coplans' principles and definitions for "Serial works," we can examine Donald Judd's "100 untitled works in mill aluminum" in that context. We will first see if we can identify a macro-structure, a process that is governed by the artist from outside of individual works.

We carefully examined the 100 objects located in the artillery sheds at the Chinati Foundation in Marfa, Texas. During our field observation and documentation, we were able to identify two types of structuring, to which we referred as the "compression type" and "cap type." The compression type objects utilized bolts and inner plates to compress two parallel members, whereas the cap type objects used gravity to compress the other members through the weight of a full (51"x71") ½" "cap" on top. These two types defined 96 of the 100 objects, with the remaining four not fitting into either category.

During our field observations, we noticed some imperfections and surface anomalies on the aluminum, which we originally believed were caused by internal blind pins. However, we discovered that the surface imperfections were the results of fabrication techniques utilized by the sculpture fabrication shop, Lippincott Inc. of North Haven, CT. We had imagined that the structural types didactically determined the fabrication of the objects but recognized that the two types were really form types and the structure and fabrication of the objects were governed by what was necessary for precise assembly. We should confirm that the "types" are ours, and not mentioned anywhere by Judd or in any of his drawings. Nonetheless, the two types were so consistent that we continued to engage them.

Lippincott Inc was commissioned to fabricate all 100 objects, two "Trial Proofs," and an early prototype. The Judd Foundation archives hold all shop drawings produced by Lippincott for this project, which not only describe the objects themselves, but also how they are structured, detailed, and fabricated. Although the shop drawings do not mention "types," the language used to describe the objects and their fabrication distinguishes types nonetheless; language such as "top over sides" and "top over ends," for cap type objects, and "sides over ends" and "ends over sides" for compression type objects.

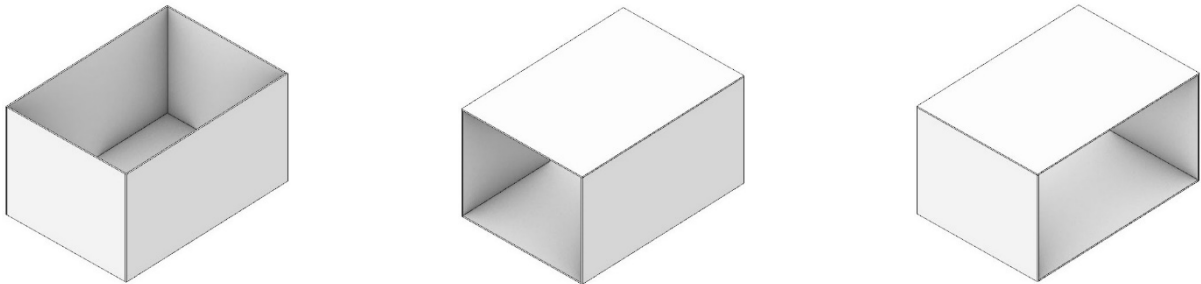

Figure 1: Diagrams of "Open Top," "Open End" and "Open Side," Objects number 1, 12, and 13. Diagrams by authors.

Judd's sketches for the 100 objects are also held in the Judd Foundation archives. After examining the sketches, we recognized three "form types" that defined the groupings of objects: "open or recessed top," "open or recessed end," and "open or recessed side" (Figure 1). We mapped each of the 100 objects in a chart with three columns related to the "form types" and added a column for the four anomalous objects. We applied a color code to all the objects documenting the types we had identified during our field observation and found that all open top objects were of the compression type, while all open-side and open-end objects were of the cap type. The strict adherence of the structural and formal discoveries made during field observation, with Judd's sketches, and the fabrication shop drawings confirmed that we were on the right track. We continued to pursue the identified types.

Based on these discoveries and the alignment of the results of multiple angles of research, we were convinced that we were close to identifying a macro-structure that governed the majority of the 100 objects. In order to gain a deeper understanding of the methods at work, we continued our analysis of individual objects, but also began to examine the chronology of the design of the objects through documents held at the Judd Foundation Archives.³ In a June 13, 1980, handwritten note/sketch, Judd describes 13 objects through text (there are a few small sketches accompanying the text). The list is as follows (the object numbers have been added by the authors and represent the objects currently held at the Chinati Foundation):

Half covered crosswise	Sides overlap	#2
Half covered lengthwise	Ends overlap	#3
Half slope from middle crosswise	Sides	#4
Half slope from middle lengthwise	Ends	#5
Full slope lengthwise	Sides	#6
Full slope crosswise	Ends	#7
Divided in half crosswise	Sides	#23
Divided in half lengthwise	Ends	#22

RESEARCH AND DESIGN

Divided in half open sideways	Ends	#24
Divided in half open endwise	Sides	#25
Half slope from end, crosswise	Sides	#20
Half slope from side, lengthwise	Ends	#21
Half division lengthwise	Ends (Judd 1980)	#34

In addition to “open top,” “open end,” and “open side” formal types mentioned above, we see that the words “full” and “half” govern the form of all thirteen objects in the list. We noted the same in our field observations. For example, object # 90, which is positioned to be viewed as the first object in the large shed if entered from the North (most visitors enter from the North, due to its proximity to the visitor’s center,) is an object with one side closed. We noted that the closed end was painstakingly inset, held together with blind pins and not-visible bolts. The fact that so much effort was placed in in-setting this plate caught our attention. We began to recognize that there is great care in ensuring that all objects, viewed in elevation, hold similarities. In this case, the elevation of object #90 matches objects #13, 34, 35, 36, 68, and 96. So, the “full” and “half” not only describe the formal qualities, but also the elevations of the objects, down to the way the different plates overlap one another and the connective mechanisms.

We have established “open top,” “open end,” and “open side” types as our largest governing formal/constructive macro-structure, and the elevation types of “full” and “half” cutting across all three formal types. We noted from the list of thirteen objects mentioned above that all except one served as the source from which other objects were derived (and the one was the double of a source object). This is a practice that Judd engaged regularly. Judd wrote in a short note in 1990: “Perhaps the point at which a piece of mine becomes good is when it opens toward many possibilities. One good piece naturally becomes a category of good pieces” (Judd 2016, 617). We examined every object and located twenty-six objects from which categories of objects were derived. In addition, the list of thirteen also documents objects as “full slope” and “half slope.” We note “slope” as a tertiary ruleset, an effector. After this initial set of objects, others were developed that had an oblique plate in plan. Although they belong to the same category of objects as “slope,” we chose to use the word oblique instead of Judd’s “slope,” which is only meaningful in sectional obliques. You will see in the chart in Figure 2 below that we have “full” as a category and also “full-oblique.” The same holds for “half” and “half-oblique.” We can deduct from this brief analysis that Judd was engaging macro-structures in the shaping of the 100 works. The structure included form types (open top, end, or side) and visual types (elevation types of full and half), as well as a sub-structure of obliques.

Categories of objects in Donald Judd’s “100 untitled works in mill aluminum”																								
Form Types-->		Open or Recessed Top						Open or Recessed End					Open or Recessed Side						Anomalies					
Elevation Types-->	Rulesets	Source Object	Offset	Offset-Offset	Double	Offset-Double	Offset-Double-Offset	Compound	Source Object	Offset	Offset-Offset	Double	Offset-Double	Offset-Double-Offset	Closed One End	Source Object	Offset	Offset-Offset	Double	Offset-Double	Offset-Double-Offset	Closed One End	Double-Closed One End	
		Full	1						100	12						67	13							68
FULL	Full-Oblique	10						17								18								
		16						26	27							34								
		6	77	78	79	43	44		28	30	32		45	47		35	37	39		49	51			
		91							29	72	69		87	76		36	70	73		85	75			
FULL	Full-shape Offset	7	57	58	80	61	62			74			88			71			86					
		92							95							96								
		8							53							55							11	
HALF	Half-Oblique	9						54							56								14	
		15																					19	
		2			93				25			66				24			65					
		3			94				33			48				40			52			89	90	
		22			63																			
HALF	Half-Oblique	23			64										97			99					98	
		4			41				31			46				38			50					
		5			42																			
		20	84		59	82																		
21	83		60	81																				
100	16	6	2	10	4	2	2	11	3	2	3	3	2	1	12	3	2	4	3	2	2	1	4	

Figure 2: Chart documenting types, rulesets, and categories of objects in Judd’s “100 untitled works in mill aluminum.” Chart by authors.

Next, we need to see if we are facing a “type of repeated form or structure shared equally by each work in a group of related works made by one artist,” exploring if the macro-structure is shared equally by all 100 works (Coplans 1968, 10). Examining each object within each category, we deciphered rulesets that governed the variations of objects in the categories, while maintaining their adherence to the macro-structure. The rulesets are: “Offset,” “Offset-Offset,”

“Double,” “Offset-Double,” “Offset-Double-Offset,” “Closed One End,” and “Double-Closed One End” (these are all our terms and not Judd’s, although Judd does use the terms double and offset in his sketches). Double, for example, doubles an inner plate, but in doing so, it also displaces the source plate. A “half” bisector that is doubled, offsets the source plate by 2” from the center, and the new plate is also offset in the opposite direction by 2”, making a 4” offset dimension centered on the object centerline. The 4” dimension is a constant, whether doubled, or offset. In the cases of oblique plates, the offset not only re-locates the source plate, but also changes the plate angle and thus reconfigures the milling angle of the plate’s end. The “Offset” rule offsets one end of the plate from its source location by 4”; “Offset-Offset” rule offsets both ends of the plate; “Offset-Double” doubles the plate and offsets one end; “Offset-Double-Offset,” offsets both ends; “Closed One End,” is self-explanatory as is “Double-Closed One End.”

We observe from the chart in Figure 2 that the twenty-five source objects produce eighteen derivative objects from the offset rules. The double rule produces seventeen derivative objects. In various combinations, there are fifty-seven objects that have been derived by applying one of the rules to the twenty-five source objects. This leaves eighteen of the hundred objects un-accounted. Of those, seven are source objects without derivatives, and ten belong to a category of objects which are derived from offsetting the full object as a complete shape by 4”. The remaining one, object #98, is an anomaly, which we will discuss later. Figure 3 clearly documents both the repeated forms governed by the macro-structure, and their relationship to one another and to the rulesets. We posit that Judd’s “100 untitled works in mill aluminum” also satisfies the second principle noted by Bochner and Coplans, establishing relational order shared equally among objects.

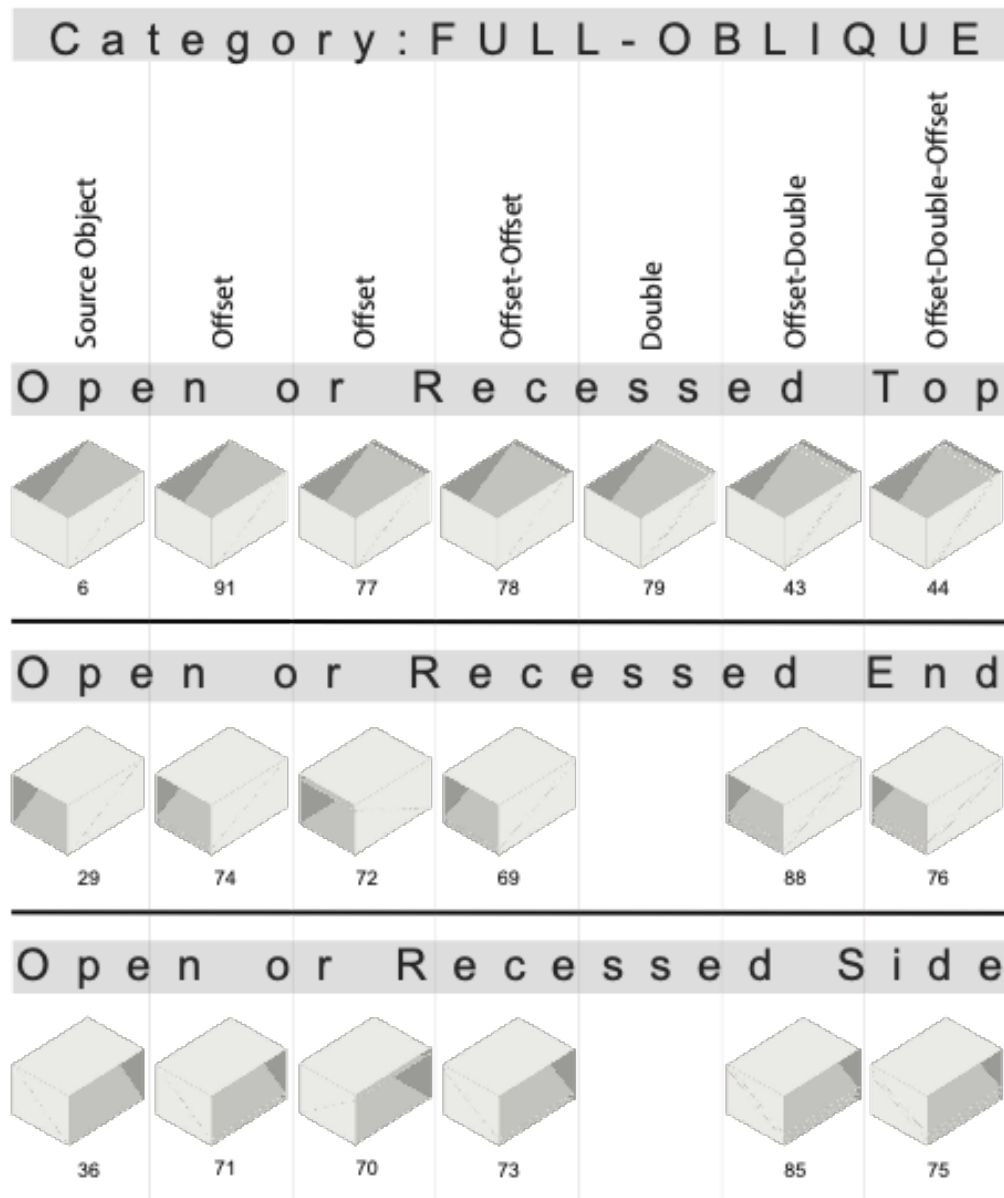

Figure 3: Diagram documenting categories of objects derived from rulesets applied to source objects. Diagram by authors.

Regarding Bochner and Coplans' principle #3, we have already determined there is deviation between Bochner and Coplans, where Bochner insisted on a "self-exhausting" system and Coplans had a more expansive and thus inclusive principle. Judd's "100 untitled works in mill aluminum" certainly fulfills Coplans' definition. However, in relation to Bochner's more restrictive definition, we need to examine whether the 100 objects are "self-exhausting."

Figures 3 not only describe the relationship among objects, but it also makes visible the objects that were not made. For example, in Figure 3, we note that there are no doubles in the form types of "open end" or "open side." We see doubles with one side offset, and both sides offset, but no pure double. We have not yet deciphered a logic for this through the examination of the objects. However, Judd has been clear that he is not interested in making every possible object within types. In a 1990 interview with Claudia Jolles, Judd was asked: "Your work is often built up on a system of variation. But it is never very obvious whether this system follows as a precise rule. Do the existing possibilities stand for all the other unrealized ones?" In response, Judd said:

"I just do the possibilities which are the most interesting. I don't want to realize a comprehensive sequence of all the possible solutions. Because usually just some of them are good. Usually I can think of many more possibilities than I can afford to build" (Jolles 2016, 9).

In Figure 4 below, we have marked in red twenty-two possible objects that could have been made and would have fit within the category of objects, given the rulesets, but were not made. If we were to accept Judd's statement, we would conclude that these were not among the most interesting objects to produce. However, given all the other objects that were produced within each category, we are unable to conclude that these objects would have been any less interesting than the ones made. Of course, we do not have Judd's vision. As previously stated, the 100 works meet Coplans' principle #3, but we see from this analysis that Bochner's more restrictive definition requiring self-exhaustion is not met with the 100 works.

Categories of objects in Donald Judd's "100 untitled works in mill aluminum"																							
Form Types-->		Open or Recessed Top					Open or Recessed End					Open or Recessed Side					Anomalies						
Elevation Types-->	Rulesets	Source Object	Offset	Offset-Offset	Double	Offset-Double	Offset-Double-Offset	Compound	Source Object	Offset	Offset-Offset	Double	Offset-Double	Offset-Double-Offset	Closed One End	Source Object	Offset	Offset-Offset	Double	Offset-Double	Offset-Double-Offset	Closed One End	Double-Closed One End
		Full	1	10	16				100	12	17	27				67	13	18					
Full-Oblique	6	77	78	79	43	44		28	30	32	45	47			35	37	39	49	51				
	91							29	72	69	87	76			36	70	73	85	75				
	7	57	58	80	61	62			74		88					71		86					
	92							95							96								
Full-shape Offset	8							53							55								11
	9							54							56								14
	15																						19
Half	2			93				25			66				24			65					
	3			94				33			48				40			52				89	90
	22			63																			
	23			64											97			99					98
Half-Oblique	4			41				31			46				38			50					
	5			42																			
	20	84		59	82																		
21	83		60	81																			
100	16	6	2	10	4	2	2	11	3	2	3	3	2	1	12	3	2	4	3	2	2	1	4

Figure 4: Chart documenting all objects that could have been made given the rulesets, including those that were not made marked in red. Chart by authors.

We also observe from the chart that Judd designed eighteen objects which were singular and did not produce any derivatives. Four are true anomalies, and seven others do not quite belong to the categories we have deciphered and constitute a new set. In the charts in Figures 2 and 4, we have called the seven "Full-Shape offset," and the four "anomalies." One of these objects, #98 breaks every rule that defines all other objects. In an August 8, 1984 handwritten note from Alfred Lippincott of Lippincott, Inc., the fabricators for all 100 objects, to Donald Judd, he writes:

"I'm not quite sure what to do with this Box #98. It's an amalgam of top over sides and top over ends. In so much as there is only one side and one end [,] it is a hybrid and there exists no precedent within the group as a whole. In certain primitive art [,] don't they sometimes interject an unrelated element such as this to 'let the demons out'? Notwithstanding demons, it may be fun to have a lone work such as this to inspire those devotees with an eye for detail as they stroll among the boxes, rather than complicate construction by trying to relate to other boxes" (Lippincott 1984).

Object #98 is truly an anomaly: It is both open end and open side, and closed one end and closed one side; It defies the bolt patterning, as all other bolt patterns are parallel and here they intersect; In addition, each of the two parallel lines of bolts on the top plate contains a different number of bolts and the bolts do not align across the two parallel lines; and the half plate introduces an unprecedented condition where it connects to the baseplate. Clearly, Judd not only confounded the Lippincotts, but also us, viewers, and researchers. It would be very difficult to argue "...the possibilities which are the most interesting" as the logic of producing object #98, and much easier to argue the "demons." Either way, it seems to us that object #98 is there to confound, to introduce the proverbial wrench in the system, to make researchers that think there is a system believe there is not, or at least not a consistent one. Or perhaps, to open the possibilities for the next 100 objects.

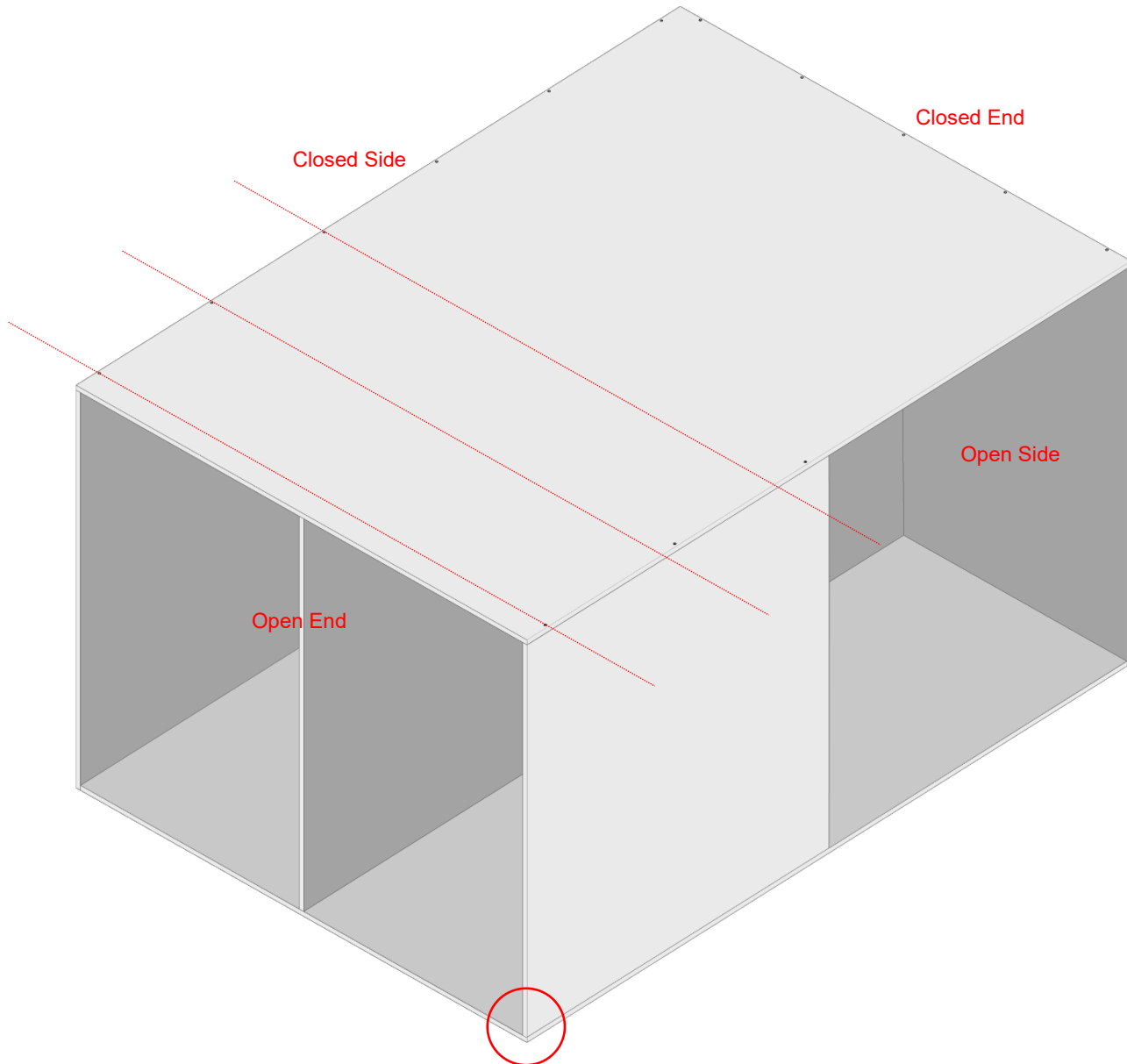

Figure 5: Diagrammatic view of object #98, highlighting its differences with the other 99 objects: It is both open end and open side, and closed one end and closed one side; It defies the bolt patterning, as all other bolt patterns are parallel and here they intersect, each of the two parallel lines of bolts on the top plate contains a different number of bolts and the bolts do not align, and the half plate introduces an unprecedented condition where it connects to the baseplate. Diagram and annotations by authors.

CONCLUSION

Judd began his artistic career with paintings in the 1950's and quickly transitioned to three-dimensional objects by the 1960's. Many of his early objects had repetitive elements creating surfaces or negative spaces. Repetitive elements—both parts and spaces—became almost a signature of his later objects. His early wall pieces, though individual objects, included many repetitive parts. In the mid-sixties, his wall pieces included repetitive objects—in distinction from repetitive

parts—and led to the development of his progressions, stacks, and repeated wall-hung or floor boxes. In the late 1960's, he began producing individual box-like objects, with some similarity to the 100 works. Repetition was a key method for Judd towards the development of work, both as parts within individual objects and among objects. The repetition also included new objects with variations in material, surface treatment, color, size, and proportion. Box-like objects were also a major part of Judd's vocabulary. So, the objects in Judd's "100 untitled works in mill aluminum" have their sources in Judd's previous work, and, in turn, served as the source for later work. The "100 works," however, were unprecedented in the combination of their number and scale. They presented a significant moment in Judd's career where he began to work at the scale of large buildings and landscapes. Although both Bochner and Coplans were writing about Judd's earlier work, his "painted wall pieces,"¹ we see, through this analysis, that his structure⁴ processes and methods were sustained throughout his career and fully informed the "100 untitled works in mill aluminum." Repetition, on its own, as we know, does not constitute serial order. Judd started with the repetition of parts within objects and moved to the repetition of objects within larger works, and finally produced the 100 works through the repetition of structure.

To conclude, let us go back to Coplans' *Serial Imagery* where he writes:

"...seriality is identified by a particular interrelationship, rigorously applied, rigorously consistent, of structure and syntax: serial structures are produced by a single individual process that links the internal structure of a work to that of other works within a differentiated whole" (Coplans 1968, 11).

Bochner's self-exhaustive principle notwithstanding, we believe, at this state of our research, that most of the 100 objects were produced with a structure and a syntax that was rigorously and consistently applied, but not to all possible objects. In our abstract, we referred to these moments of inconsistency in the application of a structure as improvisational. We have identified one of these moments between the first twenty-five objects and the remaining seventy-five. We have also identified many smaller moments where source objects have not produced any derivatives. And, lastly, we have located a set of anomalous objects, one of which, we think is intentionally anomalous. We believe these improvisational moments to be the artist's most masterful moments, when the artist slips out of the structure to achieve other artistic ends, without undermining the structure. In the next phase of our work, we will attempt to decipher why certain objects that belonged to the structure and syntax were not produced. We will also try to decipher the logic of producing the few objects which we found to be anomalous. Judd utilized repetition and variation of structure and syntax as a design process in the development of the "100 untitled works in mill aluminum." These processes were also fundamental to the development of work throughout his career: starting from the singular three-dimensional objects of the early 1960's to the objects that were made of repetitive parts to work that was made of repetitive objects, to the 100 works of repetitive structure. It is enlightening to recognize that 100 beautifully luminous objects were produced from a simple mill aluminum box using a set of rules and the vision of an individual who understood objects not in isolation as geometric phenomenon, but in context with one another, with light, reflection, luminosity, and the gunsheds in the Chihuahuan desert. In the artillery sheds, one oscillates between the individual objects and the experience of the collective structure. Each object is a wonder on its own, and even more so, in its relation to others and to the sheds and the landscape beyond.

REFERENCES

- Bochner, M. 1967. "The Serial Attitude," *ARTFORUM*, December.
- Coplans, J. 1968. "Serial Imagery," *ARTFORUM*, October.
- Coplans, J. 1968. *Serial Imagery*. Pasadena, CA: Pasadena Art Museum.
- Coplans, J. 1971. "An Interview with Don Judd," in *Artforum*, Summer.
- Referenced in Coplans, J. *Serial Imagery*, p. 19: Huntington, E.D.: *The Continuum* (and Other Types of Serial Order), second edition. Harvard University Press. Cambridge (1921).
- Jolles, C. 2016. "Interview with Donald Judd, April 5, 1990." in *Donald Judd Cor-Ten*. New York: David Zwirner Books.
- Judd, D. 1980. Drawing and note for the 100 untitled works in mill aluminum, June 13, 1980, pencil on paper, 8 3/16 x 11 9/16 inches (20.9 x 29.5). Judd Foundation.
- Judd, D. 2016. *Donald Judd Writings*, ed. Flavin Judd and Caitlin Murray. New York: Judd Foundation and David Zwirner Books.
- Letter from Alfred Lippincott to Donald Judd, August 8, 1984, Donald Judd Papers, Judd Foundation Archives.

ENDNOTES

1. Bochner specifically names Judd's "Untitled" in galvanized iron. From Bochner's description, we believe the piece he cites to be one of the three following variations: 1965: Red Lacquer on Galvanized Iron; 1967: Blue Lacquer on Galvanized Iron; and 1967: Purple Lacquer on Galvanized Iron. There are also other variations of this piece, produced in other colors and materials: 1967: stainless steel; 1972: brass; 1972: chartreuse anodized aluminum; 1972: burnt sienna enamel on cold-rolled steel; 1973: copper; 1973: purple anodized aluminum; 1973: green anodized aluminum; and 1973: blue anodized aluminum. Coplans describes work by Judd that, "for example, replicates parts by having identical units manufactured; they are then positioned to form one sculpture, one unit." (Coplans 1968, 9)—the description could point to the same work as Bochner mentions.
2. We have elected to not engage the "parsimonious" aspect of Bochner's statement in this paper, as it involves aesthetic decisions which require a different type of investigation than the one on which we have embarked here.
3. Initially, Judd was to install twenty-five objects in the Wool and Mohair building in Marfa. He had designed the objects based on previous installations. Later, the project grew first to eighty-five, and then to one hundred objects.

The list of thirteen objects includes twelve of the first group and one (#34) that is an extension of a series developed for the first twenty-five. Objects 22-25 are all bisectors, and by extension, make objects 33 and 34. Although the fabrication was also meant to occur in groups of roughly twenty-five, the design groupings and fabrication groupings do not align. In other words, the first twenty-five designed were not the first twenty-five fabricated, nor installed.

4. The project referenced in this paper is Donald Judd's "100 untitled works in mill aluminum," permanently installed at the Chinati Foundation, Marfa, TX. The archival material for Judd's 100 works is held at the Chinati Foundation Archives, and the Judd Foundation Archives.

Architecture's Expanded Field: Territories of Collective Action

Frances Hsu¹

¹Marywood University, Scranton, PA

ABSTRACT: The paper addresses research-in-practice groups evolving across Western Europe with focus on the Nordic geographical and cultural region. Bringing together architecture, planning, and the public sector they synthesize design and policy. The groups engage critical and participatory approaches to design that synthesize interdisciplinary research, experimental pilot projects, and consultancy services. They purposefully advance "new economic thinking" involving design and alternative governance structures and policies. The heterogeneous European organizations challenge the social and environmental impact of libertarian economic systems. The research-in-practice case study may provide new understandings of architecture's role in society, raising questions on how practice-based research methods can have impact and relevance for 21st century architectural education and practice.

KEYWORDS: Participatory design, practice-based research, sustainability, new economic thinking, decision-making

INTRODUCTION

NEW ECONOMIC THINKING: BEYOND NEOLIBERALISM

In academic, media, citizen, and policymaking spheres, voices contesting and critiquing key aspects of mainstream economic thinking have increasingly permeated debates since the 2008 global economic crisis. The term new economic thinking is based on the principle that economics should serve society:

"We are economists who challenge conventional wisdom and advance ideas to better serve society. Mainstream economics has demonstrated blind spots that have impaired its effectiveness and credibility—and failed society at large." (Institute for New Economic Thinking 2022)

Assessments of a post-neoliberal era include *Towards a New Economic Approach* by the OECD and multidisciplinary groups like GANE (Global Assessment for a New Economics) at the University of York (Fig 1). Arguments have addressed the outdatedness of GDP as a measurement of economic development and the role of the State in societal transformations. (Dasgupta 2021). Articles such as "Is it Time for a New Economics Curriculum?" (The New Yorker 2022) and the global student-run *Rethinking Economics* tackle the decolonization of the economics curriculum.

The landscape of European research-in-practice groups advancing new economic thinking is plural and heterogeneous, comprised of actors from professions and academia engaging design processes in different locations, in diverse ways, and at different scales. (Figure 1) Initiatives to transform the built environment include green economies (circular, regenerative, ecological, etc.), feminist economics, solidarity and democratic economics, de-growth/post-growth, laws of the common good, indigenous and local knowledge, as well as land and ownership debates. Activities promote a shared ethos of collaboration rather than competition and interdisciplinarity across silos of expertise that aim to balance bottom-up action with top-down coordination. Despite divergent ideological origins, and while the groups do not form a cohesive movement or direction, they purposefully challenge mainstream economic paradigms by offering alternative projects, services, and research responding to environmental crises, political instability, economic power, and social inequalities. Together they signal growing interest in designing and developing alternatives to the post-2008 dominant economic paradigm.

Disciplinary critiques historicize a political economy where the neoliberal mobility and distribution of capital has marginalized the design profession. (Gutman, 2007; Deamer 2013 and 2020) The architect's activity is contingent on the capitalist system, with limited influence, commercial value, or socio-cultural worth to public clients, developers and decision makers. Manfredo Tafuri described the bind of the architect as master builder caught within the structures of capitalism to be the worst of the evils: the decline of the architect's "professional" status and his introduction into programs where the ideological role of architecture is minimal. (Tafuri 1976)

The critique of global markets was more recently underscored by the 2016 Venice Biennale curated by Alejandro Aravena. The theme of "Reporting from the Front" focuses on architecture as an instrument for improving the people's quality of life and was "a comprehensive survey on how it's possible to favor the public interest against selfish ones." The exhibition addresses the interconnection of the design of built environments to the socio-economic and political organizations contributing to their existence, with an aim to open the profession to new fields of engagement:

RESEARCH AND DESIGN

On the one hand we would like to widen the range of issues to which architecture is expected to respond, adding explicitly to the cultural and artistic dimensions that already belong to our scope, those that are on the social, political, economical and environmental end of the spectrum. On the other hand, we would like to highlight the fact that architecture is called to respond to more than one dimension at a time, integrating a variety of fields instead of choosing one or another. La Biennale di Venezia, paragraph 19)

Projects examined notions of repair, incremental, ad-hoc, and bottom-up progress; the value of cooperative shared architecture and history's *longue durée*. Reviews found in the biennale a multidimensional critique of global real-estate speculation and its effects on society.

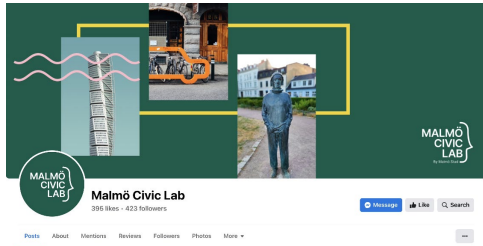

Figure 1: Malmö Civic Lab. Source: <https://www.facebook.com/malmociviclab>; <https://twitter.com/MalmoCivicLab>.

APPROACH

This paper addresses the evolving role of design and socio-political processes. It provides an historical context for disciplinary attempts and arguments for new economic and participatory models of over the past half-century. First, an overview of the evolution of public interest design and government. Then, observations and notes on the landscape of Western European research-in-practice models is followed by an examination of case studies of practice-based research in Finland at the intersection academia, profession, and public. How can understanding the changing relationships between participatory design and practice-based research clarify what is meant by the terms design or research and consequently how pedagogy and research methods can have impact and relevance on design and practice?

ARCHITECTURE AND GOVERNANCE

The history of entanglement between plans to benefit the general populace (the public interest) and political process can be outlined in several phases. From the 1960s to 1990s in Europe, the public interest was tightly defined by politicians and experts. Municipal departments were answerable to politicians. Services were delivered through professional and or state institutions. The aim was primarily effective and efficient administration. In this era of patriarchal public services and technocracy, civil servants determined and allocated resources. The State dominated decision-making, increasing its power following the world wars. (In the prewar 19th century European city urbanization was driven by public-private partnerships in which public works infrastructure, e.g., railways, trams, subway, water, sewerage, energy was achieved largely in concessions granted to entrepreneurs. (Bezaçon, 2004)

The commercialization of the public interest occurs with the design and development of digital information and communication tools (ICT). This phase, coalescing around the 1990s, can be identified with the technological management of public participation. Driven by a market-based ethos, governments used public-private partnerships to deliver services for public infrastructures. ICT tools targeted inputs and outputs focused on the optimization of technology and infrastructures of energy, transportation, communication, waste, and water. Programs were monitored by civil servants. Politicians were held accountable to the market. The public interest was measured through customer surveys. Data visualization techniques were used to make large amounts of data available to the public, aiming to inform citizens and increase participation in decision-making (Micheli et al, 2012; Boulianne, 2009; Hemmersam *et al*, 2015). This kind of collaboration among public and private economic actors was deemed a cost-effective and efficient way of delivering services.

In the third phase, the public interest becomes an ecosystem involving dialogue between citizen/users, providers or digital platforms, and services with the development of bottom-up apps for consumers and citizens. Urban citizen/users intersect with digital platforms emerging from the operational logics of web-based businesses such as Amazon, Alibaba, Apple, Airbnb, Spotify, Uber, and so on. The services provided by the platform's direct social and technical interaction between multiple parties, each of which follows platform-specific requirements to interact with others. The commercial value of the platform increases with the number of users. Crowdsourcing, social media, sharing economies, and other byproducts of smart phone promised a more immediate personalized relationship between individual and local governments.

This model of public interest has been named Platform Urbanism by political philosophers and architects. (Srnicek, 2016; Easterling, 2014) The ethos of personal customization and user-centricity masks new hierarchies and inequalities between platform makers and users. They link platforms to the emergence of new social and material infrastructures

of late neoliberal governance and economy (epitomized by the notion of the smart city). The market power of platforms and big data sets is a form of economic oppression. (Zuboff, 2019) An important distinction of this phase is the centralization of power and shift away from city and national governments at the same time platforms are increasingly influential to understanding, experiencing, and governing the city. (Troy, 2022)

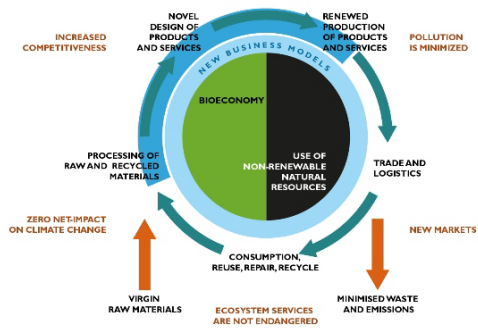

Figure 2: Renewal of manufacturing towards a sustainable circular bioeconomy and implications for innovation policy
Source: Suomen ympäristökeskus Finlands miljöcentral/Finnish Environment Institute. <https://www.syke.fi/fi-FI>

PARTICIPATORY PRACTICE AND RESEARCH

Architecture has always been participatory. Architects collaborate with clients, owner/developers, local agencies, and others. "Participatory Design" is defined as an approach, method, and ideology that includes "users" in the design process. The movement grew out of the concern to democratize design and expand the architect's expertise by actively involving stakeholders. It is part of a multitude of politicized approaches emerging from cross-cultural grassroots urban social reform movements occurring around May 1968. In the past 60 years public participation in architectural design and urban planning has involved the dissemination and organization of information through public hearings, workshops, citizen committees and panels. This occurred especially in European countries with a strong moral consensus culture and social democratic political parties (such as The Netherlands). Also developed and executed were pilots of small scale plans with the decision authority shifting to local population.

Henry Sanoff, at North Carolina State University, created the Community Design Group (precursor to numerous Community Design Centers, to offer pro bono design services and advocate for those underrepresented in the development process. Sanoff describes participatory design as

an attitude about a force for change in the creation and management of environments for people. Its strength lies in being a movement that cuts across traditional professional boundaries and cultures. Its roots lie in the ideals of a participatory democracy where collective decision-making is highly decentralized throughout all sectors of society. (Sanoff, 2010, 1)

Sanoff developed tools, methods, and games for community design. (Sanoff, 2003, 2009) He believed that participatory design results in new knowledge that can only be developed from within design practice. (This viewpoint is challenged by the Nordic models of the Helsinki Design Lab and Design for Government discussed later in this paper.)

The subject of the Design Research Society conference in 1971 was Design Participation. In his opening paper Reyner Banham addressed "the new wonder ingredient 'participation' and "the fact is that the wonder ingredient 'participation' hasn't been around all that long." (Banham 1971) Literature on the nature of design's relationship to inhabitants, government, technology, and media includes Bernard Rudofsky's exhibition "Architecture Without Architects" (1964) and Victor Papanek (1971). Lucien Kroll at Louvain-a-Neuf, Belgium involved students in design and construction. Participatory ideals have motivated Ralph Erskine at Byker Wall in Newcastle, England and Michael Payatok for low income and affordable housing on the US West Coast.

Architects' engagement of people in design processes has evolved through humanitarian design that spans scales from the design-build of Rural Studio and Shigeru Ban to the work of collaborative practices such as Mass Design in the US and Muf Architecture/Art and Assemble in the UK. Ana Džokić and Marc Neelen of STEALTH (Belgrade and Rotterdam) undertake collaborative urban interventions engaging research, policy, entrepreneurship, and activism. These practices have created diverse ways of working with local communities that differ from Community Design Center collaborations with neighborhoods. In all these cases, collaboration starts before design begins and extends beyond the completion of construction creating new fields of engagement.

Three decades ago, Kenneth Frampton identified how architecture's preoccupation with autonomy "derives in large measure from the fact that nothing could be less autonomous than architecture." (Frampton 2011, 26) Jeremy Till also points to the extent of architecture's contingent nature. Dependency is.

a defining feature of architectural practice, and in particular the introduction of others into the processes and products of that practice, brings with it political and ethical dimensions. (Till 2009, 151)

He suggests a reformulation of practice and proposes a future in which the architect brings together conflicting voices to work responsibly for the built environment a move from the idea of architect as expert problem-solver to that of architect as citizen sense-maker; a move from a reliance on the impulsive imagination of the singular genius to that of the collaborative ethical imagination. (Till 2009, 151)



Figure 3: Global Assessment for a New Economics (GANE). Source: <https://www.york.ac.uk/new-economics/>

RESEARCH-IN-PRACTICE

The ways architects participate in the design of built environments have evolved. The research to practice groups addressed in this paper signal renewed interest in participatory processes. They are concerned with understanding and making connections with the next larger context in the network of relationships telescoping from team to organization, to culture.

Research-in-practice can take the form of an independent think tank, foundation, and urban innovation lab that brings together researchers and practitioners in disciplines including urban studies, geography, architecture, design, social and political science, economics, and management. They include non-profit organizations such as Partners for a New Economy, New Zealand, the EU-funded Common Wealth and Green European Foundation, and the privately-led Laudes Foundation. These groups are a part of a Europe-wide swath of practices that explicitly focus on projects that challenge mainstream economic systems in which sustainable 'green' policies result in inequalities. (While this paper examines groups in Western Europe, initiatives in the US intersecting design and government include the Mayors' Institute on City Design (MICD) founded in 1986 in collaboration with the National Endowment for the Arts. Partnerships between the city and external parties such as the City of Boston department of New Urban Mechanics pilots technological and educational innovations to improve civic services. Signs of new economic and social alternatives to neoliberalism in the US include the Green New Deal and the Roosevelt Institute report titled *The Emerging Worldview: How New Progressivism Is Moving Beyond Neoliberalism*, which states "Neoliberalism has failed." (Wong, 2020).

The case studies presented in this paper addresses research-in-practice in the Nordic region. The countries include Denmark, Finland, Iceland Norway, and Sweden. The structure of the political (and administrative) systems in the countries occur at the levels of the state (national), the county or region, and the municipality (local). Strong social democratic traditions align with the larger project to remake and rebuild the commons by focusing on ideological and material urban infrastructure. Through case study I will examine how a tradition of research-in-practice in Helsinki, Finland reshapes the city through new economic thinking engaging design with governance structures, and policies. The paper addresses how the practices synthesize disparate bodies of knowledge, how they use platforms to render urban engagement, and the role of design as a tool for policy and governance.

The roots of Finnish research-in-practice reach back to 1968. The story begins when a group of Finnish students, members of the Scandinavian Design Students' Organization (SDO) applied for and received government funding to host a seminar that would disrupt the principles and ethos of a design and educational culture focused on aesthetics they had inherited from the 1950s and 60s. These decades now referred to as Finnish design's "golden age" were a period of growth for industrial design after Finland received the largest relative proportion of prizes at the 1954 Tenth Milan Triennale. The students from engineering, design, and architecture, including Juhani Pallasmaa, were dissatisfied with their design education and sought new ethical purpose and methods to address society's pressing problems. That summer they organized the Industrial, Environment and Product Design Seminar. Invitees Christopher Alexander, Buckminster Fuller, Victor Papanek, John McHale, Kaj Frank and other Swedish and Finnish designers held workshops addressing issues and working methods related to systemic design practices that would connect science, engineering, the social and behavioral sciences, and economy. They spoke about how such design practices could help to deter immanent environmental catastrophe.

The Industrial, Environment and Product Design event led to the founding of Sitra, the Finnish government's innovation fund. Supervised by the Finnish Parliament, Sitra would support the study on economy, education, and future development scenarios in a new kind of cross disciplinary collaborative form of design research connecting technical,

industrial, and governance activities that fell into a sort of no-man's land. Sitra took on the challenge presented by the Finnish students to extend the craft-based tradition of Finnish design to move beyond products, objects, and buildings. 1 Sitra has evolved to promote national economic development and international competitiveness through studies, trials, pilots, events, and training on the themes of carbon-neutral circular economy, societal renewal, and work life. Sitra repositioned design at a deeper level in society, embedded within government yet operating autonomously to develop strategic capabilities rather than solving specific problems.

In 2005 Demos Helsinki, a research and development spin-off of Sitra, authored a report entitled *The Voice of the Individual - The Welfare State in the Age of Communities* examined the role of human behavior in systemic change. The aim of Demos is to "develop democracy to suit the needs and capabilities of the people in the 21st century." The experimental think tank gathers professionals, academics, entrepreneurs and civic groups in Finland, Sweden, and Norway. Collaborators develop public awareness actions, urban visions, and new experimental concepts for public spaces and civic services with companies, cities, governments and communities. The application of systems approaches in the public sector includes the design of a policy framework to conduct experiments linking design and government that are co-created with stakeholders, municipal organizations and civic institutions. For example, Hoffice in Helsinki Stockholm and Copenhagen began as an idea for live/work in which residents could turn their living quarters into co-working spaces for teleworkers and freelancers. Hoffice was part of a Nordic start-up program run by Demos to explore new uses for Helsinki's vacant urban buildings and address housing shortages. The program is a sharing economy which is free for participants, who contribute voluntarily to expenses. However, apartments have been sold as live/work spaces. Working with Aalto University, Demos Helsinki developed the Design for Government model to develop experiments in policy design based on qualitative research. The Smart Retro program (now called Peloton) examines how to use digital technologies to sustainably retrofit the existing building stock of cities. Other academic programs such as the Centre for Design Research at the Oslo School of Architecture and Design investigate global and local contexts for design processes, products, and planning. They link theory, practice, and analysis through interdisciplinary research.

The research arm of the Finnish Innovation Lab is the Helsinki Design Lab (HDL) created in 2008 by Marco Steinberg, Sitra Director of Strategic Design. 2 HDL was given the task to address the institutional and social challenges that Finnish governments and other public organizations were facing in complex changing contexts. Steinberg was inspired by the legacy of the Industrial, Environmental and Product Design conference. HDL worked from the proposition that while the world was in "crisis" and facing problems from social inequality to ageing to climate change, government was insufficiently equipped to deal with them. They argued that the flaw in this system was the disconnection between design and delivery. A fundamental reconceptualization of how government approached big projects was needed. The boundaries of complex problems and their processes could be rethought as a way for architects to participate in the larger field of design. HDL sought to help decision makers view problems as part of a larger perspective, developing a way of working called strategic design. Their approach was informed by three questions: How to educate strategic designers? How to increase the supply of practices capable of providing design services? How can governments and foundations commission projects for strategic design?

HDL wanted to provide a platform for conceiving and developing design as the driver of change. They proposed to examine the forces and flows affecting large-scale projects in two ways: 1) the development of strategic design as a methodology and a philosophy and 2) analysis of projects that were intentionally designed to achieve larger effects. HDL studied the techniques for social participation and community cooperation through digital networks, connecting architecture/urban design, economics and social sciences. Constitución Chile, Brownsville New York, Gov.uk and Branchekode.dk were examined as cultures of successful decision making. The results of this work informed the organization and construction of the Low2No Sustainable Design and Development Competition located in new neighborhood of Jatkasaari in West Helsinki.

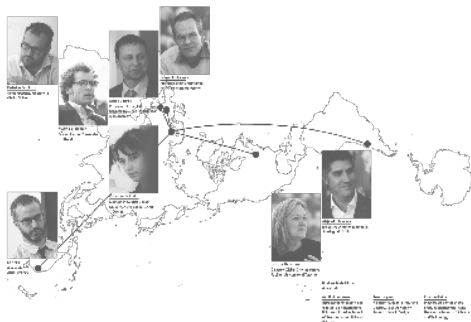

Figure 4: Sitra Sustainability Studio. Source: Boyer, B., Cook, J., Steinberg, M. 2011. *Recipes for Systemic Change*. Helsinki: Sitra/Finnish Innovation Fund.

STRATEGIC DESIGN

Strategic design was conceived as a research-in-practice model that brings architects into an expanded design process to influence public policy formation. Initiatives put in place by national government placed design within federal and local authorities to foster the creation urban plans, websites, and public services. In the tradition of linking art and manufacturing, the Finnish model connects academic, activist, professional, government, and industrial fields in transformative collaborations and processes that embed design into the processes of everyday life.

Strategic design was developed to address macro-level, big-picture disparities in areas such as education, health care, housing, and sustainability. It engages with the craft of decision-making and begins with the redefinition of how problems are approached. Whereas established definitions of design most often aim to create discrete solutions in the form of a building or an object, strategic design is aimed at systemic change. It is based on confronting the forces, ideologies, and organizations that generate and reinforce structural racism; ethnic or gender discrimination; and labor, work, economic, and environmental inequalities. The design or reconstruction of a town, neighborhood or urban space offer entry points to larger debates about equity and opportunity, as well as more abstract issues of the political, legal, economic, and cultural conditions that construct the status quo.

Strategic design is based on the architectural design studio model and was conceived as paradigm for practice, a tool that allows organizations to quickly sketch new solutions matching challenges to kickstart the transformation process. If the design studio was an ideal platform for codifying and experimenting with design, architectural thinking was particularly useful for conceptualizing problems. Discussion on a shift in architectural education where rather than designing buildings architects should redesign the systems around which built forms exist and evolve. Instead of designing a hospital, for example, the studio model would develop research into the healthcare system. Instead of a school building, research on how to induce better learning methods for the future, in this way engaging a project before design begins as well as continuing involvement after construction ends with the aim to change systems.

The work of HDL was part of growing interest in applying systems thinking to social and public policy changes. This field is especially strong in the Nordic countries, where universities in Finland, Sweden, Norway and Denmark have been practically the first to expand the field of design by initiating new majors and curriculums. To formulate their “recipes” for systemic change, HDL imported the architectural design studio model, which they all knew quite well, into their work for HDL. They used the design studio as a model of problem solving that diverged from the more commonly used linear approaches endemic to government policy decision making, to redesign the process at the individual, group and institutional levels. This was most agile way to operate in times of uncertainty and continual change, when increasingly, society operates in contexts where evidence is still developing, information will always be incomplete and debate around facts is ongoing. An important goal was to be capable of framing relevant questions.

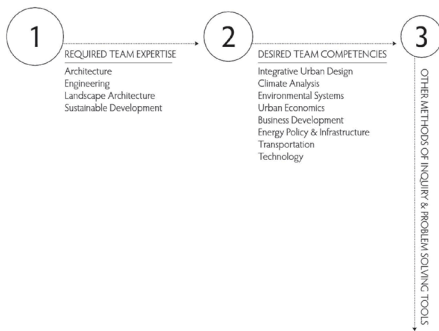

Figure 5: Low2No Criteria for RFQ. Source: Sitra/Finnish Innovation Fund Low2No Competition Request for Qualifications 2011. www.low2no.org. Cited in Liang, Z. 2014. Design Competition towards Sustainability: A Case Study of Low2No International Competition in Finland. 5th International Conference on Competitions: Delft University of Technology; Bechthold, M. and Kane, A. Low2No: Strategies for Carbon Neutrality. <http://helsinki.designlab.fi>

LOW2NO

Low2No is a design competition and construction project that aimed not only to deliver a more sustainable built environment for ecological urban living but also aimed to develop a market for development that would put Finland on a more sustainable path. The term comes from the phrase "from low carbon to no carbon" and refers to the gradual and iterative transition to zero carbon city building. Sitra/HDL designed and funded the Low2No competition, acting as enabler to lead the project team through city block design phases and initiate related projects such as Open Kitchen. Built in partnership with private companies, Low2No was meant to demonstrate to city government that social and environmental objectives could be economically viable. Besides low-carbon, energy efficient construction, a key priority was to enable lifestyles and consumer habit. Financial, regulatory, and cultural barriers to low carbon building were examined through events, partnerships, and targeted investments to ensure stakeholders that solutions were possible, effective, and lasting - evidence that sustainability was not merely a technological question but a cultural challenge.

The competition was designed to emphasize long-term systemic change, especially the shift to a low-carbon country. Building was an enabler of such change rather than the end. This approach is evident in the procurement process, which foregrounded reproducible approaches and a team capable of designing a diverse range of approaches and strategies rather than just a physical proposal. The architecture, a 12-story wooden apartment building, was conceived by HDL as a platform to explore, rethink, and provide for:

- creative procurement processes
- food culture in Finland in terms of food retail and food production that emphasize local, organic approaches including urban agriculture
- the use of timber (CLT) as a construction material, creating new futures for the Finnish forest industry traditionally used for paper processing, which is endangered by cheaper, faster timber production from the Global South.
- new ownership and tenancy models
- carbon accounting to counter construction industry greenwashing
- communal facilities of the shared sauna to reverse trends towards privatization of an essential element of Finnish life
- participatory design processes engaging the built environment industry
- prototyping behavioral change amongst residents, workers and visitors. (Hill, 2014)

The more immediate consequential outcomes of the project have been to put in place an approach to architectural competitions focusing not just on a building solution, which often encounters financial and cultural roadblocks (like the Helsinki Guggenheim competition). Another early achievement lay in working with the authorities to change fire codes to allow multi-story timber construction and provide future projects with the possibility to use low carbon building materials as well as opening a new market to the Finnish forest industry.

Additionally, in place of the traditional procurement method to which public (state) organizations like Sitra/HDL were obliged to follow, the competition called for strategies in response to issues of low carbon building rather than only a building proposal. Teams selected to participate for the breadth, depth, and complementarity of their experience were in the 2nd phase asked to develop a method to work through the creation and construction of a low carbon urban development project. The commission awarded to a team and entry that emphasized informed consumption through interfaces allowing users to view their energy and carbon profile, carbon mitigation via investments in renewable energy for district heating and cooling from a centralized location combining heat and power plants, and a process for co-creation of new housing models through workshops with future residents.

The ambition of Low2No was to enact larger-scale social and economic change. The project expanded the strategic design research of HDL to include ideas about the design of more effective services that would bridge between the enablers of change (governments, politicians) and those who deliver on those visions (civil servants, professionals, designers). This kind of project has been addressed as a kind of design activism in which municipalities and government support initiatives explicitly aimed at seeking alternatives to the status quo. 3 (Berglund, 2013)

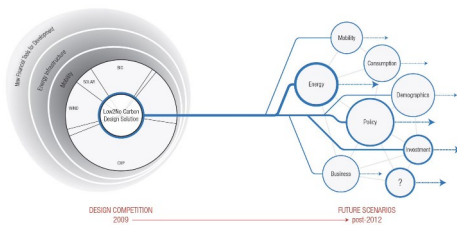

Figure 6: Low2No Future Scenarios. Source: Sitra/Finnish Innovation Fund Low2No: A Sustainable Development Design Competition. 2009. www.low2no.org

The Humble Timber initiative extends the achievement of Low2No in legalizing tall building CLT construction in Finland. The search for concrete solutions to carbon neutral building is based on a way of working that addresses issues of supply/demand and incentives driving the cost, capacity, efficiency, and skills of timber construction supply chains, sustainable forestry practices, and benefits to end users. Communication with actors in the building industry focuses on the creation long-term demand, delivery of education, and provision of projects as guiding examples.

In the Nordic region, design has historically created national identity and supported industry. An activist design ethos emerges in the research-in-practice work that aligns with a larger project to remake and rebuild the commons across Western Europe in different fields, locations, and scalable dimensions. The work presents alternative economic scenarios that challenge the way in which the built environment is produced and may help to clarify how understandings of disciplinary conventions, assumptions, and epistemologies of design practice, processes, and practice-led design research are changing.

Such challenges, frequently occurring outside of the regulated approach of professional organizations that direct and validate architecture school curriculums, also raise questions on how architecture education may often be a lagging

indicator of social, political, and cultural realities. An opportunity to address how to prepare future professionals to think about and act upon urban environments in a time when cities become increasing complex entities is presented. This is an imperative to actively cross disciplinary boundaries and contribute beyond buildings to engage in a more systemic manner the fields that are determining the shape and performance of cities and built environments.

REFERENCES

- Banham, R. 1971. "Alternative Networks for the Alternative Culture?" in Cross, N. (ed.) 1972. *Design Participation - Proceedings of the Design Research Society Conference*. London: Academy Editions.
- Berglund, E. 2013. "Design as Activism in Helsinki," *Design and Culture* 5:2. Taylor & Francis Online.
- Bezançon, X. 2004. *2000 Years of Public-Private Partnerships (2000 Ans d'Histoire du Partenariat Public-Privé)*. Paris: Presses de l'École Nationale des Ponts et Chaussées.
- Boulianne, S. 2009. "Does Internet Use Affect Engagement? A Meta-Analysis of Research." *Political Communication* 26:2. pp. 193–211.
- Dasgupta, P. 2021. *The Economics of Biodiversity: The Dasgupta Review*. London: HM Treasury.
- Deamer, P. 2013. *Architecture and Capitalism: 1845 to the Present*. United Kingdom: Routledge.
- Deamer, P. 2020. *Architecture and Labor*. United Kingdom: Routledge.
- Easterling, K. 2014. *Extrastatecraft: The Power of Infrastructure Space*. United Kingdom: Verso.
- Frampton, K. 1991. "A Critique of Contemporary Production." Ghirardo, D. (ed.) *Out of Site: A Social Criticism of Architecture*. Seattle: Bay Press.
- Gutman, R. 2007. *Architectural Practice: A Critical View*. New York: Princeton Architectural Press.
- Hemmersam, P., Martin, N., Westvang, E., Aspen, J., Morrison, A. 2015. "Exploring Urban Data Visualization and Public Participation in Planning," *Journal of Urban Technology* 22: 4, 45–64.
- Hill, D. 2014. *Dark Matter and Trojan Horses: A Strategic Design Vocabulary* (Moscow: Strelka Press)
- Micheli, P., Schoeman, M., Baxterm, D., Goffin, K., 2012. "New Business Models for Public-Sector Innovation: Successful Technological Innovation for Government." *Research-Technology Management* 55:5. Taylor & Francis, Ltd. Accessed November 1 2022. <https://www.jstor.org/stable/10.2307/26586337>
- Papenek, V. 1971. *Design for the Real World*. New York: Random House.
- Romeo, N. 2021. "Is it Time for a New Economics Curriculum." *The New Yorker*, October 8, 2021.
- Sanoff, H. 1999. *Community Participation Methods in Design and Planning*. New York: John Wiley and Sons, Inc.
- Sanoff, H. 2010. *Democratic Design: Participation Case Studies in Urban and Small Town Environments*. Berlin: VDM Verlag.
- Sanoff, H. 2003. *Three Decades of Design and Community: History of the Community Development Group*. Raleigh: North Carolina State University.
- Srnicek, N. 2017. *Platform Capitalism*. Cambridge, UK: Polity Press.
- Tafuri, M. 1976. *Architecture and Utopia: Design and Capitalist Development*. Translated by Barbara Luigia La Penta. Cambridge, Mass.: The MIT Press.
- Till, J. 2009. *Architecture Depends*. Cambridge: The MIT Press.
- Wong, F. 2020. "The Emerging Worldview: How New Progressivism Is Moving Beyond Neoliberalism." Accessed November 1 2022. <https://rooseveltinstitute.org/publications/the-emerging-worldview-how-new-progressivism-is-moving-beyond-neoliberalism/>
- Zuboff, S. 2019. *The Age of Surveillance Capitalism*. London: Profile Books

ENDNOTES

¹ "The goal of the fund is to promote Finland's stable and balanced development, quantitative and qualitative growth of the economy, as well as international competitiveness and cooperation, especially by working to implement projects that make the use of the resources of the national economy more efficient or raise the level of research and education, or that explore future development options." See <https://www.finlex.fi/fi/>

² Steinberg asked his ex-Harvard and RISD classmates Brian Boyer and Justin Cook to join him in founding the Lab. Boyer had worked as an independent architect, software programmer, and technology entrepreneur. Cook had experience in Renzo Piano Building Workshop in Genoa and as principal of a design-build firm in Seattle. They were joined by Dan Hill, an urban sociologist who had worked as an Associate at Arup.

³ Design activism typically includes small DIY efforts to counter market-driven, high-technology notions of sustainability.

Developing a Transdisciplinary Assessment of User Research and Feedback from Early-Stage Experiential Prototype Development

Greg Garner¹

¹NC State University, Raleigh, North Carolina

ABSTRACT: There is growing consensus that data-informed decision-making through human-centered inquiry and design process results in improved outcomes for designed artifacts. Among the latest trends is a group of tools and processes loosely assimilated under the umbrella term, “design thinking.” Broadly, these are ways to make explicit the habits, traits, skills, and cognitive methodologies that designers utilize to move from concept to finished design. In most design thinking processes, shortly after problem identification and definition, a low-fidelity prototype or mock-up that mimics key aspects of the desired experience or interaction is tested with users. This prototyping phase represents a form of data collection that then informs future design decisions. It is not, however, without significant risk, most of which lies within the designer’s processes and methods, especially as it relates to the user feedback they collect and then interpret.

Prototype testing represents a pivotal moment in the design process, and more often than we’d like to admit, our confirmation bias, vision for what will be, and lack of effective questioning strategies results in only hearing what we want to hear. Through a pilot study using a content-neutral virtual reality (VR) prototype learning experience, pulling from the disciplines of design, education, and psychology, a semi-structured interview protocol was created, based on a tripartite assessment heuristic used with grade school teaching strategies and professional development. The use of transdisciplinary models and assessment strategies to decode the feedback users provide during the prototype development process suggests a more holistic approach for designers to capture relevant user insights. Further, the designer can then assess the feedback received against design goals while mitigating confirmation bias during the interview process. This paper claims that these strategies lead to actionable user insights designers might have otherwise failed to discover.

KEYWORDS: Transdisciplinary, Prototype, User Research, Feedback

INTRODUCTION

The value of mock-ups or prototypes is gaining acceptance as a valuable tool in product and interface design. As Martin and Hanington note, “prototypes serve an internal development purpose, as a checkpoint for the designer or team” (Martin and Hanington 2012, 138). Within the framework of design thinking, stages of user research, rapid prototyping, and product refinement often cycle until the designer has created what venture capitalists might refer to as a “minimum viable product,” where the product has been refined such that the designer would be willing to expand its reach beyond the test audience. The role and nature of the designer throughout this framework is assumed to be “in charge” of their creations, based on the data collected throughout the various stages, meaning that the designer’s intent as well as their own unique understanding of the world plays a tremendous influence into the development of their artifacts and experiences. It is here we find a gap between the designer’s intent and the expectations that a user brings to an interaction. Within design thinking, one implicit role of rapid prototyping is to close this gap by collecting user feedback as early as possible, often through tacit, empathy-based psychological principles and strategies. It is at this stage that designers are ill-equipped to integrate the feedback they’re collecting with the delta between their intent as a designer and the user’s expectations, demonstrated by the author’s original framework in Figure 1.

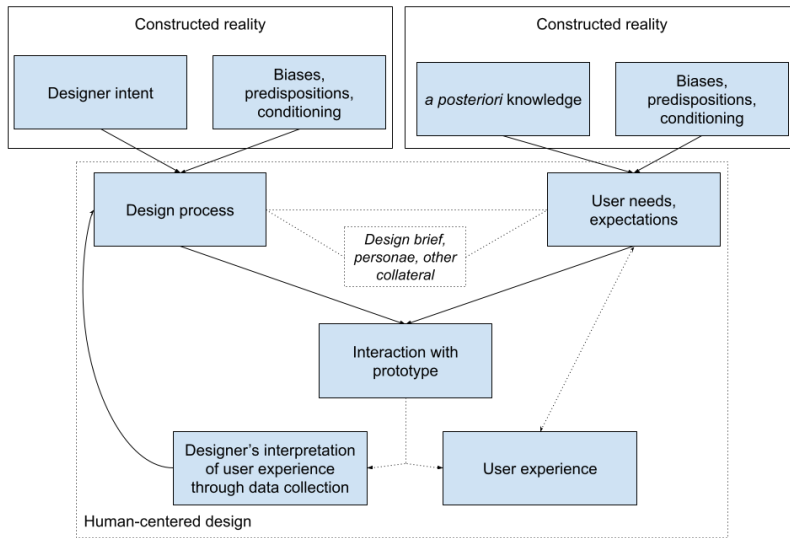

Figure 1: Interaction of designer intent, user expectations, and prototype iteration process (original work)

This research asserts and assumes that there is a gap, but that this gap can be known by designers. The existence of this gap does not represent a failure of the designer, but failure to see and understand the nature of this gap is detrimental to the ultimate utility of the artifact. As will be seen, there may even exist different types of expectation-experience gaps that extend into socio-emotional affective states. Simply put, the designer has not met their goals until they understand this gap and have altered their design processes as appropriate, whether to further utilize the gap or to mitigate its effects. Popularized design psychologies and methodologies as well as established protocols within human-centered design fail to incorporate appropriate mechanisms for understanding this gap, particularly within the context of iterative design processes that incorporate multiple prototypes at increasing levels of refinement. Further, these methodologies and protocols are fundamentally and continually centering the designer and not the user, compounding the opacity of the gap.

Within the context of learning experience design, the use of a heuristic assessment model from the discipline of education may prove useful for decoding and understanding the experiences of users, particularly if the designer does not themselves have significant depth of knowledge as it relates to teaching and learning processes. Many designers bring specific expertise in product, experience, process, or aesthetic development but are not themselves psychological nor educational experts at understanding the feedback provided by end-users whose formal training is in domains other than design. This study utilizes TPACK as its heuristic assessment model, useful in identifying and explaining differing domains of knowledge that a teacher must possess to create learning experiences (Mishra and Koehler 2006). TPACK can be described as a three-part Venn diagram with distinct knowledge domains for Technology (TK), Pedagogy (PK), and Content Knowledge (CK). Where each of the domains overlap represents an additional knowledge domain formed by the intersection of the others. (e.g., where TK and PK overlap, TPK is formed, representing how teachers use technology to create learning experiences, devoid of a particular CK.) Where TK, PK, and CK overlap in the center, TPACK is formed, representing expertise in the correct use of technology to teach a particular content in a way that maximizes learning (e.g., Figure 2).

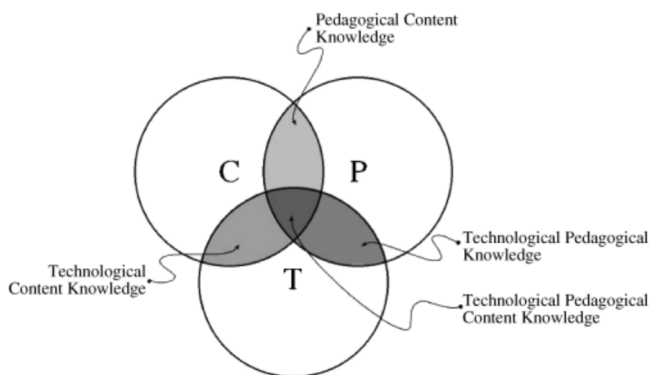

Figure 2: Pedagogical Technological Content Knowledge. The Three Circles, Content, Pedagogy, and Technology, Overlap to Lead to Four More Kinds of Interrelated Knowledge. (Mishra and Koehler 2006)

1.0 METHODOLOGY

1.1 Research Epistemology

This research is focused on the lived experience of the research participants. Participants will describe what they're thinking, what they're feeling, and how they're affected by a particular event, in this case, engaging in a technology-mediated learning experience. Ontologically and epistemologically, the researcher's role in this study is to "discover" how each participant views the world and to "get as close as possible to the participants being studied" (Creswell and Poth 2018). For these reasons, a qualitative constructivist framework that asserts multiple constructed realities best positions itself to accomplish these goals. As Mertens notes, "(q)ualitative methods also allow for inclusion of participants' differences in beliefs, values, intentions, and meanings, as well as social, cultural, and physical contextual factors that affect causal relationships" (2015, 238).

Methodologically, this epistemological framework facilitates two distinct approaches that can be blended. From ethnography, an *emic* approach to the data is employed, in which the author's position as a researcher becomes embedded within the collection and interpretation of the data. The data include participant observations and narratives, which are useful in new product development processes to not only capture the facts of the human experience but also the meaning constructed around the event and the meaning-making thought processes employed by the participants (Sakellariou, Karantinou, and Goffin 2020). By recentering the participant and their experience, both the researcher and the designer are de-centered, creating psychological space to question previously held assumptions and bring about new insights (Cayla, Beers, and Arnould 2014). From phenomenology, analytical methods that investigate overlap in how participants "interpret the world and life around them" (Mertens 2015, 248). Indeed, the field of interaction design already relies heavily upon phenomenological methods to derive insights from user experience research efforts (Martin and Hanington 2012). However, it should not immediately be assumed that the experiences described are generalizable to broader populations but instead serve as a starting point for designers to understand how they might improve their own inquiry methods based on their own sample populations.

1.2 Sample

Sakellariou, Karantinou, and Goffin describe the value of "small, carefully screened samples of users from the market segment under investigation" within the confines of ethnographic market research allowing "focused, less time-consuming data collection" due to the vast quantity of data that can be collected through ethnographic inquiry (2020, 4). Within the context of prototype development, speed and iteration are inherently prioritized over the perfection of any single artifact (Kelley and Kelley 2013). By combining these approaches (carefully selected users and rapid prototyping), future designers and researchers can reduce the time-to-market of their ideas and build confidence in the feedback received on the aspects of their prototype that need additional refinement as well as the aspects that are not resonant with their target population.

The three participants in this study are graduate students at a major university in the southeast United States, pursuing an advanced degree in the field of education. Graduate students receiving formal training in education practices are primed to consider how their prior life experiences and training inform their own learning experience design processes as well as their interactions with the prototypes in this study. This group was selected for their attention and intention to their own personal development in all three areas of TPACK, as the graduate program in which they are enrolled contains coursework that specifically targets each of the three primary domains. Each individual's expertise and experience with any one or any combination of two or three areas of TPACK will vary and supports the need for phenomenological methods to understand their experiences.

Alice (all names pseudonymous and chosen by the participant) is a former middle and high school English teacher and at the time of the interview, was a second-year doctoral student pursuing a PhD in Literacy and English Language Arts. She noted that, "the most I've used educational technology was over the last year and a half when I taught during COVID." Alice utilized Prototype 1, described in the next section. John is a former STEM (Science, Technology, Engineering, and Mathematics) teacher and STEM Director and has worked in K-12 environments in small, rural counties as well as large, metropolitan counties. His background with technology is extensive and includes virtual reality as well as 3D printing and other more advanced technologies. At the time of the interview, he was pursuing a PhD in STEM Education. John utilized Prototype 3. Justin is a Teaching and Learning with STEM PhD student with an undergraduate degree in Technology Education and a Masters in Technology and Innovation. He has not served as a K-12 classroom teacher but has served as a student teacher and TA, all in technology education courses. Justin utilized Prototype 2. Based on their descriptions of themselves and their respective experiences, Alice has high general Pk and high Ck and Pck within the field of English. She has relatively low Tk, TPk, Tck, and thus overall low TPACK. John has an average Pk with medium-high Ck, Tk, and Tck in technology as a domain, giving him average TPACK. Justin has relatively low Pk, but high Ck in Technology Education. His high overall Tk means his TPACK is average, depending on the ways he incorporates and builds upon his Pk.

1.4 Data Collection Procedures

The research is comprised of three stages and four distinct data collection methods, with participants serving as learners within a prototype learning experience using virtual reality (VR). The learning experience selected was a crisis intervention training for responding police officers. The experience is intended to be a standalone learning event and

teaches both the process and procedure for responding to a mental health crisis emergency call. This topic was specifically selected to mitigate any effects of prior content knowledge (Ck) as it exists outside of a typical course of study for primary and secondary schools. During the first stage, participants received the exact same instructions about a participatory learning experience. They are told the nature of the learning experience including the learning objectives as well as instruction to consider the experience to be a prototype of a VR experience. After receiving instruction, the first round of data collection begins through a semi-structured interview to ascertain their background and contextual experience. Immediately following begins the second stage in which participants engage with one of three prototype designs, varying in their level of detail and development. Held constant in each prototype is the content delivered. Prototype 1 is an instructional video filmed in third person, with and audio narration, hosted on YouTube (Figure 3). This level of development would be equivalent to a design brief provided by a client or via request for proposal. Prototype 2 (Figure 4) is a first-person, interactive slide-based training with audio narration, developed with course-building software and includes additional cognitive tasks for the learner but does not alter the content addressed from Prototype 1. This prototype serves as a mock-up of the designer's first attempts at delivering on the brief and incorporating additional experiential elements from the original prototype. Prototype 3 (Figure 5) is an immersive, first-person VR experience and represents a final, full-featured prototype that most closely represents what will be the final deliverable. While the participant engaged with the assigned prototype, they were observed and asked to describe what they are doing, thinking, and experiencing, commonly referred to as a "think-aloud" protocol. The shift from third person in Prototype 1 to first person in Prototypes 2 and 3 is an intentional psychological and educational strategy, designed to increase the empathy and cognitive awareness of the learner. This shift would mirror the difference between a small-scale physical model of a building that could be observed somewhat passively compared to an immersive digital rendering to be explored by (or through the perspective of) a future occupant. Notes and jottings were captured and included in data analysis. During prototype use, users may ask questions and answers were provided, but there was no other intervention or any type of interview nor additional prompts. The final stage of the research consists of two data collections, a pre/post assessment and a final semi-structured interview to compare their experience against their baseline expectations, again using TPACK.



Figures 3, 4, and 5: Screenshots of prototypes 1, 2, and 3, respectively (lightcrusader2, 2014)

1.5 Data Analysis

Data analysis began with thematic qualitative coding based on interviews and observation. Themes were analyzed against the TPACK framework and categorized into whether they represent technological knowledge, pedagogical knowledge, content knowledge, or the intersection of any combination therein. Responses were not assessed with assigned positive or negative value (i.e., is the participant demonstrating a lack of knowledge or expertise in this area?), merely whether the participant's response reflected that expertise in the given area would be useful to the designer in understanding the feedback given. The analysis looked for indicators of bias and unmet expectation on the part of the participant as well as any indication that design process changes may be warranted. Such changes might have

discovered these elements prior to the testing of the prototype, such as through a more reflexive interview, a more detailed user persona, or other method. It is here that a transdisciplinary approach incorporating their knowledge of design, psychological methodologies and framework including research on affect and expectation, and an educational framework aligned with the content of the experience provide the designer with additional tools to understand and interpret user feedback. The use of the TPACK framework helped triangulate the design refinements the designer might have pursued based on the themes present in the user feedback while highlighting what knowledge areas, if any, weren't shared by the participant, either in the initial interview or any of the subsequent data collections.

2.0 FINDINGS

While TPACK was a heuristic assessment framework for coding participant responses, the codebook was not limited solely to combinatory tags of various knowledge domains (i.e., TK, PK, CK, TPK) and analysis was open to other recurring themes, yielding a theme labeled *Prior Experience*, in which participants described their specific life experiences as they saw they related to the task at-hand. A theme that was not anticipated at the start of the study but became prominent among all participants was labeled *Affect*, drawing heavily from psychology's body of knowledge. Responses in this theme focused on how participants felt emotionally, empathized with hypothetical student experiences, or reflected on how this experience otherwise affected them. While observations related to TPACK, including met or unmet expectations related to the prototype, were expected to be primary drivers of the research findings, the additional themes have added considerable context and are worthy of additional research.

2.1 TPACK

The most common feedback given was related to technological knowledge (Tk). Participants had significantly different levels of expertise when it comes to technology and all three participants shared that they believed their role in this user testing to be assessing the technology itself and not the learning experience. In addition to the heuristic categories Tk, TPk, and Tck, the designer should assess the context in which each of these knowledge domains have been developed. During John's use of a 3D, immersive iteration of the prototype via Google Cardboard, the difference between his TPk and his VR-specific Tk became very clear. While he felt comfortable identifying ways that VR could provide specific enhancements to the learning process, he was not personally comfortable navigating the VR experience, reporting limited direct, hands-on experience. He needed significant support to complete the specific tasks of clicking on items in the scene and other common UI/UX elements of VR. At one point, he asked if he could remove his phone from the headset and just look at it "like normal" instead of in the immersive VR viewer. The designer may look at such an interaction and think that the entire learning experience needs to be redesigned. Or they may think that their tester just isn't very good with technology. Or they may think that additional supports or scaffolds may be warranted, such as a user guide at the start of the experience that teaches the VR user how to use the device. All or none of these may be true, but without an appropriate assessment mechanism, the designer does not have a clear path forward for the next iteration of the prototype. To wit, at the conclusion of the test, when asked what the next stage of development was for the VR experience, John replied that he would like to add the ability to walk around the virtual room and he would like to see more detailed interaction between the characters. Considering the hurdles described above, how then should the designer interpret this comment in order to proceed with the next stage of development?

More than half of total participant responses unrelated to technology came *after* giving a response related to technology, many after being specifically prompted to think beyond technological-specific purposes. It is the author's opinion that this finding, more than any other, represents the single most important change a designer can make to their design process: when conducting any form of user research, the designer must clarify the user's exact role in the testing process as well as what kinds of feedback are needed. While this finding may seem obvious to some, especially those who have expertise already in user research, it is not explicitly taught as part of the design thinking process. This is perhaps best demonstrated by Alice who, when asked what the next stage of development for the prototype might be, responded, "Well, I don't know a lot about VR, but I would imagine that they would have to um, I don't know. Start to develop the computer stuff to make it more like 3D? Or like to fit the VR, uh, systems, so that they could make it seem more real?" Alice's obvious hesitancy as she fumbles through this response stands starkly against her answer when asked, "What would be the next stage of development for this prototype, *instructionally*?" Alice's entire demeanor changed, a smile crossed her face, and she immediately started sharing several ideas, quoted below:

This feels a little bit more like something I could talk about... I would imagine that it would be useful to have discussions with people that experience it. 'What did you learn? What was your experience?' It seemed like it was geared towards law enforcement; having a group of law enforcement officers together discussing similar experiences would be the next step after watching that, and then presumably having other similar type VR experiences so they're not just seeing this one situation that turned out okay, (but) being able to see, 'Okay, well, what if this escalates and these strategies don't work?' Kind of (a series) with that debriefing process after each, so that you're processing the experience more.

In this instance, it is reasonable to believe that if a designer had asked the first question without the use of a heuristic device, the first answer would have been considered sufficient for the purposes of developing the prototype: the prototype needs to be "more 3D." If the designer of the learning experience prototype, however, could acknowledge that the participant's response was solely focused on technology (Tk) and used a follow-up question to investigate

improvements to the content (Ck) or pedagogical (Pk) principles of the prototype, then the second insight shared by Alice opens an entirely new path of possibilities including a more robust product portfolio and not merely iterative improvements on the existing product roadmap.

The final major finding related to TPACK is described as *the role of novelty*. All three participants situated their understanding of learning experiences in student engagement. When asked to define engagement more specifically, all three acknowledged that “engagement” is often wrongly used to describe how students may be “entertained” during a learning experience. Many instructional designers face this issue as the novelty wears off a particular experience or technology followed by a seemingly correlated drop in student engagement. Indeed, Justin noted, “if I’m going to bring in something, yes, it needs to be engaging at the forefront, but it needs to lead to long-term engagement and motivation... But you build that off the novelty.” Engagement is not directly associated with TPACK, but instead draws on education psychology research, especially regarding technology use in learning experiences. However, there is not yet any clear theory or cornerstone finding related to the interplay of technology as an instructional medium and the instructional methods an instructional designer or teacher chooses to utilize through their TPK. These three participants seem to agree with Clark that we should distinguish between technologies that merely deliver content and those that use inherent traits of a technologically derived experience to change instructional practice (Clark 1994). The former would thus be value-neutral and unrelated to the cognitive conditions of learning (e.g., Tk alone) while the latter begins to create meaning-making opportunities for learners to connect with the content in a new way (e.g., TPK). In this paradigm, the content of the learning experience can be held constant, as it was with the different prototypes, but the technological and pedagogical choices made for each prototype should be cognizant of the divide between novelty, which fades over time and exposure, and authentic learner engagement, pulling in components of motivation and intrinsic interest. The implications for designers are clear: the novelty of a new experience or new technology may garner the attention of your audience, but it is not sufficient over the long-term. Instead, novelty must translate into specific uses, in this case pedagogical practices, that will create long-term opportunities for the audience to choose to interface with the design, of their own volition and motivation and not merely out of requirement or necessity.

2.2 Prior Experience

During prototype testing, all three participants continually looked for connections to their prior experience. Perkins notes that the learning process and meaning-making must bridge contexts and that this bridging can be subdivided into a “low road transfer” (e.g., applying “well-practiced knowledge” from one context to another) and a “high road transfer” (e.g., generalizing and abstracting core principles to a new context) (Perkins 1986, 226). Both forms of transfer and context-switching were observed during prototype testing, but each serves a different purpose for the designer. Low road transfer was found in comments such as Justin’s remark that the prototype, “reminded me of a lot of other experiences... a fairly standard online training that we all end up doing at one point or another in our jobs.” This is an important contextual consideration when he’s describing other features that he’d like to see, such as, “Have you ever seen one of those (subtitles) where it highlights the word? It’s on and walks across. It might bold it and unbold (sic) it, or something like that.” His suggestion here can then be interpreted as a low road transfer where he’s acknowledging that he’s not actively problem-solving nor is he creating novel UI/UX solutions. He is taking something familiar from a different context and applying it to the context of the prototype experience. This is juxtaposed with an instance of high road transfer that required several rounds of follow-up questions before an insight was made. When Justin was asked what he hoped to see or experience, he said, “Some type of fluency by the end of it that allows me to have a successful experience.” This prompted a clarification of “successful,” which meant to Justin that he “got the outcome that was intended to be had” and that the experience was both “good” and “smooth.” Through additional follow-up questioning, this led to the insight that “if the person having the experience can zoom out and say, ‘Okay, well, this didn’t necessarily go the best, but I still see the value in it, and I had fun doing it’” then it can still be a positive experience. As he described it, this kind of experience would be “good” but not “smooth.” Later, he commented that he believed a person’s technological literacy (Tk) would alter their perception of the experience, saying,

If someone has the technological literacy to understand that these are difficult, and they’re also contextual in that they understand that people are trying to put these together, and they might not always have the most perfectly refined skill set when they’re putting these together. I think that sort of eases the times when it’s not perfect. I think having a contextual understanding of making presentation material and making interactive media... helps give it some grace if you will, if you understand how difficult this stuff is to put together.

What Justin is identifying in this insight is that he believes the user experience will be radically different based on the target audience and their own prior experiences. This is a significant insight that may result in the designer completely rebuilding their prototype to ensure that they have appropriately considered the content, the user interface, *and* how the content and the interface are working together, which we would call TCK. For a learning experience designer attempting to refine their prototype, this kind of high road transfer insight may not be directly actionable in the same way as a suggestion to add a visual prompt akin to ‘follow the bouncing ball,’ but it may yield greater overall impact than the low road transfer solutions that only make aesthetic modifications to the interface. Designers in other domains beyond VR product development might also gain insight into the differences between a low-road transfer that only make aesthetic changes versus a high-road transfer insight that completely alters the composition of the artifact, given the usability and experiential challenges that were previously opaque to the designer.

Within the first few minutes of the prototype test, John started a stream of consciousness that might seem at first to be a talkative educator in the process of meaning-making with his own thoughts, quoted at length here:

So, my first reaction is, 'Yeah, we're already inside (the scene) now.' So, from an educator's point of view, you know, when the kids walk in the front door, you're already starting to build that rapport. So, from an educator standpoint again, like I would need some type of introduction, or something, you know? 'Here's your person of interest, and just to let you know they just got in, you know, a fuss with their favorite person in the world which is their sister or their brother or grandmother.' And so that way you would actually, specifically kind of know how to build the rapport or build whatever connection you need to build quickly to kind of de-escalate this anger, or whatever is displayed.

In this interaction, John is transitioning from a low road transfer to a high road transfer. He is uncomfortable that the prototype experience starts inside the room, and he wishes there had been a lead-in with some additional context-setting before confronting the person in crisis and he is trying to resolve this discomfort. He begins by recalling a familiar context (his classroom) and tries to make connections accordingly. As he processes a more robust vision of how that might play out, additional thoughts emerge in his thinking. He is recalling prior experiences with students who may have had similar issues and beginning to see if the core principles from those interactions can be abstracted to support a new, unfamiliar kind of interaction. For a designer seeking feedback on their prototype, this single interaction is rich in insight that can drive significant development to the learning experience. However, if the designer does not closely analyze this interaction and does not have the contextual knowledge of what being a classroom educator is like, they may be unable to precisely interpret that, in John's opinion, understanding what the person is going through is not a content knowledge (Ck) problem, but a pedagogical (Pk) response problem. A designer misinterpreting John's comment might redesign the experience to begin earlier than it does, but this would still fail to generate the desired or expected learning. John's frustration is not that he doesn't know *why* the person is upset, but that he doesn't believe that he has the rapport-building skillset to appropriately address the situation. While a Ck problem may be addressed with additional or revised content, a Pk problem is addressed by a change in instructional strategy and/or instructional methods and should additionally draw upon ways the technology might also address these shortcomings (TPK).

While these high road transfer insights may be more transformative in terms of overall prototype development, this is not to discount the value of low road transfer insights which the designer can still utilize to more precisely understand the user feedback and develop a more robust mental model for the feedback they're receiving and thus provide additional context that the designer may choose to utilize in future prototypes, user guides, explanations to other user groups, and more. For example, how might a designer who doesn't share a professional experiential background with Alice interpret her comment, "when they were talking about open-ended versus the closed-ended questions. I was thinking about how that's something that we use when I was a writing consultant to try to get... them to lead the question rather than the consultant being the one that leads the discussion"? At first, it's tempting to see her comment as a simple low road transfer and possibly an affirmation of the instructional method (Pk). But her follow-up comment sheds light on the contextual questions that remain in her mind and the cognitive searching she is doing to try and place this content into a mental model for deeper understanding when she says, "I'm wondering what this is used for. Whether it's used for specifically police officers or if it's used just in general for crisis intervention." So, what began as a Pk low road transfer, when connected to her prior experience, becomes a Ck wondering and a shortcoming of the prototype that the designer should address by more clearly articulating the prototype's purpose and audience. Indeed, a building manager of a property with glass doors might etch 'Pull' on the exterior and still wonder why there are handprints from failed attempts to push the door open.

2.3 Affect

All three participants, in attempting to make connections to the prior experience, acknowledged an emotional response to the content being taught through the prototype, namely crisis intervention. An emotional response may or may not be desirable for a designed interaction, but within the field of psychology, any emotional response suggests an inflection point worthy of investigation. John noted within the first minute of the experience, "I don't know if an elementary education person is really supposed to do this... my initial reaction is, 'Why are we even here? Leave immediately.' Let somebody qualified take care of this because I have no idea." Similarly, within the first minute, Justin remarked, "I wasn't prepared for this to be a crisis intervention thing. I mean, it's fine. Maybe I didn't read something right, but I didn't know that that's where this was going, and that's totally fine. It's a good thing, and I think there's a lot of value for educators in learning these. I just didn't know that that's where this is going." While the participants were able to adjust, their rambling and somewhat disconnected comments suggest it was jarring for them and represents the first definitive gap between what they expected and what they experienced. From the field of psychology, there is significant research into affect theory and how humans respond to events that can inform the designer's investigation into how their participants experience their prototypes. Tomkins' categorization of nine distinct affects may serve as a useful starting point and has already been utilized in other studies, particularly in the assessment of aesthetic pleasure as well as the role of surprise in human motivation (McIlwain 2007). These kinds of "expectation gaps" triggering an affective change in the participant require the participant to switch contexts in order to regulate their cognitive disequilibrium. If the designer wishes to reduce this disequilibrium, the proposed solution follows the findings of Schiffer, et al. whereby "experience of outcomes and instruction can mutually inform each other to promote flexible, adaptive behaviour (sic)" and as such, the designer should provide clear instructions and set expectations to mitigate surprise from unexpected

events (Schiffer et al. 2017). Conversely, if the designer was directly attempting to create a situation to elicit surprise from the participant and it was not observed, this same heuristic would be useful for understanding why this affect was not observed.

All three participants were able to clearly describe changes to their affective state and how the prototype experience did or did not meet their expectations. In addition to the surprise exhibited by John and Justin (above), Alice noted, “even though what they’re saying feels true, and I know that (it’s trying) to be calming, there’s multiple layers of that same video. It stresses me out because I’m trying to keep attention to what I’m supposed to be looking at. And so, I feel escalated, even though it’s saying that I should feel like we’re de-escalating a situation.” For designers seeking feedback on their prototype designs, the affective responses from these three participants suggest that the potential for an affective expectation gap may influence the feedback received and should be considered when translating feedback into desired revisions for the next prototype. In some instances, such affective change may be desirable, particularly if the affect is positive. In other instances, such as when the affective change is merely surprise – startle, the designer should be aware of the novel and transitory nature of the emotion and design accordingly. In other instances, the designer may have an entirely unintended emotional response and may themselves experience surprise as the participants describe the changes in their affective state. In any of these scenarios, the designer should have a specific strategy for collecting, understanding, investigating, and resolving feedback related to affect.

CONCLUSION

This study establishes the need for a transdisciplinary approach with an evaluative assessment heuristic for use by the designer during prototype testing. Further, it assumes that there exists a gap between the designer’s intended experience of their design and the expectations of the user as they interface with the design. Use of a heuristic model, aligned to the nature of the prototype experience, allows the designer to more precisely investigate and understand the experience of their users. The key findings are:

- The use of the TPACK model as a heuristic model for a learning experience prototype proves to yield valuable insights not otherwise accessible to a designer not formally trained in education practices.
- Users bring significant background knowledge and context to their interpretations of an experience and engaged in active meaning-making and context transfer in their attempts to understand the experience.
- Users are emotionally affected in the use of a novel learning experience and these changes in affect must be assessed and considered as part of their overall feedback.

ACKNOWLEDGEMENTS

This study was conducted as a pilot for the author’s dissertation, who wishes to thank the members of their dissertation committee for their guidance and feedback during the development of this study.

REFERENCES

- Cayla, Julien, Robin Beers, and Eric Arnould. 2014. “Stories That Deliver Business Insights.” *MIT Sloan Management Review* 55 (2): 55–62.
- Clark, Richard E. 1994. “Media Will Never Influence Learning.” *Educational Technology Research and Development* 42 (2): 21–29. <https://www.jstor.org/stable/30218684>.
- Creswell, John W, and Cheryl N Poth. 2018. *Qualitative Inquiry and Research Design: Choosing Among Five Approaches*. Sage Publications. 4th ed. Thousand Oaks, Calif.: Sage Publications.
- Kelley, Tom, and David Kelley. 2013. *Creative Confidence: Unleashing the Creative Potential Within Us All*. Crown Business.
- lightcrusader2. (2014, July 18). *Crisis Intervention De-escalation Steps* [Video]. YouTube. <https://youtu.be/JERkZoWGLWQ>
- Martin, Bella, and Bruce Hanington. 2012. *Universal Methods of Design*. Rockport Publishers.
- Mcllwain, Doris. 2007. “Special Section: Pleasure in Mind: Silvan Tomkins and Affect in Aesthetics, Personality Theory and Culture.” *Theory & Psychology* 17 (4): 499–504. <https://doi.org/10.1177/0959354307079294>.
- Mertens, Donna M. 2015. *Research and Evaluation in Education and Psychology: Integrating Diversity with Quantitative, Qualitative, and Mixed Methods*. Ta - Tt -. 4th ed. Thousand Oaks, Calif.: Sage.
- Mishra, Punya, and Matthew Koehler. 2006. “Technological Pedagogical Content Knowledge: A Framework for Teacher Knowledge.” *Teachers College Record* 108 (6): 1017–54. <https://doi.org/10.1111/j.1467-9620.2006.00684.x>.
- Perkins, D.N. 1986. *Knowledge as Design*. Hillsdale: Lawrence Erlbaum Associates.
- Sakellariou, Evy, Kalipso Karantinou, and Keith Goffin. 2020. “From User Insights to User Foresights: Applying Video-Based Ethnographic Narratives and User Innovation in NPD.” <https://doi.org/10.1016/j.techfore.2019.119873>.
- Schiffer, Anne Marike, Kayla Siletti, Florian Waszak, and Nick Yeung. 2017. “Adaptive Behaviour and Feedback Processing Integrate Experience and Instruction in Reinforcement Learning.” *NeuroImage* 146 (February): 626–41. <https://doi.org/10.1016/j.neuroimage.2016.08.057>.

Educate, Embed, And Empower: *Prioritizing Research in Practice*

Sarah Wicker¹, Amy Keller Frye¹, Helia Taheri¹

¹CallisonRTKL, Dallas, TX

ABSTRACT: The demand for data-driven strategies to address global issues – environmental impact, urbanism, resilience, equity, and health – drive the fundamental research needs within the architectural practice. In response, almost all large architectural firms today maintain a research department in some capacity to create new knowledge for their practice, remain competitive, contribute to disciplinary discourse, and to reach quantitatively better outcomes. The value of conducting research in architectural practice lies within the tangible research output. This paper highlights how three firmwide research programs, between 2020 and today, led by a team of 3-5 researchers at a large United States based Architectural practice, changed the 1000+ person firm's culture through their goals and impact on employees, projects, and the industry at large. The internal firmwide programs shared include *Research50*, *Global Research Fellowship*, and *Research & Innovation MicroGrants*, all foster research, forward-thinking design solutions, and partnership that is directly applied to our built environments.

KEYWORDS: research knowledge, architectural research, survey, innovation, culture, collaboration

INTRODUCTION

1.0 RESEARCH IN ARCHITECTURAL PRACTICE

Architects have long considered research to be an innate part of project work, typically including understanding client needs, assessing building materials, exploring how the building may impact behavior or influence health, to understanding how the building performs once it is constructed. But the current architectural design process does not value or prioritize fundamental research.

Research should be the first step that constitutes any design or construction project. Founded on the premise that architects can contribute to addressing urgent global challenges, research within practice explores spatial consequences of cultural, political, and environmental issues. By conducting fundamental, rigorous research in practice, more evidence is generated that leads to more viable designs, help keep our work relevant, and create better spaces for occupants and communities.

Research is required to meet the unprecedented demands affecting our cities, society, and environment. Now more than ever, owners and developers of built environment projects are asking that design decisions are supported by research and evidence. In response, almost all large architectural firms engage in practice-relevant research to create new knowledge, remain competitive, and to reach quantitatively better outcomes. Seventy-five percent of firms who responded in the annual, AIA: Firm Survey Report, reported they are engaging in practice-relevant research. This is a steady increase from the past few years, 66% in 2017 and 72% in 2019 (AIA, 2022).

Architects and designers are also in a unique position to define issues where inexperience and uncertainty lie, critical issues that require fundamental research. In 2019, AIA stated that "the research available for study of architecture and buildings is disproportionate to its impact on societies and economies" and proposed an extensive research agenda while promoting increased investment in research and research literacy (AIA, 2019). For years, forward thinking industries have prioritized and invested in research and development. The top five technology companies, (Amazon, Apple Inc, etc.) spent \$76 billion on research and development in 2018, while the pharmaceutical industry dedicated \$165 billion. By 2030, the world's research and development spending are set to double to create more innovative products and services that connect with consumers (UNESCO, 2022). It is about time the architectural industry invested in research and development.

In this paper, three programs (*Research50*, *Global Research Fellowship*, and *Research & Innovation MicroGrants*) launched within a large global architecture and planning firm, that foster research, forward-thinking design solutions, and partnership are discussed. In addition, the preliminary results of the 2022 *Design ScoreCard* survey are explored. Through educating architectural teams about the research process, creating a global network of research advocates, and empowering teams to pursue various lines of inquiry on issues that impact people and our planet, research has been embedded in practice. The objectives of this paper are to 1) understand how a small team in a large firm can impact research culture, 2) explore the value of internal programs to advance research knowledge and implementation in project work, 3) recognize how collaboration with various market areas leads to innovation, and 4) identify tools and methods that teach individuals on how to conduct research.

1.1 Establishing a Dedicated Research Team

In January 2020, a large, 1000+ person, global architecture and planning firm responded to AIA's research agenda and need for investment in architectural research along with the demands of the industry by establishing a dedicated research team. This firm is a 75-year-old organization with strong roots based in urban planning, the practice today is positioned as a full-service design firm with a diverse portfolio of mixed-use developments, healthcare, workplace design, retail stores, and residential developments.

A clear investment was made within this firm to move the industry forward through research, data, and innovation. Prior to this, academic partners and individual team members were used to complete research studies on a project-by-project basis, but it was not completed consistently throughout the practice. While the architectural design process has evolved over the years to include modern technology and sustainable principles, the core aspects of pre-design, concept design, schematic design and design development have remained consistent since the 1950s. Any incremental change to this process needed to be approached carefully and intentionally.

From the inception, the goal of the Research team was to continue to build the knowledge and skills of the firmwide employees, utilize research to drive initiatives and solutions, and develop smart, dynamic content to lead clients and partners. As a small team at a large firm, the strategy to shift the design process to include fundamental research was focused on education, upskilling, and learning by doing, teaching architects and designers the basics of research and the values of integrating research in design so they could be empowered to incorporate it as part of their individual and team design process. The Research team's longer-term vision was to shift the design process so that every project the firm worked on included a fundamental research component, seamlessly embedding research into the entire practice.

2.0 UNDERSTANDING EMPLOYEE MINDSET & BASELINE STUDY

To achieve seamlessly embedding research into practice, the team first needed to understand the existing design process, the employee mindset around incorporating research and new ideas, and the current interest, knowledge, and skills of individual employees. In addition, a baseline understanding of where they should start, where they could make the largest impact, and how they should measure their incremental change needed to be established.

2.1 Employee Mindset

Understanding how architects learn best was an essential part of developing the programs and resources to move the strategy forward. Most architects are trained in their profession by experiential learning and situated learning, which is engaging in activities and using problem-solving skills in simulated situations (Khavari and Kaiser, 2022; Soliman, 2017). Architecture students learn more visually and actively than the average student (Mostafa & Mostafa, 2010), which informed the decision to use highly visual presentations versus text-heavy reading and create programs where architects and designers could learn by doing. Communities of Practice (CoP), a group of people who share common interests and goals, is also one-way architects and designers learn organically on the job. Research shows that global architects participate in 'local' communities of practice that rely on face-to-face interaction, talk, and 'buzz' to learn about new techniques, design ideas, and technologies (Faulconbridge, 2010). To align with the current needs of the employees while considering the "learning by doing" mindset of architects, the Research Team decided to conduct a baseline study across the firm.

2.2 Baseline Study

A baseline study to better understand the current individual and team working behaviors, and the knowledge and interest of four critical industry topics: wellbeing, resiliency, human-centric design, technology & mobility was performed in late 2020. The information gained from this study helped the Research Team build team strategies moving forward. The study was open to all levels and staff at the firm, including both design and administrative employees included a digital survey, a series of focus groups called Research Roundtables, and a pre/post survey administered to the employees that attended a Research Roundtable.

- A digital survey: survey was sent to all 1,200 employees late 2020. It was comprised of 14 close-ended, matrix questions and one open-ended question focused on generating potential research topics. The purpose of this survey was to better understand how ideas are generated, shared, and integrated into projects. In addition, it evaluated individual staff's knowledge level and interest in the four critical industry topics. This survey had 633 responses.
- Focus group discussions (Research Roundtables) were hosted in ten regions where the global architecture and planning firm had offices across the globe. These virtual discussions were coordinated to gain a better understanding of the current behaviors involving research, ideation, and team dynamics. Each 1.5-hour roundtable group was comprised of 12-27 employees across market areas and seniority levels.
- Pre- and post-roundtable surveys were also distributed. These digital surveys were used to confirm behaviors identified in the Research Roundtables and allowed for anonymous sharing.

3.0 STRATEGY

Findings from the baseline study revealed that while there was an interest in research, there were significant barriers around knowledge, time, skillsets, and understanding of how to incorporate research into the design process. Teams were much more likely to consider integrating research at the beginning of the project process, but after that it was considered “too difficult” to implement. Studying projects post-occupancy was a frequent topic of interest during the Research Roundtables, but participants shared concerns about the barriers of time, budget, and lack of client interest. Most participants agreed that post-project research was essential but noted that it just was not happening - due to timing and budget. They discussed the substantial desire and need to study the projects they were currently working on and learning from current and past projects. Many participants felt like tracking this data would lead to more efficient, seamless projects in the future and would create client loyalty if we were the keepers of client’s project data. Upon the study’s completion, the team produced a final report which was presented and distributed internally.

One key takeaway identified was the elevated level of confidence and comfort respondents felt when sharing ideas with each other and clients. They also found that when new ideas (such as a research study) were presented to clients, the percentage chance that it was incorporated into the final solution increased. This knowledge presented an opportunity to incorporate fundamental research as a “new idea” within teams and with clients.

To maximize impact on the design process and projects across the 1000+ person firm, engaging with more people and expanding the network of expertise needed to happen. This informed the decision to develop a local presence of research advocates (*Global Research Fellowship*) to influence both formally and informally through discussions and sharing. This was a long-term investment in the future of the organization, and the change needed to be carefully developed, orchestrated, and measured. Armed with knowledge focused on behaviors and interests from the conducting this baseline study, the Research Team developed several programs to educate (*Research50*) and upskill (*MicroGrants*) the firm – helping individuals understand why, when, and how to incorporate research. Mechanisms to foster, support, and communicate our research were also developed concurrently.

4.0 IMPLEMENTED PROGRAMS

Based on the overarching strategy of engaging, upskilling, and expanding the network of expertise, three firmwide programs were developed and launched to accelerate the change process for the 1000 + person organization. The programs included:

- *Research50*, a monthly educational webinar, created a space for ongoing education and case studies. These webinars are highly visual and interactive, and they always include an open space for discussion, questions, and comments.
- *The Global Research Fellowship program* expanded the research expertise around the firm and created a network where individuals could actively engage in their local studio, share, and promote research, and mentor others on a local level.
- *Research & Innovation MicroGrants* created a space for individuals to practice research in a guided environment. This program created an opportunity to try, fail, adapt, and learn safely.

In addition to these highlighted programs, resources were also developed where designers could learn more through educational materials and case studies. On the local intranet, a research portal was created to include trend reports, a research library, access to subscriptions and resources, research learning resources, research process guide, an academic partnership directory, and additional information about all the internal research programs. Additionally, in late 2022, a firmwide survey *Design ScoreCard*, was created to help guide teams in implementing sustainability, digital, and research strategies into their project design and measure implementation.

4.1 Research50

Research50, which launched in July 2020, is a monthly internal learning session curated to share fundamentals of the research process and lessons learned on practice-based research through case studies, and to educate the design teams on how to deploy research into project work. These learning sessions serve as a platform to share updates on other research initiatives and offer AIA CEU/HSW education credits for the attendees. By inviting internal employees and external presenters from academia, civic and community, *Research50* connects academia and industry by providing opportunities for future partnership. During 2021 and 2022, eighteen sessions averaged 120 attendees per month and provided more than 250 AIA CEU credits. The learning sessions are recorded and added to the internal research library to serve as a resource for future reference.

After two years, based upon employee feedback and participation, *Research50* plays a significant role in identifying the values of integrating research in practice. These learning sessions include introductory sessions focusing on the fundamentals of developing a research question, methodology and analysis. Additionally, presenters have shared case studies that cover topics on human-centered research, practice-based research, academic partnerships, research and innovation, inclusion, diversity and equity in research, and industry trends.

Furthermore, to better align the topics with projects' needs, *Research50* attendees during the March 2022 session were asked to choose topics they were interested in, to learn more about at a future session. Out of 117 attendees, 71 responded to identify specific themes: 1) Internal Research Case Studies (55%), 2) Design Thinking Approach (50%), 3) External Research Case Studies (50%), 4) Prototyping and Testing (46%), and 5) Equity, Inclusion and Diversity (31%). These results shaped the remaining 2022 *Research50* curriculum (Figure 1).

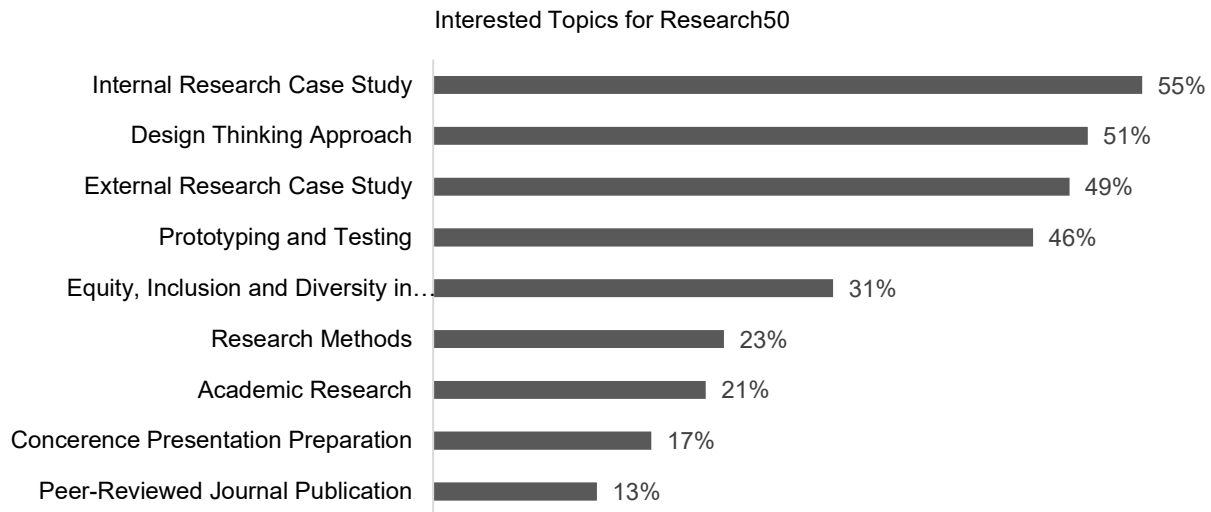

Figure 2: Survey results: topics of interest for Research50. Source (Microsoft Teams, 2022)

4.2 Global Research Fellowship

The *Global Research Fellowship* program started in 2020 with the primary goal to expand the research expertise and support and to inspire and guide research efforts in local communities. Since 2020, seventeen Research Fellows have been selected to serve as the research advocates for their respective office, markets, and region. The *Research Fellowship* program acts as a diverse brain trust which supports application of project research, but also functions as a crucial feedback loop to surface topics most critical to project work and clients' needs, and to help shape the research agenda for the firm. For the past two years, the Research Fellows served as a cohort and championed several initiatives to further strengthen the firm's commitment to research by developing additional resources. Resources have included developing a collaborative framework to help project teams form their research questions and methodologies, creating a podcast to promote research conducted in the firm and assembling an Academic Partnership Directory for employees interested in partnering with academic institutions.

In 2022, interviews were conducted with individuals in the Research Fellow program to obtain feedback on the program. Additionally, participants were asked why they were interested in serving as a Research Fellow for the firm. Results indicated that individuals enjoyed learning the basics of conducting research and developing educational content. Common themes revealed that individuals participating like to be in the intersection of research and design, contribute to projects with their research knowledge, and build a culture to engage their local studios with research opportunities. Several challenges were also discussed and included: limitations of encouraging people to engage in research in addition to their daily tasks, the cost associated with research, the timeline of the project, and finding time to meet internally with their cohort team – given different time zones across the globe. This feedback informed the current *Global Research Fellowship* participants' conjecture.

The current 2022-2023 Research Fellow cohort has had four planning sessions to discuss current challenges in their different regions and markets to frame their cohort's initiative. Collectively, the Research Fellows will focus on the benefits and roadblocks of deploying post-occupancy evaluation (POE) in projects both from project teams and clients' perspectives in 2023. The success of the *Global Research Fellowship* program led to establishing other fellowship programs within the firm including Sustainability and Design Fellows. Leaders of the three Fellow groups (Research, Sustainability and Design) meet monthly to discuss synergies between the teams with the shared goal of building a powerful culture that implements research and sustainability in all designs across the firm.

4.3 Research and Innovation Microgrants

The *Research & Innovation MicroGrants* program supports small, focused research and innovation projects proposed by current employees through investing internal funding. The program allows individuals to explore independently while working within a supportive environment that fosters interaction, dialogue, and a sense of common purpose. Rather than funding a specific solution, this program offers flexible funding that allows individuals to address needs that they identify, feel passionate about, and as a result, expose different opportunities for innovation. For the past two years, 85 ideas have been submitted for consideration with 23 projects funded. The projects funded are required to thoroughly document their research findings and develop conclusions or suggestions for application to professional practice. The outcome of which yield viable design solutions that can be implemented on local, regional, and global scales.

The diversity of projects awarded range in ideas, whether it is exploring the intertwinement of disciplines to design a livable city street, discovering what elements to consider maximizing social value in the built environment, or creating design solutions for medically underserved, and all grow our profession's intelligence. The employees participating in the program are guided by our Research Team, firm leaders within their area of interest, and a select group of academic professors known to be design, innovation, and architectural thought leaders. Both primary research studies that use qualitative, quantitative, experimental, survey, and multi-methodological designs to test hypotheses about the prevalence and impact of design efforts and interventions to facilitate it along with secondary research in the form of critical brief summaries on the state of research and literature as it pertains to an area impacting people, planet, or positive design are performed. At the conclusion of their projects, a peer-reviewed publication dedicated to documenting and presenting their practice-related research is published internally and shared externally.

The Research & Innovation MicroGrant program has propelled this firm to design smarter built environments. In 2021, 88% of the participants in the MicroGrant program noted that by participating in the program, they obtained new skills to be more effective at their job, while 100% of participants stated that they were more confident in conducting research. Success is also garnered through new client connectivity, local and regional media coverage, social media impressions, several national conference presentations attained, and through prestige awards including Fast Company's World Changing Ideas award. The program will continue to be a space to ideate, fail safely, implement findings into projects, and most importantly show promise for lasting impact outside of the firm's walls.

4.4 Design Scorecard

A firmwide survey, titled Design ScoreCard, tracks project work to hold teams more accountable and celebrates the firm's progress, launched in September 2022. The survey is used to foster deeper conversations with project teams and clients; it is an opportunity to discuss different project goals and ways to achieve them. It is also used at the end of the project as a tool for reflection on the project process to determine what worked well and what was less successful.

The survey is distributed at three project milestones: vision and concept design, schematic design, and design development. An alert email is sent to project managers at the following labor completion milestones: project creation, 25%, 50%, and 100%, but it is up to project teams to complete at appropriate milestones. The purpose of the multiple submissions is to better understand how teams incorporate goals and strategies at the beginning of their projects, which ideas and goals are included in the design process, and which strategies were implemented in the final stage of construction documents provided to the client.

The survey has four sections with 15 close-ended questions. Not including project information, each section is equally weighted at 33.3 points, where a score of 100 points equals 100%. Scores for each section are displayed at the end of the survey, as well as the current average scores for all projects submitted. This is helpful for teams to understand where their projects stand compared to other firm projects and what areas could be improved to increase their project score. Two questions in the survey address research integration in the design process by asking team members about (1) if they have engaged the research team on their project (as one of the firm's advisory services), and (2) if and how they utilized research to move design forward, create innovation, or advance people or planet strategies. The survey went live at the beginning of September 2022 with the expectation that it will stay open with running results posted on the firm's internal intranet.

The pulled results of the survey on November 29, 2022, have 149 responses with 74% of project teams indicating that they incorporated research into their project in some capacity including conducting design research, market research, user experience research, collaborating with the research team, and collaborating with universities (Figure 2).

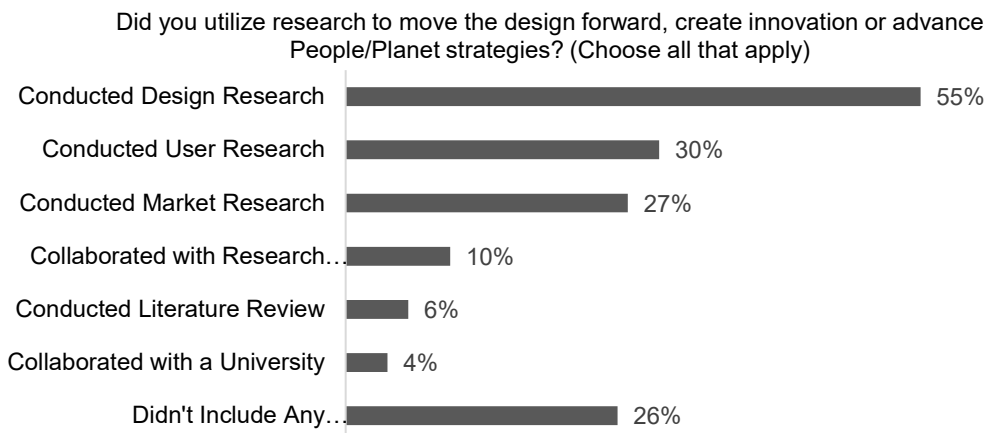

Figure 3: The Design ScoreCard survey 11/29/22 results - Did you utilize research to move the design forward, create innovation or advance People/Planet strategies? Source (Qualtrics, 2022)

DISCUSSION AND CONCLUSION

A variety of programs to highlight the value of research within architecture while introducing tactics on how to independently conduct low-fidelity research is necessary in a large practice. The results of the *Design ScoreCard* show that three quarters of design teams are using research in some capacity throughout the design process whereas in the baseline study conducted in 2020, only 10% of individuals indicated that they conduct research in their projects. While the connection between these results is not directly correlated, we can appreciate the uptick of integrating research and offers merits for discussion. The respondents who mentioned using research in their practice are a combination of individuals collaborating with the Research team (10%) and teams who conduct research on their own (64%). In the absence of valid analytics, we can only suggest this number is empowered by the past two years of learning engagements and programs initiated.

While the data shows that these programs have led to a significant increase in research engagement at the firm, the value exceeds beyond this statistic. Through these programs, the firm leadership has noticed higher engagement, loyalty, connections across geographies, job growth, and personal satisfaction from the individuals who have participated. As empowered employees (Black, 2021) determine what they value most, who they want to work for, and where they want work, programs, and initiatives such as *Research50*, *Research Fellowship*, and *MicroGrants* have the potential to be a critical part of the decision-making process by aligning with employee's interests and values.

Moving forward, the Research team has more closely aligned with the digital, sustainability, and experience design teams. Together, the focus is on shifting the typical design process and transforming the architecture firm of the past to one that is more human-centric, data-driven, evidence-based, and sustainable. Some of this transformation occurs by directly engaging experts on projects across market areas, but the bulk of the transformation is happening through peer-to-peer learning and programs where employees are empowered to expand their skillset and take on new challenges. As these programs grow and evolve, more employees will be engaged, furthering their knowledge base, and increasing their comfort level by incorporating research into practice.

REFERENCES

- Black, V. 2021. *The empowered employee experience*. Benefits Pro. <https://www.benefitspro.com/2021/04/19/the-empowered-employee-experience/>
- Faulconbridge, J. R. 2010. *Global architects: learning and innovation through communities and constellations of practice*. Environment and Planning A, 42(12), 2842-2858.
- Khavari, F., Kaiser, L. E. 2022. *Impact of extended reality on architectural education and the design process*, Automation in Construction, Vol. 141, 104393, ISSN 0926-5805, <https://doi.org/10.1016/j.autcon.2022.104393>.
- Mostafa, M., Mostafa, H. 2010. *How do architects think? Learning styles and architectural education*. International Journal of Architectural Research Archnet-IJAR 4(2): 310-317.
- Motealleh, P., Parsaee, M., Parva, M. 2016. *Interactive architectural approach (interactive architecture): An effective and adaptive process for architectural design*, HBRC Journal, Vol. 12, Issue 3, 327-336, ISSN 1687-4048, <https://doi.org/10.1016/j.hbrj.2015.01.001>.
- Soliman, A. 2017. *Appropriate teaching and learning strategies for the architectural design process in pedagogic design studios*, Frontiers of Architectural Research, Vol 6, Issue 2, 204-217, ISSN 2095-2635, <https://doi.org/10.1016/j.foar.2017.03.002>.
- The American Institute of Architecture (AIA). 2019. *AIA Architectural Research Agenda 2019 & 2020*, The American Institute of Architecture (AIA), https://content.aia.org/sites/default/files/2019-05/AIA_Research_Agenda_2019-2020.pdf, Accessed: November 22, 2022
- The American Institute of Architecture (AIA). 2022. *The Business of Architecture 2022*, The American Institute of Architecture (AIA), <https://www.aia.org/resources/6151-firm-survey-report>, Accessed: November 22, 2022
- UNESCO Institute for Statistics. 2022. *How much does your country invest in R&D?*, <https://uis.unesco.org/apps/visualisations/research-and-development-spending/> Accessed: November 29, 2022
- Wolfe, R., National Center for Science and Engineering Statistics (NCSES). 2022, *Businesses Spent Over a Half Trillion Dollars for R&D Performance in the United States During 2020, a 9.1% Increase Over 2019*, NSF 22-343. Alexandria, VA, National Science Foundation, <https://ncses.nsf.gov/pubs/nsf22343>

Evaluation of a Framework for the Integration of Airflow Simulations into the Early Stages of Architectural Design using Delphi Method

Soo Jeong Jo^{1,2}, James Jones²

¹Louisiana State University, Baton Rouge, LA

²Virginia Tech, Blacksburg, VA

ABSTRACT: airflow analysis has been a critical part of architectural design since airflow is closely related to the physical and mental health of the building occupants. Specifically, after the coronavirus pandemic, the demand for more accurate airflow analyses from the early stages of architectural design has been increasing. To meet the demand, airflow simulations, including Computational Fluid Dynamics (CFD), may be utilized in architectural design. However, the current users of airflow simulations tend to be limited to researchers and engineers in the building industry, focusing on a single aspect of architecture, such as wind load analysis, rather than a holistic design process. For expanding the simulation users to architectural designers, an implementation framework was developed with a holistic approach seeking the application of airflow simulations throughout the whole architectural design process. This framework consists of the recommended tools for airflow simulations in each phase of architectural design, the knowledge set to effectively use the tools, and the interactions between design thinking and the information from airflow simulations. The present study evaluates this framework by using a Delphi method. Delphi is a structured group communication method for soliciting expert opinions about complex problems or novel ideas using a series of questionnaires and controlled feedback. This method is useful for the initial stages of prediction, organization, prioritization, and making strategies or frameworks. A group of experts in architectural design and building science was selected for the Delphi study, and an agreed view and shared interpretation of the developed framework was established. The revised framework based on this study can be applied to various building projects while supporting architectural designers to utilize airflow simulations in their design processes. Providing such a framework will contribute to the dissemination of various airflow simulation methods in the community of architectural designers.

KEYWORDS: Airflow, CFD, Building, Delphi, Simulation

INTRODUCTION

Airflow analysis has been a critical part of architectural design since airflow is closely related to building form and the quality of built environments. Specifically, after the coronavirus pandemic and the trends of complex building design, a demand for more accurate airflow analyses from the early stages of architectural design has been increasing (Jo, Jones, and Grant 2018). Responding to this, various airflow simulation tools and methods, including Computational Fluid Dynamics (CFD), have been introduced to the building industry. However, the usage of the tools and methods tends to be limited to a single aspect of buildings rather than holistic architectural design processes. To expand the usage and actively integrate airflow simulations into the architectural design processes, the authors of this paper developed an implementation framework for the integration of airflow simulations into the early stages of architectural design (Jo and Jones 2021). The framework, which may serve as a recipe for simulations, consists of the recommended airflow simulation tools based on the needs in each phase of architectural design and the knowledge set to effectively use the tools. The present study aims to evaluate and improve this framework by using a Delphi method that is known as an effective way of collecting feedback and consensus from experts. Experienced architectural designers, educators, and researchers were invited to the present study, and the agreed view and shared interpretation from the study were utilized for improving the proposed framework.

1.0 BACKGROUND

Delphi is a “structured group communication method” for collecting experts’ opinions about a specific problem or idea utilizing a series of questionnaires requesting their feedback (Day and Bobeva 2005). The Delphi method allows experts to achieve an agreement on certain topics. It was developed in the 1950s by Dalkey and Helmer (Hsu and Sandford 2007). After the first report in 1964, the Delphi method has been recognized in dealing with complex problems and continued being developed (Day and Bobeva 2005). A typical Delphi study is composed of two or three rounds of inquiry, but this range may be expanded to one to ten rounds (Lang 1995; Erffmeyer, Erffmeyer, and Lane 1986; Day and Bobeva 2005; Meijering et al. 2015). For example, Meijering et al. (2015) performed a one-round Delphi study for determining the priorities in landscape architecture research. Schweiger et al. (2019) conducted a two-round Delphi study on co-simulation to collect empirical data from researchers. The Delphi method is useful for the initial stages of

prediction, organization, prioritization, and making strategies or frameworks, thus, it has been applied to various studies in building research specifically concerned with Building Information Modeling (BIM), sustainable design, building renovation strategies, residential buildings, and frameworks for decision-making or assessments.

Banihashemi, Ding, and Wang (2016) focused on the role of BIM in sustainable building design. They applied the Delphi method to their study for identifying the variables compatible with BIM for optimizing the energy performance of buildings. The identified variables could be applied to BIM modeling processes. Olawumi and Chan (2018) also investigated the benefits of BIM on sustainable construction using the Delphi approach. They recruited 14 participants in academia and the industry for conducting a two-round Delphi survey to establish the ranking of the identified factors. The collected data were analyzed with Kendall's concordance test, which determines the level of agreement among the participants. In a similar vein, Wong and Kuan (2014) employed the Delphi method for implementing the BIM-BEAM Plus assessment framework, developed for sustainable building certification in Hong Kong, into architectural projects for BIM-based analyses on the sustainability of residential buildings.

While the abovementioned studies concentrated on the interactions between BIM and sustainability, the following studies focused on the validation of frameworks for decision-making or assessments. Lee, Kim, Lee, and Han (2012) developed a slab-form selection methodology in residential projects based on the Delphi techniques. 27 professionals are invited to the two rounds of surveys and reached a consensus on the essential items for the methodology, which could finalize the selection criteria. Alyami, Rezgui, and Kwan (2013) also developed a tool for the assessment of sustainability in Saudi Arabian building designs using a Delphi approach. A panel of experts brainstormed the assessment criteria suitable for the Saudi Arabian context, and the criteria were refined with analytical stages and communications. The level of consensus among the experts was quantitatively measured with the medians and interquartile ranges (IQRs).

Similarly, Jensen and Maslesa (2015) validated RENO-EVALUE, a decision-making tool for value-based building renovation projects, using the Delphi method. They developed the tool based on four renovation cases in Denmark focusing on the different stances of the project stakeholders. The tool allows building professionals or users to compare proposals, follow in-progress projects, and evaluate the results. Likewise, Kamari, Corrao, and Kirkegaard (2017) reinforced a sustainable decision-making framework for building renovation projects, named RE-VALUE, with a Delphi study. The invited experts from academia, government, and industry reviewed the developed indicators and concluded the final criteria for the framework that holistically examines the chain of effects in building renovation projects.

2.0 METHODOLOGY

The process of the present study consisted of the following steps: research design, sampling, first-round questionnaire development and distribution, first-round responses analysis, second-round questionnaire development and distribution, second-round responses analysis, results, and discussion.

2.1 Research design

The present study was designed based on the literature review and the following research questions:

- Is the proposed framework effective for developing architectural design and making design decisions?
- Is the proposed framework effective for teaching architectural design and enhancing students' understanding of environmental issues in architecture?
- How would the framework be improved?

After identifying the research questions, the strategies for the research were developed. Firstly, the two-round Delphi method was selected since it is the most suitable when a clear reference is available for establishing the survey instrument and if the study goal is to "take the temperature of opinion on a topic" (Iqbal and Pison-Young 2009). In this case, similar studies were available that can be considered "clear references" (Hafiz 2016; Jensen and Maslesa 2015; Kamari, Corrao, and Kirkegaard 2017), also, the study goal was to obtain the general opinions of the designers and researchers on the proposed framework.

Secondly, the present study employed both qualitative and quantitative approaches for conducting the surveys. The first-round survey with a qualitative approach consisted of open-ended questions for supporting the participants to brainstorm. The participants' responses to the first-round questionnaire were coded and analyzed to establish the basis of the second-round questionnaire. The second-round survey with a quantitative approach was composed of multiple-choice questions in which the participants can rate and rank the tools and strategies. The responses to this questionnaire were statistically analyzed.

The Delphi studies were conducted online because of the pandemic issues during the time of the study. In addition, the online Delphi method is more efficient than the traditional in-person Delphi method which has limitations of time and place. The efficiency allows the online method to have a broader pool for recruiting research participants, which has attracted more researchers to employ the online method recently (Kaufman et al. 2018; Blackwood et al. 2015; Oostendorp et al. 2015). The present study provided an online presentation on the proposed framework to the participants and communicated with them through the first and second online surveys.

2.2 Sampling

For recruiting the participants, a purposeful sampling approach was adopted as the participants had to meet the requirements that ensure more insightful and knowledgeable feedback. The requirements included the following criteria:

- experienced in architectural design
- have the capability to effectively communicate their opinions (Adler and Ziglio 1996)
- have time and intention to participate in the study

Since the proposed framework aims to introduce airflow simulation tools and strategies to architectural designers, the participants were required to have experiences in architectural design, while they may or may not have experience in airflow simulations. This is considered a homogeneous sample specialized in architectural design as the goal of the study was to receive feedback from potential users of the framework. However, the participants had different backgrounds within the boundary of architectural design, such as a professional architect, a building science researcher with professional experience in architectural design, and an architecture faculty. This sampling strategy maximizes the variance of the group within the criteria and enables the study to examine the topic from multiple perspectives. Based on these principles, various professionals, educators, and researchers in architectural design were invited to the study. The invitees digitally signed the consent when they agreed to participate in the study, and nine participants were recruited after this recruiting process. The educational and professional backgrounds of the participants could be categorized into the following three groups: architectural designers (professional designers and licensed architects), architectural researchers (current or former research experience in building science and urban planning), and architectural educators (current or former teaching experience in architecture programs). Table 1 specifies the diverse backgrounds of the study participants.

Table 1: Delphi study – background of the participants

Participants/Background	<i>Architectural Design</i>	<i>Architectural Research</i>	<i>Architectural Education</i>
<i>A</i>	Yes	Yes	No
<i>B</i>	Yes	Yes (CFD)	Yes
<i>C</i>	Yes	No	No
<i>D</i>	Yes	Yes	No
<i>E</i>	Yes	No	No
<i>F</i>	Yes	Yes	No
<i>G</i>	Yes	Yes (CFD)	Yes
<i>H</i>	Yes	No	No
<i>I</i>	Yes	Yes	Yes
Number of participants	9	6	3

2.3 Data collection

The goal of the first-round questionnaire development and survey was to help the participants brainstorm and obtain their opinions on the proposed framework including various airflow simulation methods and strategies to utilize the simulations in the early stages of architectural design. The first-round survey was composed of the following open-ended questions:

- Would the proposed simulation approach and design process framework be helpful for architectural designers to generate and evaluate design ideas? Why or why not?
- Would the utilization of Computational Fluid Dynamics (CFD) software support the design thinking process of architectural designers? Why or why not?
- Would you be interested in using the tools introduced in the webinar?
- What are your suggestions regarding the presented framework or tools to better support design activities during the formative process of architectural design?
- Please provide any additional comments or thoughts.

A questionnaire composed of the questions above was used as an instrument for collecting the data and preparing the second-round questions. The questionnaire was distributed to the participants after an online presentation about the framework. The participants responded to the questionnaire through an online survey tool, Google Forms. The experts' responses to the open-ended questions may provide insight that has not been explored by the researcher and reveal an additional area of the research application.

The second-round questions were developed based on the literature and the first-round survey responses (Hsu and Sandford 2007; Hasson, Keeney, and McKenna 2000). Different from the first round, the second-round survey was a set of rating-scale questions, also known as a "Likert scale" which ranges from "1 = strongly disagree" to "5 = strongly agree" showing the level of agreement. A Likert scale is one of the frequently used methods in qualitative studies

(Joshi et al. 2015). For example, Warmbrod (2014) reported that “Likert-scale methodology was used in 62% of the articles reporting quantitative research” (30).

In the second round of the study, the participant’s level of agreement on the following statements was inquired:

- The proposed framework and tools were effective in testing the airflow and natural ventilation in and around buildings.
- The proposed framework and tools will contribute to architectural design in general to be more environment-responsive.
- Overall, I was satisfied with the introduced tools and framework in the webinar.
- I am interested in using the introduced tools and framework in the webinar.
- The proposed framework and tools will make positive impacts on the practice of architecture.
- The proposed framework and tools will be able to support the design thinking processes of architectural designers.

After receiving and reviewing the summary of the first-round study, the participants were invited to the second-round study consisting of six questions shown above investigating the participants’ final thoughts and the level of their consensus.

2.4 Data analysis

After collecting the first-round responses of the participants, the collected data were segmented and excerpted. Each excerpt was then analyzed and coded for conveying both the explicit and implicit perspectives of the participants. The codes were constantly compared with each other by observing differences and similarities to identify their distinctive qualities. To develop categories, the codes were then clustered based on their shared characteristics. For comparing the responses to a specific question, constant comparison techniques were used for the coding process. Constant comparison techniques combine “inductive category coding with a simultaneous comparison” (Goetz and LeCompte 1981, 58). Thus, this method allows a “continuous refinement throughout the data collection and analysis process” (Dye et al. 2000, 2). Figure 1 shows the process of coding and the constant comparison approach for the present study.

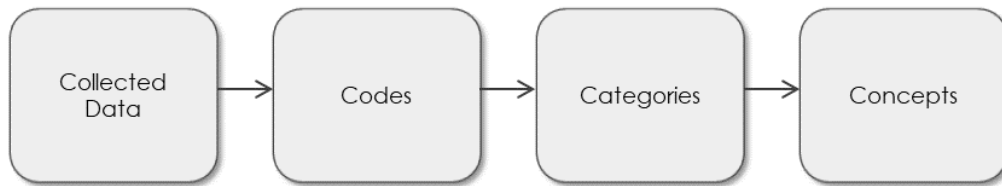

Figure 1: The sequence of coding – constant comparison approach. Source: (Author 2021, based on Nekeisha Randall, 2019)

To measure the consensus among the participants, the collected data were analyzed using descriptive statistics, which investigate the central tendency (mean, median, and mode) and the variability (standard deviation and distribution) of the data. This method is often employed for showing the major trend of broad information and summarizing collected data. For the present study, median, mode, and bar chart were analyzed. As the mean and the standard deviation are not suitable for Likert-scale data (Jamieson 2004), those indicators were excluded from the data analysis.

3.0 RESULTS

3.1

The first-round questionnaire was a set of open-ended questions inquiring about the study participants’ qualitative evaluations and suggestions about the proposed framework. Overall, the participants were interested in employing the framework in their design processes and believed that the framework would support the thinking processes in architectural design. The summary of the responses is shown in Table 2.

Table 2: Summary of the first-round Delphi results

<i>Questions</i>	<i>Responses</i>
1. The framework would be helpful for architectural designers to generate and evaluate design ideas.	Yes, because it: 1) provides scientific evidence (confidence) about the design decision. 2) explains the steps for the application of the simulations, tools, and the required knowledge. 3) is useful as an educational tool. 4) helps designers understand airflow, which is a complex phenomenon, and environmental context. 5) improves indoor environmental quality.

2. The utilization of CFD software would support the thinking process of architectural designers.	<p>Yes, because it:</p> <ol style="list-style-type: none"> 1) makes the design exploratory - aware of the alternatives and pros and cons (evaluation) for each decision, tests airflow at different levels of design. 2) represents and visualizes questions about natural ventilation. 3) provides a balanced understanding of building performance that includes airflow (currently building energy efficiency is more focused). 4) is more efficient compared to wind tunnel tests or tracer gas methods. 5) takes into consideration the environmental factors of the site with quantitative measures.
3. Interested in using the tools introduced in the webinar.	Yes.
4. Suggestions to better support design activities during the formative process of architectural design.	<ol style="list-style-type: none"> 1) Include what the users look for. 2) Categorize the proposed knowledge sets into two: one for conducting simulations, another for the interpretation. 3) How would the surrounding condition affect the results? 4) Consider how the wind pressures are reacted with the building design. 5) Information on the simulation time for modeling and running the calculation. 6) Compatibility with multiple design software beyond Revit. 7) A similar approach that helps maximize sunlight in the early stages of design.
5. Additional comments.	<ol style="list-style-type: none"> 1) Highlight the most appropriate tool for each design phase. 2) Looks like a systematic design approach. 3) Video tutorials of the model generation processes. 4) Reaching out to architectural firms that may be interested in applying this study.

Based on the responses from the first-round Delphi study, the proposed framework was improved as shown in Figure 2. The green area indicates the updated contents. The primary revision was adding two scenarios, in an open field and an urban area, and showing the simulation workflow for each case. The revised framework and the summary of the first-round responses were also shared with the participants for their review before proceeding to the second-round Delphi study. Figure 3 illustrates the second-round study results and the level of consensus in each survey question. Although there were some disagreements between "agree" and "strongly agree," most of the participants had a consensus on the positive impacts of the proposed framework in architectural design.

RESEARCH AND DESIGN

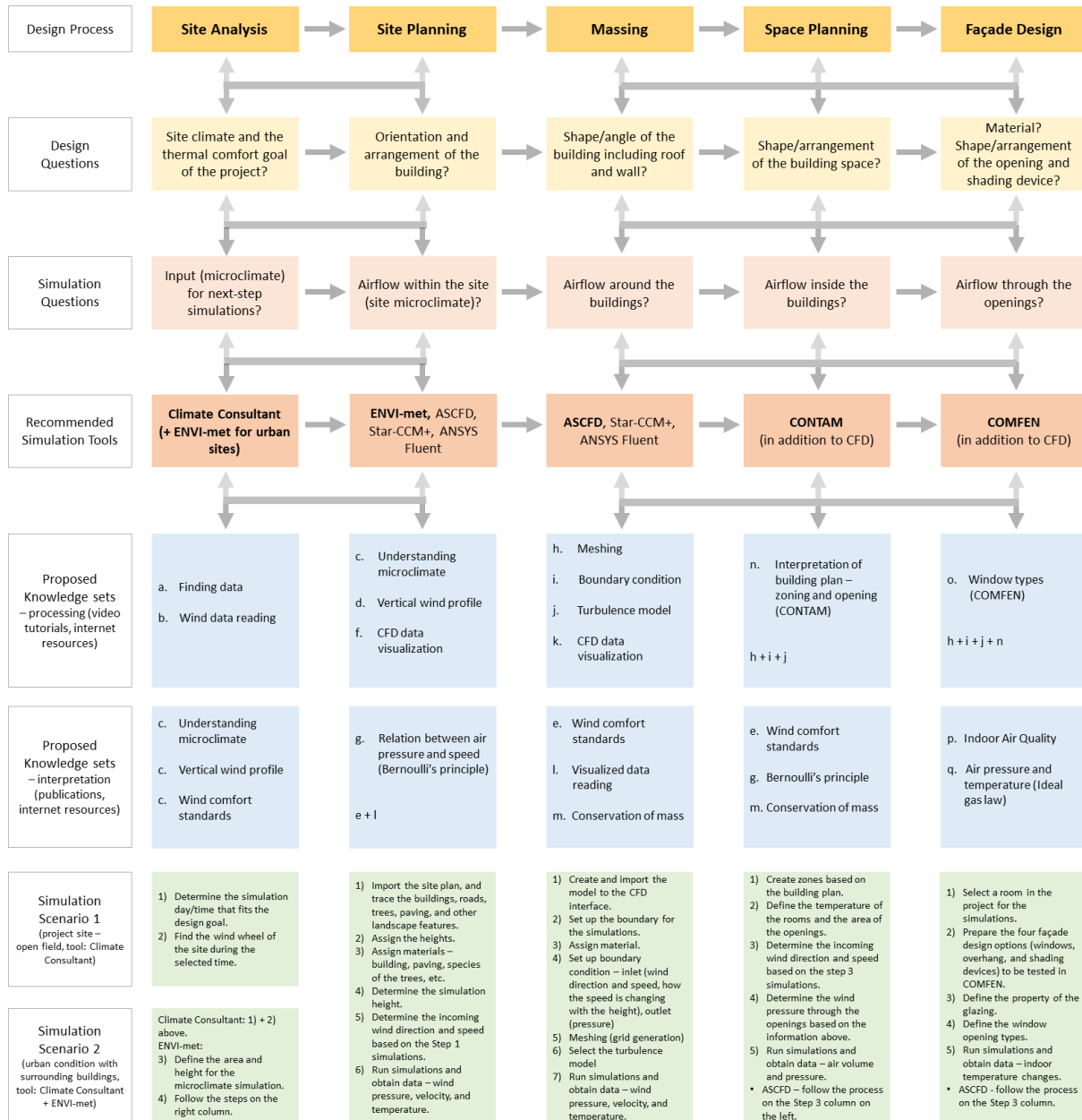

Figure 2: Proposed framework for airflow simulation-assisted design (green – updates based on the Delphi study). Source: (Author 2021)

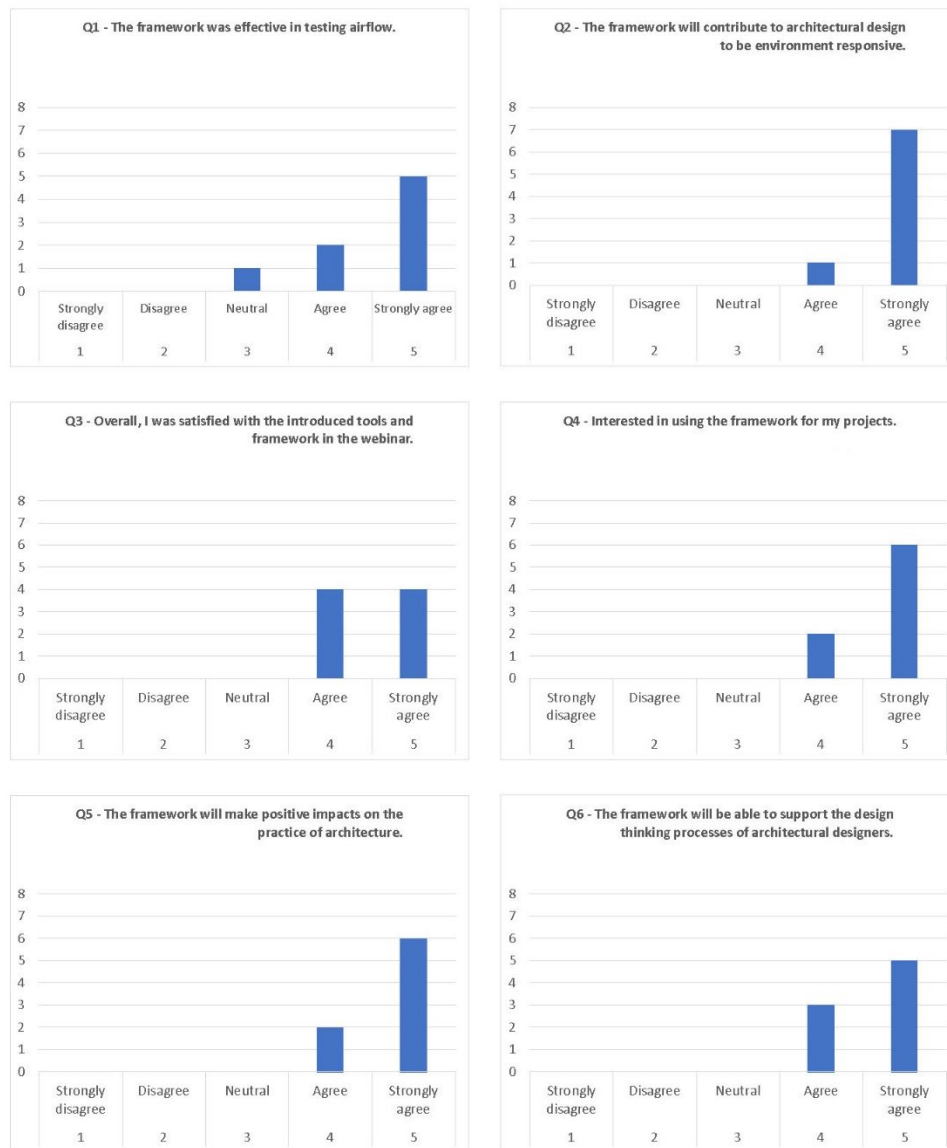

Figure 3: Second-round Delphi study results. Source: (Author 2021)

CONCLUSION

A Delphi study was conducted to evaluate and improve the proposed framework for utilizing airflow simulation tools in the early stages of architectural design. The Delphi study consisted of two rounds: qualitative and open-ended questions for the first round, and quantitative rating questions for the second round. For the study, a group of experts in architectural design, with or without backgrounds in building simulation research, who may be potential users of the framework, were purposefully selected as the study participants. Nine participants were recruited for the first-round study, and eight participants continued their participation to the second round. In the first-round study, the participants shared their opinions and suggestions on the proposed framework via an asynchronous discussion platform. Based on the discussions, the proposed framework was finally revised and shared with the participants before the second-round study. Overall, the participants evaluated that the proposed framework would be beneficial, specifically for encouraging architectural design to be more environment-responsive. The revised framework can be applied to various building projects while supporting architectural designers in utilizing airflow simulations in their design processes. Providing such a framework will contribute to the dissemination of airflow simulation tools and methods in the community of architectural designers.

ACKNOWLEDGEMENTS

This study was originally presented at 2021 ASHRAE 2021 Building Performance Analysis Conference. The contribution of the conference organizers and committees is hereby gratefully acknowledged. We also thank Neel Vyas,

Dr. Seydreza Fateminasab, Dr. Alsaleh Sugati, Dr. Amos Kalua, Dr. Danny Kim, Josephine Arbaugh, Joanna Brindise, Dr. Lisa Lim, Arzu Sevinc, and Henry Bein, for their supports.

REFERENCES

- Adler, Michael, and Erio Ziglio. 1996. *Gazing into the oracle: The Delphi method and its application to social policy and public health*. Jessica Kingsley Publishers.
- Alyami, Saleh H, Yacine Rezgui, and Alan Kwan. 2013. "Developing sustainable building assessment scheme for Saudi Arabia: Delphi consultation approach." *Renewable and Sustainable Energy Reviews* 27: 43-54.
- Banihashemi, S, G Ding, and J Wang. 2016. "Identification of BIM-compatible variables for energy optimization of buildings—a Delphi study." *40th AUBEA*: 281-291.
- Blackwood, Bronagh, Suzanne Ringrow, Mike Clarke, John Marshall, Louise Rose, Paula Williamson, and Danny McAuley. 2015. "Core Outcomes in Ventilation Trials (COVenT): protocol for a core outcome set using a Delphi survey with a nested randomised trial and observational cohort study." *Trials* 16 (1): 1-7.
- Day, Jacqueline, and Milena Bobeva. 2005. "A generic toolkit for the successful management of Delphi studies." *The Electronic Journal of Business Research Methodology* 3 (2): 103-116.
- Dye, Jane F, Irene M Schatz, Brian A Rosenberg, and Susanne T Coleman. 2000. "Constant comparison method: A kaleidoscope of data." *The qualitative report* 4 (1/2): 1-9.
- Erfmeyer, Robert C, Elizabeth S Erfmeyer, and Irving M Lane. 1986. "The Delphi technique: An empirical evaluation of the optimal number of rounds." *Group & organization studies* 11 (1-2): 120-128.
- Goetz, Judith Preissle, and Margaret D LeCompte. 1981. "Ethnographic research and the problem of data reduction 1." *Anthropology & Education Quarterly* 12 (1): 51-70.
- Hafiz, Dalia O. 2016. "Improving Design Decision-Making through a Re-Representation Tool for Visual Comfort Consideration in Dynamic Daylit Spaces." Virginia Tech.
- Hasson, Felicity, Sinead Keeney, and Hugh %J Journal of advanced nursing McKenna. 2000. "Research guidelines for the Delphi survey technique." 32 (4): 1008-1015.
- Hsu, Chia-Chien, and Brian A Sandford. 2007. "The Delphi technique: making sense of consensus." *Practical Assessment, Research, and Evaluation* 12 (1): 10.
- Iqbal, Susanne, and Laura Pison-Young. 2009. "Methods-The Delphi method--A guide from Susanne Iqbal and Laura Pison-Young." *Psychologist* 22 (7): 598.
- Jamieson, Susan. 2004. "Likert scales: How to (ab) use them?" *Medical education* 38 (12): 1217-1218.
- Jensen, Per Anker, and Esmir Maslesa. 2015. "Value based building renovation—A tool for decision-making and evaluation." *Building and Environment* 92: 1-9.
- Jo, Soo Jeong, and James Jones. 2021. "A Framework for the Integration of CFD into the Early Stages of Architectural Design." ARCC (Architectural Research Centers Consortium) 2021 International Conference, Tucson.
- Jo, Soo Jeong, James Jones, and Elizabeth Grant. 2018. "Trends in the application of CFD for architectural design." ARCC (Architectural Research Centers Consortium), Philadelphia.
- Joshi, Ankur, Saket Kale, Satish Chandel, and D Kumar Pal. 2015. "Likert scale: Explored and explained." *British Journal of Applied Science & Technology* 7 (4): 396.
- Kamari, Aliakbar, Rossella Corrao, and Poul Henning Kirkegaard. 2017. "Sustainability focused decision-making in building renovation." *International Journal of Sustainable Built Environment* 6 (2): 330-350.
- Kaufman, Jessica, Rebecca Ryan, Simon Lewin, Xavier Bosch-Capblanch, Claire Glenton, Julie Cliff, Angela Oyo-Ita, Artur Manuel Muloliwa, Afiong Oku, and Heather Ames. 2018. "Identification of preliminary core outcome domains for communication about childhood vaccination: An online Delphi survey." *Vaccine* 36 (44): 6520-6528.
- Lang, Trudi. 1995. "An overview of four futures methodologies." *Manoa Journal of Fried and Half-Fried Ideas* 7: 1-43.
- Lee, Kyung-Suk, Hyun-Mi Kim, Tae-Hee Lee, and Seungwoo Han. 2012. "A Selection Methodology of Slab-form Construction Methods in Residential Buildings based on the Simulation and Delphi Techniques." *Journal of Asian Architecture and Building Engineering* 11 (1): 39-46.
- Meijering, Jurian Vincent, Hilde Tobi, Adri van den Brink, Fiona Morris, and Diedrich Bruns. 2015. "Exploring research priorities in landscape architecture: An international Delphi study." *Landscape and Urban Planning* 137: 85-94.
- Olawumi, Timothy O, and Daniel WM Chan. 2018. "Beneficial factors of integrating building information modelling (BIM) and sustainability practices in construction projects." Hong Kong International Conference on Engineering and Applied Science.
- Oostendorp, Linda JM, Marie-Anne Durand, Amy Lloyd, and Glyn Elwyn. 2015. "Measuring organisational readiness for patient engagement (MORE): an international online Delphi consensus study." *BMC health services research* 15 (1): 61.
- Schweiger, Gerald, Cláudio Gomes, Georg Engel, Irene Hafner, J Schoeggel, Alfred Posch, and T Nouidui. 2019. "An empirical survey on co-simulation: Promising standards, challenges and research needs." *Simulation modelling practice and theory* 95: 148-163.
- Warmbrod, J Robert. 2014. "Reporting and Interpreting Scores Derived from Likert-Type Scales." *Journal of Agricultural Education* 55 (5): 30-47.
- Wong, Johnny Kwok-Wai, and Ka-Lin Kuan. 2014. "Implementing 'BEAM Plus' for BIM-based sustainability analysis." *Automation in construction* 44: 163-175.

Optimizing Precast Concrete for Micro Housing

Gernot Riether¹, Mohamed Mahgoub²

¹Hillier College of Architecture and Design, New Jersey Institute of Technology (NJIT), Newark, NJ

²School of Applied Engineering and Technology, New Jersey Institute of Technology (NJIT), Newark, NJ

ABSTRACT: The increasing cost of housing in urban areas has made it difficult for the middle class to live and work in close proximity.¹ At the same time more people want to live in cities and urban metropolitan areas are growing. As a consequence of increasing living density through compact living, Micro-housing had emerged in many metropolitan areas. This research will investigate in precast concrete as a building system to explore possibilities of translating the need of high-density living conditions into new types and configurations of spaces for Micro-housing to provide new urban qualities for a lifestyle of young urban professionals and to tackle construction cost and time. The paper will discuss the opportunities and challenges of using precast concrete for Micro-housing at the scale of 5-over-1s and will use three case studies developed by students of a fourth year B Arch PC Research Studio at NJIT to show three possible strategies to address these challenges through projects that were developed with the Precast Concrete Industry and a Jersey City based developer.

KEYWORDS: Precast Concrete, Micro-Unit, Housing

INTRODUCTION

The PC Research Studio is a 4th year Option Studio of the B Arch program at the School of Architecture at the New Jersey Institute of Technology (NJIT). Sponsored by the Precast Concrete Institute (PCI) and the National Precast Concrete Association (NPCA) it provides an environment for students to engage in meaningful ways with the precast concrete industry. It exposes students to producer companies and fabrication processes that are on-trend with the use of techniques in the industry. This is done through guest lectures, producer plant tours and a design build component during which students design and build real scale prototypes of precast building components. The hands-on studio focuses on the benefits of precast concrete techniques and capabilities, challenges of concrete as a material and precast concrete as a construction system and speculates with solutions for different building typologies for the industry.

1.0 THE NEED FOR MICRO HOUSING – JERSEY CITY AS CASE STUDY

There are economic, demographic and environmental reasons that make compact living a necessity. This research will use a Micro Housing as a building typology and Jersey City as a site to speculate with new solutions.

According the United States Census Bureau the number of single households in the US has increased to currently 28%² and the future is likely to require more housing for people who live alone. Trends such as the Tiny Homes movement in the US have contributed to a desire of minimal living. Many people are open to new living arrangements in order to secure affordable and stable residences. Market studies show that 25% of renters in the US are willing to choose compact housing over conventionally sized apartments (Been and Gross, 2014). The challenge is to capitalize on such trends and integrate them into the urban landscape (Evans, 2018). This research will respond to this change in demographics by developing spaces for new lifestyle requirements of private, shared and public domains. Projects will investigate strategies for micro-housing as it has an ecological advantage over typical housing. It uses less space, saves construction material and needs less energy and resources. Beside developing ideas for a transformable unite projects will pay attention to the relationship between the unit and the façade, common spaces and efficiencies in the construction.

Jersey City was selected as housing expenses there reached a national record high of currently 74% higher than the national average. One reason why Jersey City has become such an extreme case is the development of the Path train that connects Jersey City to Manhattan. Large investments in improving the Path since its reopening after Hurricane Sandy lead to up to 40% increase train frequencies between Newark and the World Trade Center and made Jersey City an attractive place for young professionals to live in close proximity to work in Manhattan.

2.0 ADVANTAGES AND CHALLENGES FOR PRECAST CONCRETE USED FOR 5-OVER 1

This research is focused on 6 story buildings also known as 5-over-1s, a building typology that is very typical for metropolitan area across the US. The recent increase of housing can be contributed to a large degree to a dramatic increase in cost of building materials, supply chain issues and uncertainties in construction time (Evans, 2018). Instead

of using the typical building system of wood-frame stories atop one concrete podium this research will explore the advantages and challenges to use precast concrete as a single construction system.

2.1. Advantages

There are different types of precast concrete systems: Frame construction, solid wall construction and semi-fabricated systems. Using precast concrete for 5-over-1s the typical construction techniques used are frame system in the first floor to accommodate for larger spaces such as stores or parking and solid wall construction in the upper floors. Semi-prefabricated elements in which the permanent formwork is made from fair-face concrete to which in situ concrete is then added on the site is typically not used for this building typology.

This research will focus on solid wall construction as it is the fastest and most cost-effective construction system. The components for such a system are typically casted horizontally on a casting bed. This results into two different surface finishes, the formwork side and the trowelled side. The formwork side can be treated in various techniques. Beside chemical and physical surface treatments such as sandblasting, form liners can be used to create an imprint. Panels can also be produced as sandwich panels that integrate insulation. Constructing a building as a kind of parts requires a good understanding of its parameters, techniques and requirements and a close cooperation between architect, structural engineer and fabricator. The more the kind of part is simplified and the more the number of panels can be reduced the more cost can be saved.

On site the typical erection of a solid wall system is 10 weeks for a 5-story housing project which dramatically saves time over conventional construction techniques and reduces construction cost. Once assembled on site wall surfaces do not have to be finished. Concrete can be exposed. Exterior insulated sandwich panels save additional time in the construction process. This reduces assembly time and the number of trades that would typically be involved and would have to be coordinated in constructing a building façade. Walls can be used structurally which can save on material and cost over alternative construction methods that are made up of columns and beams as a primary structure and wall panels as a secondary structure.

The factory-based production allows for a fast fabrication process of components and a very short assembly time on site. Producing components under controlled conditions provides better quality for concrete density and surface finish. Humidity of the air, temperature and the curing time can be better controlled than on site which results in high quality concrete components. Disadvantages of prefabricated solid wall systems are the limitation of size that depend on the casting beds available, limitations on variations and transportation to bring elements from the precast plant to the site and the risk of damage during the assembly process. Another disadvantage maybe that you see the joints that will always reveal the presence of precast elements.

In terms of building performance an essential advantage of solid construction is its thermal properties (Doebbler, Ellis, and Michael 2005). Heating and cooling buildings requires energy. Heat storage capacity is equally important than thermal insulation. As thermal conductivity increases with density monolithic or solid construction techniques such as concrete have thermal advantages over lightweight forms of construction such as timber or timber studding. Based on studies that compare the two different building systems in different climatic regions the heating requirements is about 2-8% lower in solid construction techniques due to the greater heat storage capacity. Especially in spring and autumn, solid components store solar energy, which prevents uncomfortable interior temperatures. As the energy is released when temperature is decreasing no input of new energy is required for one to two cooler days, an effect known as Buffer Effect. The combination of storage capacity and insulation leads to a primary energy saving of approximately 3% compared to buildings employing lightweight forms of construction. Comparing the cooling energy requirement of the two different building systems solid construction the use of energy is about 15-20% lower than buildings using lightweight forms of construction (Peck, 2006). Even more energy can be saved at specific parts of the building. A timber roof construction for example would result into extreme temperature differences whereas a roof construction from precast concrete elements creates an interior climate in roof spaces that is almost identical to those of the stories below.

2.2. Challenges

Architecturally the use of precast concrete in housing projects faces a series of challenges that have to do with preconception. Precast concrete is often associated with prison architecture, student dormitories and post-war large-scale affordable housing projects that failed large social projects.⁷ Such associations created an unnecessary stigma for using precast concrete for housing. Using precast concrete in new ways to address today's challenges of micro-housing may help to change this perception. Cost is also an important factor. 70% of US house builders chose construction systems based on cost and value (Glass, 2000).

Reducing the number of panels and variations for example can significantly reduce the overall cost. Also, this may seem to compromise opportunities for architecture it can also be framed as an architectural challenge. Typically, building 5-over-1s using precast concrete would result in a hybrid construction: frame construction in the 1st floor and solid wall construction in the upper floors. This has to do with different spatial requirements for different programs. The three projects below experiment with different strategies to integrate the 1st and upper floors into a single solid wall

construction system. This can be accomplished by cutting openings into the panels, aligning spaces and distributing communal spaces differently such as sucking them vertically instead of horizontally.

Another challenge that need to be addressed is the environmental footprint of concrete. Cement produces carbon dioxide during its production, but cement could be replaced as an aggregate by fly ash. Current research is looking into the percentage of fly ash used to replace cement for equal strength. A discussion with engineers and plant managers from precast concrete plants made clear that the problem is the consequences such a change would have in the fabrication of precast concrete panels.

One problem that prevents concrete plants to use fly ash is that replacing cement with fly ash would lead to longer curing processes which would have a large impact on the production sequence of prefabricated concrete. Typically, a precast concrete plant is turning out panels in a daily workflow cycle: Preparing the mold, casting and curing within 24 hours. Changing to fly ash would reduce the number of panels an existing plant could output in a certain time frame. From a financial perspective it explains challenges that a precast concrete producer would still have to overcome to switch to more environmentally friendly aggregates. Current research is therefore testing different particle sizes of fly ash and cement to speed up the curing process (Bentz et al,2011).

There are a few examples of small projects that experiment with new types of concrete. In a one family house by Patrick Gartmann in Chur foamed clay it used to replace gravel as an aggregate and sand was replaced with foamed glass to improve insulation qualities and making the material lighter. In another project by Clemens Bonner and Amanda Schlaich in Berlin fiberglass was used instead of steel and an air-entraining agent was included to improve thermal conductivity to make the material significantly lighter. In the Weinberghaus at Wörrstadt the use of self-compacting fine-grained concrete made it possible to reduce the thickness of the prefabricated reinforced concrete components to 1.5 inches (Peck, 2014) . All these buildings are small residential projects and much will have to be done to translate these prototypical projects into an industrial scale.

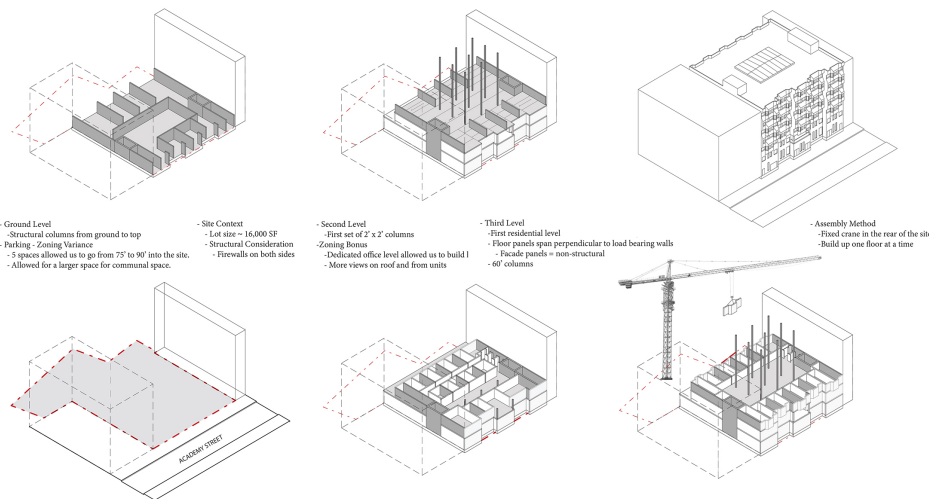

Figure 1: Diagram of construction sequence. Source: (Samantha Volpicella and Abdurahman Oudeh 2022)

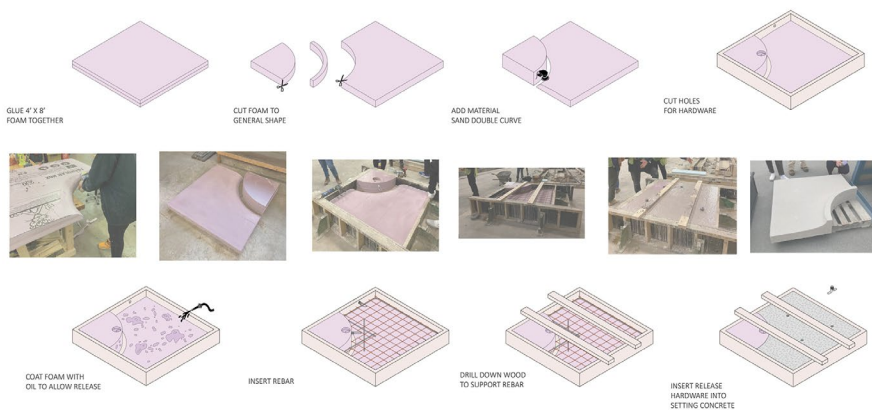

Figure 2: Diagram and images of production of façade prototype. Source: (Ella Martz and Karly Savinon 2022)

In collaboration with BLDGup (2021) , a local real-estate development company, the studio developed strategies for micro housing for a site that was recently purchased by the developer: 189 Academy Street in Jersey City. Its location

between Newark and New York City makes this area an attractive location for developers to invest in. The close proximity to public transportation creates a perfect condition for housing.

The projects below are minimizing the size of the units 240sf – 360sf that are 12' x 20' to 30' in plan in response to the lifestyle of young urban professionals that want to live in close proximity to work, cost and parameters of the prefabrication system. Living room, bedroom, kitchen, etc. are dedicated to specific functions only used for a specific activity during a specific time. Combining these functions into a space that can transform and adapt to different uses is a much more efficient way of using space in housing. This required the development of transformable furniture. The design of the facade was especially critical as it not only framed views and regulated daylight but also informed the appearance and experience of the small living unit. Projects also provided strategies of moving functions of an apartment from the unit into communal spaces or public urban spaces.

Surrounded by a wide range of public spaces and places of social activity is key for a micro-housing project to be successful as the small living unit is just one of the places where daily activities take place. All projects therefore also address the demand on social interaction through new types of communal spaces. The city is the place of activity and the micro unit a place to sleep and rest. This allows for the private space to be small and push the density level of cities upwards.

All projects speculated with different strategies to respond to the relationship of construction systems between 1st floor and upper floors and different relationships between construction system of the apartments versus common spaces. In teams of two to three students, 6 different projects were developed for the site. The three projects presented here are all within the parameters of a 5-over-1s which is a zoning regulation for this area but schemes differentiate conceptually as one was developed as towers, another as a folded façade and a third as a series of townhouses.

In the project by Ella Martz and Karly Savinon the maximum building volume was broken up into four volumes or towers that form courtyards between them. The daylight that penetrates through these courtyards in the middle of the site provided a condition to pack the site with more units. Each tower had floorplans of four to six units. The towers were then tied together through bridges that connected the individual towers into a single building in terms of egress. A unique feature of the project was the window. The window frame was extruded into a windowsill that could be occupied as a small space to study or lounge. This also visually extended the length of the unit without changing the square footage. The extrusion of the window frame created a double curved surface on the exterior of the building, creating a unique and more three-dimensional characteristic of the façade. The team used CNC to create the mold taking advantage of the plasticity of concrete as a material.

In the project by Lucas Konradparisi and Kashish Dalal daylight penetrated through a courtyard into the middle of the building allowing to organize the floorplan in one double and one single loaded corridor with the main vertical circulation along both edges of the site. From this configuration some of the units were extracted to make space for shared spaces to work, cook and socialize. This move provides views through the entire site, visually connects the amenity spaces to the street and the backyard and provides orientation from circulation spaces and common spaces in the building. Another unique feature is the façade of the building. Conceptualizing the façade as a folded surface created bay windows for each unit that opened views up and down the street and visually expanded the size of the small micro unit. To cast the panel, the folded façade was broken down into L-shape components with a reveal of 3', which is the maximum reveal that can be produced by casting a panel horizontally.

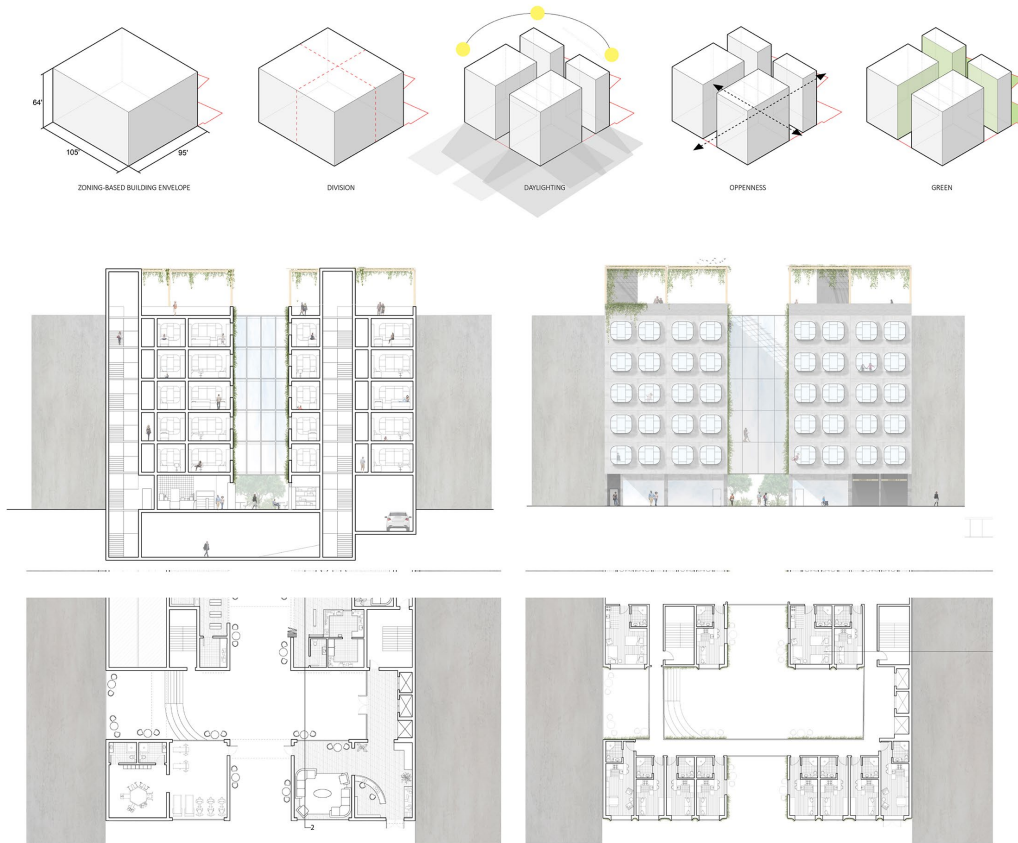

Figure 3: Concept diagram, section, elevation and plans. Source: (Ella Martz and Karly Savinon 2022)

In their Townhouse project Samantha Volpicella and Abdurahman Oudeh responded to the characteristics of existing townhouses in the neighborhood of the site. The façade was broken down into five vertical sections that were formally articulated differently to appear as separate buildings even they were organized as a single building. This effect was achieved by pulling parts of the façade into the street created corner and bay windows. The units lined up towards the street and the backyard leaving a large atrium in the center of the building that spatially connects all the residents into one community and houses common functions such as shared office spaces, lounges, a fitness center and other amenities. The façade was broken down into horizontal panels that span the length of each section of the total of five sections of the building. This allowed to integrate the complexity of the folded façade into a single mold of a panel that was repeated throughout the entire façade.



Figure 4: Elevation and plans. Source: (Lucas Konradparisi and Kashish Dalal 2022)

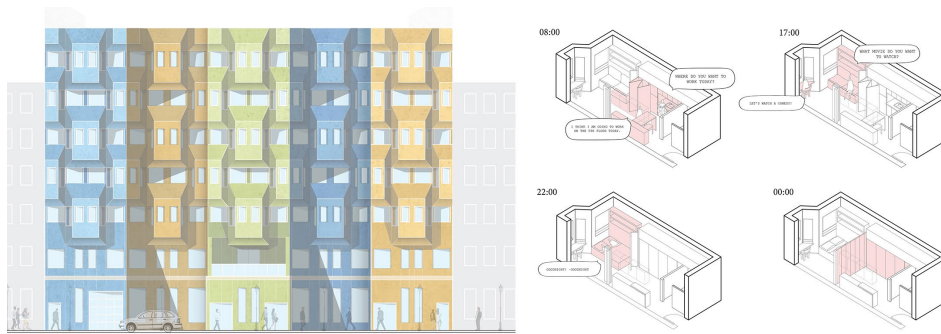

Figure 5: Elevation and diagrams of micro unit. Source: (Samantha Volpicella and Abdurahman Oudeh 2022)

CONCLUSION

The paper provides an overview of challenges and advantages for precast concrete construction in 5-over-1s and provides through three examples strategies of how challenges can be turned into opportunities by translating new requirements for housing into a new aesthetic quality and more efficient construction techniques. Combining that with a research in a material that is more sustainable provides a strategy that can help respond to the current housing crises.

The projects of the studio explored different façade strategies to respond to micro housing but at the same time translated these challenges into aesthetic qualities far beyond the typical punch out design of precast concrete façade elements. The case studies also offer different strategies for an effective use of precast concrete as a building system by integrating the first floor and upper floors into a single construction system. The three projects also provide a range of alternatives for organizing living units and common spaces that create different frameworks for new lifestyles. The paper also describes the Nature of an upper level B Arch research studio that connects students to the construction industry. Casting small scale models and creating a full-scale prototype student learned how to operate within the limitations of horizontally casted panels. At the same time the design of bay windows, a folded façade and extrusions showed how such limitations can be challenged and resolved.

ACKNOWLEDGEMENTS

Students of 2022 PCI Research Studio: Kashish Dalal, Hunter Grimm, Siluni Karunaratne, Lucas Konradparisi, Ella Martz, Abdurahman Oudeh, Kumayl Qureshi, Timothy Ramnanan, Joseph Rocker, Karly Savinon, Samantha Volpicella, Dominique Wiktorowski.

Collaborators: PCI Research Studio 2022: Dawn Decker, Executive Director, PCI Mid Atlantic; Lauren Rose, Design Team Leader, High Concrete Group.

Consultants: Chad Hollinger, Design Engineer, High Concrete Group; Harry Nash, Design Engineer, High Concrete Group; Brittany Colmery, Design Engineer, High Concrete Group; Eric Rowits, Sales Representative, High Concrete Group.

Guest reviewers: Andrew John Wit, Tyler School of Art + Architecture, Temple University; Michael Gibson, Kansas State University; James Kerestes, Ball State University.

REFERENCES

- Been, V. and Gross B. 2014. "Responding to Challenging Households: Regulatory Challenges for Micro-Units and Accessory Dwelling Units." New York: NYU Furman Center.
- Bentz D. and Hasen A. and Guynn J. and Glass J. 2011. "Optimization of cement and fly ash particle sizes to produce sustainable concretes." In *Science Direct*, Vol. 33. Issue 8. 824 – 831. Amsterdam: Elsevier.
- BLDGUP real estate development services. Accessed November 29, 2021. <https://www.bldgup.com/>
- Doebber, I., Ellis, Michael W. 2005. "Thermal Performance Benefits of Precast Concrete Panel and Integrated Concrete Form Technologies for Residential Construction." In *Conference Proceedings of Ashrae Annual Conference Denver*, Vol. 111, 2. Denver: Ashrae.
- Evans, K. 2018. "Integrating tiny and small homes into the urban landscape: History, land use barriers and potential solutions." In *Journal of Geography and Regional Planning*. Vol. 11(3). 34 - 45
- Glass J. 2000. *The future for precast concrete in low-rise housing*. Glenfield: British Precast Concrete Federation.
- Peck M. 2006. "Concrete Construction Examples." In *Detail Practice*. Basel: Birkhäuser.
- Peck M. 2014. *Modern Concrete Construction Manual*. Munich: Detail

ENDNOTE

¹ Desmond M. 2022. "Unaffordable America: Poverty, housing, and eviction." In *The Affordable Housing Reader*, edited by Mueller E. and Tighe J.R., 389 - 395. London: Routledge.

² United States Census Bureau. "Measuring America's People, Places, and Economy." Accessed November 29, 2021. <https://www.census.gov>.

Patch, Stitch, Mend: A History of Urban Fabric Applied to Contemporary City Repair

Daniel Luis Martinez¹

¹Indiana University, Eskenazi School of Art, Architecture and Design, Bloomington, IN

ABSTRACT: The primary aim of this investigation is to trace the evolution of urban fabric as a concept over time in canonical texts that have greatly influenced the theory of urban design and planning. Through historical analysis, it seeks to reveal the original context surrounding its early use and its subsequent influence on urban design and planning principles across different eras. A secondary objective is to show how urban fabric's evolving meaning continues to generate new interpretations of a city's essential structures within contemporary practice. A discussion of the role of urban fabric within recent schools of thought, including New Urbanism, Ecological Urbanism, and Landscape Urbanism, culminates with the introduction of three new strategies meant to augment Tactical Urbanism's operative catalog of tactics. These strategies provide continuity to the idea of the city as a woven entity but are also meant as loose provocations for contemporary urbanists to explore.

KEYWORDS: Urban Design, Placemaking, Tactical Urbanism, History, Theory

INTRODUCTION

Within architectural discourse today, the phrase urban fabric is commonly understood as the rhythm of solids and voids created by the pattern of a city's buildings and the residual open spaces that they frame (Trancik 1986). Commonly illustrated with a figure-ground drawing, the fabric of a city can be synonymous with its texture (Rowe and Koetter 1978) and can indicate continuity or disruption of surfaces in vertical and horizontal directions. Despite wide use, the origins of this concept have not been studied in detail, nor have the metaphorical implications of comparing urban form to a textile. Thus, the primary aim of this investigation is to trace the evolution of urban fabric as a concept over time in canonical texts that have greatly influenced urban theory. The hope is to understand more clearly the original context surrounding its early use and its subsequent influence on urban design and planning principles across different eras.

A secondary objective is to show how urban fabric's evolving meaning can continue to generate new interpretations of a city's essential structures. The article will end with a summary of possible frameworks inspired by the history of urban fabric and applied to contemporary strategies for Tactical Urbanism. Ideas such as patching, stitching, and mending represent an intriguing continuity in the belief that cities are woven systems. They also highlight an important characteristic of the current era. Increasingly, the frayed urban fabrics of cities are repaired through small-scale, cost-effective measures that are developed and implemented through community-engaged processes (Lydon and Garcia 2015, Courage and McKeown 2019). These are ephemeral solutions that embrace urban design by trial and error, but they can also serve as catalysts to permanently strengthen an urban fabric over time.

1.0 HISTORICAL BACKGROUND

Etymologically, only the most recent sense of the word fabric in the English language refers to a textile. Its oldest significance, dating from the late fifteenth century, denotes something constructed and is borrowed from Middle French *fabrique*, which is in turn connected to the Latin *fabrica* meaning workshop. This sense persists in the English word *fabrication* and highlights the fact that fabric has a doublet in the word *forge*. Fabric evolved to mean manufactured material by 1753 and is not recorded as referring to a textile until 1791. The word *urban* on the other hand enters English as early as 1619 and has always related to the city. It stems from the Latin *urbs* (genitive of *urbis*), which refers to a city dweller. The close English relative *urbane* is recorded as early as 1533 in reference to the purported elegance and refinement of character attained by city dwellers in comparison to rural or sub-urban denizens (Barnhart 1999).

It would take several centuries before anyone thought to combine these two terms. Searching through architectural texts of the sixteenth century reveals that fabric is still closely aligned with its original sense as something constructed. In Rudolf Wittkower's *Architectural Principles in the Age of Humanism* (1949), the author reproduces a memorandum from the Franciscan friar Francesco Giorgi (1466-1540) about the construction of San Francesco della Vigna describing the desired proportions as follows:

In order to build the fabric of the church with those fitting and very harmonious proportions ... I should like the width of the nave to be 9 paces, which is the square of 3, the first and divine number. The length of the nave, which will be 27, will have a triple proportion ... (Wittkower 1949, 155)

Giorgi explains that the power of this harmonious proportion is evidenced by Plato in the *Timaeus*, who wished to describe the wonderful “consonance of the parts and fabric of the world” (Wittkower 1949, 155). He elaborates further that in Christian theology the same proportional measure was used by Moses for the fabled tabernacle, which was also based on the fabric of the world. The architect who would eventually design the façade of San Francesco, Andrea Palladio, writes in his influential *Four Books* (1570) about how disagreeable it would be “if in a very large fabric there should be small halls and rooms” (Palladio 1570, 37). In this passage, fabric denotes the overall architectural structure or shell, which the architect must subdivide proportionately to create aptly scaled interior volumes. Hence, fabric was used in Greek philosophy and Christian theology to describe the tacit background that structures an entire world but takes on a decidedly architectural connotation during the sixteenth century in reference to the structure of buildings. In both cases there is no specific link to textiles or urbanity.

Given that the characteristics of urban fabric are often illustrated through a figure-ground drawing, one obvious place to search for the origins of this phrase is the work of Giambattista Nolli. His 1748 Map of Rome is arguably the most famous and frequently cited example of a figure-ground drawing. Commissioned by Pope Benedict XIV in 1736, Nolli’s cartographic masterpiece was made as an attempt to clarify and correct an earlier map of Rome by Leonardo Bufalini. The work of both cartographers was used as the basis for a 1761 publication where the extraordinary height of the great aqueduct known as Acqua Marcia is deduced based on the “ruins of its fabric” (Bufalini and Nolli 1761, 10). Severus’ Arch in the Roman Forum is also described as a “magnificent fabric” that is now considerably sunk in the earth (Bufalini and Nolli 1761, 13). The book demonstrates that fabric in the eighteenth century still references physical structures such as monuments or buildings, rather than a collective urban structure.

The nineteenth century offers more context around the origins of the phrase urban fabric. The industrial revolution helped the world’s urban population nearly double between the years 1820 and 1920 (Van Bavel, 2013). This gave rise to major renewal projects and heightened the dialogue surrounding urban planning. Notably, this era also marks the birth of sociology and ushers in an increased focus on the social fabric of cities. Auguste Comte, the inventor of Positivist philosophy and a pioneer in the social sciences, writes a letter to John Stuart Mill in 1841 about the rise in popularity of metaphysical theories that may “subvert the whole fabric of society” (Thompson 1976, 917). German social theorist Friedrich Engels writes in 1844 about his experience of rapidly industrializing cities in England. He explains:

What is true of London, is true of Manchester, Birmingham, Leeds, is true of all great towns. Everywhere barbarous indifference, hard egotism on the one hand, and nameless misery on the other. ... one can only wonder that the whole crazy fabric still hangs together. (Engels 2000, 48)

Engels had been sent to Manchester during his early twenties by his parents, who hoped to excise his radical political views through physical labor at a factory that, coincidentally, made sewing threads. However, his first-hand experience of industrial working conditions in England emboldened his political critique instead. Writing by Comte, Engels, and other early sociologists demonstrates how the meaning of fabric, still aligned closely with structure, is applied to urban conditions.

Urban design treatises also flourished in the nineteenth century. Idefons Cerdà’s *General Theory of Urbanization* (1867), recently translated into English, contains a curious analogy in its closing sections. In a passage addressing the transition of cities to accommodate emerging transportation technologies, Cerdà explains that contemporary urban renewal efforts are akin to Penelope’s shroud, since they are “successively woven and unwoven ... never reaching a state entirely suited to the real urban and social needs” of inhabitants (Cerdà 1867, 702). The reference is to Homer’s Greek epic *The Odyssey* where Penelope outwits various suitors during her husband’s long absence by insisting that she must first complete a shroud for Odysseus’s father before entering a new marriage. For several years she unravels her work at night and begins again the following day, thereby maintaining the possibility of reuniting with Odysseus. For Cerdà, it is the ever-expanding requirements of urban circulation that instigate the need for urban renewal or what he wittily refers to as the process of “Penelope’s cloth” (Cerdà 1867, 714).

Thus, the metaphor of a city’s woven structure is very much in play during the mid to late nineteenth century. Camillo Sitte’s influential treatise, *City Planning According to Artistic Principles* (1889), reinforces this concept. Sitte sets out to understand why nineteenth century planning, though rich in technical achievements, lacked significantly in artistic merit compared with previous centuries. The principal method of his research was to create figure-ground diagrams of historically successful urban spaces and explain the root cause of their beauty through formal analysis. In one passage, he compares nineteenth century urban layouts with Baroque examples and praises the building typologies of the latter for typically leaving one side of a courtyard open to the city. This yields a condition where, according to Sitte, “the enclosure with its powerful architectural effect could be advantageously seen and woven into the city structure” (Sitte 1889, 52). In this case, city structure can be interpreted as a synonym of urban fabric.

By the early twentieth century, the idea that a city’s structure is a woven fabric of social and physical threads is embraced by Sir Patrick Geddes. A devout believer in Positivism, Geddes converted to Auguste Comte’s Religion of Humanity after studying biology and anthropology. He became interested in the built environment after surveying the city of Edinburgh and, more specifically, through his efforts to improve conditions within the city’s slums. Geddes subsequently received an invitation to assist with planning efforts for the city of Indore in the west-central state of Madhya Pradesh in India. In a summary of his proposal for Indore he asks:

How can we hope to make an enduring fabric of all these long separate warp-threads of the loom of Time? Only by weaving in the corresponding threads of the woof. What then are these? What but the Cities and their Regions, the City-States ... (Geddes 1918, 183)

Warp-threads run vertically on a loom and counter to the fibers that run horizontally to form the weft of an interlocking fabric. The term woof is an antiquated synonym of weft that was often used figuratively in speech, especially during the Victorian era. On the loom of Time in the analogy by Geddes, it is the city and its surrounding region that create the integral warp and weft of his proposal. In India, he admired the “transition from narrow lanes and earthen dwellings to small streets, great streets, and buildings of high importance” as an “inseparably interwoven structure” (Tyrwhitt 1947, 26-27). His approach influenced several contemporaries, including Raymond Unwin and Ebenezer Howard, who catalyzed the Garden City Movement in England and heralded an era of decentralized approaches to urban design and planning.

2.0 URBAN FABRIC IN TWENTIETH-CENTURY MODERNISM

The loom analogy employed by Geddes would not be the last in the history of urban fabric. Another version would appear in Frank Lloyd Wright's *The Disappearing City* (1932). Surrounded by the agrarian and industrial landscapes of the Midwest, Wright designed the utopian Broadacre City as a critique of Chicago's two influential world fairs and as a diffuse urban model tailored to the vast scale of the American countryside. The 1893 World's Columbian Exposition, which produced the framework for the City Beautiful Movement and Daniel Burnham's 1909 Chicago Plan, was disdained by Wright as a nostalgic echo of nineteenth century Paris that set back his dream of a “native architecture” for “at least fifty years” (Wright 1957, 57). Wright not only embraced decentralization of building and population density, but also of transportation and vital infrastructure. Broadacre City would entail the “architectural reintegration of all units into one fabric” (Wright 2000, 349). Thus, urban, industrial, and rural elements of society are combined into Broadacre's singular fabric that appears as a quilted patchwork in the largescale model produced by Wright's studio.

Wright dedicates a significant portion of the book to explaining his concept of individuality. He is careful to distinguish this idea from the “rugged individualism” of capitalism and describes individuality instead as an interior quality of the spirit (Wright 1932, 15-19). Broadacre City is designed as an embodiment of “communal-individuality”, which is how he defines democracy and why he proposes to guarantee an acre of land for every family (Wright 1932, 19). Individuality also proves to be essential for Wright to balance the homogenizing tendency of mass-production and his totalizing urban model with the obvious need for difference. On the differences between Broadacre Cities, he writes:

These differences would naturally be accentuated and developed as to their individuality except where uniformity of standardization and mass-production entered as substantial human benefit into the warp of the fabric. But the ultimate weaving need show no less imagination and individuality when the woof began to be stitched on to the warp. (Wright 1932, 51)

Unlike Geddes, whose loom of Time served as a metaphor for the interwoven relationship between city and region, Wright imagines a loom so that he can temper the technological advents of the machine-age with the spirit of individuality. He interlocks the warp of standardization with the weft of individual personality, which he believes will organically develop from a city's people and natural context. In the end, however, the communal-individuality envisioned by Wright as true democracy is only vaguely defined and its spatial embodiment through organic architecture seems like a veiled promotion of his own architectural tendencies.

The advent of modernism in Europe marks another significant inflection point for the phrase urban fabric. The Congrès Internationaux D'architecture Moderne (CIAM) was organized in 1928 by Le Corbusier, Hélène de Mandrot, and Sigfried Giedion as a forum for leading European architects to discuss the role of architecture in advancing the social and cultural values of western society. Their fourth meeting, which took place aboard a ship sailing from Marseille to Athens in 1933, focused on the topic of “The Functional City”. An edited summary of this CIAM meeting was published a decade later by Le Corbusier as the Athens Charter and served as a foundation for his radical urban design proposals, including the Radiant City (1935).

The Athens Charter is organized according to the central functions of the city, which are identified as habitation, leisure, work, and traffic. Among the major problems of the traditional European city identified by CIAM were the “remoteness of outlying open spaces,” which do not necessarily improve the “congested inner zones of the city” (Corbusier 1976, 67), as well as the “dimensioning of streets,” which if not adapted to the future might impede upon “new mechanized speeds and the orderly progress of the city” (Corbusier 1976, 80). The Charter recommends that every residential district include adequate recreational spaces and that “unsanitary blocks of houses be demolished and replaced by green areas” (Corbusier 1976, 69). Infatuated with the emerging technology recently made available to produce tall buildings, the Charter also stipulates that “high buildings, set far apart from one another, must free the ground for broad verdant areas (Corbusier 1976, 65). Taken all together Le Corbusier emphasizes that, “the urban fabric will have to change its texture,” so that urban population centers can be transformed into “green cities” (Corbusier 1976, 69).

The result is a total inversion of the figure-ground patterns found in historic European centers like Rome, where tightly packed buildings carve out intimate public spaces with an almost labyrinthian effect. Instead, the modernist urban vision

embodied by Le Corbusier's drawings for the Radiant City show pedestrian parks and vehicular circulation as the primary components of a city's structure separated in section with vertical buildings organized sparsely in a rational grid. It is important that the Athens Charter describes this as a change in the urban fabric's texture. This tactile quality acts as a conceptual device that invites the reader to imagine running their fingers over cities to note their differences in grain. A medieval city, for instance, might feel courser and more complex with little variation in height, while the fabric of the modernist city is definitively looser and punctuated by a regular rhythm of vertical protrusions.

3.0 SOCIAL FABRIC AND CROSS-USE AFTER WORLD WAR II

The decades following World War II would serve as a global testing ground for the urban ideals of the modernist movement, but this era would also foster its most poignant criticism. While the ideas in the Athens Charter and *The Disappearing City* differed significantly from one another, they shared the common goal of decongesting and sanitizing densely populated city centers. By 1959 CIAM had disbanded, and Team 10 emerged as its heir with many of its members openly criticizing the spread of the Radiant City's ideals. As Team 10 member Aldo van Eyck put it:

Instead of the inconvenience of filth and confusion, we have now got the boredom of hygiene. The material slum has gone ... but what has replaced it? Just mile upon mile of organized nowhere, and nobody feeling he is 'somebody living somewhere' (Smithson 1968, 44).

Two of his partners in Team 10, Alison and Peter Smithson, described modernist urban design as completely inadequate in providing "an environment which gives form to our generation's idea of order" (Smithson 1968, 84). Defining form as an "active force" that is "life itself made manifest," they felt compelled to "evolve an architecture from the fabric of life itself" (Smithson 1968, 88).

It was the dawning of an era that would embrace the gritty life of the city as an essential aspect of its urban fabric. This idea was explored deeply in *The Death and Life of Great American Cities* (1961) written by Jane Jacobs. The book is first and foremost an "attack on orthodox urban planning," which Jacobs jokingly describes as "Radiant Garden City Beautiful" during her introduction (Jacobs 1961, 25). The book's first section contains descriptions of the lively atmosphere and diversity of interactions that occur on the streets of cities. Beginning with everyday observations is essential for Jacobs' critique because it amplifies the romanticism and imposing order of orthodox planning. In contrast to an idealized society living in harmony with nature and automobiles, she calls on urban planners to instead "foster lively and interesting streets" and to "make the fabric of these streets as continuous a network as possible." She describes successful parks and squares as a natural extension of the "street fabric." (Jacobs 1961, 129)

Spontaneity and even chaos are essential elements of the vibrant city for Jacobs, and she draws attention to the "differing commercial and cultural facilities, and different-looking scenes" that crop up throughout one's experience of a diverse city. It is "within this fabric" of everyday street life that "huge traffic arteries, too large parks, big institutional groupings" can disrupt what she describes as the essential "cross-use" of neighborhoods (Jacobs 1961, 130). Cross-use is a key word in Jacobs' lexicon that greatly expands the breadth in meaning of urban fabric. It describes the "internal continuity and overlapping" with which a district is used, as well as the capacity of a district to attract "visitors from other parts of the city" (Jacobs 1961, 132). Jacobs sees the intangible vectors of movement created by people motivated to explore neighborhoods as essential fibers of the urban fabric. Hence, "monotony is the enemy of cross-use" (Jacobs 1961, 130), since it suppresses the variety of uses and conditions necessary to create the "intricate mixed city fabric" where pedestrians can thrive (Jacobs 1961, 269).

Throughout the book, Jacobs rejoins urban fabric with its sociological origins by focusing on the movement of people and their everyday use of the city. Her ideas inspired many followers. The urbanist William H. Whyte, for instance, decried the "clean-sweep approach that obliterates the street pattern," because it, "also obliterates the fabric of the city" (Whyte 1968, 286). Whyte believed that most redevelopment projects were simply "too loose in fabric" (Whyte 1968, 336). Jan Gehl, in his influential book *Life Between Buildings* (1971), notes that "social activities and their interweaving to form a communal fabric" had declined in the modern era (Gehl 1971, 14). A firm believer that "life in the streets" was essential to fostering a healthy city, he lamented that the introduction of suburban "gas stations, car dealerships, and parking lots" had, "created holes and voids in the city fabric" (Gehl 1971, 93). Alison Smithson wrote an article dedicated to the problem of a "city center full of holes", which she believed were generated by the decentralizing and depopulating effects of diffuse urban models typical of the modern era (Smithson 1977).

The emerging automotive industry that fascinated and inspired Le Corbusier and Wright in the 1920's engulfed the urban landscape by the 1960's with dire social and environmental effects. The streets of medieval towns, scaled for the experience of pedestrians, became an unlikely foil to Modernism's technologically forward cityscape for critics like Lewis Mumford. He famously compared the form of medieval towns to a tapestry because the "eye, challenged by the rich intricacy of the design, roams back and forth over the entire fabric" (Miller 1986, 119). Intricacy becomes a key characteristic of successful urban fabric during this generation. In his research for the book *A Theory of Good City Form* (1981), urbanist Kevin Lynch asked hundreds of design students to describe what makes a good city. The most popular responses included stimulus, richness, variety of experience and scale, wealth of perceptible detail and "intricacy of urban fabric" (Lynch 1981, 385). Lynch was also critical of disruptions to the urban fabric caused by large vehicular

streets and parking lots. “Any good city,” he explains, “has a continuous fabric, rather than a cellular one” (Lynch 1981, 401).

4.0 FABRIC ANALOGIES IN NEW, ECOLOGICAL, AND LANDSCAPE URBANISM

Different schools of thought emerged from this era’s critique of modernist urban design. A return to the logic of traditional urban fabric prioritizing the publicness of the street in all its intricacy, continuity, and diversity would help define New Urbanism. As a leading proponent of this movement, Léon Krier embraced the call for mixed uses in cities advocated for by Jane Jacobs and identified single use zoning as the most detrimental policy adopted by many European cities since the advent of modernism (Krier 1977). Krier believed that the concentration of singular programs simultaneously destroyed a city’s physical and social fabric, as well as the cultural and economic systems that develop under ideal conditions as a result (Krier 1977).

As with Lewis Mumford’s admiration for the medieval town, Krier called for a return to “the study of the history of the city” in opposition to modernism’s overt “anti-historicism” (Krier 1978, 41). This historical turn would place an emphasis on the full range of architectural typologies that comprise the city. He explains how:

The bourgeois concept of architectural history- basically concerned with the monument- is extended to include the typological complexity of the urban fabric, of the anonymous buildings forming the flesh of the city, the skin of public space (Krier 1978, 41).

This quote interestingly compresses and expands the meaning of urban fabric. Reduced to anonymity, Krier presents urban fabric as the non-descript blocks whose continuity of mass and form make it possible to emphasize the hierarchy of civic monuments. However, he immediately lifts the phrase up as the “skin of public space,” which by analogy to the clothing on bodies, draws attention to the articulated façades of buildings as textile-like elements.

Alternative schools of thought emerged through advocates of ecological and landscape urbanism. Choosing not to wholly discard the notion of creating green cities that was central to modernist ideology, advocates of ecological urbanism sought an alternative to buildings for reinforcing the structure and identity of cities. The metaphorical loom returns with Stuart Cowan and Sim Van Der Ryn’s thought experiment to:

“Imagine the natural world and the humanly designed world bound together in intersecting layers, the warp and woof that make up the fabric of our lives” (Van Der Ryn and Cowan 2000, 520).

They argue that the complex relationship between nature and the built environment is not a “simple fabric of two layers,” but rather, “dozens of layers with vastly different characteristics.” Hence, the field of ecological urbanism is described as an investigation into “how these layers are woven together” (Van Der Ryn and Cowan 2000, 520).

The ecological school blossomed alongside landscape urbanism in the 1990’s and early 2000’s with the shared belief that environmental consciousness would require that “building fabric, street wall, and traditional public space recede as the primary determinants of urban order” (Waldheim 2016, 92-93). The rehabilitation of cities marred by heavy pollution and the vestiges of obsolete industrial infrastructure became the primary mode of operation for landscape urbanists dealing with “decreased density, friction of social interaction ... and deterioration of building fabric” (Waldheim 2016, 92-93). In an expansion of the regional thinking framed by Sir Patrick Geddes, landscape architect James Corner theorized that the great potential of landscape urbanism existed in the ability “to locate urban fabrics in their regional and biotic contexts” (Waldheim 2006, 24). A city’s green space is envisioned as a strategic intermediary, in contrast to the expansive and formal ground of the Radiant City. For Charles Waldheim, this creates the possibility of using “landscape in the stitching of infrastructure into urban fabrics” (Waldheim 2006, 45).

CONTEMPORARY TACTICS

The field of landscape urbanism has been responsible for many large-scale urban waterfront and industrial rehabilitation projects over the past decades. However, the global economic recession of 2008 created a context in which major infrastructural, cultural, and civic planning projects in urban areas would need to be reconsidered. It is in this context that a focus on community building and a replacement of “top-down” urban planning with the “ground-up” approach of Tactical Urbanism and Creative Placemaking emerged (Lydon and Garcia 2015, Courage and McKeown 2019). As Aditi Nargundkar Pathak writes of the Urban Vision program in Mumbai, a recent placemaking initiative “creating flexible social places” in the city: “At this inflection point, it has become essential to revive and keep the social fabric of cities intact.” (Pathak 2019, 70). What is readily identified as Creative Placemaking in contemporary practice emerged from a shift in policy at the National Endowment for the Arts in the US during the first Obama administration to focus on funding low-cost projects with the potential to animate public and private spaces, as well as rejuvenate structures and streetscapes (Markusen and Gadwa, 2010).

Creative Placemaking shares the general aspiration of increasing walkability in vehicle-centered urban environments through city repair with Tactical Urbanism. Both approaches are indebted to the urban rebellion of the 1960’s and 70’s

and the evolution of theory into practice for pioneers of that generation like Jan Gehl. These ideologies are meant to address the needs of urban centers and the decentralized urban and suburban sprawl typical of the US and other western nations. The work of Street Plans Collaborative, co-founded by planners Mike Lydon and Tony Garcia, embodies the principles of Tactical Urbanism by addressing the “undervalued/underutilized supply of walkable urban fabric” in places that have “limited social, economic, and physical resiliency” (Lydon 2012, 3).

A unique feature of the Tactical Urbanism movement is the active cataloging and open-source sharing of various tactics that can be employed by everyday individuals or collectives to improve their neighborhoods. These tactics can be “sanctioned or unsanctioned,” depending on whether they aim to follow the rules of regulatory bodies or skirt the system altogether (Lydon and Garcia 2015). Based on the history of urban fabric explored in this study, which demonstrates both its metaphoric resiliency and surprising breadth of meaning, I'd like to propose three strategies to augment the Tactical Urbanism catalog. These strategies provide continuity to the idea of the city as a woven entity but are also simply meant as loose provocations for contemporary urbanists to explore.

As a lo-fi adaptation of landscape urbanism's ability to stitch infrastructure into the urban fabric, the first strategy is stitching. This refers to the insertion of a linear band of improvised pedestrian space into an existing vehicular corridor. Adjacent to the tactics of creating open streets and intersection repair, an urban stitch can move in and out of a city's street fabric and may create a recurring pattern across various lengths. Within the thickness of the stitch itself, the tactical urbanist can facilitate interaction amongst pedestrians through the incorporation of seating, games, gardens, works of public art, or other elements that invite participation or engagement.

The second strategy is patching, which entails the creation of public space infrastructure or curation of public artworks as a patch temporarily overlaid onto a significant void in the urban fabric. Patching can be used to address the types of open areas denounced by Jane Jacobs as “border vacuums” (Jacobs 1961, 257), which are often created by the uninhabitable edges of major infrastructural elements, single-use zones, or when large and inactive open spaces (like vacant lots) create inhospitable borders between neighborhoods. Patching can also temporarily alleviate discontinuity of building fabric by creating, through graphic or other means, the impression of connectivity between disparate elements in the urban environment. Patching can take place across horizontal and/or vertical surfaces and can serve as a way of temporarily editing disruptions in the urban ground plane or across building facades to refresh what Léon Krier referred to as the “skin of public space.” (Krier 1978, 41)

Lastly, the notion of mending can be used as a conceptual framework for repairing frayed social conditions within the urban fabric. Mending does not operate through overtly physical means and refers instead to the intentional activation of social structures through the introduction of performance or event-based practices in the urban environment. Mending as a tactic relies fundamentally on actions, rather than physical artefacts or objects alone, to encourage healthy cross-use of a district, neighborhood, or undervalued space in the city. This strategy, as with patching and stitching, invites the performative, event-based, and participatory logic of contemporary public art to serve as a means for community engagement or as a generative device for urban design and planning.

REFERENCES

- Barnhart, R. 1999. *Chambers Dictionary of Etymology*. New York: Chambers.
- Bufalini, L. Nolli, G. 1761. *A description of ancient Rome, containing a short account of the principal buildings, places, &c. noticed in the annexed plan of that city, drawn from an actual survey*. London: Knapton.
- Cerdà, I. 2018 (1867). *General Theory of Urbanization*. Barcelona: Actar.
- Corbuser, L. 1973 (1943). *The Athens Charter*. New York: Grossman.
- Courage, C. McKeown, A. 2019. *Creative Placemaking: Research, Theory and Practice*. New York: Routledge.
- Engels, Friedrich. 2000 (1845). "The Great Towns." *The City Reader 2nd Ed.*, edited by LeGates, R.T. and Stout, F., London and New York: Routledge, 46-55.
- Geddes, P. 1918. *Town Planning Towards City Development: A Report to The Durbar of Indore*. Indore: Holkar Stato Printing Press.
- Gehl, J. 2011 (1971). *Life Between Buildings*. Washington DC: Island Press.
- Jacobs, J. 1961. *The Death and Life of Great American Cities*. New York: Vintage Books.
- Krier, L. 1977. *The City Within the City*. Tokyo: A + U, Special Issue, November, 69-152.
- Krier, L. 1978. *The Reconstruction of the City*. Original Source Unknown.
- Lydon, M. 2012. *Tactical Urbanism 2*. New York: Self-Published.
- Lydon, M. Garcia, A. 2015. *Tactical Urbanism: Short-term Action for Long-term Change*. Washington DC: Island Press.
- Palladio, A. 1965 (1570). *The Four Books of Architecture*. New York: Dover
- Pathak, A.N. 2019., “A case for human-scale social space in Mumbai.” *Creative Placemaking: Research, Theory and Practice*. edited by Courage, C. and McKeown, A., New York: Routledge, 69-80.
- Rowe, C. Koetter, F. 1978. *Collage City*. Cambridge: MIT Press.
- Sitte, C. 1945 (1889). *The Art of Building Cities*. New York: Reinhold.
- Smithson, A. 1968. *Team 10 Primer*. Cambridge: MIT Press.
- Smithson, A. 1977. *The City Centre Full of Holes*. London: Architecture Association Quarterly, no. 2–3, 4–23.
- Thompson, K. 1976. *Auguste Comte: The Foundation of Sociology*. London: Nelson.
- Trancik, R. 1986. *Finding Lost Space: Theories of Urban Design*. New York: Van Nostrand Reinhold.

- Tyrwhitt, J. 1947. *Patrick Geddes in India*. London: Lund Humphries.
- Van Der Ryn, Cowan S., S. 2000 (1995). "An Introduction to Ecological Design." *The City Reader 2nd Ed.*, edited by LeGates, R.T. and Stout, F., London and New York: Routledge, 519-527.
- Van Bavel, J. 2013. "The world population explosion: causes, backgrounds and projections for the future." *Facts Views Vis Obgyn*. 5(4): 281–291.
- Waldheim, C. 2006. *The Landscape Urbanism Reader*. Princeton and Oxford: Princeton University Press.
- Waldheim, C. 2016. *Landscape as Urbanism: A General Theory*. Princeton and Oxford: Princeton University Press.
- Wittkower, R. 1949. *Architectural Principles in the Age of Humanism*. London and New York: WW Norton.
- Wright, F.L. 1932. *The Disappearing City*. New York: William Farquhar Payson.
- Wright, F.L. 2000 (1935). "Broadacre City: A New Community Plan." *The City Reader 2nd Ed.*, edited by LeGates, R.T. and Stout, F., London and New York: Routledge, 344-349.

The Powerhouse, a community-based adaptation of an industrial building

Gernot Riether¹

¹Hillier College of Architecture and Design, New Jersey Institute of Technology (NJIT), Newark, NJ

ABSTRACT: Industrial buildings are often just preserved if they are easy to adapt for commercial use. But what if an industrial building is difficult to adapt but significant for its community? This paper will use the Jersey City Powerhouse as a case study to illustrate the motivations of adaptive reuse projects in a consume driven culture and speculate with strategies to make an adaptive reuse project more inclusive by involving the community while responding to today's context of environmental, political and economic challenges, the pandemic and megatrends such as digitalization. The paper will contrast its inclusive approach with a previous developer driven attempts to adapt the building and illustrate how engaging the local community in the process can result in a feasibility study of creative possibilities to reuse an industrial infrastructure as an infrastructure that empowers its community.

KEYWORDS: Adaptive Reuse, Industrial Heritage, Community Engagement

INTRODUCTION

The disappearance of industrial processes from industrial nations left a fast number of vacant factories, warehouses and powerplants. Particularly in the last 20 years they were transformed into cultural venues, housing or public spaces around the world. A power station in London became the Tate Modern Museum, gasometers in Vienna, Austria were converted into housing, the Zollverein coal mine industrial complex in Essen, Germany was transformed into a cultural center, a Polish textile manufacturing complex became Manufaktura, a mixed-use facility that contains hospitality, cultural and commercial functions and a slaughterhouse in Shanghai was transformed into a shopping mall. Such projects have now become the standard bearers of industrial conversions. Since industrial buildings and infrastructures present a more recent part of history, a critical discussion of which buildings should be preserved, motivations behind that process, programing strategies and architectural execution of adapting industrial buildings is essential for their place in the future.

1.0 THE HISTORY OF THE POWERHOUSE

Jersey City's Powerhouse was a powerplant and control center of the first subway system that connected New Jersey with Manhattan. It's opening in 1908 marked the realization of a dream which had occupied the minds of engineers for nearly half a century, connecting Jersey City, historically an industrial center, and Manhattan with an underground subway, operated remotely and powered by electricity.¹

In 1908 the Powerhouse dominated the industrial landscape of the Jersey City riverfront that was densely packed with piers, ferries, a railroad infrastructure and warehouses. The massive volume of 180' by 220' in plan and about 100' in height sat next to the river on a four feet thick concrete platform that protected it from tide water. Its architecture is a merge of an industrial material language of brick and steel with a Romanesque Revival style usually used for churches. The most dominant features of its facades were five story tall windows of wire glass that were held by steel frames and gilded with terra cotta. An elaborate tapestry caped the entire perimeter of the structure's parapet.² Four smokestacks raised 50' above the roof. During its only 20 years of operation it was by far the tallest building at the bank of the Hudson River where it represented a far larger industrial infrastructure that was mostly hidden underground.

The building was a showcase of the improved electrical machinery it contained³ and a powerful demonstration of technology: electricity as a form of energy and the possibility to remote control a vast infrastructure from a single point. As one of the greatest large-scale engineering feats of the era the Hudson tunnels were declared a National Civil Engineering Landmark in 1978 by the American Society of Civil Engineers. In the 1990s, the Powerhouse was cited by Preservation New Jersey as one of the state's ten most endangered historic sites. In 2001 it was added to the National Register of Historic Places for its significance in architecture, engineering, and transportation.

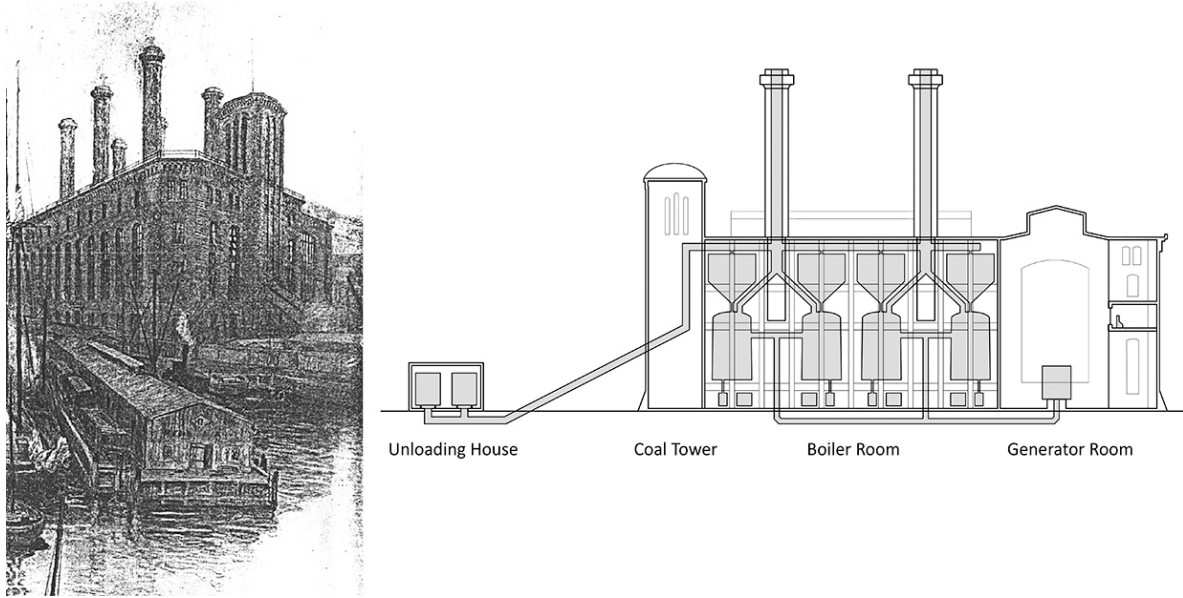

Figure 1: View of Powerhouse from Hudson River (1910) Source: Nat. Register of Historic Places National Park Service (2001) and diagram of it in operation (1906-1929) Source: Gernot Riether

2.0 A FAILED ATTEMPTS OF ADAPTIVE REUSE

In 1929 Hudson & Manhattan Railroad found that it was cheaper to purchase electricity from outside and almost unnoticed the Powerhouse was shut down. For many years the Powerhouse and the industrial buildings around it were abandoned. Zoning was established to make it attractive for artists to take over the abandoned industrial warehouses and developers started to speculate and turned the riverfront of Jersey City into high-end residential area. In the 1990s Jersey City went through a large development boom and rapid, often unchecked growth caused the destruction of many historic buildings in Jersey City. In 1999 Jersey City residents started to meet and discuss ways to manage the threat.⁴ These conversations lead to the idea of the Jersey City Landmarks Conservancy (JCLC)⁵, an organization that is promoting the protection of Jersey City's historic buildings.

In November 2004, the City Council voted to designate a Powerhouse Arts District, an 11-block area around the Powerhouse for affordable housing.⁶ In 2009 Mayor Jerramiah T. Healy announced plans to transform the Powerhouse into an entertainment and retail center.⁷ Following the model of "Powerplant Live" an adaptive reuse of a powerplant in Baltimore.⁸ The ambiguous 100-million-dollar project was set in motion in 2011.⁹ Also, this project would have followed a common strategy of turning an industrial buildings into profit, the project was rejected by the community, especially the art community and was eventually abandoned. At the same time developers challenged the city's Powerhouse Arts District's stipulations and found ways to develop the properties around the Powerhouse with out of scale high-rise towers. Many of the few historic significant buildings within the district were destroyed and the idea of the Powerhouse district seemed to only exist on paper.¹⁰

These developments triggered an outcry from the community and the Powerhouse Arts District Neighborhood Association (PADNA)¹¹ was founded in 2006. Its initiatives try to preserve the very few remaining historic structures in the district and in particular the Powerhouse. At the same time many artists that lived in the neighborhood before had moved out leaving an Art District without any large-scale art venue. The idea was born to turn the Powerhouse into an art venue instead of an entertainment center. PADNA teamed up with the city and approached large art venues in the Metro New York area as potential investors. Many large institutions including Cooper Hewitt, the Guggenheim, MoMA, Morgan, Smithsonian and the Whitney Museum were contacted. The model for the project was PS 1¹², an art institution in Queens that is an offshoot of the Museum of Modern Art in Manhattan. But the institutions did not show interest, did not have the funds to expand to another location or simply did not see fit.

3.0 CURRENT CONDITION

Today almost none of the often historically significant mid-nineteenth and early twentieth century industrial structures that had surrounded the Powerhouse at the bank of the Hudson river survived the radical redevelopment of this area. Landfills used for new developments along the bank of the Hudson river had moved the river away from the Powerhouse. Large high-rise apartment buildings around it make it appear small. A light rail train that only passes it a few feet from its walls makes it visible for many Jersey City residents.

An analysis of the current condition showed that the 28" brick exterior walls are in a surprisingly good condition. The boilers, turbines and most of the other machinery were removed over time. The heavy steel beams and columns of the Boiler Room still exist. They have 75% section loss due to corrosion. Removing them would exceed the cost for a financially sustainable adaptive reuse project. At the same time the spacing of the columns is too tight for a typical spatial adaptation. The roof was removed after it leaked and the smokestacks that were also supported by the heavy steel structure of the Boiler Room had to be removed as well.

This assessment made clear that the Powerhouse is in a category of industrial buildings that is far more difficult to convert than warehouses or other structures and is therefore at risk to be neglected, underutilized or simply demolished. Its development therefore requires attention to its historic relevance as a powerhouse for the first subway that connected New Jersey with New York and its role as a landmark for residents of Jersey City. Comparing the cost of stabilization to the cost of demolition shows that funding has to be raised in any case scenario. The massive 28" thick brick walls and heavy steel structure inside combined with raising demolition costs may save the Powerhouse from being demolished. On the other hand, its stabilization can be financed by finding creative new ways to insert program into the dense steel structure and expanding the volume.

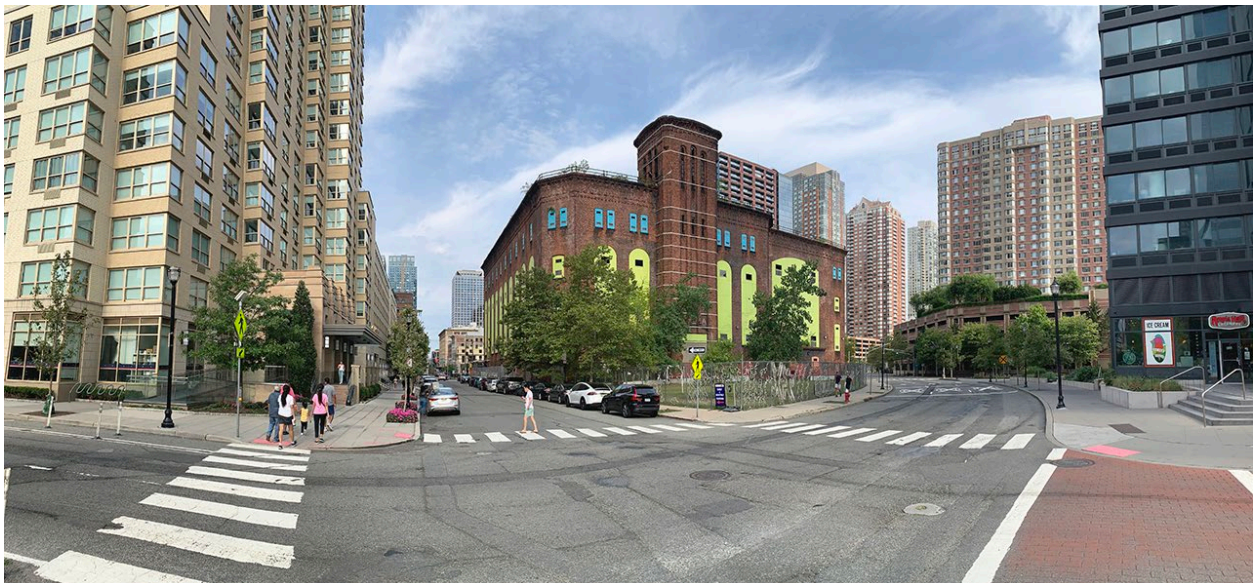

Figure 2: View from Greene Street showing the Powerhouse in today's context. Source (Gernot Riether)

4.0 COMMUNITY ENGAGEMENT

In 2022 a grant for a feasibility study conducted by Gernot Riether and an effort to generate community awareness by Kevin Shane, board member of the Arts District Neighborhood Association and Ben LoPiccolo, expert in adaptive reuse of historic buildings in Jersey City came together to find a new approach. The key idea was to combine the idea for an art venue with a program that would serve the local community in multiple ways and to develop a program that would generate enough revenue to make the project financially sustainable. A feasibility study was started in 2022 as a process that engaged the community which allowed for a program to emerge from an inclusive discussion. To draw attention to the project and to engage as many residents as possible in the process a series of initiatives were started in 2022: Social media feedback campaigns in collaboration with Community Organizations, the Power House Art Collection and conversations and discussions with Jersey City residents, businesses and art organizations where at the core.

4.1. Social Media

Social media platforms of the Community Organizations and the city were used to reach out to the community to get an idea of what Jersey City residents think about the Powerhouse and what they think the city should do with it in the future. Together with members of the Art District community and city officials a series of questions were developed to provoke ideas and discussions. Social Media posts such as a graphic of the Powerhouses with a big question mark or simple questions such as "How can the Powerhouse empower Jersey City," or "What would you like to see here?" produced the most responses. Posts on community pages and the major's social media resulted in 20 to 700 comments per post. Examples of suggestions include a museum, as there is no larger art venue in the art district, restaurants, affordable housing as rent is out of control, an urban farm, a learning center for kids, a training center for entrepreneurs, a market, a children's museum, a school, a flagship store for Apple or Google, an event space, a space for food festivals, studios for artists, a convention center, a bookstore, a library, a community engagement center, cafes, courtyards, spaces for art, a garden, a gym, a parking lot, a home for veterans, a theater, a swimming pool, a skatepark to just name a few.

The answers also reflected that a significant part of the population of Jersey City are immigrants. References were often made to projects outside the United States. Immigrants from India for example would reference industrial projects from the same period that they know from their home country. Jersey City's population increased, and demographics changed. As the area around the Powerhouse was not residential before; most of its new neighbors have only recently moved here and 41% of them are immigrants.²⁰ From their point of view the remaining structure of the Powerhouse is a found object that someone may associate with its past as a relic from industrialization but most do not know the details of its historic relevance in engineering and architecture or how it operated and what it represented to the workers that worked there 24/7. Most residents had just found the structure in their new neighborhood and wonder what it is, a large brick block with large openings covered by yellow wooden boards, the interior completely invisible - a mystery for the public.

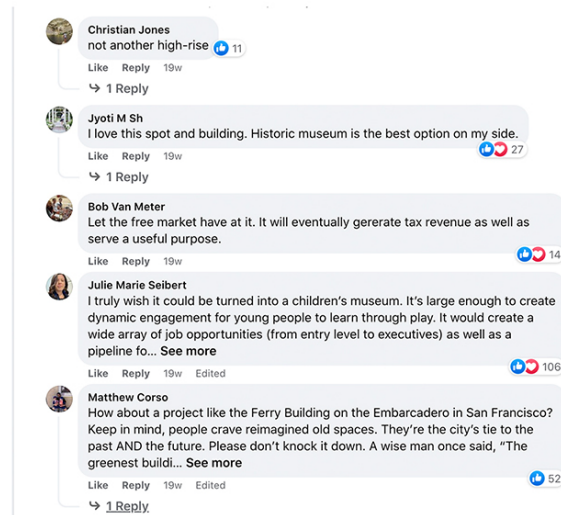
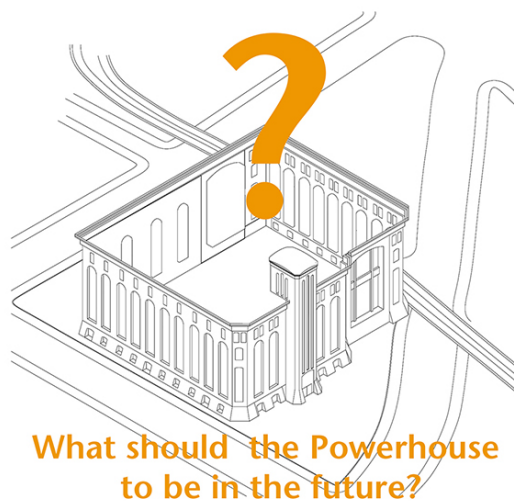

Figure 3: Facebook Post and responses. Source: (Graphic by Gernot Riether 2023, FB page of Mayor Steven Fulop)

Asking the community showed that most immigrants associate the structure with memories of industrial structures that they know from their home country. Memories from somewhere else are now projected on the Powerhouse. A space that immigrants associate with their culture. The feedback from the community revealed that the Powerhouse over recent years became a container of memories beyond its own history.

The international demographics of Jersey City was also reflected in the case studies residents suggested on Facebook. A few examples from that list include M. Herrera Jasey, who would like to see “Something like Fábrica de Arte Cubano in Cuba” while M. Meisel would like to see “Something like Borough Market in London.”

Social Media was also used to draw attentions to the project through “The Powerhouse Art Collection,” an initiative that was started by Kevin Shane to trigger conversations and help to gather feedback from the community. Local artists were asked if the Powerhouse can be the subject or the canvas for art to provoke cultural change and address issues such as inequality, racism, supremacy or ignorance. Discussions with local artists also resulted in art telling the story of the Powerhouse and speculations about its future. Shaheen Yadav, a local Jersey City artist, for example, showed a possible future of the Powerhouse through her paintings and an independent filmmaker is working on a documentary. Using the Powerhouse as an art project and connecting it to larger issues helped to create awareness. The online presence of their work, events and art exhibitions and the conversation about the Art District and its Powerhouse made the Powerhouse a topic of conversation in the arts community. Even if most of the artwork is not tangible in the physical space, it has the power to change the way the community sees the Powerhouse, recognizes its potentials and gets engaged in a creative process and a debate about the structure's transformation. Events of the Powerhouse Art Collection were held to keep the conversation alive.

4.2. Conversations

Conversations between an expanding group of people from the community of Jersey City, a demographic that had dramatically changed in recent years helped to address changing conditions, needs and desires. Events were held to discuss local issues that could be addressed through a transformation of the Powerhouse but also larger trends accelerated by the pandemic and economic developments and how they could translate into ideas for programming the Powerhouse. Conversations and meetings were held between Jersey City Landmarks Conservancy, the Powerhouse Art District Neighborhood Association, the city, developers, educators, local businesses and residents. Site visits were organized and the outcome of discussions of various groups shared.

NPO art organizations that provide platforms for local artists were asked for ideas to transform the Powerhouse into an anchor for Jersey City's art community. Conversations with the Jersey City Theater Center for example made clear that what the art community would like to see is a year-round production home for artists that plays an important role in its community. A place that makes that diversity visible and a place that brings the community together through art. A place from the people for the people, a space for art that everyone in the community feels comfortable at. 24% of the population in the US are visiting art venues such as museums or galleries.¹³ Rather than compete with large cultural institutions in the Metro New York area for the 24% strategies were developed to create a welcoming space for the remaining 76%. With the input of NPOs concepts were developed for an art space to operate in a much broader sense; be it through education, an event space for public and private gatherings, or markets.



Figure 4: Representatives from Jersey City's community organizations inside the Powerhouse. Source: (Gernot Riether 2023)

From the conversations, events, debates and discussions with the community a series of concepts and ideas for adaptive reuse program for the Powerhouse emerged.

The Powerhouse as a connection to history: A lot of books are celebrating adaptive reuse projects as successful if they give an old structure a fresh revitalizing look. Also, projects may result from a very careful architectural engagement with existing buildings at a formal, material and detail level the relationship between the original program of the historic building and the program used in its adoption is often not the main subject of critic. Is it appropriate for instance to adapt an industrial building that may represent exploitation in its original use for a place for fun and pleasure to a degree that a reading of its memory that it contains becomes impossible? The intention of the Powerhouse adaptive reuse project is to celebrate its history as an outstanding industrial achievement of its time.

The Powerhouse to empower the community: The idea of adaptive reuse in a consume driven culture seems to be to retain heritage but at the same time attract people and make money. The idea is that entertainment and commercial programs create a destination, an escape from everyday life that is exciting for tourists and residents alike as they create a contrast to the everyday routine. This approach was used and had failed in 2009 as discussed earlier. In contrast an approach was developed that would integrate it into everyday life by providing services to the residence and programs that make the Powerhouse part of everyday life of the community around it.

The Powerhouse as service infrastructure: Prior to the pandemic the Powerhouse was envisioned to become a mixed-use project for art, retail stores, galleries, markets and offices, a typical mix of program for industrial adaptive reuse projects of a similar structure and scale. A program therefore was developed to serve the community from a fitness center to schools to spaces for health and human services. Such public programs can also be shared with the program of a health infrastructure and as amenities for housing.

The Powerhouse as health infrastructure: In recent years the COVID 19 pandemic had changed the way of thinking about adaptive reuse projects. The first years of the pandemic triggered a peek in adaptive reuse: Existing structures such as gymnasiums were transformed into vaccination centers, car washes were adapted as drive through testing sites and hotels were used as homeless shelters. Also, most of these transformations were temporary some became permanent. Jersey City is planning to expand health services for the community, especially immigrants through the Division of Immigrant Affairs and the Department of Health and Human Services.¹⁴ and immigration legal services program for refugees.¹⁵ The Powerhouse would be an ideal location to house such an infrastructure.

The Powerhouse to support affordable housing: Typically, the program used to make industrial buildings such as the Powerhouse financially sustainable is of a commercial nature. The pandemic had accelerated online shopping, many stores went bankrupt. Currently investing in new spaces for stores is too risky and financially not attractive. Instead of commercial functions the suggested strategy is to use affordable housing to make it financially sustainable, not just to follow the Powerhouse Arts District's stipulations that states to include ten percent affordable housing in new developments but exceed the stimulation through affordable housing funds. The program of micro units, shared office space, online meeting rooms, a broad choice for work environments, shared launch spaces, open office spaces, studios or more formal offices was mixed with a public program of markets and restaurants that can serve the community around the Powerhouse.

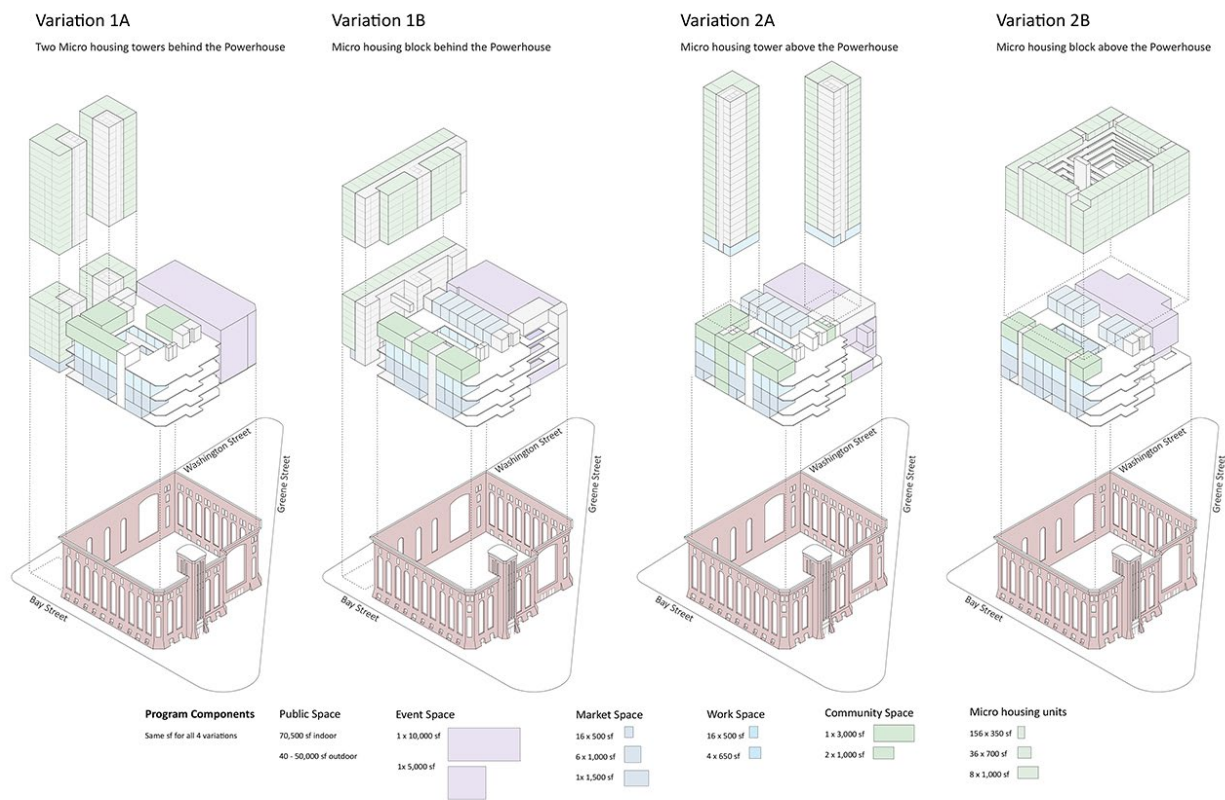

Figure 5: Programming strategies in response to community needs. Source: (Gernot Riether 2023)

5.0 A NEW PROGRAM FOR THE POWERHOUSE

From the community feedback and the programs that emerged from it the study analyzed the financial sustainability of program components and program relationships. As a result, six categories of programs were developed: Public Space, Market Space, Community Services, Work Space, Housing and Event Space. The study shows that in order to reach a point to make the project financially sustainable one has to extend the square footage of the project significantly. From that calculation the program was expanded with 80,000 sf Housing that was connected to 27,000 sf Public Space that is open and enclosed and could be utilized by art installations, events or a farmer's market. 10,000 sf Market Space

that included restaurants, cafes, and grocery stores, 7,000 Community Space for services that included a health service center, space for educational programs and facilities such as a gymnasium that could be shared by the public and used as an amenity for the housing component, 7,000 sf Work Space that include a wide range of work environments for firms, startups, artists and work spaces for residents that are working from home, and an Event Space.

The historic value in the Powerhouse is not just its façade but also in the character of its interior spaces that consists of two volumes of radically different condition, the Boiler Room, that is occupied with a massive and dense steel structure that would be too expensive to remove and the Generator Room that is a large open space. Different strategies had to be developed to superimpose programs onto the two different spatial conditions of the existing structure.

The Boiler Room consists of 4 floors packed with a tight grid of columns and beams. Program types that could be broken down into small components such as market spaces or offices could be inserted into the dense steel structure. Leaving an opening in the center provides daylight, space for circulation and visual vistas of the existing structure. A lightweight structure that is woven through the heavy steel grid does not claim to be monumental but instead contrasts the preserved heavy historic steel structure. This superimposition of realities creates a dream space that allows the visitors to be engaged with the new function but at the same time be caught up in the memories of the original industrial space. For the large open volume of the Generator Room two different strategies were explored. The first strategy was to use the entire volume as one large multipurpose event space. The second strategy was to divide the space into two or a series of event spaces. Differentiating these volumes in program, the Boiler Room as Market space and the Generator Room as Event Space allowed to maintain the different characteristic of spaces.

Both, the Boiler Room or the Generator Room could not be used as residential space without major interior demolition and reconstruction that would be too expensive and not sustainable and would destroy the appearance and character of the industrial space. There are also not enough apertures in the existing building envelop to provide enough daylight for apartments. The program of apartments was therefore used to extend the volume. Different schemes were developed to extend the volume vertically or horizontally. Adding on horizontally and utilizing the left-over spaces of the site around the building proved to be more affordable but also allowed for less changes of the interior of the historic building. Adding on vertically and utilizing the air rights of the building allowed to maximize the open spaces of the site around the building for public space and did not change the visibility of the façade of the buildings.

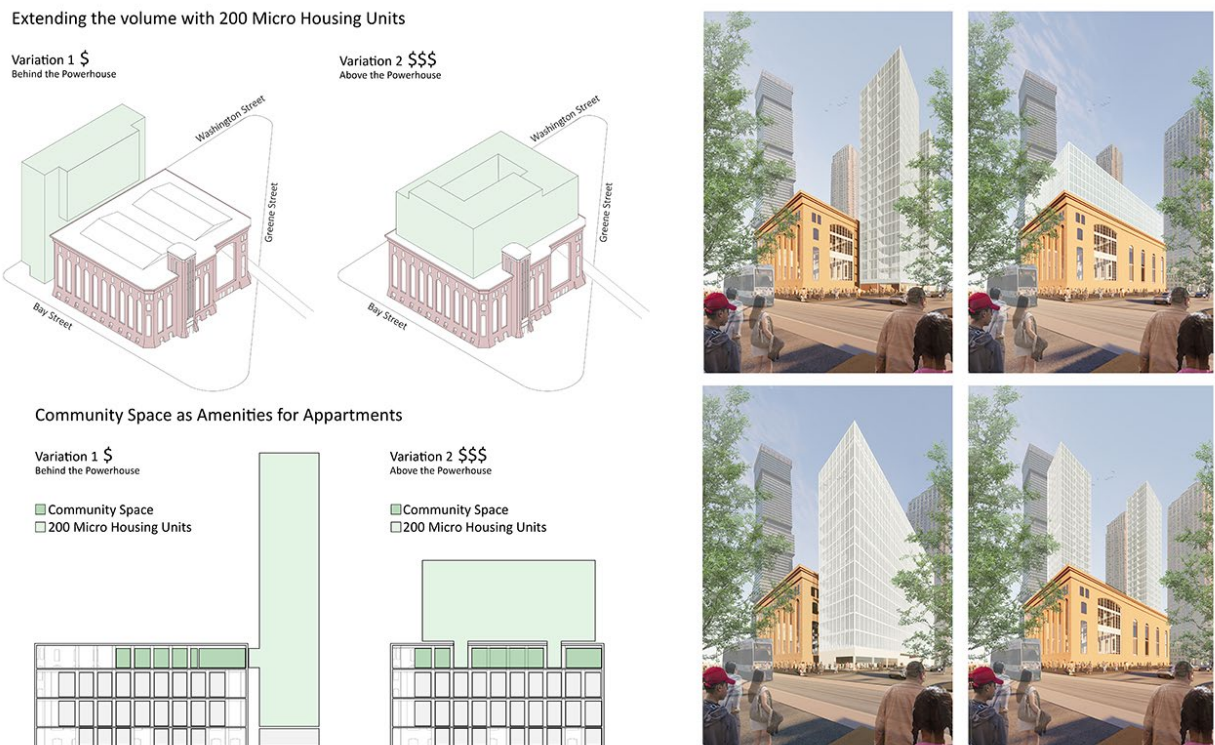

Figure 6: Add on strategies for micro housing units. Source: (Gernot Riether 2023)

All amenity and support spaces for the apartments were located within the existing volume of the Powerhouse and connected with a bridge to the historic building. Currently the Powerhouse is an object disconnected to its context which during its operation was not the case. When the Powerhouse was a powerplant the volume of the building was physically connected to a larger infrastructure around it such as the coal-unloading house or a sloping coal belt conveyor bridge was attached to the coal tower of the building. All of that infrastructure around it was demolished over

time. By building next to it and connecting to the Powerhouse programmatically and physically through bridges would recreate these historic connections.

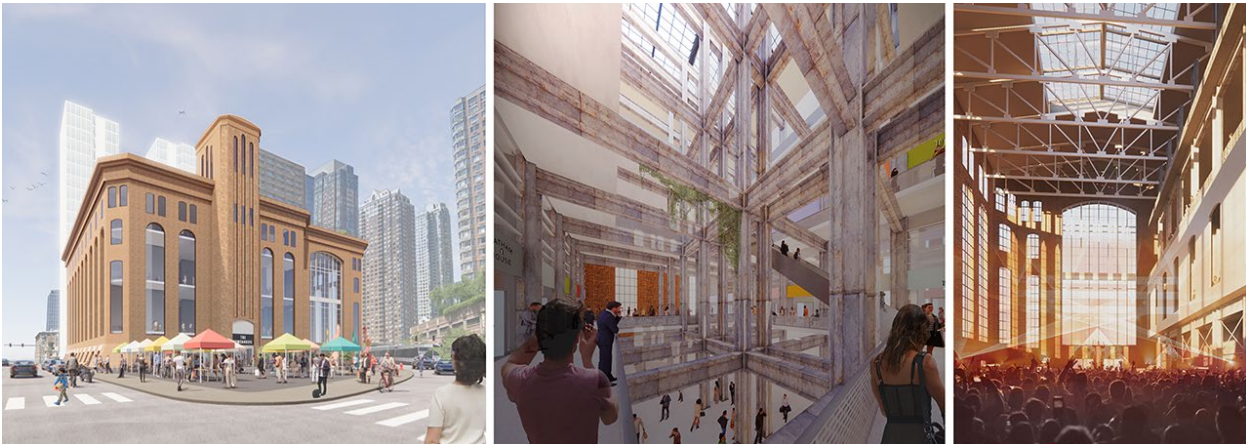

Figure 7: Exterior view from Greene street and interior views of a Boiler Room transformed into a Market Space and the Generator Room transformed into an Event Space. Source: (Gernot Riether 2023)

CONCLUSION

Buildings that are easy to adapt are not always the ones that are of most historic significance. Leaving adaptive reuse up to investors is no guarantee that buildings with the most significant historic value will survive. The Powerhouse proved to be difficult to adapt as its interior is filled with a dense massive steel structure that can't be removed and opportunities to superimpose the historic structure seemed to be limited.

Adapting the Jersey City Powerhouse had failed in the past as its proposed commercial program was rejected by the community. In contrast a new inclusive approach shows that a more successful strategy for its adaptation can emerge from a process that starts with the community rather than an investor and is driven by the community and partnerships with a wide range of local organizations and businesses. That way a program was developed that is customized for a specific community without following the previously used investor formula. This more inclusive approach revealed the meaning the current industrial ruin has to its community. It also allowed to develop a strategy to respond to shifting local needs of a community that had changed during recent trends and developments such as the pandemic, changes in the economy and demographics, and needs of services to its community.

Extending the existing volume horizontally or vertically with affordable micro housing units and connecting it programmatically to the existing structure allowed for strategies to use a left-over site that would typically be too narrow to develop. This became a key component for making the project financially sustainable. Within this approach spaces were developed that could serve multiple purposes: A gym for example is used as amenity for the housing project, at the same time it is available to the public and connected to health services. A space for education for example can be shared between preschool programs, workshops, a space for a dance school and practice room for a local opera singer.

The grant will be completed in 2023. The city will gain full ownership and control over the site in 2026. The outcome of the grant provides a better understanding for different opportunities to superimpose and extend the existing structure with new program that is specific for its community and needs. Beside an analysis of the existing structure and financially sustainable adaptation strategies the feasibility study also created a momentum for the project and helped to increase the chances for the Powerhouse to become a productive actor in the life of Jersey City.

The process of the feasibility study shows the necessity for adaptive reuse project to start with the community and involve the community throughout the entire process to allow for the community to connect to the history of the place and at the same time develop a vision for it that can serve the community in the future.

ACKNOWLEDGEMENTS

Gernot Riether project team: Samantha Volpicella and Abdurahman Oudeh
 Community Outreach: Kevin Shane, board member of the Arts District Neighborhood Association
 Consultant: Ben LoPiccolo, BLDGup, Ben LoPiccolo Development Group, LLV

ENDNOTE

¹ New York Times. 1. February 26 1908.

² National Register of Historic Places. NPS Form. October 1990.

- 3 Jersey City, Evening Journal. p 3. October 6.
- 4 <https://jclandmarks.org/about/history/>, accessed at 10/10/2022.
- 5 Jersey City Landmarks Conservancy (JCLC), <https://jclandmarks.org/>, accessed at 10/10/2022.
- 6 <https://archive.hudsonreporter.com/2010/09/19/powerhouse-phase-one-done/>. accessed at 10/10/2022
- 7 https://www.nj.com/news/2011/09/jersey_citys_washington_street.html, accessed at 10/10/2022
- 8 <https://www.powerplantlive.com/>, accessed 10/10/2022
- 9 https://www.nj.com/hudson/2009/06/jersey_city_powerhouse_buildin.html , accessed at 10/10/2022
- 10 <https://archive.hudsonreporter.com/2010/09/19/powerhouse-phase-one-done/>, accessed at 10/10/2022
- 11 Powerhouse Arts District Neighborhood Association, <https://www.padnajc.org/>, accessed at 10/10/2022
- 12 MoMA PS1, <https://www.momaps1.org/>, accessed at 10/10/2022
- 13 <https://www.amacad.org/>, accessed at 10/10/2022
- 14 <https://www.jerseycitynj.gov/news/pressreleases2020/jcsetsnationalprecedentshiftsimmigrationnarrative>, accessed at 10/10/2022
- 15 <https://www.insidernj.com/press-release/>, accessed at 10/10/2022

Third Places, Health and Urban Design: Lessons from a Cross-Sectional Study on Neighborhoods and Blood Pressure Among Parsis in Mumbai

Hitakshi Sehgal¹, William A. Toscano¹

¹University of Minnesota, Twin Cities, MN

ABSTRACT: The exposome, all environmental exposures, including built, natural and socio-cultural components, affect human health and disease outcomes via diverse pathways that have been scarcely researched. Third places in urban areas encompass sociospatial opportunities and exposures that are indispensable to health. Third places, an alternative to digital entertainment within walking distance of the home, are fundamental to 'smart growth'. Smart growth focuses on liveability of spaces and reducing automobile dependence. With rapid urbanization, digitalization of socio-cultural and entertainment opportunities, the ability to travel for socializing and increasing automobile dependence, third places in urban areas have shrunk. Low- and middle-income countries are experiencing rapid urbanization and there is a gap in research on the health outcomes from diminished access to third places in urban areas of these countries. Walkable access to third places from the home makes them integral with neighborhood environments. We conducted a study to assess neighborhood environments and their effect on blood pressure in the Parsi communities residing in four types of neighborhoods in Mumbai. We used the Neighborhood Accessibility Framework to assess people's perceptions of accessibility to daily needs within their neighborhoods. In this paper, we discuss the results of our study with respect to people's access to third places. The study included 774 females and 756 males in the age group 19–53 years. Eight questions in the questionnaire related to the participants access to third places. Our results indicate that overall, participants perceived poor access to third places, and the neighborhoods where residents perceived diminished access to third places, were associated with poor health outcomes. Third places are critical to a healthy urban lifestyle and influence other factors of surveillance, streetscape and experience in a neighborhood. This paper provides evidence for the inclusion of third places in the design of urban areas for sustainable development.

KEYWORDS: third places, health, urban, neighborhoods, LMICs

INTRODUCTION

1.1 Third Places and Sociospatial Opportunities

The term and concept of 'Third places' was envisioned by Ray Oldenburg, an urban sociologist, in the late nineties (Oldenburg 1997) when urban development was informed by 'new urbanism'. New Urbanism proposed changes to suburban development with an approach to enhance population density, diversify land use and promote walkability in itself, as well as to reduce automobile dependence (Ellis 2002; Atash 1994; Bosman and Dolley 2019). Research indicates that suburban development is over reliant on automobiles and lacks places for socializing, which is reflected in the discussion on vanishing third places (Atash 1994; Oldenburg 1997; Bosman and Dolley 2019; Sehgal and Toscano 2021). Third places are termed as such because we seek them outside of our routine at home, the first place, and work, the second place. In the order that people prioritize places, home is the first place, work is the second and third are places that give people freedom from routine responsibilities, which allows them to recreate (Jeffres et al. 2009).

Limited research publications on third places have restricted debate and discussions on the criteria that qualify a third place. In the featured article, 'Our Vanishing Third Places' (Oldenburg 1997), Oldenburg identified two criteria, a convenient location and the provision for socialization, that qualify a third place. The concept of promoting third places is in tandem with the idea of walkable local places and it explores the 'sense of community' in an urban neighborhood (Oldenburg 1997; Németh and Schmidt 2010; Jeffres et al. 2009; Sehgal and Toscano 2021; Sehgal 2022). The social fabric of a place builds over time, to create an environment that invites participation. At the outset, third places should be incorporated in planning an urban neighborhood so that people can casually walk there due to the time-effective location, not feel the need to use an automobile and socialize at ease (Jeffres et al. 2009). This has positive implications for the health of people as well as for the neighborhood to flourish (Oldenburg 1997; Sehgal 2022; Sehgal and Toscano 2021). The walk and the place together support a healthy exposome that promotes physical, social and mental well-being for individuals and communities (Sehgal and Toscano 2021; Sehgal 2022). We use the word exposome because it includes every exposure that we experience (Toscano et al. 2014; Sehgal and Toscano 2021; Sehgal 2022) while the term 'environment' can be restrictive as people tend to associate it with physical components such as air and pollution. Figure 1 is a word cloud image of an exposome and the exposures it includes. In an urban area, neighborhood exposome is at the cusp of the micro-exposome, the home and the macro-exposome, the city. Within the neighborhood,

third places effectively facilitate a socio-cultural environment for people to avail sociospatial opportunities that are not domestic or for business purposes (Jeffres et al. 2009). Third places simplify neighborly interaction to provide neutral grounds without the burden of hospitality and allow everyone with a multitude of choices for things to do or to simply be there (Jeffres et al. 2009). Thus, as third places evolve in a neighborhood, they provide sociospatial opportunities, promote community building, social cohesion and social capital (Williams 2019; Oldenburg 1997; Putnam 2001; Sehgal and Toscano 2021; Sehgal 2022).



Figure 4: The Exposome includes every environmental exposure (Source: The Authors).

Oldenburg emphasized the need for third places as an alternative to the television. He criticized the television as a source of entertainment because of the sedentary lifestyle it inveigled, the lost opportunities for people to interact among themselves and its invasion on local culture (Oldenburg 1997). Today, information, entertainment, work, shopping and socialization, among other things, are all on digital platforms (Jeffres et al. 2009). The threats Oldenburg perceived have become real risk factors that affect the health of populations and are a burden on the healthcare systems especially in low- and middle-income countries (LMICs) (Sehgal and Toscano 2021). Post-the COVID-19 pandemic, quality of life in cities has metamorphosed as people adapted to the restrictions during the pandemic and the possibilities the world wide web provided. Diminished access to sociospatial opportunities and leisure have adversely affected health and well-being globally (Mouratidis 2021).

Smart growth, an idea which followed and is synonymous with new urbanism, acknowledges the challenges of urbanization in development and is promulgated as a response to the environmental effects of urban sprawl (Knaap and Talen 2005). Third places and sociospatial opportunities encourage walking, discourage automobile dependence and provide an ambience for community interaction (Williams 2019; Oldenburg 1997; Sehgal 2022; Sehgal and Toscano 2021) to support smart growth in more ways than one (Knaap and Talen 2005).

1.2. Health, Non-communicable Diseases, Lifestyle Disorders and The Urban Exposome

Non-communicable diseases (NCDs) account for 74% (41 million people) of all deaths globally, cause maximum mortality across the globe and disproportionately affect the underserved, the discriminated and LMIC populations. Of all deaths attributed to NCDs, 77% occur in LMICs (World Health Organization 2022). Young populations, those who are less than 70 years old, are at a high risk to suffer and die prematurely from NCDs; 40% of NCD deaths are premature and 86% of these occur in LMIC populations. A majority of deaths from NCDs are attributed to lifestyle disorders which include metabolic and behavioral risk factors (World Health Organization 2022). Urbanization is associated with a greater risk of NCDs and mortality from NCD related causes (Stuckler 2008; Frumkin and Haines 2019; Sehgal 2022; Sehgal and Toscano 2021)

The exposome is a greater determinant of health of populations than is acknowledged because it includes every exposure natural, built, social, cultural, economic, and others, which potentially affect health and disease (Andrianou and Makris 2018; Rappaport 2011; Sehgal 2022; Sehgal and Toscano 2021; Toscano et al. 2014). Health behaviors

and lifestyles are the sequelae of choices made in the exposome rather than in a vacuum. Our interactions with health determinants in the exposome influence our choice of behaviors, lifestyle, risk factors and the resulting health and disease outcomes. Lifestyle disorders are common complex diseases that affect a large global population, are chronic, can be inherited and although they involve multiple genes, they are mostly triggered by exposomal factors (Rappaport 2011; Tabish 2017; Sehgal and Toscano 2021). The determinants of behaviors in the exposome and the behaviors are modifiable (Toscano et al. 2014; Sehgal and Toscano 2021). The current discourse on NCDs focuses on the modification of behaviors (World Health Organization 2022), which puts the onus of change on the individuals who suffer from the disorders. This is a dual burden on the patients because the multifactorial lifetime diseases cause morbidity, induce healthcare costs, compromise their quality of life and require them to modify their behaviors in an exposome, which likely does not support healthy behaviors (World Health Organization 2022; Sehgal and Toscano 2021; Sehgal 2022). The discourse on lifestyle disorders skips mental health and social well-being for their influence on physical health and as diseases in themselves (Cuevas, Williams, and Albert 2017). Physical activity, unhealthy diet, smoking, sedentary lifestyle, physical inactivity and automobile dependence are behaviors that are associated with risk factors and lifestyle disorders such as high blood pressure, type 2 diabetes and obesity (Frumkin and Haines 2019; Rappaport 2011; Sehgal and Toscano 2021; Sehgal 2022). There is little discussion regarding design and modification of urban environments that can support a healthy lifestyle with most research being restricted to walkability (Weinberger 2012; Andrianou and Makris 2018). An inclusive approach is required to conceptualize the urban exposome for the magnitude of exposures on risk factors, behaviors and lifestyles in urban populations (Andrianou and Makris 2018; Toscano et al. 2014). Restricting the discussion to walking or studying health of populations from the perspective of their behaviors can be misleading. Poor people may walk more because they don't own automobiles or live in unplanned areas that lack public transit and rich people may walk less but be in better health because they have improved access to physical activity and healthcare. Research indicates that affluence of urban neighborhoods is a stronger index indicative of health status of residents than individual demographic factors, socioeconomic status, health insurance and behaviors. What do affluent urban neighborhood exposomes have that predicts better health of the residents? Among other factors, affluent neighborhoods have community organizations that are secured by the support of middle- and high-income residents, resources to promote a healthy exposome and the ability to informally socialize that facilitates maintenance of social control. The structure and design of affluent neighborhoods is connected by a strong social sense and sociability which influence better health outcomes (Browning 2003).

1.3 Urban Design, Third Places and Opportunities, LMICs

Third places provide the place for informal social gathering, have the potential to influence walking and walkability, social-cultural interaction and simultaneously discourage physical inactivity, automobile dependence and a sedentary lifestyle (Williams 2019; Oldenburg 1997; Sehgal and Toscano 2021; Sehgal 2022). The collective efficacy of third places to affect physical, social and mental well-being of populations has not been explored. At the interface of research and design in LMICs, urban sprawl poses some similar and other contrast challenges for third places and opportunities than in high income countries. A larger part of urban populations in LMICs live in impoverished settlements that are unplanned parts of the city (Abascal et al. 2022) and lack access to planned spaces for recreation. These settlements likely lack stable, affluent residents who have the ability to support structures and organizations to strengthen the sociocultural exposome (Browning 2003). Urban sprawl has contrasting challenges of low population density in high income countries and overcrowding in LMICs (Frumkin and Haines 2019; Sehgal and Toscano 2021; Sehgal 2022). Inadequate budgets may limit residents' access to public resources (Németh and Schmidt 2010; Frumkin and Haines 2019; Sehgal 2022). The challenges of overcrowding in megacities are augmented by poverty and insufficient public services. Overcrowding in urban neighborhoods in LMICs can be a deterrent for walking (Sehgal and Toscano 2021; Sehgal 2022), which is fundamental for access to third places. Megacities in LMICs have been addressed as 'global risk areas' due to high population density and sociospatial disjunction among other factors (Butsch et al. 2016). Most walkable cities in the world have medium density (Network 2018; Sehgal and Toscano 2021; Sehgal 2022).

The challenges of the built, natural, economical and socio-cultural environment in megacities in LMICs interpose access to third places. Diminished access to third places impinges on sociospatial opportunities and can affect physical, social and mental well-being. Across the globe, more people reside in urban than in rural areas. Forecasts of steep urbanization in LMICs predict that over two billion people will transition into urban areas by 2050 (Butsch et al. 2016). Most megacities are in LMICs, are stretched for public resources and rapid urbanization leaves little scope for smart growth that would include third places.

1.4. Research Gap

Urbanization presents unique challenges and opportunities for sustainable development in LMICs, which have significant implications for the prevention of lifestyle disorders in the populations (Frumkin and Haines 2019; Sehgal and Toscano 2021). With maximum urbanization set to happen in LMICs in the next two decades, urban planners will rely on evidence-based planning. Unfortunately, research on third places is limited in high-income countries and almost absent in LMICs. There is a need for research and debates on the pathways through which third places affect health. For example, are places of religion (temples, churches, mosques and synagogues) third places? What efforts are needed for a more equal and equitable access to third places especially in LMICs, where the burden of lifestyle disorders and urbanization are putting the populations at a high risk of a poor quality of life, preventable risk factors and premature mortality? We conducted a study in Mumbai, a megacity, to examine a pathway by which determinants of health in urban neighborhoods influence behaviors and lifestyles of residents that result in metabolic changes and make them vulnerable to high blood pressure. High blood pressure is a lifestyle disorder and the leading risk factor

NCDs (Sehgal and Toscano 2021). Among the eight determinants of health in a neighborhood, we asked participants about their perception of access to third places and opportunities. This paper discusses the participants' perceptions of access to third places in their neighborhood and the prevalence of high blood pressure in the study population. In our knowledge, this paper is the first to exclusively discuss access to third places and opportunities and its potential effects on high blood pressure in a megacity in India.

2.0 METHODS

This paper discusses data from a larger study and the methods were described previously (Sehgal and Toscano 2021). Access to third places and opportunities within urban neighborhoods, was part of the larger research study. The study was done in a single ethnic community, the Parsis, in Mumbai. In that study, we compared participants' perceptions of accessibility to determinants of a healthy lifestyle in four neighborhoods in the city of Mumbai. Participants were 1530 Parsis, 774 females and 756 males, in the age group 19–53 years. The four types of neighborhoods are, Baugs, Parsi apartments, cosmopolitan housing and the Mancherji Joshi Dadar Parsee Colony, and each is briefly described here. Parsi Baugs (BAUG) are gated communities that house a playground and a gymkhana. A gymkhana is a space adjoining the playground with provisions for social gatherings, indoor games and may include catered food. Parsi apartments (PARAP) are a stand-alone apartment building or a cluster of apartment buildings. They may be gated, but they differ from Baugs because they lack either a playground, a gymkhana, or both. The Mancherji Joshi Dadar Parsee Colony (MJDPC) is the only non-gated Parsi housing with a gymkhana and a playground exclusively for its residents. Participants who did not live within Parsi housing were all included under the umbrella of Cosmopolitan (COSMO) neighborhoods.

We examined the natural, built and socio-cultural exposures in a neighborhood using a framework of eight determinants designated as “The Neighborhood Accessibility Framework”; each participant's perceptions of access to these determinants were recorded using a questionnaire; the perceptions were quantified to compare accessibility of the four neighborhoods. The eight determinants in a neighborhood that must be accessible for a healthy lifestyle for residents are space, third places, streetscape and experience, land use, connectivity, surveillance, pedestrian safety and public transport. Thirty-one questions assessed the perceptions regarding accessibility in the neighborhood. The response to each question was relevant to one of the eight determinants for a healthy lifestyle. The participants had options of replying in a yes (affirmative), no (negative) and don't know (unaware). The ‘yes’ answers to each question were summed. The percentage of affirmative responses to each question was scaled from 0–5 and this is the affirmative response score. The sum of affirmative response scores for each determinant of healthy lifestyle was calculated and scaled from 0–10 and this is the Affirmative Perception Score. The Affirmative Perception Score (APS) is the sum of the ‘yes’ responses to all questions in the category and is scaled from 0–10 (0—least score, no accessibility and 10—maximum score, best accessibility) for the purpose of quantification and analysis. Table 1. lists the eight questions we asked participants to assess their perceptions of access to third places and opportunities within their neighborhood.

Table 1: Questions to assess perceptions of third places and opportunities; Affirmative Response Score for each neighborhood and calculation of the Affirmative Perception Score scaled from 0–10.

* APS represented above is the same as Neighborhood Accessibility Score for Third Places and Opportunities

1.	Questions	BAUG	PARAP	COSMO	MJDPC
<i>The neighborhood I live in:</i>					
1a	<i>Has cultural activities that I can be a part of</i>	4	0	0	4
1b	<i>Has an event space I can visit for theatre, arts, and cultural immersion</i>	1	0	0	1
1c	<i>Has a religious facility I can visit</i>	4	4	2	5
1d	<i>Has a library that I can use</i>	0	0	0	4
1e	<i>Has a school that my children can go to</i>	0	2	2	5
1f	<i>Has a neighborhood/ community organization that I can be a part of</i>	3	0	0	4
1g	<i>Has Children's Park/ Garden</i>	5	2	3	5
1h	<i>Is a close-knit neighborhood where everyone knows each other and socializes</i>	5	3	0	5
2	Affirmative Perception Score (APS)	22/40	11/40	7/40	33/40
3	Affirmative Perception Score* (APS) on a scale of 10	5.5	2.8	1.8	8.3

3.0 RESULTS

The participants from the MJDPC perceived the most access (APS=8.3) to third places and opportunities, followed by the residents of Baug's (APS=5.5), Parsi apartments (APS=2.8) and cosmopolitan neighborhoods (APS=1.8). For all determinants in the Neighborhood Accessibility Framework (ref. to Table 3 in (Sehgal and Toscano 2021)) cumulatively, participants residing in the MJDPC perceived most accessibility— their affirmative responses totalled to 80%, followed by residents of BAUG—72%, COSMO—61% and PARAP—59%.

In other results of the study that are relevant to third places and opportunities, 50% of the participants said they had a sedentary lifestyle; 1186 participants travelled for work (a second place in the context of this paper) and of these, 923 (78%) were dependent on automobiles, 37 (3%) said they walked to work, 225 (19%) took public transit and 335 (22%) worked at or from home.

In a detailed statistical analysis using multinomial regression, after controlling for factors that are known to cause high blood pressure, the results of our study indicate that accessibility to lifestyle factors in neighborhoods has an influence on blood pressure. High blood pressure prevalence in the study population was 21% (n=313). Fig. 2. in the paper (Sehgal and Toscano 2021) shows the prevalence of high blood pressure in participants based on the neighborhood they live in— 15% in MJDPC, 19% in BAUG, 22% in COSMO and 23% in PARAP. In neighborhoods that had weaker BP outcomes, residents perceived reduced access to third places among other factors.

4.0 DISCUSSION

The evidence provided from our study suggests that exposure and access to third places and sociospatial opportunities provided in these spaces can influence blood pressure. To the best of our knowledge, ours is the first study in India to explore a pathway by which, neighborhood determinants influence metabolism. Our results provide cutting-edge information about access to third places and the opportunities they create. These factors have previously not been studied as a part of the exposome for their influence on non-communicable diseases. The neighborhoods where residents perceived most accessibility to third places had relatively better blood pressure outcomes.

We compared the perceptions of participants from four neighborhoods. The residents of MJDPC perceived the best accessibility to third places and opportunities. The blood pressure outcomes of residents from MJDPC were better than those of other neighborhoods and they perceived better access to other lifestyle determinants in the neighborhood accessibility framework (Sehgal and Toscano 2021). Accessibility, the ease with which people go about their routine lifestyle, is an outcome of the design and planning of the environment in which people live (Németh and Schmidt 2010; Sehgal 2022; Sehgal and Toscano 2021). The MJDPC is a non-gated community and the residents' perceptions acknowledged the sound neighborhood design that led to improved mobility, social interaction and a sense of community. They perceived easy access to a religious facility, a library, a local school, a community organization and a children's park. They affirmed that they had opportunities to participate in cultural activities and that people in the neighborhood knew each other and socialized. Third places and opportunities are interdependent and this likely led to affirmative perceptions of overall access among participants. The MJDPC has a gymkhana and a playground which people can frequent anytime over a board game, a racquet game, a beverage or a snack, a walk or even just to sit with friends and chat. The local school where participants' children can go is not just an avenue for education. It is common for schools to let their playground or their gathering space to local communities for events. Residents who have children can connect with their contemporaries, parents of other children, at school during parent teacher meetings, school events or simply when they drop and pick their children. Local libraries are a place people can go to and they encompass socio-cultural information in the form of fictional and non-fictional literature, other media and they may house a book club which then builds on local culture through discussions and communication. Social communication is a fundamental process that fosters the essence of third places (Jeffres et al. 2009). In a study done about privatization of public spaces, street users expressed more concern over libraries, playgrounds and parks than about greenery and public seating (Leclercq and Pojani 2021).

The affirmative perception score of Baugs was 5.5 and compared with the MJDPC (APS: 8.3), residents perceived the lack of a library, a school and an insufficiency of a community organization that they could be a part of. The only difference between the BAUG and the MJDPC is that Baugs are gated communities. What the residents of Baugs gained in a gymkhana, playground and knowing their neighbors, they lost in the means to maximize socialization because of the structural limitations of gated communities. Their perception score indicates that a space needs design to transform it into a third place that will allow socio-cultural interaction. These perceptions are not unexpected because research suggests that gated communities can detach their occupants from socializing at different levels due to their design, which affects physical connectivity as well as social interaction at diverse levels (Kwan 2013). Evidently, residents of Baugs perceived poor access to the other determinants of connectivity, space and land use. This shortfall in accessibility was reflected in the blood pressure outcomes of participants. The participants from Baugs were not at a significantly higher risk for high blood pressure and yet their average blood pressures were higher than those in MJDPC (Sehgal and Toscano 2021).

The poor perceptions of access to third places in participants from Parsi apartments and cosmopolitan housing reflect the paucity of space and design. Participants reported insufficient access to cultural opportunities, a library, a community organization, parks and a local school that translates to restricted local mobility and the inability to build local social networks. Parsi apartments and cosmopolitan housing rely on city resources for playgrounds, parks and places such as the gymkhana. Their perceptions reflect an inadequacy in the city's infrastructure that is required for access to a healthy lifestyle. Instead, they are likely forced to adapt to the constraints, to live with restricted mobility and poor social capital that potentially harms their physical, mental and social well-being. Parsi apartments are exclusive community housing, and the residents reported fair access to a religious facility and yet reported a dearth of socio-cultural opportunities. Residents' perceptions and mapping of the Agyari's (Parsi fire temples) in Mumbai (Figure 2) suggest that the Agyaris are within walking distance of most Parsi Apartments. Residents of cosmopolitan housing reported diminished access to a religious facility and no opportunities to neighborly interaction. Third places support social cohesion in a neighborhood as people run into each other informally (Williams 2019; Oldenburg 1997). The perceptions of residents from Parsi apartments and cosmopolitan housing explain the interdependence of determinants

in the Neighborhood Accessibility Framework. These residents perceived poor access to space, streetscape and experience, connectivity and pedestrian safety in their neighborhood. Third places encourage people be out and about in the neighborhood as they enhance other accessibility determinants of surveillance, streetscape, experience and land use. The physical and social benefits of third places and opportunities along with other neighborhood determinants can decrease the risk of lifestyle disorders as was reflected in the blood pressure outcomes in this study population. Residents of Parsi apartments and cosmopolitan housing had higher blood pressures and were at a greater risk to develop hypertension.

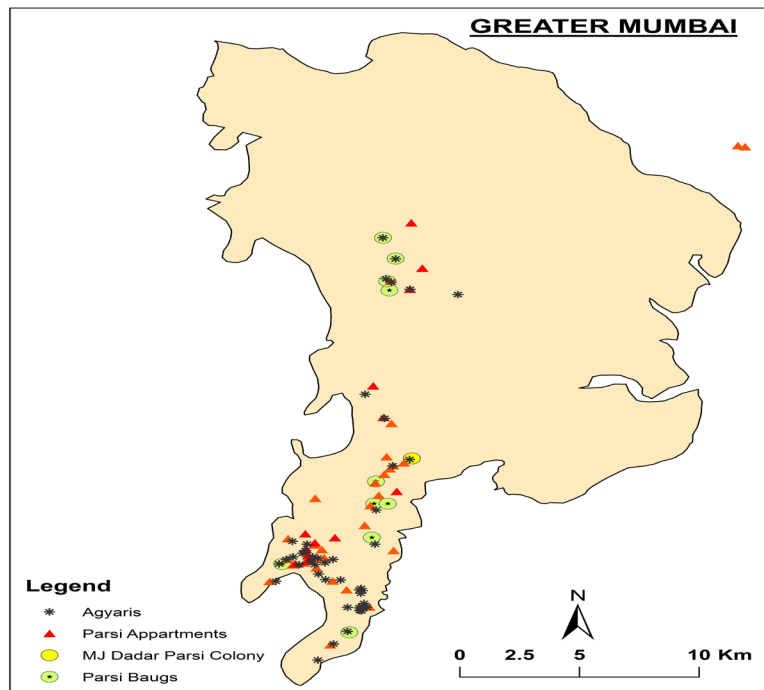

Figure 5: Parsi Temples in Mumbai are concentrated in and near Parsi community housing (Source: The Authors).

All participants perceived poor access to theatre and art venues for cultural engagement. This is likely due to digital entertainment. The digitalization of entertainment is not limited to television. Digitalization and sedentary lifestyle have moved people away from the socio-cultural life outside. When outside, people are 'online' and continue to communicate in the virtual world. This shift of communication to an online platform remains to be studied for its association with health and disease. The increase in digitalization and the lack of third places and opportunities go hand in hand. Increase in digitalization of entertainment has a direct impact on third places and opportunities as the demand for space and opportunities decreases. As people increasingly stay indoors there is less motivation for offline social interaction.

The socio-cultural relevance of the third place and the opportunities it creates are unparalleled. Since its inception, the concept of third places has not evolved and this gap in research must be addressed. What qualifies as a third place, who has access to third places, and what is the role of public and private ownership of places? These are questions that must be addressed to inform urban planning and policy. The private-public nature of third places must be evaluated because private places welcome people conditionally. The conditions, the behavioral expectations and the exclusions that a community may impose with respect to who can be at the third place must be debated for greater and equal access (Leclercq and Pojani 2021).

The prevalence of high blood pressure in the overall study population, higher blood pressures among the youth, increased obesity, sedentary lifestyle and automobile dependence in a greater number of participants suggest poor physical activity, mobility and social interaction irrespective of neighborhoods. It reflects the burden of rapid urbanization in megacities in LMICs that can affect NCDs by social layering and complexities (Frumkin and Haines 2019; Németh and Schmidt 2010; Sehgal and Toscano 2021). Urban sprawl with overcrowding strains public resources, forcing people to use private automobiles and drives risk behaviors such as inactivity and a sedentary lifestyle. Ultimately, entire urban populations are left vulnerable to lifestyle disorders and non-communicable diseases. Our results affirmed that the challenges of urbanization in LMICs are distinct from those in high-income countries.

CONCLUSIONS

A third place encourages mobility and social interaction to enhance social capital and healthy behaviors. Third places and sociospatial opportunities complement the exposome to positively affect the lifestyle and health of populations. Rapid urbanization is a threat to third places and opportunities with unique challenges in LMICs. The loss of social space disconnects populations, is detrimental to health and can lead to non-communicable diseases that do not have

a cure. These diseases are a burden on populations and healthcare systems. As we strive to bring everything to our fingertips on a mobile application, third places and the sociospatial opportunities they provision, demand to be at the research-design interface with a promise of improved health outcomes. The urban exposome can potentially determine the lifestyle and health of residents. Urban planners must make informed decisions for resilience of cities and the people who live in them.

REFERENCES

- Abascal, Angela, Natalie Rothwell, Adenike Shonowo, Dana R. Thomson, Peter Elias, Helen Elsey, Godwin Yeoboah, and Monica Kuffer. 2022. "Domains of deprivation framework" for mapping slums, informal settlements, and other deprived areas in LMICs to improve urban planning and policy: A scoping review." *Computers, Environment and Urban Systems* 93, no. 101770. <https://doi.org/https://doi.org/10.1016/j.compenvurbsys.2022.101770>.
- Andrianou, X. D., and K. C. Makris. 2018. "The framework of urban exposome: application of the exposome concept in urban health studies." *Science of the Total Environment* 636: 963-967. <https://doi.org/https://doi.org/10.1016/j.scitotenv.2018.04.329>.
- Atash, Farhad. 1994. "Redesigning Suburbia for Walking and Transit: Emerging Concepts." *Journal of Urban Planning and Development* 120 (1): 48-57. [https://doi.org/https://doi.org/10.1061/\(ASCE\)0733-9488\(1994\)120:1\(48\)](https://doi.org/https://doi.org/10.1061/(ASCE)0733-9488(1994)120:1(48)).
- Bosman, Caryl, and Joanne Dolley. 2019. *Rethinking Third Places and Community Building*. Edited by Caryl Bosman and Joanne Dolley. Monograph. *Rethinking Third Places*. Online: Elgaronline.
- Browning, C.R.; Cagney, K.A. 2003. "Moving beyond Poverty: Neighborhood Structure, Social Processes, and Health." *Journal of Health and Social Behavior* 44 (4): 552-571.
- Butsch, Carsten, Frauke Kraas, Sridharan Namperumal, and Gerrit Peters. 2016. "Risk governance in the megacity Mumbai/India — A Complex Adaptive System perspective." *Habitat International* 1-12. <https://doi.org/http://dx.doi.org/10.1016/j.habitatint.2015.12.017>.
- Cuevas, Adolfo G , David R. Williams, and Michelle A. Albert. 2017. "Psychosocial Factors and Hypertension." *Cardiol Clin* 35: 223-230. <https://doi.org/http://dx.doi.org/10.1016/j.ccl.2016.12.004>.
- Ellis, Cliff. 2002. "The New Urbanism: Critiques and Rebuttals." *Journal of Urban Design* 7 (3): 261-291. <https://doi.org/https://doi.org/10.1080/1357480022000039330>.
- Frumkin, Howard, and Andy Haines. 2019. "Global Environmental Change and Noncommunicable Disease Risks." *Annual Review of Public Health* 40: 261-282. <https://doi.org/https://doi.org/10.1146/annurev-publhealth-040218-043706>.
- Jeffres, Leo W. , Cheryl C. Bracken, Guowei Jian, and Mary F. Casey. 2009. "The Impact of Third Places on Community Quality of Life." *Applied Research Quality Life* 4: 333-345. <https://doi.org/10.1007/s11482-009-9084-8>.
- Knaap, Gerritt, and Emily Talen. 2005. "New Urbanism and Smart Growth: A Few Words From the Academy." *International Regional Science Review* 28 (2): 107-118. <https://doi.org/10.1177/0160017604273621>.
- Kwan, Mei-Po. 2013. "Beyond Space (As We Knew It): Toward Temporally Integrated Geographies of Segregation, Health, and Accessibility." *Annals of the Association of American Geographers* 103 (5): 1078-1086. <https://doi.org/10.1080/00045608.2013.792177>.
- Leclercq, Els, and Dorina Pojani. 2021. "Public space privatisation: are users concerned?" *Journal of Urbanism: International Research on Placemaking and Urban Sustainability* 1-18. <https://doi.org/https://doi.org/10.1080/17549175.2021.1933572>.
- Mouratidis, Kostas. 2021. "How COVID-19 reshaped quality of life in cities: A synthesis and implications for urban planning." *Land Use and Policy* 111, no. 105772. <https://doi.org/https://doi.org/10.1016/j.landusepol.2021.105772>.
- Németh, Jeremy, and Stephen Schmidt. 2010. "The privatization of public space: modeling and measuring publicness." *Environment and Planning B: Planning and Design* 38: 5-23. <https://doi.org/10.1068/b36057>.
- Network, The Economist Corporate. 2018. "The Global Liveability Index 2018A Free Overview." *The Economist*.
- Oldenburg, R. 1997. "Our vanishing third places." *Planning Commissioners Journal* 25, no. 4: 6-10.
- Putnam, R.D. 2001. *Bowling alone: The collapse and revival of American community*. Simon and Schuster.
- Rappaport, S.M. 2011. "Implications of the exposome for exposure science." *Journal of exposure science and environmental epidemiology* 21: 5-9. <https://doi.org/10.1038/jes.2010.50>.
- Sehgal, Hitakshi. 2022. "The Neighborhood Accessibility Framework: A Methodological Instrument to Assess Neighborhood-Level Determinants that Affect the Health of Urban Residents." ARCC-EAEE 2022 International Conference, Miami, USA.
- Sehgal, Hitakshi, and William A. Toscano. 2021. "Neighborhood exposures and blood pressure outcomes: a cross-sectional environmental study among 19-53 years-old Parsis in Mumbai." *International Journal of Environmental Research and Public Health* 18 (16). <https://doi.org/https://doi.org/10.3390/ijerph18168594>.
- Stuckler, D. 2008. "Population Causes and Consequences of Leading Chronic Diseases: A Comparative Analysis of Prevailing Explanations." *The Milbank Quarterly* 86 (2): 273-326. <https://doi.org/https://doi.org/10.1111/j.1468-0009.2008.00522.x>.
- Tabish, S.A. 2017. "Lifestyle Diseases: Consequences, Characteristics, Causes and Control." *J Cardiol Curr Res* 9 (3): 00326. <https://doi.org/10.15406/jccr.2017.09.00326>.
- Toscano, W.A., H. Sehgal, E. Yang, L. Spaude, and A.F. Bettmann. 2014. "Environment-Gene interaction in common complex disease: New Approaches." *AIMS Mol Sci* 1 (4): 126-140. <https://doi.org/10.3934/molsci.2014.4.126>.

RESEARCH AND DESIGN

- Weinberger, R.; Sweet, MN. 2012. "Integrating Walkability into Planning Practice." *Transportation Research Record: Journal of the Transportation Research Board, Washington, DC* 2322: 20-30. <https://doi.org/10.3141/2322-03>.
- Williams, SA.; Hipp, JR. 2019. "How great and how good?: Third places, neighbor interaction, and cohesion in the neighborhood context." *Social Science Research* 77: 68-78. <https://doi.org/https://doi.org/10.1016/j.ssresearch.2018.10.008>.
- World Health Organization, WHO. 2022. "Noncommunicable diseases; Key Facts." World Health Organization Accessed November 28, 2022. <https://www.who.int/news-room/fact-sheets/detail/noncommunicable-diseases>.

Typo-morphology as a Methodological Framework to evaluate Urban Sustainability

Anirban Adhya¹, Philip D. Plowright¹

¹Lawrence Technological University, Southfield, MI

ABSTRACT: Typo-morphology has been traditionally used as an analytical classification methodology to make sense of urban space. It involves understanding the changes in an urban environment through the implied social effect of evolution of underlying repeated physical patterns. However, typo-morphology also depicts urban areas as socially constructed spaces as formal characteristics are physical indicators of human beliefs and actions. Considering typo-morphological content through physical indicators of capacity, stability, sensibility, choice, and diversity in urban development, we can reveal beliefs and actions connected to urban sustainability.

Typo-morphology was applied to connect urban sustainability to a spatial semantic framework, using the City of Ann Arbor, Michigan as a case study for a longitudinal cartography-based analysis. Infrastructural evidence was linked to socio-political priorities and actions through a focus on the evolution of street patterns and urban grain development. These were then analyzed for grain directionality, permeability, locality, and activation in relation to natural and infrastructural edges and boundaries as indicators of embodied sustainability factors.

The research revealed how typo-morphology depicts cities as socially constructed spaces, engaging different hierarchies of urban elements and socio-economic priorities in the formation and transformation of the city. The specific outcomes underline human-assigned values, embedded in the physical elements and infrastructure of the city, influencing ability of the city to support, enhance and sustain increasing population (capacity), to adapt to generate different options (choices), to provide a condition of equilibrium (stability), and maintain its relevance through varied formal and infrastructural strategies (diversity). Through this research, typo-morphological analysis can be recognized as a method to evaluate the successive and sustainable nature of urban form.

KEYWORDS: typo-morphology; urban patterns; sustainability; methodology; longitudinal study

INTRODUCTION

A historic typo-morphological study is about knowing and telling the history of a city through repeating physical patterns found in the city. People, individually or in groups, relate to cities as relationships that exist between physical form and socio-economic activities in an urban environment. This formal-social relationship is vital towards understanding the city as an idea and as a realization of practice through human construction. The dynamic interaction between urban configuration (formal structures), human behavior (engaging actions) and common understanding (social values) continually shapes the growth of a city through time (Habraken, 2000).

Urban typo-morphology

The growth of a city is broad and complex. Physical patterns of this growth embody dynamic shifts in social agreements, economic priorities and political intentions. In order to understand the overall sense and structure of the city across time, a typo-morphological framework, grounded in the street network and its qualities, can be used to document, analyze and understand urban spaces at the city scale. Within the typo-morphology of the “town-plan” (Conzen, 1960; M.P. Conzen, 2018), streets as well as all other parts of the public space network have a higher permanence in time. The physical infrastructure of the street network represents one of the most significant socio-economic efforts of a society in the process of city-building. Streets support the different flows of a city, allowing access to the different plots, buildings, activities, and events within the urban system. Basic properties of a street include its shape, length, and width, expressing its capacity for human movement, flow and interaction. Variations in street grid composition and density patterns are linked to nodes and segments as well as its spatial configuration - how each street segment is connected to every other segment in the urban system, determining permeability and accessibility measures in the urban environment (Oliveira, 2021). Highly accessible street networks attract movement associated with configuration of the grid, making the highly dense and connected urban core a locus of local and global destinations (Hillier et al, 1993). These typo-morphological qualities form the basis of urban design principles considered to identify distinct morphological regions with consistent physical patterns and document their evolution through time. The evolution and properties of the street grid system, such as regularity, directionality, density, permeability, and accessibility, is a significant tool for analyzing urban development.

Urban design principles

There are a few critical factors that can be used to analyze urban conditions when looking at strictly space-based information. These are 1) boundary and edge conditions, 2) mobility and path patterns, 3) urban axial tendency, 4) grain and grain directionality, 5) urban permeability, and 6) locality relationships. Each of these are expanded below as formal analysis factors used to extract socio-economic information through typo-morphological conditions. These formal factors are indicators of the ability of a city to support an increasing population and development through providing access to resources and activities. They also indicate the ease of accessibility which is a major factor in the ability of a population to engage available resources and experiences, affecting equity and resilience in urban populations and infrastructure.

In urban design, boundaries are critical elements of the environment as they operate as both physical and conceptual containers through enclosing large volumes of space through different types of edges. An edge is simply a moment where something stops being itself and becomes something else (Adhya and Plowright 2023, 40). These edges are often imagined through legal agreements, but this study concerns massing or physical edges that are either environmental, such as topography, or infrastructural, such as high-speed mobility corridors. The boundary created by these edges affect urban design decisions through influencing where and how we build or what we wish to control.

Mobility and path patterns affect accessibility, opportunity, and connections between different human events (Adhya and Plowright 2023, 58, 62, 82, 104). These patterns are revealed through movement infrastructure through the street grid and associated with grain patterns, grain directionality, and permeability. One of the most critical factors in mobility are the indicators of speed and scale hierarchies. Small scale paths, such as a local road, increase the potential for choice at the block scale while connectors, such as arterial road or urban corridors, increase connectivity and activation between different localities. These affect axial tendency in terms of development potential through grid expansion, distortion, extension and consolidation. At a regional scale, paths operate at high speed and relate to highway systems, railroads, air travel and other long distance travel infrastructure. While these connect urban centers with other centers, they affect local massing through operating as edges.

An urban axial tendency is the growth tendencies of an urban space supported through physical capacities. These can be expressed through its potential of development along an urban axis as the main line of direction, motion, growth, and expansion in the city. A growth tendency is suggested by several factors including the availability of a strong local and directional mobility corridor or network such as a major organizing street and development of edges and grid overcoming existing connections or massing such landscape elements (water, topography) or infrastructure (rail lines, highways). The urban axis is the summary of the major direction of growth based on the least formal resistance to added urban massing or the greatest potential to connect human density to human activities.

Urban grain describes the essential structure of an urban area based on how land is divided and developed in a built area usually at the block or district scale. Grain is important for how the built environment affects social interactions as it expresses the potential for ease of movement directly related to permeability. It is also directly related to the degree of choice in that movement which increases interaction opportunities and degree of connection (Adhya and Plowright 2023, 50). The grain direction, or the ratio of block length to width, will be a major indicator of this potential. As blocks demonstrate regularity like orthogonality (angular relationship) and squareness (equal length and width), the opportunity for access and movement around the block becomes equal. As a block elongates and becomes more 'directional', the long sides restrict cross movement through lower porosity which adds to the axial tendency of the urban massing. The short sides of a grain with strong directionality have a greater potential for accessibility and activation as ease of movement, or axial tendency, will be supported by the direction of the urban grain.

Urban permeability is the measure of the capacity of an urban space to allow movement through the relationship between grain patterns and mobility infrastructure. Permeability relies on the degree to which one open space provides access to another and how they connect to create a path of travel (Adhya and Plowright 2023, 108). More permeable environments are those that allow a greater potential of accessibility through choice and ease of motion. This is affected by public accessibility to paths and the massing relationship between urban forms as highly permeable spaces offer multiple and non-restrictive paths that increase the likelihood of human density, events, and activities through adjacency. Permeability should not be confused with porosity which is the relationship between built mass and open space in an area.

Locality is indicated in typo-morphological studies through physical characteristics of grain, grain directionality, massing patterns and mobility connections that suggest a point of focus or a location that is highly activated. Activation in formal analysis is indicated through diverse connections at multiple scales, strong local edge conditions that reinforce a formal identity, or, formal differentiation such as a prominent change in formal characteristics (localized change in grain pattern or isolated building form). Through presence and prominence, the point of locality operates as an organizing factor for the surrounding area, extending a perceived boundary and area of influence. This is usually expressed through the identification of a center which can be either physical massing or an urban void.

1.0 METHODOLOGY: TYPO-MORPHOLOGY AND STREET GRID ANALYSIS AS URBAN LONGITUDINAL STUDY

The exploration of typo-morphology of a city as a relevant framework to evaluate urban sustainability was tested through a case study approach. The subject city, as a case study, is focused on the historic evolution of tendencies in urban conditions. In this case, the City of Ann Arbor, Michigan, was selected as the context to study the relationship of sustaining morphological information and its reflection in shifts in socio-political values in the city across time. Ann Arbor was chosen for its scale as a successful small urban center and accessibility to well documented, longitudinal information for an urban destination that has sustained identity and vitality throughout the years. A longitudinal analytical study of Ann Arbor was undertaken across five significant time years in the developmental history of the city - 1856, 1874, 1925, 1948, and 2004.

The purpose of the analysis is to indicate socio-cultural intentions through formal and pattern-based evidence. As such, the socio-spatial factors were isolated from historical or cultural knowledge through the methodology. While typo-morphology operates at multiple scales, this study focused on the overall urban patterns of development. It did not use block-level spatial information (land use, building directionality, localized movement, and entrances/access) or lot-level studies (massing, open space, figure-ground). As such, the basic typo-morphological analytical unit for this project was the city-wide street network. At this large urban scale, a multi-phase research structure was employed with focused analysis passes involving four phases. The first phase was a cartographic study of the urban morphology of the sample city through five maps from the five years. Historic maps were analyzed to identify the street network (Figure A on diagrams 3.1 to 3.6). The second phase was a street grid analysis identifying accessibility patterns and its morphological evolution at five temporal points of development. This identified grid structure, grid regularity, grid directionality and grid accessibility through spatial network analysis (depthmapX) (Figure B on diagrams 3.1 to 3.6). Once the spatial network was analyzed in terms of the density of street nodes, the next phase analyzed spatial patterns through formal instances of locality through nodal identification and expressions of urban axial development tendency. These highlighted boundaries, edges, movement scales, and grain directionality through street segments and street integration as an accessibility measure (Figure C on diagrams 3.1 to 3.6). Finally, phase four was a review of historic socio-economic events and actions correlated to the identified formal pattern development in the study periods. These are discussed to explain and reinforce the observed analytical findings to generate a socio-spatial narrative.

2.0 TYPO-MORPHOLOGICAL DESCRIPTIONS

The study uses five maps from 1856, 1874, 1925, 1948 and 2004. All the maps from the nineteenth century (1853, 1874) and the twentieth century (1925, 1948) are Sanborn Fire Insurance maps that outline city streets and important infrastructure of that time, mapped as a documentation and inventory of critical urban spaces and resources. The 2004 map is based on city GIS layers archived and used for infrastructure and resource development and planning. The descriptive maps, the street grid analysis and urban development tendencies are elaborated and discussed below.

2.1. Ann Arbor 1856

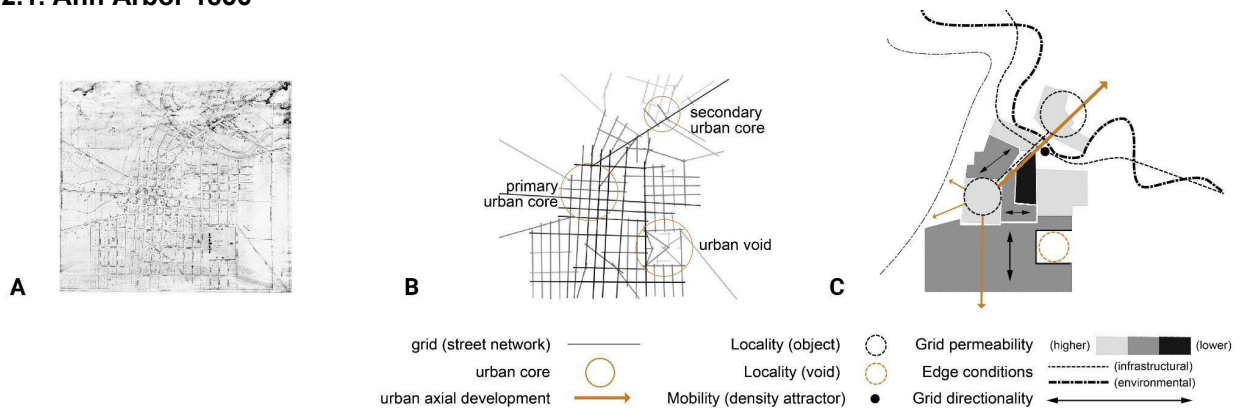

Figure1: 1856 (A) county survey map (Washtenaw County); (B) street grid analysis diagram (by authors); (C) typo-morphological analysis diagram (by authors)

The 1856 county survey map panel (1A) shows Ann Arbor with a compact street network with four primary characteristics which are identified through the street grid analysis diagram. The primary structure of the urban composition is a highly regular, orthogonal grid containing sections of different grain patterns (1B). Two areas of finer grain grid composition can be identified on the north and south sides of the river, which maintain a strong connection (diagonal) through a highly connected street. The primary core is surrounded by an elongated street grid with north-south block directionality to the south and east-west directionality to the east. The grid analysis can be overlaid with typo-morphological factors as there are identifiable formal boundaries, localities, and axial tendencies (1C). Two barrier elements (river topography and rail infrastructure) create a strong edge condition to the north of the primary core. A

second edge is present through topography with a change in elevation to the west. The strongest axial lines extend from the primary urban core to the northeast and the south, suggesting a path for expansion. The northeast axial tendency links the primary and secondary cores although constrained by the river edge. A third locality is an urban void, defined by strong edges on three sides located to the southwest of the primary urban core and is an exception to the grid. This urban void is disconnected from both other urban cores through more directional and less permeable urban grain. This suggests the development of two parallel but independent urban identities.

The typo-morphological analysis of the city in 1856 reveals three prominent localities — two core developments and one active void. These multiple points of interest reflect the historic context of Ann Arbor in 1856 as a new frontier town searching for its identity and attempting to establish itself as a prominent destination during its formative years. Ann Arbor was chartered in 1851 as a county seat after a decade of efforts in establishing the city as the capital of Michigan. Such political efforts led to the establishment of the primary core, an ideal orderly street network on the upper part of the natural hill with sites for speculative government buildings and public spaces. The Michigan Central Railroad reached Ann Arbor in 1839, which attracted hundreds of new settlers to the city. The new settlers congregated along the railroad on the northeastern end of the city as the low-lying land was cheap and had a proximity to employment at sites along the river. The economic development focused on the river led to the incorporation of a rival village through a diagonal street expansion (north diagonal in 2b) between the two localities (Marwil 1987, 5-6; McLaughlin 1995, 16-17). The diagonals to the southeast and west of the city were also prominent connections to outlying farmlands where economic connection was needed to bring produce and raw materials to the market and industries in the city. In 1837, the city negotiated to be the home of the State University of Michigan. A large 40-acre block in the southeast was allotted for the first university buildings to be centered around a university quad (the urban void in 1B and 1C). The development of the directional grids along the three edges of this block denote a parallel development of the university as a secondary force of development. Such a role for the university as an urban actor and developer for the community was argued by Henry Philip Tappan, the first president of the university. He advocated for the city to house university students in rental homes and was instrumental in developing such a policy, which led to edge development around the university campus (Marwil 1987, 29-30).

2.2. Ann Arbor 1874

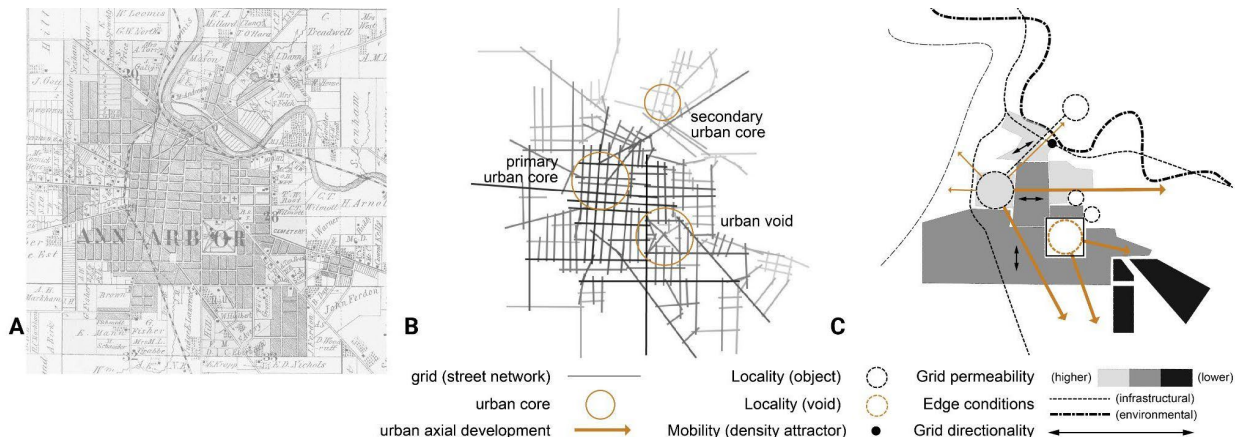

Figure 2: 1874 (A) Ann Arbor plat map (University of Michigan Digital Collections 1874); (B) street grid analysis diagram (by authors); (C) typo-morphological analysis diagram (by authors)

The 1874 plat map of Ann Arbor shows internal development as well as outward expansion (2A). There are new block developments to the northwest and the southeast. The street grid analysis (2B) reveals that the northwest development is not as strongly integrated. The strongest axial lines are two southeast diagonals and a north-south artery operating as a centerline for the city. The orthogonal grid continues to develop within the urban boundaries and a second infrastructural boundary (Ann Arbor Railroad) is introduced on the west side following the existing topographical edge. The typo-morphological layers (2C) identifies this strong southwest urban axial expansion tendency that is centered on two localities - the primary urban core and the urban void. This is supported by the grid directionality and is focused in the opposite direction to the infrastructural and topographical edge conditions. The secondary core to the northeast is still present but has little evidence of continued grid integration or development. The strongest pattern of development is focused around the urban void which is more clearly defining (activating) its edges through massing development to the east. The urban grain in this area is still strongly aligned with a north-south directionality.

The historic records of the socio-economic and political life of Ann Arbor in 1874 is dominated by the economic downturn following the Panic of 1873. The dull economy brought realization in the city that the vision of Ann Arbor as one of the great manufacturing cities in the west has not been realized. In reality, Ann Arbor was a small-town destination within a largely surrounding rural area, albeit with a large growing university. After 50 years of growth, the city had recently lost 10 percent of its population (University of Michigan Library MLK Planning Committee 2023). The economic

recession and de-population resulted in halting of construction and new development. Specifically affected was the secondary core across the river and northeast area of industries along the river and railroad. With the industries closing and less demand and workforce left in the town, the lower town development in the northeast ceased, as reflected in decreasing grid integration and lack of new grid development found in the map and street grid analysis. The only force of stability and resilience was afforded by the university that grew and attracted students, faculty and more importantly investments during the economically difficult times, which prompted a rival city's jibe, "if it were not for the university, Ann Arbor would be dead" (Ypsilanti Sentinel 1875). The role of the university as an economic engine was established, as seen in the strongest pattern of development in and around the campus in the urban void. The acceptance of the university's role in the community by the political elite as well as citizens of the city can be traced to votes of approval, in elections between 1867 and 1875, for using parts of state property taxes collected for the use by the university. 1874 can be seen as the true beginning of Ann Arbor as a university town.

2.3. Ann Arbor 1925

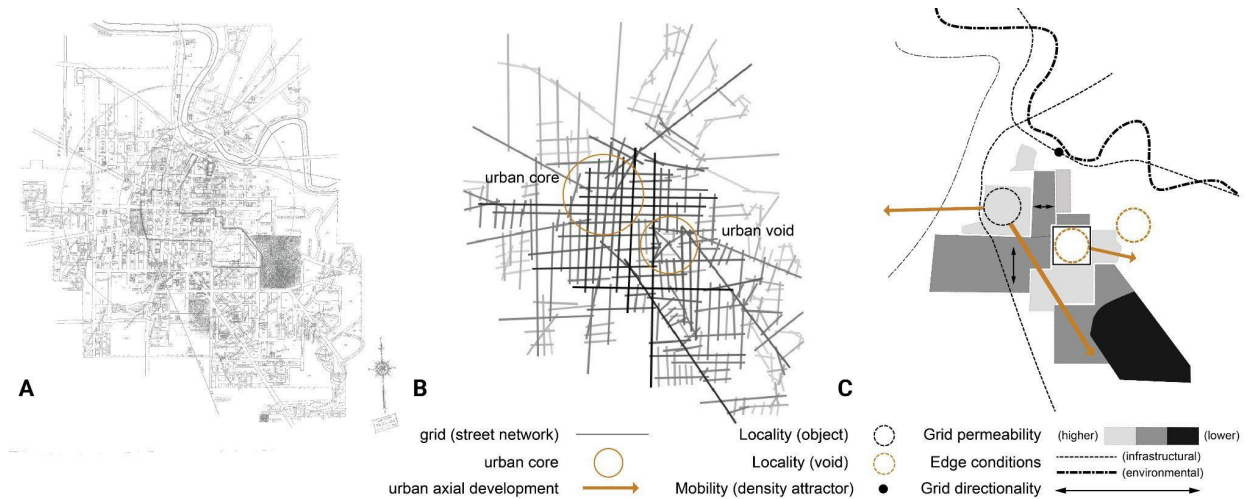

Figure 3: 1925 (A) Sanborn map (Sanborn Map Co. 1925); (B) street grid analysis diagram (by authors); (C) typo-morphological analysis diagram (by authors)

The analysis of the 1925 fire insurance map (Sanborn Map Co. 1925) shows a consolidation of the street grid, reinforcing and densifying the existing patterns (3B) and the resulting typo-morphological factors (3C). The northern secondary urban core has decreased in importance and there is no longer an axial development vector in this direction. The primary core and the urban void remain important as centers of outward expansion but the formal analysis also shows that they maintain their independence. The strongest urban axial development is to the southeast for both but there is a stronger locality developing around the urban void. This is due to a second adjacent locality in evidence to the east and a decrease to the grid permeability in the area south and east. At the same time as these major southwest axial tendencies, there is a reduction in the grid complexity at the topographical (river) and infrastructural boundaries (train line) to the north. The primary urban core also develops a western development tendency through stronger connectivity to the west and the beginning of grid development, although this is not well integrated through adjacency or the continuation of the urban fabric due to the interruption by an infrastructural boundary (train line).

The typo-morphological analysis reflects significant transformation in the socio-economic and political landscape of the city. The biggest changes came from a significant rise in residential property development, new movement infrastructure and expansion of the university, leading to a significant intersection of commerce and education. After the economic turmoil of the mid-1870's, the city saw tremendous growth in new population with an increasing number of European migrants and African-Americans from the south as well as growing number of working women. This influx of new demographics was supported by a city developing residential properties, investing in water and sewer infrastructure, and developing a progressive culture of high-quality schools and diverse workplaces. The university was instrumental in fueling and sustaining a large part of that growth until 1925, even during World War I. Particularly, the university was acting as a developer, purchasing a large number of properties surrounding the original campus void to accommodate institutional needs of new schools and support increasing volume of students. The university also expanded at the edges - for a new hospital to the east of the first void and for a new football stadium to the south. These facilities anchored the university within the community providing vital services toward a quality life in the city and justifying several millage increases in property taxes approved by the citizens. These actions on-the-ground were supported by formal planning efforts. Particularly, the planning report, *Proposed Improvements for Ann Arbor* (Olmsted and Co. 1914) - a joint planning initiative undertaken by the Civic Association, the Chamber of Commerce and the university, was commissioned and implemented "to survey current and future use of the city's physical environment" (Marwil 1987, 105-106). Specific outcome of this effort was improvements and changes to the street system in response to increasing automobile traffic, potential of heavy traffic congestion, and expansion and realignment of streets around

the university campus. Many of these led to decluttering of street network density toward somewhat less permeability in certain areas. Extended tax and fiscal support for property development and drinking and sanitation infrastructure led to huge increase in residential property development and natural consolidation around the cores and densification of the street network. Strategic expansion of the city boundary is also seen to the southeast and west through annexation of outlying township plats.

2.4. Ann Arbor 1948

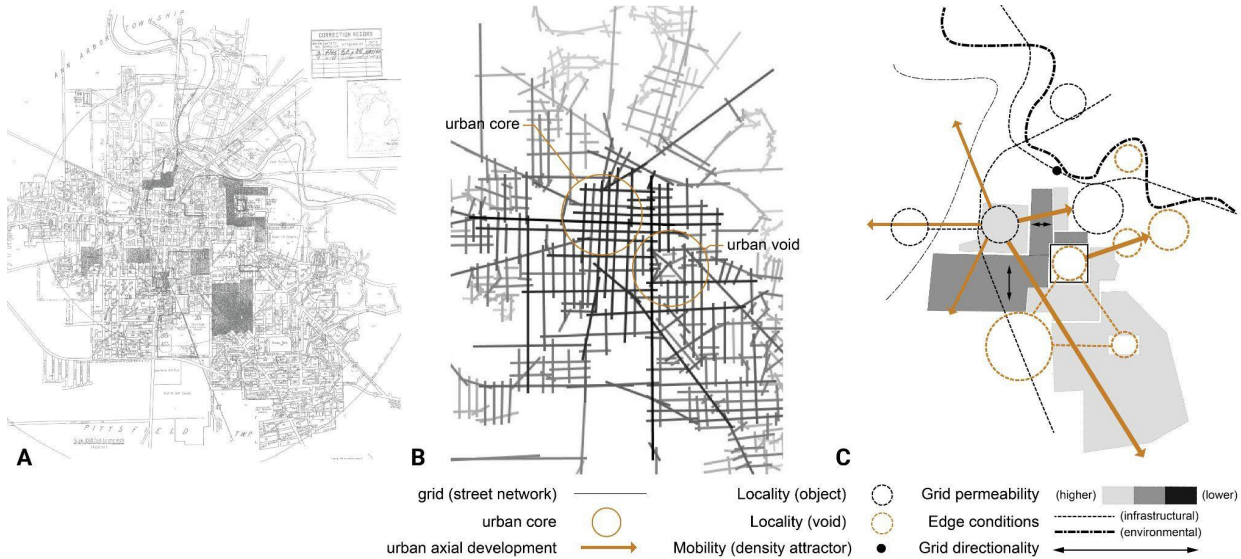

Figure 4: 1948 (A) Sanborn map (Sanborn Map Co. 1948); (B) street grid analysis diagram (by authors); (C) typo-morphological analysis diagram (by authors)

The 1948 analysis shows the strongest formal changes in the grid through the development of new secondary urban voids. These are hierarchical dependencies connected to the primary void (4C) through proximity and permeability. One of these new voids (south) is penetrated by an infrastructural edge (train) which should create a conflict in use. The strongest tendency for the primary urban area is a strengthening east-west vector that is weighted more strongly to the west. The typo-morphological relationship between the urban cores and urban voids suggests the consolidation of two parallel development vectors - one based on fine grain and permeable localized grid/massing (traditional city core) and the second based on localities centered around void with strong edge conditions. In addition to the urban voids, there is a second void development starting to emerge between the infrastructural and topographical edges (rail and river). This is disconnected from the urban grid and might represent the emergence of a third socio-cultural agent in the urban development process.

The formal analysis is supported through historical socio-economic information including a post-WWII increase in housing demand and an expanding university with an increasing student population. Although the city was able to manage development opportunities to maintain the primary urban core as an connected and integrated destination for people and activities, the university was transforming the city as the pivotal developmental engine. The economic engine of the university led to development of finer grids, strong edges and building projects extending from the original campus void as well as new sites like that for the hospital and university botanical garden (McLaughlin 1995, 170). These interconnected void developments and adjacent lands depict the university as the major driver of expansion in the city (Marwil 1987, 138). The university was becoming increasingly independent, especially related to student housing, backing away from historic agreements to use housing owned and managed by the city and citizens of Ann Arbor and, in return, enjoy exemption from any city taxes (Marwil 1987, 113, 136). The increasing grid permeability and finer grain to the southwest is representative of this shift with the university building its own dormitories. This led to several city-university conflicts played out in the spatial morphology, an example being the division of a large recreation area, the large south void noted above, between city (residential area to the west) and the university (football stadium on the east) with the trainline as a boundary. As the city and the university worked to resolve the fiscal conflict, a significant development was an agreement to continue the tax breaks for the university in return for the university's investment and support in improving the water infrastructure, water treatment plant, and sewage disposal plant facilities (Marwil 1987, 136-137). This agreement was significant in activation of several voids along the Huron River and the Michigan Central Railroad in order to manage flooding, stormwater and sewage - the void development visible in the analysis diagrams along the river. This was the beginning of green infrastructure development that integrated infrastructure and environmental management to city parks and recreational areas.

2.5. Ann Arbor 2004

There is significant grid development and densification between the 1948 and 2004 map instances although the typomorphological analysis indicates that there are no significant changes in the tendencies. The densification follows existing patterns building around agents linked to the previously identified dominant localities. The primary urban core continues to develop connections to the west through three axial road lines that perforate the infrastructural boundary. The primary urban void continues to develop through links to other smaller voids, mainly to the southeast, east and northeast. A third locality has also emerged in this period as a linear of developed voids orientated to the river.

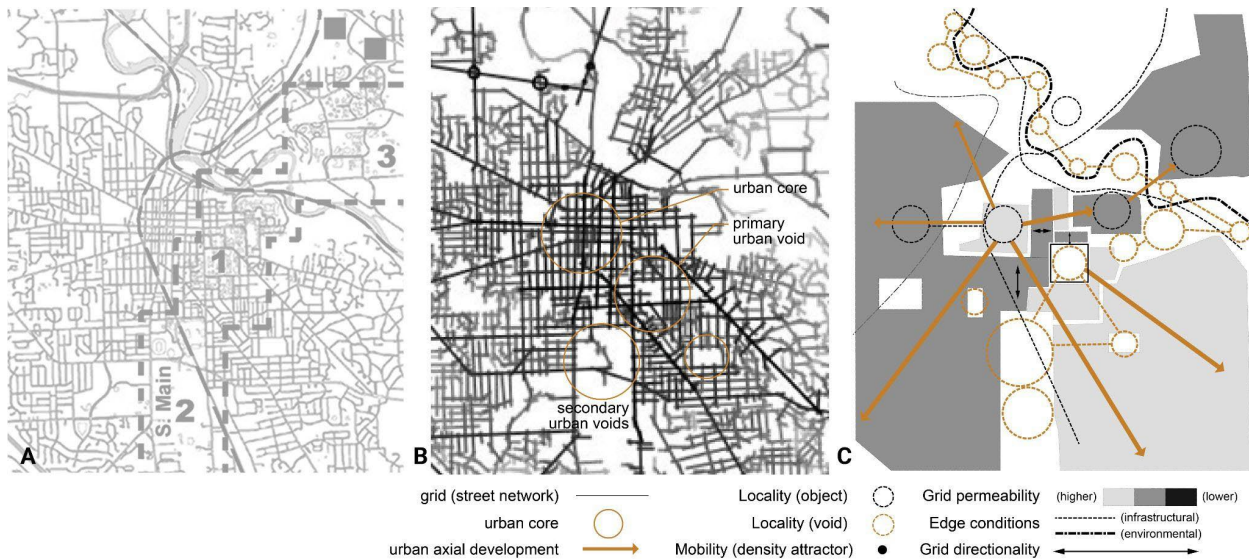

Figure 5: 2004 (A) city planning map (City of Ann Arbor Planning Department, 2004); (B) street grid analysis diagram (by authors); (C) typomorphological analysis diagram (by authors)

The 2004 analysis highlights three significant socio-economic and political factors. First, the *US Highway Plan* (1926) and the *Federal Aid Highway Act* (1956) led to a ring of highways surrounding the City of Ann Arbor. This new infrastructure created a new relationship of the urban cores to the peripheral super-grid of highways. This led to the urban core losing destination power as the old train station was closed in 1970 in the face of dwindling rail traffic and a new much smaller station was again built in 1983 with very limited service. However, the urban core survived with the help of the adaptation of the street network. The historic diagonals that allowed the city to expand, to the west, southeast, east, and northeast, were instrumental in providing quick connection of the urban core to the new highway infrastructure. Second, utilizing the series of parks and open spaces across the city neighborhoods and along the river, the city and the university collaborated to develop, propose and approve the *Open Space and Parkland Preservation Millage* (Greenbelt Plan 2003) to fund “the new parkland acquisitions within the City limits, as well as land preservation outside of the City but within the Greenbelt District” (Ann Arbor Greenbelt Program Strategic Plan 2019). This provided the city with a critical ecological and economic resource in the face of new environmental changes and crisis. Third, the university continued to expand its role as the primary economic development engine as it procured and developed the North campus, using the wasteland north of the Huron River (Michigan Engineering 2017). After a century of the 1856 plan to build the historic lower town, this was the major effort in the city to develop the low-lying flood plains across the Huron River and provide a new locality for activities and events for the city and the university.

3.0 LONGITUDINAL STUDY: FINDINGS AND DISCUSSION

The typomorphological analysis through a longitudinal study of the City of Ann Arbor (1856, 1874, 1925, 1948, 2004) illustrates access to beliefs, actions and policies through evidence of urban spatial composition. The relationship between infrastructural indicators for gathering, movement, density, edge, and accessibility strongly correlate to factors of capacity, stability, sensibility, choice, and diversity in urban development of the city. Through this formal analysis, we can find indications of tendencies in underlying socio-political and economic factors leading to actions connected to urban sustainability. One of the major indicators for urban development was accessibility demonstrated through urban grain, infrastructural/environmental edge presence, and street grid connectivity, which supported an urban axial development vector. Through each of the five historic periods, this factor was consistently aligned with resulting urban development and reinforced through social interactions and political actions.

CONCLUSION

As a formal artifact, the typomorphological analysis of Ann Arbor correlated to socio-cultural intentions and opportunities. This correlation can be seen as a significant underlying factor for Ann Arbor, or any city, to sustain itself. The street network analysis and the typomorphological descriptions, correlated to the historic socio-political values

and economic priorities in the narrative of the city's evolution, can be a powerful methodology and significant measure to evaluate urban sustainability. The findings of this study allow us to qualify sustainability, in the context of Ann Arbor, in three specific ways. First, the study highlights urban planning efforts in developing and sustaining the urban core. Throughout the temporal moments, the core is characterized by the historic grid with fine grain morphology for movement and activities, and sustaining its connectedness and permeability through processes of expansion, deformation, densification, and consolidation of the street network. The diagonals are also critical throughout the time periods, persistently connecting the historic core to the changing peripheral landscape - farms, townships, suburban growth, and highway infrastructure. Second, the city adapted well to strategic new infrastructures. This began with use of the river and then the railroad as the attractor for people and industry in the newly forming city (1856, 1874). Then, it transformed its street network to accommodate cars and automotive transportation by planning and refining the street grid as well as integrating highways at its periphery (1925, 1948, 2004). Third, voids are consistently used to generate urban activities, attract land acquisition and edge development.

A significant moment in the typo-morphological analysis was the clear presence of two parallel development agents as seen in the fine grain grid development (highly permeable and connected street network) versus the urban void (open space with strong edges). Each of these 'centers' operated as parallel, but independent, socio-economic engines and were linked to different formal development strategies. The permeable grid approach was identified as the strategy for the municipal development of the City of Ann Arbor while the open space approach was linked to the development of the University of Michigan and the evolution of its campus through historic research. In later years, the urban void strategy shapes green infrastructure development through a relationship between the two urban entities, affecting planning and policies of the city for recreation, land acquisition, growth control, and environmental resilience for crisis management like heat island effect and flood mitigation. The parallel evolution of the city and university is clearly indicated through formal analysis and supported through historical records. It was the university, with its historic educational role, that acted as an economic partner for stability during depression (1874, 1925), an independent economic engine (1948), and as a social and cultural force (2004).

The research revealed how typo-morphology engages different hierarchies of urban elements and socio-cultural priorities in the formation, transformation and sustenance of the city. The specific outcomes underline human-assigned meanings, embedded in the physical elements and infrastructure of the city, influencing ability of the city to support, enhance and sustain increasing population (capacity), ability to adapt to generate different options (choices) to provide a condition of equilibrium (stability), and maintain its relevance as a destination through varied formal and infrastructural strategies (diversity). Through this research, typo-morphological analysis can be recognized as a method to evaluate the successive and sustainable nature of urban form.

REFERENCES

- Adhya, A. and Plowright, P.D. 2023, *Urban Design Made by Humans: A Handbook of Design Ideas*. New York, NY: Routledge.
- City of Ann Arbor Planning Department. 2004. Map of the City of Ann Arbor. [map]. Ann Arbor, MI.
- Conservation Fund 2019, *City of Ann Arbor Greenbelt Program Strategic Plan*. Ann Arbor, MI: The City of Ann Arbor.
- Conzen, M.R.G. *Alnwick Northumberland: A Study in Town-Plan Analysis*; Institute of British Geographers Publication 27; George Philip: London, UK, 1960.
- Conzen, M.P. *Core concepts in town-plan analysis*. In *Teaching Urban Morphology*; Oliveira, V., Ed.; Springer: Cham, Switzerland, 2018; pp. 122–143.
- depthmapX development team. (2017). depthmapX (Version 0.6.0) [Computer software]. Retrieved from <https://github.com/SpaceGroupUCL/depthmapX/>
- Habraken, N.J. 2000, *The Structure of the Ordinary: Form and Control in the Built Environment*. Cambridge, MA: The MIT Press.
- Hillier, B et al. 1993, "Natural movement: or, configuration and attraction in urban pedestrian movement," *Environment and Planning B: Planning and Design*, 20, p.29-66.
- Loureiro, C. and Amorim, L. 2000. "O mascate, O bispo, O juiz e os outros: Sobre a Genesee Morphologica do Recife," in *Estudos Urbanos e Regionais*. No.3. November, 2000. p.19-38.
- Marwil, J.L. 1987. *A History of Ann Arbor*. Ann Arbor, MI: The Ann Arbor Observer Company.
- McLaughlin, M. 1995. *Ann Arbor: A Pictorial History*. St. Louis, MO: G. Bradley Publishing, Inc.
- Michigan Engineering. 2017. Five year plan: The North Campus story. *Engineering Research News*. Ann Arbor, MI: The University of Michigan.
- Oliveira, V. *The Town-Plan as Built Heritage*. *Heritage* 2021, 4, 1049–1061
- Olmsted & Co. (1914). *Proposed Improvements for Ann Arbor*. A planning report for the City of Ann Arbor, Michigan.
- Sanborn Map Co., Inc. (1925). *Ann Arbor, Mich. (Jan 1925)*. [map]. (925 feet to one inch). New York, NY: The Sanborn Library, LLC. Retrieved from <https://www.loc.gov/resource/g4114am.g039091925/?sp=2>
- Sanborn Map Co., Inc. (1948). *Ann Arbor, Mich. (Jan 1948)*. [map]. (ca. 1050 feet to one inch). New York, NY: The Sanborn Library, LLC.
- University of Michigan Library Digital Collections. (1874). "Ann Arbor Township Plat, 1874. [map]. Retrieved from <https://quod.lib.umich.edu/m/moaa/x-bl000819/bl000819>

University of Michigan Library Digital Collections. (1856). "Map of Washtenaw County, Michigan from actual surveys by G. R. Bechler & E. Wenig." [map]. Retrieved from https://quod.lib.umich.edu/c/clark1ic/x-002745875/39015091184773_01

University of Michigan Library MLK Planning Committee (Ed.). (2023). "Ann Arbor and Race." *Michigan's Story: History of Race at U.M.* Ann Arbor, MI: University of Michigan.

Ypsilanti Sentinel. (1875). *Peninsular Courier*, 1 October 1875, p.3.

Walking for Context Analysis

Sarah Gamble¹

¹University of Florida, Gainesville, FL

ABSTRACT: Designers need a range of tools and approaches, often used in combination, to engage with project contexts and inform the design process. Walking is one tool that is often overlooked, yet flexible and accessible for the designer and their clients to foster dialog with each other and bolster our understanding of the physical environment through on-the-ground experiences and intentional observation. As part of a multi-year research effort, twenty prescriptive walking experiences are in development to leverage the power of walking as a tool for the design process. The walks are intended for use by creative practitioners and the public-at-large, with applications in community engagement, early stages of the design process, and beyond.

This paper details the process of testing two walking experiences to assess their clarity, effectiveness, and application within the design process, and consider how creative professions and the public-at-large engage with the exercises. Analogous to the intended user groups, the research participants are two groups of undergraduate students, who undertook the walks as part of elective coursework: fourth year architecture majors enrolled in an advanced analytical sketching course (creative professionals), and first year students enrolled in a general education course on urban life and development (public-at-large). This paper reports lessons learned from the testing process with student research participants, and successes and failures of the walking experiences. Next steps in the research process are detailed, including the need for collaboration with social science fields to analyze additional dimensions of the research data.

KEYWORDS: walking; architectural context; design process; research testing

INTRODUCTION

The slow pace of travel and on-the-ground experiences offered by walking allow for structured learning, chance encounters, and viewing of the environment from a range of perspectives. This accessible mode of transport provides the opportunity to explore sites and projects contexts, an essential step in the pre-design process that encompasses the initial phase of architectural design. Context analysis is typically part of this information-gathering stage, which includes architectural programming and precedes the schematic design process. In this research, context is broadly defined as the physical, cultural, social, and ephemeral facets of the environments in which we live and work. Project contexts are dynamic and multi-faceted, and learning about them requires time and intentionality. At the start of an architectural design project, designers must consider how to best look, listen, and gather information to feed into their work.

The primary research questions for the project are: Can prescriptive walking experiences, as a tool for the design process, foster learning and engagement with project contexts and stakeholders? When and how can it be applied? A walking experience is a detailed explanation and/or step-by-step instructions that serve as a guide or source of inspiration for the reader to walk in an intentional way. Walking includes a variety of active modes of travel at slow speeds, such as rolling via wheelchair or stroller, but excludes modes with increased speeds, such as running or rolling via skateboard or rollerblades.

A catalog of walking experiences is being developed, drawn from and/or inspired by a range of primary and secondary sources that include a review of academic literature, videos, and conducting original interviews with experts from the fields of public art, urban design, creative writing, social sciences, and more. This research has revealed walking experiences in three states of development: 1. Detailed and clear descriptions and/or instructions that could be easily executed; 2. descriptions that could developed further for execution; and 3. precedent projects that could be documented and/or analyzed to yield a walking experience that could be executed. Twenty experiences with potential application in the design process have been identified and documented, and are being developed to present a range of options for professional practice and educational settings.

1.0 RESEARCH TESTING

1.1 Overview

An initial phase of testing took place over the Spring and Fall 2022 semesters to assess the clarity, effectiveness, and application of walking experiences for the two anticipated user groups, creative professionals and the public-at-large. Text was provided to participants in a printed or digital format, including: title, background information, walk instructions, and supporting creative activity instructions. At the conclusion of the experience, data was gathered digitally.

Over the span of a semester, the two participant groups (defined in Section 1.2) each tested between 6 and 10 walking experiences in development. The walks, with supporting creative activities, were selected for each group, based on their elective course focus. While the description and walk instructions were the same for each participant group, the supporting creative activities was adjusted and integrated into their assigned coursework to facilitate student learning that met course goals and objectives. Participants provided consent after grading was completed, to eliminate any pressure to contribute their coursework to the research research.

In Section 3.2, in-depth analysis of two walking experiences tested by both groups is discussed. The author sought to compare the outcomes from both groups to assess the level of understanding and engagement by creative professionals and the public-at-large by analyzing the clarity, effectiveness, and application of the walking experiences. The two walking experiences are described, using abbreviated versions of information provided to participants.

1.2. Research Testing Participants

The research participants were undergraduate students at the University of Florida taking part in the research as part of undergraduate courses taught by the author. Both participant groups elected to take the courses, so it can be assumed that they had some personal or educational interest in the topics in the courses and related walking experiences. The two participant groups are:

Participant Group 1 (Fall 2022): Twenty-nine, fourth year architecture students enrolled in *Analytical Sketching*, a three-credit course offered to participating students in the School of Architecture's study abroad in Vicenza, Italy. In Module 2 of the course, "sketching will used as a tool for observation and analysis at the scale of city, district, neighborhood, and street. Drawing exercises will focus on engagement and exploration of place throughout Vicenza and travel locations" (Gamble Syllabus 2022). Students took prescriptive walks focused on an aspect of the environment, raising their awareness of and capability to recognize, document, and analyze the environment in real time. While walking, they were exposed to unique spatial experiences, urban forms, architectural works, and local construction materials, which then served as inspiration and/or the focus of their sketches. Through a series of six walking experiences assigned over three weeks, students fostered the ability to observe and develop their own ideas into a unique thesis for each creative exercise. Prior to the course, this participant group had completed six semesters of architectural design studios and supporting courses, which provided extensive learning and experience in spatial and abstract thinking, conceptual idea development, hand and digital drawing, and physical model-making.

Participant Group 2 (Spring 2022): Seventy-one students enrolled in Quest 1 *What is A City: Life and Design for Urban Environments*. The three-credit, humanities-based, general education course is offered through the Quest program, a part of the university-wide general education program with courses that "examine questions about the human condition that are difficult to answer and hard to ignore" (UF Quest 2022). The students represent a range of majors, not including architecture majors. The walking experiences were integrated into weekly reflection assignments, where the walking experience was used as a tool to cultivate their observation skills while engaging the built environment, and served as inspiration for a supporting creative activity.

1.3. Walk Experiences

Two walking experiences, which both groups tested, is outlined below. This text is an abbreviated version of text shared with participants (Gamble Text 2022).

Radius Walk

Origin: Drawn from the work of French Scientist and Professor Carlos Moreno, a 15-minute walk has become a standard measure of cities and neighborhoods in the 21st century (Duany 2021). The Arizona State University School of Art's Museum of Walking, led by Artist and Professor Angela Ellsworth, explored this timed travel through an arts installation and public events, explaining: ". . . fifteen minutes represents the amount of time people are willing to walk to reach a location by foot" (Museum of Walking 2015).

Instructions: From a pre-selected point, walk for 15 minutes in a singular direction, maintaining as straight a route as possible. When time is up, stop walking and note your location.

Supporting Creative Activity – Group 1: As you walk back to the origin point, create a singular drawing that measures the itinerary. Take liberties with the unit of measure, be creative and draw inspiration from walk. Capture the experience on the ground, and avoid mapping from an aerial perspective.

Supporting Creative Activity – Group 2: Record your walk from start to finish by making a map drawing, noting major landmarks, intersections, etc that you encountered.

Color Walk

Origin: Developed by American writer and visual artist William Burroughs to inspire his creative writing students and cultivate their observation skills (Randolph 2011).

Instructions: Choose a single color, which has a degree of meaning or simply stands out. Spot the color and walk to it, repeat the process following the color from example to example for a minimum of thirty minutes.

Supporting Creative Activity – Group 1: At each stop along the walk, do a quick sketch to capture the moment. Experiment with watercolor, considering saturation, tone, transparency, etc, to capture the color in context.

Supporting Creative Activity – Group 2: Document your walk in a visual format through collage. A collage brings together

multiple streams or formats of information to create a single composition. For example, your collage might include photos, found materials, hand sketches, blocks of color, and more. Collages can be made digitally or physically, by-hand.

2.0 DATA COLLECTION AND ANALYSIS

2.1. Data Collection

The research testing resulted in two types of data: 1. Written reflections and/or feedback about the experience; 2. creative works, for example: a series of photographs, a hand-drawn map, a sketch of an urban scene, etc. This data was gathered from participants in a digital format, and its collection was customized to each participant group for ease of integration into the course.

Group 1 submitted the data via Google Forms, accessed through the e-learning interface (Canvas). Students answered a series of questions, which were repeated for each walking experience to allow for comparisons, and submitted an image or scan of the creative works. Group 2 submitted the data via the university's e-learning interface (Canvas). Students authored 200- to 300- word reflective writings in response to a provided prompt, which was tailored to the course material, and submitted an image or scan of the creative works.

2.2. Data Review

In relationship to the primary research questions, the data from the two participant groups was reviewed to assess the clarity, effectiveness, and application of the walking experiences, and consider how the two groups engaged with the exercises. Based on differing levels of experience and educational training, it was anticipated that the perspective and level of comfort investigating the built environment would vary between the two participant groups, along with the artistic and aesthetic quality of their creative works. These differences were an asset to the research and analogous to creative professionals and the public-at-large, who often struggle to engage and collaborate on built environment projects due to these differences.

In text-based responses, participants' opinions, preferences, and examples spoke directly to these criteria and/or an assessment was interpreted. The creative works were reviewed and interpreted in relationship to the criteria. Creative works were not compared and/or assessed as 'better' or 'worst' in terms of artistic quality, but reviewed with a focus on content and focus.

1. Clarity of the Walking Experience

- Completeness of response: a more complete response indicates a higher level of clarity of the walking experience, in relationship to the participants' engagement and understanding of the intent and instructions of the walking experience.
- Depth of response: a more in-depth response indicates a higher level of clarity, in relationship to the participants' engagement and understanding of the intent and instructions of the walking experience.

2. Effectiveness of the Walking Experience

- Alignment with subject matter: Alignment between the focus of the participant's response and the focus of the walking experience indicates a high level of effectiveness.

3. Application of the Walking Experience

- Alignment with subject matter: Alignment between the focus of the participant's response and the focus of the walk experience indicates applicability of the experience within the design process.

Review 1: A high-level, systematic review of all data collected from the two groups in response to all of the walking experiences tested was completed to provide a broad perspective on the testing process and indicate general lessons learned.

Review 2: A more detailed review of data collected for the Radius Walk and Color Walk was completed to yield more specific insights about these walking experiences and the level of understanding and engagement of the two groups. For each participant, the written reflections/feedback and the creative works were reviewed simultaneously, allowing one to inform the other and shape a more holistic understanding of a participant's response.

3.0 RESEARCH FINDINGS

Research findings from this initial phase of testing include: 1. lessons learned from the testing process with student research participants; and 2. lessons learned and successes/failures from the Radius Walk and Color Walk experiences.

3.1. Student Research Participants

The two research participant groups were composed of undergraduate students, which posed a range of advantages and disadvantages for the testing process. These findings are summarized in the outline below. Lessons learned from the process will be integrated into a second phase of testing.

Testing Process

- Advantage: Participants were likely to complete the assigned walking experiences and submit responses, as their responses were graded as part of the course.
- Disadvantage: Participants could not be asked to use their submitted assignments as research data until after the course was completed. Not all participants provided consent, so their assignments could not become part of the data set.
- Advantage: Participants received an introduction to the subject matter or focus of each walking experience through course material, potentially bolstering their understanding of the intent of the walking experience.
- Disadvantage: Future research participants and/or users of the walking experiences may not have access or exposure to similar background information.

Data Collection

- Advantage: Participants have a working knowledge of the university's e-learning platform, so data could be easily collected digitally through this interface without negatively impacting the course.
- Disadvantage: Data collection through the e-learning platform was inefficient, in comparison to other digital collection interfaces.
- Advantage: Assignments set up in the e-learning platform can be easily shared with faculty for incorporation into future courses.

Student Learning

- Advantage: Walking experiences were incorporated into course assignments, in alignment with course content and learning objectives.
- Disadvantage: Minor adaptations were made to support student learning, and these variations made comparative analysis more challenging.

Written Reflections/Feedback

- Disadvantage: Some participants responded with ideas or opinions discussed during class time, making it challenging to decipher if they were in agreement and/or had adopted the ideas or opinions as their own, or alternatively were solely interested in giving what they perceived as the "correct" answer.

3.2. Lessons Learned and Successes/Failures of the Walking Experiences

Review 1 highlighted the importance of balancing clarity of the written instructions with participants' freedom to interpret. Instructions should provide enough information to guide the reader, while not squelching participants' opportunity to discover the physical environment, explore ideas, and express themselves creatively. The instructions should be worded to direct readers away from searching for 'the right answer' and toward an experience that is beneficial to their creative process and/or learning about their environment.

While anticipated, responses from Group 1 (fourth year architecture students) and Group 2 (first year, non-major students) highlighted the impact of past experience and educational training, including their capabilities to think and make abstractly. Group 1's design education, with extensive training in drawing and abstract thinking paired with 3 additional years of university-level education, led to more thoughtful and in-depth responses. Group 2's low level of comfortability and experience with studying the built environment through creative exercises was pronounced, highlighting the need for flexible and adaptable exercises to accessible to a range of users.

Review 1 highlighted varying levels of clarity, effectiveness, and application, and therefore, varying successes of the walking experiences. The lack of completeness and depth of responses for certain walking experiences, in comparison to others, revealed a lack of clarity and lack of application within the design process, and highlighted the need for improvement through redesign and/or refinement.

For example, Group 1 participants reported a lack of clarity and application for the Traced Cup Walk, in comparison to the other five walks they tested, along with an overall lack of interest in the walk itself. When asked if they could see themselves using the Traced Cup Walk in their design process, participants commented: "No, nothing against it, I just feel like I have more comfortable ways of familiarizing myself with place"; "I don't think I would use this exercise because it's really time consuming"; "Maybe, I find it less useful than some of the others we've done though" (Amy Albandoz; Alejandra Velasquez; Benjamin Spears). The creative works submitted by Group 1 participants aligned with their overall dissatisfaction and disinterest. The submissions lacked depth as creative investigations (Figure 1), indicating a low level of the walking experience's success, when compared to other responses from other walks (Figure 2).

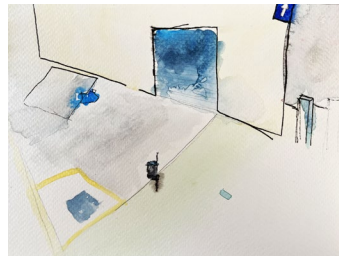

Figures 1 and 2: Sketches in response to the Traced Cup Walk (left) and Color Walk (right) by architecture student Boris Stoyanov. Source: Fall 2022 research data (Gamble).

Review 2 focused on the Radius Walk and Color Walk and allowed for comparative analysis between the participant groups. Overall, the two walks yielded positive responses from both participant groups, while indicating areas in need of refinement.

For the Radius Walk, Group 2's creative submissions conveyed an overall understanding of the walking experience, including its intent. The instructions for the drawing component were open and did not direct participants toward or away from any drawing techniques. A majority of participants created maps from an aerial/plan view at a relative scale to document and explain the physical environment they walked through. While Group 2 was given the most flexibility in how they would choose to respond, their submissions were straightforward and aimed to document the built environment, as opposed to interpreting it. (Figures 3 and 4).

For Group 1, the drawing exercise instructions asked participants to avoid drawing a plan-view map, but was open outside of this parameter. Most participants created three-dimensional perspectival and/or sectional drawings, including human figures for scale. The responses were abstract, diagrammatic, and/or experiential. As a collection, the drawings showed great depth, in terms of ideas explored, drawing techniques utilized, and freedom of expression, while aligning with the focus of the walking experience. Their responses showcased prior knowledge and experience in creative exercises and their ability to explore or capture an idea through creative making. Group 1's submissions were interpretive and idea-generating, which indicated a freedom of creative expression and the capability to think abstractly (Figures 5, 6, and 7).



Figures 3 and 4: Sketches in response to the Radius Walk by Quest students Sophia Archuleta and anonymous participant. Source: Spring 2022 research data (Gamble).



Figures 5, 6, and 7: Sketches in response to the Radius Walk by architecture students Hayley Gillette, Kaley Denaro, and Benjamin Spears. Source: Fall 2022 research data (Gamble).

For the Radius Walk, Group 2's written responses reflect an overall positive response the walking experience and its success as a tool to explore sites and contexts as part of the design process: "It helped me be more observant"; "Searching for units of measure encouraged me to find patterns in the city" (Amy Albandoz; Noah Guth). Participants shared ideas of how to apply the experience, for example: "I think this exercise is a great tool to get to a type of mapping that emphasizes a specific human scale experience of the site and the journey to and from it. [It] allows a greater consideration of accessibility (Joyce Ng)."

For the Color Walk, the creative submissions indicate both groups understood the instructions of the walk and the supporting creative activity. Group 2 was asked to make a collage with no guidance or limitations on the content, format, or approach. A majority of participants created a collage of photographs documenting the found objects. The compositions were straightforward and most participants presented the images equally in a grid-like arrangement (Figures 9 and 11), while a minority varied the size of photographs or cropped them. A few examples indicated a chronology for discovery of the objects and/or a walking itinerary.

For the Color Walk, Group 1 was asked to sketch the found objects and experiment with watercolor techniques. The submissions included a range of drawing types and approaches, including sketches as documentation (Figure 8) to creating abstract spatial compositions through sketching (Figures 8 and 10). Group 1's drawings showed creative expression and exploration of ideas within the drawings, yet their written responses were mixed when asked if they could see using the walk experience within their design process. Some could not see using the exercise: "Not really. Looking for a specific color wouldn't impact the design process of a project too much I don't think"; "Not as much, other than a tool to look for more specific info in the site region" (Abigail Duffey; Yona Novack). Others saw it as an opportunity for inspiration: "I think this exercise was used as a generative exercise"; "Yes, if color was a useful/crucial part of the project's experience in a documentative way" (Niah Pierre; Joyce Ng). These responses indicate refinement is needed to the background information and supporting creative activity to increase the applicability of the exercise for creative professionals.

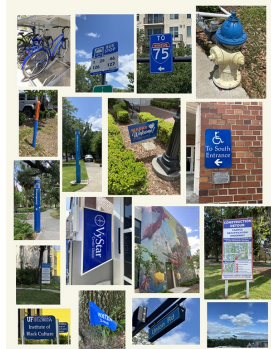
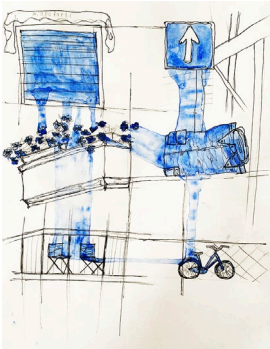

Figures 8 and 9: Creative works in response to the Color Walk from architecture student Sydney Cherrington (left) and Quest student anonymous participant (right). Source: Spring and Fall 2022 research data (Gamble).

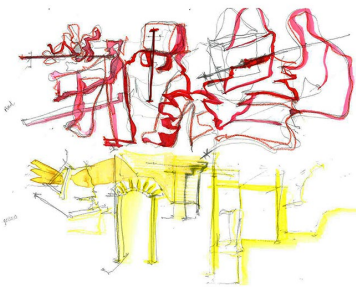

Figures 10 and 11: Creative works in response to the Color Walk from fourth year architecture student Amy Albandoz (left) and Quest student anonymous participant (right). Source: Spring and Fall 2022 research data (Gamble).

CONCLUSION / NEXT STEPS

Lessons learned from the initial phase of research testing highlights three steps to refine and improve the walking experiences. First, research design changes are needed to yield more reliable results. The walk experiences, with supporting creative activities, need to allow for testing by a broader spectrum of participants, without the need to customize for a particular group. Testing by university students is planned for upcoming semesters, and refinement of the walking experiences needs to balance student learning objectives with the need for more comparable data. Second, opportunities to test the walk experiences outside of the university context are needed, such as creative professionals and community leaders involved in built environment projects, to assess the potential use with a broader mix of participants. Third, the data review and analysis process highlighted dimensions of the data that could not be interpreted by the author, and necessitates collaboration with social scientists to more fully interpret the data. The motivation for an expanded, collaborative analysis would be greater insights into the level of understanding and engagement of creative professionals and public-at-large with the exercises and built environment. Also Furthering reflection on the common miscommunications and misunderstandings between design professionals and the public during community engagement processes, this additional analysis could inform the creation or refinement of exercises that are equally engaging and yield data beneficial to the design of an equitable, inclusive built environment.

REFERENCES

Duany, Andres and Steuteville, Robert, "Defining the 15-minute city," *Public Square: A CNU Journal*. February 8, 2021. <https://www.cnu.org/publicsquare/2021/02/08/defining-15-minute-city>.

- Gamble, Sarah, "ARC4930 VIA Analytical Sketching Syllabus", August 15, 2022. Accessed November 15, 2022. <https://dcp.ufl.edu/wp-content/uploads/2022/08/VIA-U-Syllabus-Fall-2022-ARC-4930-VIA-Analytical-Sketching.pdf>
- Gamble, Sarah, "Walking Experience Text v2," September 1, 2022.
- Museum of Walking, *Radius*, 2015. Accessed September 1, 2022. <http://www.museumofwalking.org/exhibitions-2/#/radius/>
- Randolph, Sal, "Color: William Borroughs Walking on Color," *Word Object*, May 2011, blog accessed September 1, 2022. <https://wordobject.wordpress.com/2011/05/19/color-william-burroughs-color-walks/>.
- "UF Quest," University of Florida Undergraduate Affairs, Accessed November 1, 2022. <https://undergrad.aa.ufl.edu/uf-quest/>.

ARCC 2023 RESEARCH PAPERS
Pedagogy Track

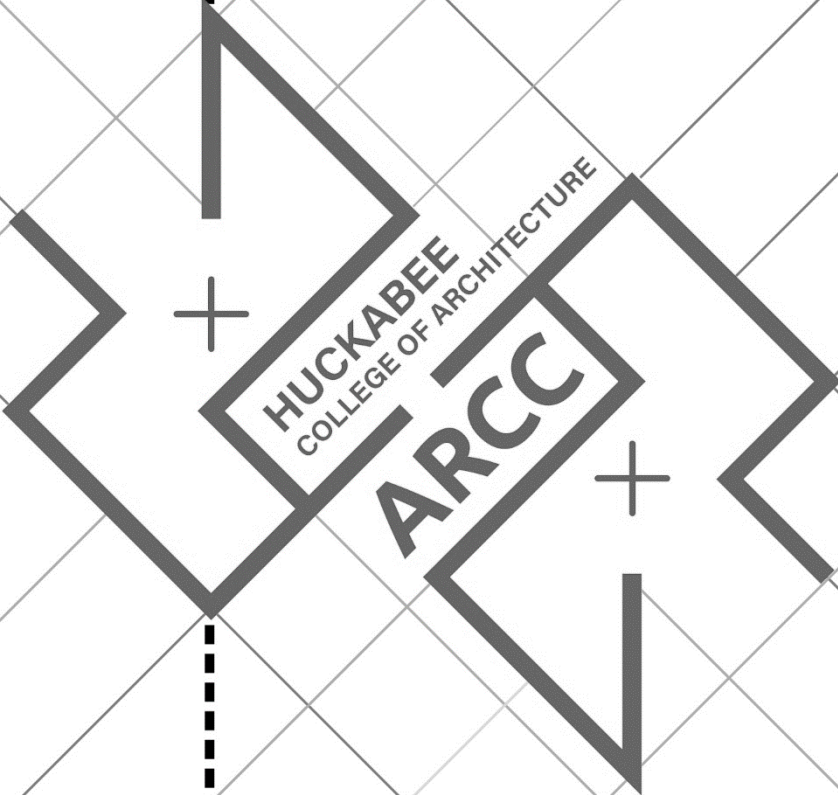

Behaviors and Failures; Using Novel Exercises as a Learning Tool in Teaching Structural Principles and Concepts to Architecture Students

Annica Streete¹

¹Louisiana State University, Baton Rouge, LA

ABSTRACT: Understanding how structures work, that is, thinking “structurally”, for the architecture student has been a longtime challenge in architectural education. Mario Salvadori, referred to as a dynamic personality by Henry Kamphoefner, in making his teaching imaginative and creative, in one of his talks, spoke of mathematics as a prerequisite of understanding structures and the need to abolish certain prejudices against mathematics. Salvadori followed with mention of three noted engineers, Pier Nervi, Felix Candela, and Eduardo Torroja, all masters of structural understanding, an understanding that has come through an extensive study of the mathematics that govern structural behavior. However, Salvadori notes that they became such experts that they forgot the mathematics and followed their intuitive feelings about how a structure will work. This paper does not advocate that students “forget” mathematics, its use is still fundamentally necessary to teaching structural theory and the students have not achieved the level of expertise mentioned above, rather it presents a testing of methods used in bridging structural principles and design thinking through novel exercises which capitalize on the intuitive-feeling approach. Ten precedent projects (five spanning and five towers) frame this heuristic and intuition-based methodology within this architectural structures II course. The first two thirds of the semester’s course time is dedicated to theoretical study, precedent research study and analysis, design, and construction. Following this initial sequence, the final third is dedicated to testing and analysis. More importantly, two strategically timed exercises accompany the scheduled sequence to reinforce abstract associations of the fundamental structural principles found in the precedents. Prior to the initial precedent research and analysis, the first exercise, a live performance demands students physically act out key structural forces separating the principle and concept from the precedent. The second exercise, a scavenger hunt, asks students to identify and document structural systems in the built environment of their everyday lives. Outcomes of this test sought to highlight student work product and collected feedback which support the efficacy of the Live Performance and Scavenger-Hunt exercises played, in the students’ conceptualizing of key structural concepts.

KEYWORDS: architecture student, bridging structural principles, novel exercises, structure and design thinking

INTRODUCTION

A survey of academic discussions regarding teaching structures to architecture students to foster understanding cover a range of methods. Discussions have identified the lack of efficacy of conventional methods, typically used in engineering specific programs, when teaching structural principles to the architecture student. Salvadori (1958) stated that the architect and engineer possess no common language, similarly it can be said that the architecture student and the engineering student speak a different language. Salvadori (1958) spoke of an *intuitive approach* based on models, an alternative method he stated at that time had not been marginally explored. Other alternative approaches include *active learning methods* as discussed by (Sgambi et al. 2019, 386-392) who points to this type of learning as an early concept put forth by English Scholar Reginald Revans in the early 1970s. Revans stated, “There can be no learning without action, and no sober and deliberate action without learning” (Pedler 2016, 5). Haptic learning methods and problem-based exercises were discussed by Whitehead (2013) as an alternative approach to engaging the architecture student more effectively in structures education. Whitehead (2013) continued to say that architecture students should be given a series of exercises that help to develop their understanding about the relationship of structural form and forces, structural behavior, and the array of potentially responsive architectural forms. Whitehead (2013) purported, and the same can be deduced for Salvadori, that a new educational model for teaching structures to architecture students was needed. New approaches and models have emerged across the academic landscape in Architecture Structures courses.

In this paper, the research surveys emergent pedagogical practices; the use of novel exercises by Rob Whitehead as presented in his text, *Structures by Design* along with an accompanying review of the topic of active learning for the promotion of students’ creativity and critical thinking in structural courses for architecture, presented in a paper by Sgambi, Kubiak, Basso and Garavaglia. Additionally presented in this paper, initial research testing and findings of two introduced novel exercises, as emergent tools, and their interjection in an architectural structures II course sequence. The research aims to quantitatively and qualitatively measure efficacy of the novel exercises across multiple installments of teaching the course.

1.0 SURVEY OF EMERGENT STURCTURES PEDOGICAL PRACTICES

The opening chapter of Whitehead’s text introduces the topic “Body Structures, The Feel of Things”. An interesting and thought-provoking question posed by a beginning design student is included at the beginning and it reads: “Are you sure this is architecture?” In thinking about the emergence of alternative pedagogical approaches in teaching structures to architecture students, this question leads to another question and an eventual realization of what pedagogical tools of instruction from within and outside of the architecture discipline are currently being considered or rather, can be considered as tools of instruction, capable of aiding students in the understanding of structural principles and concepts. Whitehead uses “poses of the body” to demonstrate an active way of learning structural principles and concepts. In this approach he states that simple acts we perform with our bodies such as standing up straight, holding a child on our hip or leaning over to pick up a bag of groceries, when categorized into movements pulling or pushing or twisting can generate fundamental understanding of how forces, loads, balance, stresses can be felt and understood by the student.

Whitehead’s body structure poses are set in a series of challenges where he asks the students to perform a physical structural activity and to discover what made an activity difficult or why they were unable to perform the activity with their bodies. Their experiences had to be recorded by documenting instances of the following but not limited to vertical measurements, achieved spans and types of stresses felt. This method of record provided a way for Whitehead to bridge and connect their understanding to the math and science of structural principles and concepts (Whitehead 2019, 1-137). The math and science of structural principles play an important role in reinforcing theoretical content, though formulaic and two-dimensional, I strategically use it by conceptually dissecting aspects of its conventional formulaic matter. To establish this pedagogical research, and survey the impact of the novel exercises, I have drawn from Whitehead’s approach in considering the body as a tool for learning structure and structural behavior, and by enacting my own experience and acquired knowledge in the field of dance to simulate static positions of structure in addition to kinetic and anticipatory conditions of movement (Figure 1).

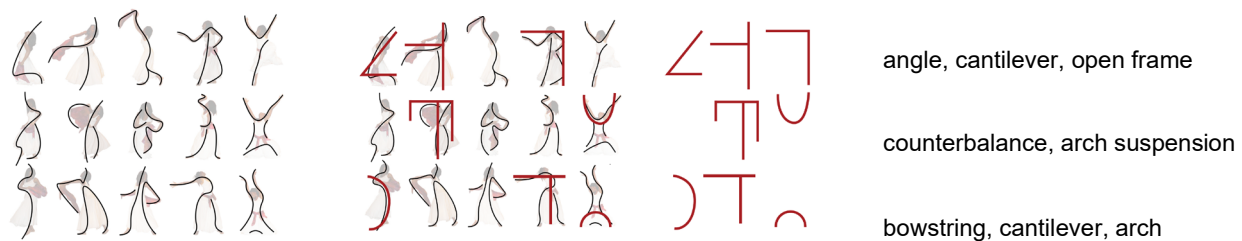

Figure 1: Diagram of Dance Frames and Body Structure Tracings, Found Transferable Body Structure Formations. Source: (Author 2020)

The timing at which novel activities are introduced and how they work in concert with conventional theoretical study are critical aspects of bridging structural knowledge. One such example of a timed introduction is demonstrated in Sgambi, Kubiak, Basso and Garavaglia’s paper on the introduction of an active learning experience within a structures design 2 architectural course. The authors’ Sgambi et al, strategy included introducing active teaching exercises in an alternating manner, with traditional course study in which the authors refer to as frontal lessons. The frontal lessons facilitated the introduction of theoretical concepts where formulaic content was further expounded upon by using mathematical demonstrations. In-practice architectural applications were also examined in this segment. An intermediate step followed the frontal lessons where the students were asked to apply the theoretical content in an analytic manner to a collection of architectural precedents. The authors stated that immediate application of this intermediary step allowed the professors to demonstrate close linkage of building composition and its spaces (Sgambi et al. 2019, 386-392). The stacking and stitching of conventional and active experience content as “novel exercise” mirror this approach. In conjunction with the final third testing and analysis, it forms the overall framework of the course sequence and the basis for this pedagogical research. The diagram below illustrates this framework (Figure 2). The focus of this paper investigates the usage and efficacy of novel exercises in bridging structural principles and concepts, establishing their placement within the overall framework is helpful and critical to deducing findings in this research.

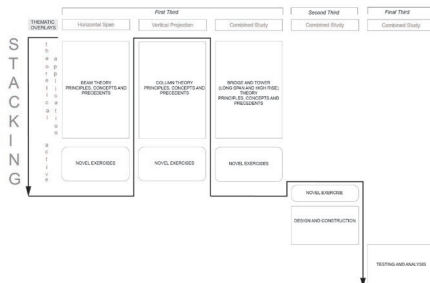

Figure 2: Diagram of Architectural Structures II Course Overall Framework, Stacking Approach. Source: (Author 2023)

2.0 COURSE SEQUENCE

One key aspect of the architectural structures II course is that it builds on the previous architectural structures I course and there is an expectation that prerequisite knowledge will be applied. A necessary start was not to immediately initiate the intended designed course sequence, but to investigate what previous knowledge the students were entering the course with, a pre-assessment (Table 1). Many learning landscapes employ pre-assessments with the goal of providing a marker of where the beginning understanding lies in prerequisite course content. (Farenga, Joyce, and Ness 2001, 10) state that it is an important factor of effective teaching and that through iterative discussion and by asking questions you can elicit students' understanding of a subject. In this research, the pre-assessment functions as a "proximity knowledge finder" where questions 1 - 2 query base structures knowledge of statics; understanding bodies at rest and how they react when acted upon by a force. Later, questions 3 - 7, begin to query structural component behavior knowledge. Whitehead emphasizes this as a critical understanding of these relationships, needed to master formal design and structural response.

Table 1: Architectural Structures II Pre-Assessment Survey. Source: (Author 2022)

	Question: Please write one concept or formula that you recall from last semester for the following topics covered (see topic listed below, please keep your responses in the order the topics are listed).	No. of responses (by question)
1)	Vectors, Equilibrium of Concurrent Forces	33
2)	Reactions, Two Force Members, Stability, Determinacy	28
3)	Pinned Frames, Cables, Trusses	30
4)	Centroid, Moment of Inertia, Parallel Axis, Axial Stress - Strain, Materials	26
5)	Shear and Moment Diagrams, Beam Formulas, Bending Stress	28
6)	Shear Stress, Deflection, Framing	26
7)	Beam Design, Columns, Buckling	26
	Notes: No. of students total (s_t) = 51 No. of respondents (s_r) = 39 Overall Response rate (%) = 76%	

A notable trend in the results of the re-assessment survey is the reduced number of responses in the form and behavior category (questions 3-7). A possible indication of the need for an appropriate bridging mechanism in transferring fundamental knowledge of structural component behavior, and an examination of the architectural structures I course as it pertains to needed knowledge base of architecture students (note: architectural structures I currently taught in the construction management course sequence, a sample of two current and related course outcomes state: 1) analyze internal forces, internal stresses and deflections on beams due to external loads and 2) design a simple beam based on loading and selection criteria). This deduction of the assessment sets a baseline for later corollary discussion of conventional tools and approaches to structures education for architecture students.

The architectural structures II course is divided into three sequential thirds, **the first third** focuses on theoretical study and precedent research and analysis, **the second third** focuses on design and construction and **the final third** shifts to testing and analysis. A secondary level of organization of course content is done through three thematic overlays. A deliberate decision to refer to these segments as *themes* engage the students' conceptual thinking. They also set the stage for the novel exercises to be played thematically. The following overlays were applied: Horizontal Span, Vertical Projection and Combined Study (Figure 3).

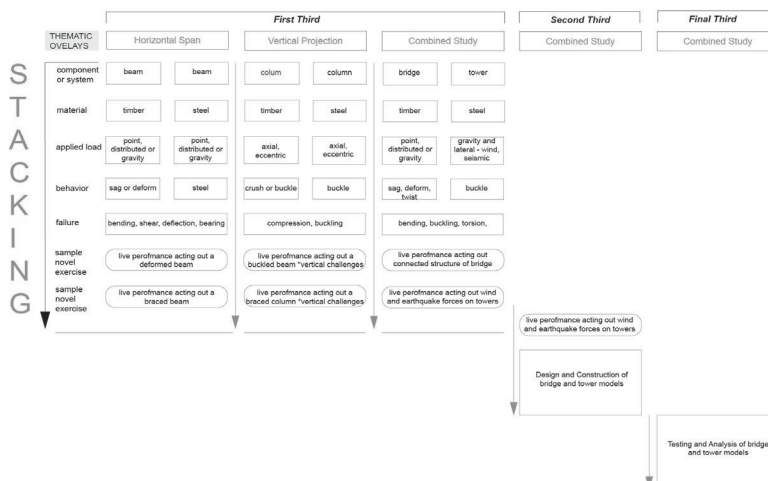

Figure 3: Expanded Diagram of how lecture discussions are built, and novel exercises interjected, *Stacking Approach*. Source: (Author 2023)

2.1 The First Third

Theory and Precedent Research Study and Analysis - In the text, *The Structural Basis of Architecture*, Chapter 2: Introducing Structural Systems, the authors pose a fundamental question that set the premise for the opening discussion of the course on day one. The question asked was “what types of structure exists?” (Sandakker et al 2019, 24). Two follow up questions were then posed to the students; “what kind of forces/loads act on a structure, and how might a structure behave when acted upon by a force or load (gravity or lateral)?” (Sandakker et al 2019, 24). These three lead questions form the strategy for knowledge building in this phase. As in a thematic performance the “stacking approach” in detail considers a subject, a scenario, a response, an outcome, building a story or narrative and revealing what is discovered and understood by connecting each previous step. The “stacking approach” is illustrated below and in Figure 3 (*note*: this architectural structures II course focuses solely on timber and steel structures). The timed novel exercises accompanied this approach in the sequence and was tested as a tool that could further bolster and bridge understanding in each scenario. Each timed novel exercise is discussed in detail later.

Thematic Overlay (Topical Area)

- Subject (component or system)
 - Scenario (applied load)
 - Response (structural behavior)
 - Outcome (failure mode)
- Timed interjection of Novel Exercise - Live Performances**
- Reflection (principle acted out to facilitate active learning)

Ten precedent projects were introduced next, five spanning and five towers. Each student group conducted a precedent study of an assigned truss bridge or tower. The intent of the study was to further familiarize students with the type of structure (truss bridge or tower) and utilize aspects of the study to inform the design of their own structure. The live performance played a key role here in establishing prior knowledge and visual memory of how these types of structures behave under a particular loading condition. In the study, the students were asked to research and report on the following aspects of their assigned structure; *for the bridge precedents*: name, location (city and state), year built, name of architect and/or engineer, type of truss design, total span, mid span length, length of largest span segment, vertical clearance above deck, deck width, overall width of structure and *for the tower precedents*: name, location (city and state), year built, name of architect and/or engineer, type of truss design, overall height of structure, total number of floors, floor area, core location and number of elevators. Both groups were required to write a statement on their theoretical understanding of the structural system and illustrate how the system functioned. Additionally, a statement expressing what aspects of their precedent research study they intended to incorporate into the design of their structure.

2.2 The Second Third

Design Prompt and Construction – Working in bridge teams and tower teams, each student group was tasked with developing a structural concept for their structure. The bridge design was to be conceptualized as a vehicular truss bridge and the tower design, a multi-story office space high rise. In the design, the following criteria were to be met; for the *bridge design*: a span length of one hundred and sixty feet, a bridge width of twenty two feet and a bridge maximum depth of fifty two feet and for the *tower design*: a total height of one hundred and twenty eight feet, a maximum floor area of one thousand, seven hundred and sixty four square feet, yielding a forty two feet by forty two feet floor plate. In considering their active experiences, acting out the behaviors of long span and high-rise structures, further attention was given to joints of their structural systems. No glue was allowed, only pinned connections. The basis here is that “real” behavior of their structures under loading could not be accurately simulated unless the actual connection condition was utilized. This provided an extended opportunity to bridge prior knowledge with an active learning environment. A campus structural field tour was conducted to observe in-practice components and structural connections in the field.

2.3 The Final Third

Testing and Analysis – The bridge and tower models were tested to determine maximum load capacity, and during testing, the students were asked to observe their structure’s behavior and response, while speculating on failure mode (Figure 4). Their speculation was aided by a recollection of enacted behaviors during the live performances. Documented pre and post testing conditions established the comparative analysis of the speculated behaviors and failures.



Figure 4: Five designed and constructed truss tower models and bridge models being load tested. Source: (Author 2022)

3.0 THE RESEARCH QUESTION

The use of *novel exercises* as a learning tool was first informally introduced into my architecture structures II course at my previous academic institution. It is a continuation and further development of earlier research inquiry, to study the use of the body to simulate structural principles and structural behavior within a formal lecture, the impetus for this research which lead to this focused study and framing this research through an examination of pedagogical practices within already established pedagogies, while carefully considering expected skills of the architecture student; design thinking, visual and spatial reading, understanding, and spatial problem solving. The first exercise, live performances that interject the formal lecture, become an anchor for lecture discussion. As mentioned in the earlier description of the course sequence, each thematic overlay sets the stage for lecture content in addition to the live performances. In each performance, students used their bodies to formulate by simulation, a specific structural component, as seen in examples in the stacked lecture content but void of materiality. An additional group of students simulate the applied load. A series of live performances were acted out, their descriptions and illustrations are described below.

3.1 Novel Exercise - Live performances

Performance A

Thematic Overlay: Horizontal Span
 Component: Beam
 Behavior: Sag or Deformation
 Failure: Bending

Counter Failure: Laterally Brace
 New Behavior: Stiffened Effect

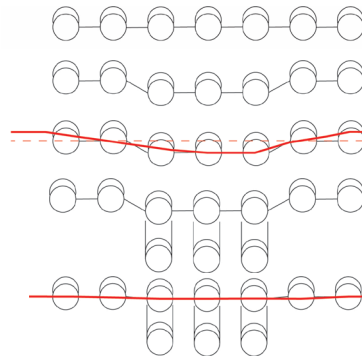

- 1 students standing in line at arms lengths.
- 2 three students step out of line simulating beam buckling.
- 3 original beam alignment compared to original position.
- 4 three new students step in and align themselves at the buckling location.
- 5 students simulate new braced condition of beam.

Figure 5: Diagram illustration of Performance A. Source: (Author 2022)

Performance B

Thematic Overlay: Combined Study
 System: High Rise
 Behavior: Lateral Displacement
 Failure: Displacement, Overturning

Counter Failure: Braced Core
 New Behavior: Stiffened Structure



Figure 6: Students live performing, acting out the behavior of a high-rise structure under lateral loading – wind. Source: (Author 2022)

3.2 Assessment of the Novel Exercise – Live Performances

Discussion accompanied by question/answer segments facilitated in class assessment of the live performances. Additionally, later in the design, construction, testing and analysis phases, and a secondary assessment accompanied

formal evaluation rubric sections that directly appealed to and tested their found sensibilities of the live performance exercise.

Sample Criteria from the Bridge and Tower Rubric:

Precedent Research and Study

- theoretical understanding statement (5 pts)
- statement of application intent (5 pts)

Concept Design, Design Development and Testing

- detailed description of concept of structure (10 pts)
- statement of application intent (5 pts)

Final Report

- report findings documentation (testing observation, failure observation: how and where failure occurred, use text and photos to demonstrate) (40 pts)

Sample Student Feedback on the Live Performances:

“The live performances that took place in our Structures II class were very helpful. As a visual learner, it is difficult at times to understand structural movement and assembly mechanisms through diagrams. Having a live demonstration of the elements of a structural assembly allowed me to understand the different roles of structural elements and their division of the loads.” – Student 02

“Any opportunity for demonstrations was so refreshing in our Structures II class last semester. By reenacting scenarios with the students, we could understand the structural principle at the human scale. It also forced students to engage in the material. I have always been complementary to that class based on the teacher’s enthusiasm and willingness to experiment with alternative teaching methods. The professor was selfless in the way they passionately expressed their desire for students to learn the material. I mean Learn with a capital L.” – Student 06

Taking the professor’s Arch 3004 transformed my insecurity of not retaining structural information to being able to understand. As a visual and kinesthetic learner, the professor’s teaching methods allowed me to retain the information very well. Class demonstrations were a common thing when new concepts were introduced. The use of this technique allowed my classmates and I to understand forces of tension of compression by acting as the members pushed & pulled on. – Student 12

3.3 Novel Exercise - Scavenger Hunt

The Structural Component Finding and Documentation exercise also known as the *scavenger hunt* asked that students step out of the classroom, into the built environment to observe their surroundings from a structures perspective. They were asked to find each of the following structural components listed below and to document the component using photography and graphical annotation.

- | | | |
|----------------------------------|-----------------|------------------------------------------------------------|
| 1. a steel bridge | 5. a solid pier | 9. an arch (from any structure) |
| 2. a wood bridge | 6. an open pier | 10. a wood or steel column |
| 3. a concrete bridge | 7. a pier cap | 11. a girder (*bonus find/ extra credit!) |
| 4. bridge decking (any material) | 8. an abutment | 12. a bridge suspension cable (*bonus find/ extra credit!) |

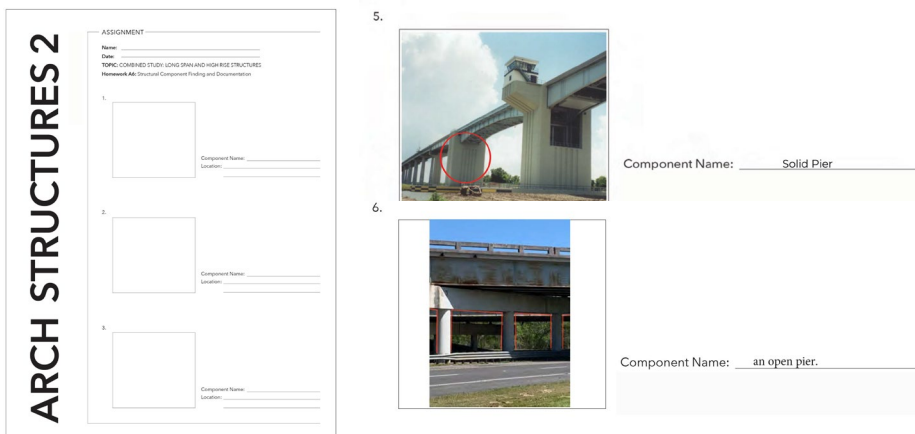

Figure 8: Sample student report, structural component finding and documentation. Source: (Author 2022)

3.4 Assessment of the Novel Exercise - Scavenger Hunt

Twelve structural components were to be found in the built environment, identified, and documented. Of the 47 students that were enrolled in the course 44 completed the assignment, a 93.6% completion rate. Identification rates of the required components were as follows: 42/44 students correctly identified components 1 through 10, a 95.5% identification rate. 36/44 students were able to identify the at least one of the two additional advanced content, components 11 through 12, an identification rate of 81.8%. 16/44 identified one of the advance components, over one third of the students (36.4%) and 23/44 (52.35%), over half of the students identified both advance components. While the rates for the identification of components were favorable and the identification rate for the advance components yielded lesser percentages, attempting the more advanced identification, components 11 through 12, challenged theoretical understanding first and the novel exercises mostly aided in the observation of components 1 through 10.

Sample Student Feedback on the Scavenger Hunt:

"I felt the structural component scavenger hunt was beneficial and a fun activity. It was a great way to get outside the classroom and recognize the items in our day to day lives that we discussed about in class. It was also enjoyable to learn more about the structure of campus and the surrounding areas." – Student A

"The Structural Component Scavenger Hunt was helpful because it bridged lecture content and real-world application. It also affirmed a lot of assumptions I was making about structural elements outside of class. Now, I feel more confident in the fact that I can notice a structural element and its role in a structural system." – Student B

"This assignment was actually really cool; I think it really helps in recognizing what the structural components look like in real life. It really expanded my knowledge on a lot of structural systems too and every time I see a bridge or girder I always find myself thinking back to this assignment. It was also super fun since my friends, and I went out to the city to take pictures." – Student C

"When we were first assigned this, I think I underestimated how challenging this assignment would be. When we reviewed the answers, I was shocked to find out that I had gotten most of the answers wrong. This discussion was actually so helpful in understanding all of the different structural components. When I drive past a bridge, I can still name all of its components because of this." – Student E

CONCLUSION

The use of novel exercises in conventional pedagogical practice poses a unique experience for the architectural student that shifts away from sole conventional structural education approaches. The experiential learning theory (ELT) defines learning as the process whereby knowledge is created through the transformation of experience. Knowledge results from the combination of grasping and transforming experience (Kolb and Kolb 2005, 194). This research established settings within which transformative learning is experienced. Two defined novel exercises as approaches and tools in bridging architectural principles were studied, the live performances demonstrating structural behavior and failure, and a scavenger hunt. The survey of recent architectural structures pedagogy presented two selected transformative and experiential scenarios. In Whitehead's architectural structures course education, the *body structure poses* provided individual and collective transformative experiences in trying out structure before principles were learned. Sgambi et al demonstrated active learning experiences by redesigning an architecture structures course to consider the sequencing of three exercises with an interjected active learning exercise. Here the principles were studied then immediate application required the students to test their understanding by engaging in-practice applications and documenting their understanding.

Final results of this study identified a correlation and advantageous opportunity in using novel exercises as teaching tools in bridging architectural structures knowledge for the architecture student. The pre-assessment survey revealed that there is a notable disconnect in retainage of structural content and fundamental understanding of structures for the architecture student, in conventional architecture structures course settings. The strategically timed interjections of novel exercises combined with conventional theoretical content delivered, where they each reinforce architectural structural principles and concepts, cultivated learning experiences that were transformative for the architecture students as seen in the sample feedback and assessment of the novel exercises. Future studies will continue to critically examine architectural structures approaches and practices as they continue to evolve and advance the pedagogical landscape of teaching structures to architecture students. Pedagogical research will continue to question and study where, when, and what possible opportunities for experiential learning can be devised for the architecture student learning structural principles and concepts and incorporated in settings of architecture structures education. From this study the following research trajectories are planned: a survey of programs within which architectural structures education exists. Many are embedded within construction management and engineering programs. A comparative analysis and assessment by location within a program will present further opportunities for measuring efficacy and provide additional investigative investigation tools in the deducing the efficacy using novel approaches within an architectural structures course. This current method is intended to be tested in several more installments of teaching this architectural structures II course. Continued and expanded assessment modes of the novel exercises through student work and feedback to comparatively assess efficacy across multiple cohorts of architectural students will be introduced.

ACKNOWLEDGEMENTS

The author would like to express thanks to the students of the Arch 5360 Architecture Structures II (previous academic institution), the Arch 3004 Architecture Structures II courses (current academic institution), and the LSU Provost's Fund for Innovation in Research.

This work was supported in part by the LSU Provost's Fund for Innovation in Research – Faculty Grant Program

REFERENCES

- Farenga, S., Joyce, B., and Ness, D. 2001. "Bridging the Knowledge Gap." *Science Scope* 25 (1): 10.
- Kolb, A., and Kolb, D. 2005. "Learning Styles and Learning Spaces: Enhancing Experiential Learning in Higher Education." *Academy of Management Learning & Education* 4 (2): 193–212.
- Pedler, M. 2016. "Reginald Revans: The Pioneer of Action Learning." 1–19. https://doi.org/10.1007/978-3-319-49820-1_20-1.
- Salvadori, M. 1958. "Teaching Structures to Architects." *Journal of Architectural Education (1947-1974)* 13 (1): 5–8. <https://doi.org/10.2307/1424174>.
- Sandakker, B., Eggen, A., Cruveller, M. Structural Basis of Architecture. 3rd Edition. Routledge, 2019
- Sgambi, L., Kubiak, L., Basso, N., and Garavaglia, E. 2019. "Active Learning for the Promotion of Students' Creativity and Critical Thinking: An Experience in Structural Courses for Architecture." *Archnet-IJAR: International Journal of Architectural Research* 13 (2): 386–407. <https://doi.org/10.1108/ARCH-11-2018-0018>.
- Whitehead, R. 2013. "Supporting Students Structurally: Engaging Architectural Students in Structurally Oriented Haptic Learning Exercises." In *AEI 2013*, 236–45. State College, Pennsylvania, United States: American Society of Civil Engineers. <https://doi.org/10.1061/9780784412909.023>.
- Whitehead, R. *Structures By Design, Thinking, Making, Breaking*. 1st Edition. Routledge, 2019

Learning Opportunities Through Immersive Technology: A Comparative Analysis Between Traditional and XR-Aided Learning in Design

S Y Andalib¹, Muntazar Monsur¹

¹Texas Tech University, Lubbock, TX

ABSTRACT: In recent years, there has been a substantial rise in interest in the field of virtual technology that is related to immersive experiences and is collectively referred to as Extended Reality (XR). XR applications are being employed in a diverse range of areas for education and training, including AEC (Architecture, Engineering, and Construction), visualization, and community involvement in design. These applications provide solutions that are both cost-effective and conducive to experiential learning. Design disciplines require a visual and experiential understanding of complex spaces and their relationships, and this attribute could benefit significantly by incorporating XR in design pedagogy. Nevertheless, XR-based learning and training are still in their infancy and require further research to get an optimized outcome from this sector.

This study explores an XR application - Virtual Reality (VR) technology to teach landscape-related topics such as landforms and earthwork to a group of landscape faculty and students, and then attempts to analyze its effectiveness as an instructional tool through mixed-method research. The participants in the study were initially given the task of resolving a standard Landscape Architect Registration Examination (L. A. R. E) vignette after being randomly allocated to either a control group or an experimental group for the study. The experimental group received both a traditional online lecture as well as an immersive virtual reality (VR) learning module. The control group only received the traditional online lecture. After that, both groups took part in a focus group discussion regarding their general experience, the role of XR technology in landscape architecture pedagogy, user interface, ease of access, scope in landscape education, and their perspectives on the potential of XR technology in the field of landscape architecture in the future. In order to gain a deeper understanding of the user experience regarding the functionality of the XR learning module, a survey using the online platform Qualtrics was carried out. An in-depth understanding of the users' perspectives regarding the potential and future development of XR instructional tools for landscape education was revealed via data gathered from all the sources combined: including the experiment, the focus group discussion, and the online survey.

The experimental portion of the study did not yield any significant group variations; nevertheless, the qualitative data collected from the focus group and the survey showed a positive outlook regarding the application of XR for immersive and experiential learning in landscape architecture.

The results of this study will serve as a foundation for further development and applications of XR technology in the fields of design including architecture, landscape architecture, interior design, urban design, etc. Also, the data gathered from this study will act as the primary source of feedback for the next iteration of the development of the XR application, as one of the findings of this study showed that the XR application development process should follow a customized iterative development process (namely Agile Development) that takes in feedback from the users to improve upon its present iteration.

KEYWORDS: XR, Design, Landscape Pedagogy, Mixed Method Research, VR Application Development, Game Environment for Learning.

INTRODUCTION

As an aftermath of the COVID-19 pandemic, architecture and urbanism experienced changes, and things will never be the same in the future (Megahed and Ghoneim 2020), and design and planning processes adapted to these changes (Everard et al. 2020; Pan et al. 2020) with an increased acceptance of technology such as distance learning, communication, interactive presentation and information sharing via online tools (Megahed and Ghoneim 2020).

On the same note, an unprecedented change has been observed in the education system, when institutions were forced to deliver lessons via only digital/online platforms. Although the restrictions enforced by the pandemic have been lifted, new digital engagement has become the new norm regarding the education sector in the post-pandemic world (Megahed & Ghoneim, 2020), as the use of media for information sharing, and webinars for skill sharing have been adopted during the COVID-19 pandemic (Goniewicz et al. 2020; Chick et al. 2020). This has created the opportunity to apply smarter solutions such as Augmented Reality (AR) or Virtual Reality (VR) to the built environment design process (Megahed and Ghoneim, 2020), and the trend of usage of technology is expected to continuously increase (Gracy et al. 2020; Muggah and Ermacora 2020).

Although the application of Extended Reality (XR) tools has long been researched in education, their effectiveness in landscape architecture education is relatively unexplored. In this context, it has become critical to reconsider landscape architecture learning methods and complex concepts such as understanding and designing landforms, as well as theoretical concepts related to it such as contour lines, site grading, and redesigning landforms with earthwork such as cut and fill. How these immersive technologies are used in landscape teaching and learning of such difficult topics in contrast to conventional learning may provide fresh insights for landscape design education in the 'new normal' of the post-pandemic world.

Why Use Extended Reality (XR) Aided Pedagogy for Landscape Learning

Digitizing educational content and creating engaging interactive instructional materials are equally important as online delivery methods. One major pitfall regarding online delivery methods is the lack of proper interaction with instructors (Adnan and Anwar 2020). Alongside this, virtual classes pose less to no appeal to students who are tactile learners. Classroom socialization is usually missing in online learning, and digital communication with peers often results in the failure of real-time idea sharing, alongside sharing of knowledge and information (Britt 2006). These show that there is a strong need for academic organizations to improve their curriculum in terms of adapting new instructional methods (Toquero 2020), and for precisely these reasons, it is high time for a discussion on adapting XR in the field of landscape architecture education.

Although development as a landscape architect often requires complex site-specific understanding that occurs outside the classroom (Kerr and Lawson 2020), the conventional mode of landscape architecture education has long been studio-based (Chou 2018). One of the main reasons behind this is the fact that disciplines such as environmental sciences, geography, and geology, that require site visits for the experiential immersion of the student are facing time and budget constraints (Smith 2004). On that basis, tools that enable students to free-roam through learning environments could be proposed as a viable solution (Kerr and Lawson 2020).

Present State of Landscape Architecture Education

Experiential learning in landscape architecture not only helps achieve course objectives but also increases professionalism and student engagement outside of class hours. However, these projects require different teaching strategies and methods, where instead of performing as a lecturer, the instructor must shift the mode of learning to student-centric rather than lesson-centric, and understand the divergence within the cohort learning objective (Stearns 1995). When selected and administered properly, the hands-on approach of a project tends to accomplish a wider range of instructor-student objectives (Stearns, 1995). XR could come into play in the role of a bridge, where the instructors don't have to sacrifice the experiential interaction of the conventional methods while adapting to the technological aspects of online and distance learning.

Present State of XR Usage in Landscape Architecture Education

It is evident that a paradigm shift is imminent in the field of landscape architecture education due to the very nature of experiential learning, along with the advent of immersive technological platforms such as the omniverse and metaverse. The improvement in terms of the instructor-learner relationship in virtual learning space calls for this adoption as well. Along with this, it is to be noted that the mode of landscape construction learning in an academic environment is still in an experimental phase, and has room for innovation.

Researchers argue that social virtual reality settings may improve distant education effectiveness when utilized with contextual, experiential, and game-based learning (Holly et al. 2021), which is of utmost importance in a world where distant synchronous and asynchronous learning is becoming the new norm (Megahed and Ghoneim 2020). The usage of VR in education has proven to yield effective improvement in knowledge acquisition amongst students (Fernandez 2017), and research shows that among the different fields of education, laboratory simulations (e.g., safety training), procedural skill development (e.g., surgery), and STEM education are among the first application fields where AR and VR-supported teaching achieves excellent results in terms of overall training speed, performance, and retention (Mystakidis 2022).

But due to the novel nature of XR technology, there is a significant gap in the body of research regarding the usage of XR in landscape architecture. But the studies indicate that games have a positive effect on spatial learning (David 2012; Quaiser-Pohl, Geiser, and Lehmann 2006) and a first-person perspective game environment could be a valid alternative to the practical site visit (Carbonell-Carrera et al. 2020). In terms of the application of XR tools in different stages of landscape design, it is seen that the AR tools offer a more individualized learning experience through a 'burst of information, allowing learners to engage with theory while being surrounded by a real site, potentially solving the limitation of the site visit (Kerr & Lawson, 2020).

One of the important aspects of the usage of XR in landscape architecture is its modality, and almost all the studies conducted on the subject have used pre-built tools such as Google Tiltbrush, Lumion, or some form of 360-degree spherical image or video for creating the immersive experience (Deng et al. 2019; Johnson, George, and Hill 2019; Li, Cheng, and Yuan 2018; Lombardo 2018; Wu et al. 2021), whereas only one study uses custom toolset made with the game engine Unity (Portman, Natapov, and Fisher-Gewirtzman 2015).

A gap in this domain of research includes the usage of the technology in "Landscape reading" methods, such as understanding contour lines to manipulate landforms and earthwork; alongside the lack in the usage of true immersion techniques through the utilization of game engines, which leads to the lack of effective pipeline development for the process of application development.

This study examines two key research questions among landscape architecture educators and learners: (1) Can XR-aided Landscape learning yield a better learning outcome than conventional landscape learning? If not, what is it lacking? (2) How can the user interface and user experience be improved in an immersive experience for learning in landscape architecture?

1.0 RESEARCH METHODOLOGY

The primary goal of this study was to compare conventional and XR-assisted learning approaches in landscape design. To assess the effect of the intervention (an immersive learning environment), an experimental study approach was needed (Groat & Wang, 2013). At the same time, since the XR platform was designed to be an iterative process, gathering input from participants was a critical step in creating meaningful data. As a result, a qualitative study approach focusing on the interpretation of user experience was necessary (Groat & Wang, 2013). Due to the lack of sufficient sample size, emphasis was put on the deeper analysis of a focus group study, which led the researchers to heavily rely on qualitative data as well. In conjunction with all of these reasons, a mixed-method research design was applied due to its capability the integration between both qualitative and experimental research design (Groat and Wang 2013). The research design included a group of participants who were divided into two groups at random: control and experiment. They were all required to watch a series of instructional videos that served as an introductory learning module on landform, earthwork, and site grading in landscape design, and represented the conventional form of landscape architecture learning, which is through class lectures. The control group was then required to solve a site grading vignette related to the learning module on the day of the experiment, whereas the experimental group experienced a set of immersive environments in virtual reality (VR) space related to the learning modules and then solved the same vignette afterward. The participants' performance served as experimental data for comparing conventional (lectures alone) and XR-aided (lecture series Plus VR) learning approaches. Following the test, the control group was exposed to the immersive modules.

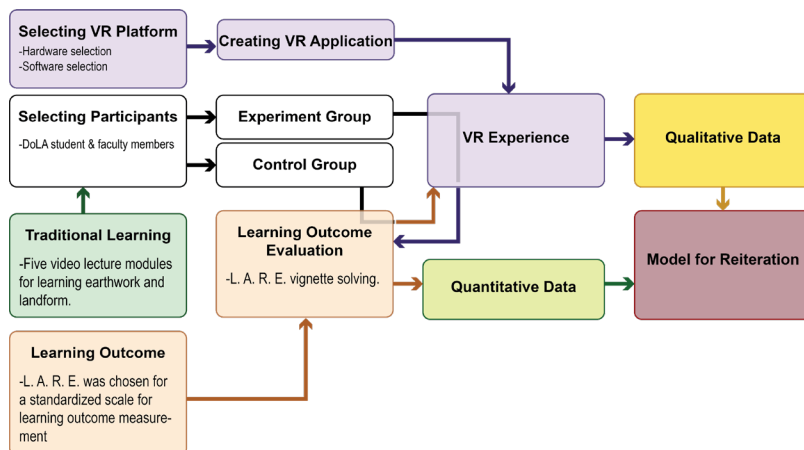

Figure 1: Mixed method research design (Andalib, 2022)

Later, both groups participated in an open discussion on the effectiveness and future usage of immersive technology in terms of teaching and learning. This provided descriptive insights through qualitative analysis on the development of XR technology for further iterations.

1.1. Learning Module Selection

Learning modules consisted of five lecture videos on landforms, earthwork, and site grading. The videos were provided by another instructor of the Department of Landscape Architecture, who has extensive teaching experience on the topics. The topics tie back to the Landscape Architect Registration Examination (L. A. R. E.); an examination that assesses prospective landscape architect licensees' knowledge as practitioners to protect public health, safety, and welfare (CLARB 2020).

These lecture videos acted as a prerequisite for both the control and experiment groups of participants focusing on five landscape topics - Landform, Earthwork, Slope Calculation, Cross Slope Calculation, and Calculation for Placing a Terrace on a Sloping Site.

1.2. Immersive Platform Selection

This step consisted of two tasks - hardware selection for viewing the immersive experience, and software selection for creating an immersive platform that would contain the learning modules and convert them into smaller understandable chunks of experience.

1.2.1. Software Selection

Unreal Engine 4.27.2 was used to create the immersive learning platform, and it was selected over any other platform of game development at the time of the experiment due to engine stability, allowing for a consistent pace of application development without any bugs; the existence of Unreal Datasmith, allowing for seamless connection with other modeling software such as Twinmotion or Rhino 3d (UnrealEngine 2021); the OpenXR plugin in the engine, which provided with cross-platform Application Programming Interface (API) (Khronos 2019), allowing future iterations of the application within any platform.

1.2.2. Hardware Selection

To access the immersive learning modules, the participants needed access to a Head Mounted Device (HMD). The decision of choosing the HMD was made based on the popularity and accessibility of the device, and Oculus Quest 2 was chosen to serve as the VR equipment of the experiment, as 47.99% of the participants in the Steam Hardware and Software Survey rated it as the most popular headset in May 2022 (Steam, 2022), and at the time of the experiment, it was more affordable than any other VR headsets of similar functionality, making it more approachable to the user groups that participated in the experiment.

1.3. Data Collection

1.3.1. Participant Selection

A request for participation in the research was distributed amongst the teachers and students in the Department of Landscape Architecture, Texas Tech University. Six respondents participated in the research: four lecturers and two graduate students. Faculty members ranged in age from 25 to 50 years, while graduate students fell between the ages of 35 and 30. On the day of the research, they were randomly divided into two groups: experiment and control, with three participants in each group. It was ensured that the participants did not have any medical conditions that prevented them from using VR headsets, and due to the limitations of the VR headsets, they did not have any visual or hearing impairment.

1.3.2. Workshop

The experimentation took place in form of a workshop. The workshop had a prerequisite and consisted of different treatments for the two groups of participants, and later a post-workshop focus group discussion and Qualtrics survey session.

1.3.2.1. Immersive experience

Two immersive learning modules were developed with Unreal Engine 4.27.2 and the OpenXR plugin, and Oculus Quest 2 VR Headset with handheld controllers was used in association with the Oculus Link. The immersive experience took place before the examination for the experiment group, and after the examination for the control group. Each module was essentially a VR game that featured several levels, dividing the learning topic into manageable portions for the users, and the users navigated from level to level using an interactive menu that could be controlled by the handheld VR controllers. The locomotion inside the immersive experience was open for both physical and controller-based movements.



Figure 2: Participants using the immersive learning modules in workshop sessions. Source: Muntazar Monsur, PhD.

Two immersive learning modules were developed with Unreal Engine 4.27.2 and the OpenXR plugin, and Oculus Quest 2 VR Headset with handheld controllers was used in association with the Oculus Link. The immersive experience took place before the examination for the experiment group, and after the examination for the control group.

Each
The first module was focused on the theoretical base of landforms, with related real-life examples. The module consisted of the following levels:

- Landform Definition: A museum-like display that consisted of kiosks containing definitions of landforms from several disciplines with small-scale 3d models of each.
- Landform Composition: A level with an explanatory video on landform composition and realistic real-scale models of different elements of those compositions, such as sedimentary, igneous, and metamorphic rocks.



Figure 3: Different types of rocks with realistic textures for the user's understanding of landform composition (Andalib, 2022).

- Landform Types: an explanatory video followed by a journey to the real sites were provided at this level. Real sites were made by the usage of real-world 360 photographs of the sites downloaded from Google Street View.

The second module focused on a spatial understanding of landform types, and the impact of their manipulation on a real scale. This module consisted of the following levels:

- Explanatory Video: An introductory video on how different types of contour lines identify different landform features was shown at this level.
- Navigating Through a Mountain Range: A real mountain range was selected with different components of landform such as peak, valley, saddle, ridge, draw, spur, etc. The users were provided with a flat 2d map in order to see the contour lines that would represent the contour line drawing on a flat piece of paper, and at the same time experience their 3D outcome through navigation through the environment, helping them relate the 2D Drawings on a paper to a wholistic 3D visualization.

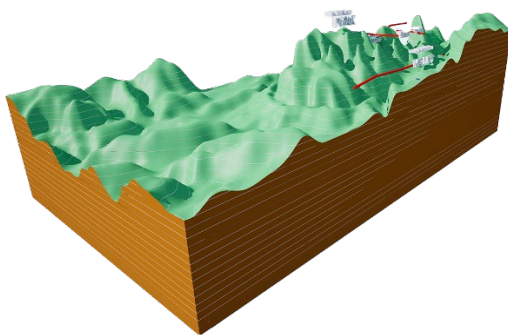

Figure 4: A scaled mountain range for the users to roam around and have an understanding of contour lines(Andalib, 2022).

- Problem Vignette: The last level consisted of a real-scale problem vignette from the L.A.R.E: placing a terrace on a sloping site. The purpose of this level was to demonstrate to players the real-world effect of their decision and how their solution would influence a site in terms of scale and health, safety, and welfare; such as what a 2% slope would truly imply in a real site, or what the consequence of failing to establish sufficient drainage could be.

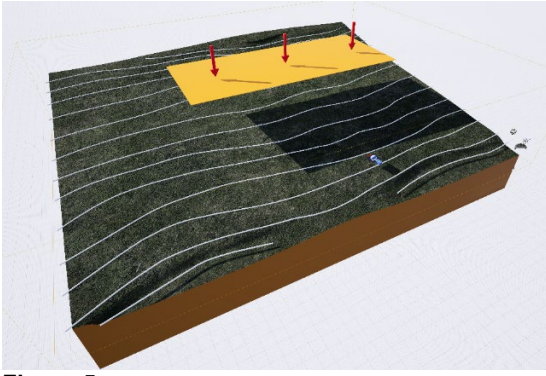

Figure 5: Problem vignette in real scale (Andalib, 2022).

1.3.3. Performance Vignette

The participants were required to solve a performance vignette that is directly related to section 4 of the L.A.R.E. The control group of participants took the test before having the immersive experience, and the experiment group took it after the immersive experience. The result of solving the problem served as quantitative data for how well the immersive experience is performing.

1.3.4. Focus Group Study

After the workshop sessions, a focus group study took place, which involved gathering qualitative data through transcribing conversation verbatim. The questions were administered by one of the researchers, and by nature, the questions were open-ended and fluidly probed into different aspects of the immersive experience. The verbatim transcription was later coded in-vivo so that relationships between different codes could be established.

1.3.5. Post Workshop Survey

After the workshop, participants were asked to complete a survey to provide feedback on their experience. The survey was conducted using Qualtrics and contained questions about the overall workshop experience, the use of technology, and the content covered. This contained the following survey questions

1. A Likert scale on immersive experience as a learning module.
2. A Likert scale on the accessibility and user experience of the immersive experience during research activities.
3. An open-ended question on the parts that were most enjoyable in the VR experience during the workshop sessions.
4. An open-ended question on the aspects that were disliked in the VR experience during the workshop sessions.
5. A Likert scale on what the immersive experience provided during the workshop session.
6. An open-ended question on the participants' opinion on what could be done to improve the immersive experience so that it can become more effective as a learning tool for the teaching concepts provided in the workshop sessions.

2.0 Results and Discussion

The data gathered through both quantitative and qualitative means were analyzed to answer the research questions.

2.1. Quantitative Data Analysis from the Experimental Research Process:

The results yielded from the experimental research process did not indicate any differences. The examination sheets from the participants were graded by the same faculty member of the Department of Landscape Architecture who provided the traditional online learning modules (lectures), and both the control group and experiment group carried out the same performance: one (1) pass and two (2) fails in each group.

Although the experimental research portion failed to gain any useful insights in terms of comparing the different learning methods, this phenomenon could be attributed to the limitations of the research design such as a low number of participants (only six participants in total), the inability of the participants to complete the online module prior to the experiment, and insufficient levels inside the immersive learning module for a deeper understanding on the problem. The limitations along with the user feedback provided a guideline for the next iteration of the VR application development.

2.2. Qualitative Insights from Focus Group Discussion:

The focus group interview session provided useful information on the user feedback regarding the thoughts, experiences, pitfalls, and expectations regarding the VR Learning Modules that were perceived by the participants.

A comprehensive Codeline analysis was made with the software MaxQDA, and it provided interrelated codes and the overall meaning of the conversation.

Comparing one set of code with another provided different indicators, such as if the Code set "Future Potential" was paired with "Assessment", it was obvious that most of the focus group participants assessed the future potential of the

immersive technology with positive potential. The faculty members pointed towards the potential of teaching and learning, whereas the students pointed out the creative ways they could use the technology to present their ideas more effectively, given the availability of the technology.



Figure 6 : Codeline: focus group participants have associated future potential with mostly positive feedback (Andalib, 2022).

When pairing the sets “Learning” with “Assessment”, similar results were observed. This could be justified by the participant’s positive experience with the VR learning environment. Many faculty members criticized the sandbox-like implications of the technology, which might prevent them from achieving the required design outcome, despite the favorable remarks made about learning. This pointed to the requirements of subsequent application development iterations with additional constraints.

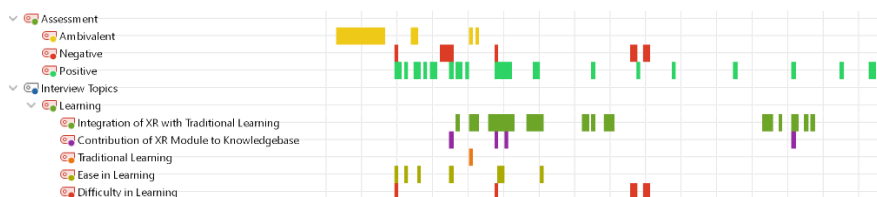

Figure 7: Codeline:: Positive experience in a virtual learning environment with minimal difficulty (Andalib, 2022).

When talking about learning, the topic of future potential came up numerous times, showing that both the faculty and the students hold a firm belief that landscape architecture education will benefit from immersive technology.

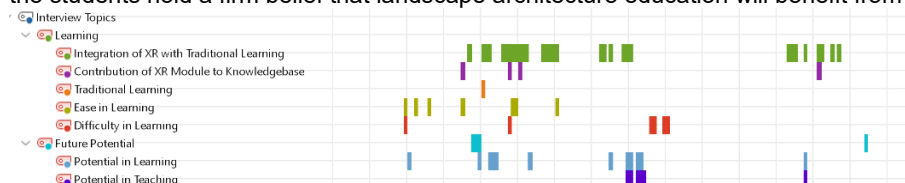

Figure 8: Codeline: Positive feedback associated with usage of the immersive technology (Andalib, 2022).

Amongst other topics, an association of real scale, and the potentials that were deemed “powerful” were associated with positive future usage. And even though the technology has not been perfected yet, and has a record of creating physical distress in other case studies (Cobb et al. 1999) the topic of physical distress only came up once due to the average usage of forty-five minutes of VR Headset usage, and even then the participants attested that the physical discomfort was mitigated by natural elements inside the learning modules, such as flowers, groundcovers, and trees. This provided useful criteria development while developing for full-scale virtual learning module.



Figure 9: Codeline: Assessments associated with challenges in usage and physical difficulties (Andalib, 2022).

2.3. Understandings from Post-workshop Survey Results

The user Interface and User Experience received mostly positive reviews. The novelty and fun of navigating the VR experience made it more user-friendly. However, accessibility and technical challenges indicate that more iteration is needed to maximize media affordance. These findings support previous research and agree that VR technology makes the inaccessible accessible, improving student learning (Portman et al., 2015). This suggests that an advanced Virtual

Learning Experience could replace a site visit, alleviating universities' financial and time constraints (Webb and Stafford 2013) .

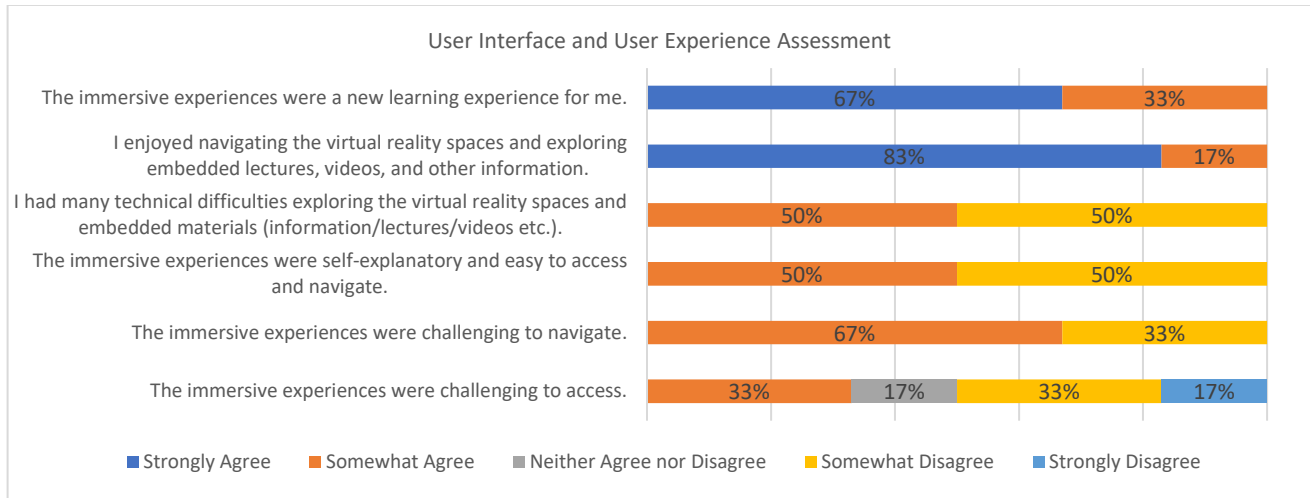

Figure 10: Likert scale on user interface and user experience assessment (Andalib, 2022).

All the participants agreed that the immersive experience was helpful to some extent, focusing on the specific learning contents. Also, the majority of the participants stated that immersive experiences would be most helpful after an actual site visit. This statement ties back to the first research question and states that at the current stage of development the tool cannot substitute an actual site visit. This is indicative of the need for further iteration of the application development as well.

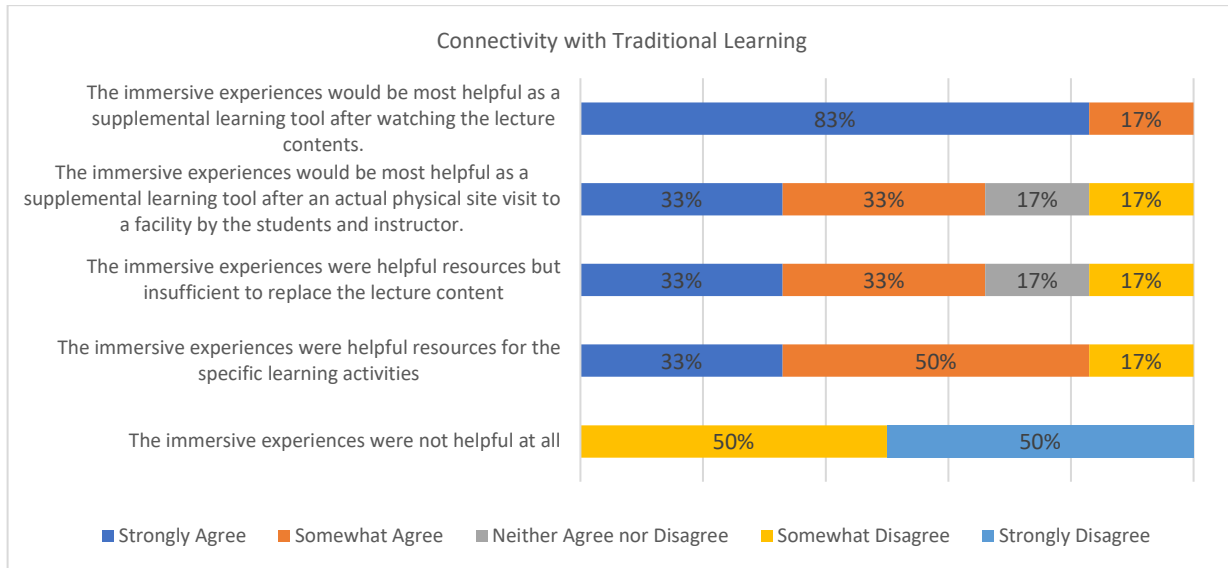

Figure 11: Likert scale showing the user feedback on the connectivity of the VR learning module with lecture content (Andalib, 2022).

CONCLUSION

This research aimed to explore the effectiveness of XR technology for landscape architecture education as an extension to conventional course delivery methods such as site visits, design studios, and lectures. Based on qualitative analysis it is clear that instead of only using the XR technology to substitute the conventional methods of learning, a blend of XR technology with the traditional model of learning is preferred by the users. At the same time, this research uncovered useful insights into the User Interface (UI) and User Experience (UX) design for a VR module for landscape learning based on user feedback. The quantitative analysis portion of the research found the necessity of further iteration of the Virtual Environment System (VRS) design.

Although the quantitative data gathered from the research shows that in its present iteration, the application could not result in an improvement of the learners' performance, it does add value in acknowledging the fact that the application needs further iteration. In addition, methodological limitations, such as the insufficient number of participants, prevented the collection of sufficient data points for statistical analysis, emphasizes the need for a long-term study to get

meaningful quantitative data. These results lead to iterative application development processes, such as Agile development, which would take into account long-term user feedback.

Another limitation that needs to be addressed is the chosen participants were from department of landscape architecture. Although this factor helps the researchers to gather effective data and feedbacks from the perspective of landscape architecture teaching, the feedback received from this group may not be representative of other types of learning environments or participants with different backgrounds or experiences. To address this limitation, future studies could include a more diverse group of participants from different departments or fields of study. This would allow researchers to gather more varied perspectives and feedback, which could lead to more comprehensive and accurate conclusions. Additionally, researchers could also consider conducting a comparative study across multiple departments or fields to compare the effectiveness of different teaching strategies and methods in various contexts. This would help to identify commonalities and differences in learning across different domains, and provide insights that could inform more effective teaching practices across multiple disciplines.

This research could be applied to the professional application development pipeline for landscape architecture. Further iterations of the application will result in practical values for teaching and learning landscape topics that have direct implications for professional success and better design for human health, safety, and security. This research could be used as a model for integrating landscape architecture into an XR-aided learning system beyond landform and earthwork and could spark a paradigm shift in landscape education, incorporating new collaborative platforms like Metaverse and Omniverse to adapt to future standards.

REFERENCES

- Adnan, Muhammad, and Kainat Anwar. 2020. "Online Learning amid the COVID-19 Pandemic: Students' Perspectives." *Online Submission 2* (1): 45-51.
- Britt, Rebecca. 2006. "Online education: A survey of faculty and students." *Radiologic technology 77* (3): 183-190.
- Carbonell-Carrera, Carlos, Jose Luis Saorin, Dámari Melián-Díaz, and Stephany Hess-Medler. 2020. "Spatial Orientation Skill Performance with a Workshop Based on Green Infrastructure in Cities." *ISPRS International Journal of Geo-Information 9* (4): 216.
- Chick, Robert Connor, Guy Travis Clifton, Kaitlin M Peace, Brandon W Propper, Diane F Hale, Adnan A Alseidi, and Timothy J Vreeland. 2020. "Using technology to maintain the education of residents during the COVID-19 pandemic." *Journal of surgical education 77* (4): 729-732.
- Chou, Rung-Jiun. 2018. "Going out into the field: an experience of the landscape architecture studio incorporating service-learning and participatory design in Taiwan." *Landscape Research 43* (6): 784-797. <https://doi.org/10.1080/01426397.2017.1386290>. <https://dx.doi.org/10.1080/01426397.2017.1386290>.
- CLARB. 2020. LARE Orientation: Understanding the Landscape Architect Registration Examination.
- Cobb, Sue VG, Sarah Nichols, Amanda Ramsey, and John R Wilson. 1999. "Virtual reality-induced symptoms and effects (VRISE)." *Presence: Teleoperators & Virtual Environments 8* (2): 169-186.
- David, Laura Teodora. 2012. "Training of spatial abilities through computer games—results on the relation between game's task and psychological measures that are used." *Procedia-Social and Behavioral Sciences 33*: 323-327.
- Deng, Bei-Jia, Young-Hun Kim, Lin-Sen Cao, and Sang-Hyun Heo. 2019. "Realization Method for Landscape Architecture Design Using Virtual Reality Technology - Focused on the Residential Garden Design." *Journal of the Korean Institute of Landscape Architecture 47* (3): 71-80. <https://doi.org/10.9715/kila.2019.47.3.071>. <https://dx.doi.org/10.9715/kila.2019.47.3.071>.
- Everard, Mark, Paul Johnston, David Santillo, and Chad Staddon. 2020. "The role of ecosystems in mitigation and management of Covid-19 and other zoonoses." *Environmental science & policy 111*: 7-17.
- Fernandez, Manuel. 2017. "Augmented virtual reality: How to improve education systems." *Higher Learning Research Communications 7* (1): 1-15.
- Goniewicz, Krzysztof, Amir Khorram-Manesh, Attila J Hertelendy, Mariusz Goniewicz, Katarzyna Naylor, and Frederick M Burkle Jr. 2020. "Current response and management decisions of the European Union to the COVID-19 outbreak: A review." *Sustainability 12* (9): 3838.
- Gracy, Sebin, Philip E Paré, Henrik Sandberg, and Karl Henrik Johansson. 2020. "Analysis and distributed control of periodic epidemic processes." *IEEE Transactions on Control of Network Systems 8* (1): 123-134.
- Groat, Linda N, and David Wang. 2013. *Architectural research methods*. John Wiley & Sons.
- Holly, Michael, Johanna Pirker, Sebastian Resch, Sandra Brettschuh, and Christian Gütl. 2021. "Designing VR Experiences - Expectations for Teaching and Learning in VR." *Journal of Educational Technology & Society 24* (2): 107-119. <http://lib-e2.lib.ttu.edu/login?url=https://search.ebscohost.com/login.aspx?direct=true&AuthType=ip,cookie,url,uid&db=eue&AN=149859015&site=ehost-live>.
- Johnson, Todd, Benjamin H George, and Drew M Hill. 2019. "How virtual reality impacts the landscape architecture design process during the phases of analysis and concept development at the master planning scale." *Journal of Digital Landscape Architecture*: 266.
- Kerr, Jeremy, and Gillian Lawson. 2020. "Augmented Reality in Design Education: Landscape Architecture Studies as AR Experience." *International Journal of Art & Design Education 39* (1): 6-21. <https://doi.org/10.1111/jade.12227>. <https://dx.doi.org/10.1111/jade.12227>.
- Khronos. 2019. "OpenXR: Unifying Reality." <https://www.khronos.org/openxr/>.

- Li, Zhe, Yuning Cheng, and Yangyang Yuan. 2018. "Research on the Application of Virtual Reality Technology in Landscape Design Teaching." *Educational Sciences: Theory & Practice* 18 (5). <https://doi.org/10.12738/estp.2018.5.037>. <https://dx.doi.org/10.12738/estp.2018.5.037>.
- Lombardo, Adrian Erik. 2018. "Virtual reality and the landscape architecture design process." Norwegian University of Life Sciences, Ås.
- Megahed, Naglaa A, and Ehab M Ghoneim. 2020. "Antivirus-built environment: Lessons learned from Covid-19 pandemic." *Sustainable cities and society* 61: 102350.
- Muggah, R, and T Ermacora. 2020. "Opinion: redesigning the COVID-19 city." *NPR*, [S. l.] 20.
- Mystakidis, Stylianos. 2022. "Metaverse." *Encyclopedia* 2 (1): 486-497. <https://doi.org/10.3390/encyclopedia2010031>. <https://dx.doi.org/10.3390/encyclopedia2010031>.
- Pan, Yang, Daitao Zhang, Peng Yang, Leo LM Poon, and Quanyi Wang. 2020. "Viral load of SARS-CoV-2 in clinical samples." *The Lancet infectious diseases* 20 (4): 411-412.
- Portman, Michelle E, Asya Natapov, and Dafna Fisher-Gewirtzman. 2015. "To go where no man has gone before: Virtual reality in architecture, landscape architecture and environmental planning." *Computers, Environment and Urban Systems* 54: 376-384.
- Quaiser-Pohl, Claudia, Christian Geiser, and Wolfgang Lehmann. 2006. "The relationship between computer-game preference, gender, and mental-rotation ability." *Personality and Individual differences* 40 (3): 609-619.
- Smith, Debbie. 2004. "Issues and trends in higher education biology fieldwork." *Journal of Biological Education* 39 (1): 6-10. <https://doi.org/10.1080/00219266.2004.9655946>. <https://dx.doi.org/10.1080/00219266.2004.9655946>.
- Stearns, Dan T. 1995. "On - site Instruction for Landscape Contracting Students." *HortTechnology* 5 (1): 78-80. <https://doi.org/10.21273/horttech.5.1.78>. <https://dx.doi.org/10.21273/horttech.5.1.78>.
- Toquero, Cathy Mae. 2020. "Challenges and Opportunities for Higher Education Amid the COVID-19 Pandemic: The Philippine Context." *Pedagogical Research* 5 (4).
- UnrealEngine. 2021. "Boost Your Pipeline with Datasmith." <https://www.unrealengine.com/en-US/datasmith?sessionInvalidated=true>.
- Webb, Julia, and Richard Stafford. 2013. "Location-based mobile phone applications for increasing student engagement with field-based extra-curricular activities." *Planet* 27 (1): 29-34. <https://doi.org/10.11120/plan.2013.27010029>. <https://dx.doi.org/10.11120/plan.2013.27010029>.
- Wu, Wei-Long, Yen Hsu, Qi-Fan Yang, and Jiang-Jie Chen. 2021. "A Spherical Video-Based Immersive Virtual Reality Learning System to Support Landscape Architecture Students' Learning Performance during the COVID-19 Era." *Land* 10 (6): 561. <https://doi.org/10.3390/land10060561>. <https://dx.doi.org/10.3390/land10060561>.

Making a Case for Embodied Graphics Learning Methods in Architectural Structures Pedagogy

Bronne Dytoc¹

¹Kennesaw State University, GA

ABSTRACT: This research discusses a modified instructional model integrating embodied graphics for introductory architectural structures. This alternative model is designed to improve upon the conventional lecture-drill format by combining different aspects of modern pedagogy, such as multimedia-associative learning, embodied learning, and collaborative learning. The research limits its content scope to the initial structural topics which challenge many architecture students: forces, equilibrium of forces, and simple truss analysis for internal forces.

A first pilot study was conducted a few years ago to answer whether the integration of graphic techniques contributed to the students' learning performance. Two small-medium sized classes each year form the sample population. One class was assigned as "control", the other was assigned as "intervention". This first quasi-experimental study yielded marginal results hinting at better performance. Upon review, modifications were applied to the methodology to clarify the assessment device and refine the data gathering. The subsequent iteration assigns "control" to the computation-dominant Method of Joints (*MoJ*) and assigns "intervention" to the graphics-dominant Maxwell Diagram (*MaxD*) method. Students, instructed in both approaches, select their preferred analysis method to employ in their assessment. Using the midterm test's major task of simple truss analysis for internal forces, performances were evaluated based on process, outputs, and efficiency.

Data were collected from 2019 through 2022 (excluding 2020 due to Covid-19). The author hypothesized that the learning method integrating graphics-actions would both perform better and be much preferred by students. Data has so far shown that preference for the proposed graphics-active method is not decisive and may be influenced by social and naturalistic factors. However, findings do suggest that the graphical *MaxD* approach outperformed the conventional *MoJ* approach in terms of correctness of analyses, as well as efficiency of task completion. More details are discussed within the paper.

With these initial results suggesting better performance, the findings lend support for the integration of graphics-actions into the instructional approaches for introductory architectural structures, indicating the position that visual-biased learners may benefit from correspondingly graphics-attuned pedagogical strategies.

KEYWORDS: Architectural structures pedagogy, teaching-learning strategies, multimedia learning, active learning, embodied, learning,

INTRODUCTION

It is often remarked and observed how the learning of structures can always been challenging for architecture students in an undergraduate program. One may debate on how the difficulties revolve around the aspects of the learning environment, the technical nature of the content, or the prior-learning preparedness of the student; nevertheless, with the content quite well established and defined, its scope and relevance are unlikely to change. Thus, the discussion turns to how the material may be delivered and how the learner may be engaged. Though this paper does not aim to argue for or against learning styles as a belief or a myth (Riener & Willingham 2010; Nancekivell, Shah, & Gelman 2020), the research aims to explore whether an evolving instructional model that integrates graphical media and actions is able to improve the level of engagement and performance of students learning foundational topics of structures.

1.0 ARGUING FOR A TEACHING & LEARNING MODEL THAT INTEGRATES GRAPHICS

1.1 Seeing and Drawing as the Operational Pathways to Knowledge Construction

In 2017, the author presented on the topic of actively using graphics in a collaborative learning model for structures education in architecture (Dytoc 2017). To address the conventional lecture format's limitations of educating motivation, engagement, and performance, the author looked at the design studio as a learning venue where students invested deep and committed effort, while operating in a mode that produced many iterations of drawings and models. Seeing this as evidence of architecture students as visual and kinesthetic learners (Mostafa & Mostafa 2010), it was sensible to adapt instructional strategies of the structures class to be more compatible with these drawing practices, with the aim of positioning architecture students towards more effective learning and mastery (Casakin & Gigi 2016).

By considering how the eye, the mind, and the hand interact to see, understand, and translate, graphics can be more than just visual aids, they can be activated as an operational dialect to associate with the sequence of computations that dominates the structures class. This is supported by teaching strategies in math, science, and business that use visuals as pathways for building knowledge (Strauss, Corrigan, & Hofacker 2011; Schraw, McCrudden & Robinson 2013; adu, Pylman, & Adu 2020).

Following this direction, the author proposes an activated-graphics strategy that is more familiar to architecture students (see Figure 1, below). Such an instructional model would build upon the multi-coding aspects of Mayer’s multimedia learning theory (Mayer 2009; Kirschner, Kirschner, & Janssen 2014), where graphical actions and outputs familiar to students are logically linked to the normal use of computations (Gellevij, Van der Meij, De Jong, & Pieters 2002). Intentional associations between drawing actions and algebraic processes are practiced through scaffolded instruction for the learning of complex tasks (Merriënboer, Kirschner, & Kester 2003).

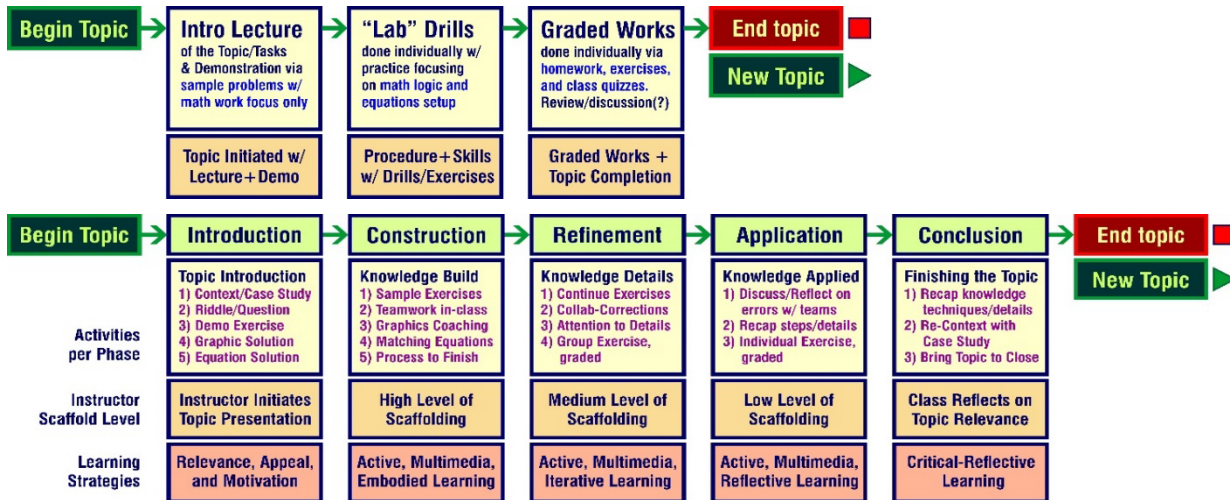

Figure 1. The traditional lecture-drill format (top) and the proposed active-graphics instructional model (bottom) (by the author, updated 2021). The alternative model combines scaffolded active-collaborative learning with graphic actions. Knowledge construction evolves with iterations; and topics end with critical reflection to reaffirm their context and relevance.

1.2 Active, Embodied, and Collaborative Approaches to “Learning by Doing”

Active learning can also be understood as “learning by doing”, not just by “seeing” or “thinking”; however, what particular modes of “doing” can we consider as improvements to the conventional lecture-drill format? One prime example of “doing” would expand on the normally expected activity of math computation work which, for most architecture students, has often been challenging. The integration of drawing scaled graphics places the familiar and developed architectural skills into the learning-by-doing process, while tapping into advantages inherent in embodied learning (Merriam, Caffarella, & Baumgartner 2007; Katz, (ed.) 2013; Mejia, Goodridge, & Green 2013). Through exact and precise diagrams, the instructor coaches students in associating drawing motions to match with the coding setup of algebraic equations. These linkages between drawn graphics and written computations serve as the major element in the alternative teaching-learning model for architectural structures (Savitz, Brown-Savitz, & Savitz 2012; Lin & Atkinson 2011; Diezmann et al., 2009). This method of doing-thinking-learning is deliberately conducted in manual and iterative modes to better imprint learning by directly interfacing with the student’s senses, motions, and perceptions (Mueller & Oppenheimer 2014).



Figure 2. Collaborative teams build knowledge via discussion and argumentation in their own “territories”. The instructor roams around as a “touring coach”. (Source : Author, 2020)

Another example of “doing” would be in the form of working in a team, where the key factor of participation and collaboration among peers can be seen as “learning by talking”, and even “arguing” (Hake 1998; Vo & Morris 2006; Nicol & Boyle 2003; Mangas 2020). Learning with peers and instructors is an example of the classic “zone of proximal development” (Vygotsky 1978). Because collaboration is effectively multilateral, this learning model allows for more communication pathways between team members (Badeau et al., 2017). Refer to Figure 2, above, for student teams in learning action.

1.3 Additionally : Relevance, Reflection, and a Good Room

For the enigmatic nature of structures, casting a good bait and reeling in the catch are not to be unappreciated. By beginning with, say, a case study riddle, students can start a topic with appeal and curiosity. Furthermore, using a real architecture project to motivate discussion gives an air of “gravitas” to the introduction’s contextual relevance, and thus may contribute to volition in learning (Keller & Deimann 2012). The instrumental content proper of the module is then dovetailed into the instructional model’s phases of scaffolded instruction.

Upon finishing a topic or module, a review window serves as the right opportunity to appreciate the learned material through contextual discussion and critical reflection. Firstly, the post-topic discussion may help to highlight particular steps and details of the newly learned tasks; secondly, the discussion may also address cognitive attitudes and behaviours that students may take for granted yet may influence their learning and performance. Lastly, the discussion also serves to bring the content back into the context of their major field and their larger goals as future design professionals (Fook & Gardner 2007; Huggard, Boland, & Goldrick 2014).

Regarding the designing of instruction: we recognize the assumption that learning subjects such as math or science happens mostly in the head. In fact, a student’s means of receiving information to construct knowledge, through their senses of sight and sound, are as important as their abilities to respond via motion and speech. Indeed, like the design studio, a teaching and learning strategy that practices active learning and higher student engagement would be best served with a learning environment that physically, technologically, and socially supports the traits of today’s learners (Holec & Marynowski 2020).

2.0 METHOD AND MODIFICATIONS

2.1 The Pilot Study’s Limitations

A pilot study was conducted using the quasi-experiment format (Millsap & Olivares 2009; Galan 2016) to verify if the proposed instructional model’s merits. The morning class was randomly assigned to follow the conventional lecture-computations format, while the afternoon class received the graphics-integrated strategy; the major task of truss analysis was chosen as the assessment device. The findings suggested that the graphics-integrated teaching-learning model contributed to better learning performance, but the measured difference was not significant. While the low count in the test population made for a hazy picture, other naturalistic aspects such as the class environment, the class time, the social chemistry, and the inevitable discussion across both classes (during off-class time) may have also added to the study’s confused results.

To be clear, peer bonding amongst architecture students develops quite surely due to their shared experience of creative studio work, all-nighters, and critiques and feedback from both tutors and peers (McClellan & Hourigan 2013). The author believes this social bonding factor has led to students communicating with each other about the different manners of instruction, their particulars, pros and cons, etc. It is possible that students would perceive an inequality in their instruction, and perhaps may even attempt to “equalize” the situation by sharing what they have learned across classes. These were confirmed through post-study informal conversations with students. While the degree of resentment for the unequal instruction was small, the difference between classes would have surely contributed to doubts, confusion, and dissatisfaction among some learners, thus affecting their attitudes and actions, and, in all probability, fogging up the validity of the pilot study’s initial findings.

2.2 The Modified Study and the Assessment Device

Accordingly, the author modified the study’s methods to address the perception of inequality in instruction and consider the inevitable cross-communication across the socially bonded students in the test population. As it is not possible to prevent crosstalk between students across classes, then defining “control” and “intervention” went to the conventional and alternative instructional methods, instead: the computations-based Method of Joints (*MoJt*) was assigned as the “control”, while the graphics-based Maxwell Diagram (*MaxD*) was assigned as the “intervention”. With two sections per spring and summer term serving as the annual population for sampling, deliberate effort was given to render instruction similarly to both classes with the same sequences, pacing, activities, exercises, and language.

For data generation and analysis, the midterm test’s major task of truss analysis served as the assessment device. The first half of the structures class covers the principal topics of forces, force addition, equilibrium, moments, and reactions; and all these topics come together to be applied in the analysis of a simple truss. Truss analysis may produce its outputs by either the computation-dominant Method of Joints method (*MoJt*), or the graphics-based Maxwell Diagram method (*MaxD*). The midterm exam comes in 4 sections, the last of which involves this major complex task, calling on the student’s full learning to analyze a given truss for its internal forces. This test generally has a completion time of two and a half hours, roughly half being spent on this analysis task.

This final section contains three parts: 1) finding external reactions, 2) analysis by sectional method, and 3) analysis of the truss for internal bar forces. The student, now trained in both methods, is asked to select their analysis method of choice. The full exam is weighted at around 200 points, with the final section weighted at approximately 100 points. The research draws its data from the first and third parts, finding reactions and full truss analysis. Below, the truss problem is given in detail with its solutions for reactions, and its analyses for internal truss bar forces via both the Maxwell Diagram (*MaxD*) method, and the Method of Joints (*MoJt*) (Figure 3).

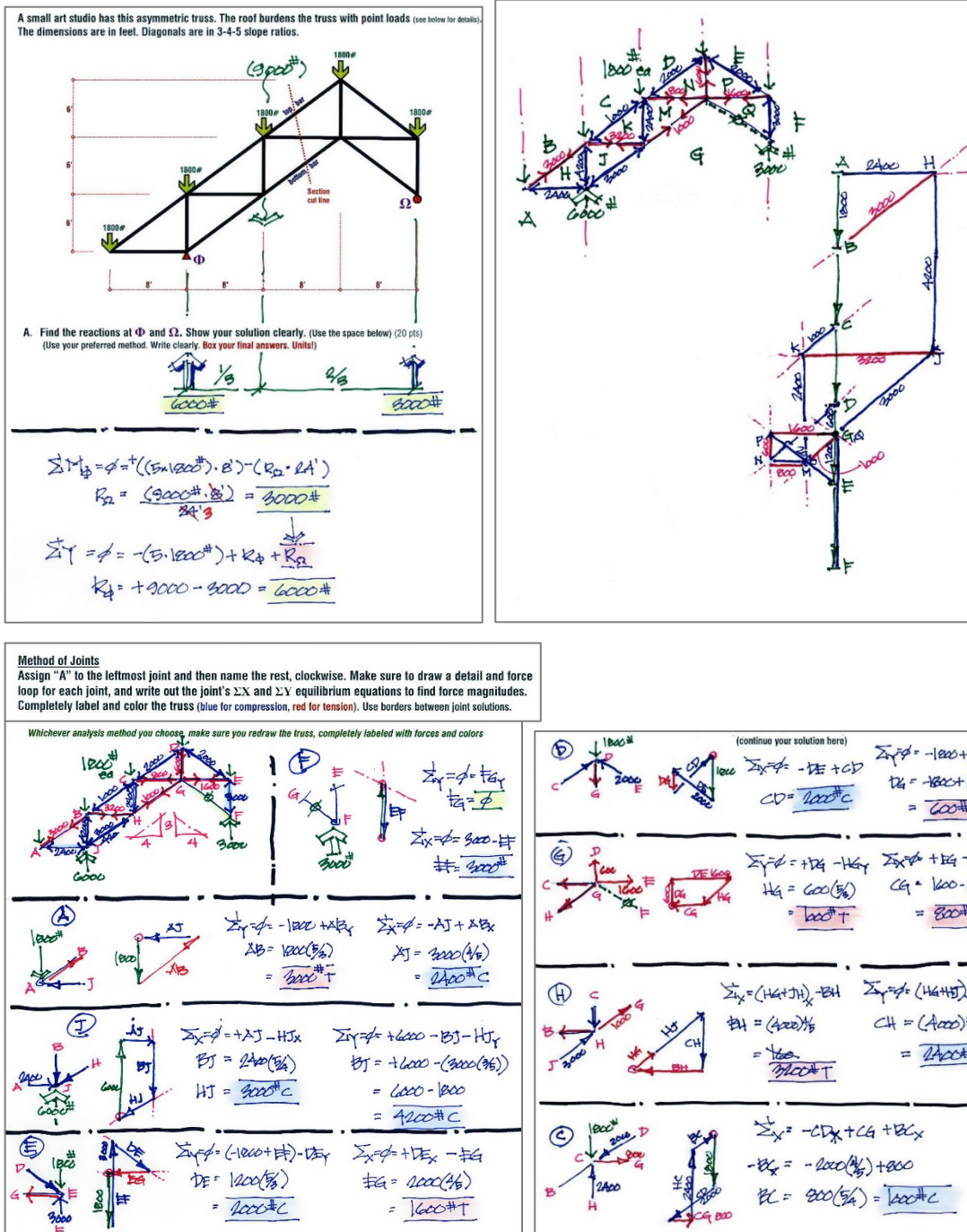

Figure 3. The simple truss with its solutions for reactions (top left), and the truss, fully analyzed using the graphics-based Maxwell Diagram (*MaxD*) method (top right). Solving for individual force amounts employs knowledge of geometry in drawing and translating the lengths of the precisely scaled force-loop graphics. In contrast, analysis of the truss using the Method of Joints (*MoJt*) method (bottom) employs the traditional writing of X and Y force-equilibrium calculations which take their equation forms based on each joint's detail and force loop. (Source : Author, 2021)

3.0 WHAT THE DATA OVER 3 YEARS SUGGEST

Data from this exam section were gathered from both classes, each year, across three years, during the spring term of 2019, and the spring and summer terms of 2021 and 2022. Data was not taken during the summer of 2019, and data gathering was halted altogether in 2020, due to the significant disruption to normal classroom practices caused by the Covid-19 pandemic. With regards to administering the test, students were given the exam in the same room with the same conditions of desk space, ambient lighting and sound levels. Data that were compiled from the examinations included the scores from the truss analysis task proper, the time used to complete the full test, and the time doing the truss analysis task. Test times suggest performance efficiency and confidence. The scores for the full test are not included in this paper. For this paper, these data are then compiled in straightforward values of raw performance scores (average), standard deviation (variance), and testing time (efficiency).

Data initially included the total student population; this meant tallying those tests with incomplete assessment tasks, thereby blurring the overall data. As the study was forced to pause in 2020, it gave the author an opportunity to review the methodology; and, as a refinement, data after 2020 were filtered to identify and include only those students that completed the truss analysis task. Tests with unfinished assessment tasks were deemed to have insufficient information to gauge performance and efficiency of task execution; these could not be considered valid for data analysis. Notably, the percentage of tests with the task completed may also offer a clue as to how the graphics-integrated approach may be more effective than the conventional method in analyzing a truss.

3.1 Proficiency : Performance Averages and Variances

Listed below, in Tables Set 1, are the truss analysis performance averages and variances.

Table Set 1. The top table shows the performance averages for the truss analysis task across 5 terms. The bottom table shows the variance of each class's scores. Data are organized according to class session (AM or PM) and chosen method (Method of Joints – *MoJt*, or Maxwell Diagram – *MaxD*).

Completed Truss Analysis : Performance																					
		Spring 2019				Spring 2021				Summer 2021				Spring 2022				Summer 2022			
Class	<i>MoJt</i>		<i>MaxD</i>		<i>MoJt</i>		<i>MaxD</i>		<i>MoJt</i>		<i>MaxD</i>		<i>MoJt</i>		<i>MaxD</i>		<i>MoJt</i>		<i>MaxD</i>		
	n	average	n	average	n	average	n	average	n	average	n	average	n	average	n	average	n	average	n	average	
AM	19	71.05	11	84.16	2	52.50	21	71.57	8	73.13	4	89.38	5	69.60	19	83.68	10	81.80	5	87.00	
PM	21	63.81	10	83.17	5	47.60	17	93.47	2	75.00	10	78.00	6	69.33	10	78.60	6	81.33	7	80.86	
Total	40	67.25	21	83.69	7	49.00	38	81.37	10	73.50	14	81.25	11	69.45	29	81.93	16	81.62	12	83.42	

Completed Truss Analysis : Variance																					
		Spring 2019				Spring 2021				Summer 2021				Spring 2022				Summer 2022			
Class	<i>MoJt</i>		<i>MaxD</i>		<i>MoJt</i>		<i>MaxD</i>		<i>MoJt</i>		<i>MaxD</i>		<i>MoJt</i>		<i>MaxD</i>		<i>MoJt</i>		<i>MaxD</i>		
	n	std dev	n	std dev	n	std dev	n	std dev	n	std dev	n	std dev	n	average	n	average	n	average	n	average	
AM	19	20.62	11	24.12	2	7.50	21	21.03	8	16.13	4	18.40	5	20.46	19	20.50	10	15.41	5	11.21	
PM	21	23.58	10	18.51	5	7.54	17	8.35	2	25.00	10	24.81	6	17.84	10	12.89	6	13.05	7	24.87	
Total	40	22.17	21	21.45	7	7.53	38	15.36	10	17.90	14	22.98	11	19.03	29	17.88	16	14.53	12	19.18	

In Table Set 1, data for performance of the truss analysis task shows how the *MaxD* method generally scored better than the conventional *MoJt* method; cumulatively, the graphics-integrated approach averaged 12% points more than the conventional computation method, 82.14% to 70.06%. Variance, or a measure of how far the scores were from the average, was shiftier from year to year, for both methods, and ranged mostly from around 15 to 20 points. Collecting the variances over the three years shows but half a point difference the conventional (19.53) and the alternative (20.08). The author can only attribute this to the inevitable and intangible differences of student engagement, study patterns, and so forth. Furthermore, the author's assumption that the graphics-integrated approach would be preferred much more did not always pan out. As the numbers show in Table 1, in some semesters, the conventional method was picked over the alternative, and in other terms, the preference for either method was roughly even. Once again, the author, at present, can only point to intangible factors of study patterns, social chemistry, mastery and confidence as having possibly strong influences in students' choices.

3.2 Efficiency : Performance Times

Table Set 2 shows task times for finishing the whole test as well as the truss analysis. On the whole, tests that employed the *MaxD* method took less time (125.23 min) in contrast to the *MoJt* method's overall average time (133.66 min); reviewing the data reveals how the employing the alternative method improved total test time from as low as 2 minutes to over 20 minutes. Similarly, when reviewing the time take for the truss analysis task alone, only one term showed the

alternative method as being 6 minutes slower, while times for the other 4 semesters show faster times, ranging from 10 to 20 minutes; though inconsistent due to low sampling power, cumulatively, *MaxD* took 52.24 minutes, in comparison to *MoJt*'s 60.69 minutes. Please refer to Table Set 2, below, for more details.

Table Set 2. The top table details the amount of time taken, in minutes, for finishing the exam, while the bottom table describes the time needed, also in minutes, to complete the truss analysis task. While the numbers do not show an absolute consistency, the general pattern favors the *MaxD* method as being more efficient than the *MoJt* method.

Task Time for Completed Exam																				
		Spring 2019				Spring 2021				Summer 2021				Spring 2022				Summer 2022		
Class	<i>MoJt</i>		<i>MaxD</i>		<i>MoJt</i>		<i>MaxD</i>		<i>MoJt</i>		<i>MaxD</i>		<i>MoJt</i>		<i>MaxD</i>		<i>MoJt</i>		<i>MaxD</i>	
	n	minutes	n	minutes	n	minutes	n	minutes	n	minutes	n	minutes	n	minutes	n	minutes	n	minutes	n	minutes
AM	19	142.53	11	124.73	2	150.00	21	134.44	8	126.25	4	131.67	5	144.60	19	142.95	10	128.30	5	124.20
PM	21	122.57	10	108.10	5	138.20	17	102.65	2	134.58	10	120.08	6	136.67	10	129.00	6	151.17	7	128.72
Total	40	132.05	21	116.76	7	141.72	38	120.22	10	122.08	14	123.39	11	140.27	29	138.14	16	136.87	12	126.83

Task Time for Completed Truss Analysis																				
		Spring 2019				Spring 2021				Summer 2021				Spring 2022				Summer 2022		
Class	<i>MoJt</i>		<i>MaxD</i>		<i>MoJt</i>		<i>MaxD</i>		<i>MoJt</i>		<i>MaxD</i>		<i>MoJt</i>		<i>MaxD</i>		<i>MoJt</i>		<i>MaxD</i>	
	n	minutes	n	minutes	n	minutes	n	minutes	n	minutes	n	minutes	n	minutes	n	minutes	n	minutes	n	minutes
AM	19	54.79	11	35.36	2	63.00	21	54.18	8	52.50	4	38.33	5	54.60	19	67.00	10	85.60	5	69.40
PM	21	47.33	10	32.60	5	72.60	17	47.35	2	97.92	10	55.25	6	59.50	10	56.40	6	78.67	7	58.28
Total	40	50.88	21	34.05	7	69.85	38	51.13	10	61.58	14	50.42	11	57.27	29	63.34	16	83.00	12	62.92

3.3 The Graphics-Integrated Method as a Predictor of Task Completion

As mentioned above, the tactic of evaluating only those tests with completed truss analysis tasks may offer another aspect of the proposed learning strategy's effectivity. Below, in Table 3, data from the last 4 terms tell a most revealing tale. "n" refers to the number of students who were able to complete the exam and the truss analysis; "total n" refers to the total number of students who took the exam, including the ones who could not complete it. Table 3 shows how the *MaxD* exam takers had a higher task and test completion rate than those who chose to use *MoJt*, cumulatively, across these 4 terms, 83.78% of students who opted for *MaxD* completed their exam, in contrast to 57.14% of *MoJt* students.

Table 3. This table details the data for "n", the number of students who were able to complete the analysis task and the exam, and "total n", the total number of students, including those that did not complete the required tasks.

Completed Truss Analysis vs Total Tests																		
		Spring 2021				Summer 2021				Spring 2022				Summer 2022				
Class	<i>MoJt</i>		<i>MaxD</i>		<i>MoJt</i>		<i>MaxD</i>		<i>MoJt</i>		<i>MaxD</i>		<i>MoJt</i>		<i>MaxD</i>			
	n	total n	n	total n	n	total n	n	total n	n	total n	n	total n	n	total n	n	total n		
AM	2	5	21	24	8	13	4	8	5	7	19	22	10	17	5	6		
PM	5	9	17	21	2	4	10	11	6	13	10	11	6	9	7	8		
Total	7	14	38	45	10	17	14	19	11	20	29	33	16	26	12	14		
%		50.00		84.44		58.82		73.68		55.00		87.88		61.54		85.71		

CONCLUSIONS, REFLECTIONS, AND RECOMMENDATIONS

This continuing research asks the question : Can the integration of graphic operations in the teaching and learning of foundational structures content improve the learning performance and engagement of architecture students? Data suggests "yes". The numbers suggest that the proposed instructional model integrating graphics offer a picture of better proficiency and efficiency, and even serves as a mild predictor for task completion.

To be sure, the author is reminded that the learning environment has also been redesigned to apply active, embodied, and collaborative learning, as well as critical reflection in the capping off of topics. And these more emergent practices may have affected the learning experiences of the students positively and productively. Additionally, having a supportive and constructive learning venue may also aid motivation, volition, and perhaps, knowledge transfer.

Students' attitudes and perceptions of the content, the instruction, and the learning environment matter in constructing their experience, thus, affecting their performance and engagement. A post-term survey to gather student feedback on

these issues may complement and enrich the research with qualitative information. The author sees this report on 5 terms worth of data as a valuable chapter upon which to build and refine continuing future research.

REFERENCES

- Adu, K. O., Pylman, N., and Adu, E. O. 2020. "Learning Styles as Correlates of Grade 6 Learner's Mathematics Performance in Buffalo City Municipality in South Africa." *E-BANGI Journal* 17(5): 119–131.
- Badeau, R., White, D. R., Ibrahim, B., Ding, L., and Heckler, A. F. 2017. "What Works with Worked Examples: Extending Self-Explanation and Analogical Comparison to Synthesis Problems." *Physical Review Physics Education Research* 13(2): 01-27.
- Casakin, H., and Gigi, A. 2016. "Cognitive Styles in Admission Procedures for Assessing Candidates of Architecture." *Assessment & Evaluation in Higher Education* 41(2): 167-182.
doi:10.1080/02602938.2014.992298
- Diezmann, C., Lowrie, T., Sugars, L., and Logan, T. 2009. "Students' Sensemaking with Graphics." *Australian Primary Mathematics Classroom* 14(1): 16-20.
doi:10.20343/teachlearninqu.8.2.10
- Dytoc, B. 2017. "Activating Graphics and Collaboration in Architectural Structures Education." *The New ARCH* 4(2): 15-26.
- Fook, J., and Gardner, F. 2007. *Practising Critical Reflection: A Resource Handbook*. Open University Press.
- Galan, J. G. 2016. *Educational Research in Higher Education : Methods and Experiences*. River Publishers Series in Innovation and Change in Education: Cross-Cultural Perspective. Denmark: River Publishers.
- Gellevij, M., Van Der Meij, H., De Jong, T., and Pieters, J. 2002. "Multimodal Versus Unimodal Instruction in a Complex Learning Context." *Journal of Experimental Education* 70(3): 215-241.
doi:10.1080/00220970209599507
- Hake, R. R. 1998. "Interactive-Engagement versus Traditional Methods: a Six-thousand-student Survey of Mechanics Test Data for Introductory Physics Courses." *American Journal Of Physics* 1: 64-74.
- Holec, V., and Marynowski, R. 2020. "Does It Matter Where You Teach? Insights from a Quasi- Experimental Study of Student Engagement in an Active Learning Classroom." *Teaching & Learning Inquiry* 8(2): 140–163.
- Huggard, M., Boland, F., & Goldrick, C. M. 2014. "Using Cooperative Learning to Enhance Critical Reflection." *IEEE Frontiers in Education Conference (FIE) Proceedings*. 1–8.
doi:10.1109/FIE.2014.7044301
- Katz, M. (ed.). 2013. *Moving Ideas : Multimodality and Embodied Learning in Communities and Schools*. New York, Peter Lang Publishing.
- Keller, J. M., and Deimann, M. 2017. "Motivation, Volition, and Performance." *Trends and Issues in Instructional Design and Technology*, 3rd ed. 84-95. Boston, MA. Pearson.
- Kirschner, P., Kirschner, F., and Janssen, J. 2014. "The Collaboration Principle in Multimedia Learning." *The Cambridge Handbook of Multimedia Learning*. Mayer, R. (ed). 547-575, Cambridge University Press.
doi:10.1017/CBO9781139547369.027
- Lin, L., and Atkinson, R. K. 2011. "Using Animations and Visual Cueing to Support Learning of Scientific Concepts and Processes." *Computers & Education* 56: 650-658. doi:10.1016/j.compedu.2010.10.007
- Mangas, C. 2020. "Active Learning in Higher Education: Pedagogical Strategies for Collaborative Work." *Millenium 2* (12). doi:10.29352/mill0212.05.00295.
- Mayer, R. E. 2009. *Multimedia Learning*. Cambridge. Cambridge University Press.
- McClellan, D., and Hourigan, N. 2013. "Critical dialogue in Architecture Studio: Peer Interaction and Feedback." *Journal for Education in the Built Environment* 8(1):35-57. doi:10.11120/jebe.2013.00004
- Mejia, J. A., Goodridge, W., and Green, C. 2013. "Enhancing Engineering Mechanics Statics Instruction Using Manipulative Truss Models." *IEEE Frontiers in Education Conference (FIE) Proceedings*. 369-371. Oklahoma City, Oklahoma. doi:10.1109/FIE.2013.6684849
- Merriam, S. B., Caffarella, R. S., & Baumgartner, L. 2007. *Embodied, Spiritual, and Narrative Learning. Learning in Adulthood : a comprehensive guide*. San Francisco. Jossey-Bass.
- Merriënboer, J., Kirschner, P., and Kester, L. 2003. "Taking the Load Off a Learner's Mind: Instructional Design for Complex Learning." *Educational Psychologist*, 38(1): 5-13.
- Millsap, R. E., and Olivares, A. 2009. *The SAGE Handbook of Quantitative Methods in Psychology*. SAGE.
- Mostafa, M. and Mostafa, H. 2010. "How Do Architects Think? Learning Styles and Architectural Education." *Archnet-IJAR, International Journal of Architectural Research* 4(2/3): 310-317.
- Mueller, P., and Oppenheimer, D. 2014. "The Pen is Mightier than the Keyboard: Advantages of Longhand over Laptop Note Taking." *Psychological Science* 25(6): 1159-1168.
doi:10.1177/0956797614524581
- Nancekivell, S., Shah, P., and Gelman, S. 2020. "Maybe They're Born with It, or Maybe it's Experience: Toward a Deeper Understanding of the Learning Style Myth." *Journal of Educational Psychology* 112(2): 221-235.
doi:10.1037/edu0000366
- Nicol, D. and Boyle, J. 2003. "Peer Instruction versus Class-wide Discussion in Large Classes: A Comparison of Two Interaction Methods in the Wired Classroom." *Studies in Higher Education* 28(4): 457-473.
doi:10.1080/0307570032000122297
- Riener, C., and Willingham, D. 2010. "The Myth of Learning Styles." *Change* 42(5): 32-35.
doi:10.1080/00091383.2010.503139

- Savitz, F., Brown-Savitz, A., and Savitz, R. 2012. "Getting to the Core of It: Innovative Teaching Approaches to Mathematics and Science Prerequisites for Business Majors." *Review of Business Research* 12(1): 154-159.
- Schraw, G., McCrudden, M.T., and Robinson, D. (eds.). 2013. *Learning Through Visual Displays*. Charlotte, North Carolina. Information Age Publishing.
- Strauss, J. F., Corrigan, H., and Hofacker, C. 2011. "Optimizing Student Learning: Examining the Use of Presentation Slides." *Marketing Education Review* 21(2): 151-162.
doi:10.2753/MER1052-8008210205
- Vo, H. X., and Morris, R. L. 2006. "Debate as a Tool in Teaching Economics: Rationale, Technique, and Some Evidence." *Journal of Education for Business* 8: 315-320.
- Vygotsky, L. S. 1978. *Mind in society: Development of Higher Psychological Processes*. Cambridge, Massachusetts. Harvard University Press.

Natural Feedback Loops As Teaching Tool

Jay Yowell¹

¹Oklahoma State University, Stillwater, OK

ABSTRACT: Natural systems and organisms appropriately respond to change through feedback loops. Portions of the output are fed back as an input to modify a subsequent output of a system. When this output amplifies the system it is a positive feedback loop. And when it inhibits the system it is a negative feedback loop.

For the Biomimicry + Architecture class, I mimicked biology as a pedagogy which utilized feedback loops as a teaching process. If nature uses feedback loops and this is a class inspired by nature to solve design problems, why not explore biomimicry as a teaching model?

Students were surveyed on problems they perceived in architecture. After class presentations, each student selected a problem to solve and various inspirational organisms. These were then categorized to provide structure that provided appropriate feedback. Each student presented their research to the class at stages during the semester. Other times, the students presented and received feedback from their various category groups. When a student obtained feedback from the professor, this was presented to the class the following period. These presentations and feedback sessions meant the class was more focused on process over final product. An initial design solution was started, but the main goal was to document the process of the feedback loops and their influence on defining the problem and refining a potential solution.

By having students work individually, then within a small group with similar issues, and within the class as a whole, more varied feedback was given at each stage of output. In utilizing this feedback loop methodology, the students saw how their inspired organism benefited other systems beyond itself. Which is going beyond design that takes from nature, or even tries to just co-exist with it, but one that actually enhances and restores systems using feedback loops.

KEYWORDS: Biomimicry, resilience, architectural education methodology

INTRODUCTION

What are effective methods to teach architecture students how to design with the environment in mind? Is it through computational analysis data? Or through studying ancient cultures that were spiritually connected to the earth? Or is it some method in between? To design architecture that protects and enhances nature, we must first understand how nature operates. Good design responds to how a client operates. Understanding a company's culture is vital when designing its new headquarters. Knowing how a family functions day to day is crucial in designing a home for them. One of the way nature operates is through feedback loops.

All flora and fauna, and from microscopic organisms to stars in distant galaxies utilize feedback loops to survive and thrive. One of the patterns in nature that the Biomimicry Institute (2021) outlines is that nature runs on information. It is necessary for natural systems and organisms to receive information from the environment that they are attuned for. They are constantly monitoring their environment and responding and feedback loops help to monitor those conditions. (Biomimicry Institute, 2021).

Portions of the output are fed back as an input to modify a subsequent output of a system. When this output amplifies the system it is a positive feedback loop. This can be seen when tissue is torn and platelets in the blood stream become more and more activated until the wound is clotted. And when it inhibits the system it is a negative feedback loop. An example of this is when the body temperature rises, we sweat to cool the body down.

For the Biomimicry + Architecture class, we mimicked biology as a pedagogy which utilized feedback loops as a teaching process. In this specialized elective course with twenty undergraduate students, we asked: If nature uses feedback loops and this is a class inspired by nature to solve design problems, why not explore biomimicry as a teaching model? This was a unique methodology implemented this semester compared to previous years where biomimicry was used as a design tool.

1.0 FEEDBACK LOOP PEDAGOGY

1.1 Why use Feedback Loops?

Muller (2011) emphasizes that feedback provides the detection of mistakes and corrective action, thus making it the starting point of the learning process. We use feedback loops as an iterative process in architectural education. But

often with time between output and input. If a student gets feedback from the studio professor in class on Monday, the students responds with adjustments for the next studio class on Wednesday.

Nature’s feedbacks must happen much faster with multiple, almost immediate iterations. The Biomimicry Institute (2011) highlights that both positive (those that speed up a process) and negative (those that slow a process down) feedback loops are important to natural systems. Since the Biomimicry + Architecture course studies natural systems for inspiration, we can learn from the way “...nature works with small feedback loops constantly learning, adapting, and evolving their environments and processes...” (Vierra, 2019).

1.2 Change in pedagogy

I have been teaching the Biomimicry + Architecture course four years and each year make adjustments after assessing how objectives were or were not met. Analyzing these outcomes coincided with learning more about how nature utilizes feedback loops. The course already uses nature as a model for the student projects, so why not take it a step further and use it as a model for the course pedagogy?

The main adjustment made was to get students to rapidly explore material they were unfamiliar with and not be afraid to experiment and fail in their attempts to arrive at a solution. To have effective solutions, it was vital for students to ask the right questions and seek the essence of the problems they are trying to solve. To be successful, the designs should push the limits of what is possible, but not beyond impossible. In order to remain relevant, ideas should utilize current technology. Innovation will come from pushing these current technologies further or into an alternative use.

A study of biomimicry obviously relies heavily on science and it is good for designers to learn from these scientists. Their process of rapid experimentation of the research will be utilized in this course. Intentional, research-based work, will be shown in class in order to implement a scientific approach to design.

2.0 BIOMIMETIC METHODOLOGIES

2.1 Failures, adjustments

From the outset, the goal was to get the students open to this scientific approach, which meant they will: fail small, fail fast and fail early as seen in so many scientific experiments. This meant creating small, quick thinking in-class assignments that were ungraded. These allowed for rapid adjustments (inputs) to their errors (outputs) like we see in nature’s feedbacks. Having a class full of architecture students, this methodology took some time before they saw that errors were not indicators of their failure. “By considering an environment where errors are welcomed, feedback can be more effective”. (Hattie & Yates 2014).

2.2 Design spiral

It also became important for me as the instructor to be clear on smaller goals to maintain momentum. Hattie & Yates (2014) emphasize that making the students aware of immediate lesson goals and expectations is critical for teachers to invest time ensuring. Expressing how these smaller steps related to the overall goal was also a constant task that proved fruitful. It was not just blind research and work, but had intention.

The Biomimicry Design Spiral from the Biomimicry Institute is a valuable tool in focusing on smaller goals. Five of the phases (not including the ‘Evaluate’ phase due to time) shown in Figure 1 were used as the framework for lectures, discussions and assignments throughout the semester. As the Biomimicry Institute explains,

Biomimicry Design Spiral provides a succinct description of the essential elements of a design process that uses nature a guide for creating solutions. It describes the six most important steps a design team should take when seeking biomimetic solutions to a design challenge. (2017).

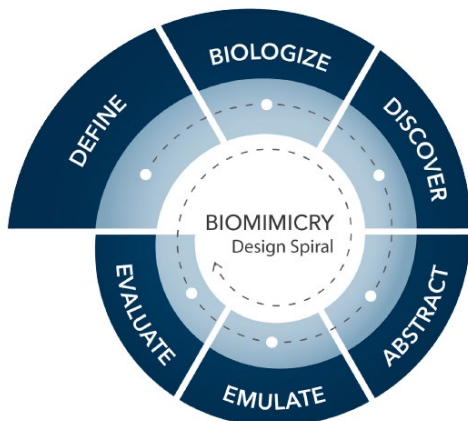

Figure 1: Biomimicry Design Spiral. (Biomimicry Institute 2017)

2.3 Category taxonomy

To begin the semester, the students were surveyed on outstanding problems they saw in architecture. After presenting these problems to the class, each student selected a problem to solve as well as various inspirational organisms. These problems and organisms were then categorized to provide structure that provided appropriate feedback. A taxonomy was created according to the student issues as shown in Figure 2. Broadly the problems were broken into: Natural Systems, Building Systems and Urban Systems. Under Natural Systems, the problems were further divided into: Land / Community and Water / Wind subcategories. And the Building Systems subcategories were: Indoor Air Quality, Energy and Materials. This taxonomy created groups that the students could work in to share research and get immediate feedback during class discussions.

Inspirational organisms were also categorized and connected to the students' problems in order to see if there were overlaps and connections that could be made between groups. The organisms were broken into: Flora and Fauna with subcategories of: Trees and Plants as well as: Air, Land and Water animals.

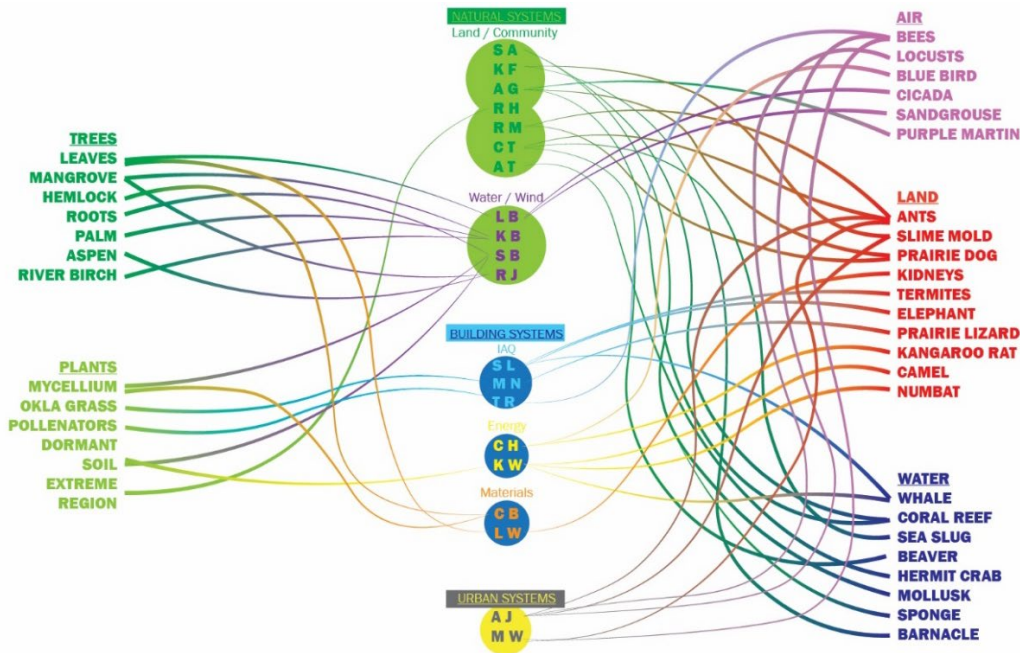

Figure 2: Overall Strategies / Organisms Taxonomy. (Author 2021)

This taxonomy was shared and used by the students to see with whom they could discuss their problem or organism. It was interesting to see the relationship between the systems and organisms taxonomy. As shown in Figure 3, the Land / Community group mainly drew inspiration from Water animals, with some Land animals. While the Urban Systems group focused on exclusively Air and Land animals. Not only did this provide fruitful for focused discussion among the students, it provided me a framework in which to disseminate material to share and present.



Figure 3: Group Strategies for Land / Community and Urban Systems. (Author 2021)

3.0 FEEDBACK LOOP METHODOLOGIES

3.1 Input -- Instructor

With these taxonomies created, instruction was focused and adapted to what feedback these groups needed and what errors they were creating. Rather than just making an error as an individual, creating errors as a group allowed the students to be more comfortable putting forth ideas and direction. Teaching was done in the standard manner, giving a presentation to the entire class. But it was also given to these individual groups, focused on the issues they were trying to solve. As the semester progressed, meetings and reviews were given to individuals. To learn to be a more effective instructor, I gave a summary of these individual meetings to the entire class. These summary presentations allowed me to receive feedback from the student that I was discussing to ensure I understood their work and what we discussed. It also allowed other students to not only see what others were working on but asking me questions about the feedback I had given the student and offering additional feedback. In discussing how this tutor and student relationship works in the zebra finch's brain can lead to success in the human classroom, Zsembik states,

Consistent feedback on the effectiveness of an instructor's efforts towards a student, and the ability to make adjustments accordingly, can lead to more effective teaching than when only the student's performance is evaluated, and the teaching method remains static. (2020).

These sequential instructional moves enabled me as the instructor "... to convey to a student that specific outcomes are attainable." (Hattie & Yates, 2014). From the outset, the students were informed that class time would be utilized to work on assignments at various stages. Other class times were used to give presentations by the instructor on explaining new material, showing examples and laying out objectives for next assignment. Other classes were used to present student progress, have the class give feedback and yet other class time was used to break out into groups by category to share research and give feedback in smaller groups.

3.2 Instructor presentations

As a foundation, students were shown historical examples of architects inspired by nature: Leonardo da Vinci, Antonio Gaudi, Buckminster Fuller, and Frei Otto. And also to show case studies on contemporary examples: Foster + Partners, Eastgate Project by Mick Pierce, and Eden Project by Grimshaw Architects. Various resources were shared including the 'Ask Nature' website, Biomimicry on social media, and Zygote Quarterly online.

As a class, we discussed current issues in architecture today and then they broke into groups and discussed problems. They were instructed to ask: Why is the issue a problem? What are the factors that make it a problem? What else could be solved by dealing with the problem? Then follow up and create diagrams and researched what (if any) work has already been done to solve the problem.

Presentations by the instructor were then given on how to Translate / Biologize the problem they were researching. An important step is to reframe the challenge into a biological context and use biological terms to define the problem.

We spent a lot of time seeking what are the essential functions and context of the issue? An example from Biomimicry Institute: Instead of asking "How might we keep buildings cool in the summer?" ask "How does nature regulate temperature in hot climates?" Getting feedback on what they saw as the function and context was important for the students to set a focused direction on their research. For the next phase, Discover biological strategies, I gave presentations on methods about how to identify the strategies used that support the natural model's survival and success. For example, a tree uses tension to pull water up the xylem and transpiration of water through the stomata of the leaves.

Next was to show the students how to Abstract and Translate the biological strategies they had been researching into design strategies. To get a bio-inspired design strategy, it is helpful to create a statement that articulates the biological system without using biological terms. For example, instead of using xylem and phloem to describe how a tree transports nutrients, use the term 'piping'. And replace the term 'fur' with 'fiber' or 'skin' with 'membrane'.

This is a difficult step for the students, as well as for the instructor who has been practicing architecture for 28 years! But having immediate discussions and feedback helps in getting past errors quickly. It was also helpful to show examples from past classes.

The final phase, Emulate, was the simple part for the architecture students because they were able to utilize their design skills to create a solution based on all the research they had done. So instruction at this point was similar to what is done in a studio course. They received feedback on their work and were shown a variety of graphic communication techniques to utilize in their final booklet. This individual critique was shared with the class. Figure 4 shows the various design stages of a project for a water habitation pod to overcome the loss of land which contributes to climate change. First was how to temporarily attach this pod to ocean or lake floor? Next input was to explore how to deal with buoyancy and movement that may cause sea sickness? Output was to design outer shell that could take in and release water while also creating a gyroscope which keeps the interior of the pod stable.

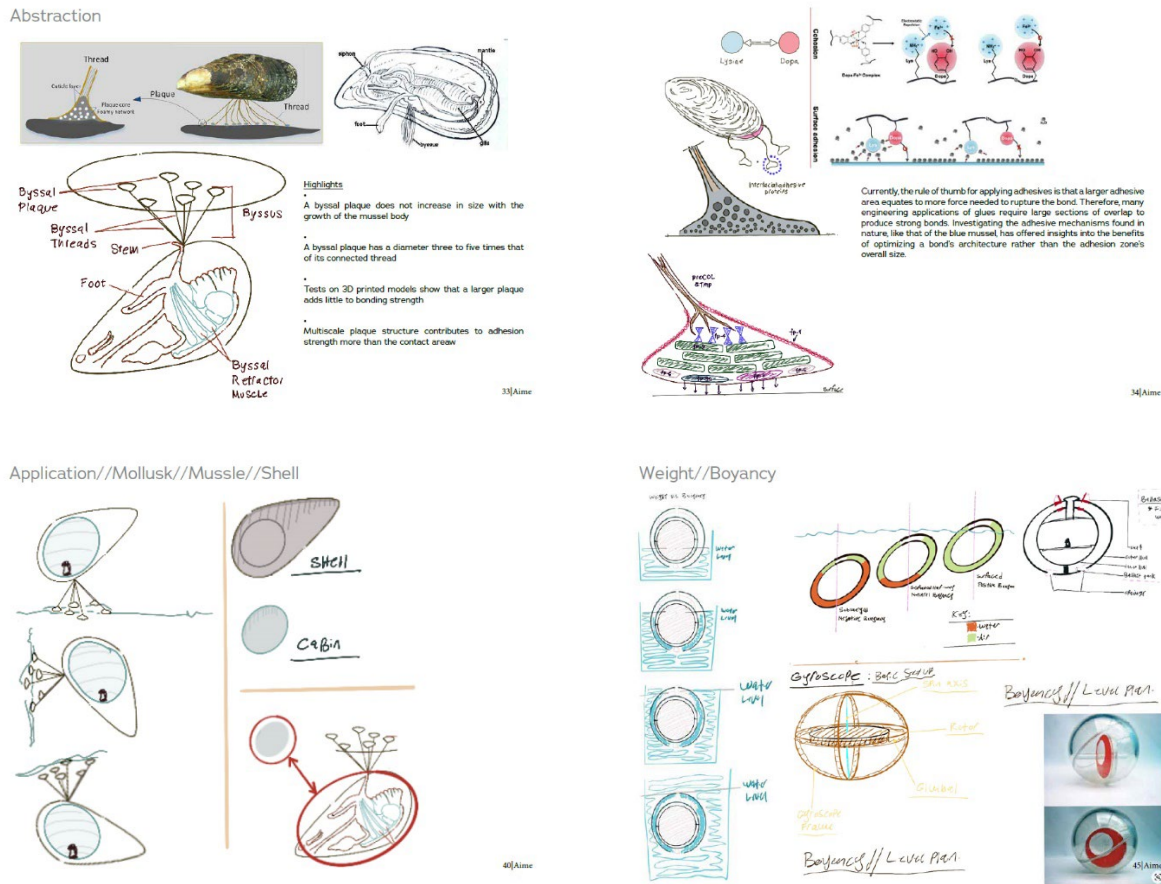

Figure 4: Student work after receiving feedback on various stages (Drawing credit: Sur Aime)

3.3 Input -- Student

As mentioned earlier, the students also led discussions and presentations. These gave them an opportunity to present to the entire class and receive feedback. Additionally, they met and presented each class period to their groups as outlined in the system taxonomy. And as their work became more detailed and defined presented their work to me. By having the entire class keep up with each other's progress, they could offer feedback on what was being presented since they were familiar with where the student was before. No lengthy presentations on what the work was about or what their architectural problem was. Instead, it could be a quick update and the other students could offer feedback. This proved to be a productive exercise. In assessment for higher education, Carless states,

For feedback processes to be productive, students need to be involved actively in making sense of information and engaging with it for the purposes of ongoing improvement. (2019).

Each student presented his or her research to the entire class at various stages during the semester. Other times, the students presented and got feedback from the groups set up by the various categories. And when a student got one-on-one feedback from the professor, this was presented to the entire class the following period. These presentations and feedback sessions meant the class was more focused on the process over the final product. By having students work individually, then within a small group with similar issues, then within the class as a whole, more varied feedback was given at each stage of output. It also allowed for a student to share research that also applied to another problem a different student was exploring.

3.4 Output -- Deliverables

Presentations by either the instructor or students were also accompanied by working on deliverables for the class. One of the adjustments made to the class was to create in-class assignments. These were short, rapid projects that were handed in at the end of class and I gave feedback by that evening. This adjustment was made after reading about findings on how students devoted much more effort and focused time to tasks that were specific and where timely feedback was given. (Northcraft et al., 2011).

The graded deliverables were assignments on each of the Biomimicry Design Spiral phases. Assignments included research of literature, many diagrams and documenting the feedback adjustments they made. They also completed

the worksheets from the Biomimicry Toolbox that helped in answering detailed questions and getting feedback from me and their peers.

Work was compiled in booklet for the final deliverable. The booklets were started the first day of class, with pages added for each class period. Diagrams, sketches, notes, research, readings, case studies and feedback notes were to be included in the booklet.

It will show:

PROCESS	How did you work through problem?
PRINCIPLES	What are nature's principles to solve?
POTENTIALS	Not just solutions, but possibilities.

An initial design solution was started, but the main goal was to document the process of the feedback loops and their influence on defining the problem and refining a potential solution.

CONCLUSION

The results of utilizing feedback loops as a pedagogy for the Biomimicry + Architecture class was overall successful in its inaugural year. In past years the class was focused on working towards a final project and this year was more about the process and reacting to feedback. While it was good to focus on process, it would be beneficial to have some additional work done on applying ideas to a project. One idea is to make it a group project so that the workload could be shared and thus get to a solution stage earlier while still working through the process of reacting to feedback loops. Or have the entire class work on solving the same problem but approaching it from different directions. This would decrease the amount of time spent on defining the problem with all students. I have hesitated in doing this in case a student is not passionate about the topic selected.

Another change I believe would be beneficial is to bring in scientists to offer feedback on the research and also present on how they take an experimental approach to their work. The 'fail small, fail fast and fail early' mantra has been useful in studio according to a number of students. A semester after taking this course, students express how they are finding this mentality helpful in other courses. Getting first-hand knowledge from scientists would only enhance this mindset.

One surprising result was that by getting and giving feedback to the entire class, students saw how their inspired organism benefited other systems beyond their own. Which is going beyond design that takes from nature, or even tries to just co-exist with it; but moves to design that actually enhances and restores systems using feedback loops.

REFERENCES

- Biomimicry Institute. 2017. "The Biomimicry Design Process."
<https://toolbox.biomimicry.org/methods/process/#:~:text=The%20Biomimicry%20Design%20Spiral%20provides%20a%20succinct%20description,steps%20are%20described%20sequentially%20as%20a%20starting%20point.>
- Biomimicry Institute. "Nature's Unifying Patterns." Accessed December 15, 2021. <https://toolbox.biomimicry.org/core-concepts/natures-unifying-patterns/>
- Carless, David. "Feedback Loops and the Longer-term: Towards Feedback Spirals." *Assessment & Evaluation in Higher Education*, 44:5 (2019): 705-714, DOI: 10.1080/02602938.2018.1531108
- Hattie, John A. C., & Yates, Gregory C. R. *Using Feedback to Promote Learning*. In V. A. Benassi, C. E. Overson, & C. M. Hakala (Eds.). *Applying Science of Learning in Education: Infusing Psychological Science into the Curriculum*, (2014): 45-58. Retrieved from the Society for the Teaching of Psychology web site: <http://teachpsych.org/ebooks/asle2014/index.php>
- Muller, Gerrit. 2011. *Systems Architecting: A Business Perspective*. Boca Raton, Florida: CRC Press.
- Northcraft, G. B., Schmidt, A. M., & Ashford, S. J. (2011). "Feedback and the Rationing of Time and Effort Among Competing Tasks." *Journal of Applied Psychology*, 96(5) (2011): 1076-1086, DOI: 10.1037/a0023221
- Vierra, Stephanie. 2019. "Biomimicry: Designing to Model Nature". Whole Building Design Guide. <https://www.wbdg.org/resources/biomimicry-designing-model-nature>
- Zsembik, Leo. 2020. "Feedback Loop Helps Brain Teach Itself Quickly: Zebra Finch". AskNature. <https://asknature.org/strategy/brain-acts-as-both-teacher-and-student/>

OPERATING AT THE OVERLAP

Kelly Homan¹, Jennifer Smith¹, Robert Sproull¹

¹Auburn University, Auburn, AL

ABSTRACT: Historically academia has been divided into specified knowledge niches geared towards creating thinkers and practitioners linked to a specific discipline. As students enter college, they are funneled into program majors sometimes declaring their course of study before even beginning their academic journey. After an undergraduate major is achieved, master's degrees and doctorates follow for those interested in pursuing more and more focused studies. Students maneuver through this structure, growing ever more specified with each step. They learn over time to become researchers asking very discipline-specific questions. In design education, the product of this structure produces designers headed into fields like architecture, landscape architecture, graphic design, and industrial design. Designers graduate to industries where hyper-specialization has become the norm.

In the 1970s a group of scientists began asking if academic specializations were the only way to learn as it was becoming clear many of the world's most pressing and complex problems were interrelated in nature, unable to be solved by any singular expert. A different model of education and practice was clearly needed, and the concept of Transdisciplinary was born.¹ Designers, like scientists, are beginning to acknowledge that no one design field can ameliorate the world's problems. Design education is currently in its infancy of exploring research methodologies that break from a singular discipline, attempt to blur boundaries, and rethink the ways we transfer knowledge to each other.

This paper describes the current siloing of academic design programs, followed by an investigation of selected design education programs within the United States attempting to reconsider how design education is taught. Based on a set of established criteria, three programs are investigated to explore their structure, learning outcomes, teaching methods, and artifacts. The programs are then discussed for their similarities and their uniqueness from traditional design programs. Finally, one program is reviewed in depth to highlight how the program is structured and explore teaching methods used to facilitate interdisciplinary learning.

KEYWORDS: Interdisciplinary Design, Hyperspecialization, Design, Environmental Design

INTRODUCTION

"The ability to make connections across disciplines - arts and sciences, humanities and technology - is a key to innovation, imagination and genius..." (Walter Issacson, Leonardo da Vinci)

The difficulties facing the world today are unnervingly complex, and many of the solutions reside within the designer's domain – (the built environment). Part of what makes these problems so challenging are the interrelated nature of the social, political, environmental, technological, and financial origins they spring from. They are wickedly layered with consequences that are often paradoxical and extremely difficult to solve due to incomplete, contradictory, and changing requirements, some of which are challenging to observe and measure.² There are no single solutions to these problems, and they require systematic and interdependent efforts at various scales, over time. For these types of problems, an interdisciplinary design approach is critical as it ensures partnerships between disciplines are effective in their search for lasting and achievable solutions.

Historically academia has moved in a direction counter to this. It has been divided into specified knowledge niches geared towards creating thinkers and practitioners linked to a specific discipline. In design education, the process generated from this structure produces graduates headed into specific fields like architecture, landscape architecture, graphic design, and industrial design. As many of these allied fields have evolved in practice, they have moved towards this specialization model in pursuit of higher productivity. Within specific disciplines there is even further specified expertise. As an example, architecture has moved toward individuals within practice that concentrate on single intra-disciplinary portions of the process of creating the built environment. It is common in today's profession to find 'design-architects' differentiated from 'project-architects'.

Today's academic model utilizes a complementary process. As students enter college, they are funneled into program majors sometimes declaring their course of study even before they begin their academic journey. As they progress further through their education, students maneuver through a structure requiring ever more specialization with each step. They learn over time to become researchers asking very discipline specific questions. Within the walls of individual academic design disciplines, (each tethered to specific educational requirements for accreditation), it is difficult to focus

specifically on the overlap of the allied fields of design. After all, architecture schools exist for educating architects as do those for Landscape, Interiors, Graphic and Industrial Design. Designers, like scientists, acknowledge that no one design field can ameliorate the problems the world faces.

International award-winning design firms like Heatherwick Studio, Field Operations, Weiss Manfredi, Alloy Development, and Barke Ingels Group (BIG), to name a few, have been intentionally working in an interdisciplinary manner for decades. They recognize and celebrate: 1) the overlapping work within various design professions (via iterative process, foundation design considerations, divergent and convergent thinking, etc.), and 2) holistic, systemic approaches to design challenges. Many of these firms offer multiple industry services including architecture, landscape architecture, urban design, industrial design, infrastructure revitalization, and real estate development. Weiss Manfredi aims to “broaden the definition of architecture and search for opportunities to consider, both in physical and disciplinary terms, a larger territory for [design] expression.”³ The architecture firm responsible for Seattle Olympic Sculpture Park develops design responses where landscape, architecture, infrastructure, and art are integrated. Not only does Olympic Sculpture Park provide needed public space and waterfront access in the heart of Seattle, it restores a brownfield and threatened ecosystem. Furthermore, Field Operations works “from the scale of the city to the scale of a seat” acknowledging that designing across scales not only informs the design process, it also creates holistic responses for communities.⁴ Many of those in leadership at these firms have an interdisciplinary background in urban design, city planning, and landscape architecture. While interdisciplinary design is at the forefront of some select offices, this level of disciplinary collaboration is only beginning to inform undergraduate design education.

1.0 YESTERDAY’S SPECIALIST, TODAY’S HYPERSPECIALIST, TOMORROW’S HYPERGENERALIST

While interdisciplinary design education is crucial for the future of the planet, it is incongruent with Western economics, risk management, and many higher education models. Adam Smith foretold the economic benefits of the division of labor in his contribution to the economics’ cannon of literature - *The Wealth of Nations*. First published in 1776, it reflects upon early economics of the Industrial Revolution, the division of labor, productivity, and free markets. All of which continue to influence modern economies and the rise of hyperspecialization. Likewise, higher education is governed by specialized degrees nested within programs, schools, departments, and colleges. Various degree programs hold expertise within or “ownership” over areas of study such as entrepreneurship, design-thinking, health, urban design, sociology, and so forth. While these concepts are embedded within a multitude of fields, the financial models and bureaucracy of higher education lend themselves to specialization. Lastly, as construction projects have increased in scope and complexity, so have their contractual counterparts in an effort to facilitate risk management. For the project architect, alone, there are over 200 different legal forms and agreements available from the American Institute of Architects (AIA) Contract Documents. While this represents a needed increase in professional support and definition around roles and responsibilities, risk management, by nature, limits interdisciplinary work. An interdisciplinary design education has its obstacles within existing institutions; however, as valuable as specialized fields and areas of expertise can be, responding to complexity simultaneously demands designers be trained for professional collaboration while identifying new relationships between industries.

To better understand interdisciplinary and transdisciplinary design, it is pertinent to examine a brief history of disciplines and their overlap or separation in higher education. A discipline is simply understood as a field of study. When considering design as an overarching field of study, multiple disciplines could be considered part of it. These allied fields are often intertwined with each other to create the built environment, and their overlap presents unique challenges requiring specific abilities to maneuver through the design process to realize projects. This begs the question, is interdisciplinary design a discipline in and of itself, (with its own set of skills and goals), or is it an assemblage of other disciplines? In answering this question, one begins with a review of Gropius’ specific model for educating students of architecture at the Bauhaus.

The Gropius model approaches the education of architects as a field of study that is layered like an onion. As students spent more time within the program, more of an understanding was acquired about the discipline. Whether this specific model is appropriate in previous or later architectural education models is irrelevant. It is the layering that Gropius captures that is appropriate for education in all disciplines (design or otherwise). Essentially, the deeper a student moves towards the interior layers, the stronger their understanding develops. The diagram also implies that a deeper understanding is dependent upon comprehension of the shallower layers. What it does not cover, is the inherent overlap between the sub-topics of the discipline and the informative value found between them, for example, how one can learn a great deal about building technologies by understanding the history of architecture or the way that design methodologies might be informed by practice. A better diagram might be something like what is pictured below. The various subjects that make up the discipline and practice of architecture overlap in a multitude of ways and learning or working within one infers that architects and students must understand not simply one area of study, but several simultaneously. For the purposes of this discussion, this area is referred to as “the overlap” of knowledge and expertise.

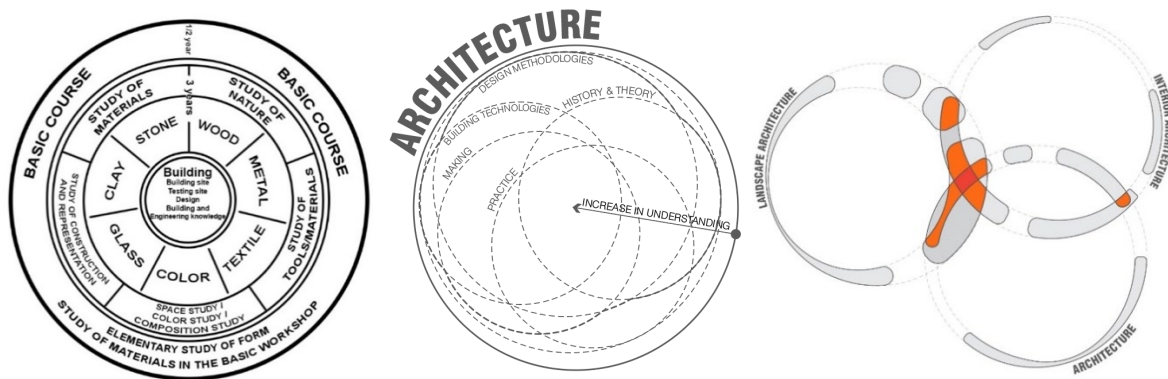

Figure 1: Diagrams of Education within a Discipline. (Far left: Architecture at the Bauhaus. W. Gropius, 1923, Center and far right: R. Sproull, 2022)

The act of operating at the overlap of design disciplines is understood by different names. Interdisciplinary, multidisciplinary, and cross disciplinary, are all well-known terms often loosely interchanged to define (sometimes incorrectly), the same thing. At the heart of these terminologies is an overlap of various expertise that work together to solve a problem through design. In general, cross disciplinary refers to the overarching notion of combining disciplines. It can encompass both multi- and inter- disciplinary design. However, there are subtle, yet meaningful, differences between these last two and working within them means a slightly different approach to the design process. Both approaches bring together different design disciplines to create a solution to a problem, but in multi-disciplinary design, each discipline is specifically focused on its own part of the problem.

Multi-disciplinary design is the most common form of design process as seen in many design-bid-build projects. It implies expertise and specialization within an individual's discipline and does not require individuals to consider areas of expertise other than their own. Communication is key for this process to be successful as it does not require individual proficiency in multiple fields. Interdisciplinary design, by contrast, is the process of combining various design fields into a cohesive whole. It involves bringing together different specialties within design, such as graphic design, industrial design, landscape architecture, and architecture. However, it can also involve working with other professionals outside of the design world, such as scientists, engineers, and other professions. It has been recognized in recent years as the design process best suited for complex problem-solving as it allows for a more diverse range of perspectives to be considered when approaching difficult questions and issues. Lastly, transdisciplinary design reconceptualizes existing theoretical frameworks embedded in traditional disciplines to create new fields of study and innovate within industries. Ecological Urbanism is an example of a more recent transdisciplinary design development (Ghisleni, 2022). All forms of cross-disciplinary work are advantageous for complex problem-solving, and each can be employed intentionally for emergent relationships to be discovered.

As interdisciplinary design firms become increasingly recognized as leaders in the profession (Lee, 2013), there is an increasing trend across the nation for higher-education interdisciplinary design degrees. Scholars and students, alike, recognize our global predicament and are interested in programs centered on responding to complexity. While we require professionals with a depth of knowledge and expertise in specific fields, there is an additional need for those working between industries through interdisciplinary and transdisciplinary design methods. In a paper from Nature Sustainability, authors write that "interdisciplinary has proven advantageous for scholars who find themselves at innovative institutions that recognize the value of collaborative work." Many universities over the past decade have bolstered cross-disciplinary research centers including the Climate School nested within the Earth Institute at Columbia University as well as Arizona State University's Global Futures Lab, in alliance with the University of Washington and the Nippon Foundation, started a center focused on social equity and ocean sustainability (Hernandez-Aguilera, 2021). Initiatives like these are uniquely positioned to include transformations in career development and capitalize on grant and foundation funding focused on collaborative processes. We require design practitioners who are prepared to strengthen collaboration across industries because they commence professional careers with an understanding of the values and responsibilities related to interdependent fields. Untethered to disciplinary boundaries, design professionals work as collaborative project managers amid complexity, fostering holistic design responses to stubborn problems.

2.0 DESIGN PROGRAMS OF THE FUTURE: CASE STUDIES

As discussed thus far, design education academic programs attached to a single discipline far outnumber design programs attempting to teach design across disciplinary boundaries. Design education in this respect appears to be far behind the sciences which have been exploring the concept of mixing disciplines through transdisciplinary teaching strategies since the 1970s. For this research paper, a set of criteria was established to find design programs in the United States that are actively pursuing ideas embedded in transdisciplinary/interdisciplinary research. The criteria were developed out of existing design program parameters within programs familiar to the research team. Due to the

flexible nature of this type of design education, no single term or academic program name is used. Environmental Design, Integrated Design, Interdisciplinary Design, Transdisciplinary Design, Design Studies, and just simply Design, are all used to describe a program not tethered to a specific discipline. The establishment of criteria allowed the researchers to extract three programs of interest for further examination.

The criteria established were as follows:

1. Program is a stand-alone 4-year undergraduate degree
2. Program must reside within the United States
3. Program learning outcomes state the objective of training students in design.
4. Program must not be accredited by a board specific to a single discipline, for example NAAB or LAAB, but the program could have the much broader NASAD accreditation.
5. Program must have dedicated, full-time faculty from different design disciplines teaching within the program
6. Program cannot have design discipline-specific tracks or a design discipline focus for students
7. Program cannot be within an Architecture program or any other singular discipline.
8. Program must have courses and learning outcomes specific to transdisciplinary/interdisciplinary design.

With these criteria applied, three undergraduate programs were chosen and will be discussed here. They include Integrated Design in the New School at Parsons School of Design, Environmental Design in the College of Architecture Design and Construction at Auburn University, and Environmental Design in the School of Architecture at The University of Hawai'i at Mānoa. The programs listed above have an approach to design education unique from discipline-specific programs. They all share the goal of training designers to tackle problems from a perspective not tied to one discipline. An architect is trained to think like an architect; a landscape architect is trained to think like a landscape architect. But what happens when you train students to think like designers without specificity?

2.1. Parson's New School: Integrated Design

The Integrated Design degree at Parson's New School is a four-year undergraduate degree dedicated to training "today's creatives to be skilled, versatile, and collaborative problem solvers in a quickly changing world". Upon completion of the program, students are awarded a Bachelor of Fine Arts. Parsons is a studio-based, 120-credit hour degree allowing students the flexibility to take courses from within the program and across the greater school. The curriculum includes a blend of courses in "service design, urban design, fashion design, entrepreneurship, sustainability management, consulting, fine arts, and emerging professional fields." Faculty teaching within the program have backgrounds and research focuses that include art, illustration, filmmaking, urban design, and others. The Integrated Design program has four categories of learning outcomes that are pursued. These include Art/Design Methodologies, Materials, Tools, Skills, General Education Skills + Practices, and Interpersonal Skills + Competencies. Student experiences within the learning outcomes are seek to "encourage familiarity with a broad variety of design work" with a focus on both traditional and digital tools commonly used in design. Also important within the outcomes is a working knowledge of design history, theory, and criticism. Integrated Design graduates have pursued careers across many categories including service design, urban design, fine arts, and sustainability management.

2.2. Auburn University: Environmental Design

The Bachelor of Science in Environmental Design at Auburn University is a flexible multi-disciplinary four-year degree. Courses within the program focus on sustainable practices with an emphasis on design thinking and the design process. Students are taught core design knowledge valued across many of the allied design fields with opportunities to include elective courses across the university. Environmental Design at Auburn contains two different types of course structures, a workshop style course that focuses on making and hybrid seminars that focus on design skills and research methods. Full time faculty teaching in the program have backgrounds in both landscape architecture and architecture with additional courses taught by faculty from graphic design, industrial design, and building science. The Environmental Design Program has ten learning outcomes that fall into four overarching categories that include: 1. Knowledge and understanding of basic concepts found within architecture, building science, community planning, graphic design, industrial design, interior architecture, and landscape architecture. 2. Acquiring skills related to effective design communication and design thinking. 3. The ability to use systems thinking to see problems as both global and local, interconnected in nature. 4. Knowledge of entrepreneurial practices and business strategies. Graduates from the program have gone on to such endeavors as law school, construction management, environmental non-profits, and positions at design firms.

2.3. University of Hawai'i at Manoa: Environmental Design

The Bachelor of Environmental Design at The University of Hawai'i at Mānoa is a four-year, pre-professional undergraduate degree centered on the design of the built environment. The studio-based program seeks to develop a student's skills across the fields of architecture, landscape architecture, and other allied design professions. A sequence of studios and seminars introduce students to a range of design skills and methods to tackle complex problems within the built environment. Along with studio courses, students take courses on "design communication, design technology, history and theory of world architecture and urbanism, environmental systems, and professional practice". Faculty teaching in the program have backgrounds in architecture, landscape architecture, and construction with learning outcomes that include design skills and methods, design communication, design technology, sustainability, interdisciplinary problem solving, history and theory, and professional practice. When examining these three academic

programs, their course structures, and student work outputs a few similarities emerge that separate the programs from traditional discipline-focused design programs. Those similarities are:

2.4. Flexibility

All three programs value a student's ability to be flexible with their course choices. While most traditional design programs allow a student to take "electives", transdisciplinary/interdisciplinary-focused programs tend to attribute more degree hours to this flexibility. An example of this would be Auburn's environmental design degree which allows up to forty hours of elective courses with available choices including classes in architecture, industrial design, graphic design, and art. A 2018 research study looking at electives offered across thirty different architecture programs found that "at present, several programs do not offer any electives, whereas others offer limited time for electives" (Ghonim and Eweda, 2017) Discipline-specific accreditation including NAAB and LAAB accredited programs (architecture and landscape architecture) have strict criteria for content that must be taught. NASAD accredited programs, or programs that have no accreditation, allow students to take a variety of courses and in turn, learn skills across a multitude of design-related areas. The ability to take courses across disciplines affords students a unique opportunity to be exposed to ways of thinking and doing in more than one discipline.

2.5. Multi-Disciplined Faculty

One of the more interesting aspects of a truly interdisciplinary program is the expertise of the faculty teaching in the program. While many traditional design programs use adjuncts or part-time faculty to fill in and teach courses that may be focused on other skills outside of the traditional professional requirements, interdisciplinary programs have most courses taught by faculty from varying backgrounds. A student getting an architecture degree will have the bulk of their program courses taught by someone trained in architecture. A student pursuing an interdisciplinary design degree will have most courses taught by faculty across disciplines including architecture, landscape architecture, graphic design, industrial design, fashion design, art, and others.

2.6. Student Work Outputs

The artifacts produced within programs teaching design skills across disciplines are varied and can include many different types of artifacts even within a single class. Recent student work from the Integrated Design program at Parsons includes a bilingual children's coloring book, an art installation exploring the idea of beauty, a guidebook on food security, and a proposal to reimagine homes and gardens in a historic neighborhood. A survey of work outputs from the Environmental Design program at Auburn included designs for disaster relief housing, a proposal for an urban trail network, abstract model explorations, and patterned art drawings using graphite on linen paper. When freed from producing work that must fall into a specific disciplinary category, students can explore the design process in a variety of ways with a variety of outputs and artifacts. Program outputs will be discussed in more detail below.

The three programs described here represent a sampling and are by no means the only academic programs focusing on interdisciplinary design education. Little research to date has been conducted on these types of design education programs, their specific teaching methods, and their value separate from more traditional programs. More research is needed to understand this type of design education and the value it brings to the design world.

3.0 AUBURN UNIVERSITY: ENVIRONMENTAL DESIGN PROGRAM

At Auburn University, the Environmental Design program is reconceptualizing how undergraduate design education teaches: 1) foundation design theory, 2) interdisciplinary design methods, and 3) advancing beyond a generalist position to intentionally work within the overlap of design disciplines. Positioned as intentionally anti-specialist, the curriculum acknowledges that a more resilient future necessitates education of professionals who, rather than specialize, work as collaborative project managers finding shared value between disciplines. This is accomplished through the program's hybrid-studio teaming projects, diversity of design faculty, and multidisciplinary design students.

Nested within the College of Architecture, Design and Construction, the undergraduate program integrates the design disciplines of architecture, interior architecture, landscape architecture, industrial design, and graphic design as well as students with the aim of joining construction firms upon graduation. An undergraduate student can also participate in the program through a minor, incorporating other design and non-design related disciplines such as interior design, finance, marketing, engineering, and so forth. In the future, there is hope of integrating the newly created minor in real estate development to more holistically integrate professionals focused on the built environment. For the reasons listed previously, it is advantageous to teach design methods including iterative process, divergent thinking, and problem solving across scales and systems to a range of students. For example, ENVD senior, Aubrey Sanders, aims to attend graduate school for city planning and has a portfolio of design work ranging from urban design, landscape architecture, and interior design projects. Design projects are limited in scope and allow students to practice within a range of design disciplines while recognizing their interdependence.

The program is eight semesters and focuses on foundation design concepts born out of the Bauhaus Basic Course. Early courses focus on color theory, composition, materiality, research visualization, abstraction, and form-making. Later courses center on research, industry-specific seminars, and developing built environment theoretical frameworks for appropriate and contextualized artifacts, systems, and processes untethered to traditional disciplinary boundaries.

Courses are taught by Environmental Design faculty with pedagogical interests in: 1) interdisciplinary and transdisciplinary design, 2) foundation design education, and/or 3) industry-specific fields of study within architecture, landscape architecture, construction, graphic design, urban design, and more. Environmental Design students have additive interests within the built environment, and a focus on foundation design education, interdisciplinary design theories and methods, as well as opportunity to slightly specialize is congruent with trajectories. Just as one-third of architecture graduates do not pursue traditional architecture practice, many Environmental Design students diverge upon graduation pursuing a range of interests. For example, summer 2022 graduates in an Environmental Design senior capstone course pursued professional positions and graduate programs in landscape architecture, construction, and architecture. Over the last five years, ENVD students have pursued graduate programs and professional practice in law, real estate development, industrial design, architecture, landscape architecture, construction, communication design, and historic preservation.

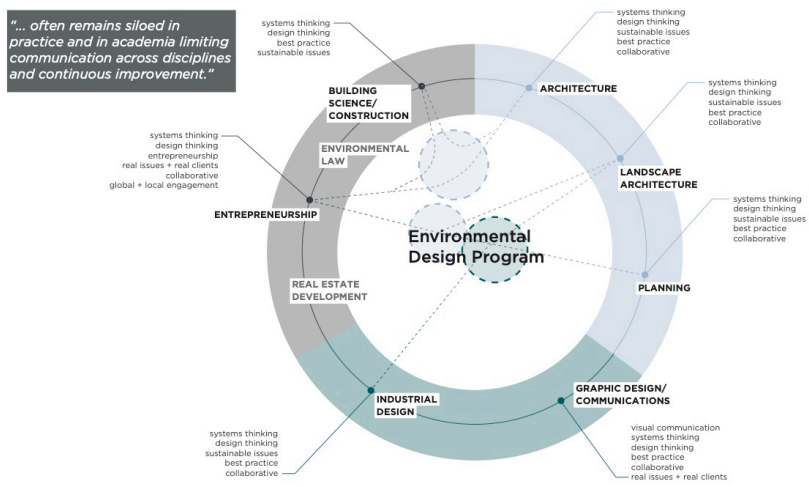

Figure 2: Diagram of Environmental Design Strategic Positioning (J. Smith 2020)

3.1. Foundation Design Education

Foundation design education is reinforced in almost all environmental design courses as a common thread between design disciplines. Foundation design, as mentioned previously, is born out of the Bauhaus Basic Course and focuses on color theory, composition, materiality, research visualization, abstraction, and form-making. This is initially taught in the first environmental design workshop where students focus on having a single concept manifest abstractly through various media and scales. For example, students start with learning analog drawing techniques by means of a large, abstracted graphite drawing. Ideas embedded in the drawing are then translated to a spatial physical model. Lastly, students create an organizational brand and graphic guide for their work and represent final ideas on a printed affiche as they simultaneously learn required software. Artifacts are limited in complexity and allow students to congregate learning around design concepts. Additionally, the variety of project types integrate concepts from architecture, graphic design, landscape architecture, and more. Like many foundation studios, students learn how the design process permeates a range of disciplines, scales, and project typologies.

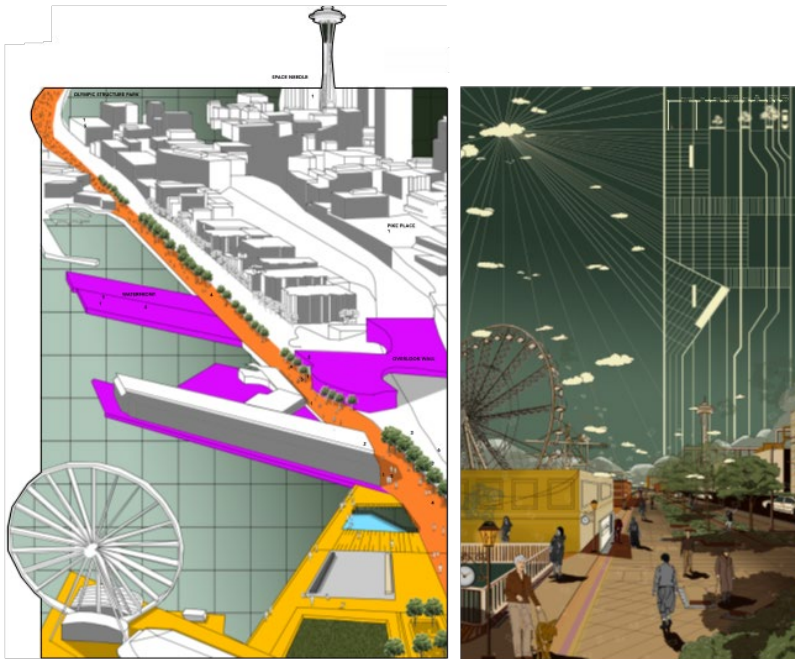

Figure 3: ENVD 4100 Seattle Capstone : XL-Scale Urbanism Project Typology (K. Bhelay, 2022)

3.2. Interdisciplinary Design Methods

The Environmental Design program intentionally guides collaboration and interdisciplinary design through multiple hybrid studio-seminar courses. For example, ENVD 4010: Design-Thinking and Communication is taken during a student's junior year and focuses on end-user research, participatory design, and various typological responses to the same set of conditions. Groups of 3-4 students conduct site analysis and end-user research through primary and secondary research means and produce graphic visuals communicating findings to stakeholders. Part two of the semester-long course introduces students to participatory design and civic engagement. Students co-design with end-users as this process more fully captures problems, opportunities, and the project scope, while also allowing students to engage locally. Starting at mid-term students begin the final portion of the course by designing a range of typological responses on the same site with similar constraints and goals. Projects may be temporal in nature, digital, architectural, landscape, or an exhibit installation. The variety of appropriate responses indicates that there is a myriad of successful means for responding to the same set of conditions. This conclusion not only advocates for a diversity of design disciplines, it allows students to think even more divergently about how one might respond to a complex project. The learning outcomes of this course manifest in various forms throughout the Environmental Design curriculum to reinforce concepts.

3.3. Designing in the Overlap

Lastly, the capstone environmental design course introduces transdisciplinary design methods. As defined earlier, transdisciplinary design is where two or more disciplines collaborate closely so that disciplinary boundaries overlap, and new theoretical frameworks emerge. Emergent theoretical frameworks influence professions and are catalytic for innovation.

The Environmental Design Program includes this introduction in the final studio where students conduct a site visit to Seattle and examine projects acting as an assemblage of traditional disciplines. Olympic Sculpture Park, Freeway Park, the Bullitt Center, Gas Works Park, and the massive Waterfront Seattle initiative are all examples, and they broadly include design considerations nested in urban design, landscape architecture, infrastructure revitalization, architecture, and ecology. One student, Alexandra Toney, developed an experiential installation exhibit along the Seattle waterfront to educate visitors on how adverse maritime noise impacts salmon migration, breeding, and endangered marine life. The enclosed installation hovers above the water and provides a sensory experience combining human and marine life sounds as well as their resultant impact on animal migration patterns. The project proposal intentionally integrates installation design, acoustics, educational theory, and life sciences. While experiential learning as an educational theory has existed since 1971 (McDougall, 2014) and experiential design has existed since ancient cave paintings and hieroglyphics, Toney's examination into their influence on spatial design and advocacy is profound. This example indicates the commencement of a theoretical framework that could be further developed in graduate school and professional practice.

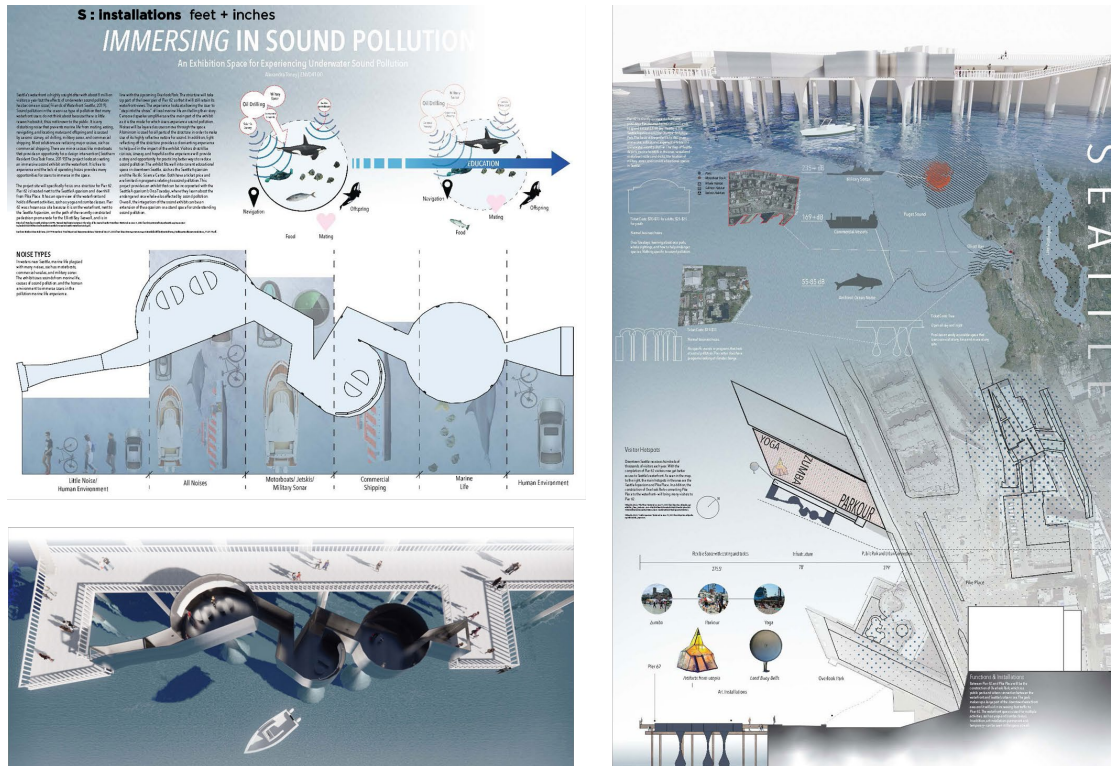

Figure 4: ENVD 4100 Seattle Capstone : M-Scale Exhibit Design Project Typology (A. Toney, 2022)

CONCLUSION

Since the Bauhaus, examples have emerged of early education intentionally “un-siloing” design fields and integrating traditional disciplines (Lerner, 2005). Elusive, however, are present design pedagogies conceptualizing that future specialization is optional. Many programs initially organize design studios generally, and later require students to select a specific design field such as urban design, landscape architecture, architecture, industrial design, graphic design, and so on. While this form of design education is critical, it should not be the sole framework as it limits future design professionals to collaboratively problem solve for appropriate solutions. This model compels team members to advocate for their disciplinary and contractual scope of work, which may not produce the most appropriate solution for end-users and environmental conditions. In an AIA report researchers found that collaborative, integrated project delivery (IPD) methods promote sustainable results and allow for increasingly aggressive goals as team members are incentivized to increase overall project success (EMEA,2022). Germane to contemporary design practice focused on collaborative responses to real world complexities, an interdisciplinary undergraduate design degree that does not suppose students later specify an area of study is necessary, and their implementation is growing nationally.

While design education and practice are increasingly specialized, even hyperspecialized (Malone et al,2012), synchronous with technological advancements and robust building systems, contemporary wicked problems require additional designers who work between disciplines to develop emergent fields of study. Interdisciplinary and transdisciplinary design are critical in undergraduate education and professional practice as they promote diverse typological responses, rather than advocating for physical and nonphysical artifacts nested within traditional disciplinary boundaries. This integrated approach to design responds to complexity through the development of new theoretical frameworks and diversity of perspectives informing the design process. The programs described here, along with others, are recognizing this need and educating future designers to work as co-advocates and innovate across industries for a more resilient future.

REFERENCES

Ghisleni, Camilla. “What Is Ecological Urbanism?” ArchDaily. ArchDaily, March 4, 2022. <https://www.archdaily.com/977930/what-is-ecological-urbanism>.

Lee, Youngjin, Gesamtkunstwerk in Design: Interdisciplinary Design and Pedagogy, ARCHITECTURAL RESEARCH, Vol. 15, No.3 (September 2013). pp. 111, Architectural Institute of Korea, 2013

Hernandez-Aguilera, J. Nicolas, Weston Anderson, Allison L. Bridges, M. Pilar Fernandez, Winslow D. Hansen, Megan L. Maurer, Elisabeth K. Ilboudo Nébié, and Andy Stock. “Supporting Interdisciplinary Careers for Sustainability.” *Nature Sustainability* 4, no. 5 (2021): 374–75. <https://doi.org/10.1038/s41893-020-00679-y>.

Ghonim, M. Eweda, N. (2018). Investigating elective courses in architectural education. *Frontiers of Architectural Research*, 1–22. <https://doi.org/https://doi.org/10.1016/j.foar.2018.03.006>.

- McDougall, Katherine. "Experiential Learning for the History Classroom: Engaging Learners on Different Levels and in Different Ways to Encourage a Lifelong Love of Learning." TSpace. Ontario Institute for Studies in Education of the University of Toronto, April 2014.
https://tspace.library.utoronto.ca/bitstream/1807/67044/1/McDougall_Katherine_A_2014June_MT_MTRP.pdf.
- Lerner, Fern. "Foundations for Design Education: Continuing the Bauhaus *Vorkurs* Vision." *Studies in Art Education* 46, no. 3 (2005): 211–26. <https://doi.org/10.1080/00393541.2005.11650075>.
- EMEA, John Bradley Frameworks Lead, and Alex Mathewson Head of Procurement EMEA. "Design and Construction: Rethinking Procurement to Drive Innovation." AECOM: Without Limits. Accessed April 27, 2022. <https://aecom.com/without-limits/article/rethinking-procurement-to-drive-innovation/>.
- Malone, Thomas, Robert Laubacher, and Tammy Johns. "The Big Idea: The Age of Hyperspecialization." *Harvard Business Review*, August 1, 2014. <https://hbr.org/2011/07/the-big-idea-the-age-of-hyperspecialization>.

ENDNOTES

- ¹ Apostel, L. (ed.) (1972). *Interdisciplinarity: Problems of Teaching and Research in Universities*. Paris: Organization for Economic Cooperation and Development.
- ² "What Are Wicked Problems?" The Interaction Design Foundation. Accessed November 28, 2022. <https://www.interaction-design.org/literature/topics/wicked-problems>.
- ³ "Approach - Studio." Weiss/Manfredi. Accessed November 28, 2022. <https://www.weissmanfredi.com/studio/5-approach>.
- ⁴ Fo. "Profile." Field operations - profile. Accessed November 28, 2022. <https://www.fieldoperations.net/about-us/profile.html>.

Research-Design Interface for a Critical Teaching Practice

Patricia Kucker¹, Cathy Braasch¹

¹Penn State University, University Park, PA

ABSTRACT: For most design educators, teaching is a design activity. Educators recognize that the complexity of problems facing designers today often exceeds an individual's disciplinary expertise and capacity. Teamwork and collaborative skills are essential to contemporary design practice that regularly engages multi-disciplinary perspectives and multiple stakeholders. What role does the research-design interface play in developing effective pedagogical approaches for the collaborative skills students need to engage in complex design problems?

Our research begins with a review of art and design journal publications over a decade. With a semi-systematic literature review method, we focused on the themes of pedagogy and best practices for collaboration, issues of culture and conflict, and assessment practices. Our expanded search netted over 4,000 entries, and we found a body of empirical research and theoretically informed pedagogical practices for collaboration and student learning across multiple disciplines. However, only a few publications address the art and design context. Missing from most of the art and design research studies, and at times identified by students through feedback, are the ideological and procedural practices associated with effective teamwork and group activities. These outcomes raise a critical need for theoretically informed pedagogy to prepare art and design graduates more effectively with these essential skills and experiences. Additionally, the low level of research-informed pedagogy indicates a gap in the theory-praxis model that is essential for cultivating a critical teaching practice.

KEYWORDS: collaboration, team-based learning, cooperative learning, and group learning

INTRODUCTION

In design education, problem-based learning is prized for its pedagogy and the community of learners it creates in the studio setting. Philosopher and urban planner Donald Schön (1983) champions the unique learning environment of the design studio as central to architectural education, the profession, and the pedagogy for teaching design. The teaching practices of the design studio are considered a signature pedagogy and are defined by practices that persist across programs and institutions. These practices implicitly define core knowledge in a field, a culture of learning and professional norms (Shulman 2005). Pedagogy and disciplinary content are not static and over time teaching practices change to remain vitally connected to the evolving character of the professions they serve. The shifting relationship between disciplinary knowledge, skills, and the needs of professions are codified through accreditation standards.

An accredited degree curriculum and formative student learning experiences are approved in response to established standards and criteria that are established by the accrediting body. Embedded in the accredited degree program are essential competencies graduates must possess for professional licensure. The accreditation standards for architecture and landscape architecture prioritize “leadership and collaboration on multidisciplinary teams; and the incorporation of knowledge from other disciplines (LAAB, 2020 p.14),” and require that students “learn how to apply effective collaboration skills to solve complex problems” (NAAB, 2020 p. 2).” Meredith Davis, author, graphic design practitioner, and dean emerita in her book, *Teaching Design*, describes multiple forms of collaborative relationships and concludes “the intent is to work beyond boundaries of a single field and to benefit from alternate perspectives that shift traditional views on problems (Davis, 2017, p.108).” The increasing demand for graduates with collaborative problem-solving skills arise from the fluid multi-disciplinary practices and the expanding cultural and social diversity both inside and outside the academy.

The collaborative learning environment is highly valued. Effective collaborative learning builds higher levels of student engagement, student self-efficacy, critical thinking, and essential workplace skills (Goodsell, 1992; Kuh, et al., 2011; Kilgo et al., 2015; OECD, 2017). Research focused on student learning and pedagogy in context, referred to as the scholarship of teaching and learning (SoTL), has increased substantially over the last forty years and related directly to increasing student success (Hutchings & Shulman, 1999). Researchers confirm there is little debate over the need to develop collaborative skills in college and within and among the design disciplines. How to design effective collaborative learning experiences and impart the skills for collaboration among peers and across multiple disciplines is an essential pedagogical issue (Goodsell, 1992; Davis, 2017; OECD, 2017). Our research considers collaborative learning experiences in the context of art and design disciplines, and is guided by three primary questions:

- Q1. What are the most effective pedagogical practices for developing successful collaborative learning and collaborative skills in the studio?
- Q2. What role do social dynamics, cultural differences, and power play in group-work conflicts and collaboration in the studio?
- Q3. What are the most effective assessment practices for evaluating collaborative learning in the studio?

1.0 THE ART & DESIGN CONTEXT

The context for student learning differs from the team-based and multi-disciplinary character of practice. In his book, *Designing Relationships: The Art of Collaboration in Architecture*, architect, and educator Andrew Pressman FAIA, identifies four reasons for an architect's hesitation for collaboration, and the first reason begins in the studio and design school. The studio spaces in design schools across the country are arranged for individual work and one-on-one desk critiques. Pressman notes, "architects learned the habit of designing only by themselves in architecture school (p.5)." Educator Dana Cuff, in her book, *The Story of Practice* identifies the socialization of architecture schools with training and evaluation based on finished products of single individuals and laments that students do not "learn about the social construction of architecture, about collaboration skills... (p.44)." In the best-selling novel *The Fountainhead*, the struggling architect Howard advances the role of a visionary design genius when he states, "No great work is ever done collectively." The model of a singular genius persists in the structures of the academy. Design faculty do not achieve tenure unless they can demonstrate distinction based on their singularly authored creative work or scholarship (Pressman, 6).

The value of teamwork and the student's understanding of the skills for collaborative work begins in school. Students learn through direct experience in the studio or through the role models in the faculty that surround them (Chapman, et al., 2010, Chapman and Van Auken, 2001, Panitz and Panitz, 1998). Design faculty often voice a commitment to preparing students for teamwork and collaboration that they will encounter in the professions, yet structured activities for learning how to work with others are not a common student experience (Davis, 2017). When group projects are offered, faculty tend to evaluate the merits of the project outcomes and don't evaluate the quality or process of the collaboration. As a result, the importance of effective social interaction and collaborative skills during the design process is devalued in the face of more obvious visual or physical outcomes present in the design solution (Chapman and Van Auken, 2001). If collaborative skills are not valued by faculty through the mechanisms of assessment for example, then they are not valued by students.

The goal of collaborative learning is to learn how to engage complex problems more effectively, produce innovative outcomes, and develop high-functioning social skills in a group context. Collaborators cultivate a refined set of social skills to effectively listen to others' points of view, treat their ideas with respect, diffuse conflict, and develop teams with equal decision-making power. Faculty and students in design studio courses often struggle with teams that devolve into poorly functioning groups (Davis, 2017, Panitz and Panitz, 1998). Dysfunctional group learning is most often the result of poor group training as well as limited knowledge on the part of educators for structuring and managing group social dynamics, developing pedagogies for collaboration, and managing effective assessment rubrics (Chang and Brickman, 2018; Davis, 2017; Chapman, et al., 2010, Panitz and Panitz, 1998). Faculty report that group work is difficult to assess, and remains difficult when the assessment is on the quality of the design project outcomes while also trying to discern each student's contribution (Davis 2017; Panitz and Panitz, 1998). A further complication resides in the historic apprenticeship culture of design education and teaching culture with little connection to the education theory, and the psychology of student learning. Taken together these issues impact a faculty's decision to minimize group work, even though collaboration is a high-value student-centered educational experience and core professional skill set for design professionals.

2.0 RESEARCH METHODS

2.1 Search terms and databases

Our research methodology is a semi-systematic literature review of pedagogy and practices for collaboration with a meta-analysis approach. A systematic literature review is a 'study of studies' and relies on methods and criteria for identifying publications (Snyder, 2019). We partnered with a librarian to define our search protocols and worked with a group of student readers to code the inclusion criteria. Developing our search protocols was a revealing process. We restricted the search to peer-reviewed journals and began with the search term "design pedagogy." We consulted the Education Resources Information Center database (ERIC) and defined a search period from 2011 – 2020. Our search yielded only 29 entries.¹

With modest results for this search, we considered that journals publishing education research reflecting the design disciplines may not be indexed by ERIC. For example, the *Journal of Art and Design Education* is indexed by ERIC, but the *Journal of Architectural Education* is not. The *Landscape Architecture Journal*, *Art, Design & Communication in Higher Education*, and the *International Journal of Construction Education and Research* are also not included in ERIC. The Avery Index to Architectural Periodicals offers comprehensive listings of journal articles on architecture and design, and subjects such as the history and practice of architecture, landscape architecture, city planning, historic

preservation, and interior design and decoration. To more fully consider architecture and design disciplines we searched the Avery index and the four design journals identified. To focus on our research question regarding collaboration, we added the search terms “collaborative learning,” “team-based learning,” “cooperative learning,” and “group learning.” Thirty-four research publications were identified over the ten-year period.

We then chose “collaboration” and several additional search terms “team-based learning,” “cooperative learning,” and “group learning” for their close relationship to collaborative learning. While these terms are often used interchangeably, there are important distinctions to consider. Cooperative learning is considered a type of collaborative learning where the group members are responsible for a specific section of their learning and contributing to the success of the group’s goals. The roles and structure of cooperative learning are typically pre-defined. The cast and crew of a play or theatre production is an example of a cooperative learning group. Team-based learning is a form of collaborative learning and is defined as an activity carried out in small groups. Emphasis is placed on out of class preparation and the sharing and application of knowledge by the group or groups in class (Davidson and Major, 2014). Because faculty often use these terms interchangeably, we wanted to be inclusive in developing the search protocols.

We returned to ERIC for a new search with the search terms “collaborative learning,” “team-based learning,” “cooperative learning,” and “group learning.” And included the term “design” to focus on the ERIC outcomes on the design disciplines or the activity of design. The table below identifies the ERIC search terms as individual and combined searches. With this set of outcomes from ERIC, we grouped results by the search terms. We chose the most inclusive search outcomes for analysis and will include outcomes from the Avery and design journal search for analysis.

Table 1: Search criteria for ERIC.

Search terms	Entries
Higher education and 2011 - 2021	
“design pedagogy”	29
“collaborative learning”	1,115
“collaborative learning” AND “design”	354
“team-based learning” AND “design”	36
“cooperative learning”	3,572
“cooperative learning” AND “design”	1,012
“group learning”	172
“group learning” AND “design”	44
“collaborative learning” OR “team-based learning” OR “cooperative learning” OR “group learning”	4,300

2.2 Inclusion criteria and coding

With the outcomes from the most inclusive search (n=4,300), we read the abstracts and coded each for the academic discipline served. For each abstract, we searched for evidence-based methods and outcomes over narrative or case study based only on a theoretical foundation. Our goal is to identify research with evidence-based criteria for accountability and to be able to replicate the pedagogy and practices of the research. In addition, and during this review, we applied our inclusion criterion resulting in a smaller set of outcomes described in the second column of the table below (n=2308). Additional analysis for the inclusion criterion derived from our research questions are documented in the subsequent columns in Table 2.

Table 2: Disciplines and Inclusion Criteria.

<i>Discipline</i>	<i>All Entries</i>	<i>Evidence-based</i>	<i>Evidence-based and pedagogy best practices</i>	<i>Evidence-based and conflict resolution</i>	<i>Evidence-based and Assessment practice</i>
Visual Arts (Hum.)	76	37	14	2	5
Humanities (not Vis Art)	535	286	142	73	31
Education (Soc. Sci.)	1896	1030	456	144	210
Social Sciences (not Educ.)	173	96	43	15	16
Natural Sciences	481	265	102	19	44
Formal Sciences	282	152	68	14	20
Business (Ap Sci)	228	114	45	18	14
Engineering & Technology (Ap Sci)	330	175	80	19	36
Medicine & Health (Ap Sci)	155	100	44	10	21
Other Applied Science	144	39	20	11	7

Design Avery + un-indexed journals	34	14	8	0	5
Total	4334	2308	1022	325	409

*Entries: ERIC with disciplines and Design outcomes from Avery and unindexed design journals.

The inclusion criteria are defined in the table below with examples that may be found in the abstracts or full research papers.

Table 3: Inclusion Criteria.

<i>Criteria</i>	<i>Definition and examples</i>
Pedagogy and Best Practices	Using a specific educational instructional method such as a case study or precedent study, role-playing, design-build, experiential learning such as study abroad, internships, constructivist approach, and community engagement.
Social Dynamics and Group-work conflict resolution	Identifies management strategies for social dynamics and conflict resolution. Strategies address issues of gender and equity, marginalized students, negotiation, goal setting, trust, competition, leadership conflicts, workstyles, personality conflicts, communication styles, listening, and team management.
Assessment Methodologies	Identifies methods to evaluate student learning experiences and opportunities for meaningful feedback. Surveys, student feedback opportunities, peer assessments, and statistical data comparing multiple individuals or groups with criteria. Assessment practices for collaborative learning and skills are highly valued.

We returned to review the pool of visual arts abstracts from ERIC and the entries from Avery and the design journals (n=79+34). A title cross reference of entries revealed duplicates. A smaller pool of unique entries is the resulting group for further analysis (n=37). In this group, each of the publications was read in full to identify research methods and to further capture content defined by our research questions. A small research sample sizes (n<10) or a descriptive focus resulting in a case study narrative reduced the group of research studies (n=15). A review of the studies for analysis (n=37) with the inclusion criteria of “pedagogy and best practices” resulted in eliminating some studies when a specific educational method or best practice was not identified (n=25). This process of reviewing the pool of studies (n=37) continued for the remaining criteria related to our research questions.

Table 4: Visual Arts and Design entries* (n=37).

<i>Disciplines</i>	<i>Evidence-based research design</i>	<i>Pedagogy & Best Practices</i>	<i>Conflict & Culture</i>	<i>Assessment Practice</i>
Architecture	2	2	2	1
Communication Design, Graphic Design	2	3	3	2
Computer Engineering, Computer Science	2	1	1	1
Design	2	2	2	2
Interior Design	0	1	1	1
Media Arts, Film	1	2	1	0
Music	2	5	5	1
Performing Arts	0	1	1	1
Teacher preparation, Arts & museum education	0	2	0	0
Visual Arts	3	5	4	3
Management Studies Business+	1	1	0	1
Total	15	25	19	13

*Entries are from ERIC Humanities (Vis Arts), Avery, and un-indexed design journals

+a miscoded entry

3.0 FINDINGS

We searched relevant sources over a ten-year period for research studies advancing collaborative learning, teaching practices, and skills. Our expansive search found only a small number of journal publications with evidence-based teaching practices and collaborative learning in the arts and design disciplines and a large number of publications existing outside the art and design disciplines. The greatest number of publications are from the disciplines of education (44%), followed by the humanities (12%), natural sciences (12%), and applied sciences such as engineering (8%). Publications from art and design disciplines are less than 5%. We are being careful not to make a direct comparison

because the disciplines of higher education vary in relative size and therefore will contribute to the variation in the volume of research publications.

Our inclusion criteria for empirical research methods had a significant impact on our research and analysis. Evidence-based research accounted for 53% of the publications in our search (n=2308). For the art and design research studies, 40% were defined by empirical research methods resulting in a very small pool (n=15). Such a small number of studies meeting the criterion for empirical research can be extrapolated as a scarcity of well-structured, well-designed, research on pedagogy linked to collaborative learning in the arts and design classrooms and studios. Art and design faculty are known to focus more on creative production in comparison to the empirical research defined by Ph.D. faculty and this may be a contributing factor to the low number of evidence-based research studies. Our literature review is focused, however low levels of scholarship and research publications for teaching and learning in the creative disciplines can have profound implications for advancing critical teaching practices and meeting the needs of students (de la Harpe, et al., 2008).

Q.1. What are the most effective pedagogical practices for developing successful collaborative learning and collaborative skills in the studio?

The research-based studies identified theories of student learning including constructivism, experiential learning, learning from real-life situations, and communities of practice. Principles of student-centered learning such as the role of social interaction, levels of participation for genuine learning, and the need for self-motivation and self-advocacy were identified frequently. Descriptions of role-play with students emulating the team structure and workflow found in a professional environment, for example, was one of the most prevalent pedagogies described. Several research studies featured technology-mediated environments where the technology facilitates collaboration and group members could work synchronously and asynchronously. Technology platforms include visually supported collaboration technology such as Mural and Conceptboard, and for the design and engineering disciplines Building Information Modeling (BIM) is prominent. Missing from the majority of research studies, and at times identified by students through feedback are the ideological and procedural practices associated with effective teamwork and group activities. These include the faculty's role in creating a structure for work procedures, and explicitly teaching social and communication skills (Davis & Major 2014). The essential pedagogical practice raised across several studies are the faculty's role in the organization and planning of groups and assignments, clarity of expectations, roles and workflow, an adequate rationale for the collaborative group work structure, and the faculty's participation. When comparing the collaborative practices in two architecture design studios, researchers acknowledge the impossibility of eliminating problematic issues from the messy collaborative environment, and propose faculty share their teaching experiences and develop well-designed strategies and practices to confront these ever-present issues (Allen, 2016).

Q2. What role do social dynamics, cultural differences, and power play in group-work conflicts and collaboration in the studio?

Results from the studies identify social dynamics of group work are an essential component of student satisfaction and significantly impact student attitudes regarding the value of collaborative learning. Issues of race, gender, and ethnicity were not identified in the research. Students were found to have more positive attitudes about working in groups when some level of training for teamwork responsibilities and group management issues was provided. Student perceptions of inequitable workloads and the inability to resolve intra-group conflict, cultivate effective communication, and establish goals were examples of how social dynamics interfered with student learning and negatively impacted the desire for future collaborative experiences.

Q3. What are the most effective assessment practices for evaluating collaborative learning in the studio?

Assessment practices varied across the research studies and typically focus on student feedback for satisfaction in the learning environment. Student surveys with ranked responses and open-ended questions were prominent assessment tools for faculty. Providing timely and purposeful assessment during the workflow was often cited as was peer-assessment. Students and researchers expressed concern about who performed a summative assessment of the collaborative learning environment and finished product outcomes, and the clarity and fairness of the evaluative criteria. A few researchers underscored assessment focused on the roles and contributions made during the process of collaborative work rather than a singular focus on the group's delivered outcome. The research identified social power dynamics resulting in student anxiety about sharing ideas in a competitive grading context. Several research studies were for pre-service educators (n=4) and considered the design of assessment practices for online environments and disciplinary practices, such as teaching improvisational music. Feedback from one research study engaging faculty across three visual arts units concluded that the new structure for assessment tasks, supported by scholarly research, contributed to developing new creative and critical perspective within the faculty. The Backward Learning Plan is an example cited (Allen, et al., 2014).

SUMMARY & CONCLUSION

Our literature review revealed limited journal publications focused on teaching collaborative learning in the arts and design disciplines. Our results appear to be a mismatch between the faculty and academic programs identifying collaboration as a hallmark learning experience. Patterns of faculty research and scholarship may however be a qualifying factor. The analysis of the publications demonstrates that many art and design faculty are aware of educational theory and use it to situate or inform their academic writing on learning and teaching. Theoretically-informed research studies were evident in more than half of the small pool of journal publications we reviewed. Continued analysis did not yield evidence that the authors discussed their teaching practice in theoretical terms or deliberately employed models or best practices with theoretical underpinnings. Missing from the majority of research studies, and at times identified by students through feedback are the ideological and procedural practices associated with effective teamwork and group activities. These outcomes suggest the need to improve and develop new pedagogies for effective collaborative learning.

Research publications of studies incorporating assessment practices revealed practices focused primarily on student satisfaction. Student feedback from the research identified a range of social conflicts, including communication and negotiation of responsibilities, and group grading practices as the leading cause of student dissatisfaction in the collaborative learning environment. The pedagogical approaches and teaching practices in place to resolve the inevitable conflict occurring in group work relationships were not identified by the faculty and not assessed in the research studies.

For most design educators, teaching is a design activity, and design practice engages research to inform problem-framing and problem-solving. Our research yielded few journal publications incorporating theoretical foundations or prior case knowledge to create theoretically informed, well-designed and effective strategies for collaborative learning and skill development. These results are one indicator of a gap in the theory/praxis model that is essential for cultivating a critical teaching practice in the community of art and design educators.

LIMITATIONS

There are limitations to our study. A systematic review relies on a process to identify a range of evidence-based research publications in response to a research question. Our multi-step review process is explicit, however, at a certain level of review and coding of the search entries, there is an interpretation by the research team members. This process creates limitations for consistency even though we met regularly to discuss findings and interpretations.

FUTURE RESEARCH

Our research will continue with the analysis of the remaining publications across multiple disciplines. In addition, we welcome partnerships with art and design faculty offering collaborative learning environments for their students.

ACKNOWLEDGEMENTS

This research was supported by funding from the College of Arts and Architecture Faculty research grant at Penn State. The following students were invaluable contributors: Jessica Zabinsky, Danica Williams, Sydney Yankowenko, Josh Achampong, Kaila Colley, Esmael Maalej, Hannah Rinne, Ciera Jones, Erica Wunschel, Hiranschi Patel, and Kali Lewis.

REFERENCES

- Allan, E H. "I Hate Group Work!": Addressing Students' Concerns About Small-Group Learning." *InSight: A Journal of Scholarly Teaching*, August 1, 2016. <https://doi.org/10.46504/11201606a1>.
- Allen, Jeanne, Suzie Wright, and Maureen Innes. "Pre-Service Visual Art Teachers' Perceptions of Assessment in Online Learning." *Australian Journal of Teacher Education* 39, no. 9 (January 1, 2014). <https://doi.org/10.14221/ajte.2014v39n9.1>.
- Chang, Yunjeong, and Peggy Brickman. "When Group Work Doesn't Work: Insights from Students." *CBE- Life Sciences Education* 17, no. 3 (September 1, 2018): ar52. <https://doi.org/10.1187/cbe.17-09-0199>.
- Chapman, Kenneth R., Matthew L. Meuter, Daniel Toy, and Lauren A. Wright. "Are Student Groups Dysfunctional?" *Journal of Marketing Education* 32, no. 1 (April 1, 2010): 39–49. <https://doi.org/10.1177/0273475309335575>.
- Chapman, Kenneth R., and Stuart Van Auken. "Creating Positive Group Project Experiences: An Examination of the Role of the Instructor on Students' Perceptions of Group Projects." *Journal of Marketing Education* 23, no. 2 (August 1, 2001): 117–27. <https://doi.org/10.1177/0273475301232005>.
- Cuff, Dana. *Architecture: The Story of Practice*. MIT Press, 1992.
- Davidson, Neil, and Claire Howell Major. "Boundary Crossings: Cooperative Learning, Collaborative Learning, and Problem-Based Learning." *Journal on Excellence in College Teaching* 25 (January 1, 2014): 7–55. <http://northweststate.edu/wp-content/uploads/files/BoundaryCrossings.pdf>.
- Davis, Meredith. *Teaching Design: A Guide to Curriculum and Pedagogy for College Design Faculty and Teachers Who Use Design in Their Classrooms*. Simon and Schuster, 2017.
- De La Harpe, Barbara, and Fiona Peterson. "Through the Learning and Teaching Looking Glass: What Do Academics in Art, Design and Architecture Publish about Most?" *Art, Design & Communication in Higher Education* 7, no. 3 (March 1, 2009): 135–54. https://doi.org/10.1386/adch.7.3.135_1.

- Goodsell, Anne, Michelle Maher, and Vincent Tinto. *Collaborative Learning: A Sourcebook for Higher Education*, 1992.
- Hutchings, Pat, and Lee P. Shulman. "The Scholarship of Teaching: New Elaborations, New Developments." *Change: The Magazine of Higher Learning* 31, no. 5 (September 1, 1999): 10–15. <https://doi.org/10.1080/00091389909604218>.
- Kilgo, Cindy Ann, Jessica K. Ezell Sheets, and Ernest T. Pascarella. "The Link between High-Impact Practices and Student Learning: Some Longitudinal Evidence." *Higher Education* 69, no. 4 (April 1, 2015): 509–25. <https://doi.org/10.1007/s10734-014-9788-z>.
- Kuh, George D., Jillian Kinzie, John H. Schuh, and Elizabeth J. Whitt. *Student Success in College: Creating Conditions That Matter*. John Wiley & Sons, 2011.
- LAAB, Landscape Architecture Accreditation Board. *Accreditation Standards For Professional Programs in Landscape Architecture*. https://www.asla.org/uploadedFiles/LAAB_ACCREDITATION_STANDARDS_SEPTMBER2021.pdf
- NAAB, National Architectural Accreditation Board. *Conditions For Accreditation 2020 Edition*. <https://www.naab.org/wp-content/uploads/2020-NAAB-Conditions-for-Accreditation.pdf>
- OECD, *OECD Skills Outlook 2017: Skills and Global Value Chains*. Paris: OECD Publishing, 2017. <http://dx.doi.org/10.1787/9789264273351-en>
- Panitz, Tobias, and Patricia Panitz. "Encouraging the Use of Collaborative Learning in Higher Education." *University Teaching: International Perspectives*, October 10, 2018, 161-201. <https://doi.org/10.4324/9780429459092-7>.
- "PISA 2015 Assessment and Analytical Framework." *Programme for International Student Assessment*, August 31, 2017. <https://doi.org/10.1787/9789264281820-en>.
- Pressman, Andrew. *Designing Relationships: The Art of Collaboration in Architecture*. Routledge, 2014.
- Schön, Donald A. "The Architectural Studio as an Exemplar of Education for Reflection-in-Action." *Journal of Architectural Education* 38, no. 1 (January 23, 1984): 2–9. <https://doi.org/10.1080/10464883.1984.10758345>.
- Shulman, Lee P. "Signature Pedagogies in the Professions." *Daedalus* 134, no. 3 (June 1, 2005): 52–59. <https://doi.org/10.1162/0011526054622015>.

ENDNOTES

¹ When this group of entries was reviewed very few papers demonstrated empirical research. The publications with empirical methods included several from the construction engineering discipline and collaborative learning associated with Building Information Modeling technology. One researcher noted that current educational approaches are not designed to develop team-building skills as students are often trained to compete against each other.

ARCC 2023 POSTERS
ABSTRACTS

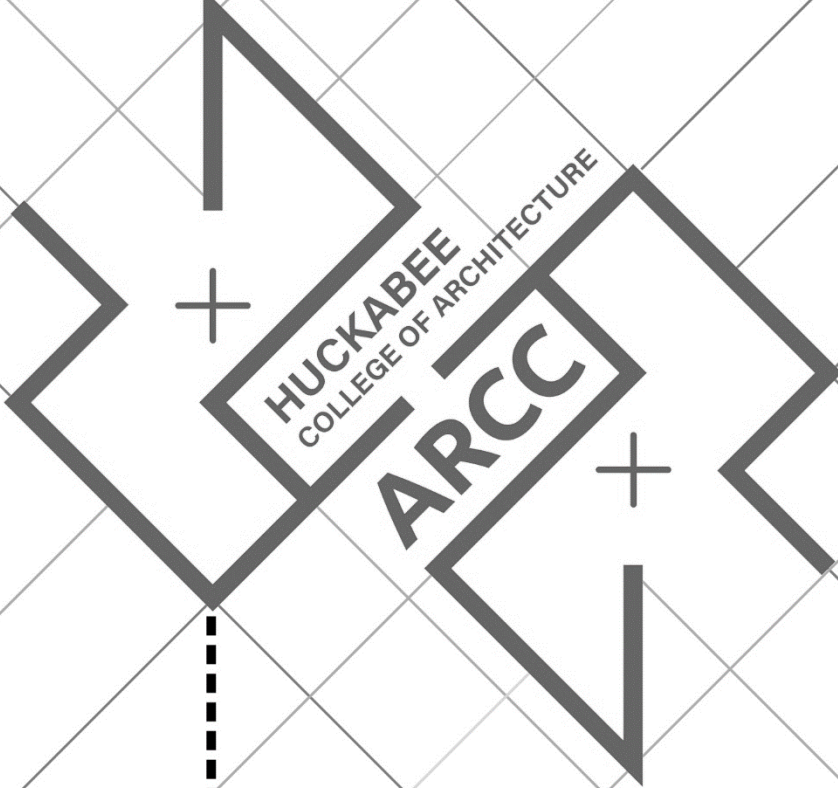

Adding Value by Design to Wind Turbine Blades and Solar Panels: A Literature Review

Burcu Salgin^{1,2}, Ahmed K. Ali², Astrid Layton², Patricia Kio³

¹Erciyes University, Türkiye

²Texas A&M University, United States of America

³Fitchburg State University, United States of America

In order to eliminate the negative effects of wastes that have the potential to occur in every production or consumption chain, they must be managed with appropriate action steps. Among the waste management principles, reduce, reuse, recycle steps, known as 3Rs, have diversified up to 12Rs in the transition period of countries to circular economy. CE strategies include 12Rs: refuse, rethink, reduce, re-design, reuse, repair, refurbish, renovate, remanufacture, repurpose, recycle and recover. Literature suggests that although recycling and energy recovery are the most common CE strategies, reuse and repurpose results in the highest economic and environmental benefits.

Within the scope of this study, wind turbine blades (WTBs) and solar panels (SPs) were examined in terms of waste management approaches. Since a sustainable waste management has not yet been demonstrated for WTB and SP at the end of their life, the wastes are managed by landfilling (burying).

Studies have shown that, considering that the renewable energy sector is growing rapidly due to climate crisis and consumption of finite resources, the volume of the waste will be remarkable in the near future. To solve the increasing waste problem, current studies are focusing on mostly recycling. However, there are difficulties in recycling and current recycling technologies do not yet offer industrial solutions.

A limited number of studies have been found on repurposing, which is the step before recycling in the waste management hierarchy. When the studies related to repurposing are examined, it is thought that there was no balance and no scalable solution to tie the waste supply and new product demand. In addition, a holistic and systematic design approach is needed for repurposing process. For this reason, it is considered important to construct future studies on developing design methodology for repurposing process.

An Overview Understanding of User Experience in a Neuroscience Outpatient Facility

Zeekra Baset Nadi¹

¹Kent State University, United States of America

Objective

The purpose of the study is to determine how environmental design and design strategies might support adult patients' well-being, satisfaction, and stress levels in the neuro-specialized facility.

Background

Neurocognitive conditions such as stroke, traumatic brain injury, spinal cord injury, and behavioral issues affect millions of people annually in the US. While the usual hospital setting typically charges a high cost for healthcare services, many look for more efficient treatment options in an outpatient setting. The healthcare environment has a substantial influence on the neuro-cognitive patient, but research on specific facility designs or user experience is scarce.

Methods

An online Qualtrics survey has been conducted through social media posting, emails, and snowball sampling. Eligible participants were adults who reside in the United States, who visited neuro-specialized facilities, or who were family members of a neurocognitive patient. 25 respondents participated from 16 different states.

Results

People's perceptions of waiting times are significantly influenced by the waiting area's design elements. The majority of respondents said that having a therapy garden would help them to decompress before and after the visit. Wayfinding to the parking lot, the entrance, the exit, and registration are critical for patients. Most respondents choose corridors with daylight and windows which are the most effective design feature.

Conclusion

The study showed that people's perceptions of experience, stress level, and wayfinding are affected by the built environment. The study's design techniques may aid in improving user experience in an outpatient setting.

Attitudes Towards Infection Control Measures: The Role of The Physical Environment in Healthcare Settings

Zeekra Baset Nadi¹, Farimah Raisali¹, Nazli Jafari¹, Sara Bayramzadeh¹

¹Kent State University, United States of America

Objective: This study aims to understand how behavioral factors can associate with healthcare-associated infection (HAI) in healthcare settings.

Background: HAIs are a common phenomenon in healthcare environments. Each year millions of Americans suffer from various kinds of HAIs. While the physical environment of healthcare facilities can directly be held accountable for the HAIs, it can also influence people's behavior toward hand hygiene compliance. The physical environment's distribution in space influences how individuals perceive space. For instance, the location of the hand hygiene stations, visible and instructional signage, and olfactory sensations are a few common physical environment factors that aid people's behavior to be in accordance with infection control measures.

Method: A comprehensive literature review was conducted using the scientific databases – PubMed, Psych INFO, and Medline. A total of 145 relevant studies were eligible after the inclusion, while eight studies concentrated on physical environment factors that influence occupants' behavior toward hand hygiene.

Result: According to findings from the identified research papers - the location of the hand hygiene station has a significant impact on people's behavior toward hand hygiene compliance. Installing a hand hygiene station or dispenser closer to the facility's entrance encourages people to sanitize their hands. Signage design depicting proper hand hygiene activity and direction to the hand sanitization stations have shown increased hand hygiene compliance in healthcare facilities. One study suggests olfactory sense can have an impact on people's behavior. Citrus-scented aroma diffusers give off a feeling of cleanliness that may encourage people to practice regular hand hygiene.

Conclusion: While the COVID-19 pandemic has emphasized the value of hand hygiene in preventing infection, data from the literature study have revealed various physical environmental variables can affect people's attitudes toward hand hygiene. These variables could be considered while designing or renovating healthcare facilities.

Celebrating Forces of Nature: Envisioning A Floating Community

Yong Huang¹, Trevor Hibbs¹

¹Bowling Green State University, United States of America

Why do we have to resist the ever-changing forces of nature along with climate change?

The floating city is fully comprised of mobile architectural and infrastructural elements that generate an evolving state of equilibrium, creating a habitable place through constantly acting and reacting to Tropical Storms, Hurricanes, Floods, Tornadoes, Tsunamis, along with Rising Sea Level occurring around waterfronts of Florida.

Instead of countering or escaping from Forces of Nature, this man-made island takes its form from the force diagram of Hurricanes. Each mobile component of the city coordinates with every other part to absorb, transfer, store, and release energies that transform natural forces from water and air into sources for productivities and human activities of everyday life.

Tropical climate supports self-sufficiency of urban farming. Around each farming field or facility, public spaces are formed as community's living rooms or communal recreational spaces. Private residential spaces are contained by mobile capsules. Powered by sustainable energy, each capsule can either come together forming collective living or move away allowing residents to enjoy temporary individual freedom and solitude.

This floating island not only hybrids nature and machine for living, but also celebrates forces of nature as well as optimistic urbanism for a self-sufficient future community.

Critical Teaching Practice for Collaboration & Teamwork

Braasch Cathy¹, Patricia Kucker¹

¹Penn State, United States of America

Cultivating a critical teaching practice relies on a research-design interface that complements a theory-praxis model. For most design educators teaching is a design practice. This research focuses on pedagogy for collaborative learning and collaborative skills. Preparing students for contemporary design practice with effective collaborative learning and multi-disciplinary learning experiences should be central to design education. How do faculty develop new pedagogies to prepare students for contemporary design practice? What role does research play in developing effective pedagogical approaches for the collaborative skills and practices students need to engage in complex design problems?

To consider these questions, our research begins in a semi-systematic review of the literature (Snyder, 2019) to examine journal publication research advancing forms of collaborative pedagogy and learning over a decade. Our analysis of the publications focused on three themes: pedagogy and best practices for collaboration, issues of culture and conflict, and assessment practices. We found an expanding body of empirical research and theoretically informed pedagogical practices for collaboration and student learning across multiple disciplines, but very few publications from the disciplines of art and design. Our conclusions highlight outcomes for the three themes and we recommend pedagogical research from other disciplines to design educators; to incorporate research into their teaching practice, and pursue mechanisms to share findings to build critical dialogue.

Designing the Inclusive Studio Environment

Wanda Kight¹, Patricia Kucker¹, Cathy Braasch¹, Marc Miller¹, Joel Priddy¹

¹Penn State, United States of America

As student demographics change, inclusivity and belonging in the studio environment are a pressing priority. Student feelings of inclusivity are linked to increased educational outcomes and a greater willingness to accept complex and intellectual challenges.[1] Conversely, some students including black and brown students, express that they are socially and culturally isolated from the studio community and curriculum. According to research, the factors impacting student inclusivity and belonging are integral to the design of an inclusive studio and within the faculty member's purview. The design-research interface for inclusive pedagogy means faculty "must continually critique and interrogate [themselves], [their] scholarship, [their] pedagogy, and [their] curricula" in order to achieve a more inclusive learning environment.[2]

Because the studio learning environment is socially co-constructed, student and faculty perceptions of the studio's learning culture are critical feedback to improving the inclusive learning environment and studio culture. Our research employs qualitative methods and engages faculty and students in interviews. We selected a comparison of two populations because the demographics of visual art programs at Penn State are more diverse than the design student population.

Our research contributes to the limited publication on the student experience in art and design studios and draws on first-year student success and retention models and classroom inclusivity research. The outcomes of our study offer talking points about the character of studio culture for artists and designers, while also identifying successes and challenges to the inclusive community we desire. To continue this research, we will include other institutional partners to best understand unique circumstances and prevailing trends. New national partners include those art and design schools within the A2ru consortium and within the Big10 Arts administrators' group.

Dynamic Bioinspired Formwork

Mahsa Esfandiar¹, Liz Liz McCormick^{1,2}, MaryGrayson Roberts¹, Liz Cooper³, Lindsay Shields³

¹University of North Carolina at Charlotte, School of Architecture, Charlotte, NC

²North Carolina State University, College of Design, Raleigh, NC

³University of North Carolina at Charlotte, Dept. of Bioinformatics and Genomics

Nature has developed efficient and effective biological systems that have garnered significant attention from architects interested in merging design practices with natural systems. This practice, known as biomimicry, has become a focal point for researchers seeking to explore the evolutionary development of tropical plants in changing climates, particularly with regard to adaptive survival mechanisms. Most plant species possess the remarkable ability to alter observable characteristics in response to changes in the environment, even in the face of minor changes in external stimuli. As such, this project focuses on examining the specific characteristics of adapted photosynthetic pathways to determine how these adaptations might inform architectural design. This research is inspired by tropical plants and aims to investigate how the characteristics and behaviors found in plants could inform responsive building technologies for tropical climates. While many biomimetic studies use nature to inform dynamic materials, our approach focuses on informing the dynamic processes used in making materials. To achieve this, we utilize ice as the formwork and wax as the formed medium, which allows us to produce temporary formwork for various shapes and pieces in facades or construction layers. The solidification of hot wax using the energy of the ice causes the ice to transform into water, resulting in shaped pores and spaces. This bioinspired process prioritizes material sensitivity over strict adherence to order and determinacy, resulting in a geometry informed by the phase change process. Our approach intentionally allows for chance, error, unpredictability, and unexpected outcomes, as it prioritizes the process over the product. Our proposed method seeks to take advantage of the same qualities introduced in biology, with the added benefit of being cost-effective, clean, and recyclable. Although this work is in its early stages, it explores the potential for dynamic formworks in larger architectural systems.

Effectiveness of Narrative Storytelling to Convey the Significance of Historic Preservation

Modesto Melendez III¹

¹Texas Tech University, United States of America

A preliminary assessment of historic preservation in El Paso, Texas has revealed an inherent need to illuminate the significance of preservation to stakeholders and homeowners alike. A general lack of knowledge and, ultimately, interest in preserving and following guidelines established by the local municipality has created a loss of historical assets over the years. Although an interest in historic preservation has shown to be on the rise within the last few years, the progress has become stagnant due to lack of knowledge of the significant historic resources that exist in El Paso. This thesis aims to produce an adaptable formula for abridging educational material in the subject of historic preservation concepts and practices through narrative storytelling. This study will focus on the analysis of using said storytelling as a teaching tool and development of an effective delivery method to teach property owners of historic homes the basics of not only maintaining a historic property, but the importance of preservation overall.

Historic Preservation in the United States of America has evolved over the years becoming a more technical field as architectural practices and code requirements have improved. The everyday layman may not know the difference between an Ionic column as opposed to a Corinthian column and research can be time consuming. Today's busy lifestyle has created a hustle and bustle attitude in which there is minimal time to be appropriated for researching something as broad and technical as historic preservation which may not be in the average person's bailiwick. With this in mind, the emphasis will be on condensing long-form content into manageable short-form content to reduce the overwhelming nature of technical data and maintain attention.

Engagement Stations, Design-build Pedagogy for Social Justice

Susan Melsop¹, Jo VandenBurg²

¹The Ohio State University, United States of America
²University of Colorado, Denver

What if architecture students identify social injustices and seek to create social change through a design-build project? This initial research presents a 4-week pedagogical experiment of a community-engaged design-build course in the context of loss, displacement, and urban renewal on a college campus. Specifically, it highlights the cultural and political value of design-build projects as vehicles for critical pedagogy, design activism, and social justice.

Providing students opportunities for direct experience with community members fosters critical consciousness and cultivates a reflective practice of their roles and responsibilities as designers of the built environment. Expanding the socio-cultural-political practice of architecture education encourages and better prepares students to be agents of change.

This poster presents the ambition of twelve students to construct an instrument for justice: to engage diverse communities in difficult topics, including racial injustice, displacement, and histories of cultural removal. This type of pedagogy—one that advocates for social justice and human dignity—belongs in the scholarly continuum of Design Justice. The pedagogical purpose of the course was twofold: 1) to provide students an opportunity to creatively design and build a project at full scale and, 2) to demonstrate how an interactive tool can engage people on difficult topics, stimulate constructive conversations, and inspire collective imagination for the future.

Following intensive research about the history of place, displacement, and campus development, students designed and constructed mobile interactive “wagons”. As participatory action research (PAR) tools, the Engagement Stations serve as mobile pop-up wagons—vehicles for social justice as they encourage public participation on histories and current conditions of displacement and urban renewal.

The purpose is to stimulate dialogue about difficult topics, develop empathy through shared stories, and foster an exchange of ideas with an open mind, open heart, and a will to work toward a collective vision.

Envisioning Adaptation to Sea Level Rise in Waikiki, HI

Wendy Meguro¹, Charles Fletcher², Josephine Briones¹, Ireland Castillo¹

¹University of Hawai'i at Mānoa, Environmental Research & Design Laboratory
²University of Hawai'i at Mānoa, Climate Resilience Collaborative, SOEST

ABSTRACT: This design research aims to visualize in-place adaptation strategies to address future sea level rise for the coastal, urban context of Waikīkī, Hawai'i throughout the 21st century. The process merges architectural design with climate science to create conceptual visual architectural and urban renderings. In line with the conference theme of planning, policy and resilience, the design research demonstrates how buildings, open spaces, transportation, and utilities could be incrementally adapted to withstand the effects of climate change, including rising sea levels, more intense precipitation, and extreme temperatures.

An interdisciplinary team of faculty and students studied emerging flood resilience guides, exemplar buildings, and the latest sea level rise science. The team identified the physical flood adaptation strategies with conceptual relevance for Waikīkī and solicited feedback on their relevance and feasibility from over 200 diverse, locally-based stakeholders. The feedback was compiled into an online report and used to inform the strategies selected for renderings. The team created two site-specific urban and architectural renderings illustrating application of the flood adaptation strategies with about 2 feet and 7 feet of sea level rise. The two sites represent prototypical high-rise and low-rise residential buildings in Waikīkī and are projected to experience flooding in the below-grade parking, at-grade occupied floors, and street.

By calculating future water levels and referencing other cities' guidelines, the team proposed standards for SLR-adjusted design flood elevations (DFEs) for Waikīkī, that have yet to be defined by the State. The goal is for these renderings to compel discussion, contribute to design guides, pilot projects, and new policies that prepare for future flooding.

Implementing Happy City Design For A Better Quality Of Life

Mariah Zeien¹, Bakr Mourad Aly Ahmed¹

¹North Dakota State University, United States of America

The aim of this research is to break down the concept of happy cities into manageable and attainable goals. Happy cities provide ideas that city planners can implement into new or existing cities. The ideals of a happy city focus on the overall happiness and betterment of the community and can positively affect the entire city environment. Happy cities aim to create a safe, welcoming, and inclusive community for those who live within.

By studying historic and current examples of happy cities, the concepts of Charles Montgomery can be compared to create a list of ideals. By viewing how existing happy cities were created and what led to their improvement, the concept was broken down into key ideas. By providing smaller goals, the implementation of happy city ideas becomes easier for any community.

This research has broken down happy cities into 4 key ideas: walkability, accessibility, affordability, and feasibility. Within these ideas are found topics such as transportation, cost, community needs, green spaces, etc. Not all ideas are required for a happy city, but a combination of what works for a specific community can help to move towards being a happier city. The ideas represented could be applied at any scale to existing cities, starting small with one neighborhood and expanding to an entire city.

Walkability within a community provides what people need inside of an eighth of a mile radius, which makes shopping and amenities readily available. Accessibility pertains to both ADA and the necessities for the community within a reasonable distance. Affordability for housing and daily needs must also be met within a reasonable distance by providing living accommodations at a range of costs which allows for all to exist in the community. Feasibility must be considered not only for city planning but also cost of living.

Japanese Joinery + Computer Numerical Control

Lucas Theodore Murray¹

¹Mississippi State University, Starkville, MS, United States of America

ABSTRACT: Traditional craft and advanced fabrication should not be at odds. It is without question that they are on opposite ends of the spectrum, but why is it that one cannot inform the other? The objective of this research was to identify the critical differences and synergies between the fabrication methods of traditional Japanese joinery and computer numerical control in order to transpose the two — an effort yielding a form of Japanese joinery more aptly suited to the technology of today. The methodologies employed to do so challenge the efficacy of both disciplines to ensure a rigorous output. The histories of both disciplines were researched to identify key differences and similarities, presenting a unique opportunity to leverage the parameters of the CNC router to explore more complex geometries not feasible with hand tools. CNC routers commonly use circular bits to carve material, limiting the geometry of interior corners to filleted edges. To begin, common Japanese joints were routed to establish and fine tune an iterative process. Next, the curved geometry was used in both the X and Y axes at a larger scale to leverage the capabilities of the CNC router and generate novel joints. Finally, a puzzle cube was fabricated to test the rigor of the research. The cube required members to be routed on multiple planes and to interlock within a system of 26 pieces. The research presented here lends validity to the process of “research by design”, by transposing two seemingly incompatible fabrication methods, the results of which expose novel design opportunities for modern joinery.

The Power Of Architecture Renderings to Legitimize Design

Natalie Bobbi Florence¹

¹Arizona State University, United States of America

Homelessness has been on the rise in the United States given widespread struggles with housing affordability and protracted issues related to COVID 19. Homelessness is often framed as a public policy issue with little attention to the range of building professionals and their expertise as it comes to shape the limits and potential of shelter. The experiences of living in emergency shelters are emotionally and physically complex, they are deeply embodied. Architects are trained to be masters of aesthetics and performance-based analytics, but not of the ways that these material selections are embedded with social values, missing a crucial link between how the worldviews and biases of designers have impact on the lived experiences of clients experiencing homelessness. There is a gap in architecture education and training when it comes to explicitly understanding the role of architects and architectural presentations in this complex social issue, in respect to designer's positionality and to the power of the architecture rendering. To address this gap, this project proposes to further investigate how design expertise and power is created and maintained. I focus on a collaborative redesign that I was a part of within the Human Services Campus, or the HSC, a 600-bed homeless shelter in Phoenix, Arizona. To accomplish this, I will code transcripts using Grounded Theory of our design meetings and meetings held with the administration during the schematic design phase of this project. In addition to coding these transcripts, I will use multimodal discourse analysis to code our presentation renderings with the goal of identifying our values and priorities as designers and how these compare to the values and priorities expressed by the administration at the HSC., with the overall goal of improving reflexivity and awareness of our agency as designers in social justice work.

Timber Nest

Yong Huang¹, John Kent¹, Jack Collins¹, Christopher Fletcher¹

¹Bowling Green State University, United States of America

Mass timber construction has been emerging as an ecological, sustainable, and cost-effective approach for social housing. However, the current built projects tend to be limited to a singular structural system, hindering diversity and richness of communal urbanism. The Timber Nest is a research-based design exercise to explore a wide range of mass timber structural systems that support diversified building programs and hybrid building types to envision the construction of a vibrant mixed-use residential community.

To challenge timber structural systems in dealing with density and complexity of urban condition, theoretically, we selected a site that allows the building to interface with both a metro line and a bus station in downtown Atlanta. By overlaying a timber building complex onto the transit hubs, the design celebrates dynamic urbanism of the city.

Six timber structural prototypes were developed in residential, commercial, and public areas to address the demands of a mixed-use building complex. The tall structures utilize modular timber construction systems to allow the building to grow for future expansion.

Urban Corridor, hovering over both the train and bus stations, provides recreational and marketplaces not only for the community above, but also the neighborhood beyond. Community Corridor mediates between the residential tower above and the urban public space below, with communal amenities arranged throughout the entire floor. Both join as one long-span bridge structural system, extending to the east bend to connect Office Tower along the main commercial street. By integrating a central rigid-core of CLT and concrete composite shear wall system with the peripheral GLT rigid post-beam framing system, Office Tower provides column-free spaces to maximize flexibility of office layout.

The Timber Nest, rooted in a transit hub, transforms a complex transportation site into adaptive homes for the collective as well as a sustainable model for the city.

Toward Blue Cities: Build On Water, Futuristic Sustainable Ubranism

Bakr Mourad Aly Ahmed¹, Mitchell Osland¹

¹North Dakota State University, United States of America

A hundred years into the future, humanity and the world will experience dramatic changes. As climate change begins to alter our global environments, humanity must adapt to the changes it brings. The overall increase in global temperatures is melting the polar ice caps and glaciers causing our sea levels to rise dramatically putting over 40% of the world population at risk of flooding impacts or being submerged under the sea by the year 2100. As dry land becomes more scarce and human populations of the world continue to increase, the need for more buildable surfaces increases. a new solution is needed to house and supply the masses, to begin to utilize the 71% (and growing) portion of the Earth's surface, the oceans. Which provide mankind with nitrogen-rich oxygen, sea food, transportation, and perhaps one day, a place to call home. This thesis explores potential solutions to large population density structure and urban societies on the seas. Exploration of design and architecture adapting to the lasting effects of rising sea levels due to global climate change. A replicable and practical project that meets humanities needs while providing the necessary character and biology of a city will be needed in the future. This research explores the various issues with oceanic structures and subaqueous life in the new cities of the future.

ARCC 2023 CONFERENCE PROCEEDINGS, APRIL 12-15, 2023
THE RESEARCH DESIGN INTERFACE

CONFERENCE CO-CHAIRS:
Saif Haq and Zahra Safaverdi

EDITORS:
Saif Haq and Adil Sharag-Eldin
EDITORIAL ASSISTANT:
Sepideh Niknia

PUBLISHER: Architectural Research Centers Consortium, Inc.
ISBN: 978-1-935129-33-2