

## The Machine Speaks Falsely

**Author(s):** Allan Franklin

**Source:** *Spontaneous Generations: A Journal for the History and Philosophy of Science*, Vol. 4, No. 1 (2010) 71-84.

**Published by:** The University of Toronto

**DOI:** [10.4245/sponge.v4i1.11333](https://doi.org/10.4245/sponge.v4i1.11333)

### EDITORIAL OFFICES

Institute for the History and Philosophy of Science and Technology  
Room 316 Victoria College, 91 Charles Street West  
Toronto, Ontario, Canada M5S 1K7  
[hpsat.society@utoronto.ca](mailto:hpsat.society@utoronto.ca)

Published online at [jps.library.utoronto.ca/index.php/SpontaneousGenerations](https://jps.library.utoronto.ca/index.php/SpontaneousGenerations)  
ISSN 1913 0465

Founded in 2006, *Spontaneous Generations* is an online academic journal published by graduate students at the Institute for the History and Philosophy of Science and Technology, University of Toronto. There is no subscription or membership fee. *Spontaneous Generations* provides immediate open access to its content on the principle that making research freely available to the public supports a greater global exchange of knowledge.

## The Machine Speaks Falsely\*

Allan Franklin<sup>†</sup>

---

How can one determine if an experimental apparatus is giving an incorrect result, if it is speaking falsely? An interesting example of this occurred in the experimental investigation, in the early twentieth century, of the energy spectrum of electrons emitted in  $\beta$  decay. Meitner and her collaborators (1911), using photographic detection, found that all the electrons emitted by a single radioactive element were monoenergetic. Chadwick (1914), on the other hand, using either an ionization chamber or a Geiger counter, found a continuous energy spectrum. Meitner et al. proposed various mechanisms whereby initially monoenergetic electrons might lose energy. These were shown to be unsatisfactory, although the possibility of an unknown mechanism for energy loss remained. In 1927 Ellis and Wooster, using a total-absorption calorimeter, which eliminated all of these possibilities, demonstrated that the energy spectrum was indeed continuous. It had taken fifteen years to show that the photographic detection had spoken falsely.

---

In the late nineteenth century Etienne-Jules Marey (1895), a French physiologist and photographer, used a technique called chronophotography, multiple exposures using a single camera,<sup>1</sup> to obtain sequential photographs of humans, birds, and horses in motion (Figure 1).<sup>2</sup> Marey also used a technique in which a subject clothed in a black suit with white lines painted along the limbs, the *homme squelette*, or skeleton man, was photographed in front of a black screen.<sup>3</sup> This was an attempt to further reveal the essentials of motion which were unobserved even in the sequential photograph of the man (Figure 1, lower

\* Received 15 January 2010.

<sup>†</sup> Allan Franklin is Professor of Physics at the University of Colorado. He works on the history and philosophy of science, particularly on experiment in physics during the 20th century. His current research is an investigation of changes in the reports of experimental results from 1893, the first publication of *Physical Review*, to the present.

<sup>1</sup> Marey produced a sequence of images using a moving photographic plate and also by using a moving film. He is regarded as one of the pioneers of motion pictures.

<sup>2</sup> Eadweard Muybridge obtained similar photographs using arrays of single-exposure cameras. Marcel Duchamp was aware of the work of both Marey and Muybridge and their influence is clearly seen in his painting *Nude Descending a Staircase*.

<sup>3</sup> Marey also used similar photographs of a single point on a body to illustrate motion. Similar techniques are used today in constructing computer graphics images in movies.

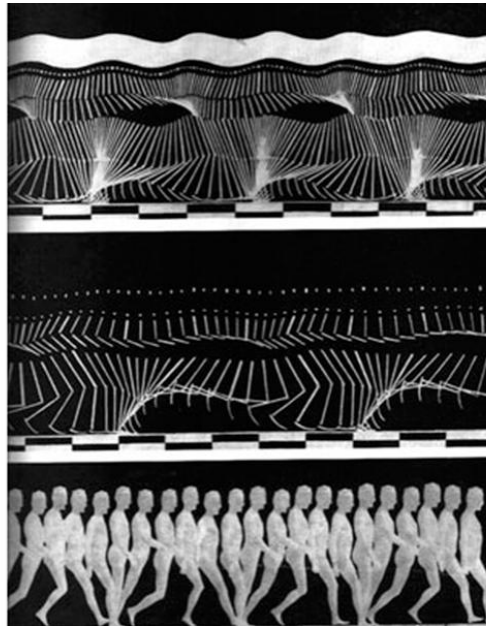

**Figure 1.** Étienne-Jules Marey, *Étude chronophotographique de la locomotion humaine* (1886), Marey Animations, [www.understandingduchamp.com/author/marey/index.html](http://www.understandingduchamp.com/author/marey/index.html).

panel). As Joel Snyder (1998) and Josh Ellenbogen (2008) have pointed out, Marey's photographs were making observable what had previously been unobservable, particularly with the human eye. These photographs were not, however, uncontroversial. The French artist Jean Louis Ernest Meissonier declared that the "machine speaks falsely."<sup>4</sup>

In his 1895 book, Marey did not discuss any difficulties with either the exposure or the developing of the photographs. Presumably the fact that the image was visible was sufficient for his purposes. The question of the development of photographs would, however, be an issue in the episode discussed below: the investigation of the energy spectrum of electrons emitted in  $\beta$  decay.

An argument for the credibility of these photographs was, however, given by Francis Galton, who privileged human vision. If the eye could confirm the photographs of Marey and Muybridge then they were credible. "The wonderful photograph by Muybridge of the horse in motion and those by Marey [sic] of the bird on the wing induced me to attempt the construction of apparatus by which the *unassisted eye could verify their results* and catch other transient phases of rapid gesture" (1882, 246,

<sup>4</sup> I am grateful to Josh Ellenbogen for pointing this out. Meissonier was actually quite careful in his choice of words. It would have been inappropriate to say the "machine lies" because that would have implied that the machine has intention.

emphasis added). Galton constructed a device with a movable shutter and prisms which, by making use of the persistence of human vision, could simultaneously display two images of an object obtained close in time. Galton succeeded in his attempt to verify the photographs. "Its execution has proved unexpectedly easy, and the result is that even the rudest of the instruments I have used is sufficient for the former purpose: it will even show the wheel of a bicycle at full speed as a well-defined and stationary object" (1882, 246).

How does one establish that an experimental apparatus, or instrument, is speaking correctly or falsely? In my own previous work I have outlined an epistemology of experiment, a set of strategies that scientists use to argue for the correctness of their experimental results. These strategies include: 1) intervention, in which the experimenter manipulates the object under observation; 2) independent confirmation, in which the same object is observed with different experimental apparatuses;<sup>5</sup> 3) experimental checks and calibration, in which the experimental apparatus reproduces known phenomena; 4) reproducing artifacts that are known in advance to be present; 5) elimination of plausible sources of error and alternative explanations of the result (the Sherlock Holmes strategy);<sup>6</sup> 6) using the results themselves to argue for their validity; 7) using an independently well-corroborated theory of the phenomena to explain the results; 8) using an apparatus based on a well-corroborated theory; 9) using statistical arguments; 10) using "blind analysis," a strategy for avoiding possible experimenter bias (For a more detailed discussion see Franklin 2007, 220-25).

Several of these strategies apply to instruments and it seems fairly clear that if an experimental apparatus fails one of these tests it is unreliable. A spectrometer that cannot reproduce the known Balmer series in hydrogen would not be regarded as a working spectrometer. There are, however, episodes in which this conceptually simple method of establishing that the "machine speaks falsely" is not easily applicable, even in principle.

Consider the case of the investigation, in the early years of the twentieth century, of the energy spectrum of the electrons emitted in  $\beta$  decay. In this episode we find early results obtained with three different instruments. Two of them, the ionization chamber and the Geiger counter, agreed with one another, whereas the third method, photographic

<sup>5</sup> These first two strategies were first suggested by Hacking (1983).

<sup>6</sup> As Holmes remarked to Watson, "How often have I said to you that when you have eliminated the impossible whatever remains, *however improbable*, must be the truth" (Conan Doyle 1967).

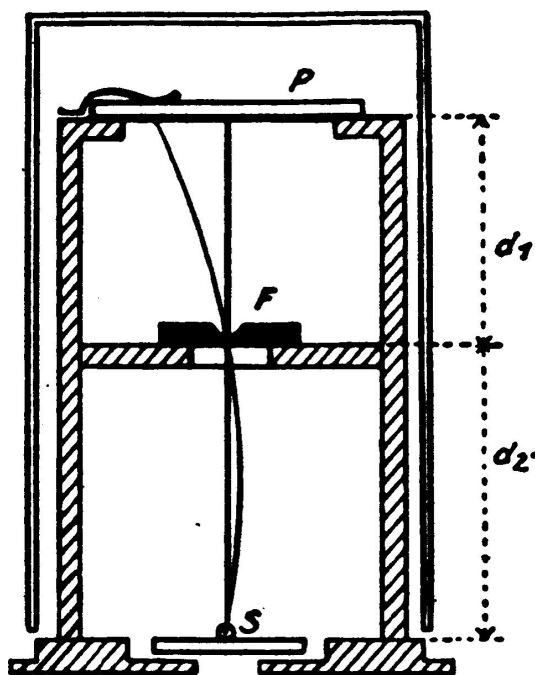

**Figure 2.** The experimental apparatus used by Hahn, Meitner, and von Baeyer (Hahn 1966, 55).

detection, disagreed. The question of how these discordant results were resolved involved yet a fourth kind of detector, a total-absorption calorimeter. The crucial question was which instrument was speaking falsely.

In the early twentieth century Lise Meitner, Otto Hahn, and Otto von Baeyer (1911), along with others, investigated the energy spectrum of electrons emitted in  $\beta$  decay using the apparatus shown in Figure 2.

Electrons emitted from the radioactive source S were bent in a magnetic field, and made to pass through a small slot F, before they struck a photographic plate P. Electrons of the same energy would follow the same path and produce a single line on the photographic plate. The results showed a line spectrum and seemed to support the view that there was one group of monoenergetic electrons emitted by each radioactive element. The best photograph obtained with a thorium source showed two strong lines, corresponding, the experimenters believed, to the  $\beta$  rays from the two radioactive substances present (Figure 3) (von Baeyer 1911).

Hahn and Meitner proposed a simple hypothesis: a radioactive element emitted  $\beta$  rays, each with the same energy, which differed for different elements. There were, however, problems. The photographs showed, in addition, some weak lines that were difficult to explain on a one energy line-one element view. The experimenters wrote, however, “The present

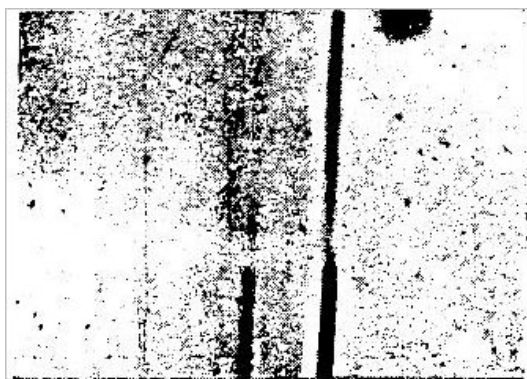

**Figure 3.** The first line spectrum for  $\beta$  decay published by Meitner, Hahn, and von Baeyer. The two lines were thought to be produced by the two radioactive elements present in the source (von Baeyer 1911).

investigation shows that, in the decay of radioactive substances, not only  $\alpha$ -rays but also  $\beta$ -rays leave the radioactive atom with a velocity characteristic for the species in question. This lends new support to the hypothesis of Hahn and Meitner..." (von Baeyer, Hahn et al. 1911). Further improvements to the experimental apparatus and to the quality of the photographs showed multiple lines, making it difficult to maintain the Hahn-Meitner suggestion. Similar results were obtained by other experimenters.<sup>7</sup>

In 1914, however, James Chadwick, who was working in Berlin with Hans Geiger, wrote to Ernest Rutherford, "We [Geiger and Chadwick] wanted to count the  $\beta$ -particles in the various spectrum lines of RaB + C<sup>8</sup> and then to do the scattering of the strongest swift groups. I get photographs very quickly easily [*sic*], but with the counter I can't even find the ghost of a line. There is probably a silly mistake somewhere" (J. Chadwick to Rutherford, 14 June 1914, Cambridge University Library). Chadwick noted, however, that the intensity of the lines on the photographic plate could be altered by changes in the development process of the photographic plates. Using a very slow development process he obtained a nearly black line against a clear background. He also remarked that the photographic effects of electrons with different velocities had not yet been determined.

Chadwick (1914) continued his experiment, using the apparatus shown in Figure 4.

<sup>7</sup> For details of this complex history and references see Franklin 2001, Chapter 1.

<sup>8</sup> The decay products of various elements were sometimes named with a letter or with a numerical suffix, and were later shown to be isotopes of other elements. This radium B was an isotope of lead, <sup>214</sup>Pb; radium C was bismuth, <sup>214</sup>Bi; and radium E was <sup>210</sup>Pb.

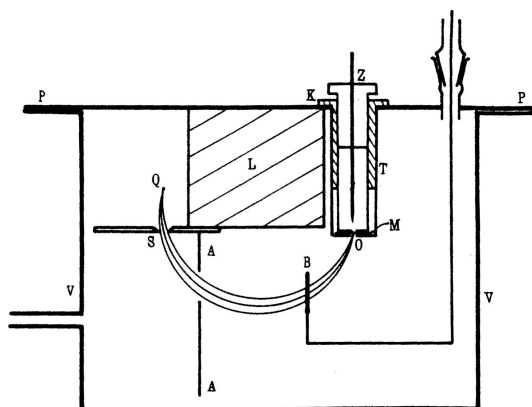

**Figure 4.** Chadwick's experimental apparatus. Electrons are emitted from the radioactive source at Q and detected by the Geiger counter (ionization chamber) at O. From Chadwick (1914, 384).

This was similar to that used by Meitner et al., but he used either an ionization chamber or one of Geiger's new counters as the detector, rather than a photographic plate. Chadwick obtained similar results with both of his detectors (Figure 5). (Notice the use of different types of detector to provide independent confirmation of the result.)<sup>9</sup> There was clearly a problem. The photographic detectors of Meitner et al. showed a line spectrum, whereas both the ionization chamber and the Geiger counter showed a continuous energy spectrum, with a few lines superposed on it. Which detector (or experimental apparatus) was speaking falsely?

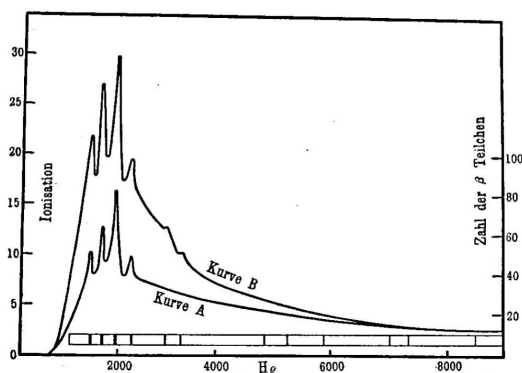

**Figure 5.** Chadwick's results for the number of  $\beta$  rays as a function of energy. A few discrete lines are seen above a continuous energy spectrum (Curve A, Geiger counter; Curve B, ionization chamber). From Chadwick (1914, 389).

<sup>9</sup> For a Bayesian discussion of why "different" experiments provide more support for a hypothesis or an experimental result than replications of the "same" experiment see Franklin and Howson (1984).

Chadwick's result was not immediately accepted by the physics community. Meitner (1922a; 1922b) suggested that the monoenergetic decay electrons might have lost energy in scattering from atomic electrons, which made the lines more diffuse. She also commented that Chadwick's experimental apparatus had insufficient energy resolution to resolve these more diffuse lines, which gave rise to his observed continuous energy spectrum. She further noted that Chadwick's result had not been replicated.

Chadwick and Ellis answered the second objection. They performed an experiment using an experimental apparatus that "was identical in principal with that of Chadwick [1914]," (1922, 275) this time using only an ionization chamber as a detector.<sup>10</sup> The radioactive source was a brass plate made radioactive by exposure to radium emanation (radon). Their results (Figure 6) confirmed those obtained earlier by Chadwick.<sup>11</sup>

Chadwick and Ellis discussed three possible explanations of their latest result.

There would appear to be only three ways in which the continuous energy spectrum could arise in the source. It might be supposed to consist of electrons ejected from the material by  $\gamma$ -rays; or it might consist of electrons which originally formed part of homogeneous groups, but which had been rendered heterogeneous by being scattered back from the brass plate; or, lastly, the continuous spectrum might be emitted by the radioactive atoms. The first possibility is ruled out at once by the magnitude of the effect. (Chadwick and Ellis 1922, 278)

They added "two strong arguments which appear to us to decide against the second possibility" (1922, 278). The first was that their results agreed "fairly well" with Chadwick's initial measurement, an example of independent confirmation. The second argument was provided by an experiment in which the brass plate source was replaced by a radioactive source placed on the underside of a thin sheet of silver, an example of intervention. This eliminated the possibility of energy loss by electron scattering. They remarked that the continuous energy spectrum was

<sup>10</sup>One may speculate that because the earlier experiment, using both an ionization chamber and a Geiger counter, gave similar results, the experimenter did not feel the need to use two different detectors. Chadwick and Ellis (1922) make no comment on this.

<sup>11</sup>The experimenters remarked that the results had been corrected for both stray electrons and any  $\gamma$  rays also emitted by the radioactive source. They further noted that two different theories of  $\beta$  decay had been proposed to explain these different results: those of Smekal (1922) and Ellis, C. D. (1922).



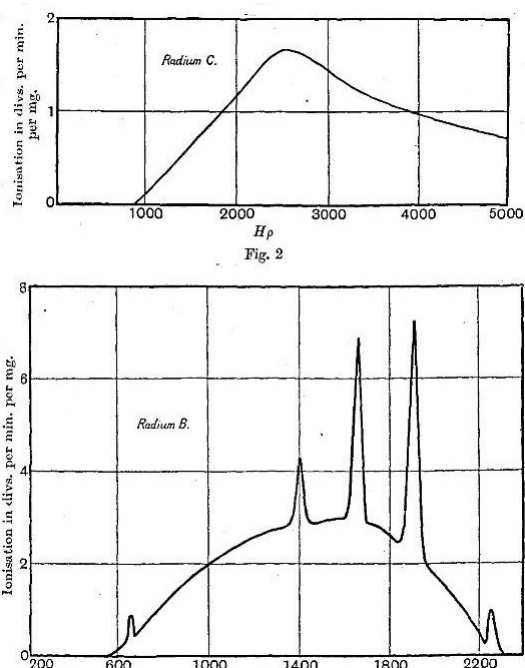

**Figure 6.** The results obtained by Chadwick and Ellis (1922) for Radium B and Radium C.

reduced by twenty percent “which means that only 20 per cent of the continuous spectrum can be accounted for by scattering from the brass plate” (1922, 279). They further noted that the ratio of the peaks to the continuous background was the same in both the silver-sheet and previous experiments. “Now it is obvious that if the real emission consists only of homogeneous groups and the continuous spectrum observed under ordinary conditions is due to scattering from these lines, then in an experiment where there can be little back scattering the homogeneous groups should be greatly increased in magnitude relative to the background. As has been stated, this effect, was not observed” (1922, 279).

Having eliminated plausible alternative explanations of their result (the Sherlock Holmes strategy) Chadwick and Ellis concluded that “In our opinion these experiments strongly support the view that the continuous spectrum is emitted by the radioactive atoms themselves....” (1922, 279).

Meitner further argued that a quantized system such as an atomic nucleus was unlikely to emit such a continuous spectrum, citing her own previous work with Hahn and von Baeyer. Ellis and Wooster presented arguments against Meitner’s suggestion and noted that “Meitner has therefore tried the hypothesis that the continuous spectrum does not

consist of the disintegration electrons at all but is due to secondary effects” (1925, 857). They discussed several other of Meitner’s suggested mechanisms for the energy loss by the presumed initially monoenergetic electrons, including: 1) Compton scattering, or the production of recoil electrons of varying energy by the scattering of  $\gamma$  rays emitted by the nucleus from atomic electrons, 2) the emission of continuous  $\gamma$  rays by the electron as it passes through the intense electric fields of the atom after it is emitted by the nucleus, and 3) the scattering of the primary electrons from the planetary electrons of the atom.

Ellis and Wooster presented both evidence and argument against these three possibilities and rejected all three. Compton scattering was rejected because it would have resulted in an incorrect energy spectrum for radium B and also could not explain the spectrum of radium E, which did not emit any  $\gamma$  rays. The absence  $\gamma$  rays in the decay of radium E also argued against the continuous emission of  $\gamma$  rays as an explanation of the continuous spectrum. The third possibility, electron scattering, was rejected because it would result in the emission of several electrons in the  $\beta$  decay of a single nucleus and experiment had already shown that only a single electron was emitted in each decay.

Having eliminated Meitner’s plausible alternative explanations of the phenomenon, another example of the Sherlock Holmes strategy, Ellis and Wooster concluded, “We are left with the conclusion that the disintegration electron is actually emitted from the nucleus with a varying velocity” (1925, 860). They also noted that there was, in fact, a direct test of whether the primary electrons lost energy as they escaped from either the atom or from the entire source.

This is to find the heating effect of the  $\beta$ -rays from radium E. If the energy of every disintegration is the same then the heating effect should be between 0.8 and  $1.0 \times 10^6$  volts per atom.... It is at least equally likely that the heating effect will be nearer  $0.3 \times 10^6$  volts per atom, that is, will be just the mean kinetic energy of the disintegration electrons. (1925, 860)

They wrote that they were, at the time, engaged in performing this experiment.<sup>12</sup>

<sup>12</sup>One possible explanation, and one rejected by Ellis and Wooster was the possibility that energy was not conserved precisely in each  $\beta$  decay, but only conserved statistically in a number of such decays. “The next point is to consider how this inhomogeneity of velocity has been introduced. We assume that energy is conserved exactly in each disintegration, since if we were to consider the energy to be conserved only statistically there would no longer be any difficulty in the continuous spectrum. *But an explanation*

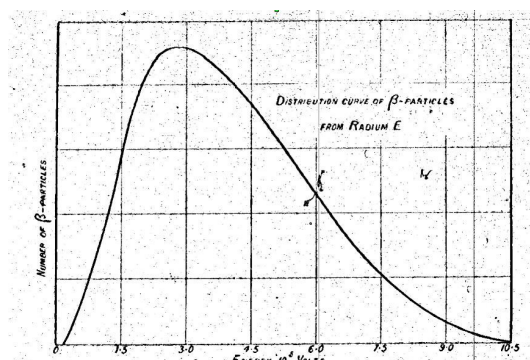

**Figure 7.** The energy spectrum obtained with an ionization chamber by Ellis and Wooster (1927).

In 1927, Ellis and Wooster firmly established that the energy spectrum of electrons emitted in  $\beta$  decay was continuous. They did this by measuring the average energy of disintegration of electrons in the  $\beta$  decay of radium E, using the heating effect produced by those electrons. If the energy spectrum really was continuous then the average energy obtained from the heating effect measurement would equal the average energy obtained by other methods, including ionization. If the energy spectrum was monoenergetic and the observed spectrum due to unknown energy losses, then the average heating energy measured should be at least as large as the maximum energy measured in the continuous spectrum. For radium E the average and maximum energies were 390,000 electron Volts (eV) and 1,050,000 eV, respectively. Although Ellis and Wooster remarked that the measurement was quite difficult, they believed that they could easily measure such a large difference.

They remarked that they had chosen radium E as their source of  $\beta$ -decay electrons because it was a radioactive source that produced no significant number of  $\gamma$  rays. Thus, the energy emitted was carried solely by the electrons. Noting that the average energy of disintegration could be obtained from the ionization measurements shown in Figure 7, they continued,

Now the average energy of disintegration can be measured by another method entirely free from any hypothesis, namely the heating effect of the  $\beta$ -rays. This is most simply done by enclosing a volume of radium E in a calorimeter whose walls are sufficiently thick to absorb completely the  $\beta$ -radiation. If

---

*of this type would only be justified when everything else had failed, and although it may be kept in mind as an ultimate possibility, we think it best to disregard it entirely at present"* (Ellis and Wooster 1925, 858, emphasis added).

the heating effect is now measured and divided by the number of atoms disintegrating per unit time, we obtain the average energy given out on disintegration. If this agrees with the value estimated from the distribution curve [Figure 7], 390,000 volts, then it is clear that the observed  $\beta$ -radiation accounts for the entire energy emission, and we deduce the corollary that the energy of disintegration varies from atom to atom. (1927, 111)

The equilibrium temperature difference between the two calorimeters, obtained when the heat supplied by the radium E source was equal to the energy lost by the lead calorimeter, after a time of about three minutes, was measured with a system of thermocouples. The temperature difference was quite small, approximately 0.001 C, and care was taken to calibrate the galvanometer that measured the current produced. "It was necessary to use a Paschen galvanometer of 12 ohms resistance, working at a sensitivity as high as 30,000 divisions per microampere, and the sensitivity was measured several times in the course of each experiment by incorporating in the reversing key an arrangement for switching in a known small standardizing current" (1927, 114).

One further difficulty of the experiment was that the decay of radium E produces polonium, which is also radioactive, emitting an  $\alpha$  particle. Thus, the energy deposited in the calorimeter was the sum of the energies from the  $\beta$  decay of radium E plus that of the  $\alpha$ -particle decay of polonium. It was absolutely crucial to determine the number of RaE disintegrations so that the average energy per disintegration could be calculated. The total absorption calorimeter precluded the counting of individual electrons, but Ellis and Wooster used the background due to the  $\alpha$  particle decay of polonium, discussed above, to determine the number of disintegrations.

A further difficulty lies in determining the number of [RaE] atoms disintegrating per second, and we obviated the necessity of knowing it by observing how the combined heat emission of the radium E and polonium varied with time. [The lifetimes of RaE and polonium were known.] From this we deduced the ratio of the mean energies liberated by the radium E and polonium and calculated the polonium energy from the energy of the  $\alpha$ -rays. We were never able to prepare a source entirely free from polonium, but this method could still be employed provided the amount of polonium initially present was found. This was done by an ordinary  $\alpha$ -ray ionisation measurement." (1927, 112)

The final result obtained by Ellis and Wooster is shown in Figure 8. The two curves show the total heating effect as a function of time as

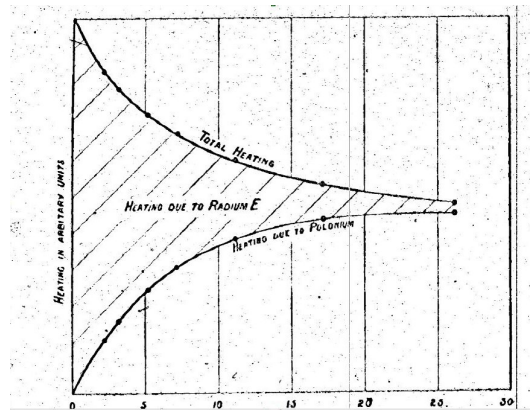

**Figure 8.** The results of Ellis and Wooster (1927, 116).

well as that due to polonium decay. The difference between them was the energy released by the decay of radium E. The average heating energy found was  $344,000 \pm 40,000$  eV, in good agreement with the average value of  $390,000 \pm 60,000$  eV obtained by the ionization measurement, and in marked disagreement with the value of more than one million volts expected for the monoenergetic energy hypothesis. These measurements were repeated with three other radium E sources of varying strength, and consistent results were found. In addition, if the experiment was producing correct measurements, the heating effect calculated for radium E should follow an exponential decay with a period of 5.1 days (See Figure 9). "... [I]t is a most important confirmation of the accuracy of our experiments that this difference [the heating effect due to radium E] shows an exponential decay with a period of about 5.1 days" (1927, 117).

The logarithm of the energy produced by radium E plotted as a function of time fits a straight line with a lifetime of 5.1 days, indicating

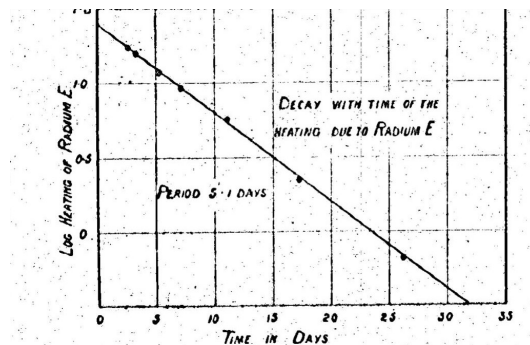

**Figure 9.** The logarithm of the heating due to Radium E as a function of time. From Ellis and Wooster (1927, 116).

an exponential decay. Ellis and Wooster concluded that, “We may safely generalise this result obtained for radium E to all  $\beta$ -ray bodies, and the long controversy about the origin of the continuous spectrum of  $\beta$ -rays appears to be settled” (1927, 121). Meitner and Orthmann repeated the heating effect experiment with an improved apparatus and obtained an average energy per  $\beta$  particle of  $337,000 \pm 20,000$  eV, (1930); this result was in excellent agreement with that measured by Ellis and Wooster. Meitner wrote to Ellis, “We have verified your results completely. It seems to me now that there can be absolutely no doubt that you were completely correct in assuming that beta radiations are primarily inhomogeneous. But I do not understand this result at all” (L. Meitner, letter to Ellis, 20 July 1929).

Why did it take so long for the physics community to recognize that the energy spectrum in  $\beta$  decay was continuous after Chadwick’s experiment had apparently demonstrated it? Why wasn’t it accepted until after the experiment of Ellis and Wooster in 1927?

Perhaps the most important reason was that Chadwick’s apparatus, as well as others at the time, measured the energy of the electron only after it had left the source, allowing for the possibility that the electron lost energy by some process in escaping from the radioactive source. Meitner proposed several possible mechanisms for that energy loss. Although the work of Chadwick, Ellis, and Wooster had provided independent confirmation of Chadwick’s initial result, argued persuasively against her proposed mechanisms, and cast doubt on the results of Meitner, Hahn and von Baeyer, the possibility of some unknown energy-loss mechanism remained. The result of Ellis and Wooster, confirmed by Meitner and Orthmann and obtained with a total absorption calorimeter, which measured both the energy of the electrons and that deposited in the source, was not subject to that criticism.<sup>13</sup>

It had taken more than 15 years to decide that the photographic plates had spoken falsely.

ALLAN FRANKLIN  
Department of Physics, UCB 390  
University of Colorado  
Boulder, CO 80309-0390  
Allan.Franklin@colorado.edu

<sup>13</sup>Interestingly, no one, at the time considered the possibility that energy might be escaping from the calorimeter. This was, in fact, the case. The very weakly interacting neutrino carried away decay energy that was not detected by the calorimeter.

## REFERENCES

- Chadwick, James. 1914. Intensitätsverteilung im magnetischen Spektrum der  $\beta$ -Strahlen von Radium B + C. *Verhandlungen der deutschen physikalischen Gesellschaft* 16: 383-91.
- Chadwick, James. and Charles D. Ellis. 1922. A Preliminary Investigation of the Intensity Distribution in the  $\beta$ -Ray Spectra of Radium B and C. *Proceedings of the Cambridge Philosophical Society* 21: 274-80.
- Conan Doyle, Arthur. 1967. *The Annotated Sherlock Holmes*. New York: Clarkson N. Potter.
- Ellenbogen, Josh. 2008. Camera and Mind. *Representations* 101(1): 86-115.
- Ellis, Charles D. 1922. The interpretation of  $\beta$ -ray and  $\gamma$ -ray spectra. *Proceedings of the Cambridge Philosophical Society* 21: 121-28.
- Ellis, Charles D. and W. A. Wooster. 1925. The  $\beta$ -ray Type of Disintegration. *Proceedings of the Cambridge Philosophical Society* 22: 849-60.
- Ellis, Charles D. and W. A. Wooster 1927. The Average Energy of Disintegration of Radium E. *Proceedings of the Royal Society (London)* A117(776): 109-23.
- Franklin, Allan. 2001. *Are There Really Neutrinos? An Evidential History*. Cambridge: Perseus Books.
- Franklin, Allan. 2007. The Role of Experiments in the Natural Sciences: Examples from Physics and Biology. In *Handbook of Philosophy of Science: General Philosophy of Science, Focal Issue*, ed. Theo A. F. Kuipers, 219-74. Amsterdam: Elsevier.
- Franklin, Allan and Colin Howson 1984. Why Do Scientists Prefer to Vary Their Experiments? *Studies in History and Philosophy of Science* 15(1): 51-62.
- Galton, Francis. 1882. A Rapid-View Instrument for Momentary Attitudes. *Nature* 26: 246-51.
- Hahn, Otto. 1966. *Otto Hahn: A Scientific Autobiography*. New York: Charles Scribner's Sons.
- Marey, Etienne Jules. 1895. *Movement*. New York: D. Appleton and Company.
- Meitner, Lise. 1922a. Über die Entstehung der  $\beta$ -Strahl-Spektren radioaktiver Substanzen. *Zeitschrift für Physik* 9(1): 131-44.
- Meitner, Lise. 1922b. Über den Zusammenhang zwischen  $\beta$ - und  $\gamma$ -Strahlen. *Zeitschrift für Physik* 9(1): 145-52.
- Smekal, Adolf. 1922. Zur quantentheoretischen Deutung der  $\beta$ - und  $\gamma$ -Strahl-Emission. *Zeitschrift für Physik* 10(1): 275-302.
- Snyder, Joel. 1998. Visualization and Visibility. In *Picturing Science, Producing Art*, eds. Caroline Jones and Peter Galison, 379-97. New York: Routledge.
- von Baeyer, Otto, Otto Hahn, et al. 1911. Über die  $\beta$ -Strahlen des aktiven Niederschlags des Thoriums. *Physikalische Zeitschrift* 12: 273-79.