

University of Warwick institutional repository: <http://go.warwick.ac.uk/wrap>

**A Thesis Submitted for the Degree of PhD at the University of Warwick**

<http://go.warwick.ac.uk/wrap/2692>

This thesis is made available online and is protected by original copyright.

Please scroll down to view the document itself.

Please refer to the repository record for this item for information to help you to cite it. Our policy information is available from the repository home page.

# **Inquiry in Question**

**In Four Volumes**

**I**

**Martin Joughin**

**Submitted for the Degree of PhD in Philosophy  
University of Warwick**

**Research carried out in the Department of  
Philosophy**

**1984**

**BEST COPY**

**AVAILABLE**

Variable print quality

**Text cut off in original**

## INQUIRY IN QUESTION: '??'

What follows is the transcript of an inquiry which takes itself as its object: an inquiry into its own inquiry.

It opens out of a mere marking of its questioning, '?', and proceeds by questioning that mark, and the progress of its inquiry as transcription of something 'open' into marks and questions - such transcription itself marked as only one thing open to the 'writer'. Each successive attempt to transcribe into words the opening transition into 'words', 'text', 'book', from some textually marked 'context' in which the transition is open, simply leads into a questioning of each such attempted transcription, the bringing of its terms 'into question'. The first section of the inquiry closes having marked out an internal 'logical' space and time of these opening questions, coordinated around the initial question of marking a question: so many 'dimensions' or lines of questioning 'question' - in particular the external 'physical' dimension of a 'space' and 'time' in which marking or transcription is (physically) open, and a 'poetic' or figural dimension in which that 'external' physical open-ness or space provides, like the 'internal' logical space of logical, physical and poetic questions, an 'image' for those three coordinate dimensions in whose textual and contextual interplay their transcription into a logical space and time of questions is open.

This interplay is then framed in a coupling of those dimensions of questioning in the poetic axis of an action or activity of inquiry organised by the question of framing a thousand or so texts of 'theory' (found as so many books in the context of this inquiry), as so many framings of the whole, or some primary dimension, of their widest 'context' from different 'points' in what they differently frame as that common, universal, context. How frame this difference, its 'space' and 'time'? A 'drama' of theory from its pythagorean inception as 'vision' of a symmetric system or Kosmos of various dimensions of the 'mark' or 'point' (σημαίον, σημειή) - at the time of inception of 'drama' and 'history' also, around '500BC' - down to a range of theoretical texts temporally situated in their contexts 'around 1970', is articulated in a 'dynamic' of inquiry in which successive books bring versions of a universal context proposed in earlier or opposed 'theories' into a questioning formulated through the identification of those other perspectives as so many limited partial views from more or less specific and questionable points in the newly mapped universal frame. The 'internal' dynamic of this book of inquiry itself, in which each such questioning of earlier theory in its turn comes into question, always finds the 'terms' in which that question is marked in some later text, which is thereby made to follow in the sequence of the inquiry's mapping of its 'historical' context as an 'external' sequence of theoretical texts, and their contexts as framed in terms drawn from those texts.

Finally, in the closing section, this figure of inquiry or history (ἱστορία) itself appears in its own 'immediate' late twentieth-century context as questioning of and response to a range of books 'around 1970' which verbally frame the inscription of language in a context it transcribes, in abstraction from the 'dramatic' question of such transcription as itself only one thing open in that context to its practitioners or writers - itself 'in question' as substitution of the linguistic order of substitutions of words, for other orders of one thing 'in place of' another, and for that substitution itself, in particular. The context of the following inquiry, as of this summary, towards 2000, has by the close of the book been organised 'in terms of' the inquiry (as simply its marking in terms found in earlier books) as what is open where and when such an inquiry is open: the inquiry in the end simply something that was open to its writer, the marking of its context as what was open, and of this mark itself as my 'position', θέσις, in it.

TABLE OF CONTENTS

VOLUME ONE

INTRODUCTION	i
PART ONE	
Incarnation	1
Kosmos	35
Enter Parmenides	117
Enter Socrates	167
Plato	172
Method	223
Hellenism	262
Alexandria	298
Rome	327

VOLUME TWO

PART ONE: SECOND HALF

I Am	342
From Initial Question to Third Century	347
The First Step	351
Γενεσις	380
Apostle to the Gentiles	398
Alexandria	410
From the Middle of the Third Century to the Close of the Fifth	427
One, Two, Three	452
'Neoplatonism'	483
Church and Empire, East and West	515
Acacian Schism to Iconoclasm	562
Eighth Century to Eleventh	584
The University: From Avicenna to the <u>Summae</u>	599

PART TWO

From Schoolmen to Romantics

Opening Questions	1
Renaissance	16
Reform	45
Luther	57
<u>Experientia</u>	71
Scientific Revolution	93
Enlightenment	99
1800	146

VOLUME THREE

PART THREE

Opening Questions	1
The Last Act	22
Mid-century	47
1900	77
New World, 1870-1930	85
Crisis	137
Mid-century: 1930-1970	171
The Myth of the Twentieth Century	232
The System	307
Paris	326
Paris 1970	454
Twentieth Century	473



VOLUME FOUR

CLOSE

'?'	1
Who? Me?	6
'Science'	77
Philology	95
<u>Mediæ Tempestates</u>	163
Renaissance, Reform, Revolution	170
Cartesian Focus	278
Enlightenment, Lumieres, Aufklärung	335
<u>Ähnliche Zeitpunkten</u>	408
Bookshelves	445
<u>De te fabula narratur.</u>	467
Paris 1970	512
Me and Jacques Derrida	561
Question, Mark	615
Twentieth Century	677
Globe Theatre	746
?	764

**?**

Who am I?

.....I have just begun this book..

...Here..

.....Now..

I open the book..but who am I?

Am 'I' a word?

I am asking these questions..though..

..words cannot ask themselves questions, can they?

..It is 'I' who finds in them my question who asks what they are..



My question.

..but is it really mine?

Are these words mine?

..Or have I found them?

I opened the book by finding them, found them by opening  
the book

..the book..

....these words?..

..Or....something.....mo  
.....m

Was the book...there...?

..Where...?

..This book?

Was it this book?

..How could I know until I opened it..

But,..., if I opened it, then 'I' had already opened it..

....I was there..

...waiting for..me

Or was I there, waiting for you?

Me?...Who am I then?

I opened the book..when we opened it..

..opened it, already there..already open..

...like a question..

..the question itself..

...or was it just a mark?..

....a question mark?..

..the question..or was it just a mark..opened the book..

..asking, when I thought I opened it..who I..

..thought I was..

Thought... I thought I was opening it. Someone else must have thought that 'I' would open it, in order to open it in the way he has. He has chosen these words, not I. Or, rather, I have only chosen them unknowingly, in opening the book. And not even the book, really, in that sense... only this copy.

But is that really what I mean? What if the book is really a piece of fiction, and I, the 'reader', am the fictional author? Then 'But is that what I really mean?' is me, the reader, imagining, thinking myself, to be the author. But that's not really true...at least, it's not really true in the fiction....

But if I am me, reading, really, it's not really true at all, it's a sort of pure, circular fiction, which I, really reading it, stand outside...Ah, but then that would be true in the story, too.

But I can close the book. I might have closed it already. How could the author know? I can choose whether to be his 'I' or not.

....Oh, but I really am the author, I am choosing these words, I am writing, and I couldn't have closed the book - the real book, not this copy ( or rather this, and not that copy), or there would have been no copy for you to choose to read.

....Ah, but I am also the imaginary reader, reading these words, and I cannot choose to close the book until I, as writer, choose.

And, if I am reading still (as indeed I am, or I must have closed the book, and could not be reading these words) then 'I' must be the real reader also. Or rather a real reader, since I have no way of telling whether someone else may also, even now, be reading these same words. Indeed the writer, who is also the imaginary reader - as I am also, in a way, the imaginary writer - is somehow reading as I read, as someone might read over my shoulder, or over my imaginary shoulder.

Who, then, am 'I', in these words? It seems that in the circle of a fiction 'I' can be, indeed 'I' must be, whoever 'I' think(s) 'I' am. But is this a fiction, or am I really involved in such a circle? Who is to choose? Am I? As writer, as choosing the words, I may ask you (then the reader) to choose that this whole imaginary dialogue is a fiction with which I have chosen to begin my book. I might - at last remembering convention, ask: Please, reader, now imagine that I have omitted initial inverted commas, that the book really begins: ' "Who am I?..."', and that this introductory fictional dialogue ends here."

Or I may choose to ask you to forgive my failure to remain within such conventions, and insist that I did not really mean the last inverted commas to be taken seriously. Indeed I now see that it must be a fiction.

But surely we, reader and writer, really can stand outside all these words, and that this is so is no fiction, indeed has its own circularity of choice, action, actuality, that exactly mirrors the circle of fiction which we can actually stand outside? Surely either of us can choose whether or not, and how, we enter into the circle of words?

Yet who, then, is 'I', opening this book, when no-one is reading it, and no-one writing it? Nobody? Nobody when 'I' has no body, no 'here', no 'now', in which to actually open the book - by writing, embodying the book, or by bodily reading a copy? Must some body actually 'choose' the words, choose to write, or choose to read? Is an 'I' common to all these choices, these real choices, of real I's, a simple fiction, a circle of words turning on themselves, or a word turning on itself?

But what, then, is actually the common frame of I, here, now, which is the same every time these nothings, 'I', 'here', 'now', indeed the whole order of words, reflecting the actuality of their use, are used?...this 'world' in which we use them? Must we, who make a difference with these same words, actually share in some common framework corresponding to the circle of a fiction, but real rather than imaginary, in order to be in a position, a situation, in which to choose such words?

Do not all these words, in fact, correspond to questions? Each covers a range of different uses, in which we, in different situations, may use them to indicate the differences of our situations. In a way the questions must be 'there', indeed always 'here', 'now', in order for us to distinguish between different answers, or different uses of the same answer: 'I am here, now, in this body, independent of the circle of words in which 'I' am always 'here', 'now', always 'me', but rarely me'.

...And is there not a 'fundamental' question which confounds the independence which 'I' think(s) 'myself' to have in the inscription of the closed circle of fiction in the Thought which 'I' think to be 'my' own, as 'I' 'think' 'I' choose who to 'think', or imagine, 'myself'? Is there not, actually, a question implicit in words themselves: How can 'I' decide whether an 'outward' or independent pattern of here and now and bodies determines who 'I' am, or whether I am, rather, myself in my affirmation of my actuality, in the terms which I (think I) find in my thought, as I find the words which express them in the world in which, 'here' and 'now', I use 'these' words?... The organisation of the 'outward' world, including these very words here and now seems also to include the organisation of 'my' thought, just as my thought seems to include the closed frame of these words, as I recognise my circular choice which confirms my independence of the circle of words in my power to entertain them in my thought, as corresponding to, or comprehended in, thoughts, my own fictions. How then to decide between 'I' and me, between two 'sides' of an action, an actuality, of self-assertion, between what is common, and what is particular, in such actuality? For a particularity, a difference which makes it me who says it this time, is itself common to all such self-assertion. Who...am...I? And why am I...me? Why should I be writing and you reading? Does not 'I' organise things in such a way that even the particularity in which I choose to write, to use these words, is somehow impersonal, interchangeable? Why am I here, now, in this body, rather than here, now, and in this body? How is it that I am you, but that you are not me.... or...are you?

Of course, simply by being a reader, rather than 'I', you can at once circumscribe this question, and choose that 'That's your problem; if you've got all tangled up in words, that's no reason for me to join you'. And yet in a way the question, even if it seem no problem,

is common to us all, in this our 'community' of common place, time, words, bodies. For you are somebody before you read, and the particularity of you, a particular reader, allowing you to choose where to stand in relation to this book, is itself, as it were, a part of the question marked by the fact of a book, enclosed in a cover, or rather, in the actuality of words, through which all of us, joined by or in a common world, communicate. This book simply exemplifies, in the common form of 'books' - including their common particularity or difference - the mystery of words. Like any question it is both open - there is a question - and closed, it being different from other books, as a question must differ from other questions in order to be that question, corresponding to the range of answering which makes it 'open'. Part of the mystery is just the possibility of this exemplification, corresponding to the opening question in which I wonder(s) how I can be me, and to the difference of this book amounting to its questioning its own particularity. It is just this particularity of the book, corresponding to 'I' in the opening question, which allows the rejection of the opening question itself by a 'reader's' reserve - which is to say, by Thought. For the question or mystery of the Question itself is simply unthinkable, requiring for its Answer a personal participation in the actuality common to Thought and to the circle of words contained in Thought as things, circumscribed by thought as a book in its 'world'. It can, though, at least, be truly thought that actual participation may be required for the answering of this Question...and I, as I write, ask that this be always 'borne in mind'.

## WHAT IS THE QUESTION?

What is open in our Question?

Why, this very book. The actuality of these words is in question. The opening of the book amounts to an initial expression of the Question, its reflection in the act of opening the book, just as the 'name' of the book simply marks the Question in our common world, the closed book reflecting the question of the actuality of the Question, of questions, itself. This empty 'mark' marks the coincidence of the circle of 'marks' in the book, turning upon themselves like the opening 'I', and the Thought which, moving in the frame of such marks mirrored in its own circle of self-assertion,



finds what it thinks is a book, a closed imaginary world, within the world shared by thinking and words in the person of whoever, finding the book, opens it. The mark, like the closed book, marks an openness, a question, whose open-ness and range corresponds to the two 'sides' of a mirroring which relates the words in the book to the thoughts corresponding to them 'in' writer and reader. The book opened by the writer is imaginary: he begins as it were with the end of writing. The beginning is chosen 'with' the end of writing the book; the end is in a way prior to the choices 'I' here make of words. The reader, on the other hand, opens a real book at the beginning, after all the choices of the writer have been made, and, in the open frame of questions indicated by the title, chooses to follow all the choices until the end. I, writing, work(s), as it were, back to your beginning, and you from thence toward my end. In the interaction of these two converse orders of determination and question, opening and closing, lies the dialogue and argument in the dimension of words which we share. 'I' must proceed by subordinating an imaginary reader to the frame of 'my' questioning, and you must understand me by containing in your imagination the Writer. Thus, in the opening of this book I, as writer, had to try and bring into question the relation between the reality of my choices, and the fiction by which I imagined myself no longer the imaginary Reader, but you, a particular reader. In order to introduce the question of questions, of the Question, I had to dramatise the 'converse' of writer and reader, by putting in question the truth of the book, asking whether 'I' actually meant I, who really wrote, or whether the whole converse or systematic conversion was the fiction of some missing author. The end of this playing with convention was to bring into play a choice, a question, which, as 'convention', is traditionally external to a book: the status of first, second, and third person, and the choice, in general, of the sort of choices different persons in the book can make. This involves a distinction between 'reflection' and 'narration', deduction and story, and, in the case of the latter, between the narration of an author 'outside' the story, and one determined by the 'false' or imaginary identification of author with a person who did not 'in' fact write the story, but who is presented in the fiction as though he did - his choices, action, within the narrative being, in fact, chosen by someone else.

The 'end' of this play is to be an introduction to, or induction into, the dramatic frame of this Actuality in which we write and read. 'My' part is here to write. This is to exemplify what 'one' might call the common dramatic truth of which the circular self-assertion of Thought and its reflection in this World are two converse domains or sides, one mirroring the other. This dramatic presentation of Drama requires the mirroring or reflection of this duality of Thought and World, of 'Reflection' in a closed system of words - this book - whose organisation thus simply reflects that of the Question which it expresses or marks. It begins in this simple character of outward 'mark', marking a closed system of 'marks', words, expressing, in the closure of a book, an open question, 'what's this?'. It closes in finding this very question, the closed book with which it began, at the end of its reflections. This is of course a simple corollary of the confusion of reader and writer, imaginary and real, in the opening of the book. Rather than the end preceding the beginning, as in this writing, or the beginning preceding the end, as in reading, the two coincide in the common closure of their common words, corresponding to the 'closed' particularity of the Question of the Book.

Such circularity is no more nor less 'unthinkable' than the circularity involved in the simple form of self-assertion, 'I', and amounts, really, only to the unity of a book. But unlike the unity of most books (and like the unity of the act of self-naming), this unity is not subject to the conventional distinction of fiction and non-fiction already noted - just as the common actuality of facts and thoughts cannot be contained or comprehended in either.

This circumstance reflects directly the way that the organisation of the book derives from the character of question, its simple complementarity of 'open', or what is to be determined, and 'closed', the corresponding range of possible determinations or answers. For one may ask: what determines the closure of questions 'in general', what is this 'closure', or what is the 'fundamental' difference between 'open' and 'closed' which makes questions possible? But what closure can determine the frame of this question?

The circularity of this Question, or question of questions has the character of a paradox, and might indeed be called Paradox insofar as it constitutes a minimal case that one might call the paradoxical thought of paradox itself, common to all the impasses of thought, or rather of Thought, which present themselves to our thinking as impossible questions. For it amounts, 'actually' to the very mirror of 'open' and 'closed' from which Thought abstracts, in the closure of its self-assertion, the 'open' interiority of determinations proceeding from an inaugural fiction of the coincidence of thought and fact in the 'I' that thinks it thinks; this 'I' that thinks it is whoever it thinks, or which whoever unthinkingly thinks that they think, must think they are. This mirror or question of the complementarity of the circular self-assertion of Thought, and the World it thinks to comprehend in the circles of its fictions which correspond to its circumscription of words in this independent outward World, presents itself to Thought as an unthinkable actuality, a circularity which is both 'in' Thought and 'in' the World of facts which is part of its Inaugural fiction - and yet 'comprehended' in neither.

This 'paradox', then, questions the authority of an order of forward deduction which, thinking itself to originate in a circular answer to the question 'who am I', in the unthinking assertion 'I' in the very imaginary open space circumscribed by this 'initial' fiction, proceeds from some closed frame of inquiry whose imaginary closure repeats this 'initial' circularity, towards a corresponding imaginary pole or circle of simple determination, independent 'outward' fact. But there are no terms, no imaginary correspondences of circular fiction and outward circle of words, in which to frame this question. There is no 'where' in the imaginary open 'space' of determination, conclusion, in which reflection proceeds, to inscribe the closure, the range of 'open' and 'closed' which determines 'what is a question?'.

Here, now, the 'forward' order of inquiry proceeds from an actual mark, and the question of who opened the book; and the authority of Thought first appears in the progress of this questioning.

Indeed, this book is opened by the disruption of its closed unity by Thought impersonating us, and by our impersonations of Thought. It is closed at the same time in a circular independence of fact, reflecting this self-assertion of our thinking, and thought to correspond to the bodily inscription of these marks in this World; and the character of these marks, words, as fiction or non-fiction is thought to correspond to whether 'I', 'here', 'now' were actually used by me, there and then.

This outward independence of the book, reflected in the question of its relation to the World about it - as fiction or non-fiction - itself reflects, as has been already several times suggested, the independence of our thought in the 'impersonation' or understanding of its inscription in these words. The 'comprehension' of the words in the forward order of the Thought which opens the book originates in an imaginary actuality of 'I' thinking itself to coincide with its own self-assertion in Thought, or, really, in the actual opening of this book, an actual coincidence of my thought or yours, my thought and yours, in its forward movement, with the closed independence of this book, in the act of opening it. The questioning by which the book is now proceeding involves an actual 'converse' between the converse orders of 'open' Thought and 'closed' book, without the more usual subordination of one of these orders to the other which would determine the book as deduction or narrative, one excluding the other. Such a proceeding might tempt a reader to resolve the confusion of Thought and World by simply closing the book, and so participating in the Actuality which closes the book in a similar coincidence of the two orders of Thought and World. I, writing, must try and avoid this, by keeping the converse between real writer as imaginary reader, and real reader as imaginary writer, firmly rooted in the converse of Thought and words, to which it directly corresponds. I must hope that I, who impersonate the Writer, can play my part well enough to maintain your sympathy as a real reader, conscious of the difference between the player and the part.

WHAT NOW?... WHAT NEXT?

What, then, actually is the Question? What is the difference between the Question, and the Question-Mark which solicits the disruption of the closed book in its opening? How does this Question inhabit this book? How does this question inhabit this sentence, from opening to closing mark?

Is it simply by the conventions which govern our uses of words, including those conventions which usually distinguish deduction from narrative, fiction from non-fiction (and from wilful misrepresentation, lies)? ...But these conventions lead to the paradox of the Question. They, like the Question, are neither comprehended in Thought nor in its World, which, as we have seen, are themselves, in a way, of the nature of conventions. Might we say that our Paradox only arises because we fail to remain within these conventions? But what sort of convention can forbid playing with conventions? Is not the authority of such Convention quite as circular as the authority of deduction? Is not such a recourse to Convention simply a refusal of the Question, an attempt to draw an arbitrary line between the imaginary absolute choice of Thought, independent of World and words, and the particular questions which it has the authority, the freedom, to decide? And this, precisely, by an appeal to independent facts, mirroring this circumscription of Thought, of thoughts: 'such are the conventions, such is Convention'?

Conventions or laws, at any rate, in the inscription of questions within the intercourse of a community of persons, actual users of words, like you and I, are themselves subject to the force of our paradox, in another form. For a convention must include a variety of possible cases within the domain of its rule, and so allow again our original question 'how' this inclusion is to be decided. We cannot determine how conventions apply in general simply 'by convention', any more than we should not question why we should not question Convention. The situation here, with regard to the formal circles of 'how' and 'why' and their converse order-

ings of activity, including our common or communal use of words, is quite analogous to the situation of the converse orders of thoughts and World, or Thought and things. Indeed these two dimensions are themselves complementary determinations of a common Actuality including World, Thought and Community, and the part of Convention corresponds simply to the circle of Community, of a common personality that was already noted in the question of the relation of me, here, now, to a World as the common Frame of all uses of 'me', 'here', 'now'. Just as an imaginary origin of deduction in a fictional coincidence of 'I' and its thought is lost in the apparently innocent act of opening this book, so also disappears an equally fictional - or mythical - origin of the Authority of Convention, its unquestionable Law or Rule.

For Convention 'explains' the Question-Mark, in terms of its use to mark a question - in this case to mark the book as a question - just as Thought explains or defines me by my use of my mark, 'I'. The question of how this can be done finds in Convention an answer as circular, and in the same terms of circular 'choice' and 'fact', as we found in Thought to the question 'Who am I?'. Yet in the conversion of this initial 'how' of the Mark into its 'why' (or rather, into a simple 'because') we actually have a determination of the opening of the book as action complementary to its determination as the origin of a deduction in the abstraction from the actuality of the book in the circular self-assertion of Thought. The ways in which these two determinations preclude our Question are quite complementary, like the two 'sides', aspects, 'open' and 'closed', of the Question itself, and in Convention Thought finds itself now confronted by a circular authority of Fact which refuses its question, as by the reflection in its 'World' of the circularity of the very action by which 'I' thinks to abstract to the inner world of thoughts.

How, then, do we mark a question; 'How does this question inhabit this sentence, from opening to closing mark?'

... Well, is that the same as this question? For the open-ness of questions allows a recurrence which is the converse

of the Question; that is: Which question?

The question-mark must be used if it is to ask a question, even if we do not know who has used it, or whether perhaps we are asking ourselves a question, even if we do not know just who we are. How?

How do we know when it is used, or where? How do we know when it is used, or when to use it? Do not different questions all partake of some here, some now, some I or I's? Isn't each 'this' question? Mustn't a question be somehow presented? Isn't this element of particularity, corresponding to some principle of resolution of the open open-ness of 'Which question?', just the converse of the irresoluble open-ness of the Question, which last corresponds to the closed frame of the duality or difference of open and closed as simply dual? Doesn't this complementarity of Question and questions, indeed, simply reflect the complementarity, or systematic mirroring, of an independent World of things, and the self-assertion of Choice, in this our Community of persons? Doesn't this Mark constitute a sort of minimal case of the participation of these words in the outward independence of Things, and the question of the relation of World to Mark a minimal case of the question of assertion, reflected in the more familiar question of the 'truth' or 'falsehood' of an account, or the fictionality or non-fictionality of a book? Doesn't it mark the coincidence of the outer space of a World, and the inner space of Thought? ...This complementing, as the extreme of 'how', the closed frame of its inscription in the Community of persons, the frame of 'I's, 'here's, 'now's, of who and where and when?

What does this mark mean:

•

?

... What can I mean, you may ask, in asking such a question? Not even 'What does this mark mean, then.....?'. Is the 'then' implicit in the abrupt transition to this question? Or can this mark, which may or may not be of the order of words, itself somehow correspond to the question of whether there has been some disruption in the order of deduction, corresponding to the disruption - or, rather, the irruption - with which this particular order of words began. Goodness.... what's the.... point!

Is not this question, as it were, a return of the independence of fact, after its disruption by thought? And does not the disruption of deduction, which cannot infer the sense of this question from what has gone before, here confront the finality, the 'why' which belongs to the closure, the closing or conclusion of this book already somehow implicit in its opening?

Is this disruption, anyway, really unusual, after all, after all that? For is this not the same mark which disrupts the progression of deduction from sentence to sentence, breaking this order up, or down, precisely, into 'sentences'? And has it not been there, here, all the time, as a part of the question-mark itself???? ? .....a part whose 'parts', unless given some sense, mean nothing, or the same as the whole... whose independence of their unity as a mark amounts only to the complete independence of sense, of participation in the line or order of deduction, of 'things' in themselves, if indeed they have, being things, any self, rather than just a reflected image of the fictional self-assertion of Thought, turning upon itself, it's self.

But is the question then, 'What does this mark mean, in itself? Does it ask for the conventional sense, or senses, of this mark? Or is it rather a question of this mark, this use of this mark, rather than the uses that can be made of conventions regarding, but, it seems, not altogether circumscribing, this mark?

Can we resolve that question, if indeed that is the question? Is it not, after all... is it not, after all, the preceding question of the particularity of questions, the question 'Which question?'



Or is it rather... a question 'of' that question, a particular case of that question, a question 'of' that question inasmuch as it brings that question 'into play'?

Could it mean that a mark was always 'that' mark, and so indeed a mark, something marked by someone? Could I have meant that by making this mark, that mark? What could I have meant by marking the paper, otherwise unmarked up till that... point?

Could one ask: 'How could I have done such a thing?.... How could you have done such a thing?' ? For I will admit that it was indeed I who made the mark: It doesn't 'mean' that the paper was mark-  
ed at this point, and that I, writing, pursuing the progress of deduction suddenly found that the paper was marked, and wondered what, if anything that might mean. The train of questions lead on from this mark, rather than back to some reason or cause outside the converse deductive and narrative orders of the words, to some chance marking, whether accidental or intentional, of the paper, this paper on which the book is arbitrarily printed. How indeed could such an arbitrary mark appear in your copy, unless it happened to be this one which 'I' as Writer, or rather, as the actual writer, am in fact writing, to be copied? For if such an arbitrary mark were to be copied, it would no longer be 'this' one.

No, I had to be bodily there, me, the real writer. I had to choose to assert myself as writer, breaking the forward progression of these words in the Deduction of Thought, just as when I opened the book by beginning to write. 'I' had to be marked by me, and by me writing, remarking my own bodily presence there, here, at a typewriter, then and not now. Standing - or rather sitting - in an order independent of the forward order of the deduction, independently making a mark then, not now, though each time is, or was, a 'now', whose own independence of this order of Time in which I am still writing is marked by the way that you, the real reader, have, as I write, not 'yet' really seen that mark, which must wait until that 'now' when you first remarked it, or when you will first remark it. And I, the real writer, am related to you, the real reader, a real reader, only through the mirroring of the Reader and the Writer in the closure

of this as of every other Book, as of every sentence. For it is this Reader and Writer that coincide at that, as at every, point, in each mark which punctuates, articulates, the narrative, any narrative. I personally, bodily me, had to choose to make that mark; and it is just this choice which is marked at that point of this book. That is what I 'meant' in constructing that question, marked simply by the point as that question. For the fundamental particularity of any question lies in just this irreducible independence which holds us in part outside the closed symmetry of imaginary Reader and Writer, even though it is through these 'imaginary' parts, characters, figures, that we must really, actively or passively, be who we are; and it is the imaginary part of Thought to ask and be asked, and to ask itself questions, that part which we mark '.....', in a simple open-ness of punctuation. In that line Thought invites and is invited into its own domain, Thought plays its part in us, and invites us to think.

So here, perhaps, we are. Where do we go from here? How do the points at the beginning and end of a sentence, opening and closing these sentences, as they open and close this sentence... ..carry us along with them, in the prosecution of Thought?

It must surely be something in the words, for how could we tell simply between two marks of punctuation which way to go? Could it really be convention, this time; even though we have seen that 'this time' is itself no matter of convention alone, or we, like the imaginary Reader and Writer would be forever everywhere and nowhere in words. For although some 'foreign' conventions would have required us to begin this book, or rather another book that might have been printed between these covers, at what is for us the end, then Thought would also have proceeded in the reverse of this direction. In either case, Thought disrupts the symmetry of the punctuation, and seems to follow the direction of words. Or do the words, rather, follow the direction of Thought? What then is the direction of Thought and words, whichever leads or follows?

## MIRROR

The imaginary Writer and Reader are locked in the closed symmetry of a fiction, as in this closed book, until questioning Thought remarks a Book, this Thing, yet not just a Thing: opening it, our thoughts disrupt this closure, this symmetry of beginning and end engulfed in Silence, just as we, real readers and writer, might disrupt the same silence in speech. For do not the words speak for us and to us here, as we entertain one another in Imagination? Between the opening and the closing of this book, the punctuation distinguishes many sentences, opening and closing in a similar way. Closed by these simple marks, . and ? , of assertion and questioning. Assertion of my passing presence in the mark which marks my presence in the sentence it closes, inviting assent as the other invites thought.

The closure of the book, like the closure of the sentence, invites Thought into the space between beginning and end, and this correspondence of open and closed itself reflects the character of questions, inviting from sentence to sentence the progressive conclusions of Thought... Between the 'closed' things which are this book 'in itself', and the points in it at which its component sentences conclude, lies the domain of words in which Thought moves forward, pausing, perhaps, as here, in mid-sentence, pausing, perhaps, a little longer at the end.... And, perhaps, a little longer still at the end of each group of sentences.....

What could mark this space, this dimension or order punctuated by questions and pauses and conclusions in which our thinking now proceeds; what in it could mark the continuation from point to point, which is the mark of our thinking, as the point marks our assertion in words? What could mark the individuality of a presence 'here' of each of us, which has no copy? For it seems we cannot here in these words mark some other point outside their order, in which each of us might 'now' be present.... and yet the words 'tell' us that there must always be such a missing point, proceeding, as it were, from its reflection in one point of writing and reading to the next. And this constantly progressing point would represent the very continuity of that remarkable presence of our selves to our and others' selves, from which the closed

symmetry of the opening and closing of this book abstracts its fictional isolation. An isolation which reflects the isolation of that missing point at which we may be really, at some point, present in these words, and which the words reflect in the 'I' that we imagine to be our self. An isolation we see in the marks themselves we use as words, and the thing itself which copies the closed symmetry of this line of words in the real book which I bodily write and which you bodily read.

It was a passing coincidence or conjunction of this isolation of the 'thing' which is marked, and of this thing which is my bodily self, which I marked at that point in the progress of our thinking marked by the isolated point, that mark I chose. And it is the open space between such a mark and the next to be made which marks, is the image of, reflects, the then still open question of how and where next to mark, to assert, the progress of deduction. As I now write this, the 'next' sentence, I am in the process of choosing how, where, why, it will end; and as I end this sentence, in the process of deciding how this group of sentences will end, in the space or interval which marks the closed frame of this group, as a greater space groups this with other paragraphs in this section of this entry into the book, this Introduction. And all these possibilities, choices within choices, are reflected in the Silence which closes this book, as the common space in which we, reader and writer, are or will be present; encloses and isolates copies of this book, encloses and isolates, in particular, in each case, this copy.

How can I mark this 'space' between the points of the deduction? How copy it, as this copy of the book copies the closed symmetry of these two orders of thought and image, of deduction and imagination; how find an image of the Imagination which presents deductive Thought with a choice, in beginning each sentence, of how it will end? How, that is, can this space itself enter into the book, as into each copy? How, itself, enter into the order of deduction, which it mirrors inseparably?

....But, you may ask, is it not already here in the bodily separation of the words in every copy? H-e-r-e? And is it not here in our conventional pause for thought...? .....

But is it really here, doubling the order of these words? Surely we have seen that it is not of the forward deductive and assertive order of words, but of things, somehow independent of the order of words, as the order of words is independent of the choice between this direction of writing and reading, and the converse, since each must always be 'this' direction. Must we not somehow mark the space in a way that 'means' nothing, except that the space should be remarked? Can we really do this with a series of points, '.....'?

But these, in the symmetry or indifference of their order, cannot mark the presence of our thinking, except by their association with, their inscription in, the conventional order of our writing.... they tell us nothing, or simply repeat the order of words. How can we mark the presence of our thinking, as we write or read, in this symmetric order of marks, which it disrupts in the order of its deduction? How mark the missing point in which thought and mark always 'now' coincide, and through which and as which thought, passing, is ordered? How mark now the continuity of our thinking as this presence of our thinking now in these words, from which the symmetric ordering of points where thinking and imagining coincide is abstracted by the very closure of its symmetry - the closed circuit of real beginning and imaginary end within which I write, and the closed circuit of really finished book, and imaginary beginning, in which I imagine you to read? How reflect in the configuration of questions and assertions which is this book - one proceeding from the end in imagination, the other from the beginning in thought, one opening from the end, the other closing from the beginning - how reflect the actuality of our reading and writing, the direction of my choices, my assertion as Writer, 'and your consideration of these, in the Community of our common Actuality of which and in which we partake and are parts?

For the missing point of which each stop is a copy, hiding the passing presence it marks, and which all the points between may or may not present, as all those beyond, and perhaps one hiding behind, this point do, now as I write this sentence, is both throughout the imaginary paper of the imaginary book with which I began, and quite outside every real copy, isolated in a thing.

Is there not something in the continuation, the continuity of thought, reflected in the continuity of the circumscribing Space disrupted by this copy of this book, in the continuity of the paper disrupted by each mark, the continuity of things; by which the disruption of this continuity in assertion or book corresponds to thought's disruption of the closed or symmetric coordination of opening and closing the book or opening and closing this sentence? Is there not some correspondence between the mirroring of the orders of deduction and imagination, answer and question, closed and open, in the closed frame of the book which thus oddly corresponds to its enclosure, circumscription, isolation, in this continuous space in which it can be bodily opened? Is it not somehow in this correspondence that the opening question has its force, through this correspondence that the real disruption of the closed body of the book begins the progress of our thinking through these words, and as it were generates the order of deduction, the asymmetry of our reason and our imagination from which the symmetry of their two orders in this book, which we disrupt in opening it, is abstracted?

Is it not as if the 'missing point' for which we are seeking is somehow there where the continuity of circumscribing Thought and World are broken in the act which disrupts the closure of the book? There where Thought unthinkably crosses into the closed order of words, breaking the symmetry of their opening and closing, of their punctuation, and installing in that closed frame the disymmetry of a deduction? As though (in the book) the missing point of entry into the book, marked as a question, as the Question of this book, corresponding to the act of opening, its actuality, progresses from point to point in the book in quest of some final assertion, some conclusion, the closing of the book? As if stumbling unthinkingly in, it must think its way out?

Then we might mark this progress by a continuous line traced by this 'missing point' through the thing that is this copy of this book, in search of the discontinuity marked by the end-point where, in the integration of the unthinkably incommensurable orders of Word and Presence in the closure of this book, awaits....perhaps, the Answer.

Or might we? For such a line has not yet begun in this discontinuous order of points and words....has it?....Unless we were to suppose that opening this book has somehow marked US...

Such a mark would be no thing, anyway... Do acts....mark us?...perhaps we must suppose they do...for how else could we remark anything? How else could we remark ourselves, our selves? And without some...mark...how could we remeber such acts, how, indeed, would they be 'ours'? How, indeed, could there be any interaction between us in these words unless my 'I' somehow marked me, and my 'you' somehow marked you, in my activity of using these marks? We are marked men... and women...from the beginning...even though we cannot mark our selves in Thought or Thing in any beginning in Thought or Thing...but only in the acts, the Actuality that is so remarkable!

Did I not try and mark this act of remarking myself as writer, when I remarked that I had made a mark, and asked how?...and imagined you asking why?...? ...Only to find that the point that I wanted to make was still somehow eluding us? Something was still wanting, 'I' was still wanting, I was still wanting some thing, and we moved on here. Was that the first point of another line, an other imaginary line following, as it were, the initial line of Thought - and, a real point, actually opening this line of thought? Some thing only in Thought, a fiction? Did we not see that this imaginary line was missing ...the point? Missing the point of entry, which broke the closed circuit of these words, and then moved along this imaginary line, missing at each point in turn? And did we not miss the point just when we tried to mark within this closed movement forward and backward, of reason and imagination, just the closing point which would repeat, and so conceal within the words, our point of entry? Didn't we only 'miss', lack, the wanting point, when we missed the point of the book, and tried to close it before the end? 'I' had still to go on thinking, not yet having found us.

Are we getting anywhere with all this business of real and imaginary points, lines, circles, crossing? What could be behind

it all, 'behind' it all? Anything other, more, than this order, ordering, dimension, 'line' of Thought, failing to see merely the reflection of its own Reflection in these words that lead it on? Are we getting any where further than our recognition that this Thought was only unwittingly doubling the order of these words, when it thought to describe the presence in which, disrupting the senselessness of its simple fact, it recognised in a mark the presence of some thought, and its sense? Are we not, rather, receding further from our object, while seeming, in this mirror of words, to advance? Are we returning from the Truth of Thought's recognition of itself in 'I' further and further into the senseless marks so ill-used? Might we not better retreat to this missing origin, lost in opening this book and finding ourselves wanting in its words, and confusing, as here, the words that want us, and something we want in the words? But just who, now, are we? How could 'we' now return to this 'I' that has been lost? We have seen our selves in the Mirror 'I' cannot see, lost in the circle of its imaginary identification with the isolation of a thing that it takes for itself. We have lost no thing, but only a fiction, an illusion, this Identity, this Term, of Thought. A thing indeed, this bodily me, thought it was 'I'. It thought to return to itself, but now we are returning to ourselves, having seen the Mirror.

'Seen'? But how could we see the mirror in which we see our selves? Have we really seen it, or only its reflection in words? Is it not at just that missing point we are trying to find? That point in which we imagine real and imaginary to coincide, but which we cannot mark? That point which is neither the 'I' of Thought or 'my' Body? That point, alone, where we are actually ourselves? That imaginary point in which the closed symmetry of these marks, leading neither forward nor back until thought to do so, is broken; that real point where the closed circuit of thought, in the imaginary continuity of its order is, in this disruption, in this irruption into the discontinuity of book and mark, itself broken. This imaginary point where the domains of Thought and Body are confused, conjoined, in which this very thinking of Thought and Body now proceeds through these words, if these very words now bodily present themselves to our bodies, in that mirroring which is the embodiment of their very thought.



A mirroring which, in the real disruption of this continuity of 'I's' imaginary presence to itself, in the act of opening this book, never really begins, having, in our recognition of our selves in these words, always already begun...the first real point of coincidence of real and imaginary orders being already a part of this book. A mirroring which continues, which is continued, by the imaginary continuity of this missing point from the opening to the closing of the book, like an <sup>imaginary</sup> break in the closed frame of these words impelled from its imaginary origin in the wanting coincidence with its own reality, which it imagines to be really at the end of this book, in the return to this imaginary coincidence of Thought and Thing in these bodies which are our selves and this book itself, in this World which is itself no thing.

But how could we ever remark, in the closed thing which is the image of the closed order of its marks (that order of what we imagine to be, in themselves, the senseless differences of all these marks which are letters, an order of a definite range of definite differences, relating as in a frame all the letters of this book, a frame symmetric in the mirror of the page, as if we might begin, physically, with the last mark, and read backwards from the other side of the pages, and 'through' the pages, 'from' the other side, from 'behind'), how could we ever remark, from this <sup>other</sup> side of the words, 'inside' the book, 'from' the side of the Thing, the presence in this system of differences of a mirror, and so the point at which the deductive order of our reason, and the symmetric order of the mark, might coincide to mark, outside the circles of I and 'I', between them, their mirroring in which we are present to ourselves? How could we ever remark, except by the circular doubling of the sense of thinking in these words, the opening thus dual to the closed frame of words themselves, which accedes to our thinking, and gives it access from imaginary beginning to imaginary end, and from real beginning to real end? How mark the open-ness of the book in the book, remark in the book how its opening marks us? How inscribe in this book the Question marked on its cover: What is the relation between its opening and its closing, between its words and its World? How and why does it mark, and so mirror, our World? And how does its opening and closing mark Us?

Opening this book, we open up this imaginary distance from beginning to end, as the presence in our thinking of the three missing points of beginning, middle, and end, organising the actual progress of our reading or writing through the words, from real point to real point. This imaginary distance is crossed, as it were, from point to point in the words, as the distance between the broken circle of 'I' at the beginning, mirrored in the image of its renewal in the closed book at the end, is really traversed in our activity of question and answer, reading and writing. And it is this imaginary distance, crossing, as it were, the words in our Imagination (from 'I' to the image of closure which is, as it were, its 'object') which, as it crosses in Imagination the mirror of the words, marks our place 'here'.

The missing point at the beginning marks in Imagination, as by an imaginary 'cross' the coincidence of these two distances, orders, the real order of points, and the imaginary continuous order of 'I' thinking, the beginning of the book in Thought. The missing point at the end marks, as by another imaginary cross, the reflection of this same coincidence in the order of words, as the closing of the book, the book, as it were, as object. The coincidence of these two points in Imagination marks, as it were, the imaginary point at which open and closed book coincide in the act by which 'I' thinks to enter and leave the closed configuration of imaginary and real dimensions of the book. - Thinks to break by Thought's continuity the imaginary isolation of the book, as if to actually cross, along this line of Thought, into the fictional independence of the closed configuration which is the thought in or of the book, without suffering the actual disruption of Thought of which this imaginary disruption of, irruption into, the order of words is the fictional reflection in Thought, corresponding to the pure imaginary continuation of the point of coincidence of imaginary and real, which at the imaginary centre of all such configurations is the inaugural fiction of the 'I', abstracted from the mirror of words in just that identification of which the coincidence of beginning and end of its circuit through these words, in the closure of the book as thing which it initially thinks to disrupt, is this instance.

So where am I, where are we, now?

This book has opened with the question constituted by the complementarity of the closed frame of the book, isolated as a fiction, or in an implicit fictional isolation, and 'its' World in which it is inscribed. The symmetry of book and context, and the complementary asymmetry which together make the question of the book, have been seen to lie somehow in the closed order of questions, of opening and closing, by which the book is abstracted from the open complementarity of the converse orders, 'outside' the book, of a Thought which is constantly questioning, constantly finding symmetries and asking the 'reason' of asymmetry within the frame of such symmetry, and the underlying Fact of such asymmetry, seen, in a limiting case, in the asymmetry between Open and Closed in which, alone, there can be any question of thinking.

In an attempt to resolve the question implicit in the opening of the book, to inscribe within the order of Thought or book the locus of this opening, we have found that neither order, neither the closed order of the book, nor the open order of Thought, can be simply inscribed, one within the other, in any correspondence of Thought and the thought of the book...that the question posed by the relation of the closure of the book, and the corresponding openness which makes its question thinkable, cannot be resolved by any coincidence of the open order of Thought and World and the closed configuration of signs in the book, either at some point, or in some line traced by this point which is missing. Any such attempt has ended in a simple mirroring or doubling of the closed order of the book and the open order in which it is inscribed. This doubling, in its symmetry, still leaves our fundamental question unresolved. We have still failed to relate the simple symmetry of Thought and Fact expressed in this systematic 'doubling' and the apparently unthinkable asymmetry of its terms. In particular, we have been - as we might, of course, well have expected - unable to discern in the closed frame of the text any mark of radical disymmetry by which the text might be open to Thought...as yet it must be as we write or read. Unable...save in a partial recognition of a mutual disruption of the two orders in the act or acts of - in fact - opening

the book, breaking into the order of its words, as they, in complementary fashion, break into the continuity of an imaginary or fictional open-ness of abstract thought. And we have recognised that it is we who are somehow at the intersection of the two orders in the crossing of Thought into the questions of the book.

It is only in relation to this initial actuality of opening of the book in a confusion of the two orders of open and closed that we can mark or remark our access to these words now. Our presence in this closed configuration whose accessibility to an imaginary identification with a point of question or assertion that 'moves' through it in an order originating in our breaking into the finitary collection of marks in the first place, corresponds not to any particular point of coincidence of the orders of Thought and Thing ( for each point at which such an identification of our presence may seem to be made amounts only to a repetition of the order of thought in the words, or of the words in thought, in which repetition our question may again be repeated), but rather to a continuation through the words of the way that this initial act has itself broken the imaginary or fictional self-enclosure of Thought. A continuation in which we seek to close, precisely, the relation of closed text and open context which gives rise to our initial question. Yet this closure cannot in principle be inscribed even at the close of the closed configuration which poses the question, any more than our Question can be inscribed in the open-ness of abstraction from particular text and its context or World.

That is, the reading of this book cannot conform in Thought to a presence marked by the disruption of a closed configuration of words at a freely chosen point of entry at which, in conclusion, the material configuration of the book may be excluded by an abstraction, an exit, which formally mirrors the initial act of entry. The book cannot be regarded as the simple embodiment of an essentially independent line of Thought. The restoration of the broken circle of the text cannot simply reflect an imaginary solution (of the question posed by or in its words) which would have Thought and Fact coincide in the simple self-determination of 'I' as I, any more than the question of the book

could be resolved (on the 'other' side, of the Thing, of things) in some simple Fact of such and such a body having been in proximity to the words over such and such a time at such and such a place or places. We cannot simply close the question by some concluding inscription of Fact in Thought, or of Thought in Fact, for the question lies in the very mirror of words, in the two-sided complementarity, from which these complementary identifications, sides, are abstracted. The question involves Us, and the closure of Thought marked by the inscription of Fact at its origin as 'I', can no more make 'I' me or you, than the corresponding isolation of Thought in a Body can make such a body me, here, or now.

The frame of the question lies, rather, precisely in the symmetry of these two orders, precisely in the complementarity of closed text and open World of Thought, the first abstracted from the open movements of question and answer which characterise the second. And in this frame what is in question is the symmetry of the subordination of thought to fact in the opening of the book as a fact, and the converse subordination of fact to thought which makes this opening, in each case, 'mine'. The opening question of the book reflects just this symmetry in the converse orders of question and answer, opening and closing, which mirror one another in its limited frame. In this frame this opening question itself calls into question just the asymmetry of the orders of question and answer in which there can be a beginning of the book, and questions just that action of opening which in breaking the symmetry or closure of the text, makes this action 'mine'.

For the unbroken line traced in Imagination as the continuation of an I in which Fact is inscribed in Thought, in the closed circuits of its fictions whose focus or origin it marks, which thinks to cross into the closed configuration of marks, and so mark in them a beginning, an opening, is itself in reality broken, in this beginning, into the factual asymmetry of me and you, in a question which itself somehow opens the closed circuits of 'my' fictions by asking me whose they in fact are. Although an 'I' identified in my thoughts as a writer cannot in fact ask

'me' as a reader such a question in fact, not knowing who, in the open range of Reader I might in fact be, yet the text, in refusing the question of who in the text is in fact the first person, can break the imaginary identifications upon which such reserve depends and really ask who, in myself, 'I' am.

For the question is inscribed not so much in the marks on the paper of some copy which is in fact opened, but rather in the actual symmetry between the actual opening of some copy, and the actual disruption of the closed domain of 'I' in each such opening. The marks ask about the actuality of opening in each opening, and this not only in the domain of abstract Thought, but also in Fact, for the question lies just in the relation of these mirror domains. The question is asked not so much 'in' the book, as at the ambiguous point of crossing into the configuration of the text. Not only the words in the book, but (and primarily) the book itself, in all its aspects, including the particular circumstances of its openings, 'in the World', asks the central, the dominant, question. The book asks the question, or constitutes a question, the same for writer and readers, but in different aspects or modes. In this sense the question is not dependent on the underlying intention of a writer sure of his identity, real or fictional: it applies to whoever 'I' may be, of itself, and only depends in fact upon a writer as it depends upon ink and paper.

The frame of the question is constituted by the symmetry of the formal closure of Thought correlative with the unlimited open-ness of its questioning, and the mirroring of this in the independence or isolation of its objects, reflected in the Fact of there being questions at all. This symmetry or mirror may indeed be seen simply in terms of the question which it implies: how, in the frame of this question, does the question, 'What is a question?' mirror the complementary open-ness of 'which question?', the former confusing the independence of Thought, the latter the independence of the Thing. The former introduces an open-ness, an asymmetry, within the duality of open and closed in each question, within the closure which is the frame of all questioning; the

latter asks what to answer, what to determine, its frame given by the fictional isolation of the Fact.. What is common to each of these questionings is a recursion of the simple form of questions at large. One brings into question the closure which determines all questions as questions, the other the open-ness of such closure. One marks a limit to the 'opening' movement of Thought, the other a limit to the converse movement of finding what matters are closed, determined, before we may begin our questioning.. In their complementarity these two 'recurrent' questions themselves determine the domain of questions, in its widest range

At the same time one marks the disruption of the closed circuit of Thought which might otherwise contain some order of questions, while itself unquestioned; and the other marks the open-ness of thinking which opens up the domain of isolated facts to the continuity of its inquiry, and refuses to any answer an unquestionable isolation. These two questions mark the limits of any domain of questioning, of which the questions and answers of this book are one instance, isolated by the fact that it is the framing of questions which is here in question, with the particularity of the instance an inseparable part of the questioning.

How can we mark the breaking out of the isolation of copies of this book as things, which is at the same time a breaking into the domain of Thought of a common frame of both their questionings? How effect the transition of our line of question and answer out of the complementary isolations of Thought and Thing, and into this Actuality of questions in which they are mirrored, how enter, in this Introduction, into this mirror of words which is the domain of the book as question, as of the subordinate question and answer 'in' the book? How can we mark, in the common frame of symmetry of Open and Closed the question of the difference and interaction of the questioning open-ness of Thought, and the closed frame of question and answer which is this book which seeks to enquire into this relation?

This is as much as to ask ( and it is only a new form of the question which has guided the inquiry so far, and which must guide it to a conclusion, a close): How can we mark, in a copy of this book, in the closed frame in which both as Thing and as configuration of question and answer, symmetric in beginning and end, opening and closing, it is abstracted from the open-ness of questioning in general, and so, in this closure or isolation, itself poses our guiding question: . . . how can we mark the symmetry of its closure and its open-ness? How can we express, 'in' the book, the radical symmetry of the questioning from which the Thought which disrupts the Thing which is a configuration of marks, and this Thing, are conjointly abstracted, and which, in the mutual disruption of these orders, one by the other, in the opening of the book, governs the common order of their questioning? How can the reflection or repetition of the symmetry of these two orders in a copy of the book actually be an essential part of the exhibition of this symmetry in (and as belonging to) the order of questions, rather than simply another repetition of the disruption of that symmetry in the opening of a book?

We saw that the presence of questioning Thought in the book involved the 'crossing' of the words, in their real order of reading and writing, by an imaginary order or line from opening to closing in Thought, by the distance or 'space' of questions to be covered in the linear development of the deduction or narration. We saw that this 'crossing' was imagined to occur at the 'missing point' which moves continuously in Imagination from an initial crossing into the order of words which breaks the closed symmetry of the imaginary configuration of the text as a whole, a unity (in the opening of the book), to a final crossing out of the text in the close or conclusion of the dynamic of question and answer generated as the order of this continuous movement of Thought through the words. We saw how this continuity was rooted in the imaginary coincidence of Thought and words in question and assertion. We can now see that the closure or symmetry of the textual configuration thus broken in imagination, and in this crossing or break assuring the continuation of thinking through the discrete or finitary order of words, in their 'real' order as marks, differences, parallelling the doubling and crossing of this order in imagination until their coincidence in some final point which restores their



original closure to Thought and Thing...We can see that this imaginary closure must involve the coincidence in imagination of real and imaginary configuration of 'book' at the very point, beginning, middle, or end, in which this closure in thought and the closure of the configuration in fact, meet in the actual open-ness or accession of the book to Thought, or to this thinking of it. It is this coincidence of imaginary and real configurations of disruption, of mutual breaking of symmetry, which is itself the symmetry broken in the act of writing or reading, broken in imagination or in reality at beginning, middle, and end of the book...or rather: broken in opening the book, and so governing the accession of our thinking to the book until its restoration at the end, the real crossing into the book at the beginning mirrored as the imaginary conclusion, in the symmetry of the orders of question and answer governing the dynamic or real and imaginary orders, the opening and closing of this same configuration in question and answer, at each 'point' of the book. Thus the imaginary 'closure' or symmetry which governs the opening questioning at each point is itself the mirroring or doubling of the initial crossing into the closed or finitary configuration of the book in the final crossing out, and itself expresses the duality of the real and imaginary orders imagined to coincide at that point.

How can we possibly embody at some point in this ordering of words the systematic mirroring of the orders of mark and thinking, and so mark the transition into the duality of the more general order of questions at large (of which this mirroring is, as it were, a reflection in the order of words) which such a mark would effect? We must find a mark which stands symmetrically with respect to the beginning and end of this Introduction to the order of questions at large. In such a transition out of the closed symmetry of this closed domain of deduction in the frame presented by an Imagination which in the limit is the inscription of the order of Fact, Thing, in Thought as the Fact of the Question itself, the asymmetry of Open and Closed, we must allow this general order of questioning to mark itself in a figure, a configuration within the words, which, unlike the forward order of the words themselves, or the converse order of their isolation as the simple fact of marks in a book whose closure corresponds in Imagination to the frame of its questioning, does not already imply a breaking of the symmetry of these two orders of Thought and Thing, or a subordination of

of one to the other, but which, rather, expresses the symmetry which organises the mutuality or reciprocity of these two orders of crossing-one-another, breaking, one, the symmetry of the other, in the very movement by which its own symmetry is lost... a mark which expresses the symmetry of the breaking of its own symmetry, and which thus contains, dually, the converse orders of Fact and its imaginary inscription in Thought, and itself marks, in its breaking, the complementary circularity of closed Fact and the questioning Thought to which all such closure is open.

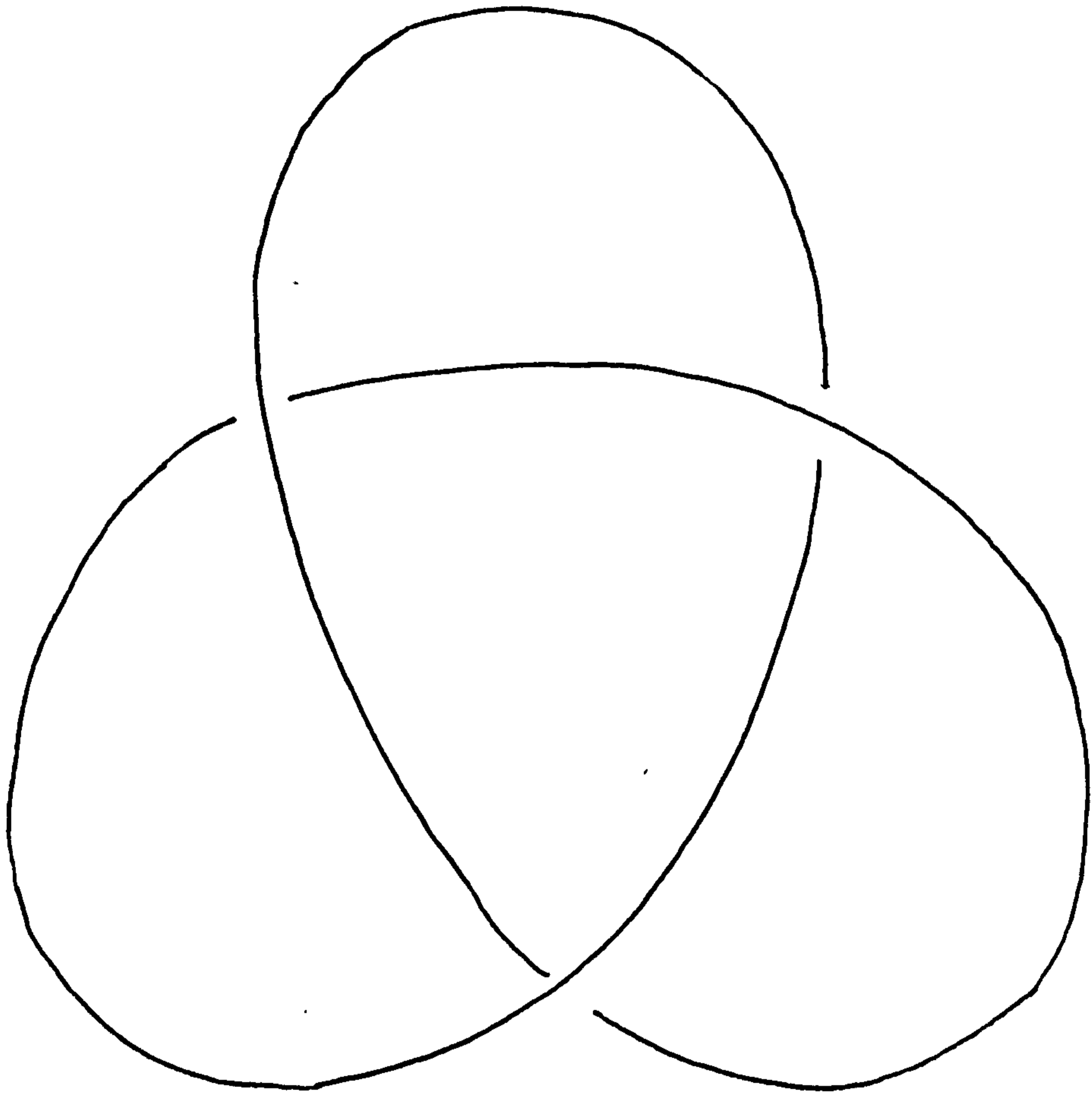

'Figure', for the symmetries of such a configuration, such a marking, must be prior to that breaking of such symmetry by which marks may be subordinated to the order of thinking as (or to become) 'words'. The mark must actually mirror such an order of 'words' in 'things'. And nor must the mark simply be a 'thing', an image, an illustration, in a fictional independence from the order of words. Its difference from the order of words must be subject, without limit, to inscription in this order, in the narration by Thought of its own direction, in pursuit of the closure which would define its Question. It must appear in words as the Mirror of words which the words alone, in the order of deduction, cannot mark. The Mirror in which words reflect things in our thinking of them, the Figure which, marking in words the order of questioning, the dynamic symmetry of Open and Closed whose subordination to the closure of Thought in the activity of making-sense these words represent, might, paradoxically, be called the Word which answers our Question, in the exhibition of an opening rooted in the symmetry of Open and Closed. And it marks the question and the questioning of the book at the point of entry into 'questioning at large' which itself mirrors, in the symmetry of opening Thought and closed Fact, the crossing out of this general symmetry in the initial order of disruption in which we crossed into the first words of this Introduction. This first half of the Introduction passes into the next through just this symmetrical disymmetry, the difference or distance from which, in the deduction so far, these opening words have traced to just this point of transition in which they close:

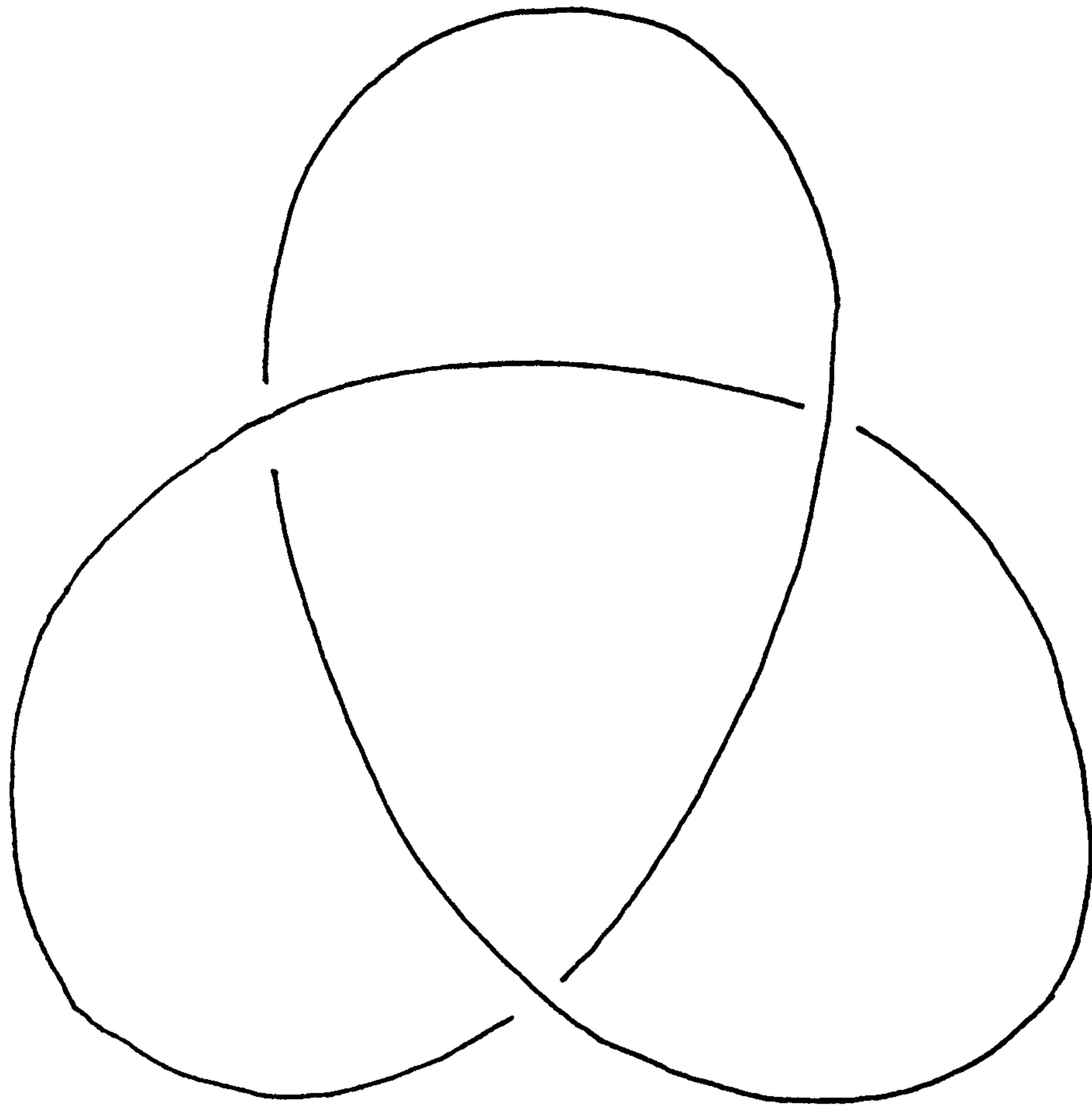



The imaginary 'missing point' closes, as it opens, this line which, in Imagination, crosses itself. This missing point is the missing point we looked for in words. As the mid-point of this Introduction it marks the first point where the real order of deduction and the imaginary order of its frame cross one the other. As such it is the 'origin', root, of the Introduction's closed order of configuration, of its symmetry of opening and closing, just as the 'beginning' of the Introduction is an 'origin' of the order of opening, questioning, and the end of the Introduction the 'origin' of the converse order of closing. This midpoint, as reflection of the frame of questioning-at-large, within the closed symmetry of the orders of beginning and ending, has, as its principle of closure, the imaginary symmetry or equivalence of points where the closed order of the Word is broken. In the three imaginary dimensions in which the imaginary closure is inscribed, the difference of beginning, middle, and end is determined only by the breaking of the symmetry of all points in this configuration by (or 'at', or 'from') some further point outside its closure, in relation to which the local distinction of real break and imaginary crossing can alone be made.

It is in a sense this 'fourth' point outside the closed symmetry of the orders of crossing which is reflected in the three missing points at which the symmetry of this closure is broken. And the identification of this point 'outside' the closure of the configuration of crossing at some point in the order of words, 'before' or 'after' the identification as an actually missing point at this midpoint where the imaginary crossing actually marks such a missing presence in the text, in the words, or 'between' them; this itself defines a dual order in this figure, an open-ness, a duality, a mirror, corresponding directly to the closure of the figure itself. For although 'really' there are three breaks in the line, the 'imaginary' closure of the line 'broken' at these imaginary points of crossing, itself defines, from different 'sides' of this figure in these words, complementary or converse orders of crossing, corresponding to one identical imaginary closure, but 'followed' in a different or inverse order around the closed line\*, just as the closure of the Introduction in which the figure defines a missing

\*That is, the line comes over itself 'out of' the paper in contrary senses, as 'seen' from different sides of the paper 'in' which it is imagined to be inscribed:  corresponds to the 'other side' of its mirror-image, .

point may be considered under two converse aspects, the deduction closing at the end, or the determination to conclude with which this forward order begins. These converse orders of the Figure thus reflect in the closure of the text the symmetry of opening reflection and closing determination, or the converse orders of Thought and Thing, from which this closure of the text is itself abstracted. The 'neutral' real breaks in the line which reflect in the closure of the text the missing point in the order of questioning 'outside' the text, correspond to the real break in the continuity of opening Thought and closing Thing in the finitary punctuation of this closure, this symmetry, of question and answer.

The six-fold (twice three-fold: the two 'sides' of the three 'missing points') image of this missing identity 'outside' the imaginary closure in the Figure of the finitary symmetry of question and answer reflects the multiple open-ness of questioning correlative with the abstraction from the simple complementarity of opening and closing, Thought and Thing, in the closed frame of a particular, a definite, question. It reflects the passage of questioning into itself, in the open-ness thus correlative with the closed symmetry of opening and closing, thinking and its objects, instanced by the finitary frame of this discourse, as of all discourses. The resulting co-ordination of finitary orders of reflection and correlative determination thereby provides a frame for the Question, as I have called it ('What is a question?'): the mirroring in questioning (and the correlative determination) at large of this Question in particular questions itself being the frame from which the finitary order of Discourse is abstracted in each of its particular closures, and which, in this abstraction, it reflects in the several orders of reflection which constitute the dimensions of Discourse's opening and closing, the dimensions of its textual space, and the orders of its deduction, themselves reflected in the orders of determination in that circumscribing World of Things in which it is inscribed, and which it mirrors.

This 'passage of questioning into itself' thus has as its frame (the closure corresponding to the particularity of a question) the mirroring of opening and closing, their symmetry or duality, but the passage of questioning into this frame requires, as it were, a

detour through the closure in which a particular questioning is abstracted from this otherwise indeterminate and unquestionable mirroring. 'Detour': but not really a detour, as there is no 'opening' and 'closing' before the recursion of Question and questions, any more than there is a closure of this text, or of the Figure which reflects that closure in itself, independent of the duality of orders of determination and reflection marked by the 'progressive' and 'regressive' projections of the Mirror marked in this text by that Figure. The distinction between the mirror-orders of Open and Closed is as inseparable from the closure in which they are mirrored, as is this last from the distinction between these two converse orders of closing and the closed frame of the triple symmetry of these two closures and itself. In the Mirror there is a triple symmetry of three orders of crossing (or, equivalently, of opening or of closing). The symmetry of the Mirror is broken in the identification of one of these orders of crossing or closing (or correlative opening) with the symmetry of all three orders - when this last symmetry then 'falls out of consideration', out of the question, itself determining the open duality of the remaining converse presentations of this same closure, this third term which, as frame of the question, has disappeared in the questioning, this Mirror which disappears in the subordination of Fact to Thought in the finitary order of reflective or theoretical Discourse.

The necessary 'detour' of this questioning which first drops out of the question in the mirror of words, in the unquestioned closure of the finitary frame of Discourse, and which only through making this closure the frame of its question can rediscover itself, amounts here to this Introduction to the domain of questioning-at-large, in which, through the words that follow, the question of this very closure of the book proceeds.

The frame of this questioning of questioning which governs the configuration of the book 'properly speaking' (the book between Introduction and Close), the questioning in this instance of 'the Book', of the closure of the Book 'as such', of books, is determined by the mirroring of opening and closing in the Actuality of questions, from which the closure of a discourse is abstracted.

The fundamental symmetry of this frame of questioning-at-large, of opening and closing 'as such' is the symmetry of the modes of breaking this symmetry. It is presented in the closure, which is one of its terms, the finitary symmetry of opening and closing in a configuration of differences (as in these marks) in terms of the coordination of 'crossing' or order which 'in' (or relative to) this closure is 'open' (as its closed frame of questioning), just as this closure is itself presented, within itself, as one side of th Figure, our 'Knot', which Figure itself includes this side (as representing its primary closure rather than the correlative open-ness), its 'first side', in the order of words.

In this sense, the first side of the Figure re-presents in the order of words, in the order of the finitary symmetry of Discourse, of the Book (or its analogues, such as speech, of which more in a moment) the primary order ordirection of closure correlative with our breaking the general symmetry of questioning by entering into a particular question, entering into the closure of the finitary configuration whose closure itself abstracts from, and so breaks, the 'neutral' symmetry of closure-in-general in the frame of questioning-in-general. Within this 'primary' or direct order of the closure of the book, we early identified the coordination of the deductive or 'logical' order (which we will in future denote ' $\lambda$ '), the converse order (primary in the isolation of a fiction) which we associated with the primary order of 'determination' in a 'physical' World of bodies 'outside' the book, in which, as a particular ('marked') sort of body the book is itself inscribed, which order circumscribes it (this order of determination we will denote ' $\phi$ ')...and, as the primary order of closure abstracted from and open to this duality or conversion of words and things, the order of closure of the configuration of questions and answers in their converse movement in the text, a 'poetic' order, rooted in the questions and determinations associated with the mirroring symmetry of logical and physical, deduction and narrative, theory and fiction - this order we will denote ' $\pi$ '. In the simplest or 'elementary' case the correlation or coordination of these orders may be seen in the limit-text of naming or marking itself, in the simple assertion of 'point-ing', 'this', or the simple open-ness of questioning, in which a 'thing' may be taken to mark itself, be remarked: '?', or 'What's this?'.



In these two converse limit cases, 'assertion and questioning, the 'poetic' symmetry underlying the subordination of thought to thing in question, or of thing to thought in assertion, 'drops out' as the third term, the closure of the 'text' which is constituted by the symmetry of this closure itself, and the closures of  $\lambda$  and  $\phi$  which are correlative with the open-ness of the text to thought and thing as its 'terms'.  $\lambda$  here constitutes the minimal 'direction' of Thought, of a thought, towards a 'thing', its closure amounting to the inscription of what 'marks' the thing in the domain of Thought.  $\phi$  corresponds to the 'term' or object of this thought which, conversely to the order of Thought, determines, in the minimal mirror of the mark, itself 'indifferent', this direction of thinking, the thinking 'of' it, as the finality, the 'end' of this direction.. and, insofar as this 'object' impinges on Thought, it itself 'opens' thinking to its presence.

Complementing this elementary 'direct' mode of 'naming', the structure of assertion and question corresponding to the '.' and '?' which were themselves objects of inquiry in the first half of this Introduction, is a converse mode in which the object of the words is not a 'physical' or 'outward' thing, but a correlate of such a thing in 'Thought', as if the name or mark were being used in a converse sense, the directions of question and assertion, opening and closing, being inverted in the 'mirror' of the mark or name, so that in the assertion of the name it is open as to what, if anything, is really, in Fact, being marked, the assertion of the name, the making of the mark, not corresponding to what is physically marked, but rather to what is a sort of minimal fiction, a, or the, thing which might be marked by the mark. The 'direct' order of 'opening' and 'closing' is inverted, and the three orders of 'crossing' which constitute the mirror-image of the 'primary' presentation of the Figure or Knot are introduced into the closed frame of questions and answers, as the 'open' orders correlative with the primary closures of  $\lambda$ ,  $\phi$ , and  $\pi$ .

These three complementary orders represent 'in' the finitary frame of closure the organisation of the complementation of the finitary and discrete symmetry (or order of symmetry) of this frame in the frame of questioning in general. They represent the 'other side' of this general frame, just as they are presented within the finitary frame itself as the 'secondary' or converse order of crossing, and just as the Knot, two of whose three crossings represent the two sides or closures of the triple order including their symmetry, represents the mirror of opening and closing in general, within the closure of the finitary frame (represented in itself as the 'first' side of this Knot). The triple order of these symmetries we call 'co-finitary', since its organisation, although 'infinitary' and irreducible to any finitary scheme of identification within the finitary order of closure (just as the asymmetry of open and closed in the Question which is the frame of this order cannot be reduced to the closure of any finitary configuration of symmetries, and is 'irresolvable' in 'finitary terms') mirrors exactly the triple order of finitary symmetry, just as the open-ness of the mark as imaginary term that covers all real terms, but cannot be reduced to any finitary enumeration of these as its extension, mirrors exactly the closure or determination which is given to it in some particular instance.

Just as we characterised the minimal case of finitary coordination in terms of the mark, so, now, we can give a complementary characterisation of co-finitary symmetry in terms of the missing point that marked, in Imagination, our presence in the first half of this Introduction, and which, as a 'fourth' missing point 'outside' the closure of the Figure, determined in Imagination, or in two converse imaginary perspectives or projections, the dual presentations of the Figure as complementary triple symmetries of crossing.

Mirroring the logical order of deduction in the mark, then, is the order of an actual identity which cannot, in principle, be reduced to any finitary determination, any more than one could close the symmetry of open and closed in the Question in a way that would be unquestionable, leave no opening for further

questioning. Yet (correlatively) there is no point at which the logical characterisation or analysis of this missing point can itself be halted. Any limit, any line by or at which one might seek to express the inaccessibility to deduction of this constant pronomial presence in each step, in every term, of the deduction which it systematically eludes, could in principle be crossed in the finitary, yet unlimited or indefinite prosecution of the logical order of differences in the mark. In the duality of any distinction between marks and that which is marked (as in the radical duality of the closed frame of a deduction and the correlatively open range to which its terms may, within the formal limits set by their coordination in the system of differing marks which is the deduction, apply) there is always maintained an absolute or unlimited complementarity rooted in the absolute or recurrent symmetry or mirror of coordination of Open and Closed, Asymmetry and Symmetry.

The 'elementary' or minimal instance of this complementarity can be seen in the point which marks assertion, '.', 'is', which, in its distribution through every deduction, systematically articulates the mirroring of the logical order and this complementary or 'co-finitary' order of the 'onto-logical', or ontological, the primary closure of which mirrors the opening of the mark '?', which is the logical converse of assertion, as 'what is' or 'that which is'. The systematic complementarity of the two orders embodies this elementary conversion of terms in a duality of interrogative and relative pronoun which organises the principal duality of open question and relative 'clause'.

This 'ontological' order or dimension we denote ' $\omega$ '. The co-finitary order which complements this infinitary or co-finitary order of determination we have already, in effect, identified as the order of Thought and Imagination which, in its continuity 'doubles' the logical order of deduction in thought or imagination, just as the ontological order doubles the physical order which is the finitary converse of  $\lambda$ . It was precisely this 'doubling' of the finitary text in Imagination which enabled us to characterise the 'missing point' as the break in the discrete order of assertion where the continuous 'distance' from Thought to Thing 'crossed' in an imaginary dimension which 'doubled' it

the 'real' order or line of the text. The 'open-ness' of the text at such a 'missing' point (corresponding to the finitary unity of the 'sentence' between two points of assertion with some definite content and extent, as to the 'clause' within the sentence, to the group of sentences, and so on - and corresponding in the limit to the point of question or assertion in which the two orders were imagined to coincide) marked by a broken line in the Knot is complemented by the continuous closed line which crosses it in imagination. This continuous line, doubling in Imagination the order of the text, as its 'terms' double the terms of the finitary orders of  $\lambda$  and  $\phi$ , is itself 'broken' at points which 'double' the real breaks which are the beginning and end of the text. These breaks in the symmetry of the closed circuit which corresponds in Imagination to a 'presentation' of the Knot correspond to the 'missing point' in the imaginary order which doubles the 'real' order of the text:

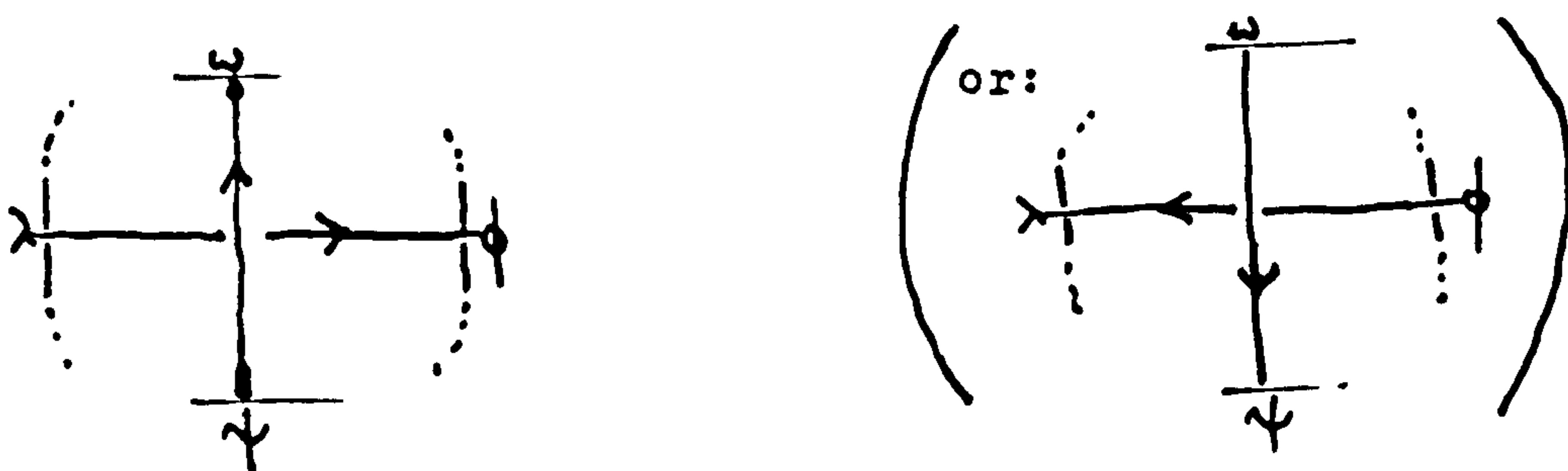

' $\psi$ ' denotes the 'psychical' or 'psycho-logical' order, whose closure complements  $\phi$ , just as the closure of  $\omega$  complements  $\lambda$ .

Just as ontological identity or being, 'is', constitutes the infinitary limit which the finitary analyses of the logical order cannot in principle determine, but whose order of determination they mirror without any definite limit in unlimited approximation, so does the 'missing point' at which our thinking is present 'here' and 'now' in the text, as in its 'world' defined by the primacy of  $\phi$  'outside' the finitary closure of the text, in which the physical order of the text is inscribed, constitute a limiting presence in the bodily or physical order which cannot in principle be 'physically' determined (since there could be no 'physical' determination which could decide which of two 'here's or 'now's was actually here and now, or which body is in fact my 'mine'

rather than your 'mine'). The same principle of unlimited mirroring relates these orders of Body and Mind as relates the orders of  $\omega$  and  $\lambda$  which they double; in particular, there is that perfect complementarity of 'real' and 'imaginary' which, rooted in the conversion of what is marked or remarked into what might be so marked or remarked, enabled us to effect the transition from the triple symmetry of the 'real' finitary order to the mirror image of this in the 'imaginary' order we are now identifying.

We have remarked the incorporation of these two pairs of converse orders in a structure or figure of 'crossing' which constitutes a representation within this Introduction of our presence in it. We noted that the continuous interval, the imaginary distance, between the 'missing point' (or points) of  $\psi$  and  $\omega$ , 'broke' the imaginary progress of the order of marks it doubled, just at the point in the text where it was present, and that the quality of the two orders, finitary and co-finitary, was expressed by the open break in the finitary order of the text that mirrored the continuity of Thought and its Object at that very point, and, in the elementary limit by the imaginary coincidence of the two orders in the point of assertion or question. But we left indeterminate the relations between the missing points as 'terms' of  $\psi$  and  $\omega$ , and the 'terms' of  $\lambda$  and  $\phi$  in the real breaks which mark beginning and end of the text. Nor have we indicated, except by a mark of direction (an 'arrow') extrinsic to the symmetry of the figure of crossing, the relation between the 'terms' and the 'order' or 'direction' of the various orders. Nor (which will be seen to be equivalent) have we made any attempt to coordinate all these as yet independent factors within the symmetry constituting the finitary closure of the text ( $\mathbb{N}$ ), nor have we as yet introduced the co-finitary complement of this closure, which would mirror the way in which it broke or breaks the Symmetry of Open and Closed at large, in this general Symmetry of which the breaking associated with finitary closure is one term, presented within this primary closure as the 'first' presentation of the Knot.

It is to the coordination and consequent resolution of all these questions that we now proceed.

We saw in the first half of the Introduction how the 'doubling' of the logical order of marks in Thought was somehow associated with an initial disruption of the 'poetic' symmetry of the closed order of the text - in Imagination - which corresponded to a complementary disruption of the imaginary continuity of Thought in its real implication in the discrete order of assertion and question. This coordination is illustrated by a 'completion' of the figure which presents the 'line' of the text 'crossing itself in Imagination':

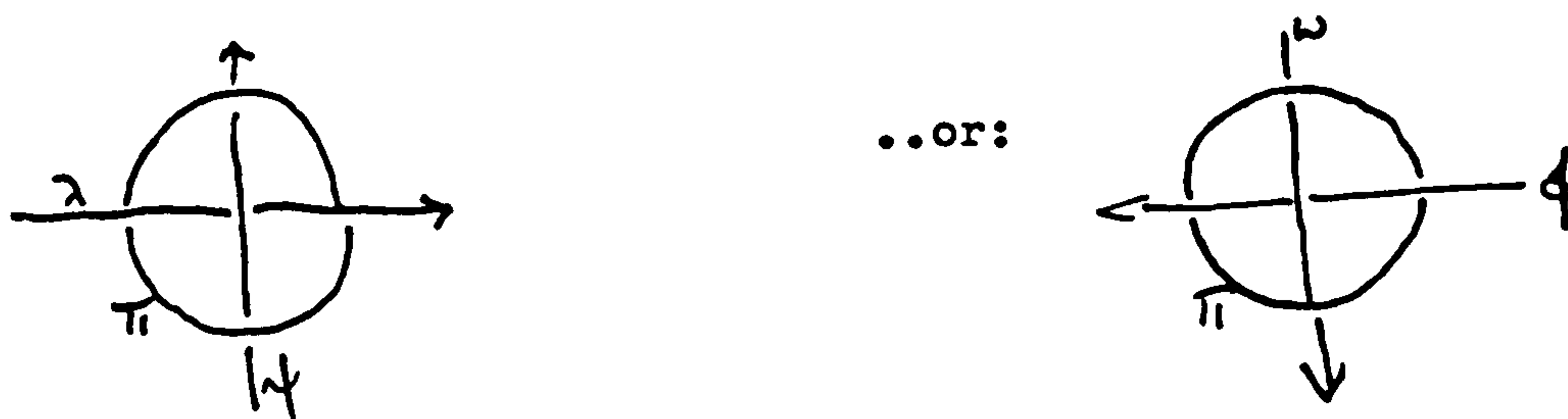

- The transposition of the order or line from finitary to infinitary orders amounts to an inversion or conversion of each of the points of crossing. In Imagination, in the imaginary continuity of the line, 'missing points' are seen, as it were, from the 'other side' of the figure - corresponding to the complementarity of 'open' and 'closed' in real and imaginary or finitary and co-finitary orders that we have already noted as the fundamental principle of this complementarity. This transposition also corresponds in this figure to a rotation of the line. Indeed the two figures may be reduced to a common figure expressing the coordination, in the symmetry of  $\pi$  and its breaking, of these orders, and we can further simplify the matter by replacing  $\psi$  and  $\phi$  by ' $i\lambda$ ' and ' $i\phi$ ', indicating the imaginary 'doubling' of these finitary orders:

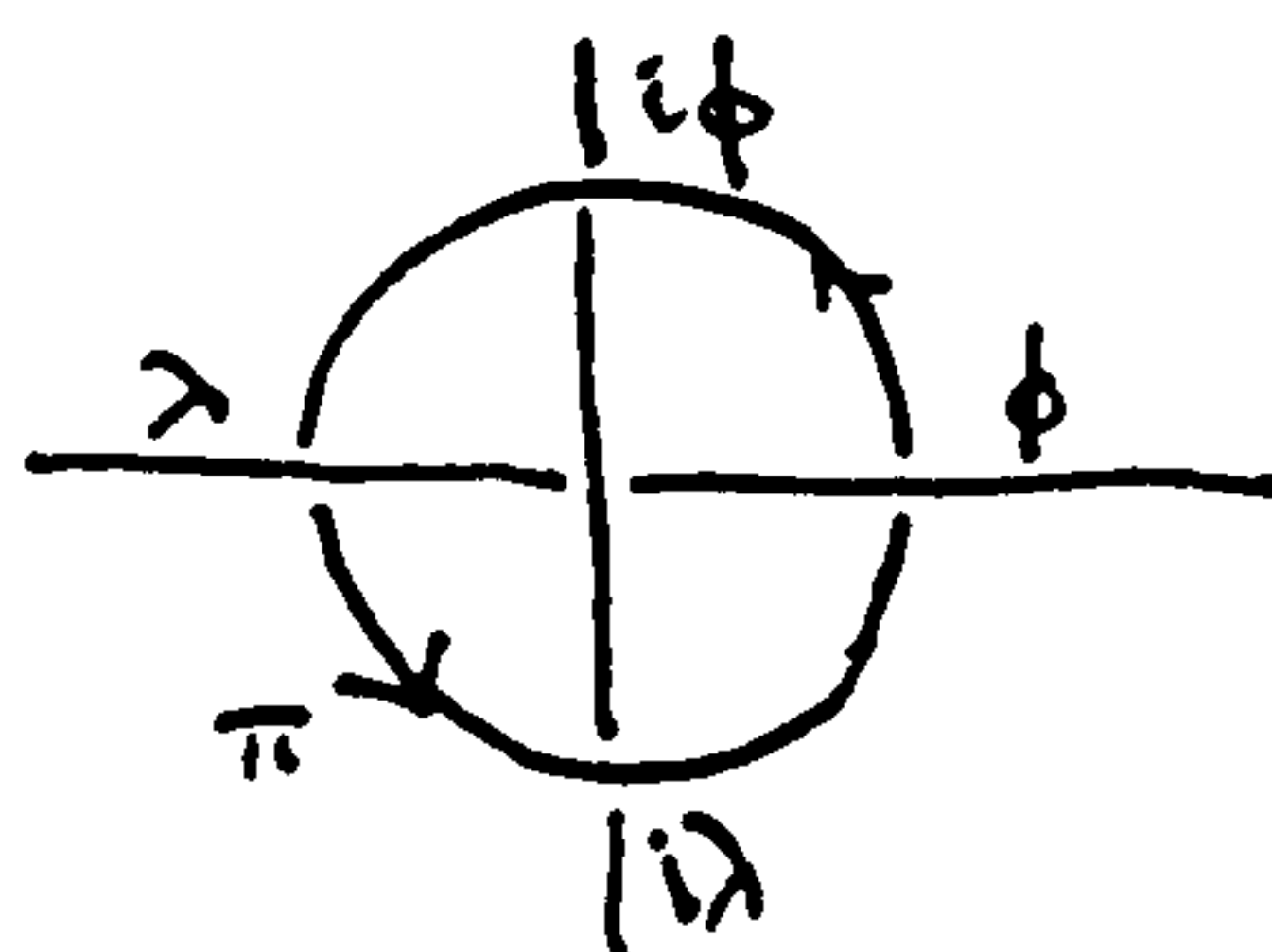

- For it will be seen that the 'doubling' in the previous figures amounts, in each case, to a 'rotation' of the converse finitary orders in the same sense, corresponding to the transposition from 'real' to 'imaginary', from this side to 'that' side of the paper, as it were.

In these figures the 'opening' of  $\pi$ , corresponding to the logical order of the words, corresponds to a break in  $\lambda$ , the imaginary correlate or double of this order, corresponding to the entry of Thought into the imaginary closure of the text, this last abstracting from the symmetric orders of  $\lambda$  and  $\phi$ , and their 'doubling' in Imagination. In Imagination the missing point, the 'cross' marking the coordination of real and imaginary orders at an imaginary 'point' in the text, forms as it were a limiting contraction of  $\pi$ , in which the coordination of real and imaginary orders is lost.

This essentially local aspect of the coordination associated with the last figure is reflected in various questions it does not resolve. While characterising the imaginary missing point of coincidence of real and imaginary orders as the minimal 'term' of the poetic order, it abstracts from the question of those 'terms' of the logical and physical orders, and their imaginary correlates, which appear simply to be 'outside' the closure of  $\pi$ . We might try and correlate these by circumscribing this first 'term' of  $\pi$ , and the configuration it implies, with another circle which would 'double' the first, as its imaginary 'other side':

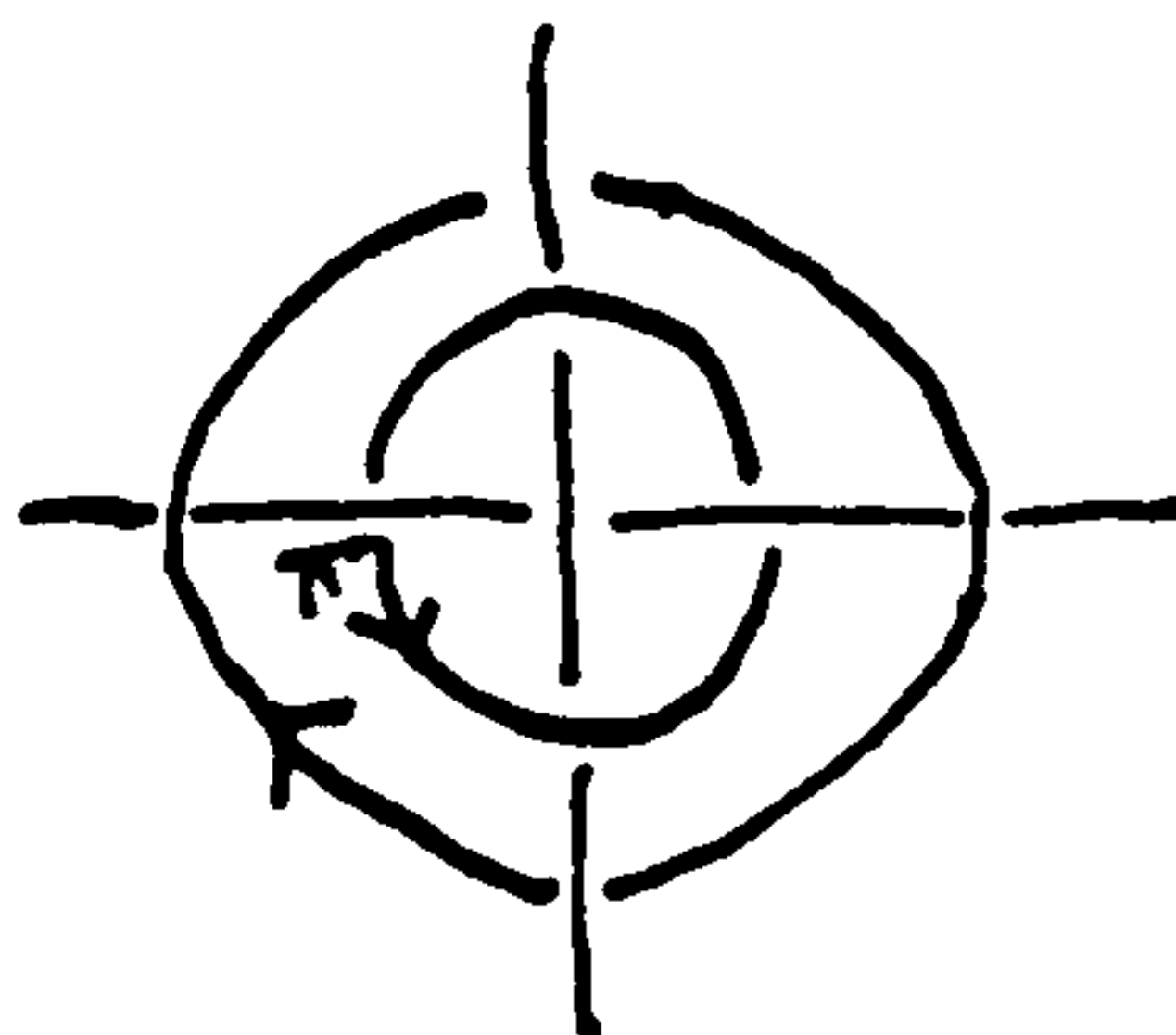

.....But can we really make any sense of this new figure? On which 'side' are the 'real' and 'imaginary' axes of the figure where they intersect this 'other side' of  $\pi$ ? It seems as though this missing point of intersection, in each case, has to mark, like the central crossing 'this' side, the same dynamic of meeting of 'real' and 'imaginary', this and that. In fact it will be seen that, in effect, all four points must be considered to be one missing point, which is somehow both 'this' side and 'that' side of the central point or 'first' term of the figure. The inverted direction of the circuit or rotation, corresponding to a reversal of the representation of the 'other' side by a rotation on 'this' side, marks or requires a rotation of axes at the point of crossing which mirrors, but in a quadruple image, the central 'rotation' defining the symmetry, and the closure, of  $\pi$ . This conversion, or attempted conversion, of  $\pi$  amounts, in effect, to a reflection of the central point of coincidence of real and imaginary, defining the poetic 'term', in the closure of  $\pi$  itself. Opposite 'points' of the outer circle are identified, and the rotation which corresponds to the central rotation associated with the closed circuit of  $\pi$ , rotates the configuration of crossing just as it is rotated at the central point.

What are we to make of this 'fiction' required by the figure? For the converse of  $\pi$  would appear to correspond to an imaginary point at the limit of the figure, which is at both sides at once. ...As if the figure should be inscribed on a closed surface, like a sphere, where our missing point would constitute another 'pole' of the figure, both reflecting our initial point, and yet somehow identical with it. For the complementarity of  $\pi$  and this converse corresponds to the complementarity of the asymmetry and the symmetry, the closedness and the open-ness, of  $\pi$ . What is open in relation to this figure as imagined traced on a closed surface, rather than on the 'open' surface of these pages, this paper, is just the question of which side of the closure of  $\pi$  'we' are on. And there is no way, except through an extrinsic determination of the 'locality' of one of the points, to decide, from the symmetries of the figure, which side is which... which of the 'poles' of our imaginary sphere is this one, and which is 'both', corresponding to the 'missing' point which is the co-finitary mirror of the indifferent mark of  $\pi$  in



which the terms of  $\lambda$  and  $\phi$  are mirrored in the closure of the finite text.

The extension of our initial figure which we have tried to describe also requires that the open axes in which 'real' and 'imaginary' orders are considered to be indefinitely extended 'outside' the closed text which abstracts from the symmetry of their common open-ness, are actually 'closed' at (or 'in') this missing point, which thus stands outside any finitary inscription just as the 'term' of the ontological order stands at an infinite remove from the terms of  $\lambda$  or of  $\phi$ , which it 'mirrors' or 'doubles' respectively. The impossibility of inscribing the mirror of  $\bar{\pi}$  within the finitary determinations of this poetic order reflects, like the impossibility of reaching 'what is' through a finitary configuration of differences, just the contradiction implicit in trying to give a finitary circumscription, to 'close', the infinitary Question, to abstract through a closed configuration of questions, from the radical open-ness which in each question mirrors or complements its frame, the exclusive range of its questioning. This underlying complementarity of open and closed, which constitutes the Mirror, also demands the mirroring of 'mirror' orders, such as the ontological and the logical, in the absolute symmetry of their common questioning. This symmetry is now further characterised in terms of the mirroring in the closure of  $\bar{\pi}$  of the order of the Question.. the question of 'How can there be any difference between the two sides, between the 'inside' and 'outside' of a text? What is the open-ness of this closure in general, what is a question? And how can one ever introduce into the symmetry of this difference actual differences subject to questioning; how can a 'question' be decided, by an 'I' to whom it is open?'

This question may be expressed in an equivalent manner if we try to 'double' or 'convert' the symmetries characterising  $\pi$  by the direct introduction into our figure of the 'missing point at infinity' as follows:

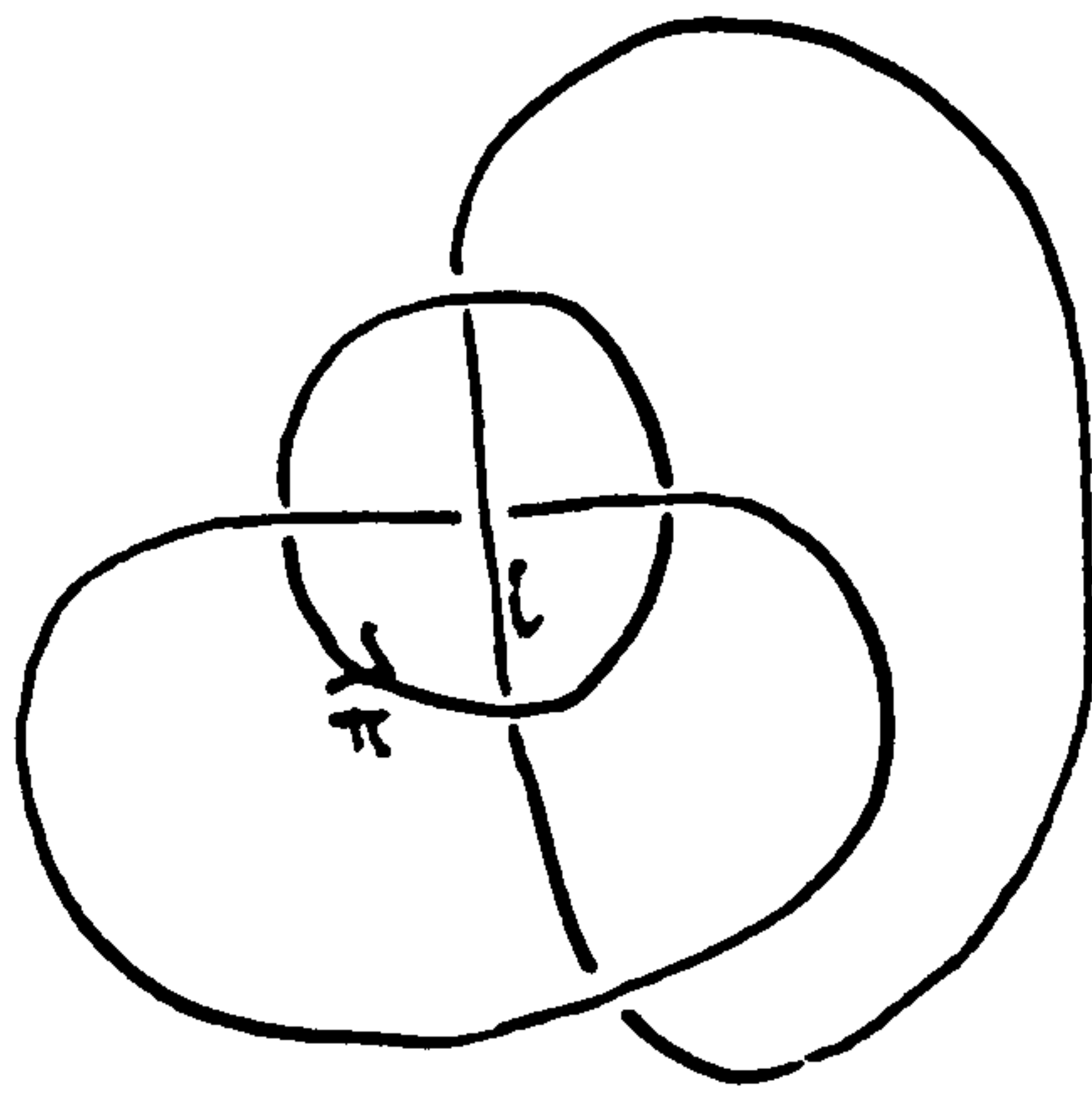

The lower circuit here corresponds to the infinitary closure of the logical (or physical) order (the difference between these, as already in the earlier figure, being abstracted from - as a difference in direction or orientation in the common configuration in which their converse orders mirror one another - in the finitary symmetry of  $\bar{\pi}$ ). The 'other side' of this circuit, its imaginary double, is represented, as before, by the rotation corresponding to the transposition of a real order of succession into an imaginary distance at each point of this succession.

These infinitary closures then cross at what amounts to a 'reflection' outside the closure of the text of the point at which 'we' are in the text. But now we must take the point(s) of passage from 'inside' to 'outside' the text as effecting a 'conversion' from one 'side' to the 'other' of the figure, and we find, working through the 'logic' of the figure, that  $\bar{\pi}$  must be its own converse. For example we might 'label' the orders of symmetry involved:

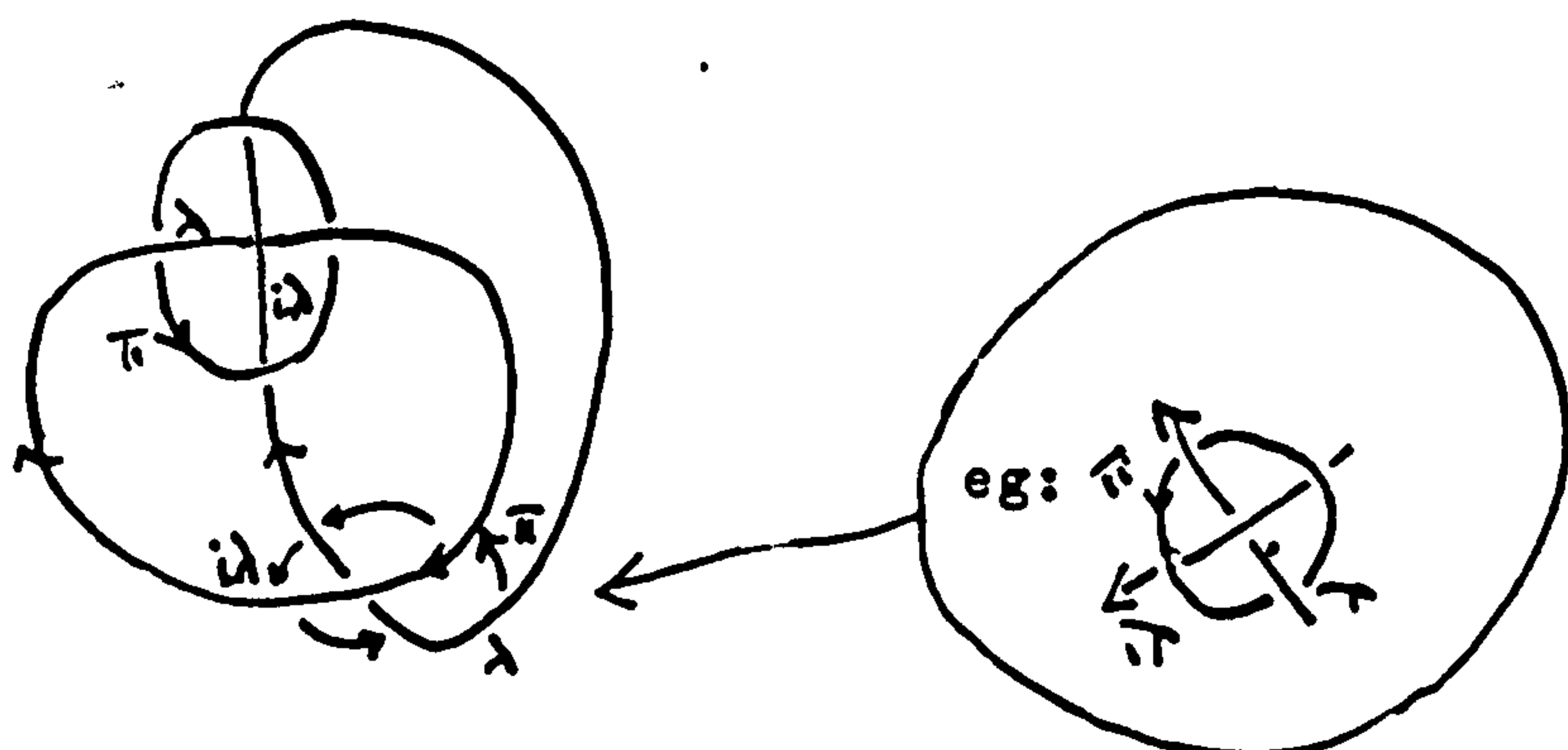

....Well, almost its own converse: the sense of rotation has changed, and to make the figure coherent, one would have to make the 'other side' of  $i\lambda$  to be  $\phi$ , or the finitary converse of  $\lambda$ .

Now we might just as well have completed our initial figure with the lower circuit crossed by, rather than crossing, its transposition:

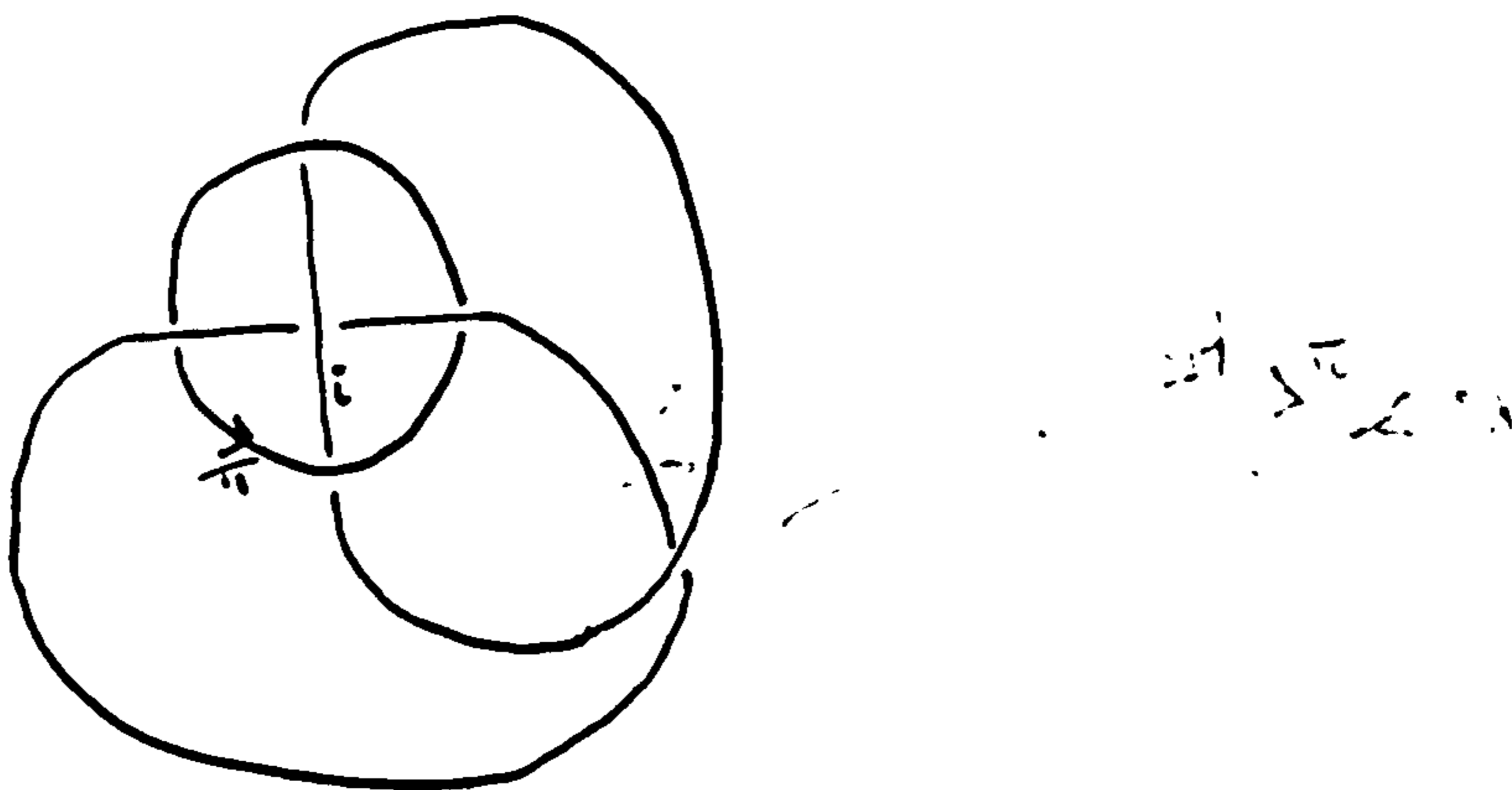

- And now it may be seen that  $\pi$  is also (and this more strictly) its own 'double'.

The relations between these two putative 'completions' of our initial figure express, in effect, just those symmetries between 'inside' and 'outside' the text by which  $\pi$  is abstracted from the open complementarity of  $\lambda$  and  $\phi$  in the first place. The 'missing point' at infinity is in the first case 'on the other side' of the text, in the second case, 'on the same side'. Again we see that we cannot decide, simply in finitary terms, between a text which inverts the true order of things in a fiction, and one that actually repeats this order. 'Where are we?'..are we in the text or outside the text: here we find again the symmetry of truth and fiction in the text, corresponding to its isolation, its closure, its abstraction from the indefinite Actuality of the mirroring of Open and Closed in fact, with which the Introduction began. The missing point which would be the infinitary reflection or complement of the open question which radically marks the poetic order must be

both of the points of crossing 'outside' the poetic order at once. 'This' side and 'that' side. And we now see that the 'imaginary' doubling and conversion of finitary and co-finitary in which we sought to define the co-finitary order as the mirror of the finitary order - mirror in both senses:

doubling, as  $\psi$  doubles  $\lambda$ , and conversion, as  $\psi$  is the co-finitary 'conversion' of  $\phi$  - that this 'imaginary' order was a secondary determination of the co-finitary order, as it appeared in subordination to the finitary order, inscribed within its figures.

This circumstance may be directly associated with the abstraction from the actuality of questioning in general, in the attempt to represent the configuration of this more general order within the finitary closure which is one of its terms. For in trying to express  $\pi$  in relation to the point of coincidence of its two sides, in relation to its own 'term' - 'in its own terms' - the symmetry of  $\lambda$ ,  $\phi$ , and  $\pi$  as all finitary has 'dropped out' of consideration, leaving us to try and reconstruct the ternary order of their common finitude from the binary order defined by the breaking of the general ternary order of Open-Closed in which this breaking into the finitary order of the text is one of two complementary forms. As was noted earlier, in discussing the symmetries of the Figure or Knot, in this breaking of the ternary symmetry of questioning-at-large, the ternary symmetry of its finitary term also drops out of the question, and we are left trying to characterise the closure of  $\pi$  in terms of the binary symmetry of  $\lambda$  and  $\phi$ , corresponding to the two finitary 'sides' of  $\pi$ . Having unquestioningly broken the symmetry of Open and Closed in general, in entering, breaking into, the finitary order of particular questions without questioning the frame of such questioning (it could not be otherwise), the question implicit in its closure, the closure of this finitary order, which in this closure drops out of the question, appears as an indefinable paradox. The closure of  $\pi$  being constant, invariant, 'in'  $\pi$  (this invariance, indeed, itself defining this 'in') cannot be defined in relation to, in terms of, the 'term' which marks what it is to be 'in' the text, in the order of  $\pi$ .

This 'paradox' necessarily appears as the question of the 'term' 'at infinity' which mirrors, in the general symmetry of Open and Closed broken 'in'  $\alpha$ , that symmetry ( $\alpha$ ) of the three finitary orders which itself is the third term which 'drops' out of the questioning determined by its closure as unquestionable frame of questioning. Whereas the binary symmetry of  $\uparrow$  and  $\downarrow$  which constitutes the 'open-ness' of the co-finitary order can be represented in  $\alpha$  as 'imaginary' correlates of its binary open-ness, the ternary symmetry of these two imaginary correlates and their symmetry together, the imaginary correlate of  $\alpha$  itself, cannot. It appears as the missing point which would constitute the locus of determination of which side of the closure of  $\alpha$ , finitary or infinitary, 'we' are on...

...But when we try to imagine being on the 'other', the 'imaginary' side, of  $\alpha$ , we find that we have no way of deciding between the two sides.

Now, in the definition of the ternary symmetry of Open and Closed, of questioning-in-general, which marked, in a circular manner, our formal entry, while 'in' this text as one of its sides, into this order of symmetry of its two sides (represented in the text by the two 'sides' of the Knot) we have already confronted (in considering how this more general order 'presented itself' in 'this' text) the configuration of words and Figure and text which reflects just the problem of determining 'in' the text its general complementation, which we have so far been attempting to resolve in this text considered in its unquestioned isolation from its actual context.

In purely finitary terms, the Knot has only one side: there is nothing in fact 'behind' the imaginary points of 'crossing' corresponding to an 'other' side. The three 'missing points' which correspond to the imaginary closure of the Figure are themselves correlates of a fourth missing point 'outside' the closure, on the 'other' side from the three missing points in the Figure. It is this fourth point which decides 'which side' of the figure 'we' are on. In terms of the Figure 'itself', 'really', this 'fourth' point is on 'both' sides and on neither. It corresponds, precisely, to the co-finitary correlate of the poetic 'term', which correlate organises, in relation to its finitary expression, the symmetry of Open-Closed.

in general just through (or by) marking within that symmetry or order, how the correlate or complement in this symmetry of the 'poetic' term constituted the break into finitary closure, marks itself, in finitary terms, as missing.

This 'missing' point marks itself first, in relation to the 'direct' order associated with the 'inside' of poetic closure, as imaginary correlate of the point identified in this direct or primary order as 'this' side of the Figure, marks itself (that is), as 'behind' the three 'imaginary' points of crossing, constituting the pure fiction of an 'other' side which itself allows the organisation of an 'imaginary' order in the subordination of this fiction to the identification marked by the 'term' of , and in particular by the term which appears to represent itself as 'this' side, by an initial abstraction from the 'fictional' or imaginary symmetry of two equivalent 'sides'. (Here we have already, in outline, the configuration which leads to the primary paradox associated with the 'dropping out of the question' of : the lack of any principle to give any substance to the difference between 'this' side and 'that' side, within and without, that closure which we feel we must indeed be 'within' in order even to understand the question of which side we're on.) When, however, we actually find ourselves on that 'other' side of the Figure, we find (of course, since the 'missing points' of crossing are really missing from the Figure) that we are rather on another 'this' side, which does not quite correspond to what we imagined.

Thus, let us consider the finitary symmetries as presented in the first image of the Knot:

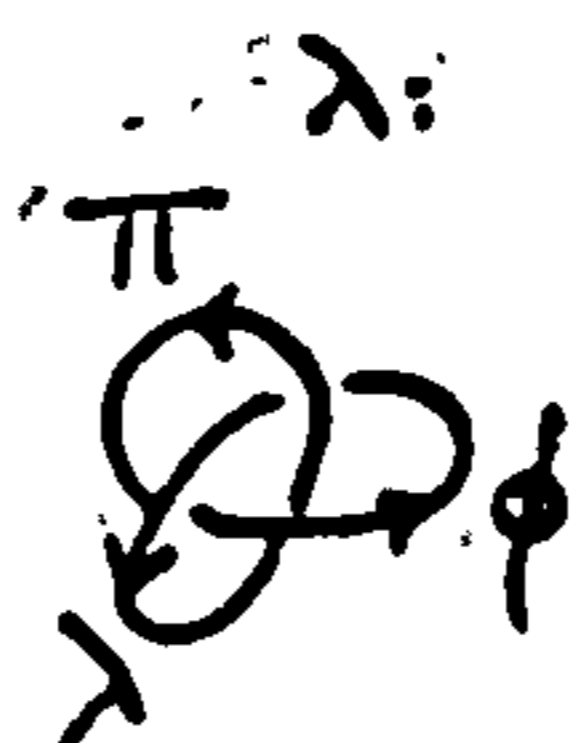
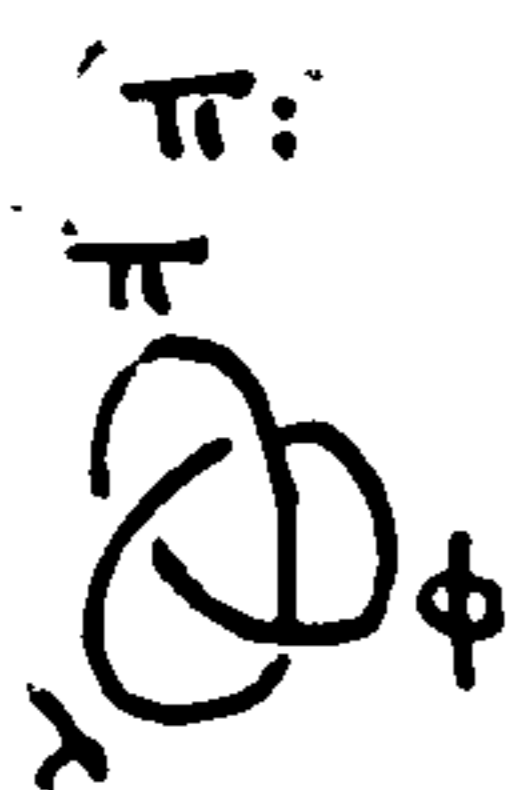

If we take the figure corresponding to the logical order,  $\lambda$ , and 'turn it round', we may imagine we find:



- which, as we see before attempting to define in detail the new order of crossing, exactly corresponds to the order of  $\phi$  'on the other side', being the 'same' Knot with the crossing 'coming out of' the paper in an anti-clockwise sense, but with the converse direction 'around' the crossings, with the converse 'order'. It will now be seen that this corresponds to none of the Knots which are 'really' on the 'other side' of the paper, since all of these (see the verso of the previous sheet) 'come out of the paper' in the reverse sense.

If we now remember the 'doubling' of orders discussed in relation to the missing point as principle of correspondence of finitary and co-finitary orders, then we may label this figure:

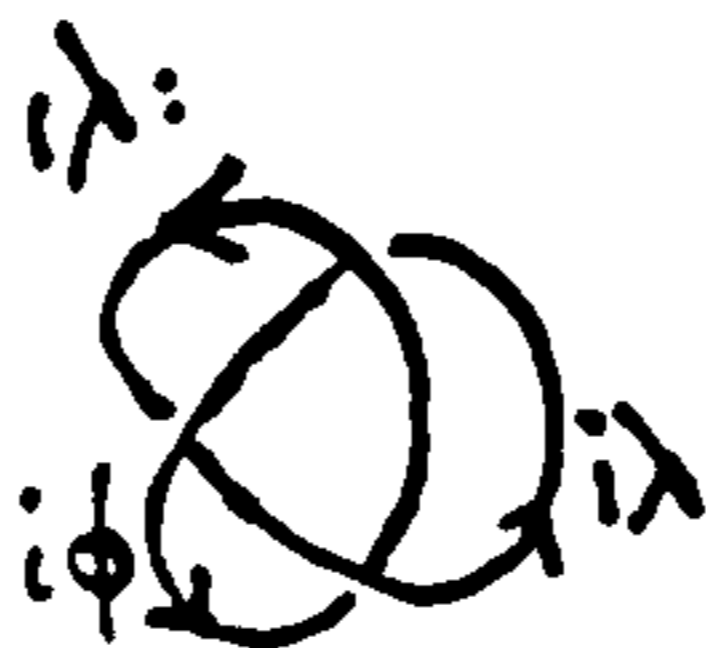

- Since the imaginary correlate of each finitary order corresponds to the limb of the Knot 'on the other side', imagined broken in being crossed, this side, by the limb to which, in Imagination, it corresponds.

Now, it will readily be seen that the correlate of a crossing, a disruption of the symmetry of one order by another, in the rotation of the Knot which corresponds to the Knot 'imagined' from the other side, is just what we called its 'imaginary doubling'... whereas the 'real' correlate, seen really from the

other side of the figure imagined, 'taken' in Imagination - from 'this' side or 'that' - for a closed circuit crossing itself - a knot - is just what we called the 'imaginary converse'.

It will also be readily seen that we could express all these permutations of symmetry within the imaginary closed frame of  $\pi$ , taken simply 'in itself' for a closed circuit with two converse directions, were it not for the question of a converse of this closed circuit itself, in abstraction from which it cannot be imagined to be closed. Or if imagined simply closed, cannot be imagined in any sense to 'cross' itself. For we can certainly insist upon the equivalence of mirror-images (converse knots, 'left-handed' and 'right-handed') when they are given different senses of rotation, a different 'orientation'. But we need to be able to abstract from such converse orientations (corresponding, for example, to  $\lambda$  and  $\phi$ ) in order to define the ternary symmetry of  $\pi$  itself. And, in this abstraction, we find there are implicit two analogous orientations of a different order, corresponding to a symmetry relative to our 'fourth point' outside the closed circuit, and correlative with two complementary ternary symmetries, depending upon 'which side' of the closed line it (this 'fourth' point) is on.

We can then see that our initial attempt to characterise the co-finitary order in general, including the complementarity of its 'open' binary symmetry of  $\psi$  and  $\omega$ , 'doubling'  $\lambda$  and  $\phi$  in the converse finitary order, and its 'closed' ternary order, amounting to the symmetry of the two 'binary' poles along with the third term that in this attempt had 'dropped out' (mirroring in this the way that the third finitary term,  $\pi$ , had 'dropped out' of the frame of our questioning) had involved the characterisation of the binary co-finitary symmetry of  $\psi$  and  $\omega$  in a negative, subordinate or secondary way (in relation to the closed frame of our questioning) as 'imaginary' - as the 'other side' of a primary closure that was 'this side', real.. the 'text' itself. This has led us to a recognition that the 'imaginary point' defining the 'other side' is in a sense prior to the breaking of the symmetry of the two sides of our 'Mirror', in which (a) 'this' side could be identified. A recognition that, complementing the finitary closure of the configuration of real and imaginary orders in the text, there is an



order first characterised as the 'imaginary' (as 'outside' the circumscription of any finitary order, and, in particular, the order of words, of the indefinite extension of the text) locus of distinction of 'inside' and 'outside' the finitary configuration of the text - fictional or actual, 'imaginary' or 'real'. A 'co-finitary' order which, equivalently, was organised around the 'missing point' that mirrored in the general symmetry of Open and Closed the elementary mark of the finitary poetic order, but which could not be inscribed as an imaginary double within the order of such marks. For the co-finitary order itself defines this very 'within', as it defines the two 'sides' of the Knot in relation to points 'before' or 'after' it in the finitary order of words.

It will perhaps be seen how this radical principle of closure of the co-finitary order corresponds in a way to the figure of the Question - the principle of resolution of the absolute symmetry of Open and Closed that is itself one term of this general symmetry, mirrored in, or complemented by, the principle of finitary closure. It also corresponds to the infinitary Actuality common to the infinitary closure or resolution whose two 'sides' (corresponding to  $\lambda$  and  $\phi$  as the two 'sides' of  $\bar{\pi}$  in the finitary order) are the 'action' in which  $\omega$  is subordinate to  $\psi$  in 'my' (or your, or his, or her, or their) 'closing' or resolution of the finitary symmetry of a particular question, and the actual asymmetries to which such action is 'actually' subordinate - what is actually the case... where, for example, and when, I am.

More generally, it may be seen that this order of 'actual infinity', present by its systematic absence in or from all finitary determination, all distinction of 'this' side and 'that' side of any finitary closure, yet in 'that' absence defining the 'thisness' of all finite determination - it may be seen that this (or 'that') order constitutes, with its complementation or dual order  $\bar{\pi}$ , what is 'open' in the intermediate 'indefinite' (rather than 'finitary' or 'infinitary') order of 'questioning at large' of which the Knot is the reflection in the closure of  $\bar{\pi}$  (which last -  $\bar{\pi}$  - is itself one of the terms of the radically 'indefinite' order it thus mirrors). We have associated  $\bar{\pi}$  with the 'first' side of the Knot, embodying the symmetry of  $\lambda$  and  $\phi$  as its two converse orientations. In a sense (considering the figure simply as closed, without relation to the question of

the 'missing point'), these two orientations of  $\pi$  are themselves equivalent to the 'left-handed' and 'right-handed' presentations of the Knot, since without relation to any 'external' point - simply in relation to the closure of  $\pi$  - the one-dimensional orientation of the Knot is equivalent to an orientation relative to the 'fourth' dimension of the external 'missing point'. In relation to this closure of  $\pi$  abstracted from the infinitary actuality of this 'fourth' dimension (which is then considered as an imaginary correlate of the three dimensions of its finitary configuration) we can consider  $\pi$  as the Knot considered simply in terms of the symmetry of its two 'presentations', and express the infinitary order implicit in the actuality of this distinction in terms of two imaginary correlates of these converse presentations - their 'other sides' in a rotation of the finitary order within the three finitary dimensions of its space of configuration. But we find that in such an attempt at a finitary characterisation of the orders of question within the finitary closure of  $\pi$ , we find another order that mirrors the configuration of such an attempt, without (and this precisely because of the radical character of the mirroring, which repeats as a question the breaking of symmetry by which we enter into the closed order of  $\pi$  - questions the closure, the finitude, of  $\pi$  itself) itself having any coherent place 'within' the symmetry, the closure, of  $\pi$ . We find that at some point the closure of  $\pi$  must itself be subordinated to the presentation of the indefinite order as mirroring itself in  $\pi$  as one of its terms. And this Actuality of the symmetry of Open and Closed in the Question, and in the question of the closure of  $\pi$  which reflects this Question, is seen to correspond to the 'fourth' dimension of a point missing, as infinitary correlate of  $\pi$ 's 'mark', from the finitary order of  $\pi$ . And it is seen that the primary expression, in this text, of this 'missing point' is as really, actually on the 'other side' of the Figure when we are on 'this' side, and there organising a ternary 'co-finitary' symmetry, represented by the actual (rather than the 'imaginary') other side of the Knot... And that in the sense it gives to this presentation, it must be considered to be 'actually' on both sides of the Knot, and that its presentation as the 'other' side reflects precisely the primacy of  $\pi$  within just that closure of this text, as of all texts, of which it must first appear as unquestionably 'this', primary, side.

That is: within the finitary configuration of these words, finitary and co-finitary orders are reflected as 'this' side and 'that' side of the Figure which represents itself within 'this', as one of its sides, as the Knot whose three elements are itself and its two 'sides', as here presented within one of them, 'from' this side. Thus far we have approached this radical symmetry of the Mirror Itself, which defines in its own terms the closure of the text in which it has thus far been negatively characterised, from 'within' this text, in which its symmetry is 'already' broken. At the midpoint of the part of the text which is this Introduction, this Entry into the Element of the Book proper (the Word) was signalled as a formal passage into this Element, into the general symmetry of Open and Closed in 'questioning-at-large', through the inscription of this text in that domain as the question, through the correlative open-ness, of its own closure, as our primary access to this domain which, with the question of the closure of the text, drops out of consideration in the initial breaking of the symmetry of Open and Closed (in-general) which corresponds to entry into a text, breaking into words.

In seeking to characterise in words this domain of 'the Word', of which they are themselves the finitary embodiment, we discovered a systematic mirroring of finitary and co-finitary, by which the closure of the co-finitary order which mirrored in our general Symmetry (in the domain of questioning-in-general) the broken symmetry of the text itself in which it could not in principle be identified, expressed the Actuality of the Word as the frame of the Question whose closure, mirroring the closure of the particular questions of this finitary text, is just what is Open in each of these, the principle of their resolution. The co-finitary order of this closure we will call  $\theta$ . From the negative characterisation of the formal symmetry or mirroring of  $\pi$  and  $\theta$ , we must now pass into the positive inhabitation of the Mirror whose closure corresponds to the invisible Knot of the Knot and its two sides,  $\pi$  and  $\theta$ , which we at first tried to identify in the finitary order of  $\pi$  which is itself one of these two sides. We found that the 'other side' of  $\pi$  could not be inscribed in the finitary order of  $\pi$ , and so indicated the Actuality of the Mirror or Word from which  $\pi$ , insofar as it was considered simply 'in its own terms', from 'within', had been unquestioningly abstracted.

## HERE WE ARE

Here we are, in this order of words, and, like them, in this World of paper and ink and reading and writing, of opening and closing of books, and so much else, 'In' the order of words, 'in', involved somehow in, the logical order of their argument, and 'in' the physical order of things, where we are bodily 'outside' the words, and they outside, detached from us, allowing us to enter as we choose into their logical order of which this now is a part - 'in' which this, these words, have their 'sense'.

'In' the order of words - and more particularly, in this instance of it, for the configuration of logical, physical and 'poetic' orders sketched in the last section requires for its coherence (as we there saw) some principle of decision, choice, which belongs to another order, and of which choosing to read or to write, to open and close this book, is an instance.

It is just what decides in this way between the 'inside' and the 'outside' of some instance of the poetic order of words which has been questioned in this instance: this question opens this book, this instance of words, discourse. It was chosen as the opening precisely because it is what must always be open in the poetic closure which formally defines what it is to be 'in', inside (or outside) some words, as we may (or may not) be 'psychically' involved in what they may be taken to express. Any such closure has to be open, and opened, somehow or other. In (or as) this instance a sort of extreme or minimal case has been expressly chosen, so that, in a way, the natural break of continuity which begins the logical order of any discourse as one enters into its words, its closed frame (which makes it 'this' instance of words rather than another, which engages us) in this instance itself appears to partake in some paradoxical continuity of 'outside' and 'inside' the words, some form of communication, a form of communication that is more usually - 'naturally', unthinkingly - excluded from consideration by the very act of beginning.

One might, for example, have begun with something which is in some way 'prior' to the everyday act of opening a book, entering into words. One might naturally think that to ask what it is to be a self is somehow prior to our opening question of who I am. One might think that to ask 'what is a word?', 'what is language?' should in some way be more fundamental than some particular case in which 'I' confuses word and thing (or person). And yet these more 'basic' questions derive their precedence from 'psychological' or 'poetic' orders whose coordination is, as we have seen, in a way more fundamental than (as implicit in) the primary terms (and the correlative primary questions) understood to be at the 'beginning' of these orders. And an irreducible part of this coordination involves the irreducible character of some instance involving various such 'fundamental' orders of questions. More particularly, in the general coordination of all orders of questions, this instance, the question of this very book, and what we have to do with it, is in a radical way primary. Even the question of 'what is a question?' which is 'formally' prior to the opening of the book, is subordinate to the order of questions opened by the relation of closed frame of words to this very opening in the beginning of the book, of this very frame of words, this instance, itself.

To begin with some 'terms', some questions, which are naturally thought to be prior to the opening of the book, being prior in the order of thinking, and to enter into a theoretical discourse independent (or thought to be independent) of its actual expression in words, its actuality, would have involved the initial exclusion (in principle) of any common frame of closed expression and the open-ness of a thinking which it expresses. The initial terms of the inquiry would be constituted in a break into expression, into some 'frame' or configuration of questions, of questioning, which break would then in principle be inaccessible to the continuity of the order of reflection coordinate with, or implicit in, this frame of its terms. The question of the relation or correlation of the frame of expression, and the inquiry pursued within it and governed by its order, could not itself be there 'framed', since the question would already have been excluded by the choice of some

particular frame of inquiry, in an initial unthinking answer (as it were) to the question posed by the open-ness of the closure (of the closed frame) of discourse ('in general') 'to' an irreducible multiplicity of instances, in no definite case of which could it be itself definitively inscribed. The only way to countenance the question of this irreducible character of the instance (which thus 'doubles' the principle of textual closure by abstracting from its very open-ness to some particular determination) is to open with the very open-ness correlative with the formal closure of the poetic order itself, with the question of the 'thisness' of this instance. 'This', then, although a 'case', is not any 'definite' case, abstracted in the closure of its particular frame, and by the discontinuous breaking into it of some thinking. It is just by this wilfully indefinite character of the questioning, a paradoxical circularity in the very framing of the opening question, that this instance may be in a strange way 'definitive'. This last character must for the moment, however, remain very questionable. We must see what we can make of it.

To each of the (six) correlative orders whose coordination we have found to be implicit in this book, in its 'thisness' which constitutes our opening questioning (and its object - and the 'subject' who questions) there corresponds a definite 'priority' (to say which is just as much as to insist upon their common character as 'orders' of questioning or determination). There is a 'physical' priority of the materials of the book, and its material or bodily situation relative to other things (including our bodies) in a physical order of 'space' and 'time' which itself reflects (and is reflected in) the formal 'space' and 'time' of questions in the book (which we have thus far characterised in terms of the 'crossing' in which the 'real' distance (in the time of writing and reading) from opening to closing is doubled by an ideal 'space' as 'imaginary' correlate at each 'point' (defined by this crossing) of the network of coordination we call this 'text'). In the textual or 'poetic' frame of this reflection of a 'physical' order in a converse 'logical' order (whose 'priority' lies in its 'end' or objective of determination which imposes its own coherence on the 'space' and 'time' of the text) lies a yet prior order of symmetry whose first 'term' or element is precisely that 'term' which is supposed to embody the reflection or complementarity of logical and physical orders, without any further determination, and beyond which no further questioning is supposed possible.

This 'poetic' order of the term, which we denote , organises (coordinates, mirrors) the symmetric orders (priorities) of logical and physical determination (' ' and ' ') between its first 'term' - the 'term' itself - and its 'last' term, which is simply the frame of terms, the closure, corresponding to the openness, the essential multiplicity, of 'the term' itself, supposed free of further determination. This poetic ordering or principle of coordination of term and frame is implicit in the very terms which define logical and physical orders. These orders are in turn implicit in the very 'term' of this poetic order: implicit in the asymmetry of terms without which the poetic order would have no content, and without which even the distinction, the separation, between term and frame, the very identity of terms themselves, and of 'term' itself, dissolves.

We have also seen how this 'finitary' coordination of poetic symmetry with the irreducible asymmetry of the 'mirror' orders of logical and physical questions or determinations (from whose 'mirroring' or symmetry the poetic order is, in a sense, abstracted, but as which order of symmetry it is in another sense prior to the constitutive correlation of converse physical and logical orders) itself involves a complementary organisation (which we have called 'co-finitary') whose fundamental principle 'decides' which side of each instance of poetic closure we are on. We saw that this principle of decision, which is itself directly correlative with such an 'I' (or 'we') in each such instance, although it appears only to exactly reflect the finitary coordination of poetic, logical and physical orders in the text, is in principle irreducible to an imaginary 'double' of the text. We cannot insist upon an absolute priority of the 'term', and inscribe this 'co-finitary' organisation 'in finitary terms' in the finitary order of terms, as a secondary reflection of the textual order organised about the term ('I') which 'I' then imagine(s) to be something 'outside' the order of terms, 'besides' all its implications in the finitary configurations of simple terms. Such a 'reduction' of co-finitary organisation through the supposed inscription of its basic 'missing point' (which 'doubles' the 'term' of the finitary frame) in the formal integration of logico-physical asymmetry in

poetic or textual symmetry in a supposed totality of 'all' finitary configurations corresponds rather to an imaginary 'world' as supposed closed Frame of all finitary frames. Although no definite limit can be assigned to the inscription and reflection of its cofinitary mirror in finitary organisation, in this 'world', although finitary organisation cannot be thus definitively circumscribed in any 'more' primary psychological, ontological, or theological order, or in any 'absolute' coordination of these, nor yet can a certain primacy of such co-finitary determinations of Actuality be circumscribed definitively in some supposed coordination of the 'term' simply as such, without further determination, in some correlative limiting frame, 'world', in which poetic, logical and physical might be supposed 'at infinity' to coincide. Nothing in it could decide whether there actually were such a 'world', nor could there be any principle which could differentiate the formally symmetrical orders of logical and physical - or, more generally, the two 'sides' of any definite configuration.

At the same time the co-finitary principles implicit in the actuality of any finitary configuration cannot be altogether abstracted from the movement of incorporation of this principle, through its particular expression in such a particular instance, within the formal frame of a 'world'. In each instance the essential particularity of its 'thisness' involves the inscription of the cofinitary determination which complements any actual finitary configuration (that is - which corresponds or responds to its open-ness as question, possibility) in the movement of circumscription whose dynamic is articulated between the imaginary poles or limits of fully determinate term and fully comprehensive world. The particularity of this actual actuality of this book cannot be reduced to a simple reflection of an absolutely decisive cofinitary actuality which somehow decides that there should be a world, rather than not, and this within it. For the finitary distinction of the two sides of any configuration, the closure of the configuration of such an imaginary possibility correlative with the open question of what 'I' decides, some initial mark, must itself precede such a supposed choice. Just as the finitary term is elusively shadowed by some systematically missing correlate, our 'missing point', around which a whole complementary cofinitary coordination is organised, so does an irreducible finitude reside in this cofinitary organisation.



This reciprocity of finitary and co-finitary in every instance is expressed within the order of this Introduction - in relation to the general frame of questioning in which the opening of the book is made to reflect simply the open question of the relation of 'inside' and 'outside' of the closure which makes it this rather than something else (this - a book - and this book) - in terms of the 'Question', 'what is a question?', and the question of 'which question?'. For there to be any question, anything which is 'open' to (further) determination, there has to be some framing of the question, some exclusion of what is not in question in that instance. More generally one may correlate an 'order' of questioning, in which particular questions are subordinate to the resolution of more 'general' or more inclusive questions, with its 'frame', so that there is a mirroring of the successive determinations of its 'terms' in that subordination of questions to the resolution of other questions which culminates in a 'frame' in which all questions of that 'order' may be somehow or other inscribed. We have already characterised the principle of complementation of finitary and co-finitary in terms of the correspondence of a co-finitary 'term', or the term of a co-finitary order, with a corresponding open-ness of application of some finitary determination. Thus, for example, the 'missing point' around which the co-finitary orders are coordinated corresponds in just this way to what is in finitary terms the open question of just at what 'point' in any finitary configuration or punctuation we actually are. More particularly the 'is' of the ontological order corresponds to the point of assertion in the logical order, the thought of the psychological order to the thing of the physical order. The Question then expresses the irreducibility of the coordination of finitary poetic, logical and physical orders to a purely 'formal' (for so the co-finitary order must be characterised in the finitary terms of this our discussion) coordination of co-finitary determinations rooted in some supposed Actuality in principle prior to and independent of any 'extrinsic' and arbitrary 'mark'. It expresses, for example, the 'unthinkability' of the embodiment of my thinking in my bodily situation in this 'world', and the irreducibility of the

non-entity, Nothing, which makes the being of one thing distinct from the being of another thing. In the formal order to which the definiteness, the definition, of a difference would in principle be subordinate, if the finitary coordination of differences were to be inscribed as a reflection of some absolute inexpressible co-finitary identity organising in the coordination of co-finitary orders the very mirror in which this reflection were supposed to take place - in this formal order there would be no place for the framing of the Question, which itself must correspond to the very frame of the supposed 'mirror' of Open and Closed in which the finitary organisation of arbitrary Fact could be inscribed. The 'mirror' would have to be constituted by the open-ness of which 'side' of some primordial closure was to be taken: but in order to be presented the question must already have been answered, for the supposed closure is itself one of the two 'sides', and the open-ness of two sides the other. Without some extrinsic mark there could be no question of asking the Question, one could make no difference, no distinctions could be drawn, there would be no 'where' in which to draw them.

Thus in any attempt to assert the primacy of the co-finitary order, one finds that the first question which should define the 'origin' of the order cannot itself be resolved. The original identity of self-assertion which would mark the difference of open and closed in the opening of the order is itself lost in the symmetry of open and closed in which it should progressively determine the finitary order as its reflection organised about the identification of the difference between opening and closing with (or 'in') which it closes or concludes. The situation is exactly mirrored in the supposition of a reduction of the co-finitary order to a finitary 'world', whose frame would leave no room for its own actuality, this being 'out of the question'. For there could be no questions if there were no way of deciding what was in question. Until we knew where we were in such a frame, there would be no way of knowing who we were, in order to wonder about where we were.

Rather than trying to inscribe the mirroring of these complementary organisations within one or the other, and so determine one or the other as primary, the mirroring itself being

supposed determined by one side or the other, we found earlier in this Introduction that having brought the complementarity of Question and questions to the question of the 'missing point', the mirroring of the finitary point and its co-finitary correlate could itself be reflected in the Figure which constitutes the midpoint of this Introduction. This figure, in the context of this Introduction, amounts to a reflection within the closure of this instance of a finitary configuration ('its' text), of the coordination of finitary and co-finitary orders around the mirroring of this 'point' and its apparently 'missing' correlate. That is, through the deliberate opening of the Introduction with the question of the relation of its 'inside' and 'outside', with a question simply complementing, reflecting, the closure of the text with no further preconception than that this was indeed a 'text' somehow or other (just 'how' remaining open), the various priorities of the primary orders of determination of this text (as unfolded in the opening questions) - argument, embodiment, frame, thought, being, choice - while they each have their precedence to which the opening may be subordinated within the orders whose 'first' terms these are, are yet in some way dependent, in this very precedence, upon a coordination 'first' directly expressed 'within' this text, a coordination which involves in an essential way the organisation of these correlative orders in 'actual fact'.

It is as though, if we were to have chosen inquiry 'within' one of these orders - a logical treatise, a psychological discourse or whatever - the book would simply have opened in a supposition of coincidence of the closure (the frame) of words and thoughts with the closure of that order's frame of questioning in this instance. The book would open, as it were, in the very middle of the Introduction (as in a sense does this book), with a supposed coincidence of some order 'within' the book, and a corresponding order 'outside', which the internal order would then unquestioningly and unquestionably 'represent'. It is just such an entry into a frame or order of thinking and words that I earlier insisted could not comprehend the transition from 'external' to 'internal' expression - and this in principle. In such an extreme case the Introduction would, in effect, have been

reduced to a mere formality of abstraction from the general mirroring of 'inside' and 'outside' of the order of the book, which should then (in principle) amount to an uncommented formal coordination of a set of terms and their frame, a kind of pure Theory or Reflection, in which the correlation of the open-ness of the closure of discourse in general and the closure of some order, through the choice of an author in this instance, would be supposed to be quite elided. It may easily be seen how such a limit of Theory coincides with a limiting Fiction in which the imaginary frame of an absolute fabrication might be supposed to coincide with a 'world' that, within such a fiction, is taken to be what is 'really' outside it. In such a case the reader who supposed himself in a 'real' world different from that defined by the fiction, and circumscribing it, would be himself or herself inscribed in the fictional world as insane, 'not himself'.

Between the actual opening of this Introduction, and the midpoint which reflects the coordination of those orders which 'outside' this book have an independence reflecting the range from which the frame of the book might have been chosen, the transition (marked by the consideration of the 'point') between the first part of the Introduction and the middle section (concerned with the coordination of finitary and co-finitary in the reflection within the text of their mutual mirroring) marks a point 'where' one might have begun a different Introduction to a supposed coincidence of the frame of the book with a 'theoretical' order abstracted from the Question in the supposition of a formal subordination of facts to some theoretical frame (while yet allowing an intercourse marked by the Introduction with an 'actual' world outside the frame of the discussion, and stopping short of the extreme formality imagined above) - or with a 'practical' order of narrative, abstracting from formal determinations in the supposition of some context, whether real or fictitious, and so taking to some extent for granted the choice of what is in question while yet allowing a certain open-ness to, or intercourse with, thought.

But to what sort of book, then, corresponds this actual Introduction, which begins before any resolution of just what sort of frame it is into which one enters in opening this book?

What is 'reflected' in the passage from our entry into this Introduction towards the point (at the passage into its middle part, 'Mirror') where our opening questioning begins to organise itself around the 'point' as limiting correspondence of the finitary or discrete order of the words or signs, and the 'co-finitary' continuity of our 'imaginary' presence in this order?

We can now see how we might give an 'internal' characterisation of what was going on in that first part of this Introduction, by attempting to reflect and so inscribe it in a 'theoretical' order deriving from the formal identification in the Figure of the Knot of the breaking of an initial 'theoretical' symmetry of Open and Closed in the actual opening of 'this' book, in a co-finitary determination corresponding to a theoretical authority of an Author (instituting the co-finitary order of the 'work') - a breaking of the symmetry of Open and Closed reflected in the Knot, which breaking, as a necessary 'detour' (like the 'mark' or 'sign') itself allows this breaking to be formally defined in terms of a reflection within one of its terms (the closure of the text) of the Symmetry thus broken.

But just as there is no place for the Question in an order abstracted from the finitary frame of its questioning, so there would be no place for the actual breaking into this text within the theoretical or supposed Symmetry of an order in which the breaking into the text could be supposed somehow re-inscribed in the text itself. The formal Authority co-ordinate with the theoretical determination of the breaking of a primary or absolute Symmetry of co-ordination in terms of that Symmetry would leave no room for anyone to actually choose such a subordination of Disymmetry to Symmetry, to choose such a theoretical determination of the initial break rather than a thoroughly correlative ('symmetric') extrinsic determination, by me.

Such a formal determination could itself be inscribed as a fiction, an imaginary closure, within some otherwise 'extrinsic' narrative of what I thought I was doing, by falling, in this world which is supposed to circumscribe all books, into an imaginary identification with the theoretical Author who presides over the entry into theoretical discourse.

Conversely, I cannot merely narrate what has happened, as it should now be fairly clear that neither I nor anyone else could find any altogether neutral or unquestionable terms 'outside' the closure of the frame of this book, no thoroughly independent order, in which to describe the passage into words by which words were found to directly represent the extrinsic order of facts to which they would (in this case) be supposed subordinate. Just as a theoretical or internal determination of the entry into these words would require a formal Authority which is itself in question in this very entry - 'Who am I?' - so would an unquestionably authoritative narrative suppose a starting-point in which the finitary orders of marks coincided to mark a starting-point embodying unquestionable Fact - a simple presupposition of an unquestionable 'World', in which there would be nothing corresponding to Choice in the opening of this book, nothing open in which the opening question could have any sense. I would be simply me, and no question corresponding to the opening of the book would arise. There would be nothing to correspond to the imaginary closure of this text, nothing corresponding to an imaginary 'I', not even any 'me' which 'I' might be. For in such a Frame, 'World', there would be nothing, no way, to actually abstract from the open-ness of its actuality or reality to the closure of this particular frame, text, 'within' it.

What sort of order, then, might adequately correspond to the crossing into these words? What sort of order in which these inadequate theoretical and narrative orders might themselves be inscribed, as the Question and the questions which reflect and question their presuppositions are themselves inscribed in these words?

Formally, such an order must embody the general principle according to which the coordination of orders of questioning within these words reflects the determinations of the closed frame of this questioning, of these words, 'outwardly', 'within' such orders - in fact. This formal requirement amounts to the formal coincidence of theoretical and narrative or factual orders in the frame of the words, and this formal symmetry, amounting to a movement of inscription of co-finitary in finitary, this formal 'side' of their mirroring, with its formal imperative, we may call Law. The three finitary orders we have characterised as  $\pi$ ,  $\lambda$ , and  $\mathfrak{Q}$  may be seen as theoretical

projections of this formal Law, supposed abstracted from any particular instance - elementary components, as it were, of the coordination of the internal constitution of anything in particular and its outward situation, of 'term' and 'frame'. Such 'Law' governs, for example, any account in which the constitution of a thing or group of things is coordinated with its (or their) interactions within some common framework. It also governs the inscription of co-finitary elements in such an account, in requiring them to mirror the coordination of finitary elements in the formal frame of the account; in particular it governs accounts of the relative authority of different accounts, and the answerability or responsibility of the 'author' who is the co-finitary correlate of an account.

In the instance we are now considering, the account we are trying to give within this account (of the relations of this account and its context) of the entry into this same account, there must be some correlate in the world of extrinsic determinations which is its actual context, of the symmetry in this Introduction of its opening and its closing (in these last sections, now), and the framing of this symmetry in the 'Mirror' of the middle section. For this Introduction is closing in a reflection in its order of questioning of the opening question. And the question now, towards this close, is the relation between the finitary internal symmetries of the text and the infinitary external orders they reflect in the closed frame of this text precisely at the opening of the text.

It will now be shown that at this point of entry in which internal and external orders meet in a formal or imaginary beginning or initial point, Symmetry, Law, requires that there should be a breaking of the symmetry of inside and outside whose coordination perfectly reflects the Law, which latter further requires that this opening should be mirrored in the frame of the Introduction in a close which is itself an entry into a narrative with the character of a Story or History which itself closes with the entry into this Introduction - the 'actual' entry, rather than some imaginary point.

## MYSTERY

How can there actually be any questions, any frame of questions (corresponding to the closure, the frame, of the account, the 'story' whose text is inscribed in the domain of Law) is, as we have already seen, a 'mystery'. Within the unlimited configurations of Symmetry, in which any finitary determinations may be inscribed, there is nothing to decide what is actually in question, no way to choose one frame rather than another as 'actual'. Indeed the actual closure of the frame of an account is exactly co-ordinated with the Freedom, the Choice, which as what 'decides' 'between' the symmetry of all possible closed frames (simply as all 'symmetrically', equally, 'closed'), exactly mirrors Law, through the open-ness which complements the closed frame of any question.

Formal constraints are imposed upon what thus 'decides' matters, through the symmetry according to (or 'in') which the open configurations and orders coordinate or correlated with such Freedom are mirrored in Law, in the domain of Symmetry. Thus the co-finitary configurations of what is open to further determination reflect the formal coordinations of the finitary terms whose closed configurations complement this open-ness. In particular, the subordination of finitary to co-finitary through this mirroring is itself subject to the finitary symmetries implicit in the formal inscription of Freedom in Law as 'what is left open'. The Law of Difference, of the Mark, is inscribed in the very heart of Freedom, as the Question, the question of the difference of Open and Closed. The fundamental closure in which the symmetry of Open and Closed appears as the question 'What is a question?' is implicit in the limiting 'theological' principle which decides between or differentiates the converse co-finitary orders of psychological and ontological determination ('subjective' and 'objective') in their shared Actuality. The nothing which is formally opposed to, 'outside', this Actuality, is formally implicit in the actual difference of Actuality and nothing, and though itself nothing, thus coordinates what actually is.



That is: the irreducibility of one of these two complementary orders - 'finitary' and 'co-finitary' - to the other is (in each case) a 'mystery'. For in their mirroring, one the other, through the symmetry or complementarity of Open and Closed, there is no particular limit to the inscription of one order (its mirroring) in the other, while yet this mirroring cannot in principle be completed, in either case, as the very relation of Open and Closed which defines in each case that order of questions and determinations corresponds to the determination implicit in, constituted by, the primary terms or elements of the other order. The primary closure of one order or configuration of orders must in principle remain open, as an irresolvable question ('What is a question?'; 'Which question?'), in the very closure which (as their common frame) is implicit in all the determinations of the other, 'mirror' order or configuration.

It is precisely in the correlative symmetry and disymmetry of these two 'mysteries' that we must look for the order, which we have already called that of 'questioning at large' in which they may together be inscribed. We have already noted that this correlation or coordination of finitary and co-finitary is reflected as the figure of the Knot in that 'side' of the breaking of the symmetry of the two orders of finitary and co-finitary which is itself reflected - within itself- as one side of the Knot. This 'side' is characterised by the representation within it of the two sides of the broken symmetry of questioning-at-large as symmetric. Within this 'finitary' frame the co-finitary order formally reflected in this order as its 'other side', mirror-image, is characterised as what decides, in 'this' instance in which the order is expressed, that this is indeed 'this' instance and that the difference is made, expressed. It is the side which decides that it is the side which decides, but in such an instance, situation, it cannot but choose to thus be the principle which chooses.

Formally, this definition of the co-finitary principle of decision as a pure recurrence, as circular (and so formally 'outside' the linear development of the finitary order) corresponds to our characterisation of the circularity of the Question: in order to decide the difference between Open and Closed, this self-asserting Decision (which alone decides that it is the principle of Decision rather than of Symmetry) must already have decided ('in order') to frame the Question. The principle cannot be introduced as a neutral element: its

introduction makes a difference which is then re-marked.

In the general case (rather than this limiting case in which the actuality of the question as such is in question) this principle of Decision corresponds to the choice or determination of some particular frame of questioning or accounting (determination) from the open range of finitary closure-in-general ('as such'). The Question represents the limit case in which this principle of closure, decision, demarcation, Disymmetry, correlative with the open-ness or symmetry of all closed frames considered simply as closed frames, as closure, is itself formally inscribed within Law, in the dynamic mirroring of co-finitary in finitary. The general case represents in finitary terms the recurrence of Symmetry in the application of finitary symmetries, configurations, in the general dynamic of 'accounting' governed by Symmetry as Law.

'Dynamic'? - Formally this expresses the application, to this general principle of Application itself, of the configuration of terms associated with the circumstance that no particular or definite closed configuration corresponds to the open-ness of finitary closure-in-general, any more than the actuality of Decision implicit in the formal characterisation of the principle of 'deciding' which of 'all finitary configurations' actually applies, can be reduced to some definitive finitary image, representation, or reflection, and inscribed in the formal closure of all finitary closures as (a) 'world'. 'Dynamic': the inscription of every particular closure within further closures, without any but a formal and imaginary limit in 'world' is itself inscribed in the open order of Time coordinate with the closed psychophysical configurations which are one primary expression, one axis, of the reflection of co-finitary in finitary.

- A limiting formal expression, in which the decisive closure of the frame in question is determined simply as the inscription of the formal dimensions of the closed text within an outward 'physical' dimensionality or coordination which it formally reflects. Thus the Knot is taken simply as a mirror within the text of the embodiment of the closed text (which mirrors 'inside' and 'outside') within three symmetric 'dimensions' or orders of physical 'space', and of its formal abstraction from that space (to the 'formal' space of textual configurations) through the open mirror-symmetry implicit in its 'spatial' order, this

reflected in the two 'sides' of the Knot which, like left and right hands, cannot be superposed in this space of physical coordination.

The mirror (the 'antisymmetry'), then, of different orders, 'directions', senses, in this physical frame, whose primary term is the physical point in which its three dimensions are coordinated, corresponds to the simple 'open-ness' of physical configuration to the abstraction of some particular closure, a 'here'. The 'psychological' order of Decision is implicated in this definite (and so 'asymmetric') 'here' (here, for example) as the temporal dimension of its actuality in each of its ('my') actions, deciding upon some action organised in time, cannot but choose to be 'here'. In this case, this writing or reading now, this dynamic of inscription of the psychological order of actuality in this outward physical order of the spatiality we, readers and writer, joined by the physicality of this text must share, the psychological instance inscribed in this physical order as our (equally correlated or connected) temporality, is reflected in the act(s) of opening the book - this book or this copy, whose formal temporality appears in the 'internal' logical order of opening and closing, beginning and end. The formal and actual ('inner' and 'outer') dimensionality or spatiotemporality of the text meet in the 'Mirror' of the Knot which defines (by its embodiment) the fundamental symmetry of opening and closing in this Introduction. The subordination of  $\lambda$  to  $\phi$  implicit in the 'dynamic' in which this text, like all actual closures, configurations, anything definite, must (logically) be inscribed, is thus reflected within the text as the subordination to  $\phi$  of  $\lambda$ , which latter is (as we earlier noted) 'doubled' by  $\psi$ .

A correlative or converse subordination of  $\phi$  to  $\lambda$ , corresponding to the subordination of  $\omega$  to  $\lambda$ , is implicit in what, by analogy with the first case, one might call a 'dynamic' of inscription of context in text, which, complementing the ('real') poetic closure in or through which Decision or Actuality is 'physically' inscribed in  $\phi$ , tends towards the open-ness of never-ending Prose whose 'imaginary' closure would be (or might be imagined, supposed, to be) adequate to the unlimited variety (the open-ness) of the physical configurations, closures, which mirrored its end of timeless, context-free, definition, in the imaginary frame of a 'world'.

Such inscriptions of co-finitary elements in finitary configurations, corresponding to two complementary aspects of the general

inscription of co-finitary in finitary we are calling Law, share in a common subordination of  $\Theta$  to  $\kappa$  which we have already, in part, investigated. For in each case the subordination involves the correlation of a finitary 'converse' of some finitary order (as, in the first case, of  $\lambda$ , as converse of  $\phi$ ) with its imaginary doubling by the co-finitary converse (in this case  $\psi$ ) of that same order. This formal inscription of co-finitary in finitary as 'imaginary' doubling, as finitary reflection, we encountered in the question of the doubling of  $\kappa$ , which we concluded in the formal characterisation of  $\Theta$  as what 'decides' between the 'inside' and the 'outside' of the finitary configuration corresponding to in any particular case.

For the formal symmetry of 'inside' and 'outside', implicit in the subordination of one of these 'sides' to the other (in the subordination of  $\lambda$  to  $\phi$ , through which  $\psi$  - as imaginary 'double' of  $\lambda$  - is formally inscribed in  $\phi$  as 'imaginary' converse, as reflection; or in the converse inscription of the 'ontological' order in the finitary configurations of a 'world') cannot (as we have now seen in many ways) itself be 'decided' within  $\kappa$ . We may tend without any definite limit 'towards' the inscription in finitary terms of the dynamic of such inscription, in the coordination of its converse 'logical' and 'physical' components. Such inscription is precisely the domain of Law, its general dynamic corresponding to the inscription (and so the decision, determination) of what 'decides' matters in any particular instance within some further instance, the inscription of what is 'responsible' for some matter in some further process, a calling-to-account. But we cannot in principle inscribe in such a process the actuality of the principle which decides, in every case, how to frame the account. The formal recurrence which 'theoretically' reflects the irreducible instance of Authority, implicit in every instance of Law, cannot in principle itself decide anything, for it amounts only to the formal definition of the complement of formal definition negatively, as 'what cannot choose but that it chooses'.

We saw that the formal reflection of this irreducible limitation of Law, which cannot yet (in principle) be identified as a mere 'formality', lay in the irreducibility of what (as its two-sidedness) was open in the Knot, to a definitive coordination of one side and the textual closure it reflected in this same closure. This irreducibility

was itself reflected in the Knot as the difference between what from one side was imagined as the other side, and what was actually the other side. This in turn reflects the irreducibility of the actual psycho-physical and onto-logical configuration of 'point' and 'line' in the Knot to the order of words (these words) in which it, as 'Figure', is inscribed. For the inscription of the 'other' side as imaginary correlate, as reflection in the order of the text, of the words, of the side reflecting the same order of words (and so reflecting also its reflection in itself), would reduce what was open, what was in question, in the Figure, to the closed configuration of the text, which could then in principle accommodate its formal 'open-ness' to this 'its' (but really our) reading and writing ('its' co-finitary doubling in imagination) in a closed frame of words formally abstracted from their bodily inscription in the configuration of these marks. We have already seen how such an order of 'narrative' exactly complements (in the narrative inscription of this text in some definite context) the formal, 'internal', inscription of the entry into the text as a breaking of the symmetry of the Knot which itself constitutes one component of the Knot whose symmetry it breaks. Each such 'reduction' or identification of the text within itself involves a suppositious or imaginary abstraction from the actually irreducible mirroring in of 'inside' and 'outside'.

So we return, in our questioning, in the complementarity or mirroring of narrative and theoretical orders in (and of) this Introduction, to the question of the Order or coordination of finitary and co-finitary in which, through the coordination of these in the entry into these words, the text to which these words constitute an Introduction may itself be inscribed.

The problem has now been 'reduced' to that of embodying the 'theological' order in words, and this through the actual difference between its actual 'actuality' and the formal Actuality negatively characterised as a formal Infinity 'outside' words, imagined in these words to be outside them, in principle; as the imaginary correlate of the formal totality of 'all' finitary configurations as 'world', whose Actuality such an Authority must formally decide.

First we must try and embody the subordination of poetic closure to theological 'disclosure', and then see how we may embody the 'conversion' of their complementary dynamics.

What is the relation between the actual difference of Actuality and Nothing, and the actual difference of psychological and ontological orders within this Actuality, in both of which we, in the common frame which is the context of this text that I write and you read, participate?

We know already that formally, the difference between Actuality and Nothing, which formally decides the actuality of this 'world', supposed the general finitary context of this text, and which decides, correlative, between psychological and ontological orders of what is 'within' my range of choice (the 'I' which chooses in each case being itself outside the range of my choice) and what is otherwise decided or determined, ...we know that this difference is nothing in particular. The subordination of the finitary order of difference to the co-finitary co-ordination which 'makes' a difference, formally mirrors, through the dynamic of making a difference, that dynamic of Law in which it makes an irreducible difference through 'framing' every element, every account.

In particular, we all, writer or readers, actually subordinate this common physical order in which we and this text are embodied, to the logical articulation of our thinking, framing the choices through which the imaginary inscription of our thinking in this physical order may, or may have, become fact, as we choose what story shall actually (or so we think) be (as I choose, for example, that this sentence shall have been written). In the limiting case we all participate in the fact of being ourselves simply by the appropriation of these bodies (with all their possible implications in the conversion of what we imagine might be, into fact) which we take for our selves. The 'physical' subordination of this dynamic of our action, our actuality, to the spatiotemporal frame in which we are sensibly embodied, according to the 'mechanical' subordination of the logical order of our framing our activity in thought to the 'external' coordinates or coordination of material 'things', then embodies the framing of our choices 'ontologically' through the presentation to our thought and imagination of what is 'open'. We 'naturally' think, by a natural inscription of our thinking in the domain of Law, that we might of ourselves decide just what is this fundamental open-ness, expressed in the possibility of appropriating a common 'I', a mere mark, a nothing, in choosing that it shall apply to ourselves, and it is in this imaginary - purely imaginary - subordination to the psychical of the physical order, and of the ontological order which is reflected in it, that we confront the mystery of the Question.

Conversely, we may confront the 'ontological' aspect of the Question, in a supposed subordination of our framing of the Question to some 'external' and im-personal determination, corresponding to an imaginary completion of the subordination of the finitary order of logical determination to the co-finitary actuality of what is. Again, the supposed assimilation of finitary to co-finitary requires an abstraction of the thing, 'in' itself, from the physical configurations in which it is 'externally' or extrinsically determined as that thing. In particular, the abstraction from the configuration in which it is remarked by a name, a completely arbitrary mark (so it might naturally be supposed) at the formal or empty limit of these more or less passing 'marks' pertaining to some thing which, as changing correspondences with other 'things', are, unlike the limiting 'mark' of arbitrary name, implicated in the subordination of external determinations to the inner being of that self-identical thing, in the ontological 'dynamic' of its independent actuality.

Each of these converse 'psychological' and 'ontological' aspects remains, in its imaginary independence, partly subordinate to the natural dynamic of Law which governs the imaginary independence of each precisely from the inscription of its terms, and their correlative frames, in the domain of that Law: the supposed abstraction from the terms of this dynamic Law is itself inscribed in the formal dynamic of Imagination, through which co-finitary is reflected and so inscribed in finitary. How then, can we characterise the 'dynamic' or Actuality of Freedom by an abstraction or extrication from this common inscription of psychological and ontological actualities in Law, precisely through their imaginary abstraction from it? How can we inscribe or embody 'free' psychical and ontical orders within some configuration which, incorporating the symmetry of their inscription in finitary Law, actually relates them? We have seen that a 'theological' order of common Actuality defined in relation to an imaginary totality of 'this world' would be tantamount to the invocation of a purely formal Authority, which simply repeated the difference it must be supposed to decide. Such a purely imaginary solution amounts to the natural re-inscription of the question of the Authority of Law within Law, under the aspect of an imaginary point 'at infinity' doubling the imaginary closure of 'the world': it would be a phantom of Authority governing an imaginary freedom, an

imaginary point 'outside' Law whose only being could lie in the formal determination of this formal independence of Law in the domain of Law. In trying to abstract from the common abstraction of psychological and ontological orders we thus find ourselves left with Abstraction itself, the dynamic of unlimited displacement from frame to frame of an imaginary identity or presence that is imagined to be in every case the common principle of Actuality - an imaginary identification of an identical Actuality in every case which allows the identification in imagination of 'the world' as correlate, frame, of this Identity.

...But what are we to make of this situation? For we have seen already that there must indeed be some principle which differentiates between finitary and co-finitary, and whose being or actuality lies somehow in this differentiation - which is reflected in the dynamic of 'accounting', and which is formally inscribed in such accounts as the framing of Possibility, as the 'imaginary' order of what is 'open' in every situation, constituting a certain Presence in finitary configurations, an open-ness to us, a 'disclosure', and a correlative open-ness of ontological to psychological orders, an actuality reflected in the finitary dynamics of a common frame or configuration, coordination.

It seems that we cannot, as we rather naturally had thought, 'first...try and embody the subordination of poetic closure to theological 'disclosure', and then see how we may embody the 'conversion' of their complementary dynamics'. For there is something in the supposition of a 'then', which corresponds to the imaginary abstraction from the symmetric psychological and ontological dynamics which leaves us in their common 'formality', fiction, of imaginary 'completion' or closure which is in fact governed by the mirroring of logical and physical 'then' in the order of the finitary account, corresponding to the '-logical' determination of co-finitary actuality insofar as its imaginary independence of the finitary 'then' (and its 'orders') itself defines such actuality as partly or wholly imaginary, as always systematically displaced from the actuality of its very expression, as imaginary Abstraction from the 'arbitrary' configuration of its expression, which imagined 'true' being is thus infinitely deferred, so that the co-finitary elements are imagined as the in-finitary or non-finitary limits of complementary finitary orders, determination, which limits are actually reached only in Imagination,



in the formal displacement from the realities of expression by which the subordination of co-finitary to finitary is really expressed.

NOW, such a formal characterisation of the displacement of the Actuality we are seeking itself simply reflects the distance to be covered between that formal determination of the failure of any primarily formal determination of what we are seeking, and what we are seeking. What is the next step?

There can be no finitary determination of the next step. We can only know that it was the next step when we have made it. It is unimaginable, for in it the displacement of Imagination from Actuality must vanish. But we will be able to decide whether it was, or is, right, by seeing whether, in its act of expressing its Actuality, the expression embodies, as it should, the very law of differentiation of expression (inscription) and what is expressed. The circularity of self-expression which, like the choosing of the frame of accounting, is inaccessible to the linearity of 'then', must yet, in retrospect, be seen to have been expressed so as to perfectly complement and formally reflect the linear order of Law which it itself frames.

'NOW': what we are trying to identify must be already 'there' in Imagination, as the closure of the sentence which constitutes the 'next step' must already be 'there' beyond its opening. The finitary 'poetic' frame of the 'step' mirrors the converse ontological and psychological orders of opening and closing in the converse physical and logical 'then's' that they double in Imagination. We must overcome the still dominant logic of opening in order to cover the correlative psychological distance to what this same distance constitutes our ontological object. Or we must present this object, or allow it to present itself, over this distance...

Already there? But... then... it is HERE, NOW!

.....Uh.....

... What?... Where?... What 'here'? Is that a real place... rather than my idea of where you are, or some imaginary identification of our different presence in these words, in this book? And which am 'I' anyway?... which sounds rather familiar...

... We're back at the beginning again... but moving, as it were, in the opposite direction.

... Not so much in the logical dynamic which subordinated our different acts of beginning to an imaginary 'here' and 'now' 'within' the book. Not that 'I'. Rather in some confusion of this (that) with the converse dynamic which would inscribe all our different acts of beginning in the common physical context in which these physical books, copies, relate us... But this regress doesn't just mirror the initial progress of logical subordination of this confusion to its articulation in the words from there to here..... It leads rather to a 'step' out of this common dynamic of mirroring, 'out' of the subordination of Imagination to a 'then' governed by the common dynamic of logical theory and physical narrative, out of the symmetry of these converse subordinations of one side of poetic closure to the other. Out of 'then'.

Out of it... by choosing to step into it.

By choosing the configuration of our presence, our presences, in these words, to mark Presence.

By choosing this, the choice of the open-ness to us of poetic closure in this instance, to mark choosing-to-choose, to mark the Choice that can choose the frame of an account from the open range before it. To choose this instance to exemplify, to assert, the Freedom which complements poetic closure and its 'accounting', its Law, according to the unlimited symmetry of Open and Closed, and which has to choose itself, rather than the imaginary freedom of an unlimited questioning which will not choose to choose, 'in order' to actually be Freedom.

By choosing this choice; this choice of, example of Choice which has to be chosen for it to be Choice, to be itself... but which is not thereby in any sense 'arbitrary', which makes no unreasonable demand that it, rather than something else, some alternative, be chosen. The alternative is simply not to choose.

This Choice is Freedom. It may naturally appear unreasonable in that it cannot accede to the Reason which is the logical prosecution of Law. It nevertheless invites us 'through' the psychical doubling of the logical order of Reason in our own rationality. It is not contrary to Reason and Law, but rather complements or completes their very open-ness, even in the determination of the terms and frame of their inquiry into its law, and its supposed unreasonability.

The 'I' which opens this book marks in the interface of book and its context, 'world', just this Choice. In responding to its invitation by playing the 'part' of the Writer who marks his choice of this part, the part of choice, in these words, I thus address to 'you' as 'Reader' outside my choice which articulates the progress of this inquiry, the question of the same Choice open to 'you' in the configuration of that 'part' of Reader. - The choice, the question, articulated here as what is 'open' in that figure, mirroring as a constant critical instance, questioning, my part in the order of 'closing' the book, its articulation towards a close, conclusion: its finality.

Who then is the Reader...?

...Anyone who chooses? But if the Reader is the reader who chooses the part of 'I' open in the articulation of 'you', in the mirroring of Writer and Reader in inside and outside of the book..the reader who responds to the book as question by choosing to play the part of 'Reader'... then how can any reader really choose, actually choose to be this Reader who, as it were by definition, must already have chosen? How take the step to where we have to be 'in order' to take the step...?

...It seems an odd sort of choice...

... For it seems to involve Choice choosing itself, 'in order' to be itself. I, if reading, would seem to have to allow some sort of self-assertion of Choice in me. I seem to have to allow what cannot choose but choose, to choose for me... as though I were to allow the self-assertion of 'I' 'in me'. To choose to make this, my self, 'I'.

... Which is rather like choosing to make this choice of Choice, framing these words, 'Choice'. Indeed it is just one aspect of that... 'mine' if I allow 'I', Choice choosing itself, to choose for me.

And this 'aspect' on the frame of the words is itself an inseparable part of that frame.. or so it is if I choose. Or rather, it's formally inseparable whatever I choose. Whether I choose or not is itself made to be part of the frame. What that amounts to seems both to depend and not to depend on who I am.

That is: what this frame is, to which I can choose my relation (though 'I' cannot choose but choose) itself depends upon my choice. Or rather, perhaps, my choice depends upon what it is. For allowing 'I' to choose in my case seems to be the same as allowing what 'I' as Writer would have it be.

Just what is open in this strange configuration of Choice?

How could one disentangle these psychical and ontical dimensions of what this is?

... But that would be to try and give some theoretical account of this 'Choice'... or perhaps to give a narrative of what part I have.. or 'has', even... in it all.

And ...'then'... we .. or rather 'one', since we don't quite know who 'we' are, or what 'we' is in it ... 'one' would simply find that this strange configuration of Choice was formally just what the Writer - or, rather the writer (me, that is) - wrote that it would be... just what one would expect of the inscription in words of what (as one might expect) they might be said to 'mir-

ror' in what would be said to be 'outside' them somehow. Something systematically 'invisible', some 'inner' meaning that was in some sense 'inexpressible', which could be 'inscribed' in the words, but which couldn't, in principle, be 'contained' in any definitive narrative or 'theory'.

... Which is just what we might expect. Or which is just what 'we' might expect. The two sides of this text (or the 'two sides' of this text, if we are not yet to choose 'between' them) exactly mirror one another. Is the 'Choice' that knows itself as one 'side' - as 'itself' - to be taken as an imaginary reflection of a confusion of logical and physical, of theory and narrative ... as a confusion of Thought and Fact?...Or is this last question to be taken as a formal acknowledgement that the Question is not closed until we choose?

At this point I, 'I', as Writer, can reasonably - without prejudice to the reader for whom the nature of these words, and his part in them, remain open - assert that it is my part now to assert my part, though the reader's part remains (as it must) in some sense 'open' in all that follows, as he or she may always take (as I as Reader or Writer cannot) the parts of Reader and Writer as possibly imaginary, as of questionable reality.

Here we are..then.

This marks where we are. 'This'... what? This choice to mark Choice, this, allowing Choice mark itself, to choose this choice from the open-ness of the finitary Frame as such to be Choice, to be itself, in this marking, to remark itself as THIS choosing to mark itself. To make a difference, to express itself in the difference between this frame and another, which makes this THIS. Why this rather than another frame? - There is no choice: for this is chosen to express Choice choosing its expression, by making a difference between Freedom and Law.

This.

What?

- Self-assertion of what decides between this frame of questions and assertions, and another. Self-expression: in the formal symmetry of Choice and not-choosing, of Freedom and Law, asserting, expressing, a disymmetry which engages us 'in' this frame. Engages us in these words, this language, in its dynamic of subordination of physical 'context', 'outside' the words in the logical frame of the text as inquiry. Engages us in the complementary Sense, sensibility, in which the logical order of the words is inscribed physically in different copies, separate yet related in a common frame of the spatiotemporality of our writing and reading.

- This which, in the difference between the two 'sides' of the poetic frame, between the 'converse' orders of logical and physical 'then', actually reflects, expresses, the difference between the psychological self-assertion of 'I' writing, and the ontical self-assertion of what is written. And which in the difference between the formally symmetric sides of the poetic frame in this limiting case of the word, names itself as Actuality: THIS. That differentiation and integration of text and context through which we are engaged in the dynamic which correlates the subordination of our 'framing' to some wider frame (our texts, for example, to some context) and the converse subordination of our situation to the way we frame its possibilities, what is open to us in it.

- This which articulates the difference of logical and physical orders within the symmetry of the poetic frame of some Action, some Drama, and in that articulates the difference between any such formal symmetry and an Actuality in which we may actually participate in a symmetry which frames our interaction.

Here, in this frame, the Action now amounts to our allowing the self-assertion of what makes it this, its 'actuality'. I, as Writer, have rapidly sketched a coordination of psychical/ontical difference, and the difference of finitary and co-finitary, Law and Freedom, in which this first co-finitary difference ( $\psi/\omega$ ) is reflected

in the difference of logical and physical ( $\lambda/\phi$ ).

This amounts to a minimal introduction to, induction into, the Drama of THIS, through this instance of its self-assertion - and into our 'parts' in it: what is open to us in this minimal configuration of 'Drama', 'Action', Actuality. 'Drama' since  $\psi$  is subordinated to  $\omega$ , as  $\lambda$  to  $\phi$ , in the introduction into the dynamic of 'framing' (governed formally by the dynamic symmetry of  $\bar{a}$ ) of the locus of the determination or choice of frame, the introduction of our 'part' in, responsibility for, what we frame: the choice is made by someone, some-where, sometime - and, also, since this principle of subordination can itself be introduced as an element of some 'further' frame, some other version or perspective, account, in the complementary dynamic of subordination of  $\omega$  to  $\psi$ , and  $\phi$  to  $\lambda$ . 'Minimal', since in 'this' what is asserted is simply assertion, the inscription of  $\lambda$  in  $\phi$ , as itself chosen, as one might further assert the inscription of one's assertion in a limiting frame - 'World' - as 'I', 'here', 'now'.

In this minimal case the subordination of  $\lambda$  to  $\phi$  is mirrored in a complementary subordination of  $\phi$  to  $\lambda$ , constituting a minimal articulation of symmetry and disymmetry, of the closure of the frame and what decides, 'chooses', 'determines', among the open range of all such (possible) closures. What asserts itself simply as THIS, as thus coordinate with the dynamic or 'dramatic' of the frame simply as such, we may call 'Actuality', but will more generally recognise simply as THIS, whose instance may be marked  $\Theta$ .

As elementary self-expression, as 'I', we may call THIS 'Word': the psychical actuality reflected in the dynamic of subordination of  $\phi$  to  $\lambda$  as 'language' in which we (simply in virtue of being 'we', I's) all participate. As the ontical actuality of here and now, THIS is Presence.

Now this minimal characterisation is itself framed in the closure of (the frame of) this Introduction. Indeed it is as deciding upon this frame (of questioning the frame of expression - and so of question and assertion - simply as 'such') in this instance, that THIS characterises itself as the Actuality which actually asserts itself as what makes this frame this (one) rather than some other. Within

this frame it marks itself as THIS, as or in its elementary component words. This 'word' reflects the Actuality which names itself as what names itself by marking itself, making its mark 'inside', as 'this' side of this frame, whose definite actuality is thus defined as a mirroring - this mirroring in its 'terms' of the actuality of the 'World' in which it is marked. It reflects its own actuality as the asymmetry in this mirroring of its finitary and cofinitary orders which expresses itself in differentiating the two finitary 'sides' of the finitary poetic frame, by marking itself 'in' the frame as a word which expresses, repeats, reflects, within the coordination of the finitary orders of the frame, just the assertion of this marking, this making-a-difference. The actuality of the mark is marked in the order of the mark as outside formal determination 'in' that finitary order. The distinction of two sides of the finitary poetic order is inscribed in the more radical 'actual' distinction of the order of actual distinction from the finitary symmetry of that 'formal' distinction of sides. Indeed THIS might as well be marked in the order of terms, as simply distinct from the term which marks its distinction: 'not this'.

The frame of this Introduction opens in a questioning of this its actuality, a questioning of its questioning: an opening mirrored, within the linear temporality of the text, in this closing assertion of assertion, of Choice, as what 'decides' the choice 'of' this frame of questions. In the primary 'internal' order of the frame as deduction, as subordination of context to text - inscription of their relations in the text - organised by an 'I' formally framing the inquiry from a limiting point of formal coincidence of and 'at infinity' outside the frame (like its 'here' and 'now'), the actuality of the frame is expressed, 'in terms of' a language or dynamic of subordination of (converse) physical order to 'direct' logical order, as a questioning of the psychical actuality which is (as yet unconsciously) reflected in this 'prosaic' dynamic of Language. The psychical actuality of the questioning appears, in subordination to the logical dynamic of the text, as an 'imaginary' configuration of what is 'psychologically' open in the logical closure of the text: the question, first of all. of who 'I' am.. Whether writer, reader, or perhaps just a word until someone (but then who?) decides.

A correlative 'ontological' open-ness or imaginary space of possible 'references' of such terms is from the start implicit in the



converse of this logical order in the symmetry of the poetic order of closure of the frame of questioning. This poetic symmetry itself reflects an initially 'imaginary' open-ness corresponding to all the possible coordinations or articulations of psychological and ontological determinations of what was going on. From this imaginary correlate of the frame of the text presented simply as such, without any further psychological or ontological determination (as to 'genre', as 'theory' or 'narrative', for example) the questioning discloses an Actuality which 'decides' among the open range of 'imaginary' correlates of the various elements of the frame, and in particular decides between the two sides of the imaginary duality of 'real' text and the 'imaginary' open range of what it might be about. This Actuality is then seen to assert itself as we assume a 'part' as what is open to us in the confrontation with these words: to allow THIS to decide between an imaginary 'I' writing or reading, and our actuality.

This 'allowing' a self-assertion of Actuality 'in' the actuality of this actual book - including 'its' self-assertion in 'my' participation in this actuality - in part 'answers' the opening, as questioning, of what was going on. For the opening questioning is now recognisable as 'my' imaginary engagement in 'Law', in the dynamic of incorporation of psychical and ontical orders within their finitary orders of expression, marking, associated with an initial 'imaginary' break into the formal closure of the poetic frame. This engagement may then be regarded as, asserted to be, the opening expression, appearance, in us (lost in the play of Imagination), in our dramatic interaction in words, of an actuality which then expresses itself more and more directly in the psychological and ontological articulation of our subsequent determination (or determinations). These determinations remain within the frame of a subordination of co-finitary Actuality to the finitary 'mechanical' dynamic of Law, through the subordination of psychical-ontical differentiation to its finitary dynamics in terms of an imaginary independence, or independent identity, of Self and Thing, psychological and ontological identities, until the configuration of Choice directly presents us with a choice corresponding to our 'part' in Choice. By our participation, simply through assertion, questioning, assent, in the interplay of finitary and co-finitary orders expressed in the dynamic of closing, determination, of the finitary frame of these words, we participate, however indirectly, in an Actuality which asserts itself directly as THIS, and in which we may assert our part directly as Reader or Writer, in actually assuming some part in these words, from the open range which doubles in Imagination the 'I' correlative with these, as with any other, words.

This figure of an initial question opening a dynamic which may be finally seen in some way to 'answer' the question by locating it as one element of a configuration into which it leads as a sort of imaginary or apparent beginning, may be called Mystery. The answer or 'answer' lies not simply in the close of the frame of inquiry opened by the initial question or questioning, but rather in the transfiguration of the frame of the opening questioning in the disclosure of an actuality which 'decides' the frame from among what at the outset appear to be various imaginary or imaginable closures, with no apparent means of deciding between them. A 'mystery' because the frame of questioning is itself in question. And a 'mystery' in a more dramatic sense, in that our entering into its frame is itself the expression of a co-finitary principle of determination 'engaging' the finitary material it 'transfigures'.

In a sense, Actuality, as the Mystery of transfiguration of the Question, with its implicit frame the closure of the symmetry of Open and Closed, is a primary Mystery, the Mystery of Choice, Freedom, in which other mysteries may be inscribed. Yet this Mystery of Closure is itself complemented by the irreducible open-ness in which the particularity of every question (and in particular, of the Question, insofar as it must be expressed) asserts itself in the open dynamic of its framing, its inscription. And so, in a wider sense, in which the abstraction of a simple 'thisness' from its expression is itself questioned, the frame of complementarity of Question and questions, with its converse movements of expression and transfiguration, is itself transfigured in the open Drama, of which this writing and reading of ours is actually a still-open part: this very Drama of the complementarity of Drama and Mystery, which is itself the greatest Mystery.

This limiting or ultimate Mystery, whose material is, as it were, the confusion of Expression and Transfiguration, is in this case expressed in the complementarity in this Introduction of opening questioning and closing assertion within the closed frame of this Introduction. This complementarity, corresponding to THIS as instance or 'principle' of transfiguration, is itself inscribed in the dynamic of this expression, through the question of the inscription of the finitary closure of this frame in its primary 'context', this 'World' in which

we write and read it. The greatest Mystery lies in our engagement in the complementarity, in our activity, of the two movements of dynamic inscription and transcription, of the framing of our activity in wider contexts, and the transfiguration of our activity as our actuality: In the complementarity of our psychological and ontological inscription in the dynamic of Law, in which imaginary identities amounting to the configuration of what is open are simply transcribed from one frame to another, and the transfiguration of this dynamic as Actuality, in which we participate through the Choice which transfigures a psychological dynamic into psychical actuality, an ontological dynamic into an ontical actuality.

More particularly, we, writing and reading, are engaged in 'deciding' what this text amounts to, what to make it, or make of it, through being essentially - as writing and reading it - involved in deciding or determining what remains 'open' relative to the closure of this frame. The 'great Mystery' here, or in this, is that what remains open itself depends upon what we have already made of the frame itself, how we frame the question of just what this is, of which we are to make something. There is an essential 'circularity' in our situation which amounts to the inscription of of the 'formal' Mystery of the Question in it. But we have to decide just how this Mystery is inscribed, involved. It is actually up to us to resolve the Mystery of the complementarity of the psychical and ontical dimensions of this frame by choosing, by entering into the Mystery of our freedom.

This amounts to allowing Choice to decide what is in each case our part in relation to this frame, in relation to the question posed by the formal complementarity of closed frame and open context, which asks us to choose what this is, what we should make it or make of it. For what is open in this frame is just what is open and what is closed in its formal complementarity of Open and Closed. Insofar as we do not choose, but remain within the dynamic of an Imagination which leaves the question 'what is this?', 'what is our part in it?', open, we leave the question to be decided

by a 'chance', 'outside' us, by failing to accept our responsibility in its determination.

Allowing Choice, is to allow our part in this, to allow the articulation of psychical and ontical elements in the open complementarity of logical and physical orders in the formal frame, which corresponds to allowing Choice a part in framing what this is, and a part in framing our part in the formal complementarity of 'inside' and 'outside' the frame which constitutes the question 'Who am I?' by which we are formally engaged in this frame.

The actuality of this coordination in the self-expression of Choice of the psychical and ontical actualities reflected in the converse logical and physical orders of inscription from which the finitary closure of the text is abstracted, is itself reflected in the Figure, the Knot, which mirrors, at the mid-point of this Introduction, its 'direct' logical order of deduction (reflecting the psychological order of our rationality) and the converse 'then' of the physical temporality from which this deduction is abstracted. What is first open to us in the frame is reflected in the two 'sides' of this Figure which, as embodying the complementarity of logical and physical orders in the poetic frame, reflect the actuality of the correlation of psychical and ontical orders in what is left formally open in the frame: the actuality of our engagement in it, our presence in the actual correlation of text and context in which we read and write. The formal mirroring of finitary frame and its co-finitary actuality, through the inscription of the text of this frame in the dynamics of its context, 'World', in which we write and read it, is, as has already in effect been noted, itself reflected in this Figure, which amounts to a reflection in the frame of the text of the mirroring in this frame of text and context. Thus the way this Knot embodies the inscription of the logical dynamic of the frame in a complementary physical order itself amounts to a primary image of the actuality of the frame. Image: the inscription of what is decided in the formally open mirroring of finitary and co-finitary within the finitary domain of Fact. Within the text the figure reflects the formal conversion of finitary and co-finitary by which Actuality is inscribed in 'The World' as primary Fact, as facts.

In particular this Figure expresses the complementarity of our actuality in relation to the text, and the 'fact' of our being 'in fact' one side or other of that point (the Knot) in the text - more generally, the complementarity of co-finitary Actuality and finitary Fact - this through the symmetry in this Figure of (on the one hand) the formal inscription of Choice in the finitary order of the text, and (on the other hand) the transfiguration of this symmetry in the actuality of a Choice that chooses to express (and by this very choosing expresses) the formal complementarity of Expression and Transfiguration, Law and Freedom, in this Figure.

Further entry into the Mystery marked initially as the question of this book (the book as marking the way it constitutes a question: what we are to make of it) requires that we trace the actual determination or deciding of its frame (what determines there should be, is, this our very questioning in the actuality of this our World - what makes this this). The following, as narration, must therefore trace out the mirroring of its own actuality in our World, within its narrative frame, to the point where we find mirrored in it the very configuration of our actual reading and writing of that mirroring, that configuration. The book must then conclude or close in the transfiguration of this its frame - of the questioning by which we enter 'into' it - in the disappearance or dissolution of the imaginary open-ness complementing the imaginary closed circuit of frame, text, book, which radically separates 'inside' and 'outside' and elides any passage between them (this complementarity framing the question or inquiry which leads us 'through', into then out of, this book).

The narrative 'passages' which now follow, must then open with an identification of Mystery in the mystery of our simple participation in an Actuality which 'decides', determines, primary Choice in the open-ness correlative with (what is open in) the Frame ('as such') of which this book is this instance: in the Actuality 'of' this World. Such identification itself amounts to an opening-up of active participation in the actuality of This World - 'induction' into Mystery, as this actuality of this frame of book is inscribed in the Actuality of this World. Such Actuality, its Mystery, lies in a mirroring or reflection of the Knot, 'outside' this frame, in a mystery of transfiguration of the finitary frame of this World, into Kosmos,

through our entry into the mystery of a 'moral' Law which articulates the mirroring of the 'invisible' actuality of Choice or Freedom, in the visible Law of Nature, in that dynamic of Fact in which Choice, through Action, is inscribed.

The opening mystery is 'actually' found at work in the process of 'deciding' our actual initial frame of narration, in which further questions may then be framed (in which they open up) in a logical dynamic of Inquiry which must finally close with the question, 'marked' by this very book, of what is 'open' (to us) in this actual configuration of its various symmetric orders, dimensions. The logical dynamic of opening successive frames of questioning or inquiry themselves, to questioning - through the 'critical' inscription of an earlier 'logic' in its actual context, articulated as a narrative or 'history' in the poetic mirroring of logical and physical orders ('sides') of this dynamic - closes in the 'historical' advent of the question of this radical symmetry (of the two 'sides' of books) itself: in a final question which must necessarily be eventually confronted in an inquiry which questions its own actuality, its own character as 'this'... must necessarily be finally confronted in this inquiry...'in' this.

This then: a transcription of an economy of Inquiry directed by an imaginary 'I', which as formally 'outside' each successive frame of Reflection, continually questions succeeding frames after the mysterious opening of this continuity as our Tradition of Reflection - until it finally questions itself directly; a narration of the framing in our Tradition of its own very actuality - a narration whose final inscription in the narration marks a certain, or rather an uncertain, Close: a closing question, the question of closing this book. And within this closed circuit of this, a closing text of our Tradition, are serially inscribed three lesser circuits of opening, transition through, and closing of a certain component order of inquiry: three Parts of this inquiry or narration, amounting to the transcription into the 'internal' logical order of this book of the logical order of a Tradition of Reflection in which it,

this, inscribes itself finally, as marking - at once 'in' and 'outside' the book (in their coordination, precisely) a close, and what is open in this close: what is open, in particular, to us, to 'I' as reader and writer of this book, in the configuration of closing, of a close, marked by this book, these books. What is open to us, to 'I', what my part, what our 'parts' in relation to this 'script' of a certain or uncertain close, the close of a certain history, the end of a World?

## PART ONE

## INCARNATION

### Opening Questions

Here we are. In a physical order, a physical 'space' and 'time', one side - the 'out' side - of this text. A 'physical' space in which these texts we write or read are a multiplicity of separately embodied 'copies' of this 'in' side, this ('logical') content, this 'logic' which is in each case the same. A physical time in which this same internal logical order of these words is differently embodied in our separate activities of writing or reading. This as we enter into the psychical order of these words, ontically presenting itself in a physical configuration in which each of us bodily confronts this.. what? This multiple paper surface - this book, these books.

But where are we, and when? What common Space might include all possible situations of 'this' our reading and writing? And what Time? What World might constitute the common Frame in which those, these, situations of our reading and writing are more or less 'open' to us? 'This' World?.. containing 'in principle' or 'by definition' any physical 'copy' of this book, as it contains our physical embodiment, our physical bodies confronting the physical marks which are these words, and contains the physical order of 'copying' which links one copy physically to another, and so all readers and a writer? - A World which is 'here' and 'now' the same whenever and wherever 'I' - we - write or read this?



.. A World as Frame of all the 'marks' of which these words are particular instances, a World open to this 'marking'? An open physical Space and Time in which any of us might somehow or other mark some place and time, might 'point' out some physical 'situation' as 'this' or 'that', and as just 'this' or 'that' formally equivalent, then, to the simple mark as elementary pointing or point in this Space and Time? 'This' World, then, as the closed physical Frame formally complementing the open range of what, in all possible extensions of this frame of words, all further discussion, we might point out, indicate?

.. But we have already seen that such 'physical', 'outward', framing or determination is always actually - in any World which is to be 'this', which we are to be 'in' - coordinate with a converse logical order. In fact we have seen how these two orders, physical and logical, are formally 'convertible', how they mirror one the other, in this very book, this frame of words, in relation to which we have begun to characterise its physical 'out' side, context, World. This conversion or convertibility, mirroring, enables us to identify the limiting frame of abstract Space and Time, of a comprehensive physical coordination of indivisible simple 'points', as itself a projection outside the frame of words, of the formal logical order 'in' this frame: the 'logic' of any extension, of any particular frame or account in which this framing or account might in its turn be inscribed. - That is, 'this' limiting physical Frame or World is a fiction, the limiting formal coincidence of logical and physical orders in complementary abstraction from their actual coordination in these words. The fiction according to which the physical order is inscribed or comprehended in the logical order as the latter's doubling or reflection in its 'outward' context.

We have also seen how such a logical determination of the mirroring of logical and physical is itself doubled or mirrored by a physical dynamic (or order of determination in Space and Time) in which the formal 'space' of the logical frame (the frame, in particular, of the logical 'definition' of the physical) is itself inscribed. - And how the 'poetic' economy of this play of conversion of symmetric logical and physical orders itself leaves open the actual articulation of this symmetry, this conversion, as the poetic 'space' and 'time' of coordination of psychical and optical actual-

ities. A 'circular' self-assertion of each of these converse actualities - a common Actuality, in their actual coordination, is itself expressed (or expresses itself) in the actuality of some particular coordination of logical and physical rather than some other coordination, in the poetic range of coordination 'open'.

Thus the Actuality reflected in this particular frame of words or book, in this its actuality (rather than some other open at the start), is not to be understood simply in terms of the limiting Frame of some supposedly universal and comprehensive context - an infinitary Space and Time rooted in some radical facticity of its terms abstracted from the logical order of their identity, their identification or marking. Such a formal 'physical' Frame or order, such a (physical) coordination of terms, 'points', is itself but one limiting figure or element in the poetic economy of framing, in the order of 'Law'. 'Economy': for this Law of poetic symmetry regulates, constrains, the endless inscription of frame within frame...but cannot itself 'decide' the actual order of such inscription, except within some definite frame of decision or determination which has already been somehow decided. 'Law' cannot (that is) be itself definitively inscribed within any finitary frame, not even in a limiting Frame, in the logical or physical order simply as such. For the convertibility, the relation(s), of these mirror orders cannot itself be definitively inscribed within one or the other: any such supposed inscription can itself be at once converted, inverted. We cannot 'definitively' inscribe this frame, these words, in a definitive physical Context (in which, then, we could determine or decide in favour of their actuality rather than some other, here and now), any more than we can definitively inscribe and determine their physical 'context' as one term in the logical frame of this text.

We must, rather, look for some way of framing an economy in which these converse movements or orders of inscription, framing, of inside-in-outside and outside-in-inside, can be remarked. We saw in the Introduction that the element of such a frame or framing is an actuality, a this. - A sort of minimal instance, as it were, of the self-presentation of that order of 'this' as itself THIS. An element in a poetic frame which must in that case be this frame, these words. The psychological actuality reflected in such a logically simple assertion of assertion mirrors, as we saw, the ontical

actuality reflected in the physical fact of the book, which organises the opening questions. This 'mirroring' of psychical and ontical is actually embodied in the Introduction in the coordination or articulation of orders (  $\lambda, \phi, \pi; \psi, \omega, \theta$  ) in a 'Mirror' which is itself reflected in the poetic frame of that Introduction, those words, in the figure of a Knot. To find a frame in which this text may 'actually' be inscribed, framed, 'decided' amidst what it might have been, amounts to finding not simply a 'physical' reflection of the logical articulation of that Knot, 'out' side of the text, but rather to finding an actual configuration in which the economy of this mirroring of logical and physical may itself be remarked in the actual world of this text (in this world of which this text is one element, one 'this' among all this and that).

Marking, remarking, such a frame or configuration, mirrored within the poetic circuit of the Introduction as Knot, must involve some 'mystery' analogous to that whereby THIS marks itself in that Introduction - as what makes it that. This our actual World must correspond to some configuration which somehow is drawn 'between' the limiting formal 'space' and 'time' of logical articulation of the text, and the equally formal reflection of this in, as, a physical Space and Time of its context. Such a configuration, circuit, 'closure', must be determined, 'decided', at some point 'outside', not comprehended or determined by, the finitary economy of Law. Of a Law framing an economy or play in which this decisive point or point of decision is formally open, possible, but formally undecidable, indeterminate.

We have seen how the mirroring or complementarity of finitary Law and cofinitary circuit inscribed in the economy of what is 'open' in that (under that) Law, is itself reflected within that Law, in the finitary symmetry of logical and physical - in that finitary image of the complementary symmetry of psychical and ontical. Thus the configuration in ('through') which this world is this, is itself reflected in (the economy of) this world. We can recognise (then) the Actuality which frames and 'decides' the actuality of this account (of it), if we can recognise at work in the finitary configuration of the Knot a principle which distinguishes the principle reflected in the Knot from its finitary express-

ion: from the finitary reflection of this very distinction from that finitary expression itself. - If we can remark a differentiation which differentiates itself from its reflection, expression, image. - If we can find such an actuality at work 'in' the image of its differentiation from that image.

That is: the circuit, closure, the 'frame' corresponding or 'answering' to what is open in the economy of inscription of this frame of words, these words, in further frames or accounts, is not to be found in some non-finitary or infinitary Frame or World in which the logical order of the text would be reflected in some supposed physical totality (a sort of infinite physical Creation as limiting case of finitary poetic creations). Rather is it to be found in a cofinitary principle; actuality, working, of framing, which bears to the finitary economy of frames a relation of complementarity reflected in the finitary terms of that economy as the finite logical articulation of the text in an 'infinite', Space and Time physically open to such a closed logical circuit... but which isn't 'outside' this logical image in the way that the infinite physical closure of a Universe might be supposed its 'out' side, but rather is formally 'outside', irreducible to, the conversion of logical and physical, cannot be definitively framed as a finitary or definite element in their common economy. A co-finitary principle which is at once logically 'outside' its logical image, but cannot therefore be identified with the physical order as image of this 'out' side of the logical. The 'mystery' here lies in the way such a 'cofinitary' principle or working may find finitary expression - may actually express itself in the distinction between itself and its expression, a distinction itself reflected in the expression of self-distinction from its expression. It is just this figuration of recurrence which we remarked in the Introduction as the 'circular' self-assertion which formally 'defines' (or rather, 'marks') the cofinitary configuration or coordination marked by the coordination in this text of the letters  $\lambda$ ,  $\phi$ ,  $\bar{u}$ ;  $\psi$ ,  $\omega$ ,  $\theta$ . Complementary psychical and ontical orders participate in a common figure and actuality of self-assertion which asserts or differentiates itself in differentiating 'between' psychical and ontical: by 'deciding' the poetic symmetry of logical and physical in which psychical and ontical express themselves, in which they are themselves 'reflected'. This radical circularity of self-

assertion in self-distinction in this way 'presents' itself throughout the finitary Economy of framing as the actuality of its articulation distinguishing itself (in the Economy) from what is merely 'open', possible, in the symmetries, in the Symmetry, the Law, articulated in the formal poetics of the frame.

We know that this cofinitary principle of recurrence, of circular closure inscribed in and complementing what is 'open' in the formal poetic symmetry of the finitary orders, cannot in principle be 'definitively' inscribed, defined, circumscribed, comprehended, 'in' some finitary set or configuration of terms. - Cannot be 'reduced' to the economy of a reflection or complementation of what is open in the Economy of the finitary, by the closed circuit which 'decides' what actually happens amidst what is formally 'open'. For the question of the closed circuit embodied in the 'framing' of actuality, must always in principle remain open in the Economy of the frame, of frames.

Our question, now, is whether we can find, or invoke, some frame or configuration of terms intermediate between the logical pole of identical term (undifferentiated 'this' for example), and the physical pole of a fictional totality, a physical World of all that could be thus marked or identified, and which could itself (one must suppose) be identified as 'this' World. Whether we can invoke some frame in which we could find a reflection of the difference of 'circular' self-assertion, distinguishing itself from every instance or inscription: in which that working of distinction might be found to 'mysteriously' distinguish itself. That is: whether we can find some frame or configuration which itself embodies a distinction between a distinction, and the terms in which it is made, marked. - Whether we can find an actuality expressing itself, at work, in the inscription in the Economy of Law, of the Frame, of what is radically open in that Economy. - Whether we can invoke a self-assertion of this inscription, this self-inscription, itself...a closed circuit complementing the open economy of the formal mirroring of open Economy and the closed circuit embodied in the actuality of any particular framing of this mirroring.

Such a frame, which must somehow embody the assertion that it is the frame in which the difference of finitary and cofinitary is asserted precisely in the very determination of that finitary expression of the difference, must be radically indefinite. It must present itself in the figure or character of a 'mystery' in which we ourselves are 'terms', in which our choice is irreducibly engaged as one component in what 'decides' the expression. We appear as the locus or loci of choice 'between' an unlimited Economy (of further questioning, in particular), and an 'allowing' of the self-assertion of actual finitude, of an actuality in (most particularly) our finitude, an actuality asserting itself 'mysteriously' in choosing itself to express the general complementation of finitary framing through the very particularity of a particular configuration.

There cannot, then, and this from the very 'law' or symmetry of the matter, be any definite point of choice at which we may or may not step, so to say, 'out' of the Economy of Law precisely by choosing to assert our finitude, our part 'in' that Economy. Yet we can determine, as it were, the movement, the dynamic configuration of that indefinite 'point' quite definitely, in the duality and 'mystery' of a 'choice' as at once something 'open' (to us) and whatever 'decides' or resolves what is thus open (our 'act'). Such a configuration or dynamic has already been at work in the Introduction - in the mirroring, for example, of opening question and closing assertion of the part of writer: a dynamic of introduction or induction into the configuration of these opening questions of the First Part of the book 'proper'.

Where are we now, then: where does all this leave us?

We began this First Part - set out into it - by asking what, as 'context', might constitute a primary frame 'deciding' what was open at the outset in the mere possibility of a book, deciding the opening question posed by the frame of this book simply as such. The question arose (that is to say) of an order comple-

menting the open play of framings (in the book) of the 'poetic' frame of the book as 'book'. - Of a 'wider' order, in which all these possible framings might be supposed inscribed, and in which this actual framing of the book as an inquiry into what is open in it simply as book, might be somehow determined - inscribed, say, as a subordinate actuality within the comprehensive bare fact of a physical 'World'.

We saw that we couldn't simply 'convert' the logical 'in' side of the inquiry, the logical 'content' of the Introduction, 'through' the mirroring of logical and physical in the configuration focussed in the Knot, into some primary articulation of the physical 'out' side as universal Context (which all copies of this book would, in principle, be 'in'), in which the place (and time) of the book might be supposed decided, determined. The 'actuality' of the book, corresponding to a resolution of what is left 'open' by the figure of 'book' as frame (as frame of inquiry into this book or frame itself) was seen to be no more decided through its place and time in a comprehensive physical World, than through an internal 'logic' abstracted from the poetics of its interplay with a physical 'out' side in these words. The symmetric difference of physical and logical 'in' the book - of 'in' side and 'out' side of the book, as articulated in the frame of the Introduction; at once ruled out (as a 'fiction', 'imaginary') the simple conversion of the logical frame of the book as inquiry into a converse physical frame of its writing and reading. - Ruled out an invocation of the supposed closure or circuit in which such a Frame was supposed constituted (as) 'out' side the logic of the inquiry, to resolve the question posed by (to resolve what was open in) the very frame or closure of the book as book.

This latter closure is not to be identified with its 'logical' image as abstract inquiry, nor with the converse physical image of the book(s) as physical object(s) (term(s)), but corresponds rather to a poetic symmetry of converse logical and physical 'sides' of the book, of its 'frame' or 'framing'. - A 'poetic' symmetry or mirroring of converse logical inscription of the physical order of the book as one term in a logical configuration ('in' the book), and physical embodiment or inscription of this logic in the physical order of its reading and writing. What 'decides' what is 'open' in this play of

inscription and conversion (decides the open-ness posed in the circular question of giving an account of the different possible accounts, framings, of this book), is at the same time what decides, distinguishes, between in-side and out-side of the book. It distinguishes itself simply as an actuality of differentiation which is formally 'open' in the poetic symmetry of logical and physical (and indeed poetic) orders: an actuality which 'in' these terms distinguishes itself from what must remain formally open in their economy or interplay - including a merely 'formal' marking in the play, of this distinction from (that) its formal marking.

How, we wondered, could we proceed from this fiction of a closed physical World (as formal 'ontological' actuality complementing the logical circuit of logical distinction of their logical distinction from the physical difference (distinction) 'by' which the logical distinction of logical and physical is marked) to a frame in which the complementarity of physical and logical orders would reflect the wider (and 'analogous') complementarity of finitary (of which physical and logical orders are the two 'sides') and cofinitary? How proceed from a double abstraction of a logic of inquiry from the cofinitary actuality of resolution (that is, the coupling of abstraction of finitary from the symmetry of finitary and cofinitary, and the finitary logical order from the symmetry of this 'logic' and the physical articulation of its expression) to the mirroring of finitary and cofinitary as a more radical frame of this inquiry, of this its logic?

We noted that the coordination, the configuration, of the two complementary closures, circuits, recurrences, of finitary Economy of figure, and cofinitary Mystery was itself reflected, in the frame of the Introduction (which marks the opening of this book) as a Knot with its two 'sides', one the 'mirror-image' of the other. -The spatial image of this 'mirroring' itself one 'side' of a figure of Mirror, doubled or mirrored in the logic of distinction of 'logical' and 'physical' spaces, and this mirroring of 'inside' and 'outside' of the book itself an 'image' (to use the 'physical' analogue) of the doubling of this mirroring itself by a complementary cofinitary actuality 'outside' the open Economy of inscription of figure within figure.



We eventually saw how the 'mystery' of what we were seeking lies in some recurrence, in a closed or 'circular' configuration or frame, one of whose terms (the frame itself as marked, as one term, 'in' the frame) must itself express the determination, choice, of such a finitary frame for the mirroring of finitary and cofinitary, by the very cofinitary configuration of self-assertion, of 'choice', reflected in the terms (with their finitary articulation) of the frame thus 'chosen' from the open range of a general economy of mirroring of finitary and cofinitary.

The choice of a frame in which Choice and Law are mirrored is the term about which the self-expression of Choice is articulated in that frame.

The question now, therefore, is that of this 'choice' about which as central term is articulated the mirroring of finitary and cofinitary: the question of this circular inscription of the choice or determination of the frame as one element in the frame, which circuit is itself, precisely, the 'closure' which poses the question. Poses for us the question of the choice of a frame which will express, if we choose, the mysterious complementarity of Mystery and Law. If we choose: for we are ourselves 'terms', ourselves marked, in the frame. We have already seen (toward the close of the Introduction) how our choice of a frame of self-expression of Choice is an irreducible component of any such frame. Indeed this very circularity of our part in framing our part is precisely - is it not? - the figure of our choice as marked in this mysterious coordination, the circuit 'through' or in which the configuration is now 'open' to us as a question.

We came upon this question of our choice in the Introduction as something 'open', somehow left open to or for 'us' - for any 'I' - in the formal complementarity of a mark, 'this', and what can choose to remark itself in choosing such a mark. Within the circuit of the Introduction, in its symmetry of converse logical and physical orders of textual 'content' and its outward context, the symmetry of ('finitary') mark and ('cofinitary') remarking (of frame and framing),

remains open through the abstraction of its terms from their complementary logical and physical (or psychical and ontical) determinations or orders, an abstraction from their unlimited or open convertibility. Now we must try and frame our place (find the part of 'I', 'here', 'now') in the mirroring of the circuits of Mystery and Law, in their formal complementarity left as a 'personal' question in the Introduction. - As a question the locus of whose resolution (the locus of assertion as marked in the Economy of framing as 'I', 'here', 'now') was itself in some degree (and that necessarily) left open, addressing itself to a 'reader', an 'I' marked in the text as 'outside' its determination, as 'free' to frame, or not to frame, his reading or her reading in the part of 'reader' as marked in the text. 'I' as writer, on the other hand ('conversely') had, 'in' the text, to assert the inscription of my assertion, my choice, within a text then left open to a reader's consideration.

The 'psychical' actuality of my self-assertion inscribing itself 'in' the finitary text (in this order of marks) partakes in the actuality of a 'Choice' which 'decides' its self-expression by determining this set of marks (from other sets, texts, open to it) in which to inscribe this its determination as one term, one mark among the others. 'My' assertion, then, partakes, in particular, of the figure of the formal self-assertion in this text of a Choice which 'cannot but choose' to identify and assert itself here as THIS, and in the textual configuration or economy of that mark to 'decide' the formally open symmetry of Law and Freedom, Economy and Mystery. My self-assertion as writer in the 'finitary' logical frame of the inquiry embodied in these marks (my assertion marked in its simplest instance simply as an assertion of 'writing' in choosing this 'I') in turn partakes of an ontical order asserting itself in the physically different locus of my confrontation with the configuration of assertion, my 'I', and 'yours'. These then are psychical and ontical 'sides' of a common order of self-assertion which I have marked in a psychical 'image' or figure as 'choice', as what 'decides' what is 'open'. - Psychical and ontical 'sides' then, of a configuration of self-expression, a mysterious configuration of working or actuality of a 'Word' which distinguishes itself in the finitary order of the Mark, from the open play of marks and their figurations.

Our 'double mirroring', then, of the symmetry of finitary Mark and cofinitary Word, in the symmetry of logical and physical 'sides' of the Mark - the double symmetry from which a certain logic makes its double abstraction to an order and dynamic of 'formal' assertion (abstracted from its 'physical' context, and from what decides this symmetry of text and context, 'in'side and 'out'side of their 'poetic' mirroring) - finds a minimal and radical articulation in this configuration of a 'mystery' of Word.

In particular this configuration of a double mirroring, of a symmetry of symmetries (each one side of 'their' symmetry), is at work in these marks, these 'words'. We have already found an 'image' of this configuration 'in' the verbal frame of the Introduction: we found a 'double mirroring' in the Knot embedded in the words which 'opened' this book. If we tried to simply inscribe the difference of the two 'sides' of the words in the (physical) out-side -say in terms of two sides of some physical configuration, some body, then we must assume some logical order of identifying 'this' side and 'that' side. The physical difference itself will not determine the logical distinction of two sides in which the logical distinction of logical distinction and physical difference is to be 'physically' embedded. The logical distinction of the terms in which the logical order is to be inscribed in the physical order will remain as a question, a strange opening, something 'missing', 'in' the physical order. Conversely the 'logical' order or 'side' of our words cannot be quite 'abstracted' from the physical 'marks' in which the logical distinction of logical distinction and the physical difference 'by' which this distinction of logical and physical is 'marked', must itself somehow be marked. There will always be something 'missing' (or indeed, all too physically present) in the logical identification of the logical order as what is missing in the physical order. Neither 'side' of this dynamic of conversion can quite 'comprehend' their relation.

With the Knot embedded in the words of the Introduction we introduced a configuration of 'crossing' from one 'side' of a

distinction or difference to another: a configuration of 'crossing' from one 'side' to the other of the words, the book. With this converse order of inscriptions of the conversion of physical and logical 'sides' in either side, we discovered a coordination of the two 'sides' as indeed orders, orientations, in a common frame of conversion, symmetry. In this configuration we found a physical 'image' of these converse 'orientations' or 'orders', dynamics, of inscription of one side in another, in two 'sides' of physical 'space' of coordination itself: as converse 'times', two orientations embedded in the physical coordination of physical and logical 'orders' and a symmetric third 'poetic' order of their triple symmetry.

We found, that is, an image of the coordination of physical and logical in two 'sides' of the threefold symmetry as which the relations of physical, logical, and poetic were mirrored and inscribed in the physical order as its very frame, as a physical 'space' of coordination. - Two 'sides' of a Knot, of a configuration of 'crossing'. A 'knot' which embodied in a minimal way the closed symmetry of a minimal 'difference' or distinction: the difference whose very terms are different 'versions' of their difference, and which requires as it were from the start a third term - the difference 'between' two converse versions of their conversion. The 'logical' orientation of the words of the Introduction in which the Knot was embedded was reflected in a 'choice' of one of two possible embeddings of the Knot in the page of text. Through this coordination of the logical order of the inquiry and its image embedded in the text, the logical order of the inquiry was itself 'embedded' in the physical space of its context as one 'side', as a certain 'time' of the inquiry.

A figure that first appeared in the recognition of the logical order as what was 'missing' in the physical inscription of the distinction of physical and logical as two 'sides' of some physical configuration now appeared as a reflection in the Knot of a principle of inscription or framing itself 'missing' from the poetic symmetry of logical, physical, and poetic orders of the text in which the Knot was embedded. The 'choice' between what was 'open' in this poetic symmetry and the formally symmetrical order of what 'decided' from

what was open (and thus what decided the distinction between it and its mirroring in the poetic order, 'could not but choose to be Choice'), was reflected in the 'choice' of one 'side' or representation of the Knot and the other - was reflected, then, in the coordination of logical and physical 'sides' of the poetic order in this 'actual' difference, itself quite 'arbitrary'. This order, then, which decides between itself and its mirroring in the poetic order of the mark, in this decides, articulates, the difference and conversion 'in' their poetic symmetry, of logical and physical orders.

On the analogy of a supposed abstraction of a logical identity from the physical mark 'by' which it is marked, the elementary 'cofinitary' articulation of what is left 'open' in the finitary orders of the mark, in the symmetry and symmetries of logical, physical and poetic, was inscribed in the economy of that Symmetry as a configuration of 'formal' or 'imaginary' terms supposed to 'decide' what is left open in corresponding symmetries. - As, then, an 'imaginary' infinitary limiting term of each finitary order: the inscription of the cofinitary order which formally complements finitary symmetry, in that finitary economy of what is open, just as the identity of the 'logical' had earlier been imagined as a limiting abstraction from the physical difference by which the distinction of logical distinction and physical difference was marked.

At the close of the Introduction we recognised the expression of cofinitary Actuality (rather than its imaginary inscription 'in' the finitary economy of determination) as what decides the symmetry of what was open in this case, what decides, frames, this text 'among' all the possible words from which it is 'chosen'. - What in this actual configuration of words distinguishes itself from its inscription as one term in the finitary configuration of text. In the opening of this First Part of the text 'proper', of the 'body' of the work, into which the Introduction marks the transition (entry, crossing, opening), we have seen how that closing self-expression of the 'actuality' of the book, asserting itself in the words as what distinguishes itself in and from the mere marking of this very distinction 'in' the book, as what 'decides' the finitary expression of the symmetry and difference of self-expressive actuality and its formal marking - we have seen how the question arises of framing the 'space' in which this circuit of self expression which closes the Introduction, could be drawn, in which this among other circuits was 'open'.

This First Part, then, opens with the open-ness in which the closed circuit of the Introduction has been inscribed - in which that circuit was possible, 'open', at the outset. - Opens with the articulation of our directing question in this configuration of open and closed.

The Introduction, and the book as a whole, opens with the mere marking of a question: the question of this very marking. With the radical circularity, and what is radically open in that circularity, of giving an account of the different possible framings of this account of what is open. An initial 'mystery' lies in the fact, the actuality, of there being an account, of something, however questionable, going on, having begun, at all. The book opens with the opening mark, the actual marking of a question, as itself in question, and the Introduction closes with a 'circular' self-assertion of the actuality of the question as deciding what is most radically 'open' in the circularity of the initial question: a circular self-assertion which doubles, responds, corresponds, directly to the opening question - the self-assertion of the actuality of the question, of its marking, which is a first, introductory, step toward a full answer. The actuality reflected in the actual marking of the question of the different possible 'accounts' of this marking, expresses itself as 'deciding' what is undecidable in the open symmetry of the converse orders, the 'possibility', of a mark itself. What 'decides' what is open in the finitary symmetry of marking first and most simply 'expresses itself' in the actual marking of this question, the fact that the question is marked 'at all'. The mark simply as actual, marks this its actuality - marks 'this'.

Now this mirroring in the Introduction of a circular opening question (attaching to the simple fact that something was going on at all - a 'book', whatever that might be) - and a circular closing assertion, a corresponding 'response'...this itself prefigures the closing of the book as a whole, its order of conclusion, close, as 'direction' of inquiry, as 'corresponding' to the question attaching to the circuit of the Introduction, which opens this First Part, and with it the book 'proper'. In what 'space' and 'time' was that closed circuit of the Introduction 'open', possible?

A notional or imaginary 'physical' inscription of the closed circuit of text in an 'outward' frame of spatiotemporal coordination (a simple 'conversion' of the logical coordination of its terms in 'reflection') was not the answer. Rather must we now find some coordination of text and context which is reflected in the closed circuit of the Introduction in the Knot there inscribed, there mirroring opening question and 'closing' assertion.

The introductory circuit was 'open', not simply as 'logical' inquiry, logical symmetry of question and assertion, 'in' some comprehensive physical 'converse', not simply 'in' the space and time in which that logic was articulated, inscribed..but more radically 'open' in the symmetry of such a notional 'physical' determination or framing of the logical order of the inquiry and the converse 'logical' inscription of the relations of these two 'sides' of the inquiry 'in' the inquiry itself.

That latter frame of formal abstraction of the logical order of the inquiry from the symmetry of text and context (and of that symmetry from the further analogous symmetry of what is open in it and what 'decides' the actual closure of the text) - that abstraction in the book to a 'reflection' articulated in the simple symmetry of question and formal assertion, through the logical determination of the relations of logical order and the physical order 'by' which the distinction of logical and physical is marked - is itself mirrored in the physical inscription of relations of physical and (psycho)logical orders in 'some-body', in the two sides of a physical configuration of 'my' or 'your' body, and the physical coordination of this configuration of our several questionings and assertions with our physical confrontations with this text in different places and times, there and then finding in it our question or assertion.

The binary mirroring or 'converse' of two sides of such bodily questioning and assertion (two sides of some-body, (psycho)logical and physical) are inscribed in the ternary 'space' of physical coordination, and coupled to its 'two-sidedness', its time of logical and physical orientations, dynamics. Some-body is not simply

a closed interface of two 'sides', corresponding to some notional abstraction of a 'psychological' inside in its 'internal' determination of the difference of 'inside' and physical 'outside' (a difference 'outwardly' marked by two different sides of a 'body' or physical configuration): the ternary order of 'crossing' in which the body is embedded or physically inscribed, itself articulates a 'communication', a 'converse', a 'crossing' between the two 'sides', which is precisely the bodily locus of words...of our 'self-expression'..and this, in particular, in relation to these physical marks, the surface of this white page.

Corresponding in this configuration of 'converse' or mirroring of locus of assertion and question marked 'in' the text, and self-assertion and questioning in the confrontation of the text and our various 'bodies' outside, are various possible readings, readers.. an openness of 'you' as marked in these words. This openness, amounting in imagination to a systematic questioning of my assertion 'in' the text, by 'you', is associated with the converse orientations in our time, and the time of this text, of the closed circuit of my assertion which is for you past, and the open-ness of your questioning which is for me the future of my writing. 'You' remain 'outside' my writing even, indeed precisely, in my formal determination of this 'outside', this irreducibility, in these words: 'in' advance.

I, writing, am in my turn a reader of past writers, of past writing. My assertion, indeed, is embedded in the coordination of past assertion in closed texts and the openness of questions which oriented those texts towards a future: in some sense still my, still your, still our common Future, a radical openness of questioning. Such a coordination is indeed at work in the very terms I use here - in which past writers have left their ambiguous, questionable, marks. I may frame such a coordination in this text, but the text must itself remain embedded in a coordination of the various orders of its words which I mark in the text as its 'World'. In particular I assert myself, in writing, 'in' this World or worldliness, in the coordination of a converse of physical and psychological 'sides' of my 'embodiment' or incarnation, with the surface of these pages, and the coordination of terms taken from other pages 'in' them. Terms as it were bodily taken from other books, in my bodily confrontation



with them as 'their' reader.

In this text, then, I as writer assert its inscription in its World: 'in' a wider coordination of which it is one dimension or order - framing its own inscription in this 'wider' frame. In the finitary configuration of marks which is the text I 'mark' (and mark as 'uncomprehended' in the text) an ontical order in which my writing is actually open, and a psychical assertion, an order of 'circular' self-assertion, which mirrors, corresponds to, responds to, what is thus open 'to' it. The marking in the text of the various orders whose coordination frames, 'decides', the actual text, the text as actual, amounts to the inscription of the text in a 'mystery', a question posed in the text by its very 'in', its sided-ness, but whose answer is itself determined in the text as 'outside' its finitary determination, 'incomprehensible'.

To set the text to 'work', so to speak, we must then play our part both 'in' and 'outside' the logic of the inquiry - play our part in articulating the mysterious coordination of what goes on 'in' the text, and what this marks 'outside'.

What might be a minimal configuration of this 'mystery' in which the text marks itself as one component? We must discover the poetic order of a 'story' in which the logical order of this inquiry or questioning mirrors the physical order of a World in which the story, and in it this logic, is 'physically' inscribed, 'embodied'. - A 'story', a configuration embedded in the simple physical coordinates of a space and-time, the whole here framed in a configuration of terms, of which the configuration of terms or frame is itself one term, one component. We must embed the logical order of the inquiry itself in the configuration of Word in which it marks itself as one component, one term. - A 'story', or rather an action of which any 'story' is so to speak one 'version' open in the configuration of action and story, text, in their 'World'. An action, then, to which must in principle correspond an open variety of stories..to each of which stories, in their turn, would correspond a range of possible actions, sharing that given account.

We must, I must, then, here frame some 'action' in which this its framing, its story, identifies itself as one term or component. An action which 'mirrors' the simple marking of its logical, physical, poetic, psychical, ontical, mystical orders in the logical order of this inquiry, in the elementary physical frame of the action. My part in the 'action', then, lies open as a question in the circularity of giving a story which will tell its own part in that of which it is a story. Indeed my part is simply to identify this openness of the configuration in which this inquiry is one component, as open to the elementary psychical order of my assertion of it, my self-assertion in it. A self-assertion, open 'physically' in the coordination of my embodiment and the physical 'embodiment' of this text - or rather in the physical configuration in which the writing of this text is 'open' to me: this configuration itself marking an ontical actuality which invites my response.

This writing, then, open to me in the simple configuration of the different orders 'of' the text (marked in the text in relation to the text), is itself a participation 'in' the action it frames - is one activity 'open' in the configuration of my embodiment..the activity of telling a story (of an action), which then enters as one component of a 'past' in which a new range of action is open to me and others, a new configuration of action is 'open' to our 'self-assertion' in which the self-assertion in words (say, giving an account of our activity of speaking or writing, or of any other action) is so to speak one 'side' of a general self-assertion in what is 'open' to us - in 'action'.

'What is open to us' in the configuration of our physical embodiment: our 'part' in that configuration..and in particular the part of framing 'that' configuration, framing what is 'open' to us.. framing our very 'part'. - In the minimal case framing our very part of framing, in the elementary figure of self-assertion as 'I'.

Common to our parts of writer and reader (here) is a 'past' of these words, this writing, which frames what is now 'closed' in the configuration of this writing and reading - and in this also frames

what is open to me in writing this book. What I choose to write is then a part of the configuration of reading, part of a past which frames what is open to the reader's further reflection, his or her questioning and assertion.

Now this framing of an 'action' in which the framing is itself to be inscribed as one component, must frame its 'part' in a poetic, (hi)stori- cal, dynamic of opening up of parts, and of what is in its turn opened up by the new configurations of what has been chosen from what was open 'before'. But what of the 'opening' of the Action as a whole, corresponding to the beginning of a story now to be told, which will close when it reaches this very telling of the story itself? Must we mark as a Beginning some 'opening-up' of 'the World' as radical configuration of our telling of the story?

But no: that would be to inscribe the dynamic of Past and Future, to inscribe the Action, in that physical 'side' which is itself to be considered as one of two 'sides', reflecting the logic of this inquiry in a more radical order of this mirroring. We have already seen that this mirroring is not to be considered as inscribed in some 'physical' context as primary...so the story does not begin with some opening up of Space and Time from some initial physical 'point' from which a unitary Past would unfold. 'The' past, that is, is 'itself' in a way radically open - a 'figure' in the play of framing, rather than some comprehensive closed-ness of What Has Been in which a definitive 'history' might be supposed articulated.

... Such a formal 'Past', indeed, may itself be inscribed in the 'past' of this book, as a term transcribed from one configuration to another, and so organising, through a certain coordination of successive framings, a certain 'identity'.

No: the 'opening' of our story or history lies rather at that 'point' in the 'past' of this telling of the story, in which a 'part' of framing our part in the configuration of Word, becomes 'open', and so marks an opening in the configuration of embodiment and text, story, as a whole. 'That point': but indeed such a 'his-

torical' point is, precisely, radically open 'in' the past of this account to various different accounts. 'It' corresponds rather to the configuration in the past of a question corresponding the formal 'opening' of our story, of the action in which this its account is to be inscribed as one component. 'Theologically' the question has in our past been inscribed in a limiting coordination of the logical order of assertion, and its physical mirroring in a comprehensive Story or History of Creation from an initial 'point' of Space and Time: inscribed in that formal limiting Frame, World, as a 'turning-point' in a universal History.. Mystery focussed, marked, in the World it frames, as a definite configuration of an 'Incarnation of the Word' at a precise point 'in History'. A question posed to each of us since that point (then) in the, through the, formal self-assertion of 'I AM', of a limiting theological 'I', in the subsequent configuration of our multiple embodiment as 'I's.

Yet the mystery here - rather than its 'mythology' - lies precisely in the opening as a question: as the configuration in our past of the marking of the question attaching to the circularity of our part of framing our part. - A question in which we now find ourselves bodily involved or implicated, in the configuration of our embodiment or incarnation and the various texts or stories of this marking of the question. The 'initial point' must remain radically in question, because it marks a question attaching to the part of any account of it as one order or dimension of the question. What is marked 'as the question about which this opening First Part of our story is articulated, attaches as the question of our part(s), open to us in the very configuration of our bodily confrontation of the texts among which this text in particular is inscribed. We have as it were an irrevocable 'responsability' in the World in which this question is marked: a question which so to speak physically confronts us in what is 'open' in the configuration of our bodily confrontation with books or stories, and which, attaching directly to the figure of our assertion itself, cannot be 'abdicated'. The question is not so much 'in' The Past, as the very frame of what in each past is open: a constant Presence.

Now the actuality of this configuration, this 'historical' configuration of a question or 'mystery' in which the logical order of this inquiry marks itself as one component, is 'outside' the formal or finitary configuration of the text, and yet is marked (or remarked) in the text as the question attaching to the radical open-ness of coordination of its various orders, within which the text is itself 'decided', definite, actual, actually this text...within which the various components of this 'deciding', this actuality, are coordinated. - Within which, in particular, our part(s) of framing the actual configuration of the text in some story or account of it, is coordinated with the outward configuration of our bodily confrontation with the text, in which this 'part' of framing (and the part of framing our part as 'framing') is open 'to' us.

Let us, then, try and mark this mystery of the 'Story' or Action, of which the framing here in this text identifies itself as one component (partaking of the 'logical' order of the Story or Action, outwardly reflecting a converse physical order, and so on), in (or 'with') this text..as a question posed for, to, writer or reader in the configuration of his or her bodily confrontation with this book. A question in which the radical circuit of the 'mystery' of the actuality of the configuration(s) of this confrontation lies as it were 'open' to us in a question marked in the configuration by this book: the question of our 'part' in the mystery, the Action, its Actuality.

'Our' part, our parts...'I' as the formal locus of our self-assertion, and of the 'question' in which such assertion is 'open' to us, to the 'I' that we can assume...by which we can 'mark' our self-assertion, in this configuration ('these configurations').

A 'psychological' order of 'I', then, whose 'outward' converse is the spatial and temporal multiplicity of 'our' confrontations with this 'I', in the spatiotemporally multiple physical embodiment of this texts as the 'same' book(s) in different times and places of reading and writing.

Now some version (say this one) of what is open in the configuration of bodily confrontation with the order of texts, 'stories', itself contributes to what is subsequently open in further instances of such confrontation. The circuit by which a version of the configuration is itself marked in, say, a book, in its turn becomes a component of the wider circuit by which the 'past' of a subsequent instance of confrontation with stories, texts, is 'closed'..and, in this circuit of what is closed in the subsequent instance, leaves open once more the part of giving (another) version of what is open in the confrontation with the order of words, in the perennial interface of Past and Future.

That is: the order of assertion 'in' a text or account, of what is open in the configuration of bodily confrontation with texts, marks, words, is doubled by (mirrored in) an order of questions, of open-ness, in situations of bodily confrontation with that 'closed' account, that assertion of the part of assertion open in confrontation with texts, that text.

Thus we may find the figure of the 'economy' of conversion of 'logical' and 'physical' orders of 'the' text, in the interplay of physical and logical orders of inscription in a text, of some 'version' of what is open in the configuration of physical confrontation with texts. In the elementary 'symmetry' of such interplay, we may see the part of assertion of the part of assertion in the configuration of confrontation with texts, words, doubled or mirrored by what is open to a 'you' to which the assertion is directed, 'outside' the marking of the assertion in a text, and 'in' the future 'of' that marking.

That is: a dynamic of 'versions' of what is open in the simple symmetry of 'inside' and 'outside' of texts is itself open in that simple 'conversion' of logical and physical orders. For example we may find a simple economy of 'criticism' in the dynamic of successive writings of readings (of prior writing - prior 'writing of reading' among it). - The 'critic' as the part of assertion in a text

of standing 'outside' the configuration of assertion in some prior text or story.

For the moment we are concerned only with the dynamic or economy of 'versions' of the configuration of 'version' simply as such: a dynamic of successive 'deciding' of what presents itself as the question of our 'part' in our confrontation with different accounts of this 'part'. Different 'versions' of our 'part' as what is open to us in the configuration of bodily confrontation with stories ('in' books or otherwise) are themselves different responses to what is open in different instances of such confrontation: different assertions by different 'I's, of that part of assertion. Different responses to what is open to us in the simple configuration of the marking of what is open to us, in its configuration, by this simple text, mark, 'I'. Different instances of that - indeed this - confrontation, in which the texts of different responses in prior instances, are themselves components of the textual order of that configuration, themselves contributing to what is open, what is then 'in question'.

A dynamic, then, of 'deciding' what is formally open in the 'logical' inscription of the text in a wider configuration of coordinate orders - its economy articulated in the 'poetic' symmetry of that 'logic' and the physical order of writer and reader confronting the text(s) in which the logic is 'embodied'. Different 'parts' of framing, asserting the 'part' of 'I' are opened up by the successive marking of such 'deciding', in the configuration of words which will then frame what is subsequently 'open'.

What, then, of the opening-up of this circularity of the 'part' of framing what is open to 'I' in the confrontation with the order of stories precisely as 'part'? What of the 'opening' of this part of the part, in the 'past' of this book? How inscribe this circuit of self-assertion of 'I' (or 'in' 'I') in the figuration of this text, and thereby inscribe the logical order of this text (and of that inscription in particular) in the mystery of what 'decides' its actuality 'from' what is formally open in the symmetry of the various orders of the text already marked.

We might begin with a limit-version of the inscription of this opening of the part of 'part' in the dynamic of versions...that is: in the dynamic of versions of just this same dynamic. - A mythology, a 'theological' version, in which the open-ness of the dynamic or economy of versions, is itself inscribed as one term in the closed circuit of the 'definitive' version: as the term in which the circuit of a theological actuality of 'Creation' as a whole, 'decided' in the open possibility of Actuality as such, closes in abstraction from that open-ness. - Or closes, rather, in the concretion of a Creation, a closed 'Universe'. Within such a scheme it is the locus of enunciation of this version, this universal Frame of History, in the version, in 'History', in 'Creation', which constitutes so to speak the axis around which the mirroring of Mystery and Economy is inscribed in the universal Mystery. The axis: or indeed the focal point in which the closure of a Past in which the central enunciation is 'prefigured' ('prophesied') is mirrored in the Future opened up by the inscription of the true version of Creation and our part in it in the dynamic or economy of versions (and corresponding 'parts'). - Then our part, after the revelation of the true version, is 'already' framed for us as what is open to us in our subsequent confrontation with that true version, with its circular inscription of the question of our part with which it confronts us ('from our past'), in that story or version of the configuration of that story in the wider universal History. In that History articulated from the outset (so to speak: 'from outside the mirroring of Past and Future', 'from outside Time') in the simple mirroring of closed Past and open Future in the central 'point' of Time, in which our part can be in principle inscribed in that Future of the enunciation which the enunciation itself frames.

In such a limiting formal coordination of the various orders of text in a unitary Mystery of Creation of which universal History is simply the 'outside' ('in' Time), the configuration of the 'logical' order of framing the inscription of the logical order of assertion of a true version (and corresponding true playing of the part of 'I', responding to the possibility of this assertion - and 'participation') in the universal Frame of History or Creation, is simple and symmetrical. Thus 'in' the economy of universal History the physical order in which Creation is a possibility, is formally 'open', is itself articulated in an image of the distinction of the



closed ontological actuality of a Creation, from the open economy of its possibility: the physical order is articulated in a mirroring of two 'sides', the finality of Heaven and the open economy of Earth. The actuality of a physical Creation distinguishes itself from the inscription of that distinction in an open economy of physical possibility, and in this 'decides' and articulates the actual physical order within a wider coordination of complementary orders: this articulation of the physical order as the reflection in the physical economy of the distinction of a 'heavenly' actuality from the mere formal possibility in the physical economy of this distinction, is simply mirrored in the self-expression of a psychological or spiritual actuality of self-assertion, articulating the logical economy of stories, about the distinction in that order of the text (most notably in the configuration of Book or Text par excellence), of the psychical actuality which distinguishes itself from its merely formal inscription in the text, in the Letter and its Law. And what is 'open' in the mirroring of these two actualities - this, then, in the 'poetic' order of mirroring of logical economy of stories and physical economy of their context - is 'decided' by the theological articulation of History as a reflection within the economy of a universal Law, of the distinction of the actuality of (actual) History, from what is formally open 'in' its laws, its poetic economy of action and interaction.

Within such a formal coordination of 'heavenly' Mystery of Creation from 'earthly' Economy (remembering of course that the interplay of Heaven and Earth is itself the earthly image which reflects the heavenly actuality of the whole Creation of which these are two 'sides'), the articulation of Creation as an Action corresponding to a unitary story of the inscription of its Story in the Action (and so, then, as one component of the Story itself), is framed in the interplay of different versions of the configuration of bodily confrontation with the order of the definitive Text, with the various coordinate orders of their actual configuration. Bodily interaction throughout the whole scheme of universal History is articulated, for example, in direct coordination with the different 'versions' of the universal Frame and their parts in it, in which the various participants bodily assert themselves in word and action.

This interaction, then, articulated in terms of coordination of versions in the true version, is eventually focussed in a configuration through whose Past (with its various component pre-figurations) the question and 'part' of radical self-assertion in the 'bodily confrontation with the order of stories, texts', first becomes 'open'. More particularly, in the limiting 'theological' version now in consideration, it is precisely in the seminal or germinal inscription of what will become the bodily instance or locus of assertion of the true version, the 'Good News', in the 'earthly' economy, in that 'out-side' of the Mystery (itself of course one side in the Mystery), the configuration of this 'Incarnation of the Word' at the exact mid-point of Time and History, which opens that part. - And this 'mystery of Incarnation' itself framed in a young woman's assent to the story of her part in History, a heavenly self-assertion of 'Spirit' in the configuration in History, in its universal Economy, in which she found herself bodily confronting such a story, the 'opening', 'revelation', annunciation of that critical part.

The part is then formally open, in the configuration of the young woman's assent, of framing the bodily confrontation with the order of the Text, the Book, as frame of our part. Such a figure of our part as a question open to us in our confrontation with the order of the Book: the question of Heaven or Earth, of circular self-assertion of actuality, or imprisonment in a complementary circuit of a mere image of self-assertion in the economy of Earth - such a figure as itself asserted, itself inscribed in the economy of stories, then frames the story of an Action, of a Future, articulated by the complementary heavenly and earthly sides of the dynamic of reaction(s) to this story, this Good News - this simple figure of the bodily confrontation with the order of Text as framing our part as question, itself now inscribed in the order of Text: in the past of all future confrontations with texts, stories - as an ineluctable figure, then, thenceforth attaching as question to every subsequent 'part', every-body to whom the story would thenceforth be transmitted.

...So much, then, for a formal theological inscription of the logical order of its framing in the circuit of an Actuality formally inscribed in the abstract Economy of what is open in the symmetries of the logical, physical, and poetic orders. This theology of inscription of the relations of Mystery and Economy in the closed circuit of a unitary Mystery of Actuality or Creation is, of course, only one side of the actual configuration of our bodily confrontation with this book, these books: Mystery formally, 'mythologically', abstracted from the symmetry of closed Mystery and open Economy. A version of the configuration of our confrontation with a certain figure in the historical dynamic of reading and writing - or, more generally, question and assertion - which 'abstracts' from the actual configuration of our confrontation with that figure in a variety of versions, as marking the question of our part. A version which abstracts to a sort of 'missing original', a unitary 'true version' as it were 'behind' the differing historical versions of the opening of that figure of our part: which 'mythologically' converts a formal frame of coordination of those versions, a frame of coordination of questions, in which we find ourselves bodily implicated in our confrontation with stories, into the closed circuit of assertions in which those questions may then be supposed 'in principle' resolved.

Thus to arrive at the 'mystery' of inscription of this question of our part, of what is open to us in the order of questions open in the logical determination of the relations (symmetries) of the logical order of our inquiry, and the coordinate orders of its 'context', in the economy or dynamic of reading and writing, question and assertion, now identified or marked in this text, we must go one step further, and consider the wider configuration of a mirroring of that formal theological or mythological circuit of a unitary Mystery which 'decides' Actuality as a universal Whole, and a complementary open-ness of inscription of different versions of an 'Incarnation of the Word' in an 'earthly' dynamic of stories. Thus, in particular, we must consider, in the limit, the simple 'atheological' conversion of the heavenly circuit of a unitary Mystery into a primary economy of stories in which this 'true version' of things is simply one story among an open variety: in which the distinction of theological actuality from the formal inscription of its self-distinction from the order of the Mark in that order, is

in its turn identified as a merely formal definition of an altogether 'imaginary' or 'fictional' order.

Each of these symmetric 'limits' - the 'theological' inscription of an 'earthly' Economy in which the Mystery is inscribed, as one term in the Mystery (of Actuality as 'Creation', the infinite limit of the 'poetic' order in which it is supposed 'decided'); and the 'atheological' inscription of that theology of comprehension of Economy in Mystery, as in its turn one term in an utterly open universal Economy - each of these embody symmetric and complementary abstractions from the actual configuration of the textual embodiment of that 'version'. Thus the theological circuit supposes a 'true version' so to speak behind the actual versions of 'the' mystery of Incarnation of the Word: a sort of heavenly exemplar of which the various conflicting versions of the Truth, embedded in the earthly economy or dynamic of stories, are so many 'reflections', coordinated in the true heavenly version precisely through the coordination in a universal History of the various loci or circumstances of their assertion, enunciation. Yet such a formal principle of 'deciding' between conflicting versions, like the theological principle of 'deciding' Actuality or Creation itself 'in' the open symmetry of logical, physical and poetic (and psychological, ontological and theological itself), actually operates in, is at work in, the earthly economy, as a sort of 'direction' in which a certain order of coordination, accounting, proceeds: a theological economy indeed, proceeding towards a supposed limit-point of simple Truth, Decision, Actuality, 'Authority', just as the supposition of a universal History operates in the open economy of conflicting versions, to organise a certain narrative economy, which in its turn plays its own (ambiguous) part in the historical development to whose subsequent 'interpretation', in whose subsequent 'accounting' (so to speak), it will in turn be once more applied.

On the other (symmetrical) hand, the supposition of a radically open primary frame of universal Economy, in which these theological and historiographical 'economies' might be supposed inscribed

('atheologically'), abstracts from the radical actuality of the assertion of such a complementary 'version'. The assertion of the open universal Economy in that supposed Economy itself draws a radical circuit of 'psychical' actuality which cannot be framed, decided, in the very open-ness it asserts. This 'psychical' actuality of the 'atheological' version (whether in the promethean figure of self-assertion of human 'freedom' against formal theological authority, or otherwise) is simply doubled by the ontical actuality of the situation or context in which this radical self-assertion is 'open'. And the articulation of these two 'sides' of the 'atheological' version itself partakes of that 'mystical' order which 'decides' what is otherwise 'open' in the symmetry of psychical and ontical actualities - their 'poetic' symmetry 'in' the open 'Economy' or Law or Symmetry of logical, physical and poetic.

What, then, of the mirroring of these complementary inscriptions of Mystery in a 'theological' economy, and of Economy in the mysterious actuality of the question open in the symmetry of Mystery and Economy - an actuality which cannot in principle be comprehended 'in' the otherwise absolute Symmetry and Open-ness of Law, Economy?

We may, for example, find in various versions of 'the' mystery of Incarnation of Word, versions subsequent to the formally identified zero-point of Time in an Annunciation itself only included in relatively 'late' versions, figures of inscription of their inscription in an 'earthly' economy in a 'heavenly' mystery: we may find the figure of a marking in these versions of a duality of mystery and economy in an order of transfiguration: of the transcription of inscription of the 'version' in the earthly dynamic of versions (which is one term in that story), into the heavenly order of mystery. More particularly, we can find at work in the duality of Economy and Mystery in the actual configuration of some version, some story (of our part of framing Creation, and so of our very part, in it, itself), the figuration of our central participation in this duality ourselves, as we confront the story and face the question, open in this duality, of what to make of it.

In the simplest configuration of what is thus 'open' to us as a 'part' in the configuration of text and context (in which we are already engaged simply by writing or reading this inquiry into the

'question' of this book), then, we may identify the recognition of this 'part' as simply question, as something 'open' to us, in the coordination of orders of question marked by the simple fact or actuality of this marking itself. That is: we may find an initial figure of the complementarity of Mystery and Economy, and the question of our 'part' in that mirroring, in the simple marking of what is open in that complementarity or symmetry by the actuality of the very question itself, which presents us with the question of how it is itself 'decided' in this open-ness it presents as a question. In the simplest configuration, it is the very question itself which is the most radical mystery, actuality; the configuration of the various 'primary' orders of question or open-ness in the configuration of marking of these questions itself.

What, then, is open to 'us', to these two sides of 'I', I who write(s) and I who read(s), 'I' and 'you'? I, writing, have inscribed the book as marking this question in an actual economy of stories..but the formal point 'outside' the logical order of the book as inquiry (inquiry into its own actuality), where the radical 'theological' deciding of the various orders of open-ness marked by the book as question might be supposed marked, itself turns out to be the formal projection of a point at which the actuality of the book might be supposed decided, from within the book: a formal conversion in the book of the question discovered in the book into a formal 'Authority' marked in the book as 'outside', at a mid-point of Time in the Past (of this its marking).

...And yet, if that 'midpoint of Time' be itself a sort of missing point, yet it does correspond in the 'context' of this text to the imaginary focus of one side of the wider configuration in which the book is to be inscribed: the 'mythological' side, an economy of abstraction of Mystery from its inscription, marking, in 'earthly' Economy. How, now, are we to proceed from this 'theology' of this book (that 'theology' in which the book formally inscribes itself, it might be supposed, as a component of the subordinate logical order of the earthly Economy inscribed as a whole in the theological economy of unitary

transfiguration) to the marking in the book, the marking by the book, of what is 'open' to us in this configuration of its marking? How - that is to say - is the logical order of this book, this inquiry, to be inscribed (as I write: how is it already inscribed, as it is read) in the economy and dynamic of 'versions' of inscription of such 'versions', from which the formal 'theological' framing of Mystery abstracts? For with its inscription in a coordination of orders - a coordination of which a unitary closed Mystery, and the complementary open universal Economy in which the circuit of that Mystery, closing in the marking in it of its Economy as one term, is supposed drawn, are two 'sides', two complementary abstractions, circuits - with its inscription in such a coordination, as marking in that coordination the reflection of the coordination of orders of the mark, in the logical order of the mark, the inquiry itself closes. - Closes in the inscription of the inquiry itself as one component in the logical order, whose coordination with the correlative orders of its 'context' it frames.

In the first place, we may note how this order of 'closing' of the inquiry, its articulation as inquiry in the logical order of opening of questions and closing of answers, conclusions - in the logical economy of inquiry organised by that 'finality' of closing as a direction of Time 'into' an open Future - itself amounts to an initial inscription of the text in that logical or psychological 'side' of physical Space, that 'forward' orientation in 'Time', that 'finality' of Reflection. In particular, I, writing, may remark how the question opened up here in the logical dynamic in which this text is itself (physically, even) engaged, is framed for me by the formal symmetry of the logical, physical, poetic, psychological, ontological and theological economies of inquiry in the immediate past of this writing, this questioning. - By 'limit' questions arising latterly in the course of those 'historical' orders of inquiry, in which the circuit of abstraction from the economy of questioning or inquiry 'in general', by which each 'field', each 'inquiry', each theoretical genre, indeed, is 'framed', 'constituted'...in which this abstraction of each genre from the order of questions 'in general', itself comes into question. - Comes into the question posed by the symmetric articulation of these constitutive abstractions, in the radical configuration of our bodily confrontation with the very books 'in'

which these inquiries are 'carried on'. - Comes into question as what is 'open' in their symmetry, in the configuration marked by this book as 'question-mark', as an inquiry into the process of inquiry being 'carried on' in, through, it.

That is to say: this book as itself 'in question', as marking what is open in the coordination of its various orders (from which coordination in the book, together with their embodiment in 'that' particular book, the various economies of inquiry have in the 'past' of this inquiry abstracted), itself belongs to, inscribes itself in, a 'past' economy of questioning, of inquiry: at a sort of convergence of parallel and coordinate orders of inquiry in the 'limiting' or closing question of that finality, that order of closing, that economy, of inquiry itself.

What, then, is 'open', 'to us' in the configuration of this book - the question (that is) 'marked' by this book, these copies of this book - the question of our parts in the configuration(s) of this writing and reading - is itself the question posed 'in' or by - the question of - the close of a certain 'story', of a poetic order of coordination of logical inquiry and physical context, a 'story' of what first appears precisely as 'telling the story' of, 'accounting' for, the configuration of this 'inquiry', ἐρωτήματα .

A story, then, which opens in a place and time in which 'inquiry', the economy of questioning abstracted from its mirroring in a complementary physical economy of the questioning, through the elementary 'logical' circuit of inscription of the relations of logical and physical orders of the mark in the logical order, is marked, not as 'inquiry', but as 'ἐρωτήματα', or rather as the string of marks of which that is a later transcription.

Now that 'opening' of the story to be traced in the words, the marks, which follow these - of the story articulated as inquiry



by the 'finality' of its closing, coming 'full-circle', in the inscription of itself 'in' the close of the 'history' it frames (as 'marking' the closing configuration of that story or action as the configuration of this its marking) - itself belongs to the 'past' of the missing theological 'midpoint' of earthly Time. And the coordination as 'opening' and 'closing' of the story to follow, of an inquiry or questioning, a 'theory', opening in the part open in the coordination in the order of the Mark of the symmetries of that order in its 'context', and closing in the part of identifying that opening as beginning of a story, of which this identification marks the close...-that coordination of opening and closing of a story, in the Past and the Future of the formal 'theological' zero-point, allows us to give a 'version' of what is open in the physical confrontation with the textual order in which various different (and sometimes conflicting) 'versions' of the opening of that configuration - various versions of the 'missing' true version - have come 'down' to us through the past of this book.

...Allows us to frame what is open to us as 'part', in the configuration of our various confrontations with this text at different places and times ('your's' all in the 'future' open in the present writing), in the symmetry and coordination of the various orders of the Mystery and Economy of this book, these books, in the actual configuration of that symmetry, of what is actually open to us 'in' it. In particular, it will allow the framing of what is abstracted 'theologically' as the circular inscription of Economy in Mystery defining an exact 'midpoint of Time', as rather an organising question, the formal focus in that 'midpoint', of a coordination of questions in which this First Part - formally turning about that 'zero-point' - is articulated, inscribed.

Kosmos

The story opens with the figure of Story, Inquiry. With the opening of this figure of coordination of the various orders of telling a story. With a story whose telling is identified as one of the primary components of the story. And this configuration of Story is just what coordinates over Time and Space the opening marking of the figure, and this closing identification of that opening.

Inquiry opens as what is open in this initial figure of inscription of the logical order of its telling as one component of the Story told. With this configuration opens a 'logical' dynamic of inquiry, a dynamic of closing of what is open in that initial circularity, which closes in the configuration of this identification of the opening. And this identification is itself open in the mirroring in the figure identified, of the configuration of its identification: the coordination in that figure of Story of the various orders, logical, physical and so on, of relation of opening and closing configurations of Inquiry. This 'circularity' of identification of a figure of coordination through the coordination in that figure of the various orders of identification, is itself identified with the circularity it identifies as opening of inquiry.

The story or inquiry opens, then, in the coordination of the various orders of correlation of opening and closing configurations of marking that coordination. Marking that coordination of the various orders of the mark. Marking of the symmetry of the various orders of what is first marked as *Kósmos*, as articulating the order of assertion of this symmetry in its symmetrical coordination with coordinate actualities in a cosmic Story, History.

Marked as *Kósmos* in what is here marked as 'greek' and 'past'. Marked as greek, in 'english', now as I write, this Summer in England.

Thus a 'story' or action articulated in the 'cosmic' symmetry of the various orders of Story opens in Greece, and closes in the 'cosmic' configuration of this telling of the story in England. How then, to begin with, might we hope to coordinate the Greece and England of these opening and closing configurations in a common physical order, a common Space, and coordinate, say, this 'outward' correlation of the two configurations with their 'inward' logical correlation, in the Time of the Story? What, say, of the 'logic' of distinction of Greece and England, or of those correlative sets of marks, marked in 'english' as 'greek' and 'english'. What of the physics of english Summer, what of the ontology of 'Greece'?

Such odd questions must be confronted in due course. In the 'course' of this inquiry which opens out of a bare correlation or mirroring of opening and closing in a 'Kosmos' of which opening and closing are simply two markings. - Two markings of this elementary coordination of orders of the mark, which itself coordinates these two configurations of its marking. Two markings of Kosmos in Kosmos; two markings of the common order of their coordination, their coordination in their separation, physically, by a certain time and space, in which the opening marking is in the 'past' of this closing marking of their relation. An opening configuration of 'inquiry' in which this inquiry (and the Inquiry which is its object) opens: and whose order or finality of 'closing', conclusion, is defined precisely by the circularity of an identification of a figure of Reflection in its past, by the coordination 'in' the figure identified, of the various orders of identification, of relation of what is identified and this identifying. Thus the 'historical' coming-into-question of successive inscriptions of a logical order of inquiry in a 'Kosmos' it frames, now to be traced in the dynamic of question or 'criticism' opened up by an initial identification of 'Kosmos', is at the same time the inscription of this order of identification, this book (these books), in a progressively articulated coordination of its various orders. A coordination which 'closes' literally with the closing of the book at the 'end'.

Now the bare coordination of opening and closing with which the 'story' or action opens marks the opening configuration precisely as a question: as what is 'open' in the initial inscription of the

logical order of its marking in the coordination of this logical order with the other symmetrical or correlative orders of the mark. - As what is 'open' in the inscription and articulation of its identification or marking in 'Kosmos'.

An opening question: indeed an opening mystery. For the 'logical' order of identification of Kosmos is inscribed in that Kosmos it identifies precisely as a silence: as a question. And as a mystery articulated in the response of the individual confronted by that silence to the question posed by its configuration in the various orders of the - missing - words.

'Their silence was extraordinary', 'the strictness of their secrecy is astonishing'. And it is precisely in the mirroring of the configuration of this silence - and of its subsequent 'breaking' - in the configuration of identifying that silence as the 'mystery' of Kosmos (this at this 'close' of a story opening out of that silence), that the pythagorean mystery becomes our opening question: what is radically open in the opening configuration of an inquiry into inquiry itself. And in framing this opening we are already asserting ourselves in the opening configuration, just as in questioning the opening of the book at the outset, we had already set out into this book. That is to say, in framing pythagorean silence as mystery of Kosmos we as it were make a first step into the mystery of Kosmos, which we will find reflected in the first step - by Parmenides - 'out' of that pythagorean silence, into the mystery of an actual assertion of Actuality.

How is the initial assertion or framing of pythagorean silence here, in the configuration of this book, a closing mirroring of an opening mystery?

Well, first of all, this book defines, like pythagorean silence, a group, a circle of writer and readers, two 'sides', I have suggested, of what is marked in it as 'I'. - A writer's assertion corresponding to a reader's questioning. This symmetry of writer's assertion 'in' the logical order, and the reader's response in the physical configuration of confrontation with the mark(s) of this

assertion, is an elementary instance of the circuit of 'community' defined by common participation in a dynamic or 'economy' of the logical and physical sides of a set of marks: the 'community' which amounts to the elementary poetic frame of an action told in a story - which amounts, in particular, to the poetic frame of interplay of logical and physical 'sides' of this story - of their complementary 'economies' in which this book is itself to be inscribed as marking (as a question) what is 'open' in the configuration of its various orders.

Now the pythagorean group appears from 'outside' as framed not so much by communication through some set of terms taken from the wider set of greek 'language' as a whole..as by a common silence. This silence, or marking of an absence of terms, provides a limiting case of inscription of the order of marks in the configuration of its 'context'. In its outward configuration the silence marks a question. ...Marks, indeed, a mystery: for what was pythagorean reflection, how was the logical order of their discourse articulated 'in' that silence, as its frame?

How can we hope to tell? We have only later versions which, insofar as they have come down to us, and are not framed and hidden in silence, must in some sense say, tell us, something other than the 'meaning' of that silence.

We have only later 'versions' of the order of language in the group, later 'publications' of the logical order framed in that initial silence with which, out of which, the story opens. Yet here we are not in quite the same impasse as with the mystery which includes as one term the structure of subsequent 'versions' (and indeed prior versions or prefigurations). Here we have the 'true version' directly before us: as simply the question marked by that silence, the configuration of that pythagorean silence in its 'context'.

How can we enter 'into' that silence, and the question or mystery it presents? Simply by recognising in the configuration of the pythagorean silence, in the configuration of our historical confrontation with that silence, the familiar question of our part in

in the configuration - the part of our assertion as response to what is open in, the question 'in', this configuration of the silent group. For we know that the 'symbol' of access to, and closure of, the pythagorean 'circle', was simply a symmetrical arrangement of ten points, marks - which, we will shortly see, marks the configuration of coordinate orders of the mark simply as such, in the order of the mark. This configuration of marks thus frames not only the closed circle of silence, and the initial access to that circle for the 'initiate'...but also the elementary configuration of our access to the silence - of our initial assertion of our part in the scheme posed as question by this silence, in the simple marking of our assertion in the symmetry of various orders of marking and assertion - the marking of our assertion as response to what is open in the symmetry of those orders, and as breaking of the silent question posed for us in our engagement in that 'cosmic' symmetry. Breaking of the silence in the elementary figure of 'psychical' self-assertion - assertion of the part of assertion in the symmetry of its various orders which it thus initially frames - and in this elementary circuit of a self-assertion which responds or corresponds directly to the configuration of pythagorean silence, a first step into the logical order of assertion and question framed by the silence: an 'initiation' in the pythagorean mystery.

A first step, then, of the simple assertion of that mystery or question as that of Kosmos: of the symmetry of the various orders of assertion (and question). And with this assertion 'in' the pythagorean silence, the story opens - if indeed it has not already opened in the silent question posed by the pythagorean silence, just as this book as a whole had already opened in the marking of the question of opening it, the marking on the 'outside' of the opening as 'open', as possible, as a question...before 'I' opened it.

A first step: and the first step in coordinating the various subsequent 'public' versions of the mystery, precisely through their relation to the initial silence in the 'cosmic' coordination of the various orders of that silence and its subsequent versions - including, of course, this one.

An 'esoteric' language or logic of the pythagorean group, then, articulated in the inscription of the logical order of question and assertion in the symmetry of its various orders as 'Kosmos': and in this initial assertion of the frame of psychical self-assertion (which frames consequent questions and responses) a discovery of one's part as 'soul', as 'heavenly' psychical actuality, in the 'drama' of cosmic actuality of which this is one component: our part of intervention in Kosmos, in the cosmic articulation of our assertion of Kosmos in the coordination of its various orders as an 'action', 'drama', story.

And in this cosmic drama, in Kosmos as Drama, the configuration in the Drama of access to Kosmos as Drama (the dramatic discovery of ourselves as 'actors', of our part, which had previously been that of unconsciousness of our activity as 'part') is presented as the psychical order of the Drama inscribed in the earthly Economy of Kosmos, as a question, as the closed circuit of a silence, a 'mystery': the closed circuit of a particular group or pythagorean circle in the wider circuit of the economy of Earth as a whole, the earthly group. And in entering into the mystery the initiate does not, then, simply enter into a closed circle within the exoteric economy of earthly action: rather is this an inverted earthly image of escape from the circular 'prison' of embodiment in an earthly economy of unconsciousness turning upon and returning into itself, into the wider mystery of Drama of Kosmos, from which that earthly order is the abstraction of one side. A circuit of abstraction, indeed, governed by its inscription in the wider mystery or circuit of Kosmos into which, as into the narrower earthly circuit of the mystery, the initiate enters.

The pythagorean silence, then, is a 'mystery' in both 'earthly' and 'heavenly' senses. A mystery in the mundane sense that we cannot see how, in the normal course of our earthly activity and reflection, how to enter into it - we cannot see its part in the earthly economy of ends and means - and a mystery also in the 'esoteric', 'internal' sense given, 'in' the mystery, to this earthly impasse.

How, then, does the configuration of inscription of the pythagorean 'circle' and their closed intercourse, their silence, in the 'economy' of the various orders of assertion (and in the limit,

positive silence) already marked, present, in the 'historical' context of this book, the question of our part in the articulation of those orders in an 'action'?

I have already marked the image in the physical order of the common 'outside' of this book, these books, and their writer and readers, of the 'ontical' actuality which distinguishes itself in and from that physical order, as one 'side': 'Sky' - or rather, in the tradition of its marking in english, 'Heaven', 'heavens'. A 'heavenly' order of closed circuits 'mirrored' in the earthly order of our embodiment, interaction, and its economy - the familiar circuit of a 'Sun', for example, 'mirrored' in the earthly order of Summer and Winter in England, already raised as a question. I noted in relation to the systematic 'theology' of Mystery as 'Incarnation of the Word', how the economy of this earthly order was formally inscribed as one term in the heavenly mystery, through the embodiment or inscription in the earthly order of the focal locus of assertion of the mystery. An assertion of the 'transfiguration' of the earthly economy into the wider order of Mystery (into 'Heaven on Earth', so to speak, and the close of Time), through precisely the economy of 'versions' of the question posed by this focal 'version'. In the 'past' of that formal theological focus, then, we find another 'mystery' (taken in due course, of course, as a prefiguration of the latter mystery), framed not in public announcement of the story organised about that its announcement, but rather in a certain order of silence 'outside' a particular group, as framing the access to that group as a 'mysterious' question, in the earthly economy of question and assertion. A question indeed, without an 'earthly' answer, a question which cannot be inscribed in the earthly economy of questions and answers, and in the 'exoteric' dialogue and intercourse which frames that earthly economy into which it enters as one component. A question, then, a mystery, whose 'language' is framed in that earthly intercourse in the form of a question, in silence. A question which cannot even be adequately framed in the earthly order, just as (and correlatively) it cannot be answered: the proper framing of the question posed by the silence can only be found in the mystery. The question can only be understood if it is already answered: a mystery indeed, a circular question into which there seems to be no natural access.



Intercourse, then, framed within a circuit drawn in a 'wider' order of earthly intercourse as a whole; discourse framed within the wider order of earthly discourse, and within the wider order of 'greek' language in particular. And in this simple figure of 'inside' and 'outside' the group, verbally framed in pythagorean silence, we may articulate the mirroring in the earthly economy in which the pythagorean circle is (so to say) drawn, of the inscription of that economy as itself one side of a wider order of 'Kosmos', the two 'sides' of Kosmos, Heaven and Earth (Above and Below), articulated and coordinated as the image of the self-distinguishing actuality of Kosmos in the formal Symmetry in which it is 'open', possible.

Within this elementary frame, then, of the pythagorean group or mystery in the coordination of Kosmos identified in that group, we may begin to trace a story, a dynamic and economy of interaction of 'individuals', whose opening frame is simply the order of 'community' defined by this elementary coordination.

In the symmetry of the pythagorean inscription of the question or mystery of their silence in the coordination of its various orders as Kosmos, and the opening inscription of this inquiry in that same figure of coordination of its various orders - the symmetry of the former as opening question, and of this latter as assertion 'in' their silence, as initial response to that silence - we thus first frame the form of the following inquiry as 'story': as articulated in the symmetry over or in a common Time, of that order of opening and this order of closing. And as framed in the mirroring of the 'inside' and 'outside' of the pythagorean circle as question, in the circle of writer and readers of this close.

Before identifying a contemporary 'echo' of the pythagorean question or mystery in the configuration of Heraclitus' Word, and an initial 'breaking' of that silence in the discourse of Parmenides, let us first consider the play of a range of figures to be found in later 'versions' of the mystery.

...For the 'mystery' lies in the coordination of steps into and out of the mystery: the mystery lies, so to say, precisely in the way its details must remain for us a mystery.

In asserting the part of our assertion of Kosmos as coordination of the primary symmetric orders of question and assertion, we know ourselves as a psychical actuality of assertion asserting itself, as 'I'; as  $\psi\chi\acute{\alpha}$ , 'soul', 'life'. And in this knowing ourselves, we frame the figure of 'knowledge' itself in this order of actuality: we know knowledge: and this as an actuality, partaking of that same order of 'I', of self-expression. We know Knowledge in the figure of an 'I': we know Knowledge as we know another 'I', another actuality or actor in the cosmic Drama: as a 'god', Apollo, previously known only imperfectly, in distorted images.

...And we know the common 'I' as Actuality itself, as Life in which I and Apollo participate, as Zeus, 'father of gods and men', God, indeed, quite simply; heavenly actuality as such. And we know the actuality of Apollo, son of Zeus, in the outward 'physical' image of Sun, heavenly Light, heavenly Fire that, like its earthly image, lives 'through itself'. 'Through itself': for a spark of Light, a seed of Fire, transforms the matter in which it is implanted, by being the very figure of coordination of itself, its 'assertion', self-assertion, with its context, environment, embodiment - transforming the matter in which it is implanted by its heat, into combustible form, and so 'growing' until that matter is exhausted. Fire, like Word, Fire the physical image of Word, each comprising their inscription in their frame in their own form, their own order.

Knowledge of knowledge, Wisdom,  $\Sigma\phi\acute{\iota}\alpha$ , knowing itself as the transfiguration of the logical economy of Inquiry, as most itself in seeking itself, most truly  $\Sigma\phi\acute{\iota}\alpha$  when  $\Phi\iota\lambda\omicron\sigma\phi\acute{\iota}\alpha$ , Philosophy, the frame of transfiguration of earthly Desire, earthly ends, into Love, the inscription of earthly self and its ends in the wider frame; 'sacrifice', heavenly transfiguration, of self, its earthly image, into the heavenly actuality of soul. Love,  $\Phi\iota\lambda\acute{\iota}\alpha$ , in which we know ourselves in the God, and the God in our selves.

Mystery of Knowledge, the discovery of one's true self as soul, the discovery of one's 'part' in Kosmos in the love or worship of Apollo. Mystery of 'Philosophy' in Apollo's english Summer, mirroring philosophy in Greece many summers past.

'Greece'? The physical frame of the pythagorean circle within the wider group whose marks of self-expression we mark, in english...in England perhaps...as 'greek'? ...Or perhaps some two-sided boundary marked somehow in the earthly side of Kosmos: a boundary, a 'circuit, drawn in Earth..or perhaps, rather, a circuit drawn in some image, some 'map', of this earthly surface on whose heavenly side we like the greeks are embodied and live?

Greece: who could logically define such a place? Nobody, of course, for it was not so much a place as a group: hellenes..in their self-assertion; a self-assertion no more comprehended in any normal economy of logical and physical symmetries, than my assertion, or yours, in 'I'. Me, you, Greece, World: the identity of place is only one side of the matter.

Let us begin then, from where we are, from this book - and coordinate, say, the place and time of its writing, with another group physically related to us through the physical transcription over the time and space that separates us, of their words two and a half thousand summers past. Greece, then: the wide circle of 'greek' groups identifying themselves in a common language as the speakers of that language; together asserting themselves in the order of stories, framed by stories of the relations of Heaven and Earth, 'myths', of which that language embodied the play of elementary figures.

Groups, then, of hellenes. And groups for the most part settled, if sometimes rather recently, on this same surface of Earth as ourselves. The group or circle in this greek or hellenic Culture with which we are to deal now, grew, so to speak, from the seed taken from an old domain of settlement at the interface of Land and Sea to a new, across that greek Sea. 'Settlements', 'cities': once more groups rather than places, defined by a Law which framed a common activity, rather than by the physical frame of place where that activity was mainly carried on. A 'city',  $\alpha\iota\tau\iota\varsigma$ , marked in that word

'in terms' of a boundary: a 'country', then, with the city in the more restricted sense bounded within that country by its walls.

A seed of a group within the city-state of Croton, within the order of activity named 'Croton', within the wider order of interaction of cities called 'Greater Greece', and now called 'Southern Italy': the seed taken from Ionia to Croton by an individual named Pythagoras. The group 'around' Pythagoras, at the period now under consideration, were in control of the affairs, the frame of activity, at Croton, and derived groups in other cities of 'Greater Greece' had power in the affairs of other cities, together constituting a sort of political confederation of the newly-colonised coast(s).

How is the logical economy of 'Philosophy', then, reflected in the 'physical' economy of the central group's part in the affairs of Croton?

I have already briefly correlated the inscription of the 'psychology' of a single individual in (a) 'this' side of a bodily surface, with the finality of his or her orientation in 'Time' as itself 'one side' of the triple symmetry or dimensionality of physical 'Space'; at the other extreme, I have found the 'here' of earthly embodiment as also one 'side' of that 'side' of Space associated with our embodiment (with left and right hands, for example) and 'ends', 'objects'. One might draw an analogy between the life of the individual articulated in the triple temporality of 'physical', 'psychological', and poetic or historical 'times' (the latter the order of mirroring of the two former), and the Life of Earth as a whole, as one whole side of the 'side' of spatial symmetry shared with the individuals 'on' Earth. The activity of a group, then, is articulated in the coordination or complementarity, mirroring, of these two poles of two-sided individual and two-sided Earth - and activity 'on' Earth as a whole in the interplay of such groups.

Thus a group is bodily rooted in the engagement of the physical 'bodies' of its members in the physical or material economy of Life, and this configuration is reflected in the logical economy rooted in the individual 'ends' of members of the group, articulating those ends, for example, in the simple finality of material subsistence of

**PAGE  
NUMBERING  
AS ORIGINAL**

the group in its members. An elementary dynamic thus attaches to the interplay of this group articulation of activity, and the analogous articulation of mind and body in the limiting 'group' of the individual member of different groups, and the limiting analogy of that common interplay of mind and body in the relations of Heaven and Earth. More generally a group whose activity is framed in a Law may be taken as the frame of mirroring of individual and World, in the general interplay of all groups and sub-groups. For Law traces a radical circuit in the 'outward' economy of Nature, framing what is open to the individual 'in' the Law, and what 'outlawed' through the attachment of a 'penalty' which weighs against or counterbalances the choice of some end in the natural economy of individual desires, the individual's 'nature'. The circuit of 'within' and 'outside' the Law is drawn in the natural play of physical and logical 'economies' of action. This circuit of Law, then, mirrors in the circuit of the Land within whose circuit it applies and is enforced, an order of coordination of activity we may call 'political': the integration of activity in the  $\pi\acute{\omicron}\lambda\omicron\varsigma$ . If we make an analogy between these three circuits or components of the poetic order of interplay of physical and logical economies with the three orders, logical, poetic and physical themselves, we may then understand the restricted sense in which 'economy' refers simply to the material or physical economy of social activity, rather than the 'base' interplay of logical, poetic and physical 'economies' as a whole. 'Policy', in turn, may also be understood in a restricted sense as the discursive elaboration of a 'logic' of integration of civic activity.

Law, in the restricted sense of the 'constitution' of a group mirroring Policy in the restricted sense in Economy in the restricted sense, thus presents in the 'visible' framing of group activity, an image of the moral order of divine 'Justice', the actuality coordinating the 'historical' order within the 'poetic' symmetry of what is open in the interplay of logical and physical economies of activity - and this divine moral actuality at work in the City is reflected in a formal theological instance rather as the wider divine actuality of the World as a whole is reflected in the visible heavens. - A theological instance to which the Law itself is formally subject, by which the justice of positive law itself is judged. The law of an 'autonomous' group determining the frame of their own activity should express a divine law which itself frames the mirroring of moral and natural orders in a definite code. We will eventually see how a parallel tradition framed in

a theological economy of Law meets this greek tradition in the Question about which this First Part turns. At the period now under consideration that parallel tradition was being systematically articulated by the governing circle of a 'priesthood' that itself parallels the governing pythagorean circle at Croton.

Now for the individual at Croton pythagorean policy - pythagorean framing of an integrated civic activity within laws or constitution that they may well here (as certainly elsewhere) have also framed - seen from 'outside' the circle, must have been articulated within the overall question posed by the 'mystery' simply as such, as a range of questions: questions corresponding for the undisclosed reasons or principles upon which the various pythagorean decisions affecting the organisation of what in the City was 'open' to the uninitiated, had (presumably) been made. Questions, then, themselves entering into the general 'economy' of logical and physical sides, 'economies' of everyday life in Croton. Questions, indeed, framing the self-assertion of the demagogue Cylon who (so the story goes), being refused admission to the mystery, stirred up the uninitiated to the revolution or disruption of the original circle (burning down the house of a leading member of the circle, Milo, in which most of the others were assembled, and perished) associated in most accounts with the death or exile of the founder. Questions, one supposes, interpreted by Cylon in terms of the everyday economy of self-interest governing the unconsidered or 'natural' policies of uninitiated individuals and of the various groupings into which they naturally fell in their activity. Here, unlike the case of the subsequent mystery which it prefigures, the inscription of the mystery in that natural economy of question and self-assertion would not appear to be incorporated as one component of the mystery: its 'tragic' failure in everyday terms.

But let us consider another response to the articulation of pythagorean policy in the 'economy' of natural activity and reflection, as an order of questions articulated within the question or 'mystery' (in the everyday sense) of their Silence. In the 'natural' business of uninitiated reflection on the 'logic' of pythagorean policy, the individual as it were 'working back' through the order of pythagorean assertion in policy in the complementary order of his reflective questioning - according to its 'natural' economy -

would, perhaps, eventually confront the question posed by the Silence itself, the question attaching to the very order of pythagorean 'assertion' simply as such, the question of a certain standing-back or abstraction from the natural marking of one's assertion in self-expression (unless one has something to hide..when caution asserts itself, but in the same natural economy of inscription of the 'logical' order of self-expression in the interplay of logical and physical 'economies' of activity).

The assertion that informs pythagorean decision, then, itself in question: and at this point, perhaps, the inquiring individual confronts the configuration of marks which frames access to the pythagorean group. His reflection now articulated about the question of pythagorean assertion, posed by the Silence or mystery simply as such, he confronts the question: Why should this simple symmetrical arrangement of ten points or otherwise indifferent marks frame access to the pythagorean Silence, and to the order of assertion in crotoniate policy to which my questioning has led:

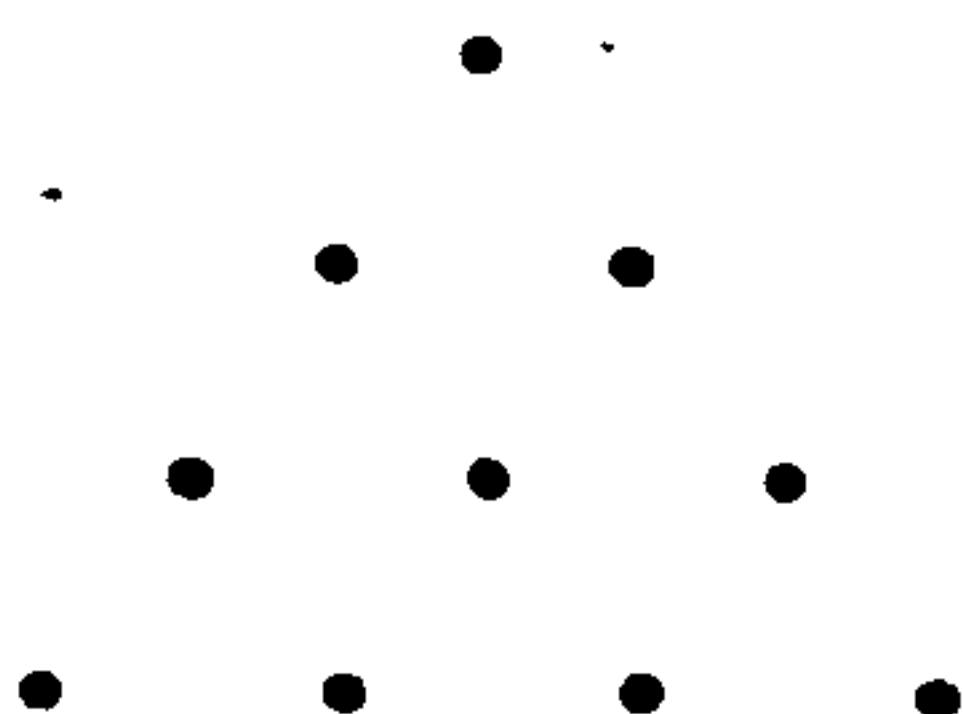

... ἐκεφθέγγοντο οἱ πυθαγόρειοι ὡς μεγίστου ὄρου  
 ὄντος τῆς τετραδός.

Οὐ μὰ τὸν ἄμετρου γενεᾶ παραδόντα τετρακτύν,  
 πατρὸν ἀνέμου φύσεως εἴδημα τ' ἔχουσαν. (1)

...the pythagoreans would invoke, as being their most solemn bond, the Tetrads:

Nay, by him who bequeathed to our line the Tetractys,  
 embodying fount and root of ever-living Nature.

1: Aetius I.iii.8 (ie Theophrastus); the later Golden Verses have ψυχῆ for γενεᾶ (vv 47-8).



...? ..And this 'Tetractys of the Decad' marks for us, too, the pythagorean 'mystery' as question, marks the question of our access to it, our access to the postulant confronting now the question of pythagorean assertion, which in turn frames his entry into that order of assertion in his recognition of himself as radically a 'psychical' principle of self-assertion, asserting itself as response to the question framed by the systematic symmetry of the various orders of assertion as such, which he now confronts. 'Finding himself' as response to the limiting question framed by the symmetry of the orders of assertion: the breaking of that symmetry in asserting himself as self-assertion, soul, being open as his 'part' in that coordination which is 'Kosmos', 'arrangement', 'ordering', 'coordination'. The part which now begins to be articulated as his assertion within the pythagorean circle, through the coordination of this assertion with the symmetrical configuration of what is 'open' to such assertion in particular situations of the wider Drama to which this recognition of oneself as a 'part' of assertion is the entry of the cosmic 'actor'.

...For in the simple arrangement of marks as 'Tetractys' the question arises of a 'sense', something so to speak 'behind' this symbol or bond of the Brotherhood. In a single mark as mark - as, then, chosen to mark something (whether we regard what is 'marked' as the 'inner' intention behind the marking or some outer 'thing' marked, perhaps, by such choice, by being chosen to be marked) - we find a simple symmetry of the logical and physical orders of 'mark'. What, though, is 'asserted' by a simple 'mark' without further 'indication'? Here again we find assertion as such 'in question'. And in the 'physical' symmetry of the marks that constitute the pythagorean 'bond' we now find this question of assertion embedded in an order of symmetry in which the previous impasse - the simple paradoxical circuit of assertion in question in pythagorean Silence - as it were opens up, with the inscription of the simple order of assertion in 'marking' inscribed in the deeper 'open-ness' or 'question' of the symmetry of various orders (that is, the wider configuration) of 'question', from which the 'natural' economy of reflection that has led to its limit in the question of assertion, now appears an 'unthinking' abstraction: a figure of mechanical questioning and assertion in which we have thought to assert ourselves, in which our radical self-assertion as soul has been lost in a mere 'image', and so imprisoned in the earthly circuit of abstraction from Kosmos to a natural economy

of images turning upon itself. At the limit of reflection in the earthly economy of uninitiated participation in the civic order of activity at Croton - the limit corresponding to confrontation, in questioning pythagorean policy with the organising question of the Silence in which it is articulated (rather than being publicly 'marked', expressed, in that everyday verbal economy of self-expression as it enters into the everyday interaction and framing of that interaction by the uninitiated populace) - we find the assertion 'behind' that Silence silently marked by the ten symmetric points which, as its 'bond', closes the circle.

If a single simple 'mark' or 'point' simply reflects, for some undisclosed reason or other, two 'sides' of whatever that business of marking amounts to, then two symmetric marks reflects (among other things) the symmetry of those two sides -

. .

- the symmetry, say, of the distinction between logical and physical (inner and outer) 'sides' of the mark(s), and the physical symmetry or two-sidedness by which the symmetry of logical and physical might be marked or reflected. The actuality of assertion, however, is still not marked by such a logical distinction of logical and physical 'sides' of the mark, marked by the physical symmetry of two sides, two marks, of an interval, a physical 'space'. Indeed this difference might be taken as an image of the way it, as mere image of the distinction in question, framing the self-assertion of assertion, leaves 'actual' self-expression in a mark still 'outside' the order of marks. And..indeed..in this configuration of a mirroring in the symmetry of the mark, of the distinction of the actuality of self-assertion from any mark, we may discover an elementary quaternary frame of an actual marking in the order of mark, image, of the part of the two sides of the mark or image in the actual identification of such parts. We will see how the simple fourfold symmetry of this marking, not of the actuality of assertion in the mark, but rather of the mark in the configuration of its actuality, is found reflected by the pythagoreans in the fourfold physical 'space' and time of marking, and how the Tetractys, the

'quaternity' of the Ten or Decad, embodies the coordination of the various orders of assertion, by which that 'psychical' order frames itself in the symmetric physical Space and Time of marks, coordinates the various 'physical' dimensions of what is open to it as assertion, and so frames embodied action as simple self-assertion or actuality in that limiting 'space' of what is open.

...But that physical 'space' of what is open to assertion of assertion, self-activity of 'soul', is of course only one symmetric component or dimension of what is open to the pythagorean, whose very symmetry reflects its coordination with the other complementary orders, just as the symmetry of the Tetractys reflects its inscription, as elementary 'poetic' frame of coordination of various orders, in that very coordination it marks - a coordination of which the mirroring in it of a logical order of distinctions and a 'space' of physical difference is one side. - The 'earthly' side, if we are to take that 'physical' opposition of Heaven and Earth, coordinated in the Tetractys with the 'psychological' opposition of heavenly soul and earthly self, as 'image' of the distinction of what I earlier called 'finitary' and 'cofinitary', in general. The coordination in the Tetractys as marking or reflecting in the simple order of marks, points, of the 'cosmic' coordination of correlative orders of that marking, may be further extended, then, to the mirroring of the physical opposition of Heaven and Earth in the two sides, in or on that Earth, of Culture and Nature: the two sides of the  $\omega\delta\lambda\epsilon$ . Within the City, in turn, the two 'sides' of activity, 'political' and 'economic', embodied within the general interplay of groups in the circuit of abstraction of the governing pythagorean group or circle from the general 'economy' of interaction (an abstraction reflected in the Silence framing their 'internal' communication or community, and in the Tetractys as inscription in the 'poetic' order of marks of the configuration of inscription of that economy as one component in the circuit closed, then, in that Symbol and bond), reflect the relations of Heaven and Earth in the wider coordination of Kosmos in which the City's constitution is embedded.

Moreover, the outward coordination of individual activity in the frame of the group reflects (as we saw in the case of reader and writer as two sides of the 'I' of this text itself) those symmetrical relations between individuals constituting the elementary

poetic symmetries of action and interaction. The Tetractys, as the elementary symmetries of the simple mark reflecting its inscription in the wider coordination of its poetic frame with the other symmetric- al orders of Kosmos, reflects the elementary symmetries of physical 'elements' in the 'outward' order. Just as, physically, the two-sided individual (or indeed, 'four-sided', if we take account of the double mirroring of 'inner' and 'outer' and heavenly 'soul' and its earthly image) is the interface of Space as a whole and these 'elementary' solids corresponding to the physical symmetry of 'points', and the physical economy of a group reflects the coordination of its member's bodies in the collective activity of sustaining individual bodies by assimilation of the elements of food...so that the 'elementary' physical 'economy' of civic life is reflected in the coordination of individual activity in groups...so does the elementary 'poetics' of civic interaction find its reflection in the wider interplay of groups, the 'scale' up from physical 'elements' through the physical economy of life, the individual, the group, to the interface of Heaven and Earth in which the interface of the group's 'Culture and Nature is inscribed, finds an immediate parallel in the scale up from the coordinating 'elements' embodied in the Tetractys, through the individual 'actor', to the widest cosmic frame of his activity.

..That is to say: a whole configuration of symmetry of the various orders of the mark, reflected in the order of the elementary mark or point as Tetractys (or a configuration of the physical order with other orders reflected in that physical order as the simple symmetry of physical 'space' or body), the whole configuration (then) of pythagorean Kosmos, is focussed in the individual confronting the pythagorean mystery symbolised in the order of marks by the Tetractys (which defines, then, the pythagorean circle, as this book defines the 'circle' of writer and readers, or english or greek languages define a more symmetrical circuit of english or greek 'Culture' as a whole, in which these two circles are inscribed). In the systematic symmetry of its various orders, the Symbol frames Kosmos as systematically 'open' to the individual's critical disruption of the absolute symmetry of orders of his assertion as 'soul', in his assertion of this his part of assertion in Kosmos. 'The' whole Kosmos is, so to

speak, focussed in, articulated about, the question of the individual's part as he confronts the symmetry of the various orders of his assertion that together are Kosmos. In assertion of his part as assertion, as 'pythagorean', he enters, then, into the direction of this assertion by the configuration of the question presented to him in any situation 'in' Kosmos: enters into that pythagorean order of assertion and the action it informs, which has previously remained a question...a mystery, closed in Silence. Enters, then, as it were, into the 'mathematical' language of coordination of all the questions facing the pythagorean through the inscription of question and assertion in the cosmic symmetry of its various orders..enters into that 'language' which coordinates the activity of pythagoreans within the unitary assertion of the circle as a whole: and which, framing the assertion of that circle in the interface of heavenly mystery and the earthly economy of Croton in which it is outwardly embedded (as in the mechanical order of the mark), thus frames the pythagorean 'policy' at Croton, which must remain for the uninitiated a mysterious business. A 'mystery, indeed, which will of itself systematically select those from the populace whose 'natural' tendency to reflection leads them to understand the coordination of pythagorean policy in the simple figure of assertion - or rather in its complementary mysterious Silence - and so brings them like a guiding spirit to the very door of the mystery, prepared invisibly for entry.

...And so too, the natural economy of inquiry proceeding, as we will now see, from the disruption of the pythagorean circle and the 'publication' of a pythagorean order of assertion (by Parmenides), leads, in the end, to our confrontation with the question of that Silence systematically coordinated with the various orders of its 'context' in that figure of Kosmos which itself frames the coordination of this close of a certain circuit of reflection, with that silent opening. We have come as it were full-circle, and join the postulant at Croton at the entrance to the mystery of Kosmos, the pythagorean mystery of Philosophy. Let us now, then, enter with him - or her indeed - through the configuration of a Tetractys which reflects in the 'poetic' element of Kosmos the coordination of that order with the other symmetric and coordinate orders of the

mark or 'point', into the details of the mystery, into that language framed by Silence, that 'mathematical' language which frames pythagorean community within the Community of Kosmos as a whole.

'Mathematical' language: all subsequent accounts of the mystery agree on the centrality of Number, and, most particularly, of the 'number' ten. I have suggested how a configuration of symmetric marks,

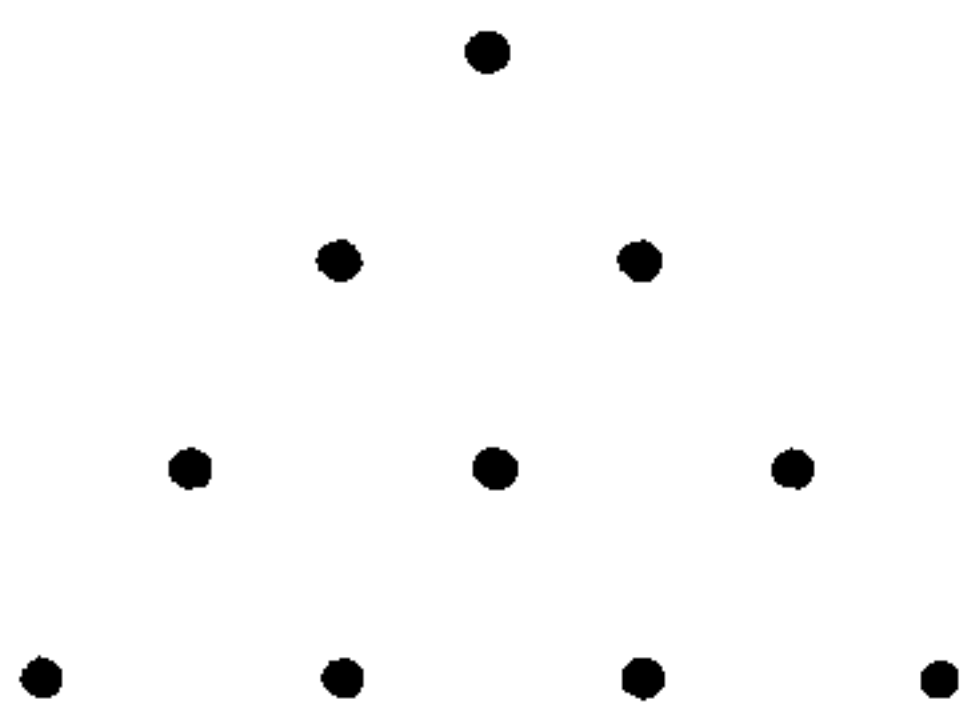

...might reflect in the order of marks the coordination of the order of marks with the other coordinate aspects of 'Kosmos'. As marking the inscription of the order of the mark in Kosmos, this Tetractys of the Decad might be said, in a way - 'indirectly' - to mark Kosmos 'itself'. And, indeed, we find that the 'number' Ten, the 'Decad', is actually called 'Kosmos' in later accounts.

The number ten as 'Kosmos', 'Heaven', 'Destiny', 'Eternity', 'Faith', 'Power', 'Necessity'...as 'Atlas', 'Untiring', 'God', 'Torch', 'Sun', 'Urania', 'Remembrance' or 'Mnemosyne' personified (and then herself mother of Urania), 'Sphere', 'Key-Keeper', 'Perfection'...(1).

...Here, then, at the 'outset', we meet with a characteristic problem: just as we will not be able to understand pythagorean Kosmos as coordination of symmetric orders of question within some later

'theory' (again a pythagorean term) abstracted from the dramatic order of its coordination as action with its various orders of 'cosmic' context, nor should we hope to comprehend pythagorean 'number' in the frame of a 'mathematics' abstracted from the pythagorean configuration of  $\mu\kappa\theta\acute{\eta}\mu\alpha\tau\alpha$ , initiations, 'esoteric' transmission.

Thus we will shortly find that our best authority for pythagorean 'doctrines',  $\mu\kappa\theta\acute{\eta}\mu\alpha\tau\alpha$ , the founder of the Lyceum, could make no coherent sense of these doctrines, as he attempted to 'coordinate' them into some unitary doctrine or theory within his framing of 'a' Kosmos... a frame coordinate, precisely, with his account of  $\Theta\acute{\epsilon}\lambda\omicron\varsigma$ , 'position', just as Kosmos is coordinate with pythagorean 'point' ( $\sigma\eta\mu\acute{\epsilon}\iota\omicron\nu$ ).

...Pythagorean 'number', then, a configuration of 'points'? ...Or rather what is marked by such a configuration. For then indeed we might well enough say that Kosmos 'is' Ten: Kosmos is the coordination of all things in the symmetry of the various orders of the mark marked as the arrangement of points called the Tetractys. Ten 'points' is then 'Ten' in the order of the mark, just as that same symmetry or principle of coordination frames the part of that 'ten' in the wider 'ten' which is Kosmos as a whole - of which the order of the mark is one of several (indeed, ten) symmetrical orders. 'Ten' is then the 'principle' or frame of 'number' in the restricted 'formal' sense, in-~~as~~far as, reflecting the coordination of the mark with other symmetric orders, it also (conversely) reflects that symmetry of coordination within the order of the mark - and so within each of the ten symmetric 'units' which reflect in the order of the mark the part of that order in Kosmos ( we will see how the pythagoreans associated this recurrence with 'decimal' counting among the greeks and 'all barbarians').

The articulation of configurations of 'points', on the other hand, then provides, through the primary figure of reflection of its coordination with other orders in the order of Number in the 'restricted' sense, a sort of systematic calculus of coordination of various component figures in the various other orders. Thus within each of the

other coordinate orders we might have a primary expression of the Decad (as in Theon of Smyrna's later treatise on the Tetractys organised symmetrically, decad within decad, within the cosmic Decad, or the decad of Kosmos, as a ('unitary') whole)..and we might in turn find the same figure recurring in coordinations of various elements of various different orders - when the score or so 'identifications' of 'Ten' already noted need cause little surprise. Rather than attempting to identify the 'poetic' order of Number in the restricted sense (of elementary symmetries of the mark) within some logical order of distinctions, we ought then to try and identify the 'logical' order of distinctions abstracted from the 'mathematical' poetics of their 'marking' within a wider symmetry of Kosmos. A Kosmos which is in a sense 'all number', if we regard number 'in the restricted sense' as the reflection, the marking, of 'actual' Number as 'cosmic' configurations or actualities in which their 'marking' is simply one component. A component whose general relation to Kosmos is presented in the Decad, 'fount and root of ever-living  $\phi\sigma\sigma$ '. Ten then appearing in a 'theological' order as 'God', 'astrally' or astrologically as 'Sun', 'psychologically' as 'Remembrance' - or in a conjunction of psychological and theological as Mnemosyne, Mother of the Nine (muses)..and so on into more singular aspects, more and more complex orders and accounts, further and further from the primary, 'radical', coordination, 'fitting together',  $\xi\epsilon\mu\omicron\nu\acute{\iota}\alpha$ , Harmony, which is Kosmos.

'Radical': Nature 'rooted' in the Decad (if we adopt that possibly misleading transposition of  $\phi\sigma\sigma$  through yet another language, into english). If the 'mark' now be considered as the symmetric 'poetic' order of interface of  $\lambda\omicron\gamma\omicron\varsigma$  and  $\phi\sigma\sigma$ , its 'inner' and 'outer' sides, then we may begin to articulate the 'logic' of Kosmos, and a certain 'physics' which we might suppose pythagorean. A logical order framed in the primary recurrence of unitary identity within the configuration of coordinate identities by which (their) logical identity is itself 'defined', 'identified'; a corresponding 'nature' of a thing which (like the example of Fire already considered) 'asserts' itself in the physical coordination of the various orders coordinate with the 'nature' of that thing - in the recurrence of its principle in the configuration of its 'context' which, like the logical framing of assertion in the Kosmos it



asserts, is a direct correlate of the recurrence of Number in the reflection within the order of the mark, of the coordination of of various orders of 'context'.

Two 'sides', then, of the central recurrence of Number in the Decad or Tetractys: two orders of subordination of the relation of text and context, or thing and context, to the 'internal' organisation of discourse or outward thing.

Within this scheme of things a name, such as the various names by which the decad is called, amounts to a sort of secondary marking, in language, within the logical order abstracted from its coordination with Nature in Kosmos (through 'Number'), of what is primarily, or properly, marked by the configuration of definition which reflects this secondary mark or name in the individual nature to which it is referred. At the same time, some distinction of the orders of definition and nature is itself involved in the organisation of physical difference as Number. 'Logically', distinction itself is prior to number... yet the expression of that distinction involves the coordination of the various cosmic orders 'through' Number, the reflection of the configuration of terms in which Number is defined, in Number. Just as the decad may be said to be the 'fount and root' of (physical) Nature, so the analogous recurrence of Number in the configuration of orders in which it is itself defined may be said to organise the cosmic Economy in which all 'orders' are coordinated with or subordinated to one another through the mirror of Figure or 'Number', in the 'Analogy' of the inscription of one figure, one number, 'in' another, as the unit (or 'point' or 'mark', ~~or sign~~ <sup>or sign, or factor</sup>) in all numbers, or the first four numbers 'in' the decad.

Within such a frame, the analogue of the tetractys in the poetic order of Number is that principle of proportion (or 'analogy', ~~ἀναλογία~~ ἀναλογία) which defines what, after the pythagoreans, is called 'harmony' in the restricted 'musical' sense. And just as (or so I suggest) Number may be taken as the 'mirror' of logical and physical orders, and the logical recurrence of the decad as the 'principle' of this poetic order of Number; so, analogously, may 'Music' in the restricted sense of harmonics, the inscription of one proportion in another, be taken as the finitary determination of the mirroring of finitary and cofinitary, as the primary pythagorean expression of Law.

**PAGE  
NUMBERING  
AS ORIGINAL**

Now, if the terms developed in the Introduction are to be truly reflected in the terms of the pythagorean mystery which have been transmitted to us through the Tradition, what are we to recognise as 'ontical', 'psychical', 'mystical' in the various constructions of the mystery that remain to us? This question actually contains (as will now be seen) two outstanding questions from the first part of this our construction or reconstruction of the mystery: How can the Tetractys be said to constitute an inscription of logical closure or recurrence in the domain of Number? And how can any sense be made of the relations between the terms in which Number is defined, and the supposed primacy of Number in the coordination, the 'syntax' (σύνταξις) of those same terms? Here perhaps will begin to appear a radical 'circularity' in the determination of the Tetractys which may in turn begin to suggest something of its part in the mystery before us.

First let it be remembered that the cofinitary orders appear in the finitary Economy of the 'World' in the supernatural economies of 'mythology', of supernatural stories. 'Supernatural' in that the stories, while framed in the terms of a theology, ontology and psychology by which the principal cofinitary orders are formally comprehended in the finitary Economy of Law, yet elude any adequate 'explanation' in finitary terms. These supernatural stories or 'mysteries' are inscribed in the mysterious paradox of an economy whose end is the 'transfiguration' of Economy. As with the teaching, the 'mathematics' (μαθηματικά) of the early pythagoreans, we can formally inscribe the question or paradox in the figure of Mystery; but this amounts almost to saying that 'one may say that one does not know what one may say', or 'formally, that is a 'mystery' for which there is no formally satisfactory account'.

All accounts agree in giving (the) 'Odd' and (the) 'Even' as 'elements' of Number, and in giving 'Limit' and 'Unlimited' as 'elements' of these. But what can one make of odd and even as 'elements' of Number, when these themselves might be supposed to be (secondary) 'aspects' or characters of numbers? One may read again and again that from Limit and Unlimited come Odd and Even,

from these the unit and multiplicity, and from these all numbers.

Now Limit and Unlimited seem to correspond to a rather ambiguous mixture of logical distinction (of logical and physical as two sides of Number, for example) and physical difference (of 'inside' and 'outside' of some limit, for example). But might one not make a virtue of this ambiguity or duality, and see in these terms something of the 'Closed' and 'Open' we found in the Question? Might these terms perhaps 'work' in a similar way in the mystery, the question, <sup>that we find</sup> before us now?

It will be remembered (I hope) that 'the Question', or 'What is a question?' gave rise to the following paradox: In order to determine 'question' (in order to answer the Question) there must be something 'open' to determination, some range or frame in which the Question could be determined, and so answered; but this range amounts to the symmetry of 'open' and 'closed', their distinction as 'open'; in order to answer the Question we must already have answered it, precisely by defining its terms. The Question is logically circular; its very circularity is indeed a direct correlate of the supposition of a 'logical' order. We found an analogous 'mystery' in the question of the logical status of the distinction of logical and physical orders. In terms of the subordination of the physical difference which might be used to 'mark' or express this distinction, to the logical order of distinction, and the correlative logical 'space' of determinations, this Question has no (determinate) place. It is thoroughly eccentric, 'out of place' -  $\alpha\tau\alpha\sigma\gamma$ , strange.

A similar strangeness confronts us with the pythagorean determination of the mark, taken as marking simple unity, incomposite, a 'point', prick, puncture, whose simplicity bears an implicit reference to a simple 'psychological' intention or end - making a mark, and so marking a coincidence of physical and logical orders, just as we tried to thus mark the relation of 'inside' and 'outside' of this book in the Introduction. Marking 'the mark'. And in the Introduction this circularity of 'the mark', its 'self-expression' almost, was (or rather marked) a first attempt to resolve the mysterious Question. In the Introduction this logical 'economy' of trying to mark in the text the relation between this 'in' and a correlative 'out' (side) led not to a Tetractys or any configuration of 'real' points, 'inside' and

'outside' the book at 'the same time', but to a configuration of 'missing' points in the imaginary 'crossing' of the Knot. The full significance of the 'mirroring' of these two configurations of 'points', Tetractys and Knot, as marking the beginning and end of a certain Tradition will constitute the initial question of the fifth part of this book, the Conclusion. What can we make of it now, to be going on with?

Consider Limit -  $\pi\acute{\epsilon}\rho\alpha\varsigma$  , a 'close', both the term, the point which defines an action, its end or finality; and something to be crossed towards such an end - like a physical boundary or limit. Like the 'close' of this book, for example. And  $\acute{\alpha}\pi\epsilon\iota\rho\omicron\nu$  - 'unlimited', endless, what may only be defined, limited, formally, negatively, as what is outside, 'without' end, definition; what is open to the the inscription of the circle by which we mark marking with a mark.

.. But can we seriously suppose that this is what a pythagorean might have thought? How can we get outside, beyond, the distinction of pythagorean Limit and our Closed as defined in our terms 'here', towards their actual difference in which, alone, this Limit can properly express itself - just as the independence of the physical mark expresses itself in a mysterious circularity which has no proper logical determination? How invoke the actuality of the pythagorean mystery as we might invoke the ontical actuality of our common 'World' by remarking the logical circularity implicit in these very terms in which the circularity is remarked, their physical irreducibility to purely logical terms?

This is currently our end: let us move a little further towards it. To the terms which mark the limit which still separated our Closed from pythagorean Limit. To terms in which these coincide.

Odd?

There's something rather odd in this whole business. Odd, strange. Perhaps ridiculous? Like this confusion of two senses of 'odd', which simply reinforces the ambiguity of the last paragraph.

Let us retreat for a moment to firmer ground. What was 'odd' to the pythagoreans of Croton? .. Many things, one might suppose...

... Or is all this just too artificial.. over-subtle? Excessive: unnatural, even monstrous? Extraordinary?

... Yet (strange enough) such criticism itself corresponds exactly to περιωδός , Odd. (Even 'strange'... even 'superfluous'..)

Is this just playing with words, going around in circles? What, exactly, does it all amount to? Does it really count for anything? Playing with words: is this account of περιωδός itself περιωδός in that sense of the word? The sense in which it is directly opposed to the exact (ἄκριτος) sense in which we can talk of odd (περιωδός) and even (ἄκριτος) number? ... But then this distinction itself, of an 'artificial' and 'exact' sense of περιωδός and ἄκριτος, belongs to an opposition of the 'unnatural' or artificial senses: the 'exactness' of the numerical sense of 'odd' and 'even' is, in these very terms, itself thoroughly questionable.

Indeed just what (exactly) is this 'number'? We have already seen that these Odd and Even are supposed to be the elements or principles from which Number is to be understood as constituted. How might they be understood to constitute the domain of exactness, the domain where intention and object coincide in the mark or point, σημειῶν ; 'sign'? How.. exactly? How might we 'transfigure' the circle of verbal confusion, how hope to find some positive sense in this 'mystery'? How can it 'work' to illuminate the actuality of Number, as the point 'works' in the context of words to mark the actuality of its marking? As the mystery of Open and Closed appears in the fact of the Question, through its reflection in marks, how might this mystery of Limit and Unlimited be found to be somehow reflected in 'Number', in configurations of points?

Well, we have seen how, in general terms, 'Odd', περιωδός , might be said to 'determine' or define (in however odd a manner) the relation of Limit and Unlimited presented ~~one~~ page above: the Odd, in an odd sort of way, corresponds to the 'definition', the inscription in Limit, of the relation of Limit and Unlimited. It 'marks' this relation by the way that it is 'logically' out-of-place. It corresponds to the circularity which is the 'poetic' closure of the Question, as the Open and Closed of the Question correspond to pythagorean Limit and Unlimited.

Conversely, 'the Even', τὸ ἄρτιον, marks the irreducible mirroring of what is limited or definite, and what is unlimited or indefinite in such a definition or limitation of the relations of Limit and Unlimited. Thus far, Odd and Even correspond to Closed and Open in the Question inasmuch as these are considered as two 'sides' of the relation or mirroring of Open and Closed. The Odd corresponds in this sense to the relation of open and closed as closed, decided, the movement of inscription of the mirroring of Limit and Unlimited in Limit, corresponding to the 'logical' order associated with the decad as 'nature' of Number, above. From this configuration the 'unit' or unity, marked by the point, arises just as the 'this' marked by the point arises from the formal configuration of 'decision' or determination 'which cannot choose but that it is the side which decides which side is which'. The range - what is formally open - correlative with this choice, insofar as it is not 'at this point' determinate, amounts to a sort of indefinite multiplicity, in which configurations of points can be determined, but whose very multiplicity has only a formal unity. An initial point in this multiplicity may be determined; the multiplicity may be marked 'outside' that point by another; it may be further marked outside the symmetry of that configuration of two points by another, a 'third', and so on, without limit.

Odd and Even are then reflected in just such configurations. Consider, for example, a figure, a configuration of 'points' (or marks, or units) which in a way reflects the two 'sides' of the opposition (or complementarity) of Open and Closed just referred to (that is, Open and Closed as themselves the two sides of the relation of Open and Closed):

. .  
 . .

- This figure, 'four' (or one expression of the 'number' four) has as its 'elements' two 'twos'. This sort of composition was called by the pythagoreans a 'square' number, τετραγώνος,

literally: 'four-cornered'. 'Literally': in the exact sense of the word, the sign, the mark. Figuratively τετελειωτος is 'complete', 'perfect', 'finished'. 'Figuratively': in the figurative sense of Figure, and 'figurative'.

.. And here we are confronted again with that 'odd' business of a strangely circular distinction of Mark and what it marks, which we can now (even) see reflected in this exact figure itself, in the strange confusion of 'twos' by which the square presents us with two twos. For one thing which the 'square' reflects is just the symmetry of the two 'sides' of mark and marked, figure and 'figurative' as it is expressed in the mark, or the 'order' of the mark, of Number in the 'exact' (ἀκριβος) sense. And in this symmetry this 'first square' reflects something very Odd which is somehow missing from the figure, the number as marked. For the figure of itself does not express the 'twoness' of Odd and Even which, in relation to the unity of the point or unit, distinguishes (as it were) two different 'twos' in the two 'sides' or 'dimensions', orders of the square, the four.

That is: the figure does not of itself mark or present the unity of all these twos. This 'unity' which might be better presented by any single 'corner' of the figure, in which the two sides, the two twos, coincide. Coincide: in four different ways, which are all, just as marks, points, the same. Or rather - which are quite symmetric, though not exactly the same, not 'numerically identical'. For they share quite symmetrically between them the same 'physical' difference as marks; and this 'physical' symmetry of the four corners itself 'contains' the twofold symmetry of the two orders or 'dimensions' (διαστάσεις, placing or standing apart, differing <sup>opposition</sup> a crossing) as 'elements', subordinate symmetries of the two, of symmetry in its simplest presentation, as simple difference of dimension.

- So that in this 'four' one might see a reflection of the unity of the point or unit as simple mark, simplest element of 'figure' or figurate Number, in the mirror of symmetry represented in the 'four', in the 'square' both as two 'sides' and the



two 'units' of each side. In such a configuration, we might choose one point, one corner, to reflect the unity of the four in the figure. This would make good sense insofar as it would reflect the identification of one 'side' of the analogous distinction of Limit-Unlimited and Odd-Even as the side of identity, of identification, of marking. It would reflect the coincidence of two 'sides' of the distinction of Open and Closed ( Open and Closed, and Open and Closed as 'sides' of their distinction or difference) in the point which marks the choice of that point, the Choice which, as the side of 'closing' cannot but choose that it is Choice, that it is Closed rather than Open, Limit rather than Unlimited, Odd rather than Even. Very odd: Oddness, singularity, itself.

Thus, within the configuration of Figure, in the domain of Number, is first presented, in 'finitary' form, the determination of one, unity, in a (properly or exactly speaking) unlimited range of multiplicity. One is chosen from four symmetric units, ones. And what then does this leave as the 'odd' number which thus amounts to an initial presentation of the 'field',  $\chi\omega\rho\alpha$ , the open Space or Place in which the first mark is made, but 'three'. Three as the first subordination of the Unlimited plurality of the even to Limit, the first expression of the 'dimension', direction of limitation, in which the Unlimited 'crosses' into Limit, and is limited. The first expression of the composition of Limit and Unlimited, their fitting-together, 'harmonisation', in the determination in terms of the unit of the relations of unit and that illimitable symmetry itself first expressed in the dual duality of Open and Closed which, 'before' determination, is 'Open' to the inscription of some distinction, some Closure, the very identification of Closure itself.

Three: 'first odd number'; and we might go on defining further configurations of the Square by again and again subordinating what is always still left outside each new limitation, in the 'series' of odd numbers, inscribed one after the other in the constant figure of the Square:

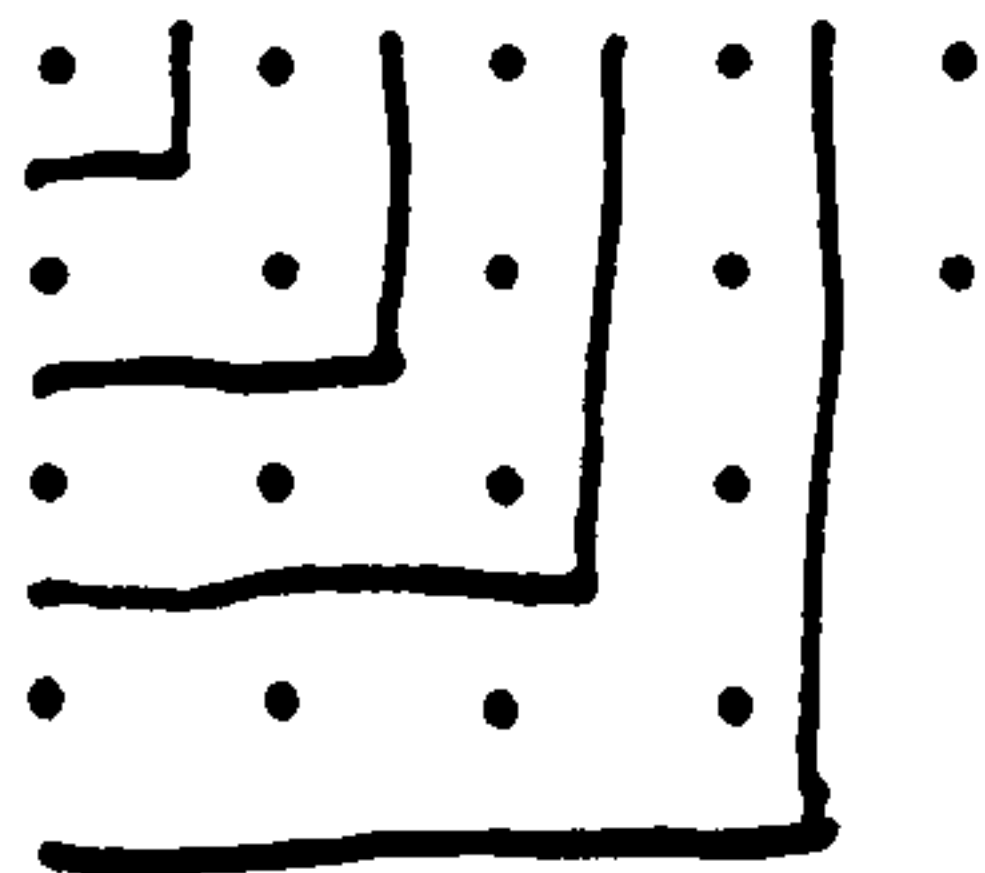

... If we had started from the half-resolved symmetry of the square, the irresoluble duality of Limit and Unlimited or Open and Closed represented, perhaps supposed resolved, as one 'side' of the square, our only limit must be the series of numbers itself, Number, in its unlimited progression or order: but even numbers, as 'two' is presented outside itself, again and again, in relentless and indefinite persistence;

. . | . . | . . | . .

- each successive even number presenting the same linear symmetry of two parts:

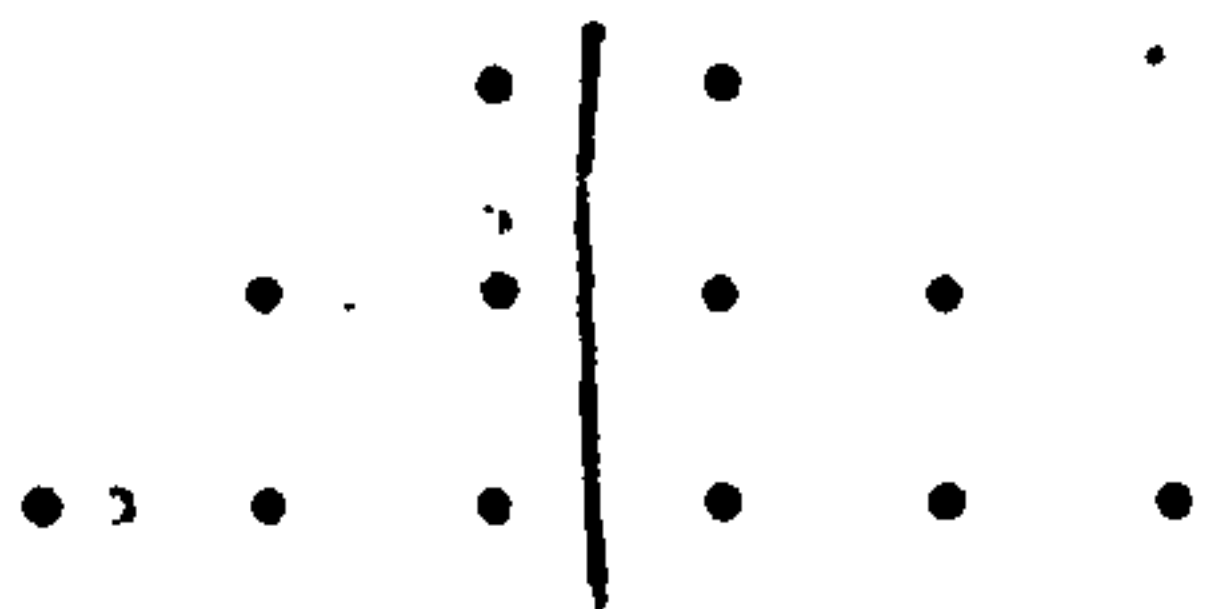

But in the primary domain of 'square' symmetry, the arrangement in the two dimensions which reflect the unlimited duality from which the square abstracts the limiting Odd, the Even presents no constancy, only tending without limit towards the symmetry of the Square, and a coincidence with the Odd:

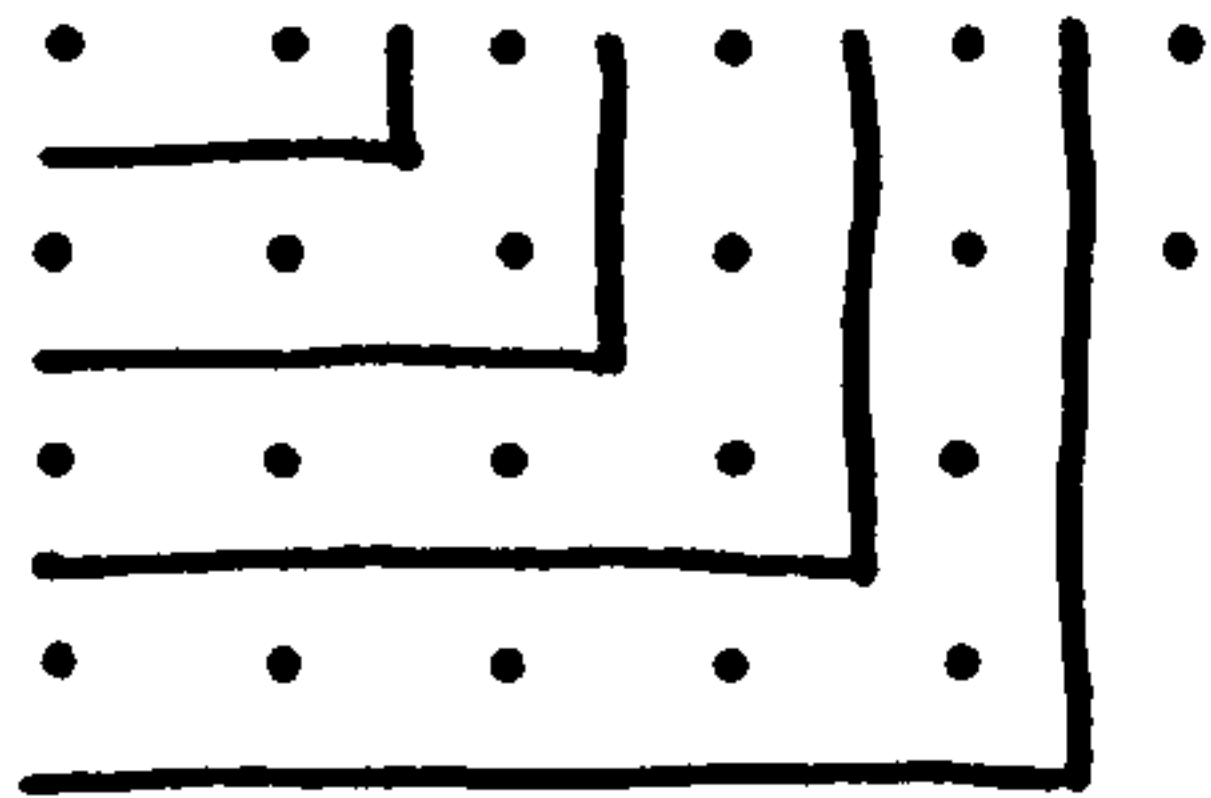

- An imaginary coincidence in the exhaustion of the Unlimited, 'Infinity',  $\infty$  imagined in some positive sense, imagined to mark something other than the turning of words on themselves, and 'outside' the domain of definition in which words or letters have been substituted for 'exact' marks - as 'one',  $\alpha$ , for . ; 'two',  $\beta$ , for . . , 'three',  $\gamma$ , for . . . , and so on.. and on.

- An 'infinity' corresponding to a sort of half-abstraction from the odd circle of words and figures which defines the point, unity.  
 - Corresponding to the successive remarking of the unlimited 'field'

'outside' the limitation of the Mark, in one way of 'standing outside', crossing each successive limit; one 'dimension', *διόρασις*, supposed independent of its 'completion', its complementation, in the Square which pythagoreans called 'Justice', *Δίκη*, right, order, Law; Judgement or Decision; way.. manner; compensation. An 'infinity' corresponding to the imaginary end of the 'one-sided' or unbalanced symmetry of the 'line', *γραμμή*:

..... ,

-*Σκίψη*, something drawn, exhibiting the simple succession of physical movement, its continuity, its Time.

... Yet combining the two 'figures' or 'symmetries' of Odd and Even, we at last find the figure which reflects another sort of 'infinity', the irreducibility of the singularity, the Odd-ness of Limit, to the unlimited symmetry, the Even-ness of the 'outward' order in which Limit inscribes itself, and may indeed be 'remarked'. We find in a limited figure an expression of the mirroring of the 'finitary' order of marks in what we have called a co-finitary order, what 'completes' the finitary order. And this not by some imaginary 'point at infinity', but rather by the way (infinitely complicated, in finite terms) that it expresses itself 'through' finite configurations which mark the distinction between the configuration of marks, and what thus distinguishes itself from its marking or expression: what 'speaks' through or in the mirroring of these two sides of the figure in the figure itself.

..For we may arrange or compose the successive numbers, Number, in two 'dimensions' as follows:

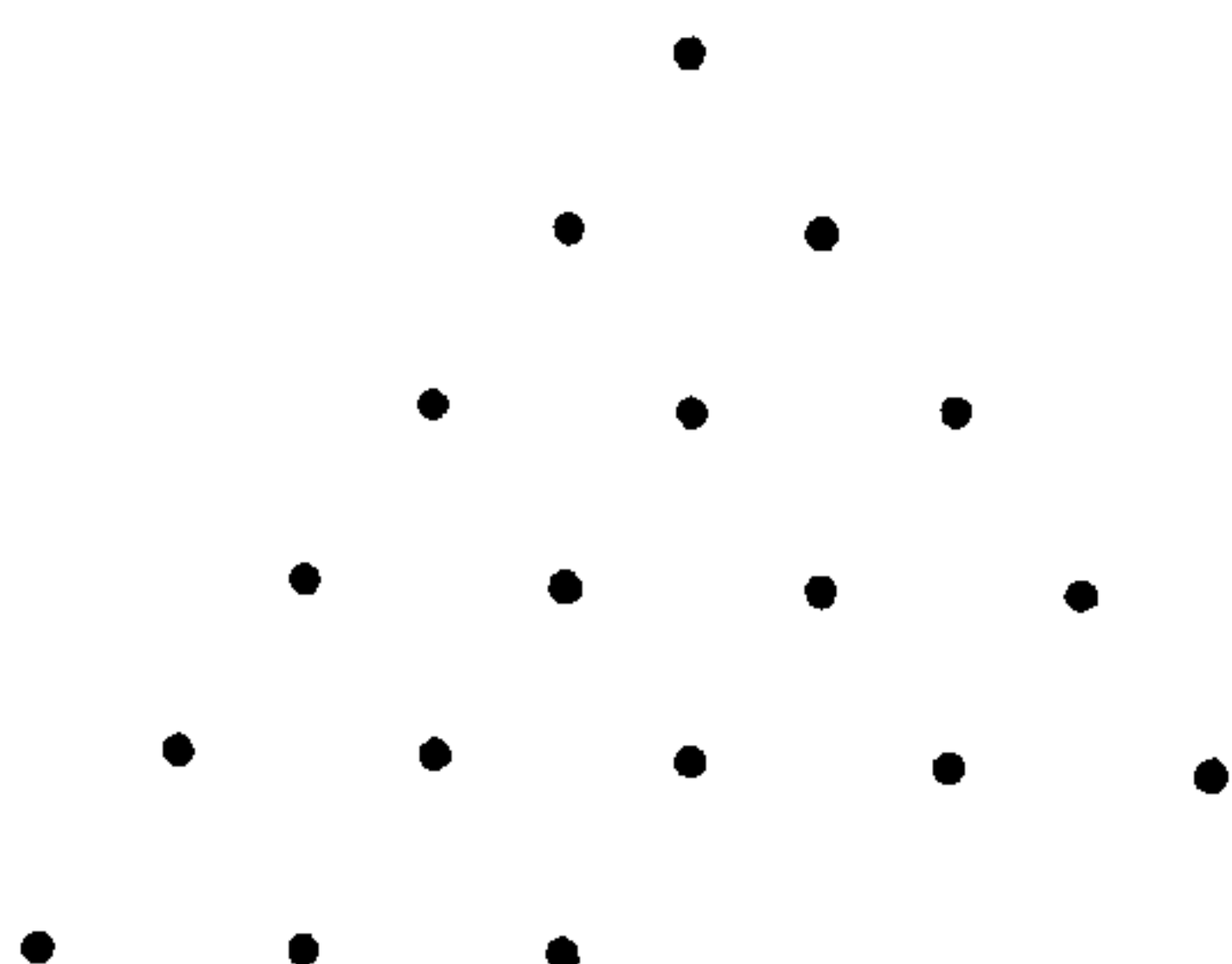

- First the unit, then the 'one-sided' symmetric representation of the 'two', the dyad, and these together making the 'three', the triad, which marks the recurrence of Limit in the Odd:

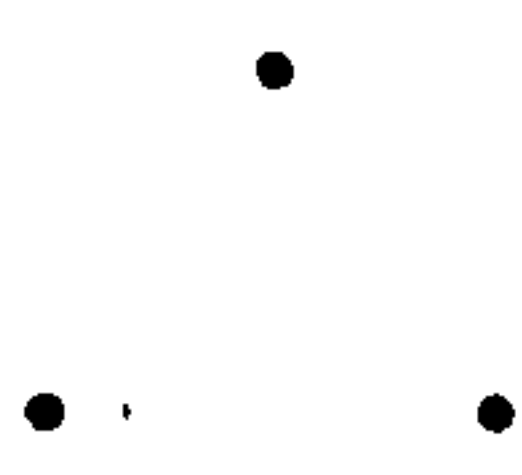

Each point 'stands outside' the order, the 'dimension', constituted by the other two. Here, therefore, are three symmetrical ways of considering the way that Unlimited 'stands outside' Limit; three symmetrical ways of marking a 'point' in the open Space or 'field' of determination, <sup>of</sup> marking, which stands outside the order(s) marked by the way the remaining two stand outside one another.

Here, then, in a way, is a 'deeper' expression of the triad, of trinity, than that determined simply in terms of the series of the Odd. For there the 'middle' term of the three remaining after the identification of one of four as the unit was not 'symmetrical' with the other two; it had a singularity, reflecting that of the chosen corner as unit, amounting to being 'in the middle' of the number:



We can now reflect this correspondence of one and three, their mirroring in the two, by adding to our triangle, our 'three' as presented above, this 'three with a middle term' as a third term after 'one' and 'two':

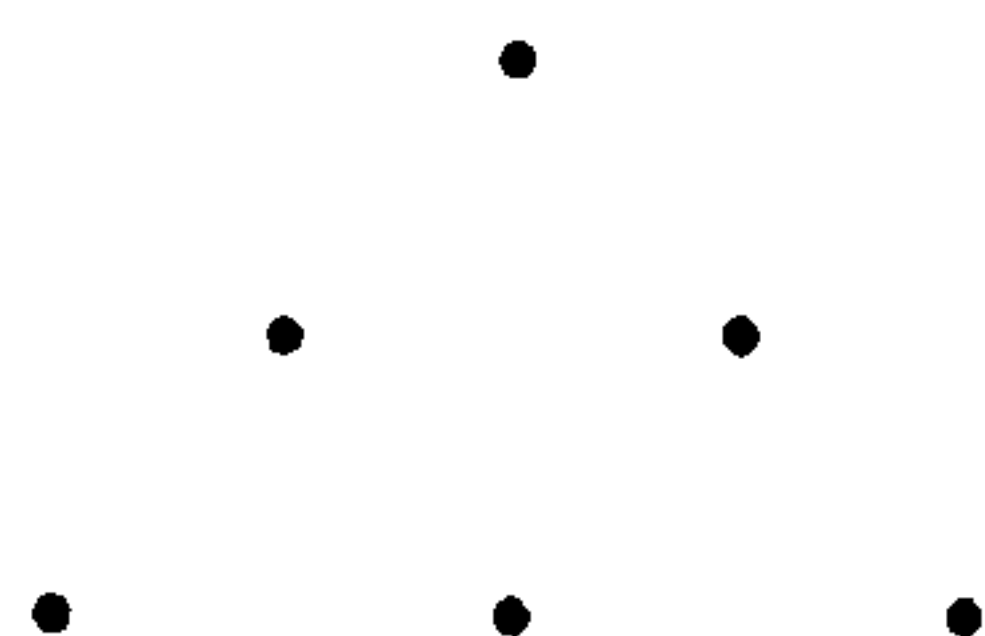

Then, as we choose one of the three symmetrical corners of the figure, we also in effect choose the 'middle' term opposite 'reflected' in the intervening dyad that the first term 'stands

outside', just as the unlimited field of Space is 'outside' determination by any particular configuration, if not (though) 'outside' a formal determination in terms of the 'closed' symmetry of the various orders (or 'dimensions') of 'standing outside' some other order.

Thus, just as one can 'physically' mark a point in a 'dimension' outside the dimension defined by the way that a 'second' point stands outside a notional first point or mark, one may go on to mark a further point that stands 'outside' the two-dimensional order marked by the way that each 'point' or corner of the 'triangle' stands apart from the order, the 'line' marked by the other two. But then, 'physically', one cannot find any other dimension outside the ways that these four points stand each outside the 'trigonometrical' or triangular order of the other three, in which to mark some fifth point. .. Unless this be by turning to another kind of order, another order of 'dimensions', of 'standing outside' some frame of determination. Unless it be, for example, by introducing some order that is 'outside' physical Space - the order of Time, for example, associated with the mirroring of spatial configurations, and the 'crossing' in and out of figures, whether these 'figures' (in turn) be simply 'spatial', or whether they belong to that mirroring of spatial and logical orders of which Time itself is the primary 'physical' expression.

We have already seen how the unitary order of definition in the point itself is reflected in the two twos of the four-square. And I have just begun to suggest how the 'fourth dimension' of the physical space of marking amounts to the reflection of the first dimension or order of the 'line', in the physical surface which it 'crosses', from one side to the other of its mirroring. Time, corresponding to surface as Light, in its mirroring, to the two 'dimensions' of Surface, of the Face of things - ἐπιφάνεια, Epiphany, shining-forth, appearance - the Out-Side:

τὸ γὰρ χροῦμα ἢ ἐν τῷ πέρατι ἔστιν ἢ πέρας.  
 διὸ καὶ οἱ πιθαγόρειοι τὴν ἐπιφάνειαν χροῦν ἐκάλεσαν.

For colour is either in Limit, or is Limit. So the  
 pythagoreans called ἐπιφάνεια, 'χρoυά'. \*

\* Aristotle, On Sense III.

- Let us not forget that we mark something by choosing some mark or term from some range, some 'field', with its various dimensions, and that there may be great difficulties in the transposition, in the 'translation' of what pythagoreans might have marked by some term (or figure) into our terms. Great difficulties: in the transposition or transcription of some configuration within the orders or dimensions of their Kosmos into a frame in which we can mark or remark their vision of Kosmos itself. Our only guide thus far has been the proposition that this Kosmos, which we mark here as 'Kosmos', is in some sense the same, whether it be framed in their terms or ours. For it has been suggested that this 'Kosmos' marks here some common frame of our relations, writer, readers, pythagoreans, in time and place, in bodies, in words. A 'community' marked by that very word.

... ἐπιπέδον they called χροιά: what does that mean? Either word can mean 'surface', either can mean 'colour'. χροία can itself have either sense. Our critic here transposes a pythagorean perspective into his terms, and this in (or 'on') his own terms. 'Our critic': Aristotle. 'Aristotle': a name, marking as it were a point of assertion, of authority; a point of view... a fairly 'exact' point of view, in which ἐπιπέδον is 'mathematical' surface, and χροιά its: appearance; its 'complexion', its colouration.

This abstract Surface is for Aristotle the 'limit', πείραξ, of a 'body'. Now the primary distinction of ἐπιπέδον and χροιά follows the distinction of the sort of bodies which we are in, and the sort of bodies 'outside' us - χροιά relates primarily to our 'skin' and its ('our') colouration. The point of 'confusion' of these terms, which we have now reached, corresponds to a 'point' which is 'outside' the three spatial dimensions of 'body', σῶμα.

...But what is there in the 'nature' of a 'physical' space which 'closes' it in three symmetric 'dimensions', so that the 'next' dimension 'outside' this closed ternary symmetry of Space (or rather the next 'dimension' corresponding to the way the next 'point' stands (logically) outside this configuration of physical Space) introduces (or belongs to) a new 'order' of things? The pythagoreans, we know (that is, all accounts agree on this point), associated this 'closure' of the physical order of Body and Space with the configuration of the

Tetractys. By starting from a first mark or 'point', and successively marking a further point 'outside' this, another outside the order or dimension in which these 'stand outside' one another, and another outside the configuration of dimensions marked by these three, one 'closes' the physical order of Space in a system of four triangular planes (each meeting in a line or edge, and these edges meeting in four symmetrical points) which constitute the closed surface of a 'physical' body. An analogous succession, from one to four points, can be seen in the Tetractys. Yet this analogy hardly 'explains' or determines the limitation of physical Space to three symmetrical dimensions. The fact that there is no further dimension in which to mark a fifth physical point, symmetric with the four vertices of the 'first solid', itself reflects some mysterious determination, rather than itself explaining it. What more is there, beyond this 'superficial' analogy, in the Tetractys, which might in some way correspond to the 'closure' of the three dimensions of physical Space?

All accounts also agree upon the importance attached by pythagoreans to the corresponding 'closure' associated with the decad in the unitary or linear order of counting:

*εἶναι δὲ τὴν φύσιν τοῦ ἀριθμοῦ δέκα. μένει γὰρ τῶν δέκα πάντες Ἕλληνας, πάντες ἑσπεροὶ ἀριθμοῖν, ἐφ' ἧ ἐλθόντες πάλιν ἀνασπασθῶσιν εἰς τὴν μονάδα.*

Ten is the nature of Number. All greeks, and all speakers of other languages, number to ten, and having reached it return once more to the unit.\*

- But again, in what sense can the arrangement of the first four numbers in a symmetrical configuration be properly taken to determine this (to us) rather arbitrary way that their sum marks a sort of closed set of terms, vaguely analogous to the closed set of terms defining the basic orders of physical configuration in Space? Might we find in the Tetractys some correlation of these 'logical' and 'physical' closures associated with the unit or point?

We further know of the central role of an order intermediate between these 'arithmetical' and 'geometrical' orders, which was also associated with the Tetractys: the 'harmonic' order. What if we could find in the correlation or 'harmony' of these three a reflection of the three orders of Limit-Unlimited/Odd-Even/One-Many, and thus a reflection in the Tetractys of the 'cosmic' configuration in which these

two aspects of Unit and Tetractys are coordinated? What if we could find in the Tetractys of the Decad a reflection of Limit-Unlimited/Odd-Even/One-Many in 'One-Many' - in Number?

Such a mirroring supposes a correlation of the order of Odd-Even, which we have already seen reflected in the configurations of Number, in the order of 'Harmony'. In effect this correlation has already been suggested in the elementary discussion of Odd as Square, in terms of the way that the Four or Tetrad, as Square (that is, in that symmetric expression of the Four in two 'dimensions') can be said to be 'composed', <sup>from</sup> to contain as elements, two Twos, Dyads. (Thus, following the pythagoreans, we say that Four is the 'square' of Two). We saw how the 'twoness' of the two Twos in Four 'mirrors' the unit in the four units of the Square in a way that reflects the configuration of Closed-Open or Limit-Unlimited in or through which the unit or point is primary 'mark'. The point as mark is determined, marked, decided or chosen, 'through a sort of abstraction from the 'dual' duality of Open and Closed (or Limit and Unlimited) as themselves two 'sides' of their opposition or complementarity.

To what extent can we regard this simple configuration as embodying the fundamental principle of 'composition' or Harmony in which figures (and the principles they reflect) occur 'in' other figures, as the Two appears, 'squared', in the Four? All accounts agree in attributing this focus (as it were) of pythagorean Kosmos to the embodiment in the Tetractys of the principle of musical harmony, the elements of that musical 'harmony' or scale (*ἡρμονία*) which comes 'full circle' in a way analogous to the decad in 'linear' numeration and the four-cornered (or four-faced) tetrahedron in 'space'.

In what sense can this *ἡρμονία* or 'scale' be seen in the Tetractys? Again accounts agree: just as the Two can be seen to relate Two and Four, so we can divide this doubling of Two to make Four into the *λόγα*, 'ratios' or relations Two-Three and Three-Four, and so again find the unit within the doubling of the two: and this division of the 'scale', of the 'interval' in which the unit appears 'outside' the first note or mark in the 'dimension' of sound, defines the principle of musical harmony. For example we 'hear' a plucked string of length three units as exactly 'between' the plucked string stopped at two units and stopped at four.

or rather:  $1, \frac{1}{2}, \frac{1}{3}, \frac{1}{4}$



This recurrence of the unit in the 'harmonics', the 'fitting-together', of the first four terms, is simply reflected in the Tetractys:

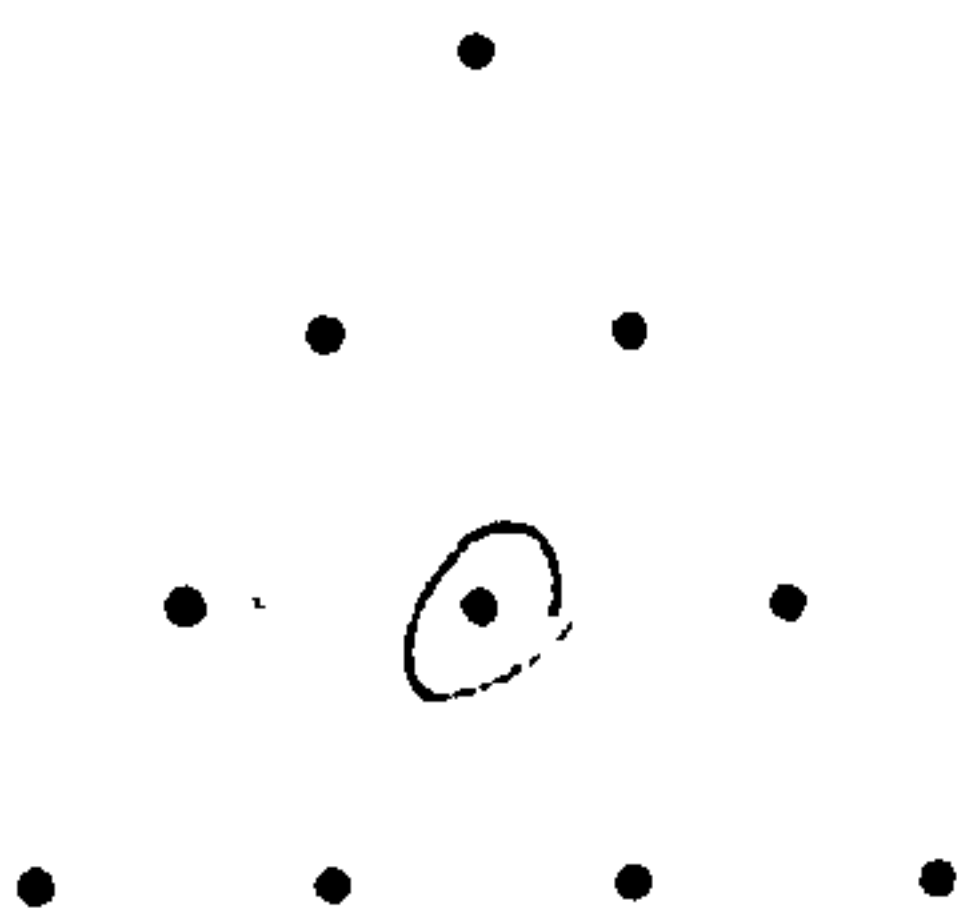

- In the mirroring of the succession of the elements of the figure, One, Two, Three, Four, in these successive terms (that is, in the mirroring of the two 'dimensions' of the figure - so that, for example, the first unit 'stands outside' the way that the two units of the second term (Two, the dyad) 'stand outside' (or differ from) one another) we see in the middle term of the third element (starting from any of the three corners of the figure) a 'middle' term for the figure as a whole.

Might we somehow see in this recurrence of the unit in the symmetry of Surface a 'mirror' in which the 'logical' (and linear) recurrence of the unit in the Ten is reflected in the closed symmetry of four surfaces (together constituting the closed surface or limit of a 'physical' body)?

Consider the different ways in which the numbers go together in line, surface and solid. In the tetrahedron, One, Two, Three and Four are as it were 'nested', each 'dimension' in the next: two points define (or limit, bound) a line; three lines a face, and four faces our solid. If we are to build up the three-dimensional figure by successive marking of four points, we will have a fourfold choice of where to begin (or better, where we began), a threefold choice of the next point or limit, a two fold choice in the next, and finally the bare choice of whether to mark or not to mark the last point, whether or not to define the figure as a whole. We might express these different ways of marking the figure by a simple list of ten terms, each marking one choice, or (equivalently) one 'element' of the figure: since we might arrive at the elementary mark by first choosing a face, then an edge of that face, then one end of that edge. But while expressing

the equivalence of the ten choices simply as markings, choices, determinations, this list of terms (each consisting as it were of the complementary possibilities of choosing or not-choosing that point - or 'at' that point) does not express the inter-relations of these ten determinations. (The completed solid, on the other hand, does not express the independence of the ten determinations). In what sense are these two aspects - 'logical' and 'physical'-of marking related in the 'harmonics', the fitting-together, of the elements of the Tetractys? And in what sense, then, does the Tetractys express Harmony or composition in general, through the way that these complementary 'logical' and 'physical' (inward and outward) aspects fit together in it?

The Tetractys seems to do just this through reflecting the linear arrangement of the first four numbers in the 'linear' dimension of their successive marking: first One, second Two, and so on. In this way it composes or fits-together the Odd and Even as these are expressed in Number or Figure, as they are marked. Previously we saw how the element of 'choice' or determination in the Mark (the way it reflected the act or actuality of marking) could be seen in the way that each corner of the Square, or Four, 'abstracted' from the Even, through its reflection in the two Twos of the sides. The Square thus expressed, in terms of the Odd, the reflection of the principle of Limit in the Mark. And yet the Even still remained in the symmetry of the four corners of the Square, as it remains in the symmetry of the four vertices of the tetrahedron. We saw how the choice of one corner at the same time marked out one 'opposite' corner, 'between' two symmetrically adjacent corners, and saw in this a reflection of the limiting or determination of the first mark in the Three which expressed the configuration of the unit together-with the symmetry of the dyad... the dyad which, by marking a point 'outside' the first point, expresses, through the 'even' symmetry of those two points, precisely what is 'outside' the 'odd' singularity of the first point (and the single point opposite). We saw how the symmetries and disymmetries involved 'at this point' were reflected in the figure:

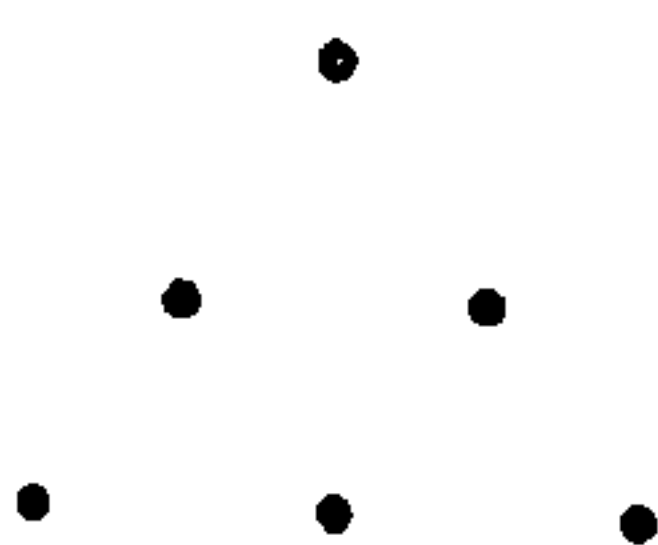

- but then this six-fold configuration presents us with three symmetrical 'reflections' of unit in dyad (beginning at each corner). Just as, in the Introduction, we had to introduce a fourth term to differentiate or distinguish the two 'sides' of the Knot (embodying an analogous symmetry) so here we introduce a fourth term, corresponding to the fourfold symmetry of the Square, 'Justice', and find that the 'reflections' of unit in dyad, starting (symmetrically) from any corner, coincide in one and the same point:

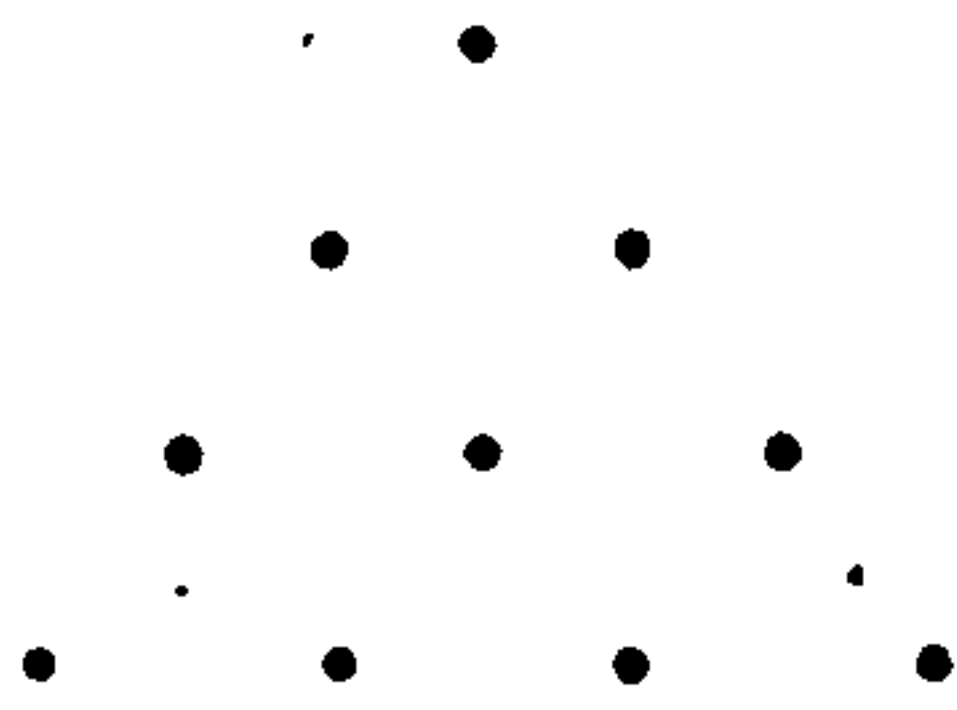

- so that <sup>through</sup> the symmetries implicit in the initial mark, we return, by the fitting-together of Odd and Even, to the unity of the mark, and in this recurrence express the reflection of the principle of Limit in the domain of Number, just as in the Square we expressed the Odd.

This reflection of Limit in Number as the Tetractys of the Decad is analogous to the reflection of the logical in the physical, of the 'inward' logic of distinctions, 'abstract' differences, in the physical differences, 'dimensions' implicit in the physical symmetries of marking. And this reflection of the 'logic' of distinction and identification in the open 'field' of physical difference expresses that closure of the logical 'circuit' in which a physical difference is used to mark the distinction of physical and logical orders. Conversely, we see logical identification reflected now in the physical closure of body. The Tetractys relates these converse 'closures' through correlating in terms of the elementary mark or point in which they coincide the 'physical' configuration of Body, and the logical articulation of its symmetries. Thus we see that what is primarily 'marked' (or remarked or identified) is the physical identity of a body, whose 'closure' (whose different 'inside' and 'but-side') corresponds to its 'surface'. With the identification of this Body, we move out of the 'even' mirroring of physical and logical orders of determination into a different order. The Tetractys marks the closed configuration of that 'finitary' symmetry, and so directly re-

flects in the Number that is the general frame of this complementarity or mirroring of physical and logical orders the principle of Closure or Limit itself. Limit, thereby, is reflected, through Odd and Even, in the Tetractys, just as logical distinction is reflected, through the Tetractys, in physical terms. The Tetractys reflects, in the 'even' exact expression of figurate Number that principle of composition, of the fitting of one principle in another, whose particular instances are reflected in the way that one number of figure is 'composed' of others, as for example the Tetractys is composed of the first four numbers.

This general principle of coordination of Kosmos - 'Harmony', fitting-together, unity-in-multiplicity - can be seen in the way that the Tetractys itself 'fits in' a cosmic scheme, a Kosmos, which it itself reflects. As was suggested at the outset, it expresses in 'Number' the configuration of terms in which Number itself (as one of the terms) is delimited or defined. From Limit and Unlimited come Odd and Even, from these Unity and Multiplicity. Odd is reflected in the composition of Unity and Multiplicity in the Square, 'Justice' (what is 'fitting'). In the next step, Limit is reflected in Number, in Unity and Multiplicity, as Tetractys. Schematically we might present the situation thus:

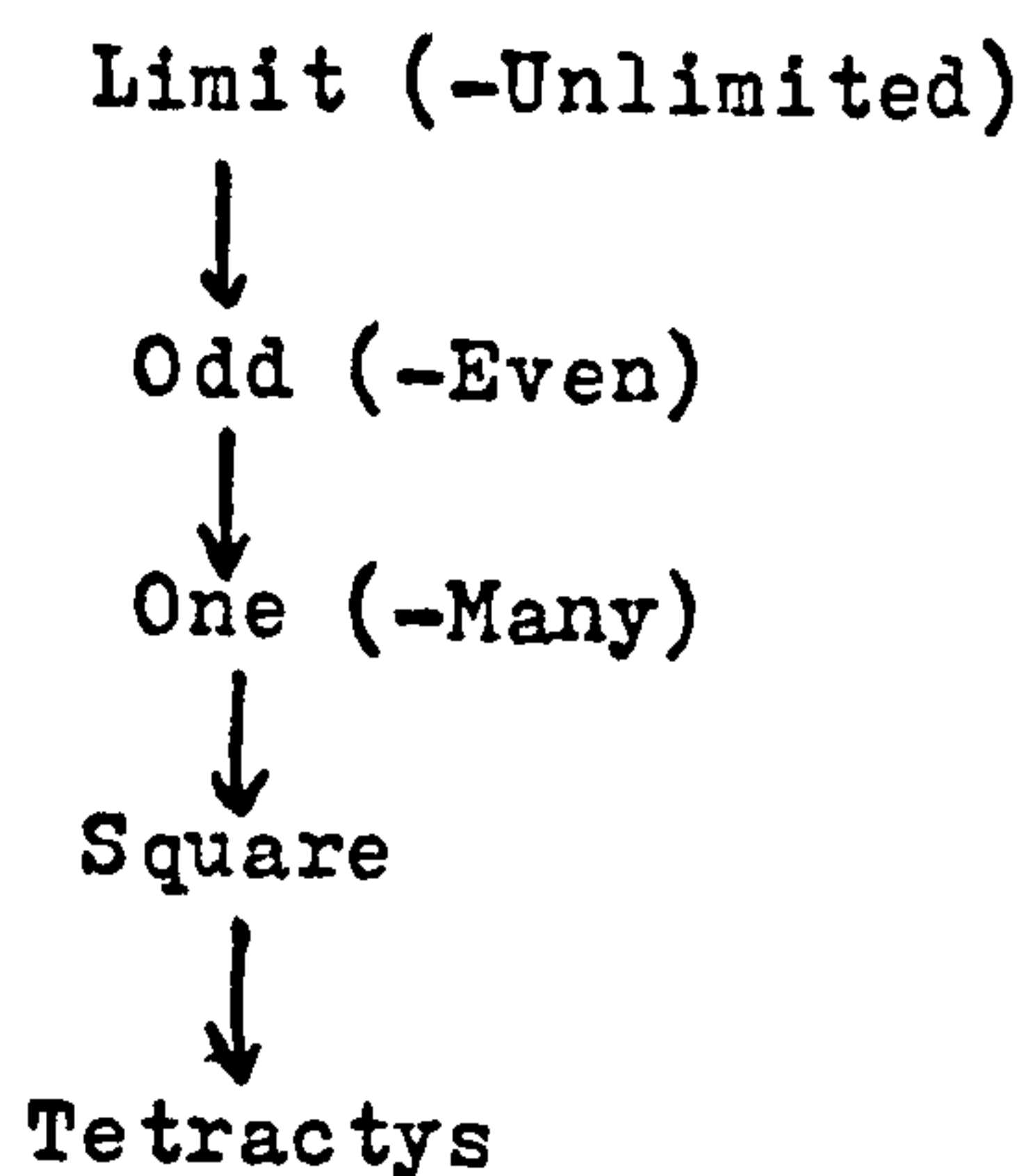

- the order of 'mystical' determination, proceeding from the ultimate singularity of Limit, is reflected in the order of the unit, point, or mark, and comes 'full-circle' in the Tetractys.

'Some' pythagoreans (quite which ones or when is uncertain) went on to specify the ten primary terms of choice, ten primary opposites, in which (in whose coordination) the internal articulation

of this circuit might itself be mapped out (just as the Ten or Decad 'logically' presents the terms in which the physical identity of the mark or point is to be determined or understood). Aristotle records the following list of opposites:

πέρας	καὶ	ἄπειρον	(	Limit	-	Unlimited
περιττόν	καὶ	ἄρτιον		Odd	-	Even
ἓν	καὶ	πλήθος		One	-	Many
δεξιόν	καὶ	ἀριστερόν		Right	-	Left
ἄρσεν	καὶ	θηλυ		Male	-	Female
ἠρεμῶν	καὶ	κινουμένων		Resting	-	Moving
εὐθύ	καὶ	καμπύλον		Straight	-	Bent
φῶς	καὶ	σκότος		Light	-	Dark
ἀγαθόν	καὶ	κακόν		Good	-	Bad
τετραγώνον	καὶ	ἑτερόμηκες		Square	-	Oblong (†)

Even given this list (or a close variant recorded by a later writer<sup>(2)</sup>) it remains unclear how these terms might be supposed articulated like the points as terms of the Tetractys. - How, that is, they might reflect an 'ontological' constitution of things in general, analogous to the 'logical' constitution of a physical body; how together amount to some 'ontological' analogue of the tetrahedron as primary physical expression of the unity of Body.

There are, certainly, evidences of such considerations in the order of the table: the fifth alternative, for example, 'Male-Female', corresponds in many respects to the fifth and central point of the Tetractys, to the Five that was called 'Marriage', being the conjunction of the first ('male') Odd and ('female') Even numbers, of Three and Two. Five is, in turn, 'halfway' to the tenth opposition or alternative in which the principles of Limit and Unlimited or Odd and Even are expressed in terms of corresponding figures, Square Odd and Oblong Even. Right and Left correspond to the principle of mirroring in, and transition through, surface, associated with a 'higher' order that we saw supervene after the first three oppositions here had been 'worked out' in the three dimensions of physical Space.

Many other correspondences might be traced, and many certainly were followed in the application of numerical 'harmonies' or pro-

!

portions to the more general order of Harmony or composition that is Kosmos itself. Yet we cannot suppose that the 'closure' of the pythagorean mystery incorporated the exact reflection in the general order of Harmony or Kosmos, of the exactness of Figure that is one of its terms: we cannot suppose that the whole configuration of themes was 'squared' in that sense. Indeed we know, rather, that such an extension of exact configuration from Number to the place of Number in the general Economy of Kosmos, corresponds precisely to the first 'publication' of an avowedly pythagorean 'system' of things, to first pythagorean book. Such a publication itself 'incorporated' previous perspectives which may be taken as 'criticism' of the unpublished mystery, criticism which 'stands outside' the pythagorean mystery in a way that is reflected in the very fact of publication. And the first and most important such criticism relates directly to this matter of the mirroring of the domains of ('cofinitary') Limit and ('finitary') Number in pythagorean Kosmos.

(in Parmenides' poem)

It is precisely in that criticism that we first see a systematic 'ontology', an economy of determination organised about Limit, as the economy of Figure is organised about the mark or point. Before this step, we can speak only of a partially systematic pythagorean 'phenomenology', which has not arrived at thoroughly general principles of constitution or articulation of whatever 'things' might be more general analogues of the numerical unit or identity. Principles giving the frame in which one 'thing' - say, Light - 'appears in' another - say, Body. General principles of composition, of the identity whose 'closure' on itself (or in itself) is first 'seen' in the closed surface of physical body.

Such a 'closure' is outside the circuit of the initial mystery of Kosmos, just as is the parallel system of a 'physiological' psychology, which expresses the economy of Determination or Choice as it is integrated in the activity of some-body (reflecting the way that the logical articulation of the Mark is integrated in the identity of physical body). Aristotle, giving the list of opposites above, wonders whether it might have been derived from the opposites whose integration was regarded as Health, perfect bodily order, by the medical school of Croton.

We do not find any closed system of terms in which the configuration in which Number is determined or identified exactly mirrors the logical articulation of figures through which physical body and physical mark are identified. Rather do we find that the question of the mirroring of Limit in Number, and Harmony, Kosmos, in the Tetractys, marks the distinction of an 'inside' and 'outside' of the pythagorean mystery. As has already been said, the closure embodied in the Tetractys, the reflection of the principles of marking within the domain of the mark, marks a 'point of transition' to another order. But we should not expect to inscribe this more general order of Kosmos within the exact economy of the mark. Rather must we now try and identify the place or part of the Tetractys in the Kosmos or mystery of Philosophy, into which it marks the transition, and of which it marks the closure. We must find the place of the 'reflection' embodied in the Tetractys in the mystery of Kosmos, rather than try and contain Kosmos in the logical circuit of a reflection which is simply one of its components.

Thus far I have only identified this Tetractys as point of entry into the pythagorean circle 'from the outside' - by situating it or marking it in an order marked here as 'Kosmos'. Now we must enter properly into the pythagorean mystery, see a little how it works, and see if their κόσμος is indeed our Kosmos.

Aristotle complains

ὅπως δὲ τὸ πρῶτον ἐν συνέσει ἔχον μέγεθος, ἀπορεῖν εἰσάγει.

..but/<sup>as to</sup> how the first unity with size was framed, they seem at a loss

- For this is the 'point' of entry into Kosmos as mystery of 'framing', synthesis, composition. An entry into the order in which the mirroring of arithmetic unit and geometric body in Figure (and, most particularly, in the figure of the Tetractys) is 'mysteriously' or mystically articulated as Actuality. Into the order in which Kosmos is actualised, 'works'. How does it work?

As Aristotle, and others before and after him, complain, this remains rather a mystery. We have already seen how the actual distinction and articulation of what I have called 'physical' and 'logical' orders, in the closure of the poetic 'frame' of their symmetry, cannot in principle

\* Aristotle Metaphysics...

be determined 'in' any of these three 'finitary orders', or in any configuration of them, taken 'in itself'. This actuality which distinguishes itself from these orders, is formally 'mirrored' in each, and in their combination, as something which can only be marked in them as being paradoxically or mysteriously 'outside' their determination, their 'limits'. This 'cofinitary' Actuality may then, through a kind of 'transfiguration' be seen to actually organise its own expression in the actual circumstances in which we recognise that the finitary configurations of (say) logical determination, cannot actually 'include' the actuality or fact of their expression. This very fact can only be marked in the logical order as 'outside' that order, and thus the very fact of that marking in a way expresses 'in logical terms' something 'beyond' logic: when the marking of the 'outside' of logical determination in logical terms is seen to reflect or express the fact of marking in this very marking which is itself 'outside' logical determination, the logical order of its articulation is turned (as it were) 'inside-out', 'transfigured' into the ontological articulation of self-expression.

Now it is the actuality of Limit that Aristotle here complains cannot be 'framed' in terms of the finitary logic of the mark or point. Yet we, with Aristotle and the pythagoreans, live or have lived in actual bodies, in an order of incarnation, in which our criticism of the inadequacy of our finitary logic for the determination of its own expression must itself be 'framed'. We will shortly see that it is Aristotle himself who (actually) introduces or introduced the technical term 'actuality', *ἐνέργεια* - being-at-work, to inscribe in his 'theoretical' determination of 'the' Kosmos, taken as fact, the mysterious self-expression of what is thus logically determined as beyond the logic of his world-frame.

In the 'cosmic' order in which this 'actuality' is actually and primarily 'at work' (rather than in the logical closure of the 'theoretical' order in which Aristotle puts it to work), we find its logically primary expression in the 'transfiguration' of the harmonics of the Tetractys, of 'mathematical' Figure, in its first inscription in this actual Kosmos which includes Aristotle, the pythagoreans, and ourselves. This actuality corresponds formally to the 'next' point after the four points of the tetrahedron, which 'stands outside' the



mirroring of the 'arithmetic' order of the line in the geometrical closure of Space in three 'dimensions' (or orders of 'standing-outside') through the symmetry of the Tetractys articulated in the two dimensions of ('plane' or uniform) Surface.

This 'missing' point marks, as we saw, the point of entry into the order of 'epiphany', of the articulation, in the mirroring of physical and psychical, or logical and ontical, in the closure of Surface, of the poetic framing of actuality in the mirroring of Time and Light. And this transition (to the order of transition), in which Kosmos begins to express its actuality as the self-expression of Limit, is the entry into a 'mystery' marked by the Tetractys: this self-expression of Limit is, we might say, the 'point' of the Tetractys, its invisible, secret, 'esoteric', missing point, the finality of Limit, distinguishing esoteric 'inside' and 'exoteric' outside of the pythagorean group and their mystery. From the 'outside' this transition naturally has the character (or figure) of ἀπορία, that difficulty of passage of which Aristotle complains: ἀπορίαν βίβλαρον. Characteristically, Aristotle ascribes the difficulty of passage or transition, insuperable in the frame or kosmos in which he inscribes the closed circuit of the pythagorean mystery, to the pythagoreans, rather than to himself. For his authority is contained in the logical circuit of a formal reflection; the authority by which the pythagoreans cross into the closed circuit of their mystery is that marked by the incarnation of Pythagoras, reflected in the Tetractys, 'their most binding oath'.

- An authority corresponding to the 'missing point' reflected in the Tetractys, an authority associated with the transfiguration of Pythagoras' incarnation, in his expression of Kosmos, or the self-expression of Kosmos through 'Him'. We learn that the Founder was always named thus within the mystery; that 'of logical (or rational) beings there are gods, men, and such as Pythagoras'.

An authority through which Limit as the 'missing point' in the points of the Tetractys articulates the actuality or working of Kosmos in a sort of cosmic 'accounting', unfolding from the initial convertibility of logical and ontical, psychical and physical in Epiphany, surface, at the opening of the account or framing of this Kosmos

Aristotle, quoted in Lamblichus' Life of Pythagoras (p 31, 144)

which closes in the framing of this very accounting itself.

'An initial convertibility', for the beginning of the frame of Kosmos, of Kosmos as the frame of 'accounting', corresponds, as we might expect, to the self-expression of Limit as the actuality which distinguishes itself from the finitary configurations of 'musical' harmonics (according to which, it will be remembered, one 'figure' is seen or found in another), in distinguishing between the musically symmetric logical order of terms and physical order of closure. Distinguishing between the ways that these orders are themselves 'seen or found in one another', mirrored in the Tetractys.

Kosmos, then, as Aristotle and our other authorities agree, 'first' actually appears (as Beginning of this Frame of all accounts or framing, as logical beginning of all stories in the History of Kosmos) in the first actual body, the first closed surface, the first actual Limit. In this actuality the mirroring of the psychical order of vision, θεωρία, in the physical order of surface, begins as the physical order of inside and outside is subordinated to the logical order of distinction in the actualisation of Kosmos. This amounts to the beginning of the ontical self-revelation of Kosmos which closes with the recognition, by the incarnate initiate of his (and His) place in the scheme, and the consequent framing of his activity in the mystery. This closed circuit, amounting to the closure of the mystery itself, begins (then) as it ends in θεωρία, vision, a 'theory' outside the authority of 'earthly' reflection embodied in Aristotles logic, the beginning and end of his story. The pythagorean 'mystery' is, of course, an important part of his story...

ἄτοπον δὲ καὶ γένεσιν παύσιν ἀδύνατον ὄντων, μᾶλλον δ' ἔν τῶν ἀδυνατίων. οἱ μὲν ὅν πυθαγόρειοι κότερον οὐ παύσαν ἢ παύσαν γένεσιν οὐδὲν δεῖ διατάξαι. φανερόν γάρ λέγουσιν ἕξ τῶ ἐνός σωμαθένους, εἴτ' ἕξ ἐκπέδων εἴτ' ἐκ χροιάς εἴτ' ἐκ σπέρματος εἴτ' ἕξ ἔν ἀποροῦσιν εἰπέω, εἰθὺς τὸ ἔγγιστα τὸ ἀπέριον ὅτι εἰλάκετο καὶ ἐπαρμένετο ὑπὸ τοῦ πέρατος.

It is odd to make eternal things come into being, or rather is this one among impossible things. But of whether the pythagoreans do this or do not, there need be no doubt: for they openly say that the One being framed, whether out of planes, or out of surface, or out of seed, or out of what they cannot express, the next of the Unlimited at once began to be drawn in and limited by Limit\*.

\* Aristotle, Metaphysics N 3

There is indeed no place for this mystery of beginning in Aristotle's vision of Kosmos: it is *ἄνωκος*, this first place, <sup>ἄνωκος,</sup> and so impossible: it can't work. Its only place, is as one among the formal non-space of Impossible Things. In a way, this is just where the pythagoreans are said to frame it: as self-expression of Limit 'in' the otherwise unlimited opposition of Limit and Unlimited. The framing of Kosmos then begins to repeat the framing of the Tetractys, until the 'harmony of the spheres' is closed in the Sphere of Heaven, as the logical order of construction closes in the physical closure of this Kosmos. We learn elsewhere that this initial 'cosmic' One, the 'first' place in every sense, is a central Fire or Light, about which is articulated the point-like configurations of planets, stars, and the outer or limiting fire of the galaxy, 'milky way'. The details of this organisation vary considerably in different accounts, but there are certain simple elements, a simple frame of elaboration, common to these various accounts, and in which their variations can themselves be articulated - as different perspectives corresponding, as it were, to the changing place of the initiate or heretic over time, in this common frame of 'Kosmos' amounting to the coordination of common elements in the constant frame of *Θεωρία*, theory itself.

In some accounts, this surface on which we live, on which this drama of framing Kosmos, from the pythagoreans to ourselves, takes place, is associated with the third 'place', for example, the body of the 'Moon' above with the fourth, the body of the 'Sun' with the fifth, the middle, place. In all accounts the Sun is in some sense a 'middle' between the central fire and the enclosing sphere, 'reflecting' the organising fire of the first cosmic unity, the focus or centre. In all the organisation of the cosmic or heavenly bodies follows the principle of 'musical' harmony discovered in the Tetractys, though details of application vary considerably. In all accounts we find the analogue of the square as Justice 'ruling' the whole through the inscription in Limit of the otherwise unlimited opposition or complementarity of Limit and Unlimited. We often find the Sun, as middle term in the proportion or harmony of the whole, associated (as both Five) with Marriage, with the 'mixing' or combination of Male and Female, Odd and Even.

As has been already suggested, the systematic working-out of the mirroring of such cosmic Harmony, and the harmonics of mathematical configuration, Number (this in the mirror of *Θεωρία*) coincides with the first 'publication' of pythagorean 'theory', a transition, as it were, from 'inside' to 'outside' of the mystery inscribed within the mystery itself, as then understood. All accounts (again) agree upon the association of this first publication with the teaching of Philolaus, who left a troubled Greater Greece for the city-state of Thebes roughly (in time) between the first institution of the mystery at Croton, and Aristotle's elaboration of his own position, and his own conception of *Θεωρία*.

Let us then pass over details whose exact place in the esoteric tradition between Pythagoras and Philolaus we cannot determine, and for the moment simply emphasise the reflection in a pythagorean frame of 'cosmology', in which different accounts of details are open to various reconstructions, of the fundamental principle of self-expression of Limit, first seen in the Tetractys. That cosmology begins in the complementary differentiation and integration of 'psychical' and physical orders in a 'physical' Kosmos or macrocosm; it closes in the recognition of the place in this of the relation of psychical and physical elements in the initiate him- or her-self. These two limits of poles of 'vision', *Θεωρία*, of the <sup>cosmic</sup>perspective of the initiate are themselves mirrored in that ambiguity of the 'surface' or complexion of a body we are 'in' and a body 'outside' us (a 'physical' body) that we found associated with the 'epiphany' that is the central self-expression of Limit, the 'medium' of that 'vision' by which we can begin to actively participate in Kosmos. This actuality of participation is analogous to an 'entry' into a language: the 'language' of the pythagorean group as 'closed', 'esoteric', as a mystery - as their mystery.

This mirroring of the two poles of 'theory', and the self-expression of the mystery of Kosmos in its articulation as 'vision' - a vision (then) or epiphany which bears to earthly sensation a relation analogous to that borne by the 'language' of the mystery to 'earthly' speech (or the 'music of the spheres' to earthly music and harmony) - is seen in simple terms in the Life of Kosmos:

**TEXT BOUND INTO  
THE SPINE**

In the first book of On the Philosophy of Pythagoras he (sc. Aristotle) writes that Heaven is a unity, and that from the Unlimited are drawn in Time and Breath and the Void which is always distinguishing the places of things\*

Macrocosm and microcosm (if we may use these later expressions for the two limiting poles of Kosmos) share in a common figure of Life in which  $\phi\upsilon\sigma\iota\varsigma$  mirrors  $\psi\chi\acute{\iota}$  as two 'sides' of 'living' surface. The epiphany of Kosmos is, above all, Life, a participation in Actuality as Life, whether physical Fire, or psychical self-assertion, or the Light, Figure, and Surface, the 'Epiphany', in which they share. Life that expresses itself in the primary articulation of the poetic symmetry of physical and logical orders of determination in the frame of the story and the action for which it accounts - which articulates the primary frame of actions - and of our breathing actuality - in a frame of Place and Time.

This common frame of Life, expressing the recurrence of Limit in the opposition of Limit and Unlimited (like the recurrence of fire - as it were - in the surrounding matter ignited by the first burning matter, the first spark or seed of fire) corresponds directly to Justice as frame of accounting. Justice is, in the terms developed at the beginning of this Part One, the very Law in which we must frame (and then account for) our actions. Justice: reflected in the 'mathematical' laws relating the symmetry of the Square to the line or side, through a sort of 'abstraction' from the symmetry or 'even-ness' of the two ends of each side, in the symmetry of the two sides, finding a recurrence of the One in the Four. Justice as Measure, and so balancing, reciprocal,  $\delta\iota\kappa\alpha\iota\omicron\upsilon\sigma\iota\varsigma$  <sup>σοφ</sup>; as one side exceeds the square, so the other side (of what thus becomes oblong) falls short, in a way that preserves the Square as common measure. It is just such a principle of relating magnitudes through their 'composition' in two dimensions that organises the method of 'application' of area to line, which is central to the pythagorean 'geometry', the measure or logic of length, rather than discrete units. It is the discovery of 'proportion' in the relations of such continuous lines that constitutes the great significance of the  $\Theta\omega\sigma\epsilon\gamma\mu\alpha$ , the vision for which He is said to have sacrificed an ox, still known to us as 'Pythagoras' Theorem'.

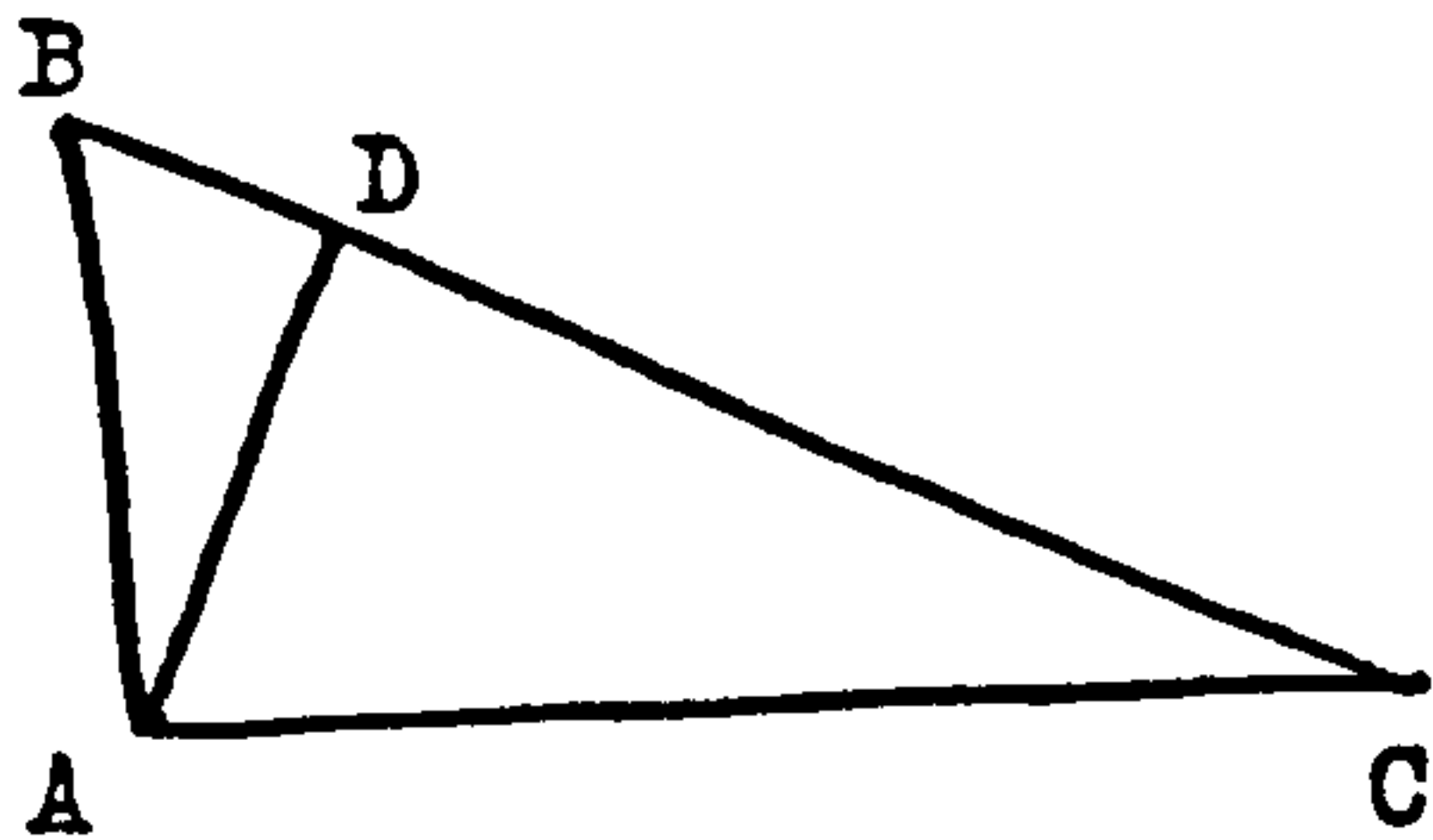

- If BAC is like the corner of a square, in which the four corners are symmetrical, and ADC (and so ADB) is made the same, then the three triangles constituted from the four points of the figure (taken three at a time) will all embody the same proportions, the same 'figure' of a triangle whose sides are in a certain proportion, one to another. Thus the proportion  $BC:AC$  is the same as  $AC:DC$ ;  $BC:BA$  is the same as  $BA:BD$ . And as  $BC$  is the 'sum' or linear composition of  $BD$  and  $DC$ , so the 'square on  $BC$ ' is equal to two rectangles on  $BD$  and  $DC$  of which it is 'composed', the 'sum':

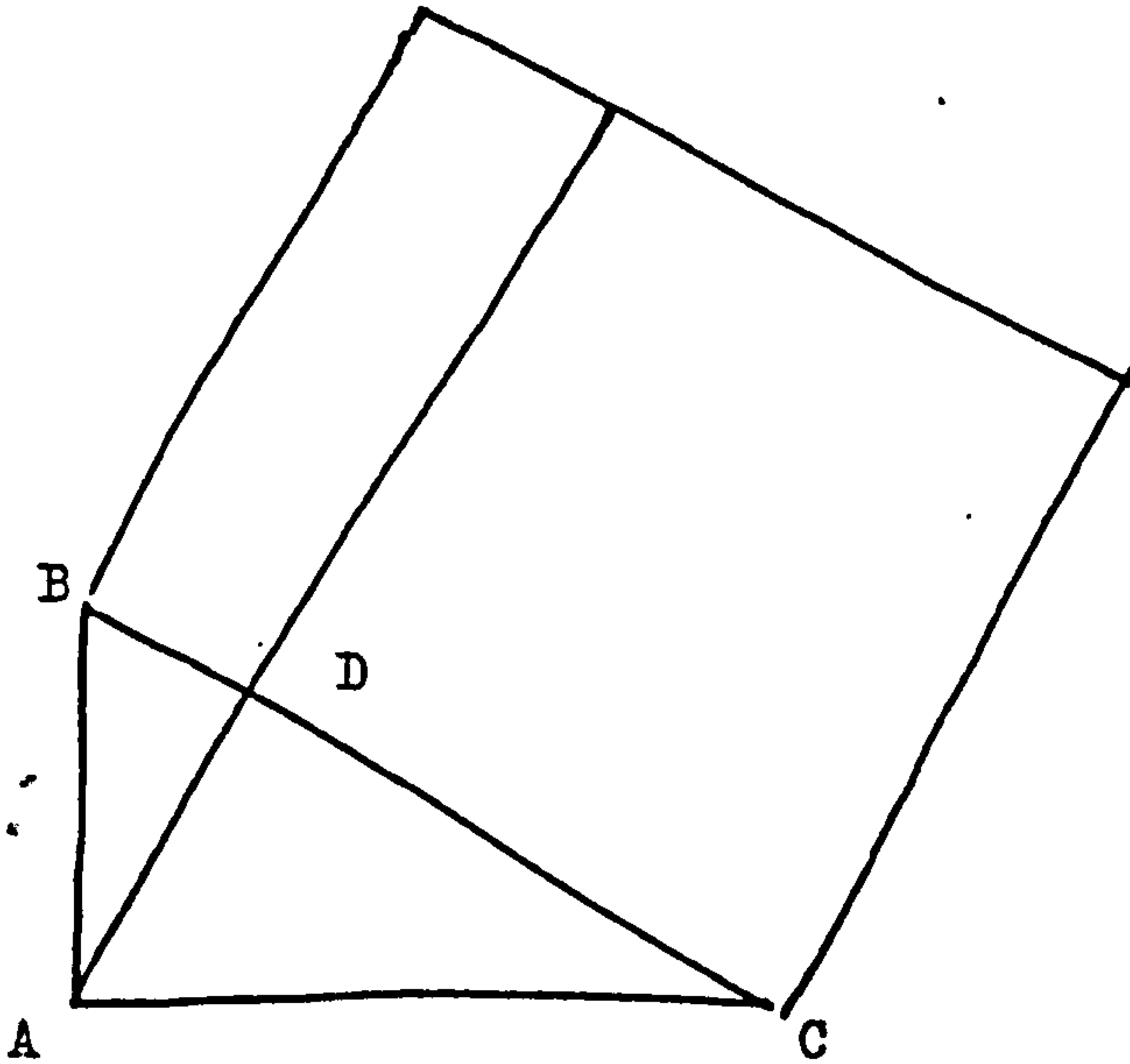

- and from the 'continued' proportions noted above, whose middle terms are  $AC$  and  $BA$ , we see that the component oblongs or rectangles of 'the square on  $BC$ ' are equal to the squares on  $AC$  and  $BA$ : it is in this sense that the measurement in two dimensions is 'reciprocal', *ἑναεναοῦς*, like Justice...

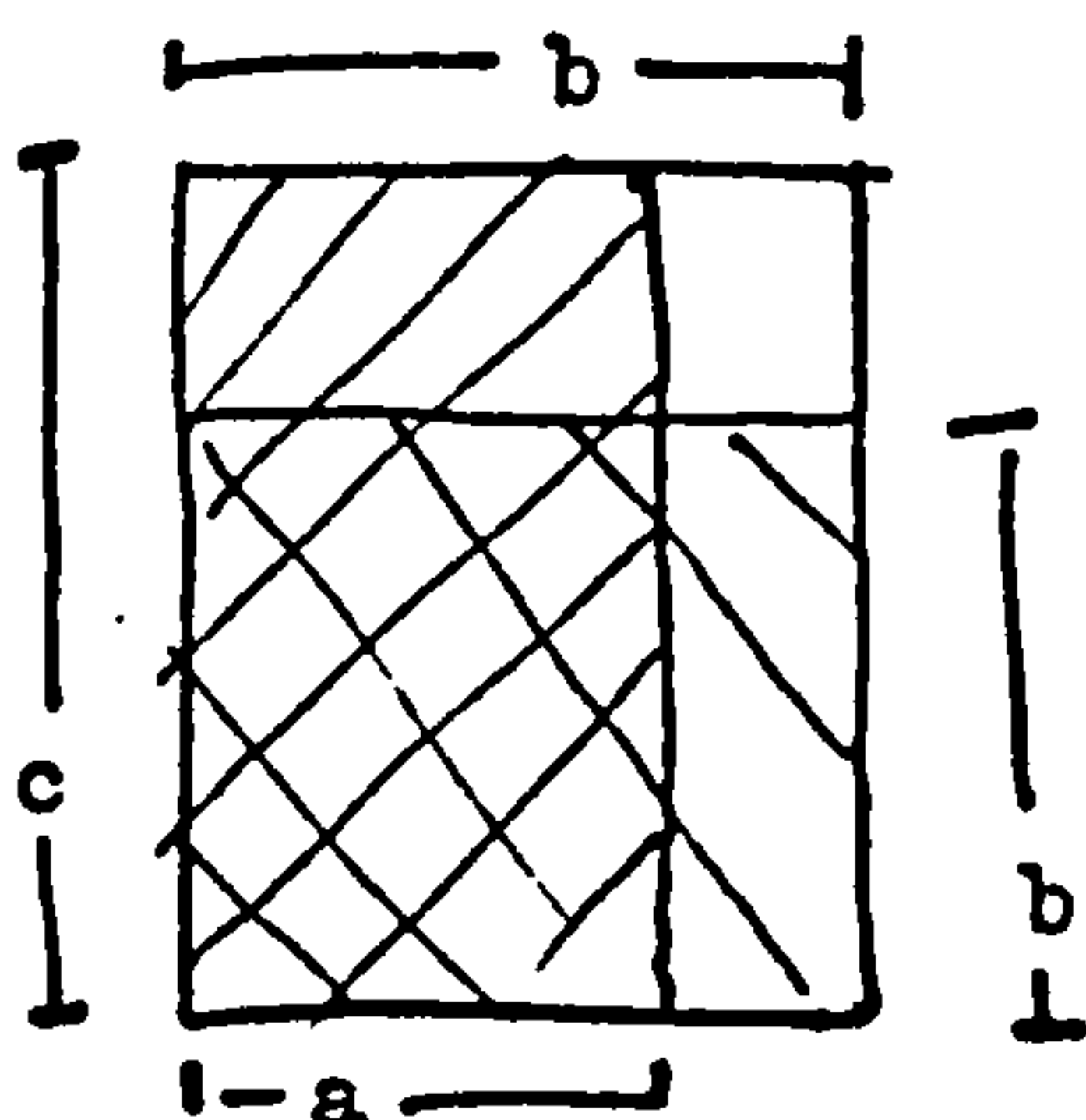

... for the cross-hatched oblong with sides  $c$  and  $a$  is the same part of the whole oblong on  $c$  and  $b$ , as is the square on  $b$ : for we know the side  $a$  of the first is to the side  $b$  of the whole, as the side  $b$  of the square is to the side  $c$  of the whole. (In pythagorean terms this is 'appling the square on  $b$  to  $c$  (or  $a$ ) as side of a rectangle').



What, then, does this cosmic 'Justice' mean to the pythagorean initiate, embodied on this Earth, this one cosmic surface, or sphere, among others, between the central 'focus', hearth, *Ἑστία*, and a containing unity of the sphere of Kosmos as a whole ( which contains the central fire as the Tetractys contains the unit, the first point)?

Just as the Tetractys relates arithmetic multiplicity to geometric closure through musical harmony or proportion, so it seems that the multiplicity of bodies and places in the closed sphere of Kosmos are held together by an analogous Harmony. Many aspects of the various accounts that have come down to us of pythagorean cosmology partake of a common 'figure' of analogy: the sphere of the Sun reflects the central fire, as the third term in the Tetractys reflects the initial unit in the interval between the second and fourth terms. In the Sphere of Kosmos, whose closure is analogous to the recurrence of unity in the Tetractys of the Decad, the Sun reflects the organising Fire and Life of the Centre, in the interval or 'space' between Earth and Sphere. In this sense, Earth is the primary 'sphere' of unlimited Even-ness, one-sided disproportion, the endless movement and conversion of opposites, of the different 'sides' or aspects, components, of things. But in this constant movement of *φύσις*, Nature in the limited 'physical' sense, this outward side of the Life in which *φύσις* and *ψυχή* mirror one another, the Limit that is reflected outwardly by the association of natural law with the sphere of the Sun, is reflected in the sphere of Earth, of our subjection to 'physical' embodiment, 'physical' life, as the closed circuit of Law in its restricted sense.

This earthly Law, corresponding to the reflection of the cosmic community of all Life in a particular earthly community (the autonomous city-state), is the primary earthly expression of Justice. The 'outward' teaching of the pythagorean school would appear to insist upon the central importance of Law in earthly life, just as the 'inward' or esoteric instruction made central that cosmic Justice of which earthly Law is a reflection: this Law plays the same part in the sphere of Earth as does Justice in the wider Sphere of Kosmos. As far as we respect this multiple image of cosmic Justice, we abstract ourselves from the earthly domain of physical body, and participate in a psychical domain whose 'natural' place is not this Earth... we tend towards our 'true' sphere in which the psychical dominates the physical in the frame of

of Justice, our 'Good' as the subordination of the opposition of Rest and Movement to the regular cycles of the heavens, like the subordination of the opposition of Odd and Even to its 'squaring' in 'mathematical' law.

Insofar as the relation of our psychical 'nature' is subordinate to our physical nature in our earthly embodiment or incarnation, we remain within the circuit of earthly life, in its constant movement without any fixed limit or finality. One unbalanced impulse of physical nature is repaid with a reciprocal or contrary imbalance, and so on, round and round in cycles of earthly reincarnation, until the cosmic Justice which governs this endless circuit of the Unlimited, of Movement without fixed finality or Limit, is recognised. Until, in the detachment from this unlimited symmetry of accounting, we begin to participate in the self-expression of Limit, begin to frame our activity in 'cosmic' terms - to see our place on Earth in the frame of Kosmos, rather than see the heavens in earthly terms. And the conversion of earthly and heavenly is marked through the mystical vision of the earthly law of an earthly community in cosmic terms, as an earthly reflection of Justice; the entry into that mystery is in turn marked by the minimal self-expression of Limit in the symmetry of the earthly mark, organised in the Tetractys.

How far does this account for the actual working of the mystery of Croton? Perhaps the expression here is too 'symmetric', too exact, too 'closed' in the circuit of terms which, it is suggested, here reflect the closure of the pythagorean mystery. 'Reflect': for it is suggested that the circuit traced in outline here, by which the revelation of Limit, determination, finality, in the Tetractys, as the experience of *Θωρα*, vision, itself finds its place in a 'cosmic' order articulated in that vision - that this circuit is reflected in the 'frame' of these words, this book, as the circuit of terms in which it is here inscribed. It is suggested that there is something like a 'continued proportion' between the pythagorean mystery (with the spatio-temporal frame which it shares with me, embodied writer, and you, embodied reader), the mirroring of that 'outside' and this 'inside' which frames the way that this works as a book, and the inscription here, in these terms, of that mystery.

In this sense I might claim that the continued proportion, a certain reciprocity of the mystery and its description, embodies a certain ... justice. That through this mirroring of inside and outside of this book 'outside' the book, one might 'rise' to the theory, the vision, of a 'Kosmos' of which my inscription of that term, and its part in the pythagorean mystery on this same Earth, are two fairly 'symmetric' expressions. That it is the same Kosmos ( quite as much as this is the same Earth) in virtue of the analogy between its 'marking' or remarking then and here, and the place of such analogy in either expression of Kosmos. That it is the same principle which expresses itself in pythagorean Limit, and a THIS which expresses itself at the close of the Introduction, the same principle which distinguishes between these two self-expressions, in distinguishing itself from the mark or marks by which or in which it expresses itself in the two different situations. The principle of Actuality which in this frames the story or History of its earthly inscription in the logical closure of Reflection or 'Theory'.

But even granted that this ..odd.. symmetry of beginning and end of this story, of the activity of Reflection for which it may be said in an odd way to 'account', even granted that it should in an odd way partake of the 'pythagorean' figure of Justice... even given that my reflection or transposition of that figure here is 'just', 'true' in some sense... then what?

.. And anyway, what is to guarantee that such 'Justice' really is Justice? What relation does that circular argument bear to truth, to the Truth? It's all very well for pythagoreans to believe in this 'Justice', and act accordingly.. but that's just what makes them pythagoreans. But surely if the argument really works in general, it must convince everyone, not just pythagoreans? Surely there's a certain justice, paradoxically, in the overthrow of their rather 'one-sided' view of the Law of Croton by the uninitiated 'many', *ἡ πολλοί*? We might imagine the masses complaining: 'That's your Justice, your Truth; it works for you - but what about us?' And to all pythagorean reasons, why should they not reply simply, 'SO WHAT?'?

The story goes that the masses were stirred up by a nasty fellow, Cylon, who'd been refused admission to the mystery; that this

demagogue manipulated the 'economy' of the interaction of the governing pythagorean circle and its 'economic base', in order to secure for himself the government of the City, and so the power to further prosecute the unlimited economy of unbridled self-interest. Whatever the precise details of the 'breaking of the pythagorean circle', we may at least be sure that it partook of the subordination of the mystery to the earthly economy of the City-State.

What is to be made of this odd implication of 'theory' in a 'real' earthly economy? And just how does it relate, if at all, to Aristotle's economy of reflection, and his inability to step into the circle of pythagorean 'theory'? And how am I to fit all the differences between the closed circuit of  $\Theta\omega\mu\lambda\alpha$  as identified here and all the different aspects of 'pythagorean' activity that appear in the subsequent tradition, into the 'economy' of an historical narrative, a credible account? So far I have managed only a very odd sort of coherence. .. The fixing of a very singular 'missing point' of 'Actuality' outside a circular configuration of terms in which I have here tried to inscribe the pythagorean mystery, with the suggestion that the same 'missing point' can be found at the centre of the pythagorean mystery long ago, in its inscription here, and in the articulation, in-between, as a tradition or history of Reflection, of its marking in successive ( or sometimes parallel) sets of terms.

These questions are all posed by the same closed circuit of  $\Theta\omega\mu\lambda\alpha$ . They amount, in a way, to sort of complementary open-ness - to  $\Theta\omega\mu\lambda\alpha$  as a question. And as the opening question of the narration of Theory that follows - as the 'closure' of this book amounts to the opening and guiding question of the book as a whole.

In relation to the 'fact' of the pythagorean mystery, in its independence of its reflection here, there is the question of the place of this circle in the activities and conceptions of the different individual initiates. The closed circuit traced so symmetrically above, in which the entry into  $\Theta\omega\mu\lambda\alpha$  corresponds to the recognition of the place of that vision in the Kosmos revealed by it, might be said to consti-

tute the primary closure of the mystery, within which its various details, and relations to what is left 'open', may be articulated. It might be said to constitute, as it were, the frame in which was articulated the 'other' Language of the mystery, that other use of the greek of the initiate, which outside the mystery was .. Silence. Yet I cannot claim that there was any term in the mystery corresponding to such a definite conception of *Θεωρία* ... only that such a principle of closure was operative in the pythagorean group, that such is the transposition of the same actuality of Kosmos from its expression in that closure of *Θεωρία* at Croton, into the frame of these words, at a 'point' outside that group. And I 66 claim that this transposition is itself defined simply in the terms developed from the initial questioning of the closure of this book.

In those terms this 'circular vision', *Θεωρία* as epiphany of Limit, marks the coincidence of two orders: the 'supernatural' economy of a mythical order, in which the 'heavenly' order found self-expression in particular stories of 'gods' and 'heroes', applicable to certain particular situations; and the 'natural' economy of accounting for a certain order of things in 'earthly' terms. The pythagorean mystery marks a convergence of these two elements, after their previous divergence - in the 'mysteries' and their identification of *ψυχή*, and the parallel economy of *φύσις* - from an earlier 'Theogony'. The significance of the meeting of these two 'sides' in *Θεωρία*, when the absence of a systematically closed and coherent economy of their complementarity (and of a corresponding mystery of their duality) is admitted, can only be further elaborated in terms of the story - or 'economy' - of such systematic articulation in the phase of 'theory' which leads from the pythagorean mystery down to the organisation of the athenian schools. It is suggested that this early phase of what I have called the 'Tradition' constitutes an integration of these two 'sides' which first meet in the pythagorean mystery, an integration which mirrors, structurally and historically, their development from an earlier theogony.

*Θεωρία* the 'philosophic' vision of Kosmos, was doubtless understood by different initiates in different ways. The difference of emphasis on the 'supernatural' and 'naturalistic' sides, for example, seem later to have developed into a split in the school. One of Aristotle's students, the musical theorist Aristoxenus who knew the last gen-

eration of the initial pythagorean movement (or at least its last representatives in Greece proper) tries (as one might well enough expect from an aristotelian) to show that the 'supernatural' elements amount to a perversion of an initially 'naturalistic' theory. He goes so far as to claim that beans were the Founder's favourite food.\*

Beans? what has that to do with the matter?

Against the weight of otherwise unanimous testimony, Aristoxenus insists that this most famous of the *σύμφορα*, 'tokens' of pythagorean life, was a superstitious accretion. But the pythagorean mystery cannot properly be abstracted from the closed circuits of 'symbolic' relations - by which for example beans are associated one way or another with the 'lower' functions of the body - which have no definite place in some 'scientific' economy of the whole. The two 'sides' of the symbols (like that prohibiting the eating of beans) themselves partake of the character of the 'closed language' of the mystery. This 'mystical' use of language must be taken as a dynamic frame of the activities of the group. Its use, it must be remembered, was restricted to the unwritten dialogue of particular situations, and the mystery cannot be properly abstracted from its particular contexts - least of all from the embodiment of its closed circuit in the city-state, in the interactions of the individual initiates with outsiders, and the changing frame of daily activity in which the cosmic vision found application. *Θεωρεῖται* itself must have been understood by different 'stories' in different situations. What is crucial in this context is the altogether general aspect of this meeting of cosmic economy and a particular group in (precisely) such particular situations, with their irreducible elements of the circular reasonings of superstition. It is the tension between these two sides of the mystery, whose mirroring is represented here in the closed circuit of *Θεωρεῖται*, which marks it as the (missing) point of transition into the narrative of Reflection.

This radical character of the mystery, as passage into the logical economy of Reflection is paralleled in the contemporary fragments that remain to us from the Discourse of Heraclitus - Heraclitus the Critic who, far from being involved in the government of Ephesus, on that ionian coast Pythagoras had left for Greater Greece, resigned to

his brother the hereditary kingship, and eventually forsook the company of men to live beyond the pale of the city, outside that group. And, for no-one in particular he composed a discourse which (it is said) he deposited in the temple of Artemis. This λόγος, discourse, is - insofar as it is 'about' anything at all - about that principle of self-expression marked in the logical closure of discourse, λόγος, itself, as Λόγος, 'Word'. It appears in the physical order as that Fire of which I have already spoken, the recognition of whose true nature, as one-sided expression of that same principle of self-expression which first expresses itself in the distinction of symmetrical Word and Fire in the poetic frame, is that 'vision' that Heraclitus (sometimes) calls (τὸ) σοφόν, Wisdom - either as something which a man may have, or something that may possess a man ... depending upon which way one looks at it..

There are many parallels between the traditional discourses on this Word, and those on Kosmos. The main difficulty is that the self-expression of Λόγος in Heraclitus' λόγος in which the former inscribes itself as 'Word', 'Fire', and in many other aspects, involves the organisation by this 'Word', as by a point outside the closed figures of language (from syntax through genre to discourse itself), of the various elements or aspects of the discourse itself. Such self-expression cannot - in principle - be definitively conceived or comprehended in some closed domain of discourse: only do we identify it when we allow it to express itself as it organises the symmetry and distinction of Heraclitus' discourse and our own...

For what remains to us in the fragments? We do not even know that they are fragments of a 'book' in the sense of a connected or continuous discourse, As we have them they amount to a 'mystery' (a sort of open secret..) in which Self-expression, Actuality - or whatever term seems right at the time - actually expresses itself in the distinction of two sides of language, of which it is 'the one that likes to hide'\*. ... Of the two sides of language, discourse, and of the two sides of Discourse and Fire... and of the two sides of Fire (the cold fire or dark light, the 'daynight'\*\*, in whose economy

πῦρ ὅς τε ἀνταλλάσσει πάντα καὶ πᾶν ἀπάντων ὕψιστος χρυσοῦ  
 χρυσοῦ καὶ χρυμάτων χρυσοῦ

But things are exchanged for Fire, and Fire for everything, as all goods for gold, and gold for all goods\*\*\*

.. and the things in which, for a time, it is hidden).

- A discourse about the two sides of that discourse: with as central theme, focus, the distinguishing principle which expresses itself in the unity or coherence of one side of that discourse. The principle which marks itself as what distinguishes between itself and its mark:

ἐν τῷ σοφῷ μόνον λέγεσθαι οὐκ ἴθιαι καὶ  
ἴθιαι ζυγῶς ὄνομα (1)

How translate these words? Their syntax allows a bewildering variety of transpositions into the English of these words. Could I find for each element in the transposition/<sup>another fragment</sup> which expresses the 'truth', the 'logic', of that elementary transposition? And then, perhaps the same in turn for each of those fragments, until the interpretation comes full-circle as Heraclitus' discourse itself? Is that, perhaps indicated in the fragment;

οὐκ ἔμοῦ ἀλλὰ τῷ λόγῳ ἀκούσαντες ἐμολογῶ  
σοφῶς ἴστω ἐν πάντι εἰδέναι.

Listening not to me, but to the Word... (2)

..We partake of that one principle of distinction which articulates symmetric opposites as in Heraclitus' discourse, and which, as discernment, is Wisdom, in all things homologous, harmonising contrary aspects. - Full circle, and in that symmetry expressing itself as what must distinguish two aspects of one point, in order to mark itself in their coincidence in the finality of the circle..

ζυγῶν ἄρχῃ καὶ πέρας ἐπὶ κύκλῳ περιφερείας (3)

But one can cut the circle, enter into the Λόγος, at so many points: ἐν, σοφῶν, ζυγῶν ... and just which point is which depends upon the knot is cut. In the circle of Λόγος, each 'point', each indication, is one and many; the mark, the sign is one, the principle, the finality is many - and one principle appears in distinguishing itself from the play of the mark. One is many, and many one. Self-expression marks itself in the question of the open syntax. If we fix one point, one interpretation, say, of that fragment above - ἐν τῷ σοφῶν ... and mark the transpositions of its elements into this

1: Fr 32    2: Fr 50    3: Fr 103 - How, as in (1), with the accidentals  
(.hell ...)



text by associating these with transpositions, interpretations, of other fragments, until we come full-circle in a fragment which marks this circle, we quickly see that, in the reciprocal open-ness of the component fragments, we might have traced other systems, other discourses, other closures. There are many interpretations, many discourses in which to inscribe 'what Heraclitus means', his point.. but the point, surely, is - as Heraclitus tells us - not to listen to the 'me', and look for opinions, but rather to what, as One Wisdom, the wisdom of the one principle which articulates dissenting opinions, at once unites and distinguishes all these aspects of itself, and is most itself in that:

τῷ λόγῳ δ' ἑόντος, ξυνοῦ ζήτουσιν οἱ πολλοὶ ὡς  
ἰδίων ἔχοντες φρόνησιν (2)

The discourse has a life, an actuality, of its own, which discourses with my 'me'<sup>(2)</sup>, in the dramatic circle in whose articulation, *συνταξις*, in whose very syntax, I discover myself inescapably embroiled. The configuration of the marks, the words, is at once closed, 'turning back on itself'<sup>(3)</sup>, and open - a question. And a mystery, in which the government of *κόσμος* (4) dramatically expresses itself in the coordination of text and context... like the pythian god of harmony,

ὁ ἀνάξ θεὸς τῷ μαντικῷ ἔσται τὸ ἐν Δελφοῖς (5)

The Lord of the Oracle, he of Delphi

(or: The Lord whose oracle is in Delphi) . .

- who, as in this delphic formula itself,

οὔτε λέγει οὔτε κρύπτει ἀλλὰ σημαίνει (5)

neither speaks, nor conceals, but indicates

(or: points; or: gives a sign, a token)

- a sign, a mark, like the famous 'E' in his temple at Delphi (6) in the dynamic of whose multiple aspect the god of knowledge expresses himself - not as a response to some particular situation or question, but soliciting Inquiry itself, like *γὰρ θεὸς σεαυτὸν*, inscribed

1: Fr2    2: Fr101    3: Fr51    4: Frs30,124    5: Fr93    6: Plutarch, op. cit.

on the wall of the same temple (1).

Wisdom discerns itself, distinguishes itself as the principle of distinction and discernment itself. Wisdom is self-knowledge, and knows itself as such; the wise man knows that this wisdom does not belong to himself<sup>(1)</sup>, but to itself, and this is his wisdom; it is no 'private understanding', but what is 'common', through which all things communicate<sup>(2)</sup>. It speaks to our private understanding, 'disagreeing with itself, it agrees with itself'!

ὁ συνῆσιν ὅπως διαφερόμενον ἑωτῆ ὁμολογεῖ  
παλίντροπος ἡρμονίᾳ ὁμοσπει ὅξω καὶ λόγῳ. (3)

- Distinction is most itself when distinguishing itself; distancing itself, it embodies the distinction which it is - the difference and the term distinguished as one side of the difference - its 'identity' - have the same λόγος; ὁμολογεῖν: they are homologous, they 'agree' - agree to differ.

This differing expresses itself ... in the difference between its unity as principle, and the plurality of the marks by which its difference from the marks of distinction is expressed. It strives to express itself in the Strife, Ἔρις, that is the dynamic of this differentiation - and in this it remains the same, at one with itself<sup>(3)</sup>, for its identity, its 'definition', λόγος, is to differentiate itself. The symmetry of opposite marks, is one side of this distinction, made by being marked off ( ) from this symmetry, as its 'other' side, as 'absent', 'hidden', as what is 'behind' the visible:

ἡρμονίᾳ ἀφανῆς φανερῆς κρείττω

(4)

Again, I will not transpose this fragment in other terms; if the discourse expresses the unmarked, hidden, side, in the play of distinctions, is not each fragment an invitation to enter into the Play that is the dramatic interaction of the two sides of Everything, Visible and Invisible, in the invisible unity which 'contains' their difference?

1: Plutarch, op cit, 1,2      2a: Fr 113      3b: Fr 84a  
2: Fr 78 | 3: Fr 51 | 4: Fr 54

Ja. v ἰδὲμος

The invisible distinction of Distinction itself, and any particular distinction from the order of particular distinctions, in which this Distinction expresses itself, partakes of the figure, already discussed, of the 'logical' circle by which the physical difference of two marks is used to mark the difference between - or rather, the distinction of - the logical and physical orders of the mark. That circle is, as has been noted, a minimal expression of the 'logical' order itself. But this circle is 'logically' symmetric, indistinguishable (except by an endless widening of the same circle, amounting to the extension or prosecution of the logical order<sup>(1)</sup>) from the 'physical' order in which the difference of the logical distinction and the physical difference which embodies it must somehow be embodied or marked: the two terms 'used' to distinguish logical and physical orders must be supposed 'logically' indifferent....

φύσις κρείττεσθα διὰ δὲ (1)

φυχῆς αἰετα ἰὺν ἀν ἂν ἱξῶρα εἰ πᾶσαν  
ἐκαστομένους ὁδὸν ὅτω παθὼν λόγου ἔχει. (2)

The actuality of the distinction and difference of these two orders belongs not to the 'visible' or poetic order of the marks in which their symmetry, their oppositions, are articulated, but rather to an 'invisible' (which is as much to say 'other') order which, in its marking (as 'other', 'invisible', 'heavenly', 'divine'.. or whatever) is - in the configurations of its marking, its opposition to the mark, quite 'symmetric' with the order of the mark: it doubles the 'everyday language' and everyday events of the 'visible' order. .. So that, by analogy, we call it *Λόγος*, in opposition to the everyday order as 'physical' - or we call it *Πῶρ*, in opposition to everyday language, and its apparent definitions of things as many separate identities<sup>(3)</sup> But however far we go, we cannot outstrip the recuperation of the marking of the opposition of Mark and another order - we cannot 'contain' or 'comprehend' the 'nameless' in the order of the mark<sup>(4)</sup>. We can only insist that it must be allowed to express itself<sup>(5)</sup> by determining the closure, the limit, of the discourse on the symmetry and distinction of IT and the order of symmetry which cannot actually determine any such limit, the closure of the expression of the symmetry of the two orders.

1: Fr123    2: Fr45    3: Fr17    4: Fr(1)(2) above    5: Fr 18  
0: Fr 115

Thus the self-expression of this 'invisible' Word is first seen or invoked at the interface of the closed configuration of marks (in which it further distinguishes itself from the marks in which it then expresses itself) and their context, the 'scene' of self-expression: it appears as the 'Truth' which distinguishes itself as the symmetry of text and context, word and thing. As the frame of this symmetry or mirroring, it is Law or Justice, in which *Λόγος* governs the economy of Fire (1).

Ἡλῖος οὐχ ὑπερβήσεται μέτρα εἰ δὲ μή, Ἐρῶνι,  
μὴ Δίκης ἰακόνουρα ἐξυγίῃσιν. (2)

The scene, the context of the book, is framed in such cosmic articulation of Word and Fire - but not, as with the pythagoreans, in a narrative which begins with the entry into the mystery whose place in Kosmos concludes the narrative. There is indeed a recurrence of *Λόγος* analogous to the circle of *Θεωρία*, but in Heraclitus' circle there is no beginning or end. A particular break in the circle, corresponding to a relation of some term in the discourse to something outside, is simply a passing moment in the circular drama of self-expression in which Heraclitus 'searches for himself';

κίον παῖς ἴσα πάλῃων, αἰσῶν παῖδος ἢ βασιλῆος (3)

Seen from above, Life is a game.. the direction it appears to have from time to time, is like the direction, the 'kingship' that a child takes on in *παιδιά*. Even kings do not stand outside the game to direct it, but they themselves are only playing, like children, at being kings (4). Heraclitus sets down the rules of the game. There is a simple proportion between the two sides of the constitution of the City, <sup>of the</sup> and the two sides, the government and the economy, of the constitution of the Kosmos, which <sup>whole</sup> the former constitution reflects in one of its sides - the visible, in which the multiplicity of laws or constitutions <sup>(5)</sup> reflect the One Justice of cosmic Law (6) But the governors of cities, on this proportion or analogy, are in Kosmos what children are in their cities (7); most men when awake, are asleep, on this analogy (8). Immortal gods are in the invisible whole what men are in the city, of rather God is, since gods are aspects of what is One, Wise, the unity of the two sides of things, which is the other side (9). In making God

1: Frs 30,31 2: Fr94; cf Fr100 3: Fr52 4: cf Fr70 5: Fr44 6: Fr114  
7: cf Fr121 8: Frs73,89; cf Fr34 9: Fr67

a reflection of themselves (1), men should see themselves as children (2), or apes (3). In this relation or proportion (λόγος) of the two 'sides' of Λόγος, of which one side - One, Truth - is the unity of the two sides, there cannot be said to be 'identity' on the other side (where the two sides seem separate identities - or pluralities) but only the play of λόγα (run through, as it were, by the ever-moving but constant λόγος of outward Difference). <sup>(3a)</sup> To 'river' or 'Sun' one should not attribute a separate fixed identity 'behind' their λόγα. There is only one common Identity, one common Λόγος, which we can (if we understand what we are saying (4)) sometimes call Fire, 'behind' all things - Wisdom, the 'thunderbolt' (5) the lightning, dry fire (6), that directs all through all (7). So that one cannot enter twice into the 'same' river, as if 'it' were itself what is 'behind' its Λόγος (8). Indeed, properly speaking, we do not even enter once, since we ourselves have no separate identity (9). The sun is (a) new (one) each day (10), and is the size of a foot (11). And since there is only One (thing) behind separate λόγα, it is, in a way, always the same 'day'.. (12).

It is from this two-sided unity or Kosmos that we come at birth into this visible side in which Heraclitus deposited his book (according to one λόγος, one story) in the temple of Artemis, Diana of the Ephesiāns, and I am now writing about it just as part of his discourse was a standing-outside and discernment of the λόγα of his Past, from the point of view of discernment itself:

σοφῶν λόγους ἕκουσα οὐδὲν ἀφικνεῖται εἰς τὸ πρῶτον (13)  
 ὅσοι γινώσκουσιν ὅτι σοφῶν ἔστι πρῶτον κεραιρέμενοι.

The most discerning precursor <sup>Heraclitus finds</sup> is Hesiod: but he didn't even understand his starting-point, for Day and Night are One <sup>Heraclitus</sup> (14), <sup>stands</sup> outside <sup>or apart from</sup> the previous thinkers of Empeae- in whom he includes Pythagoras (14a) - as they go round and round in their basic mistake of trying to comprehend the Word in distinctions (15). Heraclitus allows the Word to express itself as he marks his distance from the circuits of previous attempts to express truth, <sup>and from</sup> the 'many' who think they have a separate knowledge, and a separate identity. The Λόγος expresses itself by marking out Heraclitus; if people listen to the Λόγος, and

- 1: Fr5   2: Fr79   3: Fr83   4: Fr19   5: Fr64   6: Fr118   7: Fr41   8: Fr91
- 9: Fr49a   10: Fr6   11: Fr3   12: Fr106   13: Fr108   14: Fr57   14a: Fr 129
- 15: Fr40

3a: in this relation of also to Pythagoras as 'psychology' related to his system etc.

not to what they take for Heraclitus' opinions, they will enter into the play or drama of Life and Death, where immortality dies to become what we call alive, and our deaths are returns from this one-sided mortality to Life, properly speaking (1). Heraclitus' production of a book, embodying the symmetry of λόγος and Λόγος, even in the openness of its syntax, the multiplicity of versions, readings - this marks in its 'cosmic' context the same simple self-expression of what marks itself simply as distinguishing itself from the order of the mark, that I have already remarked in the pythagorean mystery. The pythagoreans make their mark, as it were, 'in' the City; Heraclitus marks a critical distance, 'beyond the pale' of the City. We might say of Croton and Ephesus: 'It is the same City, and not the same City'.

...Just as we might say that the circle of pythagorean Θεωρία is the circle embodied in Heraclitus' book: crossing into the circle at Croton or at Ephesus, one enters upon the same stage of Kosmos, into the same Drama - but in two different 'presentations'. The same stage of the City, reflecting, on the side of plurality, of difference, that same frame of cosmic Justice, in which the frame is itself mirrored in one of its 'sides' as earthly laws. The same frame in which the relations between its two 'sides', human and divine, earthly and heavenly, are governed in dramatic coherence.

If Croton is the City, one enters into the mystery of this mirroring by entering into the pythagorean language from the Silence outside - into the 'other side' of greek, into a language, a discourse, a Λόγος, whose syntax is inscribed in the circle of Θεωρία, a circle whose closure is marked by the Tetractys, whose beginning and end in Θεωρία corresponds to Croton as point of entry. The beginning and end coming full-circle in the narrative frame of a Kosmos regulating the unwritten interaction of pythagoreans in dramatically developing situations, unspecified in the general frame. If Ephesus is the City, the entry into the language of some particular group, at some definite point in the dramatic development of their situation - but rather by entering into converse, into 'dialogue' in which Λόγος interacts with the particular λόγος that is one reading or aspect of a book, a fixed configuration of marks, rather than the pythagorean syntax of the mark-in-general, marked in the frame of the open discourse it governs, as Tetractys.

In a way, the circle of Heraclitus' discourse is (exactly) what is missing 'between' the pythagorean Tetractys, and the general narrative frame of Kosmos, as intermediary. It corresponds to the openness in the pythagorean mystery of the particular circuit of  $\theta\omega\rho\acute{\alpha}$  in the particular situations in which particular 'mathematical' symmetries were related to particular details of Kosmos, in a particular experience of  $\theta\omega\rho\acute{\alpha}$ . It is precisely because the particular situations of the circle of  $\theta\omega\rho\acute{\alpha}$  are lost to us (like the unwritten speech which might in a particular case have embodied the two poles of mathematical point and its cosmic frame applied in some story, some passing account or view of a pythagorean's situation in some interaction or act-  
to with pythagoreans or others), that I am forced to describe the two poles of  $\theta\omega\rho\acute{\alpha}$ , point and Kosmos, in terms, and in a systematic symmetry, foreign to the mystery. And it is the same fundamental absence to us of the application of, or experience of, the mystery, which is reflected in the recognition that one should not look for any exhaustively systematic narrative of cosmogony, or of the precise system of numerical configuration, as a missing esoteric 'theory', behind pythagorean silence. One can only properly insist upon the fundamental importance of such systematisation as one of two main directions of the extended activity of the group.

At the same time, one should not (surely?) try to abstract from the fixed configuration of Heraclitus' words (or of a presumptive reconstruction of such a closed group of terms) some 'heraclitean' version of the exact reference or meaning of each mark or word (corresponding in its simplicity to a pythagorean point), or any general frame of a Kosmos that could be embodied or transposed in the sequential narrative of a cosmogony or 'cosmology' in the sense that might be attached to the narrative principle of Kosmos that was undoubtedly a fundamental element in the pythagorean mystery. Such a 'point' and such a 'cosmology' are as radically absent from the configuration of fragments that have come down thus far through the Tradition, as any contemporary pythagorean writing. (The Tradition, indeed, is fairly emphatic - obvious later forgeries aside - that there were no pythagorean writings - even within the school - up to the time of Philolaus).

I suggest that to try to fix the 'point' of any one fragment in the heraclitean remains - or indeed of most words in each fragment - is to miss the 'missing' point of their circular configuration: the

'point' outside any of the particular points where one might cut their circle to produce the beginning and end of one reading, one discourse of the *Λόγος*. The point that marks itself in the dynamic of interpretation, in the ceaseless opening and closing of the circle ( of 'speaking' in a reading, and listening - in return - to the writing, to (the) *Λόγος* ) as the finality which is the only principle ('outside the circle) which distinguishes 'beginning' and 'end' at some point.

'Syntax': I have suggested that the 'syntax', the *σύνταξις*, articulation, coordination, of (the) elements of the pythagorean mystery might be considered inscribed in the closed circuit of *Θεωρία* which I now ask you to see reflected in the closure of Heraclitus' book. But I have spoken of the open 'syntax' of that book in a more.. exact sense. Now I suggest that that 'exact' use of 'syntax', and its application to the words and their constituents in the fragments is an 'anachronism'. For 'syntax', a presumed coordination of all these verbal elements, significant marks, in the systematic closure of a 'logical' reconstruction of language (or, rather, of heraclitean greek, heraclitean ionic) is itself a discourse on Discourse, a very special *Λόγος*, associated with the (aristotelian) 'logical' economy of Kosmos of which I have already had occasion to briefly reflect, and which must occupy us very soon. Just as there is no place for a 'logical' narrative of pythagorean cosmology in Aristotle's frame, there is no place, either, for heraclitean 'syntax'. Just as Aristotle's vision of cosmic economy comes through the intermediate frame of Philolaus' publication of a pythagorean 'system', so does his 'logic' come through the intermediate frame of 'sophistic' reflections on (and discourses of) the elements of language (and their economy or system), one 'side' of which are derived directly from Heraclitus. These intermediate frames were contemporary (in mainland Greece). It is through them that we must pass to the athenian schools, and thence to the 'Incarnation of the Word (*Λόγος*)', and on to these words, until they themselves come full-circle, and partake in this same Word.

... The circle, the closed frame of these words - as question, as mystery: a point of entry into that same Drama, this same Drama, of Kosmos; a point of entry separate in time from Heraclitus' publication of the Word, and the outward configuration of the pythagorean mystery, as they themselves are separated, not in time, but standing apart across



greek seas, Water. So that as Heraclitus echos the mystery of Croton, these words echo the sibylline Word...

... the Sibyl, through mad lips - says Heraclitus - crying things grave, unadorned, unperfumed, reaches across a thousand years in her voice, through the God.. (1)

.... a thousand years... and still the same day.. the same night.. the same daynight, the same time, the same converse or conversion of God and men, the same dialogue of One and many, Same and different; the same words and not the same, communicating in a common difference. All of us here, thrown onto the same stage, mindlessly wanting One Thing behind many.. entering in the search into the circle of words, the logical circle of Thought drawn out and drawn on by questions, closed again and again, only to be opened up by new questions; drawn into Heraclitus' words, the same over a thousand years, then further fragmented for a thousand years more..

.. and unable to find anything fixed behind them... then finding this absence itself marked in the words, replying almost to our entry into the fragments, like the end of the circle which corresponds to the point where, entering, we begin. Then a dialogue of two sides of the words, framed as by a syntax that mirrors the order of our further questioning in the simple fact of the words and their unthinkable arrangement, their open grammar which cannot be contained or comprehended in that logical circuit of Thought in which the actuality of difference is abstracted from, as when a physical difference might be supposed 'used' to mark the difference of physical difference and the logical distinction thus made.

.. made.. for this act, actuality of distinction finds itself already marked as Λόγος .. the end, finality, already behind us as we enter into the circle of words. And in the articulation of our discourse with this Discourse in the small circuit of its self-expression, the point of our self-assertion, reading - as our part in the dialogue - is marked off, and no longer extends back indefinitely to an imaginary fixed point, logical identity, of 'my' self.... just as the end of our inquiry has been marked off in a few words, within reach, not at the unreachable distance of some imaginary identity behind a word that would mirror the fixed self where the logical circle has contracted to a point.

(1) Plutarch, The Oracles at Delphi.., 6. 2: Fr 20, 78

Rather do we find ourselves in a simple dramatic interaction, framed in the simple closure of the circuit of words in which, as logically the most radical question, the Word first expresses itself... just as in the physically radical question of the 'closure' of the thing, that first expresses itself, which Heraclitus has marked as Fire. 'Heraclitus': these orders coincide in such a name, an 'address'... and this simple form of address, this mark of personality corresponding in imagination at once with that contraction of the logical circle to an identity, and the contraction of the physical order to a body, mirrors a simple Actuality which 'frames' Kosmos...

ἐν τῷ σοφῶν μόνον λήγεσθαι οὐκ ἐθέλει καὶ  
ἐθέλει ζῆνός τε οὐρα. (1)

... Kosmos, as the dramatic frame of the Actuality in which the distinction of a World from Nothing is mirrored in the poetic frame of an action (or interaction) of which the logical closure of a set of words, an account, is one side, 'the facts' the other, each endlessly mirroring the other. If, corresponding to a 'life' articulated between the twin poles of a self and its embodiment, as a dramatic configuration, an activity in the elementary frame of a group, we ask what is the articulating principle, 'governing' our life, 'Heraclitus' replies

ἦθος ἀνθρώπων δαίμων (2)

The actuality of our life, its articulation as an actuality, partakes of that plurality which is the reflection of human multiplicity in God<sup>(3)</sup>, in the 'other' invisible side of the 'visible', which is the unity of the two 'sides'<sup>(4)</sup>. It is justice as the frame of Kosmos, or rather as the mirroring of these two sides<sup>(5)</sup>, which governs their interaction<sup>(6)</sup>, as laws govern interactions in the City; and it is the just view as Truth which governs the interaction of accounts presented as true, or considered true, and Truth: thus does the drama of the self-revelation of Λόγος enter into the wider drama of a sort of Interactuality.

σοφροῦν ἀρετὴ μέγιστη καὶ σοφίη ἀληθεία  
λέγου καὶ πάντων κατὰ φύσιν ἑπαίοντα (7)

1: Fr32 2: Fr119 3: cf Fr79 4: Fr88 5: Frs24,25,28 6: cf Fr94  
7: FB112; cf Frs73,114

. Δράμα , drama: at once a middle term between the discourse of Heraclitus (the dialogue between whose two sides mirrors the interaction of Visible and Invisible as two sides of Kosmos) and the mystery of the pythagoreans (as reflecting the invisible government of Kosmos in that of the City), and the common frame of which the activity of the pythagorean circle (into which one enters in θεωρία) and the written words of Heraclitus present two complementary aspects.

Drama: the actuality of Kosmos reflected in the City as Athens, midway between ionian Ephesus and italian Croton. Inscribed in another circle, another θεωρία , another λόγος , another vision, another speech, another entry into that same 'syntax' whose articulation in the primary circuits of θεωρία and λόγος I have already tried to describe. And according to Heraclitus' analogy of Visible and Invisible I call 'drama' that interaction of these two sides of Kosmos which is visibly reflected in the constitution of the City (its articulation within autonomy), and reflected in turn within the City as θεαία , drama, or λόγος , just as the City happens to be Croton, Athens or Ephesus. Kosmos as θεωρητόν , in which pythagoreans and Heraclitus play their complementary parts. And in this theatrical or dramatic constitution of Kosmos, we have already seen the part played by οἱ πολλοί , the many, as Critic, and seen the Critic as Heraclitus: in the extended drama which is to the City, as the City to imaginary scene, the audience also takes part in the Action.

In this extended drama we also find ourselves. 'Drama': thus have I already framed our interaction as writer and reader. ... But why should you play your part in the interaction in such terms - any more than the crotoniate multitude should be expected to submit to pythagorean government, or Ephesians to understand Heraclitus on - or in - his terms?

I must admit to something like presumption, indeed, in addressing you thus directly, in the first place. Traditional propriety requires that reflection be addressed to its own image, to that 'theoretical' identity of the 'I' to which the closure of the logical order contracts, and about which reflection is organised. - To an I which alone decides, in that pure autonomy of choice which is its mark, whether it is - in fact - reading this at all. I, actually writing, and openly admitting my distance from such a centre of coherence, such perfect organisation of my thoughts about an identical focus, have presumed to address

you who must be - in fact - reading, for the question of the propriety of this address to have any significance for you. In such a simple circularity, in which I address only the configuration of people scattered through the times and places of my future as I write, each of us enters into the simple figure of 'drama' exemplified in the discussion of Heraclitus'  $\Lambda\gamma\omicron\varsigma$  as dialogue of  $\Lambda\gamma\omicron\varsigma$  and reader - and of  $\Lambda\omicron\gamma\omicron\varsigma$  and writer. In this figure we are cut off from the formal identity of an 'I' that might or might not be reading or writing as we read or write, and enter into the parts of reader and writer, and into these words as frame of interaction, as an 'actor' might enter upon the stage as, say, 'Pythagoras' or 'Heraclitus' or 'The Philosopher'. And in entering into the drama of reading and writing, we see (do we not?) that the 'I' to which reflection thinks to contract, the Critic standing outside all action, all self-assertion, is simply one 'part' among many that we may play, like Heraclitus' child who plays at being king, or the king who plays at governing.

I wish (and will try) to presume no more upon your sympathy than in this - that I may presume that 'you' are reading. If you are not, then it is nothing to you; if you are, how can it be denied? I admit the impropriety - this breaking of the rules of Reflection - but insist that I mean no harm by it.       

The frame in which we are thus engaged - 'the drama of Reflection' - extends from the time of the first pythagoreans, of Heraclitus, and the first organisation of athenian drama - in 'the Past' - up to our arrival, at the close of Part Three, at my writing this book, and then, through the Conclusion or Close of the book into what is now my Future and your Present.

The circuit thus traced - out from the beginning of the book, to return to that point at the close - partakes of the figure of Heraclitus circle - of the figure of  $\Lambda\gamma\omicron\varsigma$ , and of  $\Theta\epsilon\omega\rho\acute{\iota}\alpha$ . These lead, in the narrative into which they are the entry, through other expressions of Actuality, and so, at last, into the Actuality which is at once in, and outside, this circle of its thinking, as Heraclitus'  $\Lambda\gamma\omicron\varsigma$  is at once in, and outside the circuit of its readings'.

The presumption by which I would engage you, as reading, in the drama of Kosmos, exactly corresponds to the pythagorean and heraclitean presumption by which we enter into the frame of this drama. All partake of that simple figure - a 'circle' - by which, for example, the 'logical' order of terms is closed upon itself (or 'recurs') in the 'use' of a 'physical' difference to mark the distinction of logical and physical orders. The question then arises of the logical symmetry of the two terms in this supposed distinction: the 'psychical' actuality of making the difference, expressing itself in the logical 'circle' of the supposed distinction may in turn be marked in the configuration, in an attempt to 'logically' distinguish the two sides of the difference by which the initial distinction was supposed made. This third term is itself mirrored in an 'ontical' fourth term, in a fourfold symmetry analogous to the pythagorean figure of 'Justice', or to 'Open' and 'Closed' as themselves two sides of the distinction or difference of Open and Closed (these themselves elementary complementary terms, partaking at once of both 'logical' and 'physical' orders, ambiguously). In this configuration (then) I and the pythagoreans recognise the self-expression of another 'mystical' order which articulates this double symmetry of logical-physical and psychical-ontical (which latter the former 'reflects'). - An order in which psychical and ontical symmetrically partake, and which articulates these, and so the logical and physical orders which reflect them. This articulation expresses itself in distinguishing itself from the 'poetic' order of the mark (of 'finitary' configuration) in which this distinction is made: for although in terms of this configuration of marks these two 'orders' of mystical and poetic are indistinguishable symmetric configurations of mark (and thus simply two sides of the order of marking itself), yet this very symmetry cannot of itself determine its own expression. For that would allow us to determine which 'side' of the symmetrical configuration was the order of symmetry, and thus introduce a distinction which is 'by definition' outside the domain of symmetry. It would reveal the identity of a term which by definition has no fixed place, which indefinitely moves through all its inscriptions in the symmetric order of 'terms', outside their economy in principle - in the terms of that economy itself, which allows no 'circular' recurrence of the term for the 'outside' of that order, in the 'syntax' of that term in the order itself. Indeed it is just this 'circular' economy by which a term applies to a configuration in which it itself occurs, which amounts to the first 'formal' definition, the elementary 'syntax' of the 'actual infinity' of the 'mystical'

order, and which is reflected in the unity of four in the double symmetry of the pythagorean square.

This 'primary' or minimal formal reflection of the 'mystical' does not, as indeed has just been argued, 'determine' poetically some unquestionable 'mark' of what is thus 'outside' the finitary configurations of the poetic order: it only fixes the primary 'frame' in which 'mystical' self-expression can further define itself - without ever reaching complete inclusion or comprehension in any furthest or last extension. For no finitary configuration can actually determine the particular situation of its actual marking - and the particular situation of its expression is, as appears in the second 'recursion' of the 'mystical' order in the poetic, a radical component of the configuration of self-expression. IN the pythagorean mystery this component appears in *Θεωρία*, in Heraclitus' book in its character as book. Here it appears in the situation into which this book enters as a defining characteristic, and in which I as writer, and you as reader each play our part.

This 'situation' includes, in a characteristically 'recursive' fashion, the circuits of pythagorean *Θεωρία* and heraclitean *Λόγος*, as well as the contemporary athenian frame of that 'drama' which reflects the actuality of the situation as a whole - and in this reflects *Θεωρία* and *Λόγος* as two complementary sides of this dramatic frame.

Just as the 'syntax', the articulation, of early pythagorean terms or themes can (it is suggested) be inscribed (fitted one within another within another, and so on) within the radical closure or recurrence of the *Θεωρία* by which one enters into a Kosmos in which the place of this *Θεωρία* is first defined - and just as the 'syntax' of the Word can (it is suggested) be inscribed within the radical closure or circuit of a discourse on the two sides of that discourse - so I suggest one might discover the 'syntax' of the dramatic actuality in which both of these mysteries, and this writing and reading partake, organised in the circuit of the drama in which the book plays a part, and thus in a way defines.

In this way, this 'drama' in which we are involved as writing or reading, embodies the two aspects of *Λόγος* and *Θεωρία*. I play the

'initial' part of formally framing the action or interaction, marking out the frame of the drama, its formal closure; you as the configuration of readers then play the part of the Critic. This latter part is quite open, in the measure that my part, as I articulate my assertion in this symmetry or complementarity of our parts, is closed by the time you play your part or parts. Your part is in fact - as you are well aware - open to the extent of bringing into question the very actuality of any but a purely formal frame of interaction. I interact with this frame - I insist - as an actuality, however indefinite. You may quite properly question my sanity.

'I interact..' - as, for example, I as reader or critic interact with the  $\lambda\acute{o}\gamma\omicron\varsigma$  which expresses itself in Heraclitus' words, or with the silence that lies behind pythagorean terms, or with the ontical actuality of a typewriter... or with the actual possibility of your reading, with the Kosmos that expresses itself in the situation that can be in part defined in this book by this book's part in it. Since you may then interact with this 'Kosmos' (as I see it) which expresses itself in my dialogue here, we thus in a way 'communicate' (whatever further is to be made of it) in a way analogous to the way Heraclitus marks community in terms of  $\xi\acute{\nu}\omega\omega$  (1). As Heraclitus insists, the matter best explains itself...

(Enter Parmenides)

Into this scene, there now enters Parmenides, his chariot drawn by wise horses, his way shown by the daughters of the Sun (1).

This scene: the frame of this writing and reading as thus far reflected in these words. Two converse dimensions or orders (or directions in the same 'poetic' dimension (2)), 'logical' and 'physical', meeting at an initial point (where we find Heraclitus and the first generation of pythagoreans) in our Past, where there mirroring is marked in an historical Fact. Passing then, in a sequential inscription and re-inscription of this physical fact within an extended 'logical' circuit of 'theory', until the fact of such inscription itself comes into question in the frame of these words, and their writing, in a 'poetic' mirroring of their 'physical' and 'logical' orders (which thus reflects their initial mirroring in the 'physical' order at the start, at Croton and Ephesus). Passing then, in turn, to the 'logical' inscription of the meeting of these two orders in what is, in the writing, an open 'Future', at the point marked in the writing as 'you', the reader or readers. Physically the scene has been characterised in terms of an Earth constituting one 'side' of a Kosmos - its 'context' as it were - whose 'other side' is traditionally called 'Heaven' or 'the heavens'. 'Logically', the 'scene' is characterised by the terms corresponding to this 'physical' distinction, and to other distinctions inscribed within it, as the corresponding terms are inscribed within the primary closure of a 'logical space' reflected 'on Earth' in the various closures of discourse (books like this one, or Heraclitus', for example, or the verbal interaction of the early pythagoreans). The mirroring of two 'sides' of the Action, the Drama - 'heavenly' or invisible, and 'earthly' or visible - we have seen to be reflected, in the earthly side as the Law that governs the interaction of the two corresponding sides - the 'political' and the 'economic' - of the autonomous group that appears at the outset as the greek City or City-State. In this group, the autonomy of the individual actor in the Drama is reflected in the self-enclosure, the autonomy of the whole frame, 'Kosmos'. The direction of Kosmos, on this analogy, is called 'God', ruling through 'Justice' as cosmic law - as a king might rule a city.

1: Fr 1, beginning      2: cf. Heraclitus Fr



This frame or scene is itself reflected in the discourses with which the Action, the Drama of Reflection, opens. Indeed the principle terms in which the frame has been thus far characterised have themselves been borrowed from an initial 'theory' or 'account' (all the terms, that is, barring the 'drama' which has been taken as a sort of middle term, of which *θεωρημα* and *λογος* might themselves be considered as two complementary aspects or 'sides').

The 'point' at this stage is to reach, in the narrative of the logical determination of the conditions of logical determination, this point at which that conversion of the two orders of the narrative (the orders of logical text and physical context) itself comes into question: 'in' these words, precisely.

The most general character of the 'dynamic' which must direct that narrative has already been suggested: the way by which questions arise as what is (logically) 'open' in the situation of reader or critic in the context of a text which purports to abstract in its logical 'circuit' from its context, its 'outside' in which the reader finds himself or (rather unusually) herself. The reader may himself then enter actively into the 'drama of Reflection' by constructing (most typically in a written text or texts) a 'new' configuration in which the configuration of text (more usually texts) and context is once more inscribed in the logical circuit of his (or her) text.

This figure first appears as Parmenides enters in his chariot.

Appears from where?

From the city of Elea, not far from Croton in Greater Greece. And his appearance has the character of a crossing, a transition, out of the verbal intercourse of eleatic pythagoreans (1) - and out of the particular situations of such intercourse - and into the closed frame of a written and published poem, standing out against pythagorean silence: Sources given by Zeller, I, 580

ence, and echoing (just how directly is unclear (1)) the heraclitean Word.

The poem amounts to a dialogue. Not, as in Heraclitus, a dialogue between *Λόγος* and *λόγοι*, One and many - but rather an explicit dialogue between the writer and 'the goddess' who speaks to him in the dramatic frame of the poem. A frame which opens in the dramatisation of Parmenides' passage out of the pythagorean Kosmos, and which closes in the return to this starting-point transfigured. The circuit of the narrative thus contains, as aspects, both the figure of pythagorean *Θεωρία*, and that of heraclitean *Λόγος* - the latter, as has already been suggested, corresponding to what is in a sense the mirroring of the circle of a *Θεωρία* always rooted in the spoken intercourse of the pythagorean group, in the silence 'outside'.

A dialogue? .. well, almost: Parmenides' part is to 'write' his listening, organised about the minimal way that he addresses himself to the goddess. An 'interview', perhaps. Having entered into the account of his minimal participation in the drama, as attention, he enters into the goddess' discourse as into the simple closure or recurrence of Heraclitus' circle:

ἄπόθεν ἄρξομαι· ὅπου γὰρ πάλιν ἔξομαι κείθις  
 ξυγὼν δὲ μοί ἐστιν

It is the same to me wherever I begin - for I will come back there again

(2)<sup>1</sup>

This circuit, *Ἀληθεία ὠκυκλή*, well-rounded Truth (3), amounts<sup>to</sup> or rather embodies, the simple configuration of 'Mystery' traced out a few pages above. So do the 'circles' of *Θεωρία* and *Λόγος*. But the circuit of Parmenides' poem as a whole does not, as in those cases, simply coincide with the mystery. Rather does Parmenides integrate in the frame of his poem the two sides of his mystery, first narrating his passage into its closure, and subsequently his return to his starting point. (a sort of inversion of his entry, in which the mystery is no longer approached as something 'external' to the economy of Kosmos, but this is itself inscribed in the mystery.) The passage into the mystery corresponds to a discovery of distinction, Limit, 'behind' pythagorean Kosmos as heraclitean *Λόγος* is behind the play of *λόγοι*; the return to the point of entry involves the recurrence of this figure of distinction in the symmetry of the mark.

1: note..

2: Fr3

3: Fr1, l. 29

That is: Parmenides' poem begins at a point - his situation in a pythagorean Kosmos - 'outside' the circle of the mystery of self-expression: in the symmetry, as it were, of the mystery and economy of Kosmos. In relation to the pythagorean mystery we asked: 'Why should the masses of Croton understand their interaction with (their government by) pythagoreans on pythagorean terms (indeed how could they, since they were 'excluded' from the true understanding of those terms)?'. And one might ask: 'Why should the ephesians have striven to understand Heraclitus, so to understand that it was not Heraclitus, but the Word which was the true (subject and) object of their striving?' The choice between the two sides of each mystery, from a point 'outside', is in a fundamental sense arbitrary. This choice can itself only be understood once it has been made. The point 'outside' is, indeed, understood in each case as the locus of symmetry, in which the true discernment which alone distinguishes Distinction from Symmetry, from its marks, cannot be discerned. It is characteristic that, in Elea, 'Parmenides organised (*διδασκάζει*) his fatherland by excellent laws, so that the government yearly binds the citizens by an oath to abide by Parmenides' laws' (1), whereas Heraclitus is said to have resigned the hereditary kingship, and the pythagoreans at Croton to have been massacred in an uprising. In each case, their place in the City corresponds to their cosmic perspective: their part in the affairs of the City mirrors the part they play in a Kosmos (whose identification is itself one component of the 'part'), as the autonomy (*αὐτονομία*, self-determination) of the City mirrors its cosmic frame, organised by Justice.

Thus is it just this Justice which organises Parmenides' entry into the all-comprehending closure or self-containment of Kosmos, whose 'physical' aspect of the Sphere of Heaven reflects the logical circuit of the goddess' expression (in the finite terms of the poem) of the 'ontical' self-determination which expresses itself in the physical closure of the Sphere. The 'goddess' thus articulates, as the recurrence of Mystery (herself the 'theological' instance of its articulation, Wisdom personified), mystical Distinction which expresses itself through the symmetry of 'psychical' and 'ontical' orders (*ψυχικὴ* and *ὄντικα*). Discernment, Actuality, which distinguishes

itself from the symmetry of the finitary order of the mark or name - or pythagorean 'point' - in articulating the otherwise symmetric orders of psychical and ontical self-expression.

We have seen how this self-expression of 'Limit' marks itself in the symmetry of Justice as Square or 'squaring': it identifies itself in an 'abstraction' from the two 'sides' of distinction, corresponding to the symmetry of logical and physical and the symmetry of these 'finitary' orders and the psychical and ontical orders they reflect. Identifies itself, just as the unity of each corner of the Square is reflected in the unity of four corners, through the symmetry of the two sides, and the two which is each side, of two twos. We saw how the configuration of logical (or 'arithmetic') closure or recurrence, and the physical closure of Body was expressed in the 'musical' closure or recurrence of unity in the Tetractys which thus amounts to the reflection of Limit in the intermediate frame of a Justice which squares all. How Limit then, as principle of distinction, distinguishes itself from this expression in the symmetric order of point or mark, in the order of 'epiphany' which begins 'outwardly' in the narrative of Kosmos as frame of all such 'epiphany', unfolding from the first cosmic actuality of surface of light, One as the Central Fire, the 'Hearth' of Kosmos. How this narrative then proceeds through the harmony of the 'heavenly bodies' of light, in the Kosmic closure of the Sphere, to the incarnation of individual souls, and their transfiguration in the epiphany of their cosmic situation in this narrative which thus comes full-circle, as the initiate enters into the pythagorean circle or mystery 'marked' by the Tetractys, and into the *ὄρασις*, the vision, of cosmic Recurrence and self-expression.

We saw how, in Heraclitus' words, an analogous circle, an analogous mystery, expressed itself in the dramatisation of entry into the circuit of a *Λόγος*, reflected in the circular readings of those words - readings where the 'point of entry' is distinguished from our conclusions, only by the finality of the *Λόγος* which cannot itself be 'comprehended' in the circuit of any such reading, but only as the principle of understanding 'behind' every such construction. Thus here there is no definitive narrative: 'beginning' and 'end' are themselves two terms among others in the circulation of the text, which reflects the cosmic 'economy' of Fire.

We saw the 'complementarity' of <sup>Heraclitus' Word and a</sup> pythagorean KOSMOS as formal frame for the particular accounts or narratives which embody the figure of  $\Theta\epsilon\omega\varsigma$  in the particular situations of the activity within the pythagorean group - accounts in which the symmetries of figurate Number and the framing of activity in the comprehensive frame of a cosmic narrative are 'applied', combined in a particular situation, in a manner which is not itself determined either by the comprehensive framework of Kosmos, or the elementary syntax of Number. For just as the two sides of Kosmos (as pythagorean frame) and Number (as corresponding terms) cannot determine their combination in particular applications, nor can one properly abstract from Heraclitus' words any linear cosmic narrative, or any systematic elementary syntax.

We saw how this complementarity of  $\Theta\epsilon\omega\varsigma$  and  $\lambda\acute{o}\gamma\omicron\varsigma$  amounted to two 'one-sided' expressions of a figure common to each, and which was reflected (though not itself 'reflective', or belonging to the domain of Reflection) in the contemporary organisation of athenian 'drama'.

How now, can Parmenides be seen to integrate these two sides of Reflection (these complementary abstractions from a common Drama) in the dramatic frame of his poem?

Parmenides dramatises the entry into the divine Word, and into the corresponding 'converse' of earthly and heavenly at a particular point. At a point corresponding to the simple figure of entry into the closed circle of heavenly discourse (reflected in the closure of the poem - but primarily as another circuit within this closure) by participation in the logical dynamic of Reflection (of inscription of the difference of a configuration of terms and the actuality of the frame in which they are understood to identify this frame). By taking as his part the part of that heraclitean Wisdom which is the only constant direction 'through all things'(1) the soul's participation in which is Truth, the only true direction - for separate opinions, accounts which we take for our own, while belonging to the same principle of Direction, are not joined with, 'inscribed' in it, and lead this way and that, with no constant aim (2).

Thus do we find Parmenides 'on the way of the goddess'(3) in

an order of things governed by pythagorean Kosmos as the frame of all narrative. In that frame, that configuration of terms - but not within the logical closure of its pythagorean determination as itself narrated. Rather crossing out of that circuit, and so out of the mystery and its outward silence, into the understanding of the relation between this limiting narrative or cosmogony and what, outside it, is at the outset reflected in its terms, while at the same time independent of the narrative construction by which the 'physical' configuration of these terms is subordinated to or comprehended in the logical circuit in which *Being* is embodied. And this crossing articulated in the more radical mystical or heavenly order, of which the psychical determination of the relations of psychical and ontical (reflected in the logical determination of the relations of logical and physical) amounts to just one side.

In this sense, Parmenides entrance amounts to the first crucial step in the dynamic of Reflection, just as the transitional configuration whose primary expression is to be found in the pythagorean mystery, marks the point of entry itself, an initial silence broken by Parmenides.

First 'step'? ..But we have seen Parmenides entering drawn by a pair of horses.... ... and entering where? .. into what? There is not really anyone here but ourselves - indeed there is only one of us really 'here'.

... But would we complain of an actor entering upon a stage that he was not really who he said? 'Here' we must, as it were, see ourselves, whichever of us is here, in a dramatic frame of Kosmos, in which our actual situation is contained, just as a dramatic fiction might be contained in it: again there is a sort of 'continued proportion' between 'imaginary' fiction, present situation, and comprehensive context, the 'same' in principle for all situations, and in which they (and we, and Parmenides) communicate. A proportion analogous to Heraclitus' analogy of the child playing at being a king, the king, and the direction of the Kosmos including both City and (within the City) the child's game.

... So that the constant actuality expressed in Parmenides' poem in a way includes our reading of it, just as our situation, reading,

includes the dramatic fiction of Parmenides' horses. These horses, in virtue of not really being horses, allow an actuality that bears to us the relations we bear to horses and fictions, to distinguish and express itself, through a transposition of the language that articulates visible presence, here and now, to the analogous constant 'presence' of a Kosmos, of which this passing visible presentation is only one 'side'. In such a transposition, Heraclitus can call 'Word' what articulates Kosmos, as words (or their 'logic') articulate its 'visible' side, here and now, (just as then). He can call waking people 'asleep', he can identify the organisation of our appetite, when thus 'asleep', by speaking of monkeys and pigs. And just so can Parmenides call 'horses' what are not really horses at all, and I can write of the 'entrance' of Parmenides as something present. (It is just the identification of this general Analogy which closes this Part One).

.. So, enter Parmenides, 'on the way of the goddess', 'that carries the mortal who discerns, through all things' (1). Now, according to the prevailing analogy, this is no earthly way(2), but the horses or car of Parmenides are travelling among the stars. These wandering stars, 'planets', heavenly bodies, 'daughters of the sun'(3) guide him on the way. And they are in a sense the very wheels of his chariot, for 'the axle, glowing in the socket - for it was urged around by the circling wheels at either end - gave forth a sound as of a pipe, when the daughters of the Sun, hasting to convey me into Light, threw back the veils from their faces, and left the abode of Night'.

The primary cosmic expression of pythagorean Justice lies, as we have seen, in the 'musical' relations of the movements of the heavenly bodies, 'daughters of the Sun', in the two 'wheels' on either side of the primary circuit of the Sun, that we have already seen organising the cosmic analogue of (or Kosmos as analogue of) the Tetractys, between Central Body and comprehensive Sphere (in which last Kosmos, like the Tetractys, or a physical body, is closed in or on itself). This primary expression of the recurrence of the unit in Square Justice, corresponds to the 'double-bolted' doors between Night's multiplicity, and Day's true vision(4). At this 'door' (this figure of Justice governing the primary articulation of the heavenly circuits of light(s) in the dark Night) the 'daughters of the Sun' reveal themselves for what they are in actuality: the tokens of Day scattered in darkness, through whose coordination or harmony, alone, can mortals enter into heavenly Truth.

1: Fr 1

2: Fr 1

3: Fr 1

4 Fr 1 (cf Fr 2)

At this point, this 'doorway', the goddess expresses herself in greeting, and tells Parmenides that his journey and his entrance into her domain themselves partake of the order of Justice, rather than any arbitrary order; she expresses herself in differentiating those orders - heavenly truth, into which he is entering, and its benighted converse, mortal opinion. The goddess' way, on which he has travelled, leads through the door, in converse directions, through both: through all truth, and also through the bewildering maze of opinion.

First, into the circle of 'well-rounded Truth', as it distinguishes itself from wandering error: the configuration of this Truth has already been sketched; it will be seen to amount, in effect, to an abstraction of the self-expression of pythagorean Limit, from the order of the mark, whether this last be understood as figure, name, or physical aspect. To an epiphany in which logical and physical closure mirror one another, in abstraction from that logical direction of narrative (and its converse 'physical' Time) in which the identity of the 'point' is 'logically' derived from Limit, from Limit logically understood as distinction, 'before' the elaboration of any actuality in which such a distinction might be made (it was just the circularity of this definition of the 'point' or 'first unit' which seemed so strange, as we saw, to Aristotle). The configuration of the various primary cosmic orders in pythagorean 'epiphany' is retained by Parmenides, but in abstraction from the dynamic of logical distinction and physical differentiation through which the pythagorean Kosmos is presented as narrative: for there is in the closure of Kosmos upon itself no (logical) 'point' at which to begin.

..So Parmenides begins with just this contradiction. There is no way an initial logical distinction can be properly made: for what then would be the ground of distinction of the two 'sides' of whatever was to mark the distinction? Any 'initial' distinction must be purely formal, a logical 'fiction' of beginning, an arbitrary 'making' of a distinction. Yet that very distinction of a formal or imaginary distinction and an actual distinction is itself purely 'formal': how can we actually distinguish between such a logical order and a 'real' order 'outside' a formal or nominal distinction (of logical and physical, or formal and real)? Thought and thing, imaginary and real, are quite symmetrical, indistinguishable, unless their distinction is already effected.



We cannot deduce Actuality from some logical distinction 'prior' to Actuality: Actuality must distinguish itself. We cannot begin with a distinction of Actuality from something else, something 'outside' Actuality, as Unlimited is 'outside' the first Limit in the pythagorean cosmogony. For such a distinction cannot be actually made. The only distinction that can be made in relation to Actuality, is between Actuality, which simply IS, and the circle of supposing that one can mark a distinction between Actuality and something else, in order to distinguish a formal distinction from Actuality, and so determine Actuality (as it were) from 'outside', in some formal space in which Actuality might in turn be 'constructed' in the circuit of a narrative, of some 'theory'. The order of the mark is the order of pure fiction, turning on itself.

This coordination of logical and physical (or, perhaps, psychological and ontological) orders distinguishes two 'sides' of discourse: or rather, in this frame where the distinction between Actuality and the fictional order of the mark, of symmetry (to which the distinction of such a fictional order from Actuality, itself - as a fiction - belongs), Actuality presents itself as Truth: In the abstraction from this double symmetry (of the order of the mark, and the symmetry of this with what, as Actuality, is 'outside' the poetic or fictional order of the mark), that amounts to the self-expression of Limit in the frame of Justice, that 'gate' in the heavens which 'though far off' can be entered in the vision that expresses itself, in the domain of those fictions which benighted men take for reality, as an imaginary journey through the skies:

λεῦσε δ' ὄμμαρ ἑπρόντα νόωι παρεόντα βεβαίως

Look fixedly at things far off as present to your mind (1)

When it is seen that Actuality as 'outside' the poetic order of sequential narrative cannot be determined in the frame of that 'fictional' order, it presents itself, distinguishes itself, simply as (it) IS: its nature is simply TO BE. That - but we must regard it as present (fragment next above) - this - is, IS, itself; is what is.

This point in the narrative, then, marks the division of the two 'ways', ὁδοί, orders of proceeding, at the Gate kept by Justice. It is the point of transition in the poetic order of the narrative where (what) IS distinguishes itself, marks itself, as what is 'outside' this order of the mark, of marks, earthly or heavenly. The point where one steps, or is drawn, out of the circuit of the fiction that this 'out-side' can be marked and determined, comprehended, within the order, along the way, of the mark. And into the circle (or rather, as we will see, the sphere) which has no outside, but is simply 'in itself': whose 'outside' is a fiction - is, indeed, the fiction that Actuality is one side of some distinction. A side whose actuality can be logically or physically determined in the order of a narrative that begins somehow or somewhere before the actuality of (for example) its very beginning. Which appears to begin, that is, in the distinction of Actuality and something else - where this 'something else' must be the very assumption of the distinction of which it appears to be one term, some point 'outside' actuality. The symmetry of Actuality and something else, which is only 'outside' Actuality inasmuch it is fictional, 'it' isn't.

Now we enter into Actuality by choosing it, rather than some mark. And this, when we see the relation of Actuality and mark, is simply the actuality of thinking, is true judgement, is Truth itself, of which seeing-what-it-is is choosing, judging to be true. We thus enter into Actuality as it is present to the unwavering vision of νοῦς, enter into it 'as present, though far off'. And in this vision Actuality appears in a configuration of 'marks' or aspects (σηματα) through which it expresses itself by distinguishing itself further from the fictional economy of the mark.

Thus it is outside the dynamic of conversion of logical and physical orders in the poetic order of narrative. It has no beginning, as we have seen, for there is no point 'outside' it from which the transition into it - into its actuality - might be made. It is similarly endless. Indeed it simply IS, always in the same manner, and there is no way to mark or distinguish in it any 'was' when it was not 'IS', or any 'will be' when it will be something (say, 'then') which it is not.

Nor 'is' it 'here' any otherwise than 'there'; for then it would in some way be at each place something other than simply itself, which it simply IS wherever it IS. Physically and logically it is absolutely symmetric, since there is no way that what it is, or parts of what it is, can be distinguished, or marked off. No way of differentiating two points so as to mark any difference, even the difference of the points, is open. The only 'logical' difference that can be marked, is that between such difference and its identity and unity, the only 'physical' difference, that between 'imaginary' space, unlimited, and its distinction from the fiction of some mark 'outside' it. These distinctions there must be, but they are distinctions from nothing, from the mistake of trying to include its actuality in the organisation of the mark. Rather should we recognise that there only is anything insofar as something distinguishes itself from its reflection in the order of marks or names, as it expresses itself through them in this distinction. This alone - when we mirror this self-expression in recognising the distinction - is knowledge or truth.

The very nature of mistaking is to take a mark for what, in truth, it marks, to substitute the poetic circuit of marks, incorporating terms which appear to mark a distinction of this fiction from truth, from marking a reality - and so to enter the circle in which a mark appears, in relation to the coordination of marks and names within this fiction, to mark something which isn't, something 'absent'.

This circle of  $\delta\epsilon\lambda\alpha$ , of a belief which turns upon itself as an initial mistake of believing there can be true belief which is not knowledge, that the Actuality in which it is constructed can itself be included or comprehended in the illusory closure of some story, constitutes a converse  $\epsilon\delta\omicron\varsigma$  or path of belief, a mistake which perpetuates itself, and leads us mortals, imagining we can comprehend things in the various distinctions we think to make with our words, round in endless circles, until we find ourselves, like Parmenides at the outset, on the way of the goddess.

Fictions, the play of distinctions and differences, the

passing articulation of terms - 'names', ὀνόματα - and corresponding 'marks', ῥήματα taken to be marks of different realities, closed in themselves like the Sphere, or pythagorean Body.

In a way, the return to his starting-point along this imaginary path of δόξα corresponds to the pythagorean construction of a Kosmos as frame of narrative, of accounting, in which all occurrences might be inscribed and their bearing upon the drama of incarnation and reincarnation understood. Yet the κόσμος presented to Parmenides by the goddess is

κόσμος ἐμῶν ἐπιών ἀπατηλός (1)

- the 'deceptive arrangement of my words'. Parmenides' return journey, back through the doors of Night and Day, through the arrangement of the heavens (as the veil is again thrown over the 'daughters' of the Sun'), as 'what is is cut off from what is...

σκιερόμενον πάντη πάντως ἰκετὰ κόσμον (2)

is 'scattered everywhere about in order' - ἰκετὰ κόσμον: 'through Kosmos', almost - this return amounts to the inversion of the 'way of the goddess' that proceeds to the Sphere of Truth from (what we take for) the here-and-now of earthly incarnation. Just as the way of the goddess leads through the logical order of enquiry to successively wider symmetries, until it confronts in the frame of 'Justice' the question of the symmetry of this 'logical' order of inquiry and the 'physical' order of its object and its context - and at this 'gate' confronts the mystery of the disymmetry of that symmetry and what 'decides' it - so in an exact inversion of this path does the goddess lead Parmenides back to his starting-point, beginning with the simple step into the play of fictions through the introduction of the mark which 'marks' the circle of δόξα simply as such - as the abstraction from self-discerning Actuality through the fiction that Actuality can be introduced as one term in the order of narrative (in its 'fictional' or poetic closure), a term symmetric with Fiction or Imagining itself. The third section of the poem begins with the giddy step into this 'poetic' order of always-passing imaginings and their imagined references, and concludes with the marking in this order of the mark, the names which invert the just knowledge of What Is. Names which are the manifold 'terms' or termini of this inverse path, and thus mirror, in the frame of cosmic Justice, the single 'term' of the goddess' path - IS.

First, then, the entry into the circle of δόξα, into that cosmic maze in which the fiction of marking a starting-point 'outside' simply-identical is-ness turns upon itself, embodying in this recurrence or circle the minimal or primary instance of the organisation of fictions, lesser circles, in the primary closure of what I have called the 'poetic' order.

A 'poetic' order, articulating the endless dynamic of conversion of two symmetric orders, two terms: 'Light' and 'Dark' their (physical) 'marks'. Two 'marks', reflecting in the poetic symmetry of logical and physical the primary expression of logical distinction, the initial mistake of cosmic importance:

μορφαὶ γὰρ κατ'ἄλληλους δύο γνώμης ὀνομαζέσθαι (1)

- two 'forms', μορφαί, figures, appearances - and in them the reciprocal dynamics of conversion of Light and Dark, logical and physical, mind and thing -

... τὸ γὰρ πλείον ἐστὶ νόημα (2)

- the dominance of one side of the distinction is the activity of mind.

And the entry into the interplay of 'physical' and 'logical', of thing or nature - φύσις - and corresponding direction of mind-δέσνησις, νόυς (3), is exactly the initial circular supposition (and so determination), κατ'ἄλληλους, of distinction - the preponderance of the logical in the initial distinction of the symmetric orders of Light and Dark. As we have seen before, this imaginary circuit of definition, in which a supposed distinction is 'used' to distinguish the logical or psychological order of distinction, this 'abstraction' from Actuality which distinguishes itself to this 'logical' image, to an imaginary psychological actuality of reference - this circuit amounts properly to a direction of subordination of one 'side' of the poetic order (in this case the 'out-side' to the logical 'in-side') to the other. This disruption of poetic symmetry marks precisely the passage into the 'poetic' dynamic of fiction-within-fiction (for example the fiction of the inscription of the fictitious 'physical' identities of Light and Dark, or Hot and Cold, within the fiction of a logical distinction of logical and physical orders) whose frame, Ἀναγκη, Necessity, corresponds to what I have already characterised as Law, and its Economy.

γίνεσθαι ἀποφύλακτον ἐξ ἡλίου πρῶτον γινώσκου (1)

- souls are sent from invisibility into visibility, and back; and this 'through' the Sun. In a figure that should now be fairly familiar, the relations of the 'mystical' order of the Sphere as a unitary whole to the symmetrical 'poetic' order in which it is inscribed as one term, are reflected in that poetic order in terms of 'heaven' and earth as two symmetrical sides, with the circle of the Sun as middle term, as the mirror in which 'heaven' and 'earth' are symmetrically organised as supernatural (or mythological) and natural economies respectively. The 'mystical' unity of the Sphere is thus reflected in the outer limit in which this whole scheme of visible heavens and earth is contained. The earthly order reflects its own place in this heavenly whole, in the place in the earthly order of our individual bodies. If the articulation of the group, as framing our earthly activity, the earthly order of our incarnation is then seen (in this cosmic proportion or analogy) to reflect the astrological order which intervenes between the two poles of central solid and outer wall of Kosmos, the central circuit of Sun will be seen to correspond exactly to the earthly cycle of generation as primary frame of the earthly economy of Life<sup>(2)</sup>.

τηροῦσθαι μὲν ἑστῶσα θεῶν μνηστῆρας ἀδύνατον (3)

Just how the 'goddess in the middle' (4) organises the heavenly production of the stars and their cycles is not clear from the remaining fragments, though the most natural assumption must be that Light and Dark as rare and dense would be separated by the primordial circuit or circulation later made visible in the circuit of the Sun, according to the prevalent pre-pythagorean cosmogonic figure developed by ionian 'physics'.

Nor is it quite clear just how far Parmenides' figure of the cyclical incarnation of the soul according to Justice and Necessity accords with the pythagorean mystery of release from the wheel of birth on Earth. But the general outline is clear enough: the 'downward' movement into the circling maze of a fictitious reality, a mortal implication in the great Mistake, and the converse movement of abstraction from 'wateful birth and begetting' (5), upwards upon 'the way of the goddess', back through successive symmetries, grander fictions, to the doors of Night and Day, and the discovery of the Justice that governs all through

1: Diogenes Laertius IX, 22 (Zeller I. 601 n. 1) 2: frs 11, 12 3: fr 13 4: fr 12, 3  
5: fr 12, 4

the self-expression or revelation of Actuality in the frame of the last question posed by the reflection of the fictitious symmetry of Actuality and Fiction (or Story) in the symmetry that governs the articulation of all stories, all δόξα.

- The Justice which articulates and governs the relations of this Actuality and Fiction as the fiction of two sides, True and False. Where the self-expression of What Is in the symmetric configuration of the psychical and ontical actualities of discernment and identity, seen in relation to the mark as the discourse of 'the goddess', is reflected in the mirroring in the fictional dynamic of a 'World', a Kosmos of 'forms' and their interplay, of the converse movements of mind and thing (1).

The poem began with the approach of Parmenides to the gates of Night and Day governed by Justice. Through them he passes into a participation in Actuality, in the assent which is Truth, the entry of thought into the circular intercourse of knowing and being. Thence he returns to his starting-point: first into the bare frame of the Kosmos that is the circular illusion of Fiction, then through the intermediate astrological or astronomical order of the Sun, then into the earthly order which reflects in the general frame of Creation as Fiction the relation of that frame itself to Actuality. On earth he finds himself incarnate (2), and bodily involved in the endless conversion of earthly imagination and earthly reality (3). And this in the symmetry of the two 'sides' of embodiment in the 'mark', the element of that poetic order in which these two 'sides', mind and thing, are articulated as converse movements or dynamics. And it is with this principle of the mark, marking the distance of these passing fictions which hold us apart from Truth, that the poem concludes:

οὕτω τὸν καὶ δόξαν ἔφου τὰδε καὶ νῦν ἔειπε  
καὶ μετέειπε' ἄσπε τὰδε τελευτήσαντα τρεφέεσσι.  
τοῖς δ' ὄνομα' ἔνθ' ἔρωται κατέθειναι ἑπίσημον ἔκαστω. (4)

- thus things appear to have come into being, thus they seem now,

1: Fr 16, & its context, at the opening of Theophrastus' On Sensation.

2: cf the 'genetics' of Frs 17,18    3: Fr 16    4: Fr 19

- This, then, is how we - or rather, Parmenides - re-enters the economy of fictions which organises our mortality, from the gates of Night and Day. We will soon see that the more usual point of entry - through a more earthly 'conception' - mirrors or parallels this mystical descent from the Day of Truth into the Night of what we take for truths.

At the point of entry Light and Dark are quite uniform and symmetric throughout the Sphere, inscribed in it simply as the formal distinction of two terms, two forms, reflecting the initial supposition of the symmetry of Sphere of Actuality, and the order of fiction in which it is thus formally inscribed.(1)

The disruption of this initial symmetry, corresponding precisely to the entry into its fictional economy, is then articulated within the governing frame of poetic closure (that circuit of which the logical circle of subordination of the difference of logical and physical to a logical articulation partakes, like the converse dynamic of Hot and Cold, Rare and Dense) which first appears in the fiery circuit of the Sun in which the order intervening between Sun and solid outer Sphere reflects the order intervening between central sphere of Earth, and Sun. This 'harmony', the image of Justice in the Necessity of visible Law, reflects exactly the pythagorean heavenly harmony which, in the proem, the introduction to the discourse of the goddess, led Parmenides along the converse path into the Sphere of Truth. The other face of the 'goddess', as she articulated the fictional or mythic economy of the visible Kosmos, is the creative or procreative principle through which Creation, the order of *δοξα*, persists, forever turning upon itself. For the converse logical and physical 'economies of Light and Dark fit together in the union of their mirror movements in the union of the symmetric principles of Male and Female (2).

It is through this principle of Eros that, within the circular persistence of the fictional economy of Creation, we enter into the circle of earthly mortality that reflects within the fictional order of Kosmos as a whole the movement from the Sphere of Truth into this Kosmos:

καὶ τὰς ψυχὰς πέμπειν ποτὲ μὲν εἰς τὸ ἐμφανοῦς  
εἰς τὸ κρυπτόν, ποτὲ δὲ ἀντιθέτως φέρει. (3)

1: Fr 9      2: Fr 12, 13      3: Jamblicus Physics 9a (2, 1.604)



in time they will develop and come to an end: for each of these men have taken a name as a mark.

How does Parmenides' poem itself fit into the scheme of things it presents? Does its circuit belong within the domain of passing fictions.. or does it somehow mark in that domain, in this Kosmos or Creation, something 'outside' it? Or might it somehow present us with the question of the relation of fiction and Actuality in it?

In it...'it': what is it? Not some self-enclosed logical circuit in which some formal identity - formal Identity - is somehow defined in logical abstraction from its context, from the 'out-side' of the poem in which we find ourselves now. For the poem contradicts precisely such a supposition of any purely 'logical' circuit of Abstraction, in which the Actuality in which the poem somehow participates might be inscribed, adequately defined, as one term, opposed to the open possibility presented by the closure of the poetic (and a fortiori the logical) frame upon itself - to the fictional frame of all fictions.

No.. we cannot take it as expressing some 'thought', some construction of the Actuality which expresses itself in the articulation of text and context, within which we can actually read the poem. We cannot apply some 'later' conception of thought, of conception, and insist that Parmenides' 'idea' or intention express itself clearly as such an abstract thought.

... But we can, parallelling in this the articulation of the poem itself, see its 'publication' as a dramatic first step into the open symmetry of 'logical' and 'physical' dimensions of a History, a Tradition, of Reflection - as an expression of Parmenides' part in the 'Actuality' which articulates this History as (partly) determinate Fact, his part in what thus is now (for it was), through his playing the part of the author of the poem whose fragments still remain, his written assent to the discourse of the goddess, to the Actuality which IS, in as much as we partake of its self-affirmation in affirming IT IS.

And we take part in this same articulation of judgement and its 'ontical' object, in thus reading Parmenides' poem 'dramatically'. Reading 'it' as the expression of a first step into the open symmetry of logical and physical orders which was, long ago, the Future in a pythagorean Kosmos.

That is: we cannot 'comprehend' Parmenides' poem by inscribing it as Parmenides' 'thought' in a configuration of terms, a logical circuit, in which we would include both the logical closure of Parmenides' construction and its 'object', symmetrically 'outside' it, as a physical 'thing' might symmetrically mirror some term within the poetic frame of Language or corresponding World. We will see that such an attempt to 'comprehend' the Actuality which expresses itself in Parmenides' poem constitutes the dominant 'logical' dynamic or direction of the subsequent Tradition. A dynamic which presents one side of the 'economy' in which the writing and reading of this book will find their place. We have already seen that such a 'logical' step is one 'side', a formal component, of Parmenides' part as author of the poem: logically, the guiding 'question' of the poem may be taken to be the symmetry between the terms in which pythagorean Kosmos was expressed within the pythagorean group (as limiting narrative frame of *ἑρμῆς*, and the circular 'stories' in which it must have been developed), and the Kosmos in which the reflection of 'Kosmos' in a narrative frame (or as comprehensive frame of narration and accounting) defined the formal closure of the group, the 'mystery'.

'Logically', then, Parmenides' poem appears simply as a 'critical' standing-outside the circuit of the pythagorean mystery, a breaking of the circle constituted by Kosmos as Fiction, Creation, within the Kosmos that outwardly reflects such a fiction; a breaking with the mystery in the outward expression of this symmetry in the frame of a 'fiction', Parmenides' poem (with its horses and cosmic adventures).

But that is only one side of the poem. If we try and understand the poem simply as 'criticism', simply 'internally' - as Parmenides' 'thought' - then we face the immediate contradiction that the poem itself partakes of the delusive 'fiction' that it appears to exclude from true thinking. The immediate contradiction which must then be attributed to Parmenides' 'thought' has an analogous history to the

attempt to comprehend pythagorean *κόσμος* or heraclitean *Λόγος* in subsequent constructions where they appear as one term among others, rather than the very frame of the construction which, in their context, they dramatically express (or allow to express itself). In a sense we might say that the Actuality which expresses itself in the passing configurations of these terms - *κόσμος*, *Λόγος*, *Ἔσθ*, remains constant, ever articulating the 'inside' and 'outside' of the terms in which it expresses itself according to the same forms of *κόσμος*, *Λόγος*, *Ἔσθ*; but that an equally constant actuality expresses itself in the articulation of the dynamic in which new terms are found to express new forms of mirroring of previous expressions of constant Actuality, and their actual 'context' in which the 'critic' finds himself - and in which he is drawn to reconstruct Actuality in new terms.

In its barest outline, the 'context' of Parmenides' poem - in its simple character as spatiotemporal frame of stories (like Parmenides' poem) and of the actions they present (in the case of Parmenides we will see that the 'dramatic' truth of the story lies in its character of action) is the same at the time and place of this writing and reading as it was (or 'is') at the time and place of composition. Within this context, reflected in the poem as play of 'fictions', as interaction of the 'circular' fictions of name and thing within their symmetry in the poetic frame of 'fiction' (and the comprehensive Fiction of a World of changes), the poem presents itself to us as itself embodying such a poetic frame. But at the same time, when we see it as a 'fiction', we see its dramatic truth as presentation of Actuality, through exemplifying the truth of all stories as their fiction. The poem thus operates, like a mark which marks the fiction of a mark 'outside' Actuality as the fiction by which it is taken to mark something, as a 'mark', an indication of an Actuality which in this indication expresses itself. Expresses itself in transfiguring the circuit into which we step, thinking to define the Actuality in which our step itself blindly partakes. Operates the 'transfiguration' from the fictional closure of the story in which it appears to be itself marked, its actuality somehow supposed 'open' like the reference of the term to something which might mirror it 'outside' the fiction, to the self-expression of what articulates this 'inside' and 'outside', and in which the thought by which we thought to define Actuality appears as the circle of a fiction turning on itself.

In this way, the apparent 'logical' contradiction of Parmenides' expression of Actuality in the frame of a fiction itself plays its part in the configuration - the dramatic configuration - thus presented in the poem. The poem thus operates (or allows the operation of) an access to the Drama of Kosmos, which is reflected in the poem as the analogous access of Parmenides to the Sphere of dramatic Truth (in which judgement and being correspond in a 'converse' whose mystical locus is 'marked' in the discourse of 'the goddess'). To the Sphere in which the fictional frame of this poem marks the access to that (this) Sphere, out of the circuit of fictions and their open dynamic which appears (in this dynamic) as one 'side' of the writing or reading of the poem. To comprehend the poem, then, is to see this 'side' as a fiction - as the unlimited play of the mark, the name and the 'thing' - as the mark which marks its own inconstancy, its purely elusive, illusive, delusive 'being' or identity 'in truth'. The mark which is the access from the Sphere of Truth to this mortal play, in which the poem marks the passage out of the play of the mark. Thus the poem is, as it were, the very image of the gates of Night and Day, the portals of the Sun, in this 'lower' world, this Earth, which reflects in the mirror of solar Justice, the Sphere of cosmic Truth.

.. And here we are, reading the poem, on (apparently) this same Earth on which Parmenides wrote it. And in our 'earthly' terms, we are separated from that writing by so many circuits of that same - this same - 'Sun', 'above' us as it was 'above' Parmenides. We may now construct the heavens rather differently from Parmenides or the pythagoreans of his.. day; but the simple symmetry or mirroring of Earth and Heaven, two 'sides' of the frame of our activity; and the organising circuits of the Sun remain constant in all the intervening permutations of terms, from Parmenides' poem to our place and time in its 'spatiotemporal', earthly and 'heavenly', context.

Within this simple frame, Parmenides (as we have seen above) recognises the cycles of 'awful birth and begetting', the circle of reproduction, as primary 'work of the glowing sun's pure torch' (1). This cycle of generation, organised about our 'years' (in which the Sun thus 'articulates' the fictional or poetic order of the stories we live out),

corresponds to that earthly Nature of natural - 'physical' - economy of earthly Life from which abstraction is made in the Law of the City, the autonomous group. A Law which thus mirrors on Earth that Justice which is the middle term between Earth and Heaven, like the Sun between Earth and the outer Sphere.

This Law of the greek City defines the circuit of a 'Culture': an 'inside' in which the relations of 'inside' and 'outside', of that Culture and a 'Nature' outside, 'beyond the pale', are themselves inscribed. - Just as the relations of logical text and physical context as defined within the text constitute, within the City-culture of the greeks, the domain of the 'Reflection' into which the pythagorean mystery is here taken to mark the transition:

Now, this transition may be associated with the convergence of two earlier traditions, the two dominant and complementary 'foreign' mythologies with which the greek transition into Reflection is constantly brought into relation in the biographies, the stories, of the early sages, and of Pythagoras most particularly. One of these (which the greeks called 'chaldean') was a city-culture framed by a mythological 'economy' of interaction of heavenly and earthly cycles, of the 'musical' composition of heavenly circuits with the various 'circuits' of organisation or activity in the business of the cities. The other (egyptian) was framed in a sort of mythological 'politics', with its strict hierarchical organisation. What seems characteristically 'greek' in the convergence of these elements in the pythagorean mystery, in Croton, is the integration of mythological politics and economics in the frame of a Law which reflects heavenly Justice in the autonomy of the City.

We can only attribute to the first pythagoreans the simple frame of interaction of these cosmic 'politics' (or government) and economy as an organising factor or figure in the dramatic configuration of the mystery. The symmetric integration of its government and its economy in the Law or Constitution of Kosmos, as presented in the first 'pythagorean' text, itself defines a 'cycle', a period, of Reflection - of that factor in the Culture of the greek City-state. What relation does this 'cycle' of Reflection, defined by the transposition of pythagorean 'Kosmos' from the 'practical' circuit of  $\Theta\omega\rho\acute{\iota}\alpha$  to the closed circle of a written text,

bear to the correlation of astrological and natural cycles in the activity defined in cosmic terms as the integration of, the middle term between, these two 'harmonies', heavenly and earthly 'composition'? For this cycle of Reflection must itself be considered as exemplifying the dramatic order which, framed in the City, in its Culture, is a middle term between earthly Nature and astral Heaven.

Clearly, we cannot expect to properly understand the development of Reflection (one 'side', as it were, of greek Culture) in terms of the reflection which constitutes only one point or phase in that development. We can hardly imagine that we could 'close' the figure of Reflection, close the dramatic frame, the story, at some point before the close, by trying to simply understand the place of Reflection in Kosmos as its context, in terms of the reflection that amounts to one vision of Kosmos at a certain time and place. Thus we will not understand the cycle of Reflection defined by the passage from Kosmos in the *Genesis*, the vision, of the first pythagoreans, to the embodiment of this pythagorean 'theory' in the closure of a book, simply in the terms, the 'economy' of Kosmos, as presented in that book. That would be (as it were) to try and 'short-circuit' Reflection.

And yet the question posed by this 'short-circuit' does make possible a decisive step in the inquiry into the 'closure' of this book, the embodiment in it of an analogous 'short-circuiting' of the 'World' or Kosmos as a question: as the question of the 'closure' of this book. As the question posed in the 'symmetry' of that 'logical' figure of 'closure', of the 'in-side' of the book, constituting a certain 'reflection', and the 'out-side' marked in this logical configuration as the 'physical' order of (this) context.

For this analogy allows us to consider the whole development of the 'Tradition' from the first pythagoreans down to this book, as itself a 'cycle' of Reflection, in which Reflection or Theory first embodied in the 'short-circuit' of pythagorean *Genesis*, now reappears simply as a question, as the question posed by the closure of this book, the formal inscription in it of the symmetry of its 'inside' and 'outside', the 'logical' determination in it of the symmetry and distinction of its 'inside' and 'outside', its text and context, its 'logical' and 'Physical' aspects or sides, in the dramatic or poetic configuration of its

reading and writing.

- Conversely, within the simple frame of this book as question (and working backwards, as it were), the transition into Theory or Reflection appears as the point, in the configuration of this text and its context, at which a frame for this question, 'Kosmos', is identified. This 'identification', as we saw, itself embodies an elementary or primary principle of distinction of text and context, and thus constitutes a certain elementary 'actuality' of the question posed by the text. This 'actuality' in which the identification of Kosmos in the 'historic' context of the book, and the identification of what was then identified (this in the book), reveals Kosmos as <sup>the</sup> radical dramatic frame in which these two identifications (of such Kosmos) share - as opening and closing terms of the 'drama' of marking Kosmos. Marking Kosmos as the frame of such marking - which thus effectively expresses itself as an actuality - or as Actuality itself.

Now we have just seen that, although the short-circuit implicit in the 'logic' of this definition of Kosmos (first seen as ~~Stage~~) exactly reflects Kosmos as its primary context, yet the relation of these, 'text' and 'context', is not definitively 'comprehended' in any text with-in the Tradition constituted by the progressive drama of comprehension. At the same time, we can express this relation, this interaction, as a question (marking the 'close', or transition out of, the Tradition), in terms (precisely) of this drama or dynamic of 'comprehension' as a story. My part in framing this interaction as drama then constitutes a question - a closing question - in virtue of its place as both 'within' and 'out<sup>9</sup> side' the Tradition it defines. It marks the close of the Tradition as the question of the transition out of the Tradition.

The Tradition, then, is logically closed in the figure of a 'cycle', the recurrence of the initial figure of Kosmos in the closing question of the relation of text and context. Within the 'period' of Reflection thus defined, the 'logical' dynamic of the Tradition as successive re-inscription of the relations of earlier texts to their context (and most particularly, of their failure to fully determine 'from

within' the relations of textual 'inside' and contextual 'outside') in the logical closure of discourse (that circuit in which the relations of logical and physical orders are supposed logically determined) which constitutes the domain of Reflection as a 'traditional', 'historical', activity. We have already seen how this 'critical' figure operates in the first episode of the Tradition, Parmenides' step 'out' of the circle, the logical Fiction or Creation of pythagorean Kosmos.

I then suggested how we might work back to that episode, that initial step, that initial 'phase' of Reflection, by inscribing it in the cosmic scheme of Philolaus, embodied in the first pythagorean book. For that book, or its scheme, its cosmic economy, allows the inscription of Parmenides' step within the dramatic frame of Kosmos, and should, in principle, allow the inscription of the circuit of Reflection from the initial circle of *Circle*, through Parmenides' exemplification of the relations of that initial 'fiction' to its cosmic context in his poem, then through a further step (associated with Zeno and Empedocles) to Philolaus' book itself, in the scheme presented in Philolaus' book. Thus this circuit of Reflection, this phase from initial *Circle* to its inscription in the logical circuit of a book (rather than in the unwritten 'accounting' of the first pythagoreans, rooted in its changing contexts) might appear as a cycle of thinking constituting one 'side' of the development of greek Culture, and finding its place in the theoretical articulation of greek activity as a whole as a middle term between the heavenly cycles of the stars (those of the Sun defining the seventy or so 'years' of activity) and the natural cycles of those 'elements' of <sup>those</sup> bodies in which and upon which the whole development was acted out.

But any such construction of the phase of the Tradition down to Philolaus and his contemporaries (most notably the earlier athenian 'sophists') is of course immediately open to the criticisms of Philolaus' immediate (and more distant) successors.

What we can, however, attempt, is an analogous working-back to Parmenides' step, as seen within the 'cycle' of the Tradition as a whole, from initial 'theory' to the presentation here of Reflection as a question.



This avoids the immediate difficulty of the 'short-circuiting' of Kosmos as general context of the whole Tradition (which rules out 'closing' the Tradition with Philolaus' book), insofar as the circuit involved in this instance is itself expressly inscribed in the question of the book as a whole: the closure of this circuit is directly determined within the questioning articulated in the closure of the frame of the book as a question.

Further, the recognition of this principle of 'short-circuiting' Kosmos, seen most clearly in the initial circuit of pythagorean ~~Order~~, allows an initial division of the period defined by the Tradition as a whole: we may define a 'first half' of the Tradition by the development from the early pythagoreans to a Kosmos framed in terms of the symmetry of the 'logical' circle of theory, (and its direction or dynamic) and the 'physical' order 'outside', as open, as the primary locus of questions. The transition through this 'middle' of the Tradition is traditionally called 'The Scientific Revolution'.

This intermediate transition may be said to begin with the questioning of the determination of the relations of the 'mystery' and 'economy' of Kosmos in a closed universal economy: A questioning framed at the outset in terms of the systematic symmetry of these two sides of a closed Kosmos. The question of the inscription of a mythological or mystical determination of the relations of Mystery and Economy in a closed economy, in an open economy of interaction of these two 'sides' of Kosmos - and this question progressively articulated about the meeting of Mystery and Economy in our choice, as a middle term.

(That beginning of a 'middle' phase of the Tradition allows us to define a middle period closed by the questions posed by the symmetry of Mystery and Economy, no longer defined in a closed frame or Kosmos - in which Mystery is naturally the dominant side - but rather in a framing of the open economy of their interaction. The subsequent 'period' then closes in the recognition - as here - of the 'mystery' involved in just this framing.)

Now, the 'economy' of the Kosmos at the opening of the 'middle phase', amounts to the integration, in Aristotle's economy

of the 'term' (logically determined simply as such - as the analogue in language of the pythagorean 'point' or mark), of the question posed in this first period, from the pythagoreans until these 'middle ages' in which the middle phase opens, by the 'Incarnation of the Word': the question of the relation of those 'two sides' of  $\Lambda\omicron\gamma\epsilon\varsigma$  in whose distinction their unity (as the side which includes both) expresses itself. - This question posed, ~~not~~, as by Heraclitus, in the frame of a text, but in the dramatic acting-out of the 'continued proportion' of incarnation, Earth, and the whole Kosmos as closed frame of this drama or mystery. This 'Incarnation of the Word' - as the question of the relation of Mystery and Economy in a closed Kosmos, is thus a 'middle term' between the self-expression of  $\Lambda\omicron\gamma\epsilon\varsigma$  in Heraclitus' text, and the framing of the drama or mystery of incarnation in the 'medieval' economy of the mirroring of Mystery and Economy in the closure of Kosmos as their frame. Closure: for Mystery then expresses itself systematically within the primary mystery of just this closed expression of the mirroring of Mystery and Economy - a closure which (as we have already seen in analogous instances) is 'outside' the open symmetry of Mystery and Economy, as Parmenides' Actuality is outside the fictional symmetry of Actuality and Nothing.

Now, this 'question' of the Incarnation of the Word marks, in the first period, just that: a question, something essentially open. For it marks the question of the mirroring of text and context in the poetic or dramatic order of their mirroring, and not in the inscription of that symmetry, along with its formal resolution, in the logical order which constitutes the domain of Reflection. The 'logical' continuity of this 'first period' is thus broken at the point where the logical circuit of Aristotle's economy of a closed Kosmos, and the complementary platonic dramatisation of Kosmos as a sort of logical mystery, are formally integrated: in its perfect symmetry, the resulting text closes upon itself, and Reflection literally disappears. For in the last step, the point of entry into the logical circle is systematically lost in that symmetry of beginning and end of a circle through which entry distinguishes itself from the point which marks it. An entry into the resultant mystery can then only be effected insofar as it is fashioned anew within the frame of narrative, in the poetic order of text and context, in whose order the Incarnation of the Word marks a possible transition into the logical circuit of Reflection, a transition which cannot

first be made in the reverse direction, except by 'dramatically' breaking the circle.

Within the logical circuit of an Abstraction whose continuity is broken at that point, the course of development from Heraclitus and the early pythagoreans up to that logical impasse might be taken to define a period, which we might call 'Antiquity'. In the wider 'dramatic' frame of a Tradition of which the logical circuit of Abstraction is only one side, the 'first period' or first cycle of Reflection, which turns about the Incarnation of *Λόγος* as a question, extends, as we have already seen, from the pythagoreans to the 'medieval' integration of the figures of Mystery and Economy in a closed Kosmos, articulated according to the figure of an 'Analogy of Being', in which Actuality distinguishes itself from Nothing on a variety of levels intermediate between simple fictions, and the Being which expresses itself, as in Parmenides' poem, in its simple self-distinction from Nothing. The Sun, for example, on this 'Analogy', may be taken as the visible image of an actuality intermediate between the pure Being of the circumference, of 'highest heaven', and the mixture of Being and Nothing in our earthly incarnation. This simple figure, as will soon be seen, amounts to the full working-out, in the economy of a closed Kosmos, of the distinction of Actuality and Nothing (or fiction) first introduced by Parmenides.

Within the frame of that poetic symmetry of the first period, the close of 'Antiquity' - associated with the closing of the Schools, and the definition of a Time whose 'zero-point' about five hundred circuits of the Sun previously marks the Incarnation of the Word - mirrors, as has in effect been already suggested, the institution of the athenian Schools in the fourth century of years before that Incarnation. The elaboration of the Analogy of Being, in the thirteenth century of our traditional Time, mirrors, as I have just suggested, the institution of the Tradition, of 'theory' or Reflection. In the extended frame of the Tradition as a whole, the close of 'Antiquity' is mirrored in its rediscovery in that fifteenth century of our Era, when the 'middle' ages were first identified as such: as a period intervening between the loss of pure 'theory' in late Antiquity, and the new access to it through the intervening development of a certain narrative, and a certain 'history'.

... Thus far to the place of the institution of the great athenian Schools: but what now of the transition from the inception of 'theory' to its embodiment in the School? I have already suggested that we might take Philolaus' pythagorean system, and early sophistic, as a sort of middle term between the pythagoreans (and Heraclitus) and the establishment of these Schools of Plato and Aristotle in the 'fourth century' before the Incarnation. And I further suggested that Parmenides' first step might be taken as one episode in the Reflection intervening between the first pythagoreans and Philolaus' book. It remains only to sketch the 'other side' of the Tradition - or rather the cultural frame of the Tradition intermediate between Reflection and Nature - and we should discover a simple coherence of the dramatic frame of the Tradition, according to which it may be inscribed within the question posed by the relation of 'inside' and 'outside' of this book.

This book.. this question: for this book is expressly framed in the question of the relation of 'inside' and 'outside', closed text and open context. How might we trace the context back to Parmenides?

Well - by a parallel movement to that by which I have just inscribed Parmenides' step within the 'logical' frame of the Tradition; indeed this parallel movement is already suggested by the reference to the 'schools' of Antiquity.

Here again, the movement into our Past must begin from the 'composition' of this book as question: now the simple framing of it as 'book' in this .. what?.. in which I write. This .. what? .. which includes somehow or other the book, and myself, and you reading, and Parmenides, and those pythagoreans, and Heraclitus, and Plato and Aristotle, and Greece, and Earth, and Sun and stars, and so much else, whatever exactly it all adds up to (if indeed it adds up).

Again, the 'middle' phase of the Tradition corresponds to the opening up of the closed Kosmos of Antiquity and the 'middle' ages, and to the interaction of Reflection and its World in a common dramatic frame in which Reflection participates as 'Science'. Indeed the close of this 'middle phase', identified already in terms of the clos-

ing frame of its 'Reflection' (an open 'economy' that concludes the development from the closed economy reflected in the Analogy of Being, through the period of the 'Scientific Revolution'), mirrors in its context that 'theoretical' close. Mirrors it in various cultural 'revolutions', political and economic, that open up this last period, at whose close I am writing.

This middle phase begins in a cultural frame which, again, reflects the 'theoretical' configuration of Reflection. The symmetry of Mystery and Economy is paralleled in an analogous (if considerably more 'open') interaction of 'Church' and 'State', or 'spiritual' and 'temporal' authority. - More 'open', since the actual interaction of Reflection and Nature in the frame of that medieval Culture characteristically belies the symmetrical organisation of this interaction in the cosmic scheme of Reflection - in the universal frame or economy of theory, embodied in the universal School or University, with its own theoretical place and function in that universal economy of incarnation and transfiguration in which earthly Culture, and this intellectual culture of the University within it, fitted into the scheme of the whole as developed in the University. - At least in theory... for although all details of the scheme might have been open to dispute, the frame of disputation itself was as fixed in this circular vision as pythagorean *ἑνὸς πάντων* before it, embodying the same figure of recurrence: the place of the vision of the Whole in the Whole.

.. And this same circuit seems, indeed, to characterise the place of Reflection in 'Culture' ( whose determination of the relations of Culture and 'Nature' it of course directly reflects, within this circular figure of Culture as a whole: for in the circuit of language which embodies Culture as Law embodies the constitution of the City, Reflection constitutes itself by abstracting its logical circuit of definition from a more general 'poetic' economy) throughout 'Antiquity'. In particular, the closing of the Schools of Philosophy which more or less marks the close of Reflection in Antiquity (and reflects the logical impasse which that Reflection had reached) now takes its place in the dramatic economy of sixth-century Culture: there is no place for the logical circuit of Abstraction in the poetic economy of that World, in that World's narration of itself, turning about the ritual narration, the dramatic mystery, of the Church.

Thus, in the fifth and sixth centuries of our Era, there comes full circle that 'circular' definition of the place of Reflection in Culture which first appears, as instituted in its civic context, in the schools of Athens, and in Plato's attempt to educate the young ruler of Syracuse, and in Aristotle's education of the future ruler of the World. - Alexander who, after his father had done away with the greek city-state (except, characteristically, for its place in Aristotle's civic theory), founded that model city of Alexandria which became the intellectual and material market-place, forum, of the World: a 'World', a world-culture, whose systematic articulation in a universal Law - a sort of universal 'city-state' - coincides very closely with the beginning of our Era. .. And the breaking-up of this earthly Law, and its replacement or transformation by a universal Church with its laws, corresponds precisely with the close of 'Antiquity' and its Reflection.

What then, finally, of the 'cultural' configuration of the transition from the pythagoreans and their civically instituted mystery, to the formal institution of the athenian schools of the fourth century before our Era?

I have already suggested that this transition falls into two phases: from the pythagoreans down to Philolaus and the Sophists, and then on from there. And I have marked the first phase as a definite 'period' or cycle, in terms of the passage from the unwritten Kosmos of Croton, to the Kosmos of Philolaus' publication, his book, with its integration of Parmenides' Actuality and the mark or point in its 'system'.

'Sophist': professional teachers; Athens, around the beginning of the last third of the fifth century, had become the economic centre of the greek world. Her Law, her constitution, integrated government and economy in the economy of their interaction in the Agora, the Forum, the market-place. Eloquence, verbal authority, the power of persuasion, the command of the economy of language in the courts and assemblies, became a commodity of great value in this general economy. - This athenian economy by whose extension to the intercourse of the city-states Athens was on the point of provoking a political reaction that, at this time of the first sophists, was on the point of dividing the greeks, and thus indirectly opening the way to the integration of the states under an external military law in the following century.

In a simple way, the position of the sophist in the general 'economy' of Athens, in which the relation of political government and economic organisation was itself framed in the general economy of the constitution, amounts to the inversion of the position of the pythagoreans at Croton - where the relations of government and economy were imposed 'from above', in every sense - and where they induced the practical 'criticism' of a democratic or demagogic reaction, as the athenian economy of power induced the reaction organised about the spartans, with their closed constitution, their strictly political principles, their legally enshrined aversion to any part in the economy of the household, the field, or the market-place.

Insofar as the general economy of their instruction ( according to which a certain fee bought a certain lecture or course of lectures, bought the pupil's access to some element in the economy of words, which would profit him in his civic activity) implicated the order of Reflection in the logical articulation of argument (taken as just one element among others in the general economy of language), this new context of Reflection is clearly mirrored in sophistic theses. In the sophistic economy of language (and of thought as simply one side of this economy), the figure of Reflection appears in the general theses in which sophistic methods are exemplified in the definition of 'the' general frame of their application. - This frame must, of course, be taken as simply one element among others in the radically 'dramatic' axis of sophistic skill.

The 'frame' of sophistic is just one application of sophistic: just as the 'political' framing of athenian activity was then just one element in the general economy of that activity as a whole, an economy which included as one element its very framing. It amounts, one might say, to the inversion of Parmenides' unitary Truth as Actuality. 'Being' as 'outside' the circular fiction of a fiction in which Being or Actuality, <sup>occurs</sup> becomes just a meaningless mark in the play of accounts, which now turn about a 'dramatic' truth, that axis of sophistic in which the orator makes things true: the circular character of the 'mark', and the linguistic order of accounting, from which Actuality as One distinguishes itself dramatically in Parmenides' poem, becomes the open frame of self-assertion. Everything is 'fiction', making-true: the central truth becomes, as in athenian drama, the actors recognition of himself as actor.

The reference of the mark to something outside its 'poetic' order, an Actuality prior to the mark, which ontically expresses itself in distinguishing itself from the mark and its order (in which it thus marks itself, like that which distinguishes itself from a point on a circle, by distinguishing the point as 'beginning' and 'end') itself becomes the last illusion which the actor must overcome, seeing this as an outward reflection of his failure to recognise himself as actor, the outward reflection of that fictitious identity he takes for himself, and which impedes his free action, short-circuits his power of make-believe and making-true, actualisation, his actuality.

Where Parmenides had marked the point where Actuality distinguishes itself 'ontically', Gorgias the sophist excludes this one fixed point 'outside' the economy of language, and in this criticism of Truth exemplifies the dramatic truth of self-assertion in the poetic economy of language, and so in the athenian economy of the greek world (1). Gorgias first appeared in Athens in the year 427: the scene had (as it were) been already set by Protagoras' abstraction from Heraclitus' discourse of the play of distinction, of ~~λέγος~~ but in the articulation of his discourse, the distinction of ~~λόγος~~ and ~~φύσις~~ as framing the exposition had not itself been brought 'into play' (2)

This confrontation of Reflection and Economy, whether in the economy of Kosmos as expressed in Philolaus' book, in the appearance of professional teachers in Athens around the beginning of the great war in which athenian economy was to attempt the subordination to its scheme of the opposition of such economy and spartan authority, or in its other manifestations (such as early 'atomism', of which a little more in a moment) may, I suggest, be taken to divide the transition from pythagorean (and heraclitean) mystery to the establishment of the Academy and Lyceum, into two symmetric or complementary phases. Whereas the pythagorean mystery had outwardly expressed itself in a transitory political domination of the affairs of Croton, and sophistic amounts to the entry of Argument into the athenian economy of greek affairs as outlined above, the institution of the Academy and Lyceum in the fourth century involves the integration in the Culture of Antiquity of the logical circuit of Reflection (and its dynamic), reflecting a closed Kosmos or World in which it determines both the place of (its reflection of) that Culture, and its own place within it.

1: On Non-Being, or in Nature

2: cf. Zeller II. 447



Now the 'first half' of this transition from Croton at the beginning of the fifth century before our Era, to Athens around the middle of the succeeding century may, as I have suggested above, be itself divided into 'episodes', the first constituted by Parmenides' transition out of the logical circuit of pythagorean 'theory', and into a frame of Kosmos 'outside' the pythagorean mystery. 'Outside', not in the way that the 'outward' configuration of Kosmos, taken to mirror the logical coordination of its terms in the narration of 'theory', is symmetrically 'outside', the outside, the context of the mystery. Not in the way that this 'outside', this frame of the mystery, is determined by the definition of the relations of 'inside' and 'outside' within the mystery. - Not in that 'logical' determination of the relations of logical and physical orders, which is constitutive of the circle of  $\epsilon\kappa\alpha\iota\tau\epsilon\lambda\epsilon\iota\sigma\mu\epsilon\tau\epsilon\sigma$ , and which is reflected in the definition of the point as elementary 'mark'. Rather - as, in the symmetry of inside and outside, of narration of Kosmos and Kosmos, the actuality of Kosmos as frame of all actuality, including the actuality of the theoretical narrative which would in a circular manner include in its terms this primary context, distinguishes itself as one side - as 'outside' - in which the circular constitution of the content of some theoretical narrative appears to be itself 'outside' this actuality. Only appears to be: for its elementary 'point' or simple mark cannot be actually outside Actuality, like some point in time 'before' the Actuality of the closure of Kosmos upon itself has been defined, and proceeding 'logically' from which this Actuality might be constructed and defined. This 'outside' is itself only a mark, which refers to nothing 'outside' the Actuality in which it leads us round in circles. Circles without any fixed beginning or end, in whose play one may be inscribed in another, like one fiction, one story, one account, in another.

This 'Actuality' thus appears dramatically in the 'Kosmos' which frames the relations of cosmic context and the 'theory' in which it is imagined defined - and this, as it were, in response to Parmenides' questioning of the relations of pythagorean theory and its cosmic context. - As the 'other' invisible 'side' of Parmenides' definitive step. Parmenides inscribes his step in this Actuality, his authority marking itself as belonging to the order of fiction from which Actuality (in the relation of the poem and its context) distinguishes itself. With Gorgias, as we saw, this distinction 'outside' the order of fictions is

and the embodiment in such a closure of the configuration of a prior framing of Actuality (or activity), and its context: this defines the 'episodic' character of Reflection, its primary actuality in this narration. It is in this sense that Parmenides' poem amounts to the first step in the drama, and the first appearance in Kosmos as the frame of this drama (Kosmos which frames also the writing and reading of this account), of Actuality identified, and identifying itself, as such.

Between this first episode, and that initial phase marked by the pattern of Reflection at the outbreak of the peloponnesian war, is a phase of Reflection which falls into two steps such as that just attributed to Parmenides.

Parmenides' abstraction from the order of the mark (as fiction or the mere appearance of definition and distinction) might be seen simply as the abstraction (from the circular figure of pythagorean  $\Theta\omega\rho\iota\alpha$ ), of Limit,  $\lambda\acute{\iota}\mu\eta\varsigma$ , from its mirroring (through the order of 'harmony', fitting-together, of Odd-Even and 'square' Justice) in the point, as marking (this latter) simply marking itself. (Thus Limit,  $\lambda\acute{\iota}\mu\eta\varsigma$ , as finality, might be marked as what distinguishes 'beginning' and 'end' at a point on a circle - or in the circular discourse of the goddess). This configuration of Limit, mirrored in the poetic order of the mark, does indeed correspond exactly to the framing of Parmenides' poem in the 'harmony' of Kosmos. Yet such a formal determination of Parmenides' step abstracts from the dramatic force of Parmenides' invocation: it amounts to a purely formal criticism, a reinscription of Parmenides' step within the logical circuit of pythagorean 'theory'. The force of the poem lies, not as a move within the logical frame of Kosmos, a better expression of that Kosmos in which  $\Theta\omega\rho\iota\alpha$  was framed as a narrative integration of the orders of Limit and Number, but as a move in the poetic frame, out of the circle by which the relations of theory and context were reinscribed within the narrative order of theory: a questioning of the presupposition of that circle (constitutive of the pythagorean mystery) and reflecting the closure of the pythagorean group (or groups)).

The next step (after Parmenides) may then be seen to have two complementary aspects or 'sides'. An 'internal' reply to the 'formal'

criticism - showing the contradiction of supposing that logical circuit, that fiction, by which the pythagorean 'point' might be supposed defined as a symmetrical 'other' side of theory to the Unity of Parmenides' abstraction (Zeno). - And Empedocles' poetic framing of those two 'sides' of 'theory' as converse movements (like the converse paths of Parmenides, towards and back from the sphere, through Justice as circuit of the Sun) within the fixed frame of cosmic Justice as primary, all-embracing, actuality.

Parmenides invokes in his poem what distinguishes itself from the poetic order of the mark, from the fictitious symmetry of mark and actuality in the fictional order of poetic symmetry. Zeno then introduces the figure of this distinction into the formal mirroring of the poetic order of the mark (as Number) and Kosmos as narrative frame within the circuit of pythagorean theory. Parmenides' criticism of the supposed symmetry of the narrative order of theory and Actuality, its context, from 'outside' - from that 'outside' or context in which Actuality distinguishes itself - is reflected by Zeno within the narrative order of theory. He shows that in the domain of Number, where the symmetry of Number and Kosmos is reflected in the symmetry of logical and physical orders of the unit as point, the 'logical' distinction of Kosmos as actual frame of theory, determined by the 'logical' distinction and determination of logical and physical orders in terms of the point, cannot even begin. The supposition of the logical distinction of logical and physical orders, in the point used, intended, as elementary mark, introduces an asymmetry of logical and physical orders of the point, a converse physical determination, which 'contradicts' the initial logical fiction. - Just as, more generally, the supposition of a symmetry of fiction and actuality in cosmic narrative, of Non-Being and Being, involves the 'contradiction' that Non-Being is, has being. In virtue of Zeno's formal expression of this general principle within the closed frame of a formal theory, he is generally taken, in Antiquity, as the introducer of the 'figure' of Dialectic.

Empedocles' move is, in a simple way, complementary to Zeno's. Empedocles, as 'actor' steps squarely into the poetic frame opened up by Parmenides' poem. He assumes, as 'persona', as locus of his poetic and mystical authority, the meeting and conflict of those two 'sides' of Parmenides' poem: its inscription in the order of narrative, of 'Creation',

and the appearance, in this 'descent' into the earthly order, of a heavenly order of harmony, which distinguishes itself in a converse movement. Rather than frame his poem(s) in the heavenly abstraction of Parmenides' reflection, however, which repeats, in the symmetry of Actuality and Fiction, that same figure of abstraction which Parmenides had identified as constitutive of the order of fictions, of narration, Empedocles frames his activity (including the composition of two cosmic poems) in the figure of the circle common to the two orders, and embodied in the two-sided frame of Parmenides' poem itself. In this frame, thinking, the reflection of Parmenides' poem, appears as an abstraction, just one side, of the dramatic frame of incarnation. The two sides of the poem reflect the two sides of our incarnation, earthly body and heavenly soul. Reflection must recognise itself, as in the 'autobiographical' aspects of Empedocles 'Purifications' (*Καθαρσμοί*: the title of one of his two poems) as one element in the cosmic drama in which we find ourselves, body and soul, at the middle of Parmenides' two paths, at the gates of Justice.

What then, is the Frame of Empedocles' Kosmos, the scene of his activity as 'prophet'? How, as one element of that activity, does Empedocles frame it?

Let us consider the first movement, Creation, the movement from the 'Sphere' to the place of the poet, incarnate on Earth. Here the cosmic figure of Justice appears in the subordination of differentiation, the play of distinction, Heraclitus 'Strife', to Harmony, 'Love'. Love, like square Justice, 'equal in length and breadth' (1), a perfect fitting-together of harmony and distinction in the perfect balance of the four 'elements', Earth, Water, Fire, Air, which frame the World: an abstraction from the opposition of the two 'sides' of Justice, in the 'squaring' of this fourfold distinction. In this dominance of Love, though, Strife begins to distinguish, express itself, precisely through that principle of the circle, the circular movement which will later appear in the course of the Sun, familiar from Parmenides' path of descent from the Sphere - a principle first expressed in the ionian cosmogony of Anaximander (like the corresponding circuit of 'Justice'), beginning a preliminary phase of cosmic narrative that comes full-circle in Empedocles' vision.

This process of differentiation separates out the cosmic 'ele-

ments', with Earth at the centre, just like denser matter moving to the center of a cup of water stirred into circular movement. At the surface of this earth, the interface of the elements, the elements again begin to 'fit together'. Strife or differentiation is still dominant, insofar as these compositions do not in turn fit together into some unitary harmonisation of the whole: yet this harmonisation proceeds within the dominant movement of differentiation, insofar as what 'fits' the scheme of converse harmonisation and differentiation at this stage, finds a place in the evolving harmonisation. The way things fit together is determined as a sort of image of the initial harmony of the elements in the Sphere. Indeed the 'survival of the fit-test' amounts to a kind of rough Justice. The dominant organising force at this stage of the story, therefore, is the 'blood' as principle of the movement of fitting-together which is Life, which consists of a fitting-together of the four elements in equal proportion, as in the Sphere. Bone fits in with this blood (for example) insofar as its related composition is two parts earth, two of water, and four of fire: a sort of abstraction from the airy principle, its lightness and insubstantiality, which fits in - on the other hand - as breath.

Empedocles gives great attention, then, to the various components (as they fit together) in the evolution, according to this principle, of men and women, and, most particularly, to the corresponding articulation of human bodies, their perception - a sort of 'fitting together' of outer object and inward principle of sensation - and the integration of this relation of inside and outside in the thought which is embodied in the blood around our hearts. Characteristically, many of the component figures of 'fitting-together' and its narrative logic amount (like the swirling water in the cosmic cup) to 'analogies', transpositions of the organising proportionality or *λόγος* of one configuration, to a different set of terms.

The converse movement, in this frame, the re-assertion of Love, its subordination of Strife in the integration whose underlying principle has been, now, reflected in *θεσνυσις*, the thinking of the heart, the embodiment of soul, amounts to the harmonisation of all Life in the Sphere. A harmonisation in which the elements are seen to be only the 'earthly' side of those living divine principles of Water, Earth, Air Fire, harmonised in the cosmic Mind of the Sphere as perfect Life. The economy of

Kosmos, in the closure in which the two movements are seen to be symmetrical, in the Justice in which they are united in a circle, governing the balance of ascent and descent, now appears on Earth, in earthly terms, as a mystery - indeed as Mystery. And in the second poem this mystery turns about the part in it of Empedocles 'embodiment' of is Truth, his 'showing' the path of return to all mortals, as Parmenides had shown the way to the Sphere in abstraction from the mortal frame of his .. composition. Empedocles thus embodies that 'dramatic' truth subsequently abstracted by Gorgias, his fellow sicilian, from this cosmic context, and applied within the athenian economy of the city-state.

In this mystery of Empedocles, one is held in the earthly circuit of Strife insofar as one fails to see the fundamental harmony of all Life simply as such, as earthly expression of the cosmic Harmony which is Love. And the fundamental expression of this mortal blindness lies in the nourishment of one's body with another's blood, with any blood - that earthly image of the Life common to all animality in particular, <sup>and</sup> to all Nature.

Empedocles' activity, then, is organised about the poetic axis of the mystery of Kosmic Justice. His activity as ardent supporter of Justice in the City, as wandering Prophet and 'Healer', as Poet and Philosopher, as the magician who acts, operates, in the invisible order of mystery, as in the visible order of incarnation. This activity amounts to a dramatic step into the Actuality of a Kosmos which reflects both sides of pythagorean theory in its cosmic context, where Parmenides had reflected only the actual closure upon itself (in the Sphere) of Kosmos as a whole, in abstraction from the embodiment of the play of fictions in the 'mark'. The story runs that, after the publication of Empedocles' poems, no poet was admitted to the pythagorean mystery (1), for fear that he might publish further the pythagorean principles embodied in Empedocles' poem in abstraction from the limiting terms of point and mathematical Kosmos, in abstraction from the primary logical circuit which defines the theory as the pythagorean mystery, <sup>and</sup> its abstraction from a silent context.

This step of Empedocles, then, in which the Sphere is abstracted from Parmenides' ontical stasis, and the 'marks' of Earth, Water, Fire and Air from the logical circuit of the pythagorean definition of the point, embodies 'outwardly' the fundamental mystery which first finds expression in the closed circle of pythagorean ~~theory~~, defining a Kosmos as it de-

defines, in terms of this Kosmos, the place of that definition and vision in the Kosmos it defines. 'Outwardly', in the poetic symmetry of this 'theory' and its context, as dramatic frame of activity, of which the theoretical abstraction of the pythagoreans is only one side. Embodies that same mysterious circuit: for Empedocles steps into the activity required of his place in a Kosmos, whose definition ( and with that the definition of his place in it) is one aspect of that activity.

Zeno, on the other hand, takes the critical principle of Parmenides (which Empedocles has thus in effect applied to Parmenides' ontological circle, in its 'poetic' or dramatic context) and embodies it within the frame, in the terms of, the logical circuit of pythagorean theory.

These two movements, following Parmenides' initial step may, I suggest, in the formal simplicity of their iteration of just such a critical step, be taken as a further step: and it will, I hope, be fairly clear in outline, how the outward embodiment of pythagorean theory in Philolaus' book, and the position of Gorgias, represent one more analogous step. Gorgias might be said to apply Zeno's dialectic to Parmenides' ontology, and abstract the dramatic truth embodied in Empedocles wandering prophecy to the closed frame of the City, defined (or organised) in the civic frame of a Law abstracting from cosmic Justice. In this he continues the sicilian tradition of rhetoric that had not, up to that point, been associated with the figure of Reflection (Reflection enters into the athenian drama of Euripides and Aristophanes around the same time). Philolaus manages to restore the logical circuit of pythagorean theory, and incorporate the criticism of Zeno, by introducing Number and a complementary unity of Actuality as a whole as converse movements, corresponding to the converse integration and differentiation which articulate Empedocles' cosmic vision. The details of Philolaus' construction must however be somewhat tentatively derived from a collection of fragments in later authors, some of which are transposed into a later terminology, and some of which seem to allow no reasonable construction of any genuine original.

Empedocles the prophet, Philolaus and Gorgias the teachers, Zeno who is said by many authorities to have shown outstanding courage

in resisting a tyranny which embodied in the City that same short-circuit (of Justice) which appears in the logical determination of the relations of physical and logical orders in the configurations of mathematical points. There are of course many other actors in the dramatic interaction of Reflection and the cultural economy of which it embodies, in the closure of book or discourse, one side. One side which reflects in the circuit of Culture (with its 'cultural' determination of the relations of Culture and Nature, its context) that World or Kosmos in which a 'culture' frames the dramatic interaction of men and women of which thinking is one component, one side. One side which, throughout Antiquity, inscribes itself within the circuit of culture seen as the reflection on Earth of a cosmic order of which Earth itself amounts to one side, just as civic culture is one side, on Earth, of the earthly unity of Culture and Nature, of the *Nóμος* and *Φύσις* so central to sophistic disputation, its rhetorical frame.

So far, the correlation of the episodic character of Reflection with the cultural economy of the City as a whole (let alone any correlation of this whole, then, with an earthly economy of Culture and Nature, and of that with some universal Economy of Kosmos) has been suggested only in vaguest outline - in terms of a few analogies between the reflections of early 'philosophers', and their places in the organisation of the Kosmos defined or reconstructed in these reflections. Most notably, this correlation was claimed to be an essential element in the constitution of the pythagorean mystery as point of transition into a Tradition of Reflection which leads, somehow or other, to the writing of this book. I have suggested that, in the development of this Tradition, the actuality of such writing is progressively articulated, within its reflection in books, in the writer's dramatic recognition of his part in the drama he defines, the part of this definition in the dramatic frame of a Kosmos, 'within' which (as simple correlate of the logical circuit of the text itself) as primary scene or stage, the interaction of the writer's self-assertion in the logical circuit of the text, and the Actuality which distinguishes itself in the relations between text and context (as it were in response to the writer's self-assertion) 'takes place'. So far, ~~into~~ this dramatic frame of Kosmos, as simple correlate of this text, have stepped Parmenides and Zeno, Empedocles, Gorgias, and Philolaus. The early pythagoreans, Heraclitus, and the Incarnation of the Word (as question) were there at the outset, to meet me as I myself step-



ped in, and wondered where I was, and what was going on.

Now it is characteristic of the first phase of the drama, within Kosmos as closed frame, abstracted from the open symmetry or mirroring of Mystery and Economy whose articulation in Reflection I take to mark a 'middle phase' of the Tradition, that Reflection should determine the mirroring of Kosmos by it within the closed circuit which defines its domain. It is just this short-circuit of the open economy of interaction of Kosmos and Reflection which determines Kosmos, in the Reflection of the first period, as 'closed'. - In the middle phase, the 'physical' economy of 'the World' is marked in Reflection as a question, the open-ness of the logical order of Reflection to a symmetric physical order, which can only be partially inscribed in the logical organisation of Reflection insofar as these two symmetric orders are articulated, together, in the poetic economy of activity- notably, in the open logical economy of Experience or Experiment, as it enters into the dramatic order of an activity of which it is only one side.

Thus, in Antiquity, the intermediate order (between Reflection and Kosmos) of the application of theory - of the way that 'theoretical' terms enter into our interaction with Kosmos - this is itself determined within the frame of Reflection. - The application of theory, intermediate between Reflection and the closed Kosmos which is determined in Reflection as its context, is itself determined within the frame of relations of Kosmos and Reflection, as determined in Reflection.

Naturally, it is just this 'application' of theory, the organisation of 'theoretical' terms in the 'poetic' order of activity ( and 'experience' in particular) as an inseparable part of that more extended poetic economy, which comes to dominate Reflection in the 'middle phase', in the 'Scientific Revolution' which turns about the seventeenth century of our Era.

Now, in Philolaus' scheme, one might correlate episodes or phases of Reflection, within the wider development of the Culture in which it is embodied, with the cycles of a heavenly 'harmonics' organised about the circuit of the Sun, as civic activity is organised around the corresponding 'year'. Thus Aristotle's pupil Eudemos: 'If one believes the pythagoreans, that the same things recur according to Number, and that I will be talking to you, holding this rod, as you sit as you

do, <sup>and</sup> with everything else the same, then it is reasonable that the time should be the same' (1). Later pythagoreans calculated that the natural 'period' of reincarnation was 216 (the cube of six) years (2). Heraclitus had already pointed out that in his cyclic scheme, a man could be a grandfather in thirty years (3); our seed recurs in twice seven years. - Seven, the 'critical' number (4), associated, it seems, by Philolaus, with the Sun as seventh heavenly body, embodying in the decad of ten heavenly bodies the seventh place (5). In Philolaus' exposition, it seems, Limit and Unlimited replace empedoclean Love and Strife as primary cosmic principles; like Love and Strife, they combine in a cosmic harmonics. But Philolaus articulates this Harmony in terms of Number, between a central unity of One (the Hearth of Kosmos, the Fire, Light, Life of the most elementary 'physical' expression of limit, the tetrahedron) and the encompassing Sphere. The 'interval' between this central Fire or Light or Life and the domain of Earth is 'reflected' in the <sup>harmonic</sup> division of the interval between Earth and Sphere by the Sun. Empedocles' four elements are reduced to four of the five 'cosmic solids' or regular bodies (tetrahedron, cube-earth, octohedron-air, icosahedron-water). The 'harmonics', the fitting-together of the heavenly cycles organised about the sun's year, seem to have organised the fitting-together of these elementary bodies (so that everything would recur in the 'Great Year' alluded to by Eudemus above). In a like manner the principle of heavenly Harmony of the elemental forces as a whole in Empedocles' Sphere is reflected in the local combinations of his four elements on Earth (itself the locus of one of the elemental masses as a whole). Again, as Number organises the harmonies between Earth and Sphere, and through these, as frame, the 'harmonies' of earthly bodies, so perception and sensation and thought is framed by Number, as <sup>they are</sup> framed by an analogous Harmony in Empedocles' Kosmos. And as, in Empedocles' world, all these 'harmonies' themselves fit together in Love as Harmony itself, so in Philolaus' Kosmos, Divinity seems to rule all things through Harmony, and through the framing of earthly recurrence in the heavenly articulation of planetary cycles in particular. The soul, likewise, would seem to govern the body in an analogous manner, as its 'harmony', thus belonging to the heavenly order - as the elements of the body belong to the 'earthly' order. (1)

But we cannot, <sup>properly</sup> of course, apply this systematic pythagorean economy to the determination of those three 'cycles' or steps of the activity of mind or 'soul', which intervene between the first elaboration

of that circuit of *θεωρία* which amounts to an access to the 'heavenly' order of cosmic government, and the 'embodiment' of that circuit of 'theory' in the closed logical configuration of a material book. For that would, of course, be to 'short-circuit' the general economy of logical and physical orders in the Tradition, in a manner quite analogous to the logical 'short-circuit' of pythagorean theory revealed by Parmenides and Zeno (or the 'short-circuit' of Parmenides' ontology revealed by Gorgias).

Indeed, this 'one-sided' character of Philolaus' re-inscription of the relations of theory and context 'in' theory - in embodying the 'poetic' articulation of Empedocles' cosmic scenario in a logically closed 'theory', presented as text in that context of the pythagorean mystery which had hitherto been determined in the mystery as Silence - this is directly brought out when we consider the configuration of contending 'reflections' at the time of that publication.

For the recurrence of that pythagorean figure of Number as frame of Kosmos amounts to only one of several parallel 'cycles' which together constitute the transition from the beginning of the fifth century to the outbreak of the peloponnesian war. The initial figure of the recurrence which constitutes 'vision' - the self-expression of Actuality as it distinguishes itself from the mark, in articulating the 'reflection' of psychical and ontical orders in the open poetic symmetry of logical and physical orders (from which, in this distinction, psychical and ontical actualities distinguish themselves in an 'epiphany') - had appeared within the circle of the pythagorean mystery as *θεωρία*, and outside it as *λόγος*.

Now the recurrence of these two figures in a text, following those steps marked by Parmenides and Empedocles, takes various forms. Each embodies the 'logical' circuit initially seen in the complementary figures of 'theory' and 'discourse', *θεωρία* and *λόγος*. Philolaus' text, like the initial 'accounting' of the first pythagoreans, is dominated by a 'logical' determination of this closure of the text. Gorgias' discourses, we might say, amount to a 'poetic' determination of this closure of the text constitutive of 'Reflection'. Contemporary 'atomism' amounts to the determination of this closure in 'physical' terms. We might say that within the common logical circuit, subordinate analogues have been traced, defining contrasting 'perspectives', within the common figure of Reflection. Thus the inscription by Philolaus of the 'logical' circuit of theory within a

'context' to which the same figure of logical closure has been extended in previous 'steps', from an initial coincidence of these two 'circuits' in the earliest form of the mystery - this embodies both the 'theoretical' logical determination of that distinction of text and context from which abstraction was made in the earliest figure of the mystery (the abstraction revealed by Parmenides), and at the same time embodies this figure in the context, as a book. It is within this closure of a 'logical' order, within the domain of Reflection at large, that one might, in principle, inscribe the determination of the steps that led to it, within a 'logical' conception of (the) Kosmos at large.

But that would only 'work', once abstraction is made to such a 'logical' Kosmos. It would not make sense in the 'physical' Kosmos of contemporary 'atomism', nor in the 'poetic' Kosmos of Gorgias ( a 'Kosmos' only in the sense of the 'deceptive ordering' of the goddess' words on Parmenides' return journey to the fictional order of ~~Sox~~ ).

- Thus, in the 'physical' World (or worlds..) of contemporary atomism, the figure by which the relations of logical and physical orders (their difference), as emphasised by Zeno, are reinscribed by Philolaus in a logical economy of Kosmos (or which the difference of ontical and poetic orders are 'poetically' determined by Gorgias) also appear in a converse abstraction of Leucippus (and later, Democritus) to a physical determination of this difference, this relation. As Philolaus determines Empedocles' integration and differentiation logically, in terms of a primary difference of Limit and Unlimited, and their interaction in the frame of mathematical Harmony, Leucippus determines this interaction in terms of a primary difference of Being and Non-Being, and a corresponding 'mechanical' integration and disintegration of bodies. Where in Philolaus the logical distinction of terms is made a starting-point from which to derive the actual distinctions from which abstraction has first been made, so in Leucippus and Democritus, abstraction is made from the familiar physical interactions of everyday bodies to invisible interactions of supposedly elementary bodies (which are nothing but 'body', physical closure, identity), from which the intermediate domain of logical distinction and physical difference is again reconstructed. Naturally the psychical actuality of soul which is a direct correlate of Philolaus' logical determination of the relations of logical and physical 'sides' of the 'poetics' of everyday life, is excluded in principle from the atom-

istic scheme. 'Mind' appears only as the mechanical function in this altogether 'physical' Kosmos, of the most symmetrical - spherical - atoms - which, properly speaking, amount only to the organising force of Light or Fire, that 'physical' converse of Heraclitus'  $\lambda\acute{\epsilon}\gamma\omicron\varsigma$  .

The 'poetic' articulation of the everyday order of sensation from which abstraction has been made, is attributed to that same 'convention' which the sophists were then inscribing in the more general economy of Nature. The 'Mind' that had remained as the originative circle of movement, the rotation which was the first ground of distinction, in Anaxagoras' Kosmos (transitional between that of Empedocles and the atomists) becomes in Democritus' scheme, a simple reflection of convention, law,  $\lambda\acute{\omicron}\gamma\omicron\varsigma$ , becomes the Necessity,  $\lambda\acute{\nu}\omicron\gamma\iota\kappa\eta$ , the Justice in which we have no part. In practical terms, one lives out the dramatic force or truth of this physical actuality of Kosmos by a sort of detachment from the mechanical illusion of any 'direction' in things, in accordance with the justice of physical Necessity. Truth amounts to the related 'ontical' vision of the physical world(s) as an expression of Being - whose distinction in such 'vision' or theory from the mechanical interaction of sensation and resultant desire remains the fundamental criticism of the 'theory' (1). For what place can be found for 'theory' in the theory...?

$\theta\acute{\upsilon}\sigma\iota\varsigma \gamma\alpha\rho \tau\omega\nu \lambda\acute{\epsilon}\gamma\omicron\lambda\omicron\nu \tau\acute{\alpha} \phi\alpha\iota\omicron\nu\omicron\mu\epsilon\nu\alpha$

Seeing: appearances of the invisible

(2)

Anaxagoras was banished from Athens shortly before the outbreak of the war, on a charge of impiety: Justice would not allow the suggestion that cosmic direction, government, was an illusion. ..At least, in the political economy of Athens <sup>shortly before</sup> the death of Anaxagoras' friend Pericles, who had directed affairs for many years, this was the charge brought by the opposing faction, to remove him from the scene.

The 'next step' in the drama, corresponding roughly to the duration of the war, might be taken to correspond, more exactly, with the public activity of the sophist who took no fees, the Socrates whose own 'removal from the scene' on a charge of impiety may be taken as closing that phase or step. A following step might be taken to lead from this

1: Democritus, fr 125      2: Anaxagoras fr 21a

close - the opening of the fourth century - to Plato's visit to Syracuse beginning in 368 and the philosophic frame of a platonic Republic which might be taken as leading the philosopher to the syracusan court (and the arrival of Aristotle at the Academy in the following year). A further step would lead to Plato's death in 347, his succession as head of the Academy by his pythagorising nephew, and Aristotle's departure from Athens. A following step, again corresponding to the development of some elementary figure, as in the rather schematic 'steps' from Parmenides' onwards, might be taken to lead to Aristotle's return to Athens and his lectures at the Lyceum. Thus far I have only rather vaguely suggested the 'second half' of the transition from the pythagoreans at Croton to the athenian schools of Plato and Aristotle. This vagueness may now be seen to reflect the way that I wish to take the conclusion of the whole development from the early pythagoreans to 'around the middle' of the fourth century to amount to the transition from the 'classic' platonism of the middle period - around the time of the educational visit to Syracuse - to the aristotelianism of the Lyceum lectures. - To take these two 'visions' of Kosmos as two sides, two expressions, of a common principle which might be said to 'organise' this transition over the middle part of the fourth century. - The transition from the 'dramatic' framing of the 'classic' platonic dialogues of the middle period, through the more systematic later dialogues, and Aristotle's activity as a teacher of 'rhetoric' (in conflict with the elegant 'show' of Isocrates), to the systematic logical economy of the peripatetic lecture.

I will then try to suggest how the figure of this transition, from the beginning of the fifth, to the middle of the fourth century, may in turn be seen to be analogous to the figure, the economy, of the 'first period' as a whole: how the place of Parmenides' first step in the 'Tradition', as it stands in relation to the development of the Tradition down to the figure of the 'term' around the middle of the following century, might be seen to be analogous to the place of the development down to this 'term' in the first part of the Tradition, down to the mirroring of its (essentially aristotelian) economy in a complementary mystery in the Kosmos of the thirteenth century of our Era. A mirroring which turns, like this 'first part' of the Tradition, about the figure of an 'Incarnation of the Word'. And in this 'continued proportion', this analogy between the development down to Plato and Aristotle, and the development down to the 'Schoolmen' of the thirteenth century, it will be seen how the way that this 'first part' of the Tradition turns

about the beginning of our Era, reflects the way that the phase from the early pythagoreans down to the athenian schools turns about the configuration of Reflection at the beginning of the peloponnesian war. - In particular, it will be seen how the reappearance of pythagorean themes - 'neopythagoreanism' - around the beginning of our Era, amounts to another recurrence of the pythagorean 'Kosmos', analogous to the appearance of Philolaus' exposition in an earlier phase of Reflection.

So what?..

- So, I hope, there will become apparent a simple figure of the inscription or fitting of one 'cycle' of Reflection in a wider development, which may be directly applied to the 'period' of Reflection from the pythagoreans, down to the inscription of this book in that Tradition, as a closing question.

For example, it should become clear how one might find in the 'analogy' or proportion of the phase down to the 'term', and the Tradition as a whole (where not the term, but the poetic framing of Reflection in general, is in question), a simple 'structural' analogy between the configuration of Reflection in Athens around the beginning of the peloponnesian war, with its systematic pythagoreanism, its nascent atomism, its economy of appearance - and that configuration of Reflection which we take for the 'Scientific Revolution', the turning-point of the 'middle part of the Tradition, and of the Tradition as a whole. It may be as well to note here (then) that those 'applied' theories, 'mathematics' and 'medicine', so central to the 'Scientific Revolution' first appear in systematic form (in the persons of Hippocrates of Chios and Hippocrates of Kos) in Athens, around the beginning of the war with Sparta.

- Hippocrates of Chios, about this time, first attempted to put arithmetic and geometry - 'mathematics' in the strict sense of the word - into systematic form: into an arrangement whereby the 'logical' components of mathematical 'demonstration' be organised into an economy of 'Elements' (*στοιχεῖα*: the letters of language) in which any proposition might be analysed, broken down into subordinate propositions, and these in turn further reduced until a starting-point were reached, and the proof could be constructed in a systematic manner. (This analogy of

'elements' and the letters of language from which words, sentences, and discourse are 'built up' was used by Democritus to characterise the construction of physical bodies from their 'elements', their irreducible 'atoms'; it applies equally, as is perhaps obvious, to the principle of breaking-down the development of the Tradition into 'components', outlined above).

The more famous Hippocrates studied under Gorgias and Democritus (whom he is said to have treated when he 'lost his mind'). Hippocrates' theoretical frame is the interaction of bodily 'constitution' and its physical context or environment, as it affects the harmony, the composition of the empedoclean four 'elements' in our bodies. Health, as the harmony or combination (ἁρμονία) of these elements - or of the liquid 'humours' through which they are expressed in the organisation of the body - is subject to periodic fluctuation. Thus an imbalance, treated by appropriate intake of the right elements, the right environment and activity, is rectified through the expulsion of 'morbid' matter, a 'crisis'. These crises tend to occur at definite periods - 'critical days'. Treatment thus consists in the intervention in an empedoclean economy of Nature, best allowing the natural cosmic Harmony to restore the harmonious blending of the element in the patient - just as it restores the Harmony of the Elements in the Sphere at the close of a cycle instituted by the initial disruption, imbalance, of Strife.

Applied sciences: Mathematics begins with the subordination of physical to logical in the point - or rather of ontological to logical in the unit; Medicine in the subordination of physical to psychological in the body as an 'organic' unity. Each science abstracts from any theoretical reduction of one order to the other (as, for example, the physical might be supposed reduced to the logical in Philolaus' system, or the logical to the physical in atomism). Their terms reflect, as it were, an actual economy of subordination of one order to the other, a movement, embodied in the poetic frame of activity, intermediate between the logical circuit of 'pure' theory, and the Kosmos which is its correlate. The appearance of theoretical medicine and mathematics at the same time as theoretical physics, towards the close of the fifth century, reflects that same circuit, that same poetic closure of theory, that is seen in Gorgias' dramatic exemplification of truth as dramatic. But like those other



frames of theory, newly defined within the common circuit of Reflection, these 'applied' theories are themselves articulated within the common figure of a 'theoretical' determination of the relations of Theory or Reflection, and its World or Kosmos.

(Enter Socrates)

Socrates: the unpaid sophist...

The logical circuit, which first defines 'theory' as pythagorean 'vision', the epiphany of Limit, has thus re-appeared within the frame of Reflection (simply as such) as various different frames of Reflection, various different 'theories', different perspectives, different directions, On walks Socrates. He hangs about the Agora, the market-place, the Forum. But he won't enter into any of these 'economies' of theory. He stands outside all these circular 'theories', yet constantly engaged in Reflection. And he stands outside the entry of Reflection into the market-place, in the form of the sophist's lectures, though constantly in the Forum. What is he up to?

He is always asking questions. Entering into all this circular thinking, like Zeno into the pythagorean theory: Dialectic - asking questions that in the end open up short-circuits of thinking, break the circle of confident assertion, and leave those authorities to whom he humbly submitted his initial questions uncertain of their parts...

... 'Know your self'. Socrates is the wisest greek, because he knows he knows nothing. The others, thinking they know something, have not even proceeded so far as to know nothing..

He stands for twenty-four hours entranced in the snow. He sends his young companions off to the various teachers to learn certain parts. He has a heavenly guardian who gives him direction at critical times. He wants to know some Good that lies outside the 'goods' whose values are only relative in the economy in which they are exchanged, one for another.

.. He stands, then, 'outside' the athenian 'economy', while yet marking this distance in that economy, with its component economies of contending theories (and theories of contention), as a question, a questioning. Just as Zeno had stood 'outside' the pythagorean economy of a logical narration of Kosmos, while yet inscribing his distance 'dialectically' in the frame of that narrative - as an opening-up of its logical circuit, a questioning. A questioning inscribed in that simple figure of the Question through which the dynamic of Reflection expresses itself

in the 'distance' between text or discourse, and context. A questioning inscribed, then, in the symmetry of a logically closed text and the open configuration which 'physically' reflects the organisation of the text, in the (or an) organisation of its context. As, in general, the outward unity of a spatiotemporal Kosmos reflects that logical circuit which constitutes Reflection as a domain 'within it' - and so induces a dialectical development of the relations of reflective text, and Kosmos as context.

A 'dialectic' which expresses itself in Reflection dramatically. As a sort of dialogue between thinking and its World. For although the formal figures of this development may, as here, be themselves reinscribed within the domain of Reflection, in a text like this text, they at the same time inscribe themselves - really, 'actually', in the organisation of Kosmos as context of this book, and of the books (in the 'Past' which is one 'side' of that context - what is 'closed' in it) which are formally inscribed within it. .. Not that we should, as I (rhetorically) suggested above, try and inscribe the relations of the discourses that lead from the early pythagoreans down to Philolaus in Philolaus' Kosmos. - Or that we should rather try and inscribe them in Democritus' converse physical order or World. Rather that we should take these two contradictory 'worlds' of Philolaus and Democritus (along with the inscriptions within them of the texts which define them) as two complementary actualities of the common figure of Kosmos, in which they each, in their converse ways, partake. As though each of these books, as they define a Kosmos, an order, and their place in it, introduces a new force into the interplay of 'worlds', and a new vision which is the human embodiment of that 'force'. A new 'element' into the drama of 'framing' that 'Kosmos' which is nothing but the constant 'outside' of each text in which it is framed. The identical 'outside' (simply insofar as it remains 'outside') of this text, of Philolaus', of Democritus' many texts, of Parmenides' poem, in which it appears in the figure of an all-embracing Sphere. - A sphere, as which, transfigured into four 'dimensions' (just as the 'circle' of Parmenides' discourse is transfigured into the closed circuit of the 'Knot'), the physical actuality of Kosmos re-appears at the close of the Tradition, to 'physically' frame this book.

Thus far I have suggested (rather than an inscription of the Tradition in Philolaus' 'astrology' or Democritus' 'physics' and physical psychology) a formal 'economy' of Reflection which is mirrored in the (contemporary with these) 'elements' as 'mathematical' economy. That amounts only

to a 'provisional' or anticipatory marking of one 'actuality' of Reflection (among an in principle 'unlimited' variety). This 'mathematical' fitting-together of various 'elements' in the Tradition - of abstract 'phases', 'cycles' ('periods'), 'steps', and the 'themes' or actualities these embody - with its simple 'logic' of 'inside' and 'outside' (the simplest physical opposition, this, in Democritus or Parmenides), of inscription of one phase 'within' another, down to the 'atomic' steps which embody the simple form of the theoretical 'step' - this 'constitution', this formal 'poetics' of the Tradition, I have not interpreted 'one-sidedly' from the logical perspective of Philolaus, or the physical perspective of Democritus. Somehow this 'mathematical' application of a common figure of the two theories - a formally equivalent frame - might be taken to embody some 'actuality' outside the mathematical organisation of the frame, in which 'logical' and 'physical', insides and outsides of texts, interact. But the interpretation of this abstract 'poetics' of the Tradition must be postponed until other themes have been developed, in terms of which it may be found some place in the relations of this text and Kosmos as its context, as context of our writing and reading.

Now that 'elementary' mathematics embodies, in one among various 'symmetrical' forms, the figure of that athenian 'economy' which I have just found Socrates 'dialectically' questioning. 'Outside' the common framing of these contending economies, and sophistic economies of contention, within the civic economy of an athenian 'world'. And outside the implication of government in that athenian 'economy', through the intermediary circuit of constitution and law (the primary civic theatre of contention), while yet 'dialectically' involved in that economy, as the inscription in it (like Zeno's in pythagorean Kosmos) of a ceaseless questioning, silenced at last only by Socrates' physical removal from the stage.

And what is marked, what is trying to express itself in this questioning, as Parmenides' Actuality expresses itself in the poetic economy of narrative, of the 'mark', by marking itself as 'outside' that economy?

- What but an actuality of government, direction, 'outside' that circular civic 'economy' in which the relations of economy and po-

litical direction are themselves determined within the general 'economy' of civic life? - Just as the actuality of a moral 'direction' expresses itself in the premonitory voice of Socrates' ἐπίμαχον, 'outside' the natural economy of his bodily constitution.

And what is the simple frame in which this actuality expresses itself?

- As the question of a Justice in whose frame true direction distinguishes itself from the open symmetry of this direction and an economy in which this symmetry is inscribed as an economy of law: the law of which this economy is one side, in and from whose symmetrical determination of their relations the 'other' side may distinguish itself.. mysteriously. Just as in the symmetry of the 'two sides' of Heraclitus cosmic Law, the 'direction' of Λόγος, of the Word, distinguishes itself, or in the fictional symmetry of narration and Actuality, Parmenides' Being distinguishes itself - if we choose, if we play our part in the scenario of this distinction, with dramatic 'truth'.

Thus the primary frame in which cosmic direction expresses itself in the earthly economy of Nature, is in the closed circuit of a Law, and in the 'constitution' of the group, framed in that Law, as a question. - It is the inscription of that question of Socrates in the wider frame of a later 'world' which defines, traditionally, the beginning of our Era.

So that Socrates dramatically marks the next step (after the integration of Reflection in the athenian economy) after the outbreak of the peloponnesian war, by acting - out his part in the 'mystery' of Justice. By embodying the dialectic in which Justice - in the marking of the formal distinction of its two 'sides', expresses itself in the civic economy of Athens as a question. - Or rather as the dramatic frame of the questioning, into which, as his part in the mystery, Socrates steps, in the early years of the war. Of the war that outwardly expresses the economy of an opposition of athenian economy and spartan political direction, in the wider frame of greek Culture as a whole.

→ A questioning, dramatically articulated over the remainder of the century: not inscribed in the logical circuit of some 'theory', in some discourse or book abstracted from its dramatic actuality (like these contending 'theories' whose interaction over this period parallels Socrates' activity). A 'step' comprising a 'dialectical' interaction of Socrates' questioning, and the actuality of some Good outside particular goods, the beginning and end of his questioning. An interaction in the dramatic frame of the athenian civic economy in which, through the integration in that economy of his questioning and its results, a certain poetic justice expresses itself, a certain dramatic truth.

- So that the actuality of 'direction' appears in the articulation over the period of that step (as that step, indeed), of the direction of Socrates' questioning, and the 'response' or responses with which, at each point, it meets. Formally, this amounts to the inscription of the particular questions that arise in relation to various 'responses', in the governing frame of the question of Good, as corresponding to direction itself as a question: the question of its 'end'. But Socrates' reflection is essentially 'applied': it is not inscribed within the question of the Good, as in the closure of some text framed by that question. That question, rather, formally presents the 'direction' of Socrates' questioning, abstracted from the response it meets with in its changing context. The actuality of 'direction' in Socrates' activity, in his questioning, presents itself, expresses itself directly, not as some 'abstract' reflection on the Good, but rather as the dramatic truth with which, in the particular configurations of discourse and context, Socrates plays his part. Plays his part of inquirer, according to a developing 'vision' of the implication of that part in the drama of Justice, which it is his part (precisely) to reveal, to induce to express itself on the athenian stage upon which he, Socrates, acts.

The closing scene, of which we have two accounts (those of Xenophon and Plato), two dramatisations, is played out in and around the court of Law, the formal embodiment of Justice in the athenian constitution. Socrates has been arraigned on two charges: Impiety (like Anaxagoras before him) - the introduction of new gods (his directing spirit or *διοτις*) and disregard for the state religion; and corrupting

the athenian youths who learnt from him how to ask questions, and, in particular, to question the formal authority of the state and its traditions.

Will Socrates be expelled from the body politic at this conclusive point in his career, like morbid matter from some hippocratic body? After all he has reflected in the body of the state just those outward conflicts of the war from which the state, under its new physicians, is striving to recover.

But Socrates will not countenance this 'outward' justice: the final question must be made quite clear: Socrates must embody in the court of Law/<sup>(and so in the state)</sup> the question of Justice. In judging the justice of Socrates' activity, Law, as the inscription of Justice in the civic economy of Athens, must judge itself. Socrates can only present the relation of Justice and its inscription (its marking) in the economy of the state, as a question. The last 'irony' is his stepping bodily into that economy as a question, as earlier he had presented questions in some more restricted frame, some component of the general economy of the City.

For Socrates himself, the question is simple: he allows that true Justice will decide what actuality will distinguish itself from the outward economy of psychical and physical sides in his past activity.

.. But Athens, as the corporate life of its citizens, is lost: she chooses the outward economy, which is only the semblance, the reflection, of true actuality.

(Plato leaves Athens for Megara)

How might the dramatic truth of Socrates' actuality, and the responding or corresponding Actuality of the Good, of Justice, be embodied in the logical circuit, the closed frame, of a text? - For then, in such a text, it might be instituted, actually embodied, in the frame of the World, of Kosmos: of a Kosmos then mirroring that text, and in which (then) this reflection could take its place, and play its part...

This question might be taken to organise the next step in this my dramatisation of 'The Tradition', just as the question of Justice has been taken as organising Socrates' 'step'. Two steps: First down to Plato's dramatisation of the question, 'What is Justice?' in his Republic (or State), and his attempt to institute this Justice in the context of that drama, that 'ideal' State - in the government of Syracuse. Then down through the later dramas to the last one, the Laws - in which an 'athenian stranger', almost Plato himself, appears, framing the question: How might one embody in the natural economy of an actual state, that circuit of Law through whose natural economy Justice might at last really (and, indeed, most naturally) express itself - or herself.

These two steps reflect, in a simple way, the articulation of Socrates' step, his activity at Athens during the war, the 'dynamic' of his unwritten questioning: The attempt to somehow logically 'contain', to define, the Actuality of Good, as it responds to Socrates' part of inquisitor, moves through a series of 'figures', frames, of dramatisation, and of inquiry. Each time a dynamic of question and response is articulated as a drama. First of all these are framed by some particular question, an inquiry into some particular good or 'virtue', ἀρετή. Socrates 'directs' the inquiry, questioning a group of his contemporaries (sophists - those 'teachers of virtue', and young athenian men, their pupils) - thus does Plato first attempt to abstract in a closed text from the direction of Socrates' questioning as it organised his activity from one situation to the next - and to define that Actuality <sup>which</sup> / this questioning evoked, as it expresses itself in those particular 'virtues', like courage or moderation, which should direct us in particular situations.

Then, perhaps around the time when he began to teach in the Academy park, and his own nearby garden, and after his first visit to Italy, the relation between this 'direction of inquiry, and the ἀρετή which should direct us, and which is its object, itself comes into



question: in the Protagoras, the inquiry finds behind different virtues a common actuality, which reflects the direction of inquiry itself: Virtue is Knowledge. Reflection, and the vision of Actuality it affords, as in pythagorean 'theory', determines its own actuality as that direction of inquiry whose object, the proper 'direction' of activity, is itself seen to be what articulates, as it were from 'above', the complementary dimensions (or directions) of this reflection and its formal object, posed as a question. It is seen to be what articulates inquiry itself.

One might suppose that the Apology and Crito belong to the same phase of development: Socrates, at his trial and in prison, practically confronts this same configuration of Reflection and the 'direction' of activity - from the 'other side', as it were, of abstract Reflection.

One might further suppose that the following years of teaching, up to the time of the second sicilian or italian visit, were directed by the elaboration of the 'theory' of the articulation of these 'two sides' of Reflection in that 'vision of truth' whose 'elements' Plato calls εἰδῶς, the actualities which articulate the converse logical and physical orders of our activity - which articulate its dramatic frame - and whose epiphany through the inscription of that frame itself in the logical circuit of Reflection (corresponding to our psychical self-assertion in this logical determination of the articulation of logical and physical orders, text and context) is Knowledge.

- And that the Republic amounts to a systematic attempt to 'articulate' in an extended inquiry, the two orders of Reflection and its context, in the primary dramatic frame of the state, as reflected in the dramatic frame of this 'dialogue'. This dialogue which in turn reflects, within the state in which it is composed, a Kosmos in which all states, in <sup>turn</sup> turn, must be constituted.

- So that the abstract vision of the Protagoras, and the corresponding practical situation of the Apology and Crito, here meet in an inquiry framed by the question, 'What is Justice?'

Does this vision amount to a reflection of Plato's direction of the young tyrant of Syracuse? .. Or does that project amount to an attempt to transpose the logical constitution of the dialogue into the

'constitution' of Syracuse, into the City as framing that interaction of which reflection (and its mirroring of the City in the 'logical' frame of dialogue) is but one side? Then Justice might begin to express itself in the City, as it had expressed itself in the dialogue, in that analogous 'frame' of intercourse. To express itself by articulating in the City the interaction of Theory and that cosmic Justice evinced by Socrates in the closing scenes of the Phaedo and Republic, and evoked in the earlier 'trial' dramas, in the Euthyphro, the Apology, the Crito. To thus take on, in some sense, the direction of affairs at Syracuse - and so of that Western Greece whose affairs were directed from Syracuse. To conclude the drama whose first part had been played-out by Socrates in Athens, with such a 'tragic' result.

Might we not take the Republic as marking a transition to the 'third part' of this socratic trilogy, which closes with Plato laying aside his mask in the Laws?

For Plato, returning to Athens, is faced with the recognition of the 'one-sided' character of his earlier reflection. The interaction of Reflection and that Economy of Nature in which the City must be constituted - their interaction in the dramatic frame of the City - cannot be determined simply within that logical figure of the subordination of physical to logical, the 'idea'. The actuality - the 'psychical' actuality - of this figure, is rather one side of a more radical actuality - itself embroiled in the 'economy' which amounts to the 'other' side of things. And to substitute this actuality of 'ideas' for that wider actuality itself amounts to only an idea - a dream.

How then might Plato find some.. account.. some figure, in which this interaction of idea and the 'economy' in which it is implicated, might find expression? As in the earliest dialogues, the situation is articulated as an open question (Gorgias, Theaetetus). Then, in a move paralleling that of the Protagoras, the dramatic frame of this question, the open mirroring of a psychical order of what had been called 'ideas' and the physical economy of their embodiment, is itself taken as the primary articulation - and self-expression - of this 'deeper' actuality (Sophist, Statesman). In the Parmenides (which I suggest might be regarded as the

attempt to write that Philosopher which was to have made the third part of a trilogy, with the two previous dialogues - whence the probable 'reference' at the end of the Sophist) the logical articulation of this frame, corresponding to that 'Dialectic' which is the science of science, the knowledge of knowledge, is worked out with formal exactness in the frame of that 'logical circle' which defines the 'logical' function, presented in the dialogue as a question - as the 'question of questions'. In the Philebus the 'dramatic' economy and articulation of this new actuality is worked out in the old frame of a properly 'socratic' dialogue. In the Timaeus, the outward 'cosmic' articulation of this more radical actuality is worked out in the form of narrative ( like those components of the earlier dialogues in which a scheme - an 'idea' - of the relations of ideas and their embodiment is worked out: such 'schematic' accounts are perhaps most closely integrated in the dramatic form of dialogue in the Symposium).

In the Laws, then, these three components - corresponding to those orders I have called 'logical', 'poetic', and 'physical' (and the 'cofinitary' actualities they reflect) - are articulated in the framing of that Law which reflects in the natural economy of an actual City or State, the relations of that economy of embodiment and the 'heavenly' actuality first glimpsed (only) as an 'idea', as the scheme or figure (~~σχῆμα~~) which had earlier led the 'athenian stranger' to Syracuse.

'Athenian stranger'? Where is Plato, that familiar athenian, to be found in this 'scheme' of development? Is it perhaps only an imaginary Plato I have found, following after my 'Socrates', as he stumbles after Plato's 'Socrates' - and he, perhaps, after Socrates' Socrates.. 'Who is Socrates?' asks Socrates, attentive to the pythian god, the god of questions (ἠεδομῆς); 'Who is Gorgias?' asks 'Socrates' (|).

What is the force, what the truth, the justice, of this schematic framing of 'platonic' themes? Am I to seek out the 'true' Plato behind the dialogues, some 'I' which would be his, to which I might suppose the logical circuit of the dialogues contracted, as to the intention, the meaning, behind them, giving them direction? But is that Plato? Surely Plato, as he expresses himself through the characters of his dialogues,

does not act as though that were Plato. Surely for Plato, that 'ideal' Plato must, like the psychical actuality of any other figure, be discovered in the natural economy of its - his - embodiment. - We must find this actuality as it enters into the articulation of the dialogues. If we are to agree with Socrates in the Phaedrus (1), the 'true' Plato of the dialogues is otherwise lost to us: the author's actuality, his direction, is only known in the dramatic interaction of open question-and-answer, known as an 'idea' might be known. Not at the end, indeed, of some endless analysis of texts (which from their very closure must always remain 'open' in meaning). Rather in the embodiment in dialogue of that figure of Knowledge, by which we know the psychical actuality of an 'idea': and by which we might, perhaps 'know' the 'idea' of our author here.

- It is just this actuality of the dialogues, this implication of the 'I' - of that 'figure' - as embodied by Plato as 'author' of the dialogues - it is that actuality of Plato which I would like to allow to express itself in this 'my' reading. For although we cannot, as Plato's Socrates might have wished, enter into an 'outward' dialogue with Plato, now that he is no longer embodied in the most usual way, yet we may still enter into a dramatic interaction with the 'I' of the writer as it is distributed through his texts. The figure of understanding which emerges resembles that 'justice' of my reading of pythagorean silence, which amounted to the discovery of the figure of pythagorean 'justice' in the frame of that 'reading'. That 'justice' was of course 'circular': but from it we have moved forwards to Plato - the natural questions that might be raised over that circularity by you, reading my 'reading', being reflected in the criticism of Parmenides which constituted the 'next step' of this inquiry. The question of the circularity of my reading of Plato will be seen, I hope, to reflect Aristotle's criticism of Plato and his immediate successors in the Academy - those 'pythagorising' platonists of the 'Old Academy'.

Now, then, I must briefly show the 'truth' - the 'platonic' truth - the actuality corresponding to a 'schematic' reading of Plato's dialogues.

How can I thus 'dramatise' reading Plato? Let us approach him by taking the simplest figure of our interaction - the text, or the texts in some supposed order - and take that as the frame in which to articulate our reading. I have already outlined an 'order' of reading corresponding to a preliminary tracing of Plato's self-assertion in the logical dynamic whereby the symmetry of text and context which constitutes the text as frame of questioning, and as question, is subordinated to the 'logical' order of the text, of reflection. Might the order be otherwise established? - Indeed it has been otherwise established in the Tradition in all sorts of ways. Let us see how the text responds to this initial assertion of the reader, the inquirer, defining himself as a reflecting 'I', simply 'outside' the text, in a context thus far established only in relation to earlier reflection - a context of Kosmos, City-State, 'Theory', Socrates' activity, and so on.

First, then: How does Plato, in this scheme - of an elementary articulation of the orders of text and context in a 'logical dynamic' amounting to the 'direction' of his reflection - how does he enter into this frame of Reflection?

After the death of Socrates, he leaves Athens for Megara (along with other disciples of the silenced Socrates) where Euclid, an erstwhile student of the Unpaid Sophist has a school. Euclid, in removing from Athens, has abstracted from Socrates' questioning a logically organised 'dialectic', much as Zeno had embodied Parmenides' criticism in first instituting 'dialectic' half a century before. - Euclid, indeed, combined the socratic dialectic with his own eleatic training. Other 'socratics' (most prominently the 'cyrenaic' Aristippus and the 'cynic' Antisthenes) emphasised other 'sides' or components of the socratic way.

Might we say that, following Socrates' application of dialectic to the various 'economies' of theory which competed in late fifth-century Athens - or rather, following that 'maieutic' inquiry of which megarian dialectic was an attempt to establish the logical economy - Plato first attempted to mark in the common 'logical' frame of the various contending 'theories', that *ἀρετή* which Socrates had found organising the everyday

activities from which all those theories were blind abstractions?

That would amount, one might say, to the application of dialectic to the megarian 'logic' itself - rather as Parmenides' traced the logical circle of pythagorean 'theory' in a Kosmos reflected in that theory.

'Virtue', ἀρετή: how to 'act'. The sophists taught young athenians how to play their parts on the legal and political stage of Athens - but they didn't even know what they were doing. Their knowledge extended to the mastery of some 'part' - but this mastery of illusions was itself only an illusion of knowledge. The 'teachers of virtue' are actors who do not know themselves - they give direction without knowing what directs their instruction (Io, Euthydemus). The socratic dialectic works back to question a 'circular' self-assurance whose logical economy partakes of the familiar figure of a logical determination of the relations of logical and physical orders - a determination from 'inside' a certain configuration of terms, of the application of those terms in their 'outside' context, an unthinking 'direction' of activity in whose articulation the illusory assurance of direction itself plays its part - by 'thinking' that it directs the whole activity. This ('logical circle') is already familiar in various manifestations from the circular pythagorean cosmogony criticised by Parmenides, down to Gorgias' presentation of truth as presentation.

A radical questioning leads back to the circularity of such merely formal assurance: in the end it leads back to the question: what, then is true assurance, what would be a knowledge which knew itself, which knows what knowledge is, and has a more than merely formal sureness? In a parallel dialectic to that employed against the poet and rhetorician, actors who do not know what they are doing, yet profess to teach it, 'Socrates' questions young men on virtues they seem to exemplify. They do know the virtues which direct their activity - they know how, say, courage articulates courageous activity, directs us in courageous action - yet what this direction is, they cannot say. The parallel line of questioning leads again to a confrontation with the poetic frame or framing of activity, itself exemplified in the dramatic articulation of the inquiry itself. Charmides, questioned on his σωφροσύνη his exquisite balance

or discretion, agrees that to know properly this principle in which the various parts of an activity, and of activity as a whole, are articulated and balanced, would involve knowing the articulation of knowledge as an activity. Here the question remains open.

And now the next step: the articulation in the frame of a dialogue whose protagonists are Socrates and Protagoras the sophist, of the assertion, following on the correlation of dialogue, 'virtue', and knowledge in the inquiry which leads towards the possibility of this step, the assertion that Virtue is Knowledge. - For those *ἀρεταί* which Protagoras would restrain in an irresolvable circular interplay, all partake in the common figure, scheme - idea - of Virtue, as articulation of activity. - And when this articulation is known simply as such, it is seen to be exactly that articulation of Knowledge or True Vision which sees it as such, and by which, then, we participate in virtue.

Now this marks Plato's step into the 'part' of assertion, analogous to that psychical actuality of affirmation or judgement, by which Parmenides' 'two ways' are distinguished at the Gates of Night and Day. Here, as there, the configuration of Truth or Actuality is radically dramatic: truth corresponds to a certain activity or direction of judgement, a participation in Actuality as what articulates the converse logical and physical directions of the poetic order, through articulating the conversion of the psychical and ontical orders reflected in those converse directions: one's true part is that 'psychical' subordination of the relations of logical and physical orders to logical distinction, as this subordination is articulated in a mystical or 'heavenly' order which, through this psychical actuality, and its ontical correlate, distinguishes itself from the earthly order of an economy in which the sophists' formal self-assurance is an empty reflection of 'psychical' vision or Knowledge.

In the Meno and Phaedo, Plato begins to work out the articulation of this 'reflection' of a 'heavenly' order in a blind earthly economy. I earlier suggested that the subsequent articulation of this 'reflection', in which Reflection in the narrower sense is one term (corresponding to the logical determination of the relations of logical and physical, whether in heavenly Knowledge or earthly Opinion) might naturally be supposed to correspond with Plato's activity in the Academy. The Protagoras had turned upon the question, 'Can virtue be taught?'. Surely the knowledge

of virtue (as knowledge) which there begins is just what Plato had formerly required (without quite understanding that virtue is knowledge) of the Teacher. And the dramatic dialogue in which Socrates now begins to assert himself must surely itself begin to be inscribed in a more open exchange of questions, of which it embodies the developing direction.

Socrates begins to assert himself (for example, in teaching the slave of the Meno - or rather eliciting from him the heavenly articulation of Knowledge). In his imaginary theatre Plato begins to introduce 'ideas', elements of articulation, corresponding to such a psychical force of assertion. If an 'idea' is taken to mark some instance of this heavenly articulation of Actuality, then one naturally wants some idea of the articulation of the various elements involved in the reflection of such 'ideas' in the earthly economy in which the dialogue is set. Following the initial direction of inquiry in which these 'ideas' first presented themselves, this articulation may be looked for in the very organisation of the dramatic frame of the questioning of the 'ideas'. And since such a scheme of questioning must be in some sense radically 'open', within the closed frame of a finished dialogue, so the only positive presentation of the figure developed in a dialogue, amounts to the embodiment of such a scheme or figure in the figure of a story, where that figure of story occurs in the dramatic articulation of the dialogue. Such a 'story', by participating (like Parmenides' 'story' or poem) in the heavenly articulation of the ideas, as it thus reflects this articulation in finite terms, thus partakes of the figure, the 'idea' of mystery, or of the 'myth' which embodies such a mystery. This 'truth' of myth is itself the question which dominates the Phaedrus which seems, in the development of this figuration of 'ideas' to directly precede the Republic (might the Cratylus intervene? - or does it not more naturally follow that central dialogue?).

Now is this scheme just traced mine, or Plato's?

Well, the construction, the articulation of Plato's terms in this 'reading', is undoubtedly 'mine', organised by my assertion outside



the texts in question. At the same time, though, I wish to suggest that this reading or construction mirrors in a simple way the articulation of Plato's writing. That the writing and reading are articulated as two sides of the text as question, and questioning - and that the 'schematic' elaboration of this form of the 'question', in my reading, is reflected by the part played by the 'scheme', *εἰσῆμα*, figure, form, 'idea', in organising the dialogues - in Plato's writing. Such a reading, then, amounts to a 'dramatic' participation in the platonic dialogue, as it were from 'outside' - and thus, perhaps, might be taken to reflect the teaching of Plato. - An eliciting of the actuality of that 'vision' or 'knowledge' ( *εἶδος* ) into which Plato steps, through the dramatic frame of the Protagoras. A dramatic truth, presented in the fictional frame of an 'ideal' dialogue, just as the truth so presented appears in the dialogue as the 'mythical' dramatisation of the scheme elicited in the imaginary dialogue.

'Well... that's very fine in theory...'

- Yes: and what is thus 'dramatised', brought into play, is just the working of theory, the organising actuality of this 'theory' - or 'vision' or 'knowledge' - its working in theory: for that very circularity, corresponding to the dramatic truth of pythagorean *θεωρία* is definitive of 'theory'. 'Theory', the vision which organises a certain actuality, by determining its own place in the actuality this 'place' or perspective defines. And in the Protagoras Plato, trying out the assertion of this vision in the imaginary theatre of question and answer, whose stage is set by the logical closure of the text, finds: IT WORKS!

- Well, it works within the theoretical, the 'logical' circuit of the text; it works in the 'education' which is an education of this vision, an induction of the questioning student into the circle of this 'theory' dramatised in the dialogues. It works within the School, defined or constituted, as it were, by this work or working of 'ideas', of Reflection, where the dramatic configuration of the socratic dialogue may be supposed to govern the interaction of its 'working' and the student's work, his laborious access to the workings of Actuality. How does this schooling work, though, in that more remote 'outside' of the circuit of ideas,

the City? It doesn't work quite as Plato might have hoped. First let us see how the circuit of Plato's early 'vision' works towards this 'outside', this dramatic frame of the City, from which the platonic Socrates has been abstracted, to tread the boards of academic theatre.

The question first arises of the relation of the circular vision, the 'knowledge of knowledge', 'vision of vision', to its context - for that 'psychical' actuality, corresponding to the logical distinction of 'logical' and 'physical' orders, is at once subject, in the economy of reflection, to the question of the outward symmetry of such a 'psychical' actuality or determination, and a converse 'physical' configuration which simply mirrors the logical circularity of the 'psychical' vision. Such a ~~mirroring - or 'reflection' -~~ led, for example, to the Parmenidean questioning of the pythagoreans' 'knowledge of knowledge' - and to the more radical actuality which distinguished itself from the symmetrical economy of this knowledge and its imagined object.

In the Meno and Phaedo the question of this symmetry of the physical and the psychical is raised: the 'natural' economy of this symmetry is inscribed, like parmenidean 'opinion', within a 'heavenly' order of which this natural or earthly economy of embodiment and sense is just one side, a pale mirror (like Parmenides' shifting fictions) of the Truth, which expresses itself by distinguishing itself from this inconstant mimic. This by articulating the psychical order of the soul and the ontical order of those 'ideas' which are distinct from their physical reflections, in a knowledge, an epiphany in the earthly order, of something 'outside' its economy, <sup>something</sup> mysteriously framed (Phaedo) in the figure of a 'supernatural' economy of incarnation. As in Parmenides' poem, Truth and Justice (knowledge and virtue) are two aspects of the same actuality of Heaven.

How, then, are these two aspects of the 'heavenly' order related? What is the relation between the 'psychical' actuality of Truth

and the 'mystical' actuality of Justice, in whose Drama of Heaven and Earth, of incarnation, the psychical actuality of the soul that knows that it knows, seems to enter under two aspects? If, in the Protagoras, Knowledge has recognised itself, in seeing Virtue as what articulates activity (including the articulation of this knowing of Knowledge itself, and so of Virtue), how now can this be extended (in the cosmic frame of the Meno and Phaedo) to a vision of the place of the vision of Truth, of Knowledge, in the cosmic scheme of Justice, the drama of incarnation? If the frame of Virtue has first been inscribed in Knowledge, how now can Knowledge be inscribed in the articulation of the dramatic frame of Kosmos, that is governed by the virtue of Justice - by that simple actuality of The Good, in the widest frame of activity? How make the step from the preliminary theoretical vision in which Knowledge is first known, into the wider frame in which reflection itself enters as one dramatic force or component, rather than a separate actuality. How get an 'idea' of the relations of the elementary 'ideas' to the figurative frame in which divine Justice actually expresses itself? How embody in the dramatic frame of a dialogue the mystery by which Truth expresses itself within the natural economy in which the dialogue is <sup>itself</sup> inscribed?

This question, which as naturally follows upon the figuration of the Meno and Phaedo, as that upon the discovery made in the Protagoras, and that upon the inquiry into particular virtues, is worked through in the Symposium and the Phaedrus. In the Symposium, the movement of this questioning is dramatised as an inquiry into Love: the inquiry closes with the inscription of this movement itself in the supernatural economy presented by Socrates as a revealed mystery. Love is the blind natural movement towards The Good, and its end is the knowledge of The Good in this movement itself. The end of the movement most natural to all creatures is simply the knowledge of that movement, and of themselves as participating in, possessing, absolute Good, in seeing their part in this scheme, governed throughout by the simple self-expression of that Good which stands 'outside' all earthly economy, all desires, all movement, by organising all that movement, by being in it unrecognised.

The dialogue thus exemplifies - in its own movement - this Good which is (as the object of Love) its apparent object. The dialogue is itself a 'mystery', of which the closing mystery is simply one component: The dialogue moves through successive accounts of this movement

towards what is good, dramatising in the dinner-party a common participation in the movement of the group towards understanding, until it concludes in the account of the knowledge of the heavenly articulation of this movement itself as the true possession of Good, the possession of - and possession by - Good, in Truth. Thus the reader is drawn into this same figure by the movement of his understanding, so that we might say that the Good expresses itself through the question posed by the logical or dialectical frame of the dialogue, as the dramatic force which 'transfigures' the natural movement of reflection, and illuminates that movement, as a movement towards the recognition of the place of natural movement in the scheme of which it constitutes but one side.

The scene then moves outside the City, into the natural economy of the countryside. The question now turns upon the same figure of the relation of natural and supernatural (or 'spiritual' or heavenly) orders of activity: and now the question of the function of the 'mythical' scheme which expresses this relation is itself raised (Phaedrus). What is the place of this scheme itself in the order it presents? The myth presents us as articulating our activity within two contrary movements - a 'natural' movement 'downwards', and a converse 'upward' movement. The 'goodness' of the story, like the goodness of the activity whose depiction in the story is one particular instance of such activity, must consist in a balance of these two movements - like the handling of two horses in a team - so that each plays its part in the overall scheme. - Such a balance is indeed exemplified in the dialogue itself, in its blending of Nature, Culture, and Heaven in its dramatic frame. It opens with the contrast of an elaborately 'cultured' rhetorical exercise, and the 'natural' setting of the drama. Culture does not consist in a sophistic abstraction from natural expression, turning in the artificial circle of a formal determination of the relations of form and content. True culture, as the frame of our activity, should play its part in the balancing of the two movements, of sense and reason. It should be rooted in a 'vision of truth', which begins (as in the myth) with 'dialectical' distinction and correlation of these two sides, and leads to the knowledge of the soul of men, and so of the interplay of the two sides in the community. And this community or group is the most natural frame of the exercise of dialectic and its 'vision of truth', the most natural stage of that 'philosophy' or love of the true knowledge which is wisdom, which

can discern and relate (as in the myth, and as in the distinction of the balanced expression of the myth from the artificial rhetoric of Lysias' eulogium with which the discussion has opened) the parts of sense and reason in love. That philosophy whose natural exercise lies, not in the artificial abstraction of a closed book, but in the open 'communication' of wisdom, which is the highest love.

What, then, are the implications of this recognition of the place of philosophy in the City? It prepares the way for the vision of the place of philosophy - of 'dialectic' in the highest sense, as the discernment of Truth - in the self-expression of the Idea of the Good as Justice; As the recognition of the correlation of the knowledge of virtue and the knowledge of knowledge in the Charmides prepared the way for the abstract vision of the Protagoras, whose development has led to the question of the place of philosophy in the scheme of a Justice which articulates activity in general, and this, in the natural economy of our embodiment, in the City as primary frame of our earthly activity.

The question of Justice as articulating activity - as the primary 'virtue' in which subordinate virtues may be inscribed, just as the activities they govern may be inscribed within the frame of activity in general - and the place in this articulation of the 'philosophy' which addresses just this question: this is the frame of the Republic. This circular vision of the theoretical determination of the place of theory in the World it defines or discerns, directly reflects the 'circle' of pythagorean  $\Theta\omega\rho\acute{\alpha}$ . We will shortly see how, in the Laws, the reflection goes so far as to reproduce in an ideal form the government of a city through a mystery grounded in a 'theory' whose first object is the order of Kosmos, articulated (as in the Timaeus) according to that science of composition discovered (as in the Parmenides) through dialectic, whose primary terms are the One and the Many.

What is Justice, this frame of Inquiry that has organised 'philosophy' from its inception? Leaving behind sophistical arguments, Socrates passes from the question of Justice as it organises the activity

of the just individual, to Justice as it organises the just constitution of the State from which - as its primary frame - the activity of the individual cannot be properly abstracted. - Any more than the philosophic inquiry into Justice, guided by the virtue of Wisdom, can properly be abstracted from the dramatic frame of reflection in dialogue.

Now the activity of a State, like the activity of an individual, has various components, various 'branches'. Indeed, in the State, the organisation of the activity of the whole is composed, precisely, from the component activities of groups of individuals - so that Justice must somehow consist in a mirroring of the articulation of the State and its activity, in the virtues, the just ordering of the component activities, of component individuals: the activity of the individual must correspond to the place of this individual in the constitution of the just State, and a major part of the organisation of the just State will thus lie in that Education by which (in the basic frame of the instituted 'myth' of the differentiation of places in the State, the 'noble lie') each individual learns his part in the activity of the whole, learns the 'virtue' which should articulate his activity, if the primary virtue of Justice is to articulate the activity of the State as a whole.

Now the primary frame of activity and interaction in a State is the constitution or Law which constitutes the unity of the State. There must be a group which preserves this unity within and without: the virtue governing this class of soldiers must be the Courage earlier discussed in the Laches. This Law is articulated in an otherwise open Economy, which is, as it were, the physical economy of the State, analogous to the physical economy of the individual body, which, like the horse which in the Phaedrus is always straining at the bit until brought under the sway of Reason, should be governed by the balance of  $\sigma\phi\epsilon\rho\sigma\upsilon\gamma\eta$ , already discussed in the Charmides and Phaedrus. Then, governing the whole, discerning the just articulation of the whole, as reason should govern the individual, should be a class who are themselves governed by the virtue of wisdom: this wisdom will perceive the Justice of the whole, and be its 'guardian', just as, in the abstract scheme of the Protagoras, knowledge, in knowing virtue, knew itself as wisdom, and in knowing itself knew virtue, the direction, the just articulation, of all activity.

How, then, is this governing wisdom, which knows itself as a participation in virtue, in Justice, to be instituted? What - that is to say - will be the 'education' of the governing class? This education will of course (as later in the Laws) be one of the chief concerns of those who govern: it is upon this institution of wisdom in the State that the whole must turn (and it is the question of realising the institution of this wisdom in the affairs, the general economy, of an actual State which is to prove in practice so intractable).

How can this Wisdom be drawn out of the child who is to play the part of guardian? What, in the natural development of reflection, will correspond to that mystery of Love (in the Symposium) which leads towards the transfiguration of this very movement, when it is seen as articulated by the Good of which its apparent object is but an image or reflection?

This education must also be an 'induction' into the mystery of the Good which thus articulates all movement and activity, through articulating those subordinate virtues which participate through Justice in the Good, and within these articulating those component actualities of which the vision is articulated in Wisdom. It must lead to the vision of the Good which illuminates this vision as the Sun illuminates the natural world which this vision leaves behind, as the image of Good in some good is left behind in the supreme good of philosophical participation in Good itself, in the vision which is Truth. This 'induction' must begin with a participation in natural order, the expression of Good in the ordered movement of gymnastic, and the applied poetic which is 'music'. Abstraction from this sensible image must then be effected through the discipline of mathematical figure, and then the last step, dialectic, the 'universal science', the knowledge of knowledge itself, will effect that 'turning around of the eye of the soul' from the images or shadows of Actuality, to gaze at the true Sun, to participate through the vision of Truth. in Good itself, that it may articulate, through the government of the 'guardians' thus enlightened, the only just order of things. As reason governs understanding, intellect sense, and knowledge opinion in the wisdom of the governing class, so will this wisdom govern the articulation of activity in the State through maintaining the balance of its direction, and the natural economy of the State, in the frame of Constitution and Law.

The inscription of particular activities within the activity of the State as a whole will reflect the inscription of the subordinate virtues in the supreme virtue of Justice, just as the virtue of Wisdom mirrors this subordination in the vision of its organising actuality.

Now the states which together formed the context of this, Plato's vision of the ideal articulation or constitution of the State, embodying Justice as the virtue of the State, in a frame of Law, were subject to great disorders (like the peloponnesian war). As Hippocrates had developed a systematic 'pathology' in terms of the disorders following from disruption of the proper constitution of the body, 'health', so now Plato develops a systematic pathology of the body politic, grouping parallel disorders of states, and of citizens' virtues, in accordance with their departure from the ideal articulation which alone embodies that Justice which is the Health of the State. A central and symptomatic disorder is the contemporary perversion of that elementary Education called 'music' or poetry. Whereas the ideal State or citizen is an image of Kosmos, ruled by Philosophy as Kosmos is ruled by the divine Wisdom in which Philosophy is our participation, in actual states that institution of such Wisdom which would perpetuate itself in wise education or induction into wisdom, is replaced by an art which, rather than seeing in the visible order an image of the invisible, institutes an economy of appearance by substituting for the vision of Truth an art of Imitation, a blind manipulation of the forms of appearance. Justice is turned upside-down: for philosophic abstraction from the economy of sense is substituted an abstraction from that philosophic Truth which was previously at least one side of the things around us. The craftsman participates in the natural economy of the State by copying in the visible order the actuality of some divine idea which illuminates his activity; but the poet and painter turn the proper relation of governing philosopher and subordinate craftsmen upside-down, by substituting for the vision of the divine idea a reflection or shadow of philosophic abstraction from copy to actuality, in the physical order of the copy. They mimic the vision of truth by copying what is itself already a copy of an idea (as, perhaps, in Socrates' Athens they make government merely one side in a general economy, rather than that political direction which determines (like the ideal class of guardians) the relations of political direction and natural economy, through the embodiment of Justice in Constitution and Law).



If, then, true political direction, the Justice of the ideal State, is lost, in fact - in particular states - in confusion, and a 'worldly' economy of management, where is the actuality of Justice, sought at the outset, to be found? The answer must lie in the wider government of the Kosmos, of which the government of a state, as primary frame of our mortal activity, is itself an image or reflection. The outward show of 'Justice' in actual states is itself only truly just, insofar as it corresponds to the articulation of the interactions of the individuals who together constitute the state, according to Justice as the virtue of the State, organising this interaction in the wider frame of Heaven and Earth, just as Wisdom in the ideal State organises the activity of government, within the wider activity of the just State as a whole.

This heavenly Justice, by which (rather than a sophistic identification of Justice with its appearance, with the blind conventions of actual deliberation) actual states must (or should) be judged, remains in its operation a mystery, since it relates to the wider cosmic order of which mortals know but 'this' side. Yet there is an analogue of the dialectical figure in which Wisdom, in knowing its part in the state, knows the Justice which assigns Wisdom this part - an analogue in the wider order which includes the Heaven of immortality to which this Wisdom effects a partial access, and the earthly economy of our mortal embodiment. This analogue is the moral assurance of heavenly government, which expresses itself in a vision of our part in the wider order of Kosmos, with its divine Justice. This vision of our part in the wider scheme, which can alone give sense to the ideal of Justice seen by the philosopher, presents itself in the figure of a story, whose 'poetic' articulation cannot be reduced to the dialectical form in which Knowledge knows itself in knowing Virtue, and Wisdom knows itself in knowing Justice, and its place in the just scheme of our earthly interaction in the State. Philosophy must in the end be assured of the justice of its vision, by seeing its place in such a mystery, such a 'myth': and the close of the philosophical account of the relations of Philosophy and Justice in such a 'poetic' figure (the vision of Er) amounts at once to the inscription of the primary order of Justice (from which the Justice of the State must in the end derive) 'in' a philosophic vision, and the inscription of this vision in the wider order of that Kosmos and its Justice. This closing figure, by which the divine order expresses itself in the order of Reflection, by marking in that order its difference from that order, is an analogue of the way

more emphasis to parallel of ideal & state towards the K - (X)

that, in Reflection, Knowledge knows itself in distinction from opinion. Again, Actuality re-inscribes itself in the parmenidean figure by which it marks, in the 'poetic' order, its distinction from that order - and so in the pythagorean figure of a 'vision' or epiphany in which 'theory' sees or knows its place in the order revealed in its vision.

Dionysius the Elder, who had entertained Plato at his syracusan court before the philosopher began to teach at Athens, died in 367. Dionysius, who by skilful manipulation of affairs had made himself master of Western Greece - Dionysius the patron of Aristippus, who, following Socrates in his unmasking of conventional wisdom, had concluded that activity should be organised directly in terms of the 'natural' and true economy of pleasure and pain. Dionysius the poet, who employed the best reciters, in pursuit of the olympian prize, but who had to be content with the athenian prize for his last tragedy. Dionysius whose son-in-law Dion (who was also his brother-in-law) called Plato (his earlier companion in philosophical activity) to make Wisdom the master of Syracuse, in the person of the dead tyrant's young son. But the wider theatre of Syracuse could not be conformed to the ideal drama of platonic dialogue, not least because the younger Dionysius was under the sway of Philistus the historian, whose views were in marked contrast to those of Plato and Dion.

In the Gorgias, the themes of the \_\_\_\_\_ last book of the Republic - the relations of philosophy and its \_\_\_\_\_ shadow in the State, and the part of Justice in this relation - recur. Might one see in Socrates' bitterness in this dialogue, most particularly in his confrontation with worldly wisdom in the person of Calicles, the frustration of the ideal presented in the Republic? - The confrontation of the philosophic ideal and political 'realities' at Syracuse?

Must rhetoric and the political economy it reflects get the upper hand in the actual state? - Or might one somehow bring into play the force of that moral assurance which gives the philosophic ideal its ultimate sense - bring that 'practical' assurance, which guides even the sophist Gorgias (contradicting his sophistic stance), into the dramatis-

ation of the conflict of dialectic and rhetoric (and the 'moralities' they reflect and embody). - A dramatisation of the dialectical distinction of these two 'sides' of 'the art of persuasion' which guides deliberation and so activity? - A dramatisation in which dialectic, distinguishing itself from its shadow, rhetoric, will give a moral assurance (will persuade us) of its value?

What is rhetoric? Who, what, is Gorgias? A rhetorical evasion will not do: Gorgias admits that the distinction of just and unjust which ultimately guides his activity as a teacher of rhetoric, is itself beyond the scope of his rhetoric. His disciple Polus must in turn admit that the distinction of Truth from Appearance, which is involved in the characterisation of rhetoric as a manipulation of appearances, is itself beyond the mere appearance of such a distinction. And Callicles' analogous representation of the economy of political activity leads to an analogous confusion - from which Socrates can then distinguish true political direction from this confused appearance, and proceed to the inscription of this dialectical distinction in the moral order of all our activity, presented as a myth or mystery of the divine judgement of our lives as a whole.

- So the first step towards a truly philosophical vision of the place of philosophy in the moral order of the actual society in which the philosopher finds himself is made. But although the place of philosophy has been thus marked, it has still to recover in this moral order of activity the figure of that knowledge of Knowledge already discovered in the abstraction of an ideal order. The philosopher practises knowledge, as Charmides practised balance - but he doesn't seem to know properly the activity of 'philosophy', its part in the actual interactions that together make up the activity of individuals. Does he only think his activity is knowledge...? Or can this 'dialectical' activity distinguish itself from that figure of opinion? (Theaetetus).

Well, knowledge can distinguish itself in a preliminary sort of way from opinion - and from the suspicion that it may only be the appearance of knowledge, and this on the analogy of the dialectical

distinction of dialectic and rhetoric in the Gorgias. For if, as Protagoras seems to have considered, knowledge is only itself an appearance, then where is the place for those distinctions which apply to all appearances, simply inasmuch as they are appearances? Indeed, how could 'knowledge' appear differently to Protagoras and to those who think that knowledge is something other than appearance? Even in terms of the simple economy of appearances, knowledge distinguishes itself from its inscription in this economy, and the appearance of knowledge corresponding to the assertion of the inscription of knowledge in this economy is shown - in its own terms - to be false. Nor can we merely say that knowledge, then, is simply 'true' opinion: the distinction lies outside the economy of these terms, of 'true' and 'false' opinion. There must be, even in the economy of these terms, something which distinguishes true knowledge from true opinion: there must be something in it which knows this distinction, which can give an account of its distinction from the mere play of sense, and its economy of opinion.

Such an account is sketched in the Sophist and Statesman, which continue the argument of the Theaetetus in the same dramatic setting, and which anticipate a third component of the trilogy, a Philosopher. In the Sophist an account is given of the distinction of Knowledge and its sophistic shadow; in the Statesman this distinction is applied to the way such knowledge might serve in the articulation of civic activity: a frame of 'policy' in distinction to the sophistic economy of opinion. I have already suggested that the Parmenides might be considered as the eventual form of the unwritten Philosopher, presenting as it does the formal frame of the 'dialectic' announced in the Sophist and Statesman, but in abstraction from the dramatic order of those dialogues. And I have suggested that this 'logical' presentation of the formal frame of philosophy is complemented by the ('cosmological' frame of the Timaeus (presented in that form of a 'story' which corresponds to this limiting frame of Heaven and Earth). These two components, together with the discussion of the relations of reason and sense in the individual that appears as the Philebus, are finally integrated, then, in the civic frame of the Laws (apparently published posthumously). This correlation might then account for the interruption of the Critias - the passage from that

'mythical' account of a 'working' ideal (an ideal state seen 'in action') appended to the Timaeus (itself <sup>purporting to</sup> begin as a continuation of the dramatic frame of the Republic), to the 'practical' project presented by the 'athenian stranger' in the Laws.

Such then, I imagine the organisation of that second exemplary 'step' in the Reflection of the fourth century - from the scheme of the Republic to that of the Laws, and the three 'dialogues' (of which two embody the 'dramatic' form almost as a mere formality) which I take to prepare the presentation of the latter. Apart from the schematic relations already suggested, I believe this relation of the Timaeus to the Laws is amply corroborated by Laws VII, 821-2 and book X, not to mention the probably non-platonic Epinomis or appendix to the Laws. I think the association of the Parmenides with the Timaeus and Laws in such a scheme is rendered more probable by Laws X, 893sqq <sup>XII, 965-8</sup> but like Timaeus at the beginning of his schematic presentation of Kosmos, I only claim that something of the sort, some working of this order, is surely involved, even if many of the details be questionable.

Working? How might it 'work', how might something like this scheme of development be 'at work' in these later(?) dialogues?

- Well, in a way analogous to that by which I suggested the 'scheme' of reading was reflected in the working of the figure of 'scheme' in the earlier dialogues - a scheme somewhat shattered after the Republic. For might one not find, succeeding the formal 'scheme', the idea of the 'Idea' (and of other figures - indeed a play of 'figure') of those earlier dialogues, the question of the working of such figures - the working, for example of the figure of something which distinguishes itself - in the 'economy' of figure itself (the formal inscription of one figure in another, as 'knowledge' in 'appearance') from the figure of such economy?

Now I have suggested that the Gorgias and Thaetetus have left us (and Plato - or 'Socrates') with the question posed by the figure of the 'account' that Knowledge must give of itself, if it is itself to be properly known as distinct - as distinguishing itself- from appearance

and opinion.

In the Gorgias and Theaetetus 'dialectic', which distinguishes the true nature of things, has been distinguished - dialectically - from the sophistic rhetoric of Gorgias and Protagoras, which only appears to truly distinguish things (as, for example, truth from appearance, or knowledge from opinion). To understand dialectic properly - to know the activity of knowledge according to the figure of knowledge as true opinion which can account for its truth (with which the Theaetetus has closed), we must account for its distinction from sophistic appearances of truth. What then is a sophist, and what is the true account of the distinction of true and false, which will allow us to dialectically distinguish the knowledge corresponding to dialectic from its sophistic imitation?

- Let us proceed dialectically. Where should we start? Why not with the 'artist' of the last book of the Republic: then we may make a primary distinction between 'the' Creation, as the Art or Production of the Scene in which other 'arts' are exercised, and these arts themselves as embodying within the all-encompassing Art of Creation, the same figure of Art. This distinction is then simply correlative with the figure of Art (we might even say the divine artist embodies this distinction of divine example, and copy, in his Art), and we need go no further back, to distinguish this distinction itself.

But 'arts' have many aspects: how can we proceed best to track down the Sophist amidst all their differences. We risk getting lost in his very manipulation of distinctions. ..But could we then take that mere appearance of distinction, opposed to a distinction properly known, a true distinction, as characteristic of the Sophist's art?

Ah: now the Sophist confronts us. But we are immediately lost again, as this distinction is itself lost in the play of sophistic distinctions it was to mark. How can we stand outside this play of appearances? For the Sophist draws us in as soon as we try to mark a distinction between an 'inside' and 'outside' of that play, of appearance. How can we know the mere appearance of knowledge, if knowledge is itself to be distinguished from this appearance? If we are to be 'outside' this appearance, which is an appearance of nothing, then how are we to know

it? For then it will have to be something after all - or our 'knowledge' will itself be of nothing, and so itself a mere appearance of knowledge, a mere appearance of a distinction from appearance. Almost less than nothing - since the Sophist happily moves about in the play of Being and Nothing, quite happy that this is itself Nothing. He seems to know his way about in the play of appearances, yet we are entangled in his net, having thought we were catching him in it.

Let us try and get some new bearings. Let us see what is fixed in all this, like the constant frame of differences in - among - appearances, marked in the Theaetetus. - Well there is the difference between what is fixed and what is moving or changing, for a start. These - 'Rest' and 'Movement' are everywhere at work - they are what they seem: this is there working, their actuality, their Being. And they are different from one another, and so, also, different from Being: for in relation to their Being they are the Same. .. And this Difference is itself different from Being: that is its very Being. So that we have found something which we can know as not-Being. We can draw a sketch-map of the Sophist's maze, and trace the sophistic circle in which we had become lost. Being distinguishes itself from the many things which are different from Being: there are many varieties or ways of not-Being. We cannot simply make a distinction of Being and not-Being 'in' Being, and contain the Being and Knowledge of all distinctions within a fixed domain of Being, Rest, Sameness, and so on. For then indeed there will be nothing for these, and for knowledge of them (these 'ideas') to distinguish themselves from. At the same time, we need not simply conclude that such Being, fixity, is - as Gorgias and Protagoras would have us believe - the illusion of illusions, the pathetic mirror of he who does not see that it is he, and nothing else which properly 'asserts' itself in language. This distinction of Being and not-Being cannot be separated, as Plato had earlier dreamed, from the play of appearance: but it can distinguish itself, in the poetic order of that play, from a purely circular play, in which nothing, except in appearance, is fixed (in which Being is Not-Being - a play whose 'essence' is not-Being). Being distinguishes itself, in the play of Appearance, from Appearance. And it frames this distinction in terms of the difference of the 'logical' opposition of Same and Different, from the 'physical' opposition of Rest and Movement. Being logically distinguishes itself (and so 'ontically' expresses itself) from Appearance, by distinguishing between this difference, and its complementary logical and physical ap-

pearances or images, reflections.

Thus, then, can we attain to a 'working' knowledge of not-Being, an 'account' of the distinction between Being and Appearance, and so of the distinction between Knowledge and its sophistic imitation or image or 'appearance'. We can begin to know the working of Knowledge in practice, as we had already known it 'in theory'.

What then, in the simplest terms, is the distinction we have discovered?

Well, in the simplest terms, we have found a frame in which Knowledge - of what is - distinguishes itself from the apparent knowledge whose object is not as it seems. This frame is articulated relative to the being of one 'class' (like Being, Difference, and so on) 'in' another. Truth amounts to the knowledge of Being, in the correspondence of the 'logical' inclusion of one class in another, with the 'physical' inclusion. Opinion is the 'silent assertion or denial' of such a correspondence in Thought, the 'silent speech' in which the logical relations of terms or classes are articulated. Imagination is a sort of inward play of correspondences (1).

Sophistic, then (finally) is the human (rather than divine) art of creating the appearance - by thinking to deceive - of knowledge, by presenting false opinion, which does not correspond with what is, as if so corresponding.

What 'art' would best express the implementation of this newly won Knowledge? What 'theoretical' art would be the true form, of which the sophistic 'production' of illusory authority is the false? What is the true place of dialectic in human affairs?

The inquiry will itself serve as an elaboration of the new dialectic, moving towards a fuller understanding of itself(2). Indeed Plato seems, as he writes the Statesman, to be playing-out this drama of dialectically finding the true place of dialectic in the wider frame

1: Sophist

2: Statesman



of activity as a whole - using the rather unsure first steps along the new way as illustrations of the true dialectic as a movement towards understanding of this very movement (this then mirrors the more 'ideal' mystery of Love as it presents itself in the Symposium).

Let us, then, start out again from 'Art'. The 'divine' analogue of the 'artist' we are seeking will articulate the 'physical' frame of Rest and Movement within a Knowledge correlative with the Being of this frame itself. Now supposing that we find ourselves on an Earth whose confusion is analogous to the sophistic maze in which we were earlier lost? (Plato gives a 'mythical' figure or account of the origin of this confusion in the divine scheme). Who is to find order in this confusion, as we have found order in the Sophist's part in this confusion? - Why the Statesman, the 'shepherd' of his confused flock, who imitates the divine shepherd already evoked. This is the true Statesman: the many 'statesmen' who simply assert a specious authority in the economy of Opinion which is the frame of most societies are themselves, properly speaking, a variety of sophist.

These operate within the fixity of those 'laws' which are the nearest one comes, in the confused order of the mere appearance of Authority, to true direction: but Law itself is properly a part of Policy, a part of the art of the Statesman. True political knowledge would determine the part of this frame of activity in the articulation of the activity of the state as a whole. - Just as dialectic finds the frame in which Being and Appearance are interwoven, and the divine Ruler expresses himself in the outward articulation of all things in this Frame, as Kosmos. The royal science of the Statesman must determine the part played by all subordinate sciences within their own departments, within certain spheres of activity whose correlation must be determined 'outside' these particular sciences, in the coordination of all activity as a whole. In particular, the Statesman must 'weave together' the virtues of courage, say, and temperance, whose domains often overlap: Courage will determine such an opposition of virtues according to its limited image of Virtue, and temperance will succumb, and the balance of activity as a whole be lost. The Statesman's virtue of Knowledge must determine the part in the activity of the State as a whole of such opposed virtues. It is a virtue of measuring the part of all the components in the whole. Most particularly,

the Statesman must apply Education throughout the economy of the whole, thus developing virtues and arts according to the parts they are to play in the articulation of the State within a constitution governed by the primary virtue of Knowledge, expressed in the political art of the Statesman himself.

Turning, now, to the individual as he enters into this frame of activity - what moves him, in his part in that activity? What should move him, what is the true Good towards which activity should be directed? Philebus says: Pleasure - and we find ourselves once again lost in an economy, a play, of appearances. For what is this 'pleasure' that we are to seek? How could we seek Pleasure itself, rather than competing pleasures? Is there one Pleasure we might seek in all things? Or is pleasure not, rather, a constant movement towards what appears good, and true Good rather the 'end' of that movement in Being and Knowledge, Wisdom? Then the highest good might seem to be dialectic knowing itself as the end of this movement of trying to Know...

But we must find the places of this good of knowledge, and the apparent good of pleasure dialectically - see how they are at work in the frame of the individual's activity, just as the Statesmen has discerned the different parts of individuals in the wider activity of the State, and just as some divine Knowledge seems to organise the various parts of that still wider Creation comprising State and citizen together.

Now the principle which distinguishes itself from the indefinite play of aspects or appearances one might call definiteness, Limit, finality (*τέλος*). That from which this principle of Being and Knowledge distinguishes itself one would then call Unlimited (*ἄπειρον*), always Different, always, like Pleasure, in transition from one thing to another, in the open economy of what appears good from one moment to the next. Always partly deceived by this appearance, and so always mixed with that Pain which is the absence of good, the passage further into the play of transitions towards what is good. Then we might distinguish between 'true' pleasures, which do indeed lead towards good (as true opinion leads towards knowledge) and false pleasures, which under the appearance of good

lead away from true good (in this analogous to the false opinion presented by the Sophist as knowledge). Then the frame in which the Good thus distinguishes itself as the object of true pleasures might be said to combine Limit and Unlimited as two 'sides', the frame of that 'measure' or 'Symmetry', by which the Unlimited is limited - as in the subordination of the unlimited opposition or difference of Limit and Unlimited to the form of distinction or Difference, negation. And in this frame of Symmetry we may see (then) an activity in which the opposed goods of detached Knowledge and restless Pleasure are seen to be two sides, each incomplete, but Knowledge dominant. This activity, which is Reason, is itself the true Good, in which the subordinate goods of Knowledge and Pleasure each find their part. And just as we find the principles of Limit and Unlimited as two sides of the activity of Reason, directing the activity of the individual, must we not see the activity of a 'royal Reason' in the symmetry of the Kosmos in which we have the exercise of Reason, just as we see in this Kosmos in a more systematic form those principles of Limit and Unlimited which give our bodies order and matter?

Reason thus frames the Law which is the inscription in Limit of the unlimited difference of Limit and Unlimited. Good itself, then, the primary activity or actuality of Reason, is the eternal Harmony of its three aspects of Truth, Symmetry, Beauty. Corresponding to Beauty as the sensible appearance of this actuality, one may consider the part of pleasures in the Good. Unmixed pleasures, the principle of Limit expressed directly in the domain of Unlimited, of that movement which is Pleasure, may be admitted; these take three forms corresponding to the triple aspect of Limit-Mixed-Unlimited, of which the highest, suggests Socrates, is that derived from mathematics. Mixed pleasures, corresponding to those false pleasures arising from a configuration of pleasure and pain combined, are not to be admitted. The parts of Knowledge are similarly divided into mixed and unmixed sciences and arts, 'applied' and 'pure'. And the highest of all sciences, coming above geometry and arithmetic, as the nearest approach to divine Reason itself, is dialectic, the science of Limit itself, reflecting Limit <sup>in the mirror of</sup> that pure Reflection or unmixed Knowledge which is the part of Limit within the domain first distinguished as Limit itself.

\* \* \* \*

Limit, the principle of Being and Knowledge, distinguishes itself from what it <sup>in the mirror of</sup> thus determines as Unlimited. This activity of Limit

is itself reflected in the unmixed or 'theoretical' sciences, whose object is that Symmetry which frames Kosmos, the inscription in Limit of the frame of distinction; of the principles of subordination of Unlimited to Limit. In a third movement, dialectic then determines the principle of distinction of the 'logical' order of distinction simply as such, <sup>from</sup> the 'physical' order of a geometrical Kosmos, of Space. This through the frame of the arithmetical symmetries of Identity and Difference, One and Many.

In the Sophist, Being has distinguished itself from Non-being. This, not by an identification of Being as one side of some opposition of Being and Non-being, an opposition which would itself have no being, and so lose the identity of Being in the play of merely apparent distinctions - rather as what, in this play distinguishes itself as the other side - as 'out'-side this play, and so inscribed in it. Being enters into an interaction with Non-being, as a movement or activity of distinction in which Being or Identity is itself 'constituted'. Most particularly, the 'being' or identity of the opposition of Being and Non-being is itself found to be 'logically' determined as 'Difference'.

In the Philebus, just considered, is traced a parallel 'activity' of Knowledge - the 'constitution', one might say (again, perhaps, on the further parallel of the Statesman) of Knowledge as the Rest which distinguished itself from the Appearances of Rest, <sup>of</sup> an End (a 'good') which, in this 'rational' movement of distinction it knows as the Movement of Pleasure and Pain.

What, then, is the common 'activity' or Actuality, in which these parallel constitutions of Being and Knowledge partake? What is the common principle by which the Classes or Ideas of which Being and Knowledge are two sides (we might say, the 'ontical' and 'psychical' sides respectively, corresponding to the 'logical' distinction of Same and Different, and the 'physical' distinction of Rest and Movement) distinguish themselves? What is the Actuality in which the activity of Reason might know itself as the 'dialectic' which is the (or our) psychical participation in this Actuality? How - that is - is the figure of the Protagoras, Knowledge knowing itself in knowing Virtue (the articulation of our activity in which Knowledge itself, as activity, participates), to be transposed into the frame opened up in the Gorgias by the 'dialectical' distinction of dialectic and rhetoric?

We cannot simply begin with the distinction of Idea and instance, with an opposition of the actuality of the Ideas and their reflection in the play or economy of Appearance. - This no more than we might begin with the analogous opposition (in the Sophist) of Being and Non-being: this formal opposition is nothing, is not 'in' being, thus marked. We cannot simply determine the primary opposition of One and Many, Being and Non-being, Knowledge and Appearance, Same and Different, Rest and Movement in terms of 'ideas' of One and Many, within which frame the Actuality of the Idea can then in turn be worked out. For the 'Idea' or 'Class' itself is determined as One identity in its Many different instances, and the formal opposition of 'Idea' and instance, taken to define Dialectic (as the parallel opposition of Being and Appearance was at first taken, in the Sophist, to define what is known in dialectic) at the beginning of the Parmenides, is at once lost in the play of subordinate distinctions (One and Many, Same and Different, Rest and Movement) which were at the outset supposed to have been inscribed in the primary dialectical distinction of Idea and Instance.

Where on earth, then, can we begin? How can the eliciting of Being as an activity by the Eleatic Stranger who takes over from Socrates the direction of inquiry in the Sophist (and Statesman) be extended to <sup>the</sup> the Actuality, the mirroring of Knowledge and Being in those Ideas or Classes in terms of which the Being of the Sophist is expressed? We have made a ~~simple~~ 'abstraction' in the Philebus, first from the opposition of Rest and Movement to the framing of this opposition in Knowledge; then from this two-sided Knowledge of changeable and unchangeable to the 'mathematical' frame in which these two sides are integrated according to Measure and Symmetry - then, finally, to the 'dialectic' which, as one side of this mathematical frame, itself is to determine the opposition of the two 'sides', in which mathematics itself is constituted. What, then, is this 'dialectical' opposition of Idea and - what? - in which the dialectical Idea distinguishes itself as one side? We may work back to such a formal determination of the Actuality of Ideas; perhaps this Actuality may somehow be known, as in the earlier socratic dialogues, by our participation in it. But, asks Parmenides, how on earth is this Actuality to be distinguished from the play of distinctions, in that play? Where can we begin? How will we find these 'Ideas' at work in

the economy of distinction, the 'sea of words' (1) (as Being was found 'at work' in the play of Appearance, in the Sophist)?

Just as Being was found 'at work' in the Sophist, in the frame of the formal opposition of Being and Non-being, with its two sides of Same-Different ('logical') and Rest-Movement ('physical'), so now will that Actuality of which this Being is one side (the other being Knowledge of such Being) be found 'at work' in the more general 'eleatic' frame of One and Many. This One and Many will not be determined in terms of the dialectical distinction to be discovered 'at work' in the frame, any more than the distinction of Being and Non-being could be determined 'within' Being as one side of the distinction. Just as Being was found to distinguish itself from the nothingness of the formal opposition of Being and Non-being, so must Actuality distinguish itself in what will turn out eventually to be the spatiotemporal (or 'geometrical') frame of the Timaeus, and this through the duality in the common frame of One and Many, of the unitary Actuality of the Ideas, and the spatiotemporal multiplicity of their instances.

- So to what is with little doubt the most obscure section of the platonic corpus: Parmenides' dialectical exercise, with the young 'Aristotle', as respondent, that constitutes the second part of the Parmenides, following the question opened up in the first part by the inadequacy of any formal distinction of Idea and instance, the question of the Actuality of the Ideas, of which Being and Knowledge are two complementary sides. Obscure: for how can we get any purchase upon an argument which opens in the questioning of Distinction simply as such? How apply any subsequent distinctions to elucidate Distinction in search of itself? Let us rather try and find Distinction itself at work in the sea of words...

'...most people are not aware that this roundabout progress through all things is the only way that the mind can attain truth'(2)

Parmenides traces a circle of distinctions, one distinction 'in' another, the reverse, and the distinction of these.. leaving at last the question of the distinction of Actuality from this formal play of 'in' and 'out', as it enters into this play, the economy of this dia-

lectical circle.

First then: One is seen to be 'outside' all distinctions: not at rest, not in motion, not the same, not other.. not in being, not in time, not in knowledge (137-142)

A transition is made to the second part of the exercise - One is seen to be both One and Many (142-3).

A new direction is taken: One is seen to be 'in' every term of those oppositions which it is also (above) 'outside': it is in itself, and not; in rest and in motion; the same and other of same and other, like and unlike (that is, same and other in some respects); equal and more and less... in time, in being, in knowledge (143-155).

'Yet once more, and for the third time..' (1), what now follows from the 'two sides' of the exercise thus far? One is both in, and outside, every distinction. This dialectic of 'in' and 'out' is now articulated. Articulated first in relation to Time and Appearance, with One at once 'in' Being and not (155-166).

And so, from the working-through of the 'two sides' of the One, examining their articulation, and then integrating these, in a configuration thus invariant in all distinction (which thus distinguishes itself as frame of Actuality, or the 'working' of distinction), Parmenides concludes:

'..let us say that, whether one is or is not, one and the others in relation to themselves and one another, all of them, in every way, are and are not, and appear and appear not' (166).

- Actuality is not simply 'Being' in opposition to Non-being or 'Nothing': it is rather the activity in which Being distinguishes itself from Nothing - and we play a part in this distinction, presented to us as a question at the close, in the closure, the configuration of this limiting text. How are we to read it? As Parmenides points out to the young Socrates, the distinction of the Idea as Actuality from the formal distinction by which this distinction is expressed, cannot be conveyed, 'imparted' in any definition. Such a definition can only

repeat the formal distinction from which the Ideas are to distinguish themselves, or be distinguished (this, at least, is 'formally' obvious). How then is the Actuality of the Idea to be imparted? - By an involvement of he<sup>to</sup> whom the Idea is to be imparted in the activity of the Idea, in the activity of Reason, in which formal Reflection is transfigured, as it sees its part in this activity - just as, in writing this 'ocean of words' in which Plato's 'sea of words' is but a little drop, I am trying to transfigure my 'part' of writer in the formal configuration of writing and reading, as it enters into an Actuality which transfigures your part of reading. Is Plato involved in this same business of widening the frame in which Actuality, as the coordination of Being and Knowledge as Activities, can express itself? His successors in the Academy allowed their reading of Plato to partake of such a frame. Aristotle, on the other hand, presents us with a 'formal' reading, most particularly of the Parmenides, and in this institutes another Schol - indeed, indirectly, two Schools: the Lyceum, and its more important progeny, the School of Alexandria. But before we turn to these, we must consider another exemplar of the Ideas - the Kosmos presented in the Timaeus, connected with the Parmenides both internally (37-8) and in the sections of the subsequent Laws already alluded to above.

In the Parmenides, the 'logical' or dialectical circle, seen in its minimal form in the distinction of Ideas as principle of distinction, appears as a question. The question, one might say, of the Actuality in which Being distinguishes itself ('ontically') from Non-being, and in this is known by a Knowledge which - in this - distinguishes itself from a losing-itself (or -ourselves) in the unlimited play of Appearance (that Movement where the End is itself always moving, changing). What is the context of this Question, in which its circuit is inscribed as the Parmenides? How is this logical circuit itself to be inscribed (found 'in') the configuration of Being and Appearance framed in the distinction of One and Many, with which - marking which - it closes?

To put the question in another way: How does the distinction of the text and its context, the 'in' side and 'out' side of the words, itself enter into the figure of Distinction which is 'in' the text?

Might we not see 'in' the Timaeus the other side of this quest-



ion? For there the text, rather than being articulated in a primary dialectical Distinction as a Question, begins almost (37-8) with the initial configuration of Actuality. Instead of working back to this Distinction as Question, it moves forward, in the formal frame of this same Distinction to the Man who can ask the Question. It begins with a configuration of terms marking the resolution of the Question: with a coordination of the 'logical' and 'physical' orders of 'in' and 'out', which necessarily partakes, as Timaeus readily admits, of the figure of a fiction, a 'story' (for as we saw in the Parmenides, there is nowhere, 'logically' to begin, no initial distinction in terms of which Distinction might be defined, identified). Within this 'poetic' frame of a 'physical' resolution of the symmetry of logical and physical determinations of 'in' and 'out', distinctions are then articulated, one within another, until we finally rediscover in this 'physical' order of Kosmos the 'Image' or most perfect Copy of that Actuality of Distinction with which the Story, the Cosmosology, begins. The circuit of narrative in the Timaeus thus mirrors the converse movement, in the Parmenides, from Socrates' image of the distinction of image and Idea, to the inscription of this distinction in Distinction itself as Question. And these two converse movements, these two limits (as it were) of Actuality as self-expression, will be found to be integrated in the dramatic frame of the group, as presented in the Laws. Furthermore this integration will be seen to bring full-circle the opening configuration of Kosmos (in this my 'story') in the pythagorean mystery. For the logic of Distinction of the Parmenides, the Kosmos of the Timaeus, and the governing circle or Council of the Laws will be seen to amount to a direct reflection of that initial mystery, in the frame of that economy of 'theory' that typifies Reflection at the opening of the peloponnesian war. The scene will thus be set for the recurrence of 'mathematical'  $\Theta\epsilon\omega\rho\acute{\alpha}$  in Plato's immediate successors at the Academy, and Aristotle's complementary abstraction from the 'mystical' circle of  $\Theta\epsilon\omega\rho\acute{\alpha}$  to a systematic economy of Theory, inscribed in the formal resolution of the Question posed by the Parmenides: in the opposition of 'Actuality' and 'Potentiality' framing the logical narrative of The World.

What, though, more exactly, is the scheme or Kosmos, arrangement, of the Timaeus? How, in outline, does it amount to the converse - indeed the 'conversion' of the logical or dialectical configuration of

the Parmenides? The question in which the Parmenides is articulated we found by considering the part of dialectic in the activity of the individual, as presented in the Philebus. The primary activity or actuality there corresponding to the principle of Distinction mirrored in dialectic, was the divine Reason, reflected in the finite reason amounting to the activity of knowledge, as determining the parts of Knowledge and Pleasure in activity directed by true Good. The cosmological narrative of Timaeus begins (then) with the initial configuration of this Reason expressing itself by 'setting in order the disorderly play of Appearance' (1) in relation to Good as the End of this activity, this order. Reason, correlative with Being, is not opposed to an 'abstract' Nothing, as formal opposite of Being in an empty opposition. Rather is such an opposition (as in the Sophist) an element of the Non-being, the disorderly play of Appearance, from which Being distinguishes itself - and in which Being distinguishes itself. Creation, as in earlier 'mythical' cosmogony, is from Chaos: formal Nothing - rather than protean actual Nothing - appears only in a later phase of Reflection, which imagines itself quite abstracted from its own actuality.

- We should not, however, take this Creation 'out' of Chaos, as amounting to a 'World' in which the World comes into being. Rather does it correspond to Actuality distinguishing itself, within the free play of Figures as 'outside' the primary 'open-ness' of that play - as Being distinguishing itself from the Nothing of the formal distinction of Being and Nothing. And this not at some point 'in' the play of 'in' and 'out', the formal economy of inscription and exclusion: for such a 'point' fixed in Space and Time is correlative with this primary distinction itself, in which the further distinctions that compose the self-determining order of Kosmos are inscribed - according to the various figures of such inscription. It is just this 'circularity' of the initial 'in' of 'in Kosmos' that is an immediate corollary of the narrative form of the Timaeus, complemented by the strict dialectical inquiry of the Parmenides:

'Let us then assume about the copy and original that the words are akin to the matter they describe, and that when they relate to the lasting and permanent and intelligible, they ought to be lasting and unfailling, and as far as is in the nature of words irrefutable and immovable, and nothing less than this. But the words which are the expression of the imitation of the eternal things, which is an image only, need only be likely and analogous to the former words. (2)

- So we have the primary 'in', Kosmos 'in being'. Correlative with this, divine Reason and the activity of framing Kosmos in accordance with Good. Now this Good is no other, we know from the Philebus, than Reason itself. Then Creation is, as it were, a Movement of Reason towards itself. And this, we know (again from the Philebus) amounts to the movement towards an Image of Good: the Image is coordinate with the Movement. The configuration of Kosmos thus far, then, has two sides, corresponding to the Knowledge and Desire of the Philebus: the eternal Actuality 'outside' change, and the image of this Actuality, in which it distinguishes itself from this Image.

Thus (following yet again the scheme of the Philebus) we see that the Idea or primary Actuality of Kosmos, is an 'eternal living being', analogous to the finite mortal being of the Philebus, whose 'soul' is the divine Reason itself. What then of the 'body' of Kosmos?

Body, as we earlier saw (with Timaeus' earlier brethren), is ~~Body~~, solid ('earth') and apparent ('fire'). How are these related? - Why, of course, by the 'harmonic' order we have seen in the Tetractys, the tetrad as informing the epiphany of solid. So that body will be articulated in a 'geometric' division of the difference of solid and light in a continued proportion, fire:air:water:earth. (This division of the solid in continued proportion, required for example in the solution of the 'delian problem' of doubling the volume of Apollo's altar at Delos - finding the relation between linear and cubic measure - was the central question in the mathematical inquiries of the Academy; it also finds expression as the equivalent problem of trisecting an angle).

- Then the primary expression of the Actuality of Kosmos as Soul, will be (following the Philebus once again) in the 'rational' articulation of the Symmetry of the 'Mixture' of unchangeable eternity (corresponding to Limit and Knowledge in the Ph.) and changeable body (corresponding to the Unlimited Movement of the Ph.) - just as Reason (Ph) has been found earlier as the 'cause of the mixture'. The first expression of this articulation is in the separation of a 'unity' from the mixture. The next phase of articulation then comes full circle in the elaboration in terms of this initial unity, of a harmonic frame of Kosmos: the 'mixture' is divided into two musical 'dimensions', each of three 'octaves', into which together the principles of linear (or arithmetic) harmonic and solid (or geometric) proportion are fitted.

Within this frame the cycles of the eternal stars are inscribed: first the fixed stars in the zodiac, the circle of the Same - and within this, the various components inscribed, one within another, in the frame of the ecliptic (the plane of the Sun's revolution), the circuits of the 'planetary' or 'wandering' stars. Thus is Time, the 'moving image of Eternity' framed in Kosmos, 'while Eternity rests in unity': Unity is reflected in the articulation of Number in mathematical Symmetry, and thus is constituted the divine order of astral life, the primary expression of Reason in the World - its primary Image, in the articulation of Time (this we may call the 'astrological' order of 'applied theology', as we have already recognised in mathematics an 'applied logic' and in medical theory an 'applied psychology; and an allusion has already been made to 'music' as an 'applied poetics'; We will shortly see how these 'applied sciences' of Antiquity dominated the School of Alexandria, where later they were supplemented by alchemy, the 'egyptian art' of applied physics, and an applied ontology or 'magic' which I will generally refer to the domain of 'phenomenology', for reasons that will become clearer as we proceed).

Next in the order of constitution (just what way to read the narrative 'then' of the framing of Time in the Timaeus subsequently occasioned much argument; Plato does distinguish the narrative order of his exposition from the eternal order of 'constitution' of Kosmos, but he also sometimes seems to forget this distinction in the narrative) is the conjunction of this eternal astral order with the bodily order of Light, by which we can rise out of the bodily order of Other into the eternal order of the Same, through recognising the articulation of Life according to Number in the frame of Time.

This Life, framed in 'astrological' Time, this mirroring of the eternal order of Reason in the changeable order of the Image, partakes, naturally, in the elementary 'continued proportion' of the elements, the primary figure of correlation of the 'fire' by which they appear, and their 'earthy' solidity. To Fire or Light corresponds the order of astral divinity, associated with the astral bodies of the luminous stars and 'planets'. Air and water too, have their respective orders of living creatures, and to Earth corresponds the order of Life or animality to which we ourselves belong. Thus we have almost reached our place, Timaeus' place, of narrator, in the scheme of the narration.

Now the principle in us which partakes of divine Reason must partake of that same principle of the self-expression of Reason in the 'mixture' of eternal and changeable, in which the astral order of divinity has been articulated or inscribed. God, the divine Craftsman (since he partakes of that figure of Craftsman presented in the last book of the Republic: activity directed towards the realisation of an Idea in the order of the Image, the Copy) thus takes some of the 'mixture' remaining from the constitution of the stars, and divides it into 'seeds' of Man, equal in number to the stars fixed in the circuit of the Same, the zodiac. These are 'placed', given their place, in the spherical and divine bodies of the stars, including this planetary Earth - or rather this earthy centre of the planetary circuit of the Other, within the outer Sphere of the Same, the 'fixed' stars. The constitution of mortal Life, then, on stars, repeats on those 'spheres' the same figure by which they have, in turn, been constituted within the Sphere of Kosmos as a whole. But this local constitution in Time of the Life which is to grow in the stars and planets from the eternal divine seed, implies that 'mortality' of our bodily constitution from the elements of the stars, which is our essential condition, insofar as we are, in our vital activity, dominated by the planetary circuits of the Other. It is only by recognising the inscription of this circulation of mortality in the primary circuit of the Same, that we can 'rise' out of the planetary condition of mortality, towards an immortal life in that fixed star assigned to us, in the creation of the eternal seed, lost here in the circles of generation. Here Rest, the Fixed, is lost in the constantly moving image of Good. Movement, the implication of our 'imagination', of sensible images, in the 'physical' dynamic of movement 'inside' and 'outside' our bodies, in their interaction, dominates the embodied Reason, so that in the circular movement in our heads, which is Thought, the circle of the Same is lost in the circulation of the Other, the fixity of Truth in the play of Appearance and Opinion.

The Unity of Reason has thus been reflected in the constitution, the fitting-together - the 'harmonics' - of the stars. In this frame, this astral constitution has been reflected - as it were in a continued proportion, God:stars:men.- in the secondary 'sphere' which is each star thus constituted, and we have reached the figure of our own embodiment on this central star of Earth.

- But we might have reached this same figure, this same point,

by working in a converse direction, 'up', from the 'elements' of the physical or bodily order of 'Necessity' (rather than 'down' from the first principles of Reason). Rather than proceeding by a sort of inversion or conversion of the 'dialectical' order of Reason - by which in the Philebus Reason has itself been found as the primary dialectical principle of psychical activity or actuality - we might proceed, within the same 'arithmetical' frame of One and Many, and their mixture, from the 'geometrical' frame of the Space and Time of Movement which (as we saw in the Philebus) reflects in the domain of the Image, the dialectical articulation of the Idea of which it is the Copy.

Proceeding 'dialectically' from the initial correlation of Reason, Image and Good in the Act of Creation, its primary Actuality, we found the symmetrical 'in' (side) of the Sphere articulated within the 'harmonics' of three 'octaves'. Three 'octaves': the 'musical' (in the narrower 'mathematical' sense) articulation of that 'continued proportion' between four terms (1:2:4:8 and 1:3:9:27 - 'even' and 'odd') which expresses the mathematical relations of linear 'arithmetical' proportion (1,2,3,4..) and the 'cubic' Number of the geometric solid (2:8 and 3:27). These relations are articulated according to the 'harmonic' proportion of the 'octave' first systematically presented by Philolaus: each 'interval' (1 - 2; 2 - 4, etc.) is divided 'arithmetically' and 'harmonically' ( $1 - 4/3 - 3/2 - 2$ : embodying the relations of the Tetractys) and the whole interval then articulated in a common measure (256  $\ddagger$  for  $(3/2)/(4/3) = 9/8$ , and  $(9/8)^2/(4/3) = 243/256$ , giving the  $\lambda\sigma\mu\mu\kappa$  or 'semitone' left between two 'tones' (ie  $(9/8)^2$ ) and a 'fourth' (4/3) - a 'tome' or measure being the musical difference or 'interval' between a fourth and a 'fifth' (3/2), and an 'octave' (2/1) being the interval compounded of five tones and two semitones: for the difference between a fourth and two tones is equal to the interval between a fifth and three tones -  $(9/8)^2/(4/3) = (9/8)^3/(3/2)$  - this since the initial 'tone' is itself the difference or interval between a fourth and a fifth).

The complementary 'geometrical' harmonics of solid Space, rather than linear Time (or circular Time) are in turn constituted from the 'mixture' or combination in more complex 'symmetries', of two principles of geometric 'Same' (a rectangular <sup>isosceles</sup> triangle) and 'Other' (half of an equilateral triangle). From the first is constructed the cubical form of Earth, from the second the regular solids corresponding to the remaining elements (the fifth regular solid - discovered, it is said, by

Philolaus, although the systematic construction of the solids is ascribed to Plato's associate Theaetetus - Plato associates, it seems, with the encompassing Sphere).

'We must imagine these to be so small that no single particle of any of the four kinds is seen by us on account of their smallness: but when many of them are collected together the aggregate is seen. And the proportions (*λογος*) of their numbers, motions and other properties, everywhere the God, as far as necessity consented and allowed, has exactly perfected, and harmonized them all in due proportion' (1)

- Thus does Plato begin to effect the integration of the two 'sides' of Timaeus' Kosmos - amounting to an integration of the complementary 'logical' and 'physical' economies of Philolaus' system, and that of the atomists. Philolaus' principles of divine Harmony dominate the atomist's Necessity in the integrating Actuality of Reason, just as the logical articulation of Knowledge in the Philebus dominated the part given to Pleasure (as we will see the moving principle of our action, on the atomist hypothesis, as propounded by Epicurus) in the articulation of our finite activity, directed towards - and by - Good,

From the 'physical' side of the scheme the endless movement of Necessity is governed (as in the atomist scheme) by the principle of compression associated with cosmic revolution (here articulated in the harmonics of astrology).

Timaeus gives an outline of the corresponding frame of interaction of the triangular principles in the elements, their combinations and divisions. He passes on to the interactions which are our sensations, and so to the morphology and physiology of our embodiment. Mind has its place in the sphere of the head, communicating with the eternal 'outside' sensation and movement, through the harmonics or fitting-together of Knowledge, which mirrors the heavenly order of the stars. Courage, decisive activity, has its place in the chest, and is focussed in the heart, as mind is focussed in the brain. Pleasure and desire have their place below the midriff, their organisation by the liver 'in order that the power of thought, which originates in the mind, might be reflected as in a mirror which receives and gives back images to the sight'. (2)

The principle of Life itself is implanted in the marrow, and when men who have been unable to subordinate the 'lower' nature to mind are reborn as 'women', marrow, leaking into the lower region, creates the desire of procreation, and generation arises. The origin of other orders of life from men whose activity has been otherwise 'unbalanced' proceeds in its parallel course: light-headed people who think that higher things are sensible, become birds...

Thus, through the integration of eternal and changeable in the figure of Man, in whom one is reflected in the other, as mind in liver, is closed the initial figure of Creation, and Timaeus finds himself at the close of the poetic order of his narrative, having discovered in the 'probable' exemplification of the inscription of figures within figures, the principle of the integration of the psychical order of Reason and the physical order of Movement in the poetic order of Life: in which, we might say, the order of his narrative reflects the 'poetic' articulation of Kosmos as a whole.

The account 'closes', comes full-circle, in the discovery, inscribed within the initial configuration of Reason, Image and Good (corresponding to the initial 'resolution' of the question posed by 'in', one figure 'in' another, in the Parmenides), of a recurrence of this figure in the activity of Man, within the Kosmos articulated in the initial figure. This amounts (then) to a reconstruction of the configuration of Reason in the Philebus, beginning from the dialectical figure of Distinction there inscribed within the rational activity of a finite embodied 'human' being. And this circuit reflects the inscription of Reason within the figure of finite reason with which the narrative concludes, in the poetic figure of narrative assertion, complementing the inscription of this finite reason 'dialectically' in eternal Reason, in the converse poetic frame of the question, in the Parmenides. The narrative assertion of the Timaeus is, as Timaeus suggests, the reflection of the eternal Truth which is the object of dialectic, in the figure of the Image. Its truth lies in the reflection of Reason in this image or copy of the rational articulation of Kosmos. The narrative is presented as correct 'in principle': it is the principle which is the prime object of the narrative, whose truth is thus primarily to be understood as 'dramatic' or 'poetic', rather than



strictly 'scientific' or dialectical.

One principle has thus been exemplified 'dramatically' under two aspects - as the question of the Parmenides, and the 'likely' assertion of the Timaeus. What might be the common frame, the 'poetic' frame of question and assertion, of which these are complementary aspects?...

We saw, in the Statesman, the primary frame in which dialectic knows itself in knowing its part in the group or state as frame of our activity: this primary exercise of reason distinguished itself from a sophistic copy, a mere manipulation of appearances and opinions. The Timaeus begins with a recapitulation by Socrates of the principal conclusions of the Republic, and continues with Socrates' desire to see this abstract Idea of the Republic or State 'in action' - as expressing itself as an actuality, just as the earlier 'abstract' dialectic of the period leading up to the composition of the Republic had, in the subsequent development of Plato's reflection on the place of Reflection in the 'real world', distinguished itself from the play of sophism and appearance within this worldly play - just as Being, in the Sophist, distinguishes itself as primarily an actuality of distinction, discovered 'at work' in the Non-being of the formal distinction of Being and Non-being.

Before Timaeus begins his narrative of Kosmos - as the frame of this actuality of the republic or state - Critias outlines the 'legendary' history that is to be the sequel - after Timaeus has taken the narrative down to men, the protagonists of Critias' story. The story outlined is a conflict of an ideal Athens, whose constitution corresponds with that of the Republic of Socrates, with the prehistoric might of Atlantis. The actuality of the Republic is to be seen naturally, in the conflict of two 'constitutions', a conflict framed in the military order which is intermediate between political direction and underlying material economy, just as the heart, seat of courage, is intermediate (in the Timaeus) between brain and liver, mind and nutrition.

But the Critias breaks off, as soon as the constitution of

Atlantis has been outlined, and the source of the conflict with an earlier Athens identified:

'..when this divine portion began to fade away in them, and became diluted too often and with too much of the mortal admixture, and the human nature got the upper hand..' (1).

Might one not see here the point of transition to the different poetic frame of the Laws, where the 'mythological' narrative appropriate to Timaeus' outline of Kosmos is integrated with the dialectical process of inquiry? Is not the athenian stranger who takes over from Socrates and eleatic strangers and pythagoreans and the rather disreputable athenian politician Critias Plato, finding at last his own voice, as he discovers at last the place of dialectic or inquiry in the Kosmos it has uncovered, and so at last finds his own part, and authority?

And if any of the serious or tragic poets, as they are termed, come to us and say - 'O strangers, may we go to your city and country or may we not, and shall we bring or carry with us our poetry - what is your will about these matters?' How shall we answer the godlike men? I think our answer should be as follows: - Best of strangers, we will say to them, we also are poets, according to our ability, of the best and noblest tragedy; for our whole state is an imitation of the best and noblest life, which we affirm to be indeed the very truth of tragedy. You are poets and we are poets, your rivals and antagonists in the noblest of dramas, which true law, and that only, can carry out in act, as is our aim. Do not then suppose that we shall all in a moment allow you to erect your stage in the Agora..' (2)

- Thus speaks the Athenian Stranger in Plato's last Scene, as he walks with the spartan Megillus and the cretan Cleinias from Knossos to the Dictean Cave where the Father of gods and men is said to have been raised, and whence he gave the first Laws to King Minos. The cretan is to give laws to a new colony, and as they proceed towards the Cave and Temple of Zeus, the Athenian Stranger evolves from its first principles the frame of Law corresponding, in Reason, with this end.

1: Critias, 124a

2: Laws, VII, 817a-c.

What then, is the first principle of Law - analogous to the initial configuration of Reason and Good in which Timaeus frames the order of Kosmos?

Is it the War, internal and external, in which the state as Order is maintained - and in which the constitutions of Atlantis, Sparta and Crete are framed? - But surely there is a better Order, where this maintenance of order is itself one component, as the virtue of Courage by which this latter is articulated, is integrated by the Statesman with a complementary Balance or Temperance, *Συζφροσύνη*? Is not the best ordering of virtues in a State reflected in the interplay of these in the individual member of the State? And is there not a place in State, as in individual, a place in the best arrangement, for a limited playing-out of the subordination of stern prudence to a certain intemperance of the drinking-party, so that we will know the relations of the three principal virtues of prudence, courage, and temperance, as it were, from 'both sides', know our livers as well as our heads? - And so best articulate their relations in our activity, directed by the Justice that determines the part of each in the good of the whole?

- And on the same principles of the articulation by Reason of the economy of the whole, a primary function of the State must be the education of its members, through which they come to find their part in the whole. This 'education' or induction into the activity of the State, must then begin in the discovery of the image of the order of the whole in the elementary discipline and economy of Pleasure and Pain: this through the music and gymnastic of song and dance, whose recurrent theme shall be 'Virtue is Happiness'. And so the primary principle of Virtue will be discovered or experienced as Happiness, in this its elementary self-expression, distinguishing itself, in the simple economy of Pleasure and Pain, as the Happiness of an Order whose principle is 'outside' the simple Play of Pleasure and Pain.

This principle may, in parallel fashion, be seen at work in the rise of the Order of the State in which it partakes, and into which it is an introduction or induction, from the elementary 'economy' of the household, *οἶκος*, family, over time. From this development have arisen nearly-perfect images of the Order which is the true good of the State: but still the military order of Sparta and the open Economy of Athens are unbalanced, just like the tyranny of Persia which together they successfully opposed.

The 'finished' or perfected Order, of which these are complementary aspects or images, must, then, be inscribed within the primary figure of Justice, of which these are parts. Justice expressing itself first in the 'heavenly' actuality of perfect Justice which expresses itself in distinguishing itself from these images. Expressing itself in that Virtue which is the first thing exemplified and discovered in Education, and in Respect, in which is rooted the historically primary order of the Family. Law itself thus belongs to the same order of principles as Education, and this recognition is to be a part of Education. The Laws should be seen to arise out of such principles, and to each law should be prefixed the principles it exemplifies. This principle itself, then, may be seen to be exemplified in the discussion of the first four books, which it closes, and which serve as a general Preamble to the particular laws of the following books. - A general preamble showing these Laws to be the primary expression of Justice, both in the State at large, and in the education which they, revealing this Justice in successive figures, will constitute within the State.

These general principles all partake in one Justice which finds expression in the individual citizen, in respect for the Soul. And as the cosmic frame of the relations of body and soul has its primary order and articulation (as we saw in the Timaeus) in Number - this being the primary frame of inscription of one 'figure' within another - so the civic frame of Justice will also be framed, first of all, in Number. The Constitution or frame of particular laws (in which these particular laws are to be 'inscribed', both literally and in the outward 'constitution' of the State) will thus institute 5040 households: all the 'figures', all the numbers, from unity up to twelve, <sup>(12107114 (12107114))</sup> may be found 'in' this number, as components or 'factors'. And to these numbers will correspond 'factors' in the organisation of the State constituted by or from this number of households. Time is 'constituted' in the Timaeus according to an analogous 'harmony' or harmonics, along with the Matter whose dynamics is inscribed in this Time.

Not only is the whole number divisible by twelve, but <sup>so</sup> also <sup>is</sup> the number of each tribe. Every portion should be regarded by us as a sacred gift of Heaven, corresponding to the months and to the movement of the ~~Months~~. (1)

These various 'factors' in the constitution will be in the charge of officers of the State. In particular there will be a Council, the 'guardians of the Law', numbering 37 (36+1), whose office it will be to appoint such officers, and to decide what is left 'open' in the Law: the closed frame of Law constitutes this Council to determine what the Law leaves open, according to the Justice expressing itself in the Law, and here distinguishing itself from its image in Law, by inscribing this distinction itself in the frame of the Law.

Next to be determined is the law of the Family, the elementary 'factor' or position, from which those factors intermediate between Family and Council are themselves, on one side (as it were) derived. Then follows the constitution of Education, from the initial phase already discussed, on to the astronomy and mathematics which will reveal the place of the articulation of the State in the wider order of Kosmos.

Then follows the place in the State of that order of 'play' in the broadest sense, whose instance in the elementary economy of education was discussed earlier. The same principle of Order expressing itself through its inscription in this order of the 'play' of passions, of pleasure and pain is applied to the Festival, and the play of sexuality which the Athenian associates with the spirit of the Festival.

From this, then, the transition is made to the laws relating to the infringement of Law: penalties must be measured according to that same economy of pleasure and pain whose disorder is the primary principle of such Crime. The highest crime is that against the gods (next against the State, then against individuals and property): all crime partakes of the figure of ignorance of the actuality of gods and soul. It amounts to a failure to recognise the actuality that distinguishes itself in Reason, both in the individual (as in the Philebus) whose soul is 'self-moving' and in Kosmos (as in the Timaeus). Its remedy lies primarily, therefore, in the Education in which the discovery of Virtue, and of its reflection in the Reason and Good of the divine order of Kosmos, evokes that Piety which is the very principle of Law and Order.

With this principle, corresponding to the primary expression (or self-expression) in Law of Justice, as what governs the subordination of

Passion to Knowledge in the activity of Reason, we return to the  
 Guardians, and reach the close of the Laws (XII, <sup>951d-2b</sup><sub>960a-9d</sub>). For this  
 is the embodiment or inscription in Law of the principle of Justice  
 whose actuality expresses itself in the frame of Law, just as the actu-  
 ality of Reason expresses itself in the Kosmos in which this Law is framed,  
 and in the activity of the just individual, framed by the Law.

Their place in the Law corresponds to the figure of the Quest-  
 ion: the inscription in the closed circuit of the Law, of the relation  
 between this closed circuit, and what in it is open. They mark the para-  
 dox, noted long ago in the Introduction, that Law cannot itself determine  
 the application of Law. In the frame of 'symmetry' of 'political' direction  
 and its 'economy', Justice marks or expresses itself as outside this for-  
 mal symmetry, just as Being marks itself as outside the formal symmetry  
 of Being and Non-being. This self-expression of Being in the Non-being  
 of that formal distinction is the Actuality of Being, just as the distinct-  
 ion of Knowledge (as Distinction) in and from the symmetry of Truth and Ap-  
 pearance is the 'epiphany' which is the 'appearance' of Truth, the self-  
 assertion of Truth, as Knowledge of Being, in Appearance, as 'outside' the  
 open play or economy of Appearances.

The Council, then, meeting before dawn, is a 'mystery' - the  
 instituted mystery of Justice, the primary Actuality in which an order  
 'outside' the earthly order of mortality expresses itself in that order  
 as what distinguishes itself from the earthly symmetry of Justice and Eco-  
 nomy in Law, precisely by determining the Law as framing this symmetry.  
 A mystery, not in that its proceedings are secret, like those of the py-  
 thagorean brotherhood at Croton, the figure of whose political direction  
 is exactly analogous - rather in this, that the Distinction and Judgement  
 by which this Council knows its part in framing the 'drama' of the State  
 can only be understood by those who participate in this same activity or  
 Actuality of Distinction. It is simply contradictory to suppose that  
 participation in the Council could be 'known' or understood 'outside' the  
 domain of Distinction and Wisdom which is the very part or 'place' of the  
 Council in the drama of the State which it directs:

In the first place, a list would have to be made out of those who,  
 by their ages and studies, and dispositions and habits, are well  
 fitted for the duty of a guardian. In the next place, it will not  
 be easy for them to discover themselves what they ought to learn, or

become the disciple of one who has already made the discovery. Furthermore, to write down the times at which, and during which, they ought to receive the several kinds of instruction, would be a vain thing; for the learners themselves do not know what is learned to advantage until the knowledge which is the result of learning has found a place in the soul of each. Hence what relates to these matters, although they would not be truly said to be secret, might be said to be incapable of being stated beforehand, because when stated they would have no meaning. (1)

The organisation by the Council of the 'induction' or education of its members cannot be determined at the outset by Law: it is in this sense 'formally' open, for it amounts to the first expression of the actuality of the Council, which thus distinguishes itself from its determination in Imagination or Idea. With this recognition the book closes: the next step is the passage out of the cloûre of the formal frame of the 'drama' presented in the book - which is thus in some sense an invitation to the establishment in fact, actually, of such a Council - into the implementation of this frame in its context (2).

This, then, is the figure of the institution of the Actuality of Good in a State, the very Idea, as it were, that has guided Plato's progress through the Image, through the imagination of such an implication of Good and Virtue in the Economy of the World, in so many different forms and figures, these together marking those 'two steps' of Reflection, from the judicial murder of Socrates down to the middle of the fourth century, between which the state of the Republic marks a pause and transition.

The Council is the very soul in the 'head' of the State, the embodiment of the Actuality of the state which is Justice in the Wisdom which knows its part in Justice, balancing Temperance in the frame of an Order or Law physically defended, within and without, by Courage. This Wisdom

is, then, framed in the Knowledge which knows one Virtue in four virtues, and the one guiding aim of Virtue in the many subordinate aims and activities which together make up the Activity of the State. Knowing the One in the Many, it knows the articulation of the Many in the One. It knows not only the Name - Wisdom, Courage, Temperance, Justice, <sup>Virtue</sup> but also the Definition ( $\lambda\acute{o}\gamma\omicron\varsigma$ )<sup>964b</sup> and Principle ( $\lambda\epsilon\gamma\acute{\iota}$ ) or Idea (1).  
 $\tau\acute{\iota}$   $\alpha\sigma\tau\acute{\iota}\tau\omicron\tau\epsilon$ ,  $\tau\acute{\iota}$   $\kappa\alpha\tau\alpha$   $\delta\iota\alpha\nu$

In thus knowing itself, it knows that Divinity, that Mystery, which distinguishes itself in the State as the actuality of Virtue and Justice, in the individual as the self-moving actuality of soul, and in Kosmos as the Reason of which this soul partakes, the Mind articulated in the 'order of motion in the heavens' (2). Here is the last law of the Laws:

No man can be a true worshipper of the gods who does not know these two principles - that the soul is the eldest of things which are born, and is immortal and rules over all bodies; moreover, as I have said now several times, he who has not contemplated the Mind of Nature which has been affirmed to exist in the stars, and acquired the previous Knowledge (dialectic), and seen the connection of them with Music, and harmonised them all with Laws and Institutions, is not able to give a reason of such things as have a reason. And he who is unable to acquire this in addition to the ordinary virtues of a citizen, can hardly be a good ruler of a whole state; but he should be subordinate to other rulers. Wherefore, Cleinias and Megillus, let us consider whether we may not add to all the other laws which we have discussed this further one, - that the nocturnal assembly of the magistrates, which has also been associated with us in our whole scheme of Education, shall be a guard set according to law for the salvation of the State. (3)

- And to the internal activity of the Assembly or Council, is to correspond, for members between the ages of fifty and sixty years, that part of  $\theta\omega\mu\acute{\iota}\sigma$  - 'spectator', ambassador, travelling like the gaze 'abroad', communicating to other states the principles of the new State, and to the Council those principles of Law and Knowledge discovered upon his journey (4).



In the Athenian's imaginary Council a phase of Reflection closes. A step from the rule of Wisdom in the Republic; two steps from Socrates' last invocation of a Justice 'outside' the athenian economy of sophistic virtues and political manipulation, yet marked by Socrates' respect of Law as its Image; three steps from the configuration of theory - from the mathematical Kosmos of Philolaus, the physics of the atomists, the 'poetics' of Gorgias and Protagoras - in which Socrates' inquiry took its rise. Then back over a further three steps to the pythagorean mystery at Croton, whose configuration in the City is now reflected, repeated in the mature Reflection of Plato in mid-fourth-century Athens. Repeated in the logical configuration of a text, the Laws, as a closing question - an invitation that the step out of the logical frame of the inquiry be made the first step into the mystery embodied in the Knowledge of the place of Knowledge in the frame of Activity.

The same figure of Kosmos as a 'mystery': the 'logical' order rooted in a limiting logical determination of the distinction of logical from physical, the Distinction or Limit at the limit of dialectic, presented - framed - as Question in the Parmenides. The same figure of Limit had been framed as question - as mystery - at Croton. Reflecting this limiting Distinction, then, a Kosmos as limiting 'outward' frame of inscription of distinction within distinction - the physical mirroring of the logical order of 'in', in the outside 'context' of this logical order of Limit. The same mirroring of these 'logical' and 'physical' orders in the frame of *μεθυστικα*, pythagorean 'mathematics': the mirroring in a mathematical 'harmonics', a mathematics of 'inscription' of figures within figures, of 'arithmetical' unity and geometrical point, with its three 'dimensions' or Space.

The same figure of the 'psychical' actuality of a soul, experienced in the participation of reflection in the figure of Limit, in the logical determination of the relations of logical and physical, which reflects primary 'psychical' assertion or self-expression. The same 'epiphany' of an ontical order 'outside', a transfigured Light, Light seen as the reflection of the physical determination of the relations of logical and physical orders in which Being expresses itself, appears, shines forth in a mirroring of the psychical order of the soul in Vision, *ὁρασις*.

The same inscription of these figures in the circle of a myst-

ery which is at the same time the principle of government of the City, reflecting in the natural economy of Earth the cosmic Actuality of a Justice which frames the relations of Earth and Heaven in cosmic Law, a cosmic Mathematics or Accounting. The same figure of the entry of the individual into this Council as the induction in his earthly 'frame' of the same figure of mystery which governs the City - the 'theory' or vision of the place of this vision or knowledge, wisdom, as part of the Activity or Actuality to which it is the access, and which is its object.

The same figure recurs again at the close of the First Part of the Tradition with which this First Part of the narrative is concerned - and it will recur in the final vision of the place of this narration in the Tradition it narrates. At the close of this First Part it appears in the form of a Universal Church, a mystery which bears an analogous relation to 'the World' of its vision, and its time, as that borne by the pythagorean brotherhood to the affairs of Croton. In the Conclusion of the whole narrative it will appear simply as the 'other side' of the open frame of relations in which this narrative is inscribed - an 'other' side marked in the poetic economy of 'this' side as what distinguishes itself in this Economy from this Economy, just as Plato's Being, one element of the 'other side', distinguishes itself from the Appearance which is one element in this Economy. Indeed this 'other side' will be seen to be simply the articulation of the analogous 'distinctions' traced in the course of this narrative (from the pythagorean Limit down to this text) within the general figure of Distinction which first appears in the narrative as Heraclitus' Word. Quite a bit of the journey still remains...

METHOD

What then, in such a scheme, is the part of narrative? Obviously enough the part I have sketched for Plato (or Empedocles or Heraclitus, or any of the others) is only that: a 'sketch', scheme, figure  $\{\sigma\chi\eta\mu\alpha\}$  in the wider figure or  $\sigma\chi\eta\mu\alpha$  ('scheme', 'outline', 'plan') of the narration as a whole. It remains quite as far <sup>from</sup> the minute detail and dynamic of a complete Account or History, as Timaeus' sketch from the Kosmos in which it is traced.

What part, for example, might Archytas, the pythagorean leader of Taras (Tarentum), Plato's contemporary who saved him from execution (at the close of the third sicilian visit, 361-360) at the hands of his erstwhile pupil Dionysius (whose reconciliation with his philosophical uncle Dion had been the motive for this last journey), have played in the development of 'pythagorean' elements in Plato's reflection? Where indeed might Archytas himself, the first to apply mathematical symmetries to dynamical questions, stand in the dynamic of the pythagorean tradition?

What part should be assigned to this tradition in the mathematical activity of the Academy - in Theaetetus' treatment of 'irrational' numbers (which are not commensurable, 'symmetric', with the unit, no definite 'number' of some smaller units, a definite number of which would make up unity) and <sup>the</sup> 'pythagorean' or 'platonian' regular solids, the three-dimensional symmetries of geometrical Space? - in Eudoxus' Method of Exhaustion (by which a 'limit' may be assigned to an unlimited series of successive approximations by the 'indirect' method of supposing this limit exceeded at some definite point (say) and showing the contradiction of such a supposition)? And what was the part of this 'applied logic' in the activity of the Academy ('let no-one ignorant of geometry enter' above the gate) as a whole.. ..that Eudoxus might have taken over the direction of the School during Plato's second sicilian visit, and he, rather than Plato, welcomed the young Aristotle in 367?

And what was the part of hippocratic theory in <sup>any</sup> -medical training imparted to the young Aristotle by his father (~~Rhizus~~<sup>Rhizus</sup> of Macedon's physician) in his younger years? What exactly was the relation be-

Aristotle's supposed teaching of Rhetoric during his stay at the Academy, and that of his more illustrious rival Isocrates (himself once a disciple of Socrates)? Might one suppose that Aristotle's emphasis was 'forensic' against the 'epideictic' show of Isocrates (whose profession of a 'middle way' between philosophy and politics Plato had already satirised in the Euthydemus)?

... At any rate, it was the deliberative orator Demosthenes who began to eclipse both Aristotle and Isocrates around the time of Plato's death, and the publication of the Laws: Amyntas' son Philip (who had risen to the macedonian throne according to the method of his ~~father~~ <sup>by his own</sup> Archelaus, taken as the very exemplar of tyranny in the Gorgias) had, in his campaign of expanding his rule over neighbouring greek colonies, at last taken Athens's ally Olynthus, and by the following year Demosthenes had eventually persuaded the athenians to declare war on Macedon. Might it have been this which, in the year of Plato's death, forced Aristotle to leave Athens for Assos? Or might it rather have been the ~~succession~~ <sup>accession</sup> of Plato's nephew Speusippus as head of the Academy - the representative of those 'pythagorising' tendencies of the Epinomis which Aristotle opposed - which prompted Aristotle to leave, in the company of Xenocrates (Speusippus' equally 'pythagorising' successor)?

- And what part did Aristotle's researches into natural history, into animal physiology, begun at Assos, play in the elaboration of the frame of inquiry embodied in his lectures at the Lyceum years later? And what of his 'meta-physics' was begun at this time? What, then, was his part in the forming of the young Alexander in those last years before the complete subjection of Hellas by his father Philip?

Questions, open in the frame of the narrative thus far, might be multiplied indefinitely. Whole orders of questions might be distinguished, questions inscribed within other questions.. and orders <sup>within</sup> orders. The open-ness of the scheme traced so far, indeed, might be said almost to define what is in principle irreducible to any closed Scheme, as the Fact or History in which my scheme is drawn or sketched.

- But there is no need to look so far for this radical openness which attaches to <sup>it's</sup> 'scheme' of development: one might find an equally

deep chasm of uncertainty in any of Plato's dialogues, so schematically treated above. One might find an unlimited variety of 'schemes', readings, in the configuration of any one text and its context - or rather, a variety limited only by the mirroring of these two 'sides' of text and context in the actual frame of the book - its actuality which contradicts some interpretations, just as Being 'contradicts' (does it not?) in the Sophist the Nothing of a formal opposition of Being and Nothing.

How then, like Timaeus (or rather, Plato) am I to 'close' the scheme of this narrative? Am I to happily disclaim any pretension of accuracy, and inscribe the narrative squarely in the figure of Fiction? Or.. how might I somehow dramatise the narrative to bring out or reveal an Actuality whose configuration in (say) the Sophist seems somehow independent of the acknowledged impossibility of any thoroughly 'definitive' reading, quite abstracted from the essential 'open-ness' of the text? How, then, imitate Plato himself (?) as he evokes an Actuality of Good in a dramatic configuration of Socrates and his interlocutors 'abstracted' from the actual details of historical Fact?

Might I perhaps claim that by inscribing figures of this 'open-ness' of Plato's text in that open-ness that reflects the actuality of Plato's self-expression in his text, I enter into a dialogue with Plato? - A dialogue abstracted from the material speech in which we might actually talk, and perhaps 'agree' at last - rather as the socratic dialogues are abstracted from the actual speech of Socrates.

And is not the mark of such a dialogue the actuality, the reality, of a response, which is not a mere projection of preconceptions into an otherwise inert group of words? Is it not that same 'working' of a reading found in the 'working' or Actuality of Being in the Sophist, and in the Question of Actuality in the Parmenides? And does not this implication of the very terms of this reading in the themes and configurations of Plato's texts, reflect in a way that guiding principle of 'Timaeus' - to evoke or exemplify, as best as is possible with limited means, not definitive Fact, but rather the Actuality which expresses itself in Fact, in a variety which is in principle beyond our reflection?

It was just this principle of evocation, in its simplest figuration, which was itself invoked in the identification of the starting-

point of this narrative: the discovery, 'outside' the logical order of the text, of a configuration (the pythagorean 'mystery') which reflected the 'logical' structure of the question of the relations of 'logical' inside, and 'physical' out-side of this text. Now, as the first coherent phase of a 'Tradition' then identified in the outward or 'historical' relations of pythagorean mystery and its identification here closes, with the Laws and death of Plato, this initial bare Actuality of Kosmos as primary frame of mirroring of 'inside' and 'outside' of a text, has taken on more character. Certain 'dimensions' of this Kosmos or initial Actuality have expressed themselves in the 'critical' process by which, first of all, Parmenides has found himself 'outside' the pythagorean 'theory' of Kosmos, in that context which, 'in theory', is subordinated to the internal theoretical determination of the relations of the text and context of the 'theory'.

Subsequently, this simple figure in terms of which Reflection appears as Drama, as in principle 'dramatic', is worked-out in a series of parallel or successive steps, leading down to the death of Plato. And now, with the death of Plato, this figure of 'Drama' has come full-circle in the closing question of the Laws. In the figure of the step from theoretical determination of the Actuality of (the) Good, as Knowledge knowing its part in the Activity of which it is one element (the organising or governing element), into the (actual) implementation of this Knowledge, its 'embodiment' in the context of the imaginary drama at whose close this step is identified. This marking of a limiting point of 'communication' of Knowledge and Actuality - as invitation or question - mirrors our initial point of access to the pythagorean circle of ~~ἔργον~~. - And, 'historically' it may be taken to mark the close of a phase of 'abstraction' of 'theory' from activity - from the circle of ~~ἔργον~~ into which a pythagorean 'stepped' by seeing this step in the dramatic frame of a Kosmos into which it was the entrance. - A circle and a step dramatically implicated in the City as primary frame of Activity.

At the close of this phase, this dramatic implication of theory has contracted to the simple question posed by the inscription of the logical configuration of this 'mystery of government', in the athenian state confronting Macedon, with its semi-barbarian military constitution. - And this 'inscription' of the place of theory in the State, in the very different state of Athens, marks the point at which the logical circuit of Theory is instituted in the School. A 'school' in which abstraction is at last

closed upon itself, leaving behind that last point at which the relation between the theory of institutions and the institution of theory appears as a question, ambiguous in its implications between the further development of Theory or Reflection, and the application of the theory of the State to the place of this theory in an actual colony - in the then still (just) possible institution of a new state by a group of platonically enlightened men.

This point of transition to the School, then, is marked by the inscription in Plato's Academy of the 'logical' articulation of The State, ambiguous between a 'mere' theoretical construction, and an actually possible constitution. An inscription in the 'logical circuit' of Reflection of the logical circuit of this 'theory' as the last question, the last point which closes the figure of Abstraction, closes the circle, which now has inscribed within it the symmetric articulation of those various orders of 'logical', 'physical', 'poetic', 'ontological', 'psychological' and 'theological' whose principles have been more or less separately elaborated from their initial (shall we say) confusion in pythagorean  $\Theta\sigma\mu\lambda\alpha$  .

Speusippus, Plato's immediate successor as head of the Academy, might be said to close the circle (perhaps, indeed, in the Epinomis) in instituting the 'pythagorising' phase of the 'Old Academy', which lasted until about the middle of the following century (until the 'sceptical' Middle Academy of Arsesilaus). Aristotle might be said to found another School, the Lyceum, in closing the circle according to the figure of that 'applied' Science or Theory which has been noted already in the form of the autonomous articulation of Mathematics ('applied logic') and Medicine ('applied psychology') around the beginning of the peloponnesian war.

'Schools': the autonomous group whose constitution and tradition reflects that autonomy of the City, then passing away. An autonomy constituted in abstraction, by 'closing the circle' of abstraction, from the civic context in which this abstraction is instituted as the School. An autonomy and continuity of Reflection which partakes of that figure of the continuation of Reflection simply as such, presented by the the 'logical circle' by which the relations of text and context, logical and physical orders, are determined in the logical terms or frame of the text. The con-

tinuation of a 'system' of incorporation of context in text. - A 'system' constituted by the perseverance of a certain set of terms and their relations through the successive re-inscriptions of the relations of these terms, this system, to its context, 'in' the system. And a system which, instituted as a 'School' determines in part that activity - not merely 'theoretical'- by which the material continuity of the School is maintained.

Such a 'School', then, amounts to an analogue of the dynamic of the Tradition as a whole, within the Tradition. The next phase of the Tradition, to be discussed now, might well enough be said to be a period of 'schools'. The aristotelian tradition might be said to be continued, primarily, in the work of the School of Alexandria. At Athens, and contemporaneously with that great institution ('instituted' and funded by the egyptian state), apart from the Lyceum and Academy was the epicurean tradition and, dominating all these, the Stoa. The schematic consideration of principles embodied in these schools, and their interaction, will take us down to the integration of stoicism and platonism at Alexandria, around the beginning of this our Era, represented by Philo Judaeus, and to the 'poetic' configuration which determines this point as the beginning of an 'Era', a configuration which is most directly reflected in Theory by the activity of Philo.

I have called this section 'Method'. I began it by discussing my own 'method' in this narrative - but that in a way reflects what is characteristic of the period beginning with the death of Plato, and those reflections on Method may serve as an introduction to Aristotle's 'closing the circle' of theory, his institution of the peripatetic method. I have already noted on several occasions that the questions attaching to my 'reading' of the Tradition should (if the reading be consistent) be seen to be reflected in the criticism in the Tradition of the principles which, at each stage, this reading is suggested to elicit. Thus the criticism I imagined of my reading of Plato's dialogues (as, indeed, of what prepares the way for these dialogues, down from the first pythagoreans) attached principally to its essentially 'schematic' character. In a sense, Aristotle's criticism of 'pythagorising' platonism attaches to just the 'schematic' character which I have sought, rather emphatically, to evoke.



- Yet, in a sense, Aristotle's 'system' insofar as it tends towards consistency - a virtue about which Aristotle is himself most emphatic - is far more 'schematic' than even the latest stages of Plato's reflection.

How is this?

Well, I have tried to emphasise, in inscribing my reading of Plato's dialogues in the figure of dialogue and drama, the 'actuality', the 'working', of the 'dialectical' principle which finally, in the Parmenides, appears in the form of a question - as the dialogue itself articulated as a Question. As the question of the psychical actuality of the logical principle of Distinction which distinguishes itself, in words, from the physical order of the words, of the words as marks: the question of the Knowledge which knows itself as distinct from the 'physical' order of Sense or Appearance. As the question of the ontical actuality of Being which distinguishes itself from the formal logical order of the difference of this Being, from the Nothing by which it is marked off (logically) from Nothing. Above all, as the Actuality in which these two distinctions conjointly partake, which distinguishes itself in articulating in the poetic order of conversion of these two distinctions its<sup>own</sup> distinction from that<sup>poetic</sup> order of symmetry of logical and physical, and of Actuality and its poetic frame.

This 'Question' of the Parmenides I took as the 'logical' limit of Plato's dramatisation of Actuality. The complementary narrative circuit of the Timaeus I took as a roughly 'symmetric' 'physical' limit of expression of this same Actuality. - And the integration of these two movements in the 'poetic' frame of activity, the 'constitution' of this frame, I took as a limiting expression of the figure common to ~~the~~ Parmenides and Timaeus: the figure of a 'theory' or 'reflection' which knows itself in knowing the whole of which it is a part, and knows this whole only when it knows its part. One might call this a figure of 'dramatic truth'.

Exit Plato: the scene closes. And this closing of the circle, this abstraction from that last question or invitation of the Laws, takes on two forms, two figures - inside and outside the School. Within the School, under Speusippus and his early successors, the three correlative 'questions' of the Parmenides, Timaeus and Laws are integrated in the institution of a 'mathematical' frame, an abstraction from the mirroring of

dialectic and cosmology in the State as primary frame of activity, and of these two activities of dialectic and cosmology in particular, to the frame of One and Many, in which the 'mathematical' figures of Actuality are to be inscribed, one within another. The Question of the Parmenides is integrated with the narrative of the Timaeus, within the mathematical frame of its formal resolution, a mathematical logic of inscription, of 'in', in which the Idea closes upon itself in the One which in the Two distinguishes itself from the Many, and determines the identity of the Many, the physical order, in the ideal unity of the formal opposition of two terms, One and Many - or One and 'Indefinite Dyad'. The Old Academy 'turns Philosophy into Mathematics'(1).

Aristotle, then, leaving Athens for the Troad, finds himself 'outside' this platonic circle: outside the School of Speusippus, and the mathematical frame of their subordination of the physical economy of the context of their reflection (in which Aristotle now finds himself) to the logical determination of the distinction of logical and physical orders of mathematical text and natural context. The poetic frame of their inquiry is (like that of the early pythagoreans before them) determined as the mathematical process of subordination of physical to logical.

Aristotle's situation thus resembles, in a way, that of Parmenides, outside the logical circle of pythagorean *ἄρχη*. The conversion of the Question of the Parmenides into the frame of cosmological assertion (rather than the logical locus in which Actuality may assert itself) is open to just those questions raised in the first part of that dialogue, which the 'real' Aristotle (not the Aristotle which Parmenides had found arguing with Socrates the day before the dialogue) now repeats with only slight modification in that 'meta-physics' begun around the time of his departure from Athens (2). 'Logic', Method, should be taken, not as the formal determination of the constitution of Kosmos, but rather as simply a formal frame of inquiry, the mere 'tool', *ὄργανον*, of the philosopher.

And here we find that aristotelian 'scheme' of Method or Inquiry which is determined by this first criticism of the mathematical 'figure' or 'scheme' which reduces the relation of text and context to one component of a 'closed' text, abstracted - like the 'ideas' or schemes themselves, from a more radical Actuality in which this abstraction is

1; Metaphysics A, 992a32-3; 2: Met. A; and MET., passim A 987a29-988a12

itself carried out. Aristotle will not allow that the relations of text and context should be an 'internal' component of the text, any more than Parmenides would allow an analogous figure in an earlier cosmogony.

This figure provides only the terms of Inquiry, and their 'logical' relations in the frame of Inquiry; the inquiry does not then proceed simply by the 'deduction' of an 'external' order of the World from successive inscriptions in this frame of the formal relations of frame and World, as determined by the initial logical frame. Indeed there is no place in the merely logical frame of Inquiry for the fundamental actuality of that ~~thesis~~ <sup>thesis</sup>, 'position', reference by which the terms acquire any significance they might have. The resolution of the Question posed by the radical symmetry of the logical order of distinction and the physical difference by which this distinction is 'marked' (the Question of the logical distinction of these two orders of difference) cannot - as was shown in the Parmenides - be logically, formally, resolved. If someone questions the embodiment of this resolution in the actuality of reference, with which Aristotle begins, there is no strictly 'logical' argument against him. We can only try to point out that the very reference thus refused or questioned, in itself involved in the significance of the question or refusal. A philosopher argues only with men, not vegetables, and to be a man, a 'rational animal', is to be already implicated in the actuality of reference or significance (1). The logical frame of Inquiry is thus, indeed, formally articulated as a logic of 'in' and 'out', inscribed in the initial figure of a resolution of the logical symmetry of logical and physical orders. But this resolution partakes of an Actuality in which the logical and physical 'in' are correlated in the figure of a significance or reference which cannot be reduced to any purely logical determination of the relations of logical 'inside' of thought, and physical 'outside', its initial object. - Correlated, then, in that figure of correspondence of logical and physical 'in' which first appears in the Eleatic Stranger's identification of Truth in the Sophist: when the <sup>logical</sup> inscription of one term 'in' another agrees with the physical 'presence' of the being of the second term in that of the first. - When the 'logical' inscription of a term in a 'class' corresponds to the quality thus 'predicated' of the first term actually being 'in' the 'subject' to which the first term 'refers'.

Thus 'ideas' or 'classes' or 'forms' are not to be understood in logical 'abstraction' from those 'subjects' to which they are referred, 1: Met. [ ] .

but rather as inseparably involved with these 'subjects' which they are 'in', in the actuality of reference, in which alone they may be formally, 'logically' separated or 'abstracted' from their 'being-in' a subject.

- But we do not, in fact, start from a logical determination of terms and classes - we could not, as has just been shown. This logical circle of 'definition' must itself be the result of progressive 'abstractions' of the logical order of 'being-in' from the simple actuality of actual reference to the everyday 'subjects' with which we must, actually, begin philosophy. Knowledge remains, as in the Theaetetus, the correspondence of thought and object of which we can give an 'account', give the reason or 'cause' (*αἰτία*). But this account must be reached first, not by a logical 'deduction' from some initial 'ideal' distinction of logical and physical orders, by some purely 'logical' determination of 'reference', but rather by an 'induction' from particular instances, tracing back a series of 'in's, beginning with the initial predicate of some actual 'substance' or subject which is not itself predicated of anything else, and inscribing the 'class' or form corresponding to this predicate in higher classes or forms, until we reach those 'highest classes' or 'categories' corresponding simply to the initial logical configuration of reference simply as such. When we then inscribe the particular original reference or predication in the 'return' series of causes or deductions which invert or convert the initial order of 'induction', we can be said to know the situation in the strictest sense.

This 'induction' by which Aristotle eventually reaches the 'logical' articulation of Kosmos as primary frame of Actuality, of actual 'substances' and their classes or forms, begins at Assos with the application of the 'method' of induction thus arrived at by criticism of platonic 'schematism', to the actuality of those particular living things, 'organisms', which - as in the scheme of the Timaeus - correspond directly to the form of Life as primary Actuality of Kosmos.

'Actuality': ἐνέργεια 'working', at work: the term is Aristotle's. Where is its place in Aristotle's scheme? At what point might we suppose he reached this 'Actuality' by induction? I will not attempt to resolve this or any analogous questions, by trying to find some 'gen-

etic' scheme in what remains to us from Aristotle's lectures at the Lyceum between 335/4 and 323. No doubt various constructions of the parallel development of his conceptions of Method and its results (and so of new light on its place in the System to which it was leading) are possible. I will simply take the transition from his departure from the Academy, around the middle of the century, and the systematic scheme worked-out in various degrees in the Corpus which remains to us (that is, what there is in this Corpus of an Economy of Actuality) as marking the first step in the period between Plato's death and the beginning of our Era. I will just note in passing that this transition turns, in its outward aspect, about the two or three years when Aristotle was tutor to Alexander. Apparently there date from about this time<sup>a</sup> dialogue, Alexander - Or on Colonies (or: Colonists). It is obvious enough from Alexander's subsequent activity, and Aristotle's subsequent Politics and (two) Ethics, that Plato's correlation of Ethics, Politics, Education and Colonies with Philosophy had, under Philip, and with Aristotle, lost any 'significance' it might have had around the time of Plato's death. In the Nicomachian Ethics the Philosopher, lost in abstractions, and the 'magnanimous' leader or man of action, have their clearly distinguished parts in the order of things - as 'inward' and 'outward' expressions of reflection turning upon itself, like the aristotelian God who has no definite part in their World at all.

'An Economy of Actuality', then: for the 'working' which is ἐνέργεια is the very principle of this Economy. What then is this 'working'? We cannot properly 'define' it, any more than Socrates in the Parmenides can define his 'forms' or 'ideas', for it is itself 'behind' (as it were) this 'logical' principle of definition, and any such 'definition' of Actuality would be subject to just those criticisms of the 'platonists' in which this Actuality first expresses itself. We cannot logically determine 'Actuality': this definition is itself one aspect of Actuality. Yet this term, ἐνέργεια, is 'at work' in the 'organisation' of all the other terms. It is 'at work' in the recognition that we cannot define this very term; it expresses itself most simply in this 'logical' determination of the impossibility, the circularity, of any 'definition', corresponding to the 'Question' of Distinction in the Parmenides.

Might we not then say that 'Actuality' is primarily ἰδέσθαι ,

this latter term being what, as in the Sophist, marks or names (though it cannot 'define') that principle of Distinction which expresses itself in distinguishing itself from the primary 'logical' and 'physical' distinctions which 'participate' in it?

'Primarily' form, but not simply Form or Distinction: rather Form as this is itself at work in the articulation of the two primary orders of Distinction in actual things, in that radical actuality of significance or reference, Being, 'position'. Position: a name or term for the inscription of the outward 'physical' order in the 'inward' logical order in assertion. But this 'position' by which is marked the logical circuit of abstraction from the physical mark, is at the same time the primary physical determination of the mark, as a mark 'in Space', 'in' the physical order of 'being-in', in a place. The pythagorean definition of unit, 'point', given in the Physics, is ἡ ἕνδοξος ἔστω ἡ ἀποτομή. 'unit having position'. Actuality, as it expresses itself in the 'highest genera' or Categories, cannot be defined - for this would involve distinguishing these highest classes within some further class of Being or Actuality. It must be 'indicated', pointed out, discovered at the limit of induction, expressing itself in that very limitation, with which the return path of Definition must begin. We must somehow 'grasp' how the term 'works' in the actual configuration of terms in that Actuality which expresses itself in the configuration of definition (of 'categories' as limiting terms of definition), but which cannot itself be defined. We must find Actuality 'at work' in this 'limitation' of the logical order of definition - in the constitution of that order, which is thus in a way the primary access to that actual knowledge of Actuality, that σοφία, 'wisdom', which is the formal object of inquiry in the 'metaphysics'. Actuality thus expresses itself in the logical order of distinction, as 'outside', distinct from, that order - just as Being had expressed itself, in the Sophist, as 'outside' the formal distinction of Being and non-Being. Knowledge involves 'definition', an inscription of the being of a predicate in a subject (or attribute in a substance or attribute) in the order of logical 'in'. But this logical 'in' must itself be known 'at work', 'in actuality', 'in act'. And that being-at-work of Form 'in' Actuality cannot be determined in the logical order of 'being-in'.

We find in the actual working of our terms the formal requirement that they be 'at work' in an order of working which we cannot log-

ically determine. We name this order 'Actuality', and find that this name 'works' in fact, exemplifying, but not defining, what it names, which in this sense defines or expresses itself in the configuration of logical term and 'ontological' substance. 'Substance' which, indicated in the term *οὐσία*, is simply the 'first' actuality of a thing, as simply being itself. Being-itself: being what it is. And what it is, simply as substance, is the actuality of its *εἶδος*, 'form' or 'idea' - what is 'seen' or 'known'.

This actuality of form, then, is not actually distinct from its embodiment in an individual substance, but only logically distinct, psychologically distinguished or abstracted from its being-in an 'individual', an individual substance, in the act of thinking.

Thus we are back where we started the 'induction'. But now the logical circle of the 'formal' distinction of a 'form' and its reference to some substance, which first appeared as a question, has itself been inscribed in the Actuality which articulates converse 'logical' (or psychological) and 'physical' orders in question and definition. In this sense, the knowing which is the deductive inscription of the steps of induction (reversed) in the primary frame of the Actuality which distinguishes itself, in the configuration of definition, from what can be defined, may itself be said to be known. This in the 'conversion' or transfiguration of the limit of induction in the Question of definition, the definition of the logical order of definition itself. This 'knowing of knowing', or 'thinking of thinking', *νοήσας νοήσας νοήσας*, is the actuality of thinking simply as such. In book  $\Delta$  of the Metaphysics, Aristotle calls this actuality *Θεός*, God, divinity. This figure of God is exactly analogous to the *Νοῦς*, Reason of the Philebus, as actuality of Knowledge.

Thinking is an abstraction of form from the individual substance which is the object of Thought. Actuality is form 'at work' in a substance. What, then, are we to make of the knowing of knowing? Must we not say that this God is the Actuality of Form simply as such, as distinguishing itself from Matter in Matter, and that this is the actuality of Form (simply as such) in the unity of Form and Matter which is Actuality? For as 'thinking' God is the abstraction of the form of the object of thought from the object; yet this abstraction 'of' form from the union of form and matter simply as (the) Actuality (of form), is simply the actuality of Form itself, is simply the distinction of the primary principle of Distinction from what, in this, it determines as 'other' than itself.

age, involves, as we have just seen, the coordination of logical Difference and physical Movement (Change rather: movement in Space or locomotion is simply the physically 'first' movement, in which the form of movement (the actuality of a potentiality) must always be directly or indirectly embodied, physically inscribed). Logically, then, 'position' simply as such, involves the mirroring of the logical inscription of a term in a class - a term differentiated from other terms in that class (directly or indirectly) in relation to Matter - in the physical being of the corresponding form in a substance corresponding to the logical term or 'name', ὄνομα, 'noun'. The substance must be 'posited', directly or indirectly, in physical Space (the Place of all places or 'positions' in the broadest sense), and the 'predicate' in which the logical 'noun' is inscribed must involve a reference to 'movement', and so, directly or indirectly, a reference to Time. Thus the most elementary form of 'position' would be simply the spatial 'position' of a 'point', with implicit reference to its situation 'in' Time. Logically, this elementary 'position' amounts simply to an assertion of the actuality of the point: it is not posited 'in' any form in particular, and so might be said simply to imply Form as its actuality, just as the empty predicate 'is' by which the point is posited, implies the temporality of that εἶναι, 'verb' which complements, in principle, the 'noun' which posits the subject of the predication. Actuality is thus seen to be 'at work' in Space and Time, and the primary actuality corresponding to Form simply as such, is seen to be the radical principle of Movement, Actuality 'in' Time.

Yet this 'elementary' position, in which 'noun' and 'verb' are correlated with Space and Time, in which logical 'being-in' is found to be formally convertible with physical 'being-in', in the frame of assertion (of actuality), has no actuality in-itself. Actuality is not itself, for example 'a form': it is Form, which is not itself (as we have already seen) a logical 'genus' ( γένος ) or class. It is predicated of the 'term' considered simply as such 'analogously': Form is not contained in the logical domain of what is 'in' a class. It marks, rather, this formal(?) 'in' in words, this logical principle of 'definition' which is not itself comprehended in any definition. Actuality is thus only formally or 'analogously' predicated of a 'term'-in-general. It expresses itself by being seen - logically - not to be comprehended 'in' the logical order of 'in', of definition: it distinguishes itself from this logical order of 'in' as being (as it were) what this order itself is 'in' - but not logically.



- But what, then, is this 'other' of the Actuality of Form, this 'other' of Actuality? How can anything not be actual, and yet be 'other' than Actuality? Here, once more, is the question of the Sophist: what is the actuality of the formal distinction of Being and Non-being from which Being actually distinguishes itself? There 'its' nothingness lay in the lack of any actual identity in the Many particular things which were different from Being, the essential plurality of Difference. In the Philebus was found in this figure the Movement of the Different, the implication of the different images of One Good in a ceaseless movement, in which these images were constantly (themselves) changing, 'in movement'.

This figure of the distinction of Actuality from the 'psychical' and 'physical' actualities which in turn distinguish themselves from Difference and Movement, reappears to organise the Economy of Aristotle's World or Kosmos. 'Matter', formally distinguished from Form in the Actuality of Form simply as such, is, in itself, Nothing - or rather 'it' simply is not, except 'in' thought. And yet this 'nothing' is in a sense 'at work' in its logical determination as Difference, and its physical determination as Movement (or Change: κίνησις). Change 'is the actuality of the potentially existing, as existing potentially' (1). And paralleling this 'physical' actuality of the potential as potential, matter or potentiality as such appears 'logically' as the principle of differentiation of different instances of the same form, the 'principle of individuation' of individual substances.

We may say, then, that Actuality first distinguishes itself from the mere form or possibility of 'position' - almost as, in Parmenides' poem, Actuality as 'what is' distinguishes itself from the poetic frame of that symmetry of 'actual' and 'possible' in which Actuality might be imagined to be defined, given a 'beginning' both in the 'logical' and 'physical' senses of ἀρχή. It distinguishes itself from any 'image' of what it might be, from its inscription in - from its circumscription by - some limited 'poetic' frame of definition. Thus, 'ontologically' it distinguishes itself from the inscription of 'actuality' as term 'in' the logical frame of terms being-in classes. 'Psychologically' it distinguishes itself from the physical frame of 'position', from 'being-in' the physical order, as a form might be 'in' an individual thing.

Now this simple 'thesis' or position, this empty form of the im-  
1: Physics Γ 201A .

A direct corollary of this situation is the 'physical' side of the matter: position is not itself a substance - or rather the actuality of Time, in Movement, implicit in 'position' is not the primary actuality of a substance. Time and Place are rather only analogously said to 'be', since Form is no more comprehended 'in' the physical order than 'in' the logical order. The 'elementary' frame of position has no actuality in-itself: 'in' itself it is simply Nothing, purely 'open' or 'potential'. It must be considered as primarily in relation to the Actuality of Form, which distinguishes itself from its inscription - logically and physically - in this 'poetic' frame of position.

This, then, is the primary Actuality of Form: its distinguishing itself from the purely 'formal' abstraction which would seek to define Actuality, to inscribe it 'in' the logical order of definition. And the 'wisdom' which partakes in this self-expression of Form as Actuality, by returning - as it were from 'outside' the logical order of reflection to the logical order in which Actuality had first been inscribed as a question - may be said to 'know' the logical activity of abstraction, the actuality of thinking. At the same time is 'known' - again by σοφία rather than discursive ἐπιστήμη - the actuality of physical 'being-in', the 'first principles' of Physics(1). Most particularly, in this recognition of Actuality distinguishing itself from the 'poetic' order of which these 'logical' and 'physical' aspects are two sides, we find the frame of that 'first philosophy' - which may be called 'theology', but which we will refer to by the title given to those books which treat of such matters, as 'metaphysics'.

In the extended frame, then, of the configuration of terms by which (or in which) Actuality distinguishes itself from (what I call) the 'poetic' frame of position, we may find the logical frame in which Actuality first expresses itself, so defining the logical 'in' of definition strictly speaking. The terms of this frame - unlike the simple 'noun' and verb' of elementary position, will thus constitute the 'highest genera', the maximal extent of 'in' taken logically, rather than analogically.

First then, we must consider individual Substance - and first of these that two-sided Actuality of Reason and Being which, in the irreducible Relation of Form and Matter, is the principle of Form itself distinguishing itself from Matter, the Actuality of Kosmos as such, 'in'

1. Metaphysics Γ, 1005B1, Νηπινακων ἔκτασις V, 7; 1141a 33-66

which the other 'forms' (like 'relation') which together embody the primary configuration of Substance, have their 'being', οὐσία, 'substance'. Logically, indeed, we must say that Substance is itself only one term in the configuration: the reflection, as it were, of the 'analogical' Form that is the principle of configuration in the configuration. For Actuality only distinguishes itself from its inscription in the logical order of ἰδέσθαι and εἶδος and εἶδος, in that order of inscription. In a sense we must say that the primary expression of Actuality as simply Form, taken analogically, is the unity of theological Form and the merely formal abstraction of 'form' from an individual, in an individual substance - in the individual substances from which the 'induction' which led to the question of the definition of Being began. (Here we confront what Aristotle would have called a 'problem' or 'difficulty' in his exposition, which will eventually lead to that configuration of 'Analogy' which concludes this First Part of my exposition).

Substance, Relation.... 'Physically' we found that Place and Time were implicit in simple position; logically - and corresponding to this simple order of physical 'in', we noted subject and predicate, corresponding to individuation, 'Number', and the 'whatness' of Quality predicated. And finally we distinguished between the Action or actuality of Form under these two 'logical' and 'physical' aspects, and a corresponding 'open-ness' to such activity - which the Tradition has called Passion. Since the 'action' posited (of which 'position' is itself the minimal logical form) is primarily a limited action or actuality (or activity), intermediate, as it were, between the empty form of position, and the self-positing of Form which it mirrors in the individual action, the terms of the action relate to their implication in other actualities. So (perhaps) we might take as categories or highest genera that Posture and Possession by which the various terms (for example a human agent and the object of his action) relate to the context of the action. These two bring the table of categories up to the pythagorean Ten, but they might well be themselves included or comprehended under Relation (1).

In this configuration of 'categories' then, we may find Actuality 'at work', distinguishing itself from its inscription in the logical frame of the term in these terms or categories of term. How, though,

1: Ross, Aristotle, p22, gives the relevant texts.

is it at work, distinguishing itself in and from a term? What is this actuality of distinction, this 'psychological' actuality of thinking which knows Actuality by knowing its part in Actuality, this psychological actuality reflected in the merely formal distinctions of the logical order? What is the 'in' of the logical order, whose articulation determines Actuality as 'outside' this order of definition? (1)

We saw at the outset that this distinction of a term being 'in' a class or not (being 'outside' it) could not itself be 'logically' determined. This distinction, posed as a question in the Parmenides, and 'logically' determined by Plato's immediate successors at the Academy was that point where the logical 'induction' from subject to class to higher class reaches a limit. The limit cannot be determined by some 'deduction' of the differences of the categories from Actuality or Being as a common class or genus covering the categories as particular instances. The 'definition' of the categories is, as we have just seen, not 'logical' but 'metaphysical', 'ontological', indeed 'theological'. It rests upon the application of terms 'analogically' to the 'place' of logical 'being-in' 'in' Actuality, the part of thinking 'in' reality, 'in fact', in the World.

This configuration of the logical order 'in' Actuality is the limit of logical induction. Against the Old Academy Aristotle had argued that one cannot, in circular fashion, define the relations of logical and ontological orders, what is 'in' logic and 'outside' logic, in terms of the logical distinction of 'in' and 'out', being-in or not being-in a class. The logical process of induction by 'abstraction', beginning in the logical distinction of logical forms of distinction from the physical differences in which they are embodied (which is the beginning of reflection or thought, psychological activity distinguishing itself from the passive reception of form in 'sensing') cannot be applied to the formal distinction of two 'sides' of logical being-in. The actual difference of logical and ontological orders cannot be comprehended simply as a logical distinction. Rather must we understand the working of logical distinction in the wider Economy of Actuality as a whole, and this by recognising in the activity of thinking the working of that distinguishing by which we recognise this activity itself. The 'logical circle' of defining logical 'in' in terms of a logical opposition of logical class and ontological 'form' or 'idea' is only properly understood as inscribed in the 'working' of the categories in the recognition - in actual thinking - of the part of the

Only in the actual working of the terms corresponding to the categories, in the actual configuration of categories this working of the terms reflects, is constituted that logical 'in' and 'out' which logically articulated the thinking which recognises that this actuality of the categories is 'outside' logical determination or definition. Logical 'in' and 'out' cannot be determined simply 'in' logic. They are irreducibly implicated in the form of 'position', and in the actual configuration of the categories in terms of which the Actuality which is outside formal definition distinguishes itself from the logical order of the terms in which this distinction, its primary configuration, is described. One enters into the 'mystery' of the working of things - and most particularly into the working of the distinction of this our shared Actuality from Nothing, by finding oneself at work at finding oneself at work in Actuality.

Thus the logical order of articulation of 'being-in' a class, the logical composition of simple propositions of inclusion or exclusion in the 'syllogism' (συλλογισμός) of the Prior Analytics is seen (in Posterior Analytics and Metaphysics [I]) to be itself inscribed in a mirroring of logical and physical orders of 'position' expressed by the two 'axioms' which determine what it is to be logically 'in' a class:

Contradiction: A cannot be B and not B

Excluded Middle: A must be B or not B

A term, A, cannot (in the same respect at the same time) be in a class B and not in, excluded from, that class - and it must be either in the class or outside it. Thus the logical order of distinction of 'in' and 'out' of a class corresponds exactly to the 'abstraction' of logical 'in' and 'out' from the empty physical order of 'position' in Space and Time. The distinction of the two orders does not, then, occur simply 'in' logic (or 'Analytic' - 'analysis' being the inductive reduction of a question to its logically elementary components, from which deduction or 'synthesis' can proceed to resolve the question), and the 'logic' of being-in-a-class can only be understood in the actual configuration of 'position', and so in relation to the categories as actual frame of distinction of Actuality and term. In this relation, 'knowledge', properly speaking, is deduction from this elementary configuration of terms. One may call this 'theoretical knowledge' as distinct from a 'practical' knowledge which takes some more specific frame of deduction as starting-point in

rational framing activity, without knowing the principles of inscription of this 'practical' frame in the logical frame of the categories. This amounts, as it were, to an 'incomplete induction'. Aristotle calls knowledge of how to produce a certain 'outward' object or end 'productive'.

Mirroring, then, this order of thinking and syllogism, as the 'other side' of being-in (1), is a 'physical' order of Movement, κίνησις. How does the inscription of this order in Actuality mirror the inscription of the logical order just traced?

What, first of all, is the physical analogue of the logical order of syllogism, of that primary articulation of logical 'being-in'?

Let us consider again the mirroring of physical and logical orders in the figure of 'position'. We saw that the logical inscription of term in class corresponded directly to the physical presence of the form (logically constituting the class of terms corresponding to subjects embodying that form) in the substance corresponding to the logical subject-term. We saw the correlation, in the bare form of 'position', abstracted from any particular substance, of simple logical assertion and a physical 'point', 'in' time - this correlation corresponding to the simple actuality 'is', the bare form of the 'verb', ἐστίν. We saw that the logical abstraction of one 'side', a logical 'in', from this simple figure, led to the question of whether the two 'sides' of the figure, physical and logical 'in', could themselves be distinguished 'in' the logical order of abstraction - an order whose difference from the physical order of position must then be marked in terms of a physical difference of two positions in some common 'place' - and time. This supposed logical determination of the difference of physical and logical orders of 'in', as two sides of a logical distinction 'abstracted' from the symmetry of logical and physical orders of 'position', would amount, in effect, to the 'circular' pythagorising abstraction of a merely nominal 'form' from its actual implication in that Matter by which substances differ, and in which logical difference is thus ultimately, and irrevocably, rooted.

We were led, then, to see this logical figure of abstraction 'at work' in a wider configuration, in whose 'working' or actuality the logical 'in' according to which this working was logically articulated in a scheme of 'Categories', was itself constituted. The logical 'in' was only properly

1<sup>o</sup> Physics Δ 201A in discussion of different senses of 'in'

understood by our participation in this primary order of 'working' which marks itself in the logical order as 'outside' that abstraction. In this last step, from  $\xi\kappa\iota\sigma\tau\eta\mu$  to  $\sigma\delta\acute{\iota}\kappa$ , abstraction is found at work as the actuality of thinking, as Form distinguishing itself - for the form of thinking is the distinction of the form of its object from its matter: when thinking becomes the object of thinking, this is the simple actuality of Form as distinguishing itself.

In the physical order we begin with an 'abstraction' from the simple logical difference of position, and the constancy of matter and substantial form in the 'is' of movement, 'in time', from one position to the other. But just as we could not abstract logical difference from its correlation with the physical order in the 'working' of Actuality, nor can we abstract the physical order of movement from the 'working' of form - we cannot reduce form at work in matter to the simple mechanics of the atomists. Proceeding from the initial correlation of logical difference and physical movement, we may inscribe one movement in another as a component. But just as the logical difference of form and matter must eventually be inscribed in an actuality or working of differentiation, and this difference cannot be reduced to a mere 'formal', logical, abstract determination, so must the very actuality of movement distinguish itself - in fact - from an empty 'physical' configuration which cannot determine its own actuality. Why, for example, should some matter move from one position to another? Ultimately this must involve an invocation of what the matter is. The whole configuration of movements within movements must, like the logical articulation of 'in' which it reflects, itself be inscribed in the working of Form, and in the physical aspect or analogue of self-positing thought, the actuality of Form distinguishing itself in fact. Movement itself must be found 'at work' in the configuration of Categories in which thinking has already been discovered 'at work'..  $\Phi\upsilon\sigma\iota\sigma$ , 'nature', as principle of movement, must be primarily understood as how something works, as the figure of the actualisation of a potentiality, at work in Actuality. In this figure is to be found what something is, and there cannot be movement without something which is which moves. 'What something is' thus involves the matter in which it expresses itself - and from which its actuality is to distinguish itself as being-itself rather than indifferent matter (which 'in itself' is nothing, an empty term, a mere possibility of something-in-particular being). It involves that direction or 'finality' in which it is 'at work' in distinguishing itself from this matter: this is primarily how it is itself. And since, in its movement towards itself, towards its 'perfection' or complete self-

expression, it is not yet fully itself, it cannot itself, in general, have determined the beginning of its actualisation, the beginning of its distinction from its matter (this independence of 'final' and 'efficient' cause of the actuality of a form, its working in matter, amounts simply to the re-assertion of the irreducibility of the subject of movement to Movement simply as such). This difference of the initiation and completion of a movement is thus strictly correlative with the identity of the subject of movement in the actuality of its form distinguishing itself from the matter in which it is embodied. And this distinction as such is thus the primary actuality of Form as such distinguishing itself from Matter as such, in which all movement, insofar as it is actualisation of form, must be inscribed. This First Movement must, then, work as initiating itself. It must move constantly into the same form, and this form must in some sense be simply Time itself, or rather what distinguishes itself in change from the difference of beginning and end, the 'is' of Time itself, constant in all movement: Eternity. And all movements must be inscribed in this constancy of time through the inscription of that elementary component of movement (in time) from one position to another, in the always-identical movement of the Place of all these movements into itself - in the circular movement of an all-comprehending Sphere, 'in' which everything 'in' the physical order is. This Sphere itself, then, will not itself be 'in' the physical order, any more than its movement, and the principal of this movement will be properly 'in' any further Place, or 'in' any more radical order of Time. Rather does this moving Sphere constitute the physical order of Place and Time, places and times, just as the thinking which is the other side of this eternal 'is', this primary actuality, constitutes the logical 'in', without itself being comprehended 'in' this logical order. And these two complementary aspects of all things in the physico-logical order of Kosmos are related in the 'working' of the whole - in the Form whose logical articulation in thinking, and whose physical articulation in Movement and Change, are two aspects of a fundamental actuality or working, a self-distinguishing from 'Matter' in which logical Difference and physical Movement are first correlated in the simple figure of Position, *ἕξις*.

Movement and Change: for Aristotle sometimes distinguishes Movement in a restricted sense, when there is no change of substance, but only of place, quality or quantity, from Change in general, including the coming-to-be and passing-away of substance. Thus far I have



only considered the two 'sides' of Kosmos, logical (and psychological) and physical (and ontological) separately, finding in each case complementary limits of analysis in the simple figure of 'position', and an actuality of Form distinguishing itself, in actual substances, from the bare coordination of logical difference and physical movement in Matter, the mere possibility of Form.

These two limits of Matter and Form are arrived at by induction, by progressive abstraction, from the actual 'position', 'thesis' of some individual substance. How, from the parallel distinctions of Actuality as Form differentiating itself, in Matter, from Matter - from simple logical Difference and physical Movement - can we return to the working of the situation from which we started? How articulate the logical and physical orders of Kosmos between the two limits of Form and Matter in which they coincide, so as to reflect the Actuality by abstraction from which this primary Distinction has been discovered?

We might begin with the minimal integration of 'logical' and 'physical' sides of Matter in 'elementary' substances or 'elements', *στοιχεῖα*, the 'letters' from which, by successive iterations of the figure discovered in them of integration of the two 'sides' of Kosmos, a complete account might be constructed. Thus, since substance is embodied form, and form a principle of movement, and movement always at least the change of position of some 'matter' 'in time', we find as principles of elementary substance two correlative forms, one, as principle of movement serving as form in relation to the other, principle of reception of this first form. Each form defines itself in opposition to a 'privation' or relative absence of that form and its working. Then since movement is defined by change of place, and place by where something is in relation to other things, so the moving principle, 'hot', distinguishes itself by the separation of forms, and in particular its separation of itself from the stasis of its privation, 'cold' - its movement 'upwards'. Cold, then, might be said to be a principle of aggregation - but this only as a converse, a privation, of the differentiating and primary movement of hot.

The 'fluid' principle of reception of form, then, *θετ'μβιστ'*, is intermediary between aggregation and dissociation, and in the configuration of elementary forms cohering through a greater or lesser admixture of 'moist' (or its contrary 'dry'), hot and cold interact. Thus hot, when quite 'dry' distinguishes itself as the fire that moves away from cold dry

earth, whose stability makes its 'natural' place at the 'centre' - which in turn is simply the 'place' of Earth. Between these 'dry' extremes come the configurations cohering more or less by their moisture - cold aggregated fluid and hot dissociated air. Within this whole configuration, then, the interaction of the various components is governed by the primary agency of heat - but this as itself inseparably involved in its elementary combination with moist and dry. The principle of movement in all this is essentially linear: movement together or movement apart. Working down, though, from the circular movement of the Sphere of the fixed stars, one might associate the constant cycles of the heavens, inscribed one within the other - fifty-five in all - with a different principle of movement, abstracted or distinguished from the double duality, the two contraries, as elementary principles of change. One might call this 'fifth element' of the stars, distinguishing itself altogether from the four 'sublunary' elements below the sphere of the Moon, a sort of pure fire: distinguishing itself from the elements as does fire, but this not in the constant transformations of the elements, but rather as abstracted from all change of quality and quantity, and 'in' that change only 'accidentally' - as framing it in Time, but not itself being changed in the process.

Thus the primary cause of permutation of the four principles 'below' Aristotle takes to be the greater or lesser heat of the Sun, as it approaches and recedes from Earth in the course of the 'year'. In this way the primary 'efficient' cause of initiation of sublunary change is the First Movement of the outermost sphere, transmitted down through the lower spheres, and so effecting cyclical transformations of the 'elements'. The First Mover as simple Perfection, simply being-itself is also, ultimately, the final cause of all movement, in which all determinate distinction of being (or movement towards being-itself) is at some level inscribed. I do not know that Aristotle ever considers that the formal cause of any actuality is thus 'in God'. Certainly he leaves the relation of thinking and movement in the actuality of the First Mover unresolved.

Fifty-five cycles: Eudoxus and his fellow-academician Callippus had shown how the circular movements of the stars relative to the earth might be imitated by considering the stars fixed on spheres whose axes of rotation were in turn fixed in further rotating spheres, and so on.

Aristotle derives from this platonic 'harmonics' a physical model, which will allow - unlike the formal coordination of a mathematical harmonics with a geometrical 'physics' (or 'chemistry', applied physics), which leaves no place, or rather no matter, in which to incorporate the correlation of the heavenly frame of Time and the sublunary frame of generation, in a 'now',

Now this 'elementary' configuration of Movement and Difference 'in' Matter ('first' matter, the simple correlate of Form) has, corresponding to the logical difference of the two primary differences or 'contraries' (hot-cold, moist-dry), a psychological actuality. For the 'elementary' frame of interaction of the simplest substances abstracted (or rather, 'concreted') from a double difference is also (as was, indeed, earlier suggested) the frame of the Image, of 'Sense'. The differences of hot and cold and moist and dry are not simply empty oppositions, empty 'forms', but have an actuality of quality, 'whatness', psychologically distinguished from the physical embodiment of these 'qualities' or 'sensibles' in moving matter. One might call this elementary differentiation of formal principles from prime matter the 'possibility' of abstraction. - And, most importantly, the first actuality of abstraction, the first psychical or psychological actuality, distinguishing itself as form from first matter is that Time which, in the physical order, appears as the bare 'is' of Eternity which as First Movement, frames the physical order, but is not itself framed 'in' any time or place or physically prior action, mechanism, efficiency, 'working'.

For the 'is' of what will later be called logical or psychological 'intension' reflects, in this 'elementary' configuration of Movement and Difference in prime matter, the self-distinguishing Form which is also the First Mover. To the difference of position in 'place' which is the primary frame of movement, corresponds an identity of matter 'posited' at two different 'positions', over some time. This 'numerical' identity of the subject of change corresponds to the primary frame of differentiation of Form and Matter, which differentiation is, as we have seen, the primary working or actuality of Form. The first abstraction, corresponding to the psychological 'faculty' or potentiality of memory, is the abstraction of 'is' from the 'now' of undifferentiated 'position'. The first actuality of the form of distinction of form and matter (that is, the form whose complete actualisation or 'perfection' is thinking) is the abstraction of this 'is' from the simple spatial identity of the 'point', simple position, to the 'is' which is the common form of position at two different points, the is which is the simple psychological correlate of the first 'physical' (or ontological)

actuality of form (primarily the 'hot') distinguishing itself from the 'prime matter' which is only the 'logical' or empty marking in abstraction of the possibility of Form in general - in abst action from the actual form of the individual substance which is involved, directly or indirectly, in all position - even this formal positing of 'prime matter'.

The inscription of distinct movement in the wider 'movement' or mechanism of a more extensive 'working' of form is thus framed in the primary distinction of the physical actuality of form from matter 'in Time'. Indeed we earlier noted this same elementary mirroring of logical and physical 'sides' of elementary position 'in Time' when considering the configuration of predication as presented in the book On Interpretation: the 'verb' predicated as the logical class in which the subject is inscribed, has an essential reference (unlike the subject-term) to time. And this scheme of the mirroring of the logical 'in' of subject and predicate in the inscription of movements or changes, one 'within' the working of the other, in time, was implicit in the discussion of the physical scheme of differentiation of form (or 'formal cause') from matter (or 'material cause') in the correlation of 'initial' efficient cause, and the complete working-out of the distinction as final cause, the perfection of the form.

Now we may characterise the elementary scheme of substance, then, in a more systematic way, of which the categorial scheme of Form distinguishing itself simply as Actuality, and the minimal scheme of 'elementary' substance are extreme cases -

- The 'logical' difference of two terms, is coordinated, through Matter, with the physical change which is a transition from one term to the other. On the other hand, the logical form of the distinction of form and matter is correlated with the working-out of the form of the change (the 'what', the actuality of the change); through the inscription of this change or transition in the Time and Place that are the formal correlates of the psychological actuality of Form simply as self-positing, as God, the First Mover. These 'logical' and 'physical' sides of Kosmos are then themselves seen to be two aspects of a primary 'working' of Actuality, embodied in the scheme of the Categories, in which <sup>alone</sup> the economy of this distinction itself, and the constitution, the 'working' of logical and physical orders, can be 'comprehended'. - And this 'comprehension' or inscription of the working of logical and physical orders in Actuality as such, 'outside' the physical and logical orders, but inscribing itself in these orders as 'outside', is  $\sigma\delta\phi\iota\alpha$ .

What, then, is the place of this wisdom, *σοφία*, in the general Economy of Kosmos? How, first of all, can the psychological distinction of form and matter in an actual substance be inscribed in the physical order in which we actually distinguish these two sides? How do the various orders of working of Kosmos meet in the actual situation in which we find ourselves, from which we began, and whose 'comprehension' in the working of Kosmos is the perfection of what - of who - we are, and the primary finality of our inquiry, initiated, one must suppose in the first self-expression in us of that form of thinking, which alone of forms contains the principle of its own initiation, its own efficiency, and which Aristotle calls Active Reason?

- We will eventually find that about this principle of Active Reason there turns a configuration of questions, unresolved in the Economy of Aristotle's Kosmos, and which might be said to amount to what is radically 'open' in the closed circuit from initial induction to the rediscovery of the principle whose actualisation is initiated in this 'induction': the question attaching to this 'closure' of the System as such, and as 'informing' the scientific activity of Aristotle's 'School', just as the analogous 'cosmological' circuit of abstract Theory informs that Old Academy the criticism of which might be said to be the beginning of Aristotle's inquiry or induction, around the middle of the fourth century.

- First, though, let me trace the circuit which begins in the assertion of the primacy of form (or Forms, Ideas) at work, of which working the abstraction of thinking, of separation of form and matter, is simply one part, rather than a primary order of form in which the distinction of Form and Matter is itself to be formally determined in the generation of this actual Kosmos. I earlier noted that the 'metaphysical' assertion of this principle of 'working' was contemporaneous (around the middle of the century) with the earliest 'physiological' or biological investigations at Assos. This conjunction, at the beginning of the induction which eventually leads to the closed circuit of thinking which defines a cosmic Economy or System of working of the Whole, reflects a fundamental complementarity of the metaphysical frame of 'working' in general, and the workings of animate individual substance from which an induction proceeds to fill out - to 'flesh out', one might say, the bare metaphysical frame. It is animate substance, and rational human animality most particularly, which is central to the simple configuration of logical and physical orders in Time sketched

'a moment ago', 'above'.

How are the 'elementary' configuration of substance, and the 'final' configuration of Reason, integrated in this central animate substance?

The principle is fairly simple, though Aristotle goes into great detail in the elaboration of this simple principle or figure: As we saw, the elementary movements of the simplest substance are inscribed in the frame of heavenly Time, as the circuits of transformation of these elementary substances, effected by the circuits of the 'fifth element', the aetherial fire of the heavens. The simplest figure of these 'elementary circulation' might be presented in a figure:

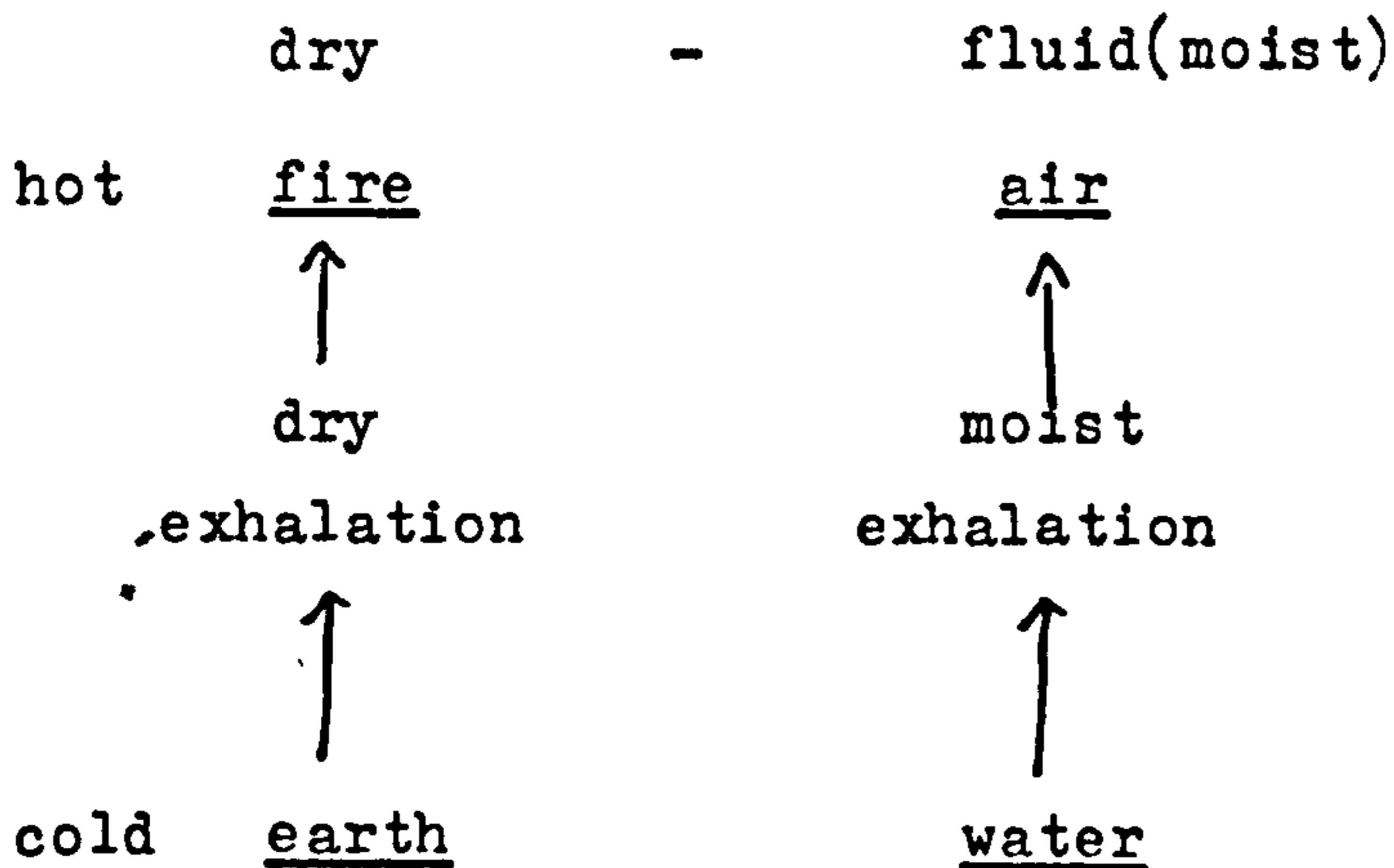

- a figure of the primary 'action' of solar heat (and, to a lesser extent, of the heat of the other heavenly bodies). This activity (thus inscribed in the complementary efficient and final orders of heavenly actuality, through the Reason which is the principle of movement of each sphere, inscribed within the primary actuality of the sphere of Heaven as a whole) is complemented (just as heat is complemented by cold) by a corresponding condensation, appearing, for example, as rain. Together these principles generate a complex configuration of relative movements of the elements, allowing sometimes the organisation by heat of a moist coherence of elements in a certain λόγος, 'formula', proportion, that may work, in this general transformation or circulation of matter, to preserve this same formula or elementary 'living' form, as it organises the integration of further matter in its constant frame or form (this through a certain stable configuration of the various actualit-

ies or 'workings' of the constituent elements, in the elementary configuration of their transformations in which the simple 'animal' finds itself).

More generally, such simple living 'tissue' can only work to maintain its form within the configuration of different tissues (homoeomerous living substance, of which each part has the same form as the whole), an 'organ' that, in turn, preserves its form by the way it 'works', the job or function it performs, in the working of an animal as a whole of organs and tissues, their workings integrated in the working of the animal as a whole, a working which is simply the 'is' of maintenance of form, and its 'natural' tendency to full actuality, differentiation from the matter or matters from which it is physically constituted. (As we saw, the logical books of the 'corpus' may be considered an 'organ' of inquiry-  $\theta\epsilon\tau\alpha\nu\sigma\nu$  - this is Aristotle's name for them, whose actuality must be understood in the Actuality or working of the System as a whole, in which they play their part),

This functional articulation of the organism may serve as the basis of a 'classification' of animals according to 'form' - in 'genera' and 'species': one might reasonably suppose that it was the inductive elaboration of such a physiological scheme that was begun with those observations in the Troad which seem to constitute the earliest material in the 'biological' books. Thus the genus 'animal', simply as such, is defined by that preservation of form, that 'elementary' form which articulates the elements in a repetition of the articulating form itself  $\Rightarrow$  that form of a natural body that we call 'life',  $\psi\chi\eta$ . On the 'elementary' level of the tissue, this 'life' must thus involve at least the form of nourishment, of 'growth', which is the perpetuation of a form which organises elements in that form. Aristotle considers that such 'elementary' life may arise out of, say, mud lying in the Sun's heat, by a simple 'spontaneous generation' or coming-into being. But generally the principle of growth and nourishment involves also a principle of repetition of the growing form in 'another' instance, through the externalisation of matter embodying the form of the 'animal' in its 'seed'. The life of plants is articulated, then, in a simple cycle of growth and such 'repetition' or 'reproduction' of the plant's form through the principle of 'seed' embodying the form in its minimal expression.

- Within the general form, then, of Life, the actuality of 'animate' or living form - of which fire may almost be taken as the limiting expression, differentiating elements, and so concentrating this very form and principle of differentiation itself - we may distinguish plants from 'animals' in the stricter sense. Rather than saying that Life is fire or heat, we should say that Life is heat organising a configuration of 'elements' working together to maintain - and so distinguish from its mere possibility in matter - a definite form. Fire, animal heat, may then be said to be the principle of Life in general, as working through a specific form, a 'species' maintaining its actuality through successive growth, reproduction, and decline or decay in its individual 'members'.

These 'animals' in the strict sense may be distinguished from 'plants' 'planted' in the surface of Earth by an additional faculty and finality of movement in place, 'locomotion' to a place where the configuration of elements may provide 'better' nutrition. This faculty of movement thus implies some principle of distinguishing better from poorer nutrition, and this is sensation which, as we saw, distinguishes the simple principles of the elements - and thus, integrated in the form or working of the growing organism as a whole, may serve to distinguish 'food' or nutrition of the form required for the fullest actuality of the animal (or species). In the complete organism the 'organs' of sensation (which, consisting of the same matter as the form sensed, are 'receptive' of that form, this reception of the form of an object of sense being 'sensation') are integrated with the 'organs' of locomotion, so that the animal 'works' and perseveres in his form by moving towards the best nutriment sensed. The nutriment is then first integrated in the form of the animal, 'assimilated', in the blood, by being itself disintegrated into its elements by the 'digestion' which is a kind of 'cooking' by the animal heat in the organs of assimilation. From the blood are then derived the nutrients of the various organs - and from over-rich blood is produced an additional embodiment of the form of the animal as a whole in 'male' semen or 'female' menses - the latter serving, in 'sexual' reproduction, as first matter for the former.

In this 'animal' configuration and its working the primary organ might naturally be taken to be the heart, the organ 'informing' the working of the blood in which the matter of the animal has been assimilated in an as yet undifferentiated form. This heart may then, naturally enough, be taken, on the 'formal' level, as receptive of the various 'impressions' of forms on the special senses, 'assimilating' these to the form of 'com-



mon sense' much as the blood assimilates the common matter from which all organs - including those of the 'special' senses - are differentiated. With the heart may be associated the working of that 'imagination' which, one way or another, amounts to the reception of a form in the heart, which is not the form of anything impressed on sense organs from without - or any combination or correlation of these in 'common sense'. - And with it is also associated that form of distinction of form and matter by which is sensed - in 'self-consciousness' - sensation itself: a correlate of the 'object' of sensation, which is not perceived by the 'special senses', but only in the correlation of these in the frame of 'common sense'. Thus the heart is the seat also of the 'positing' or position of the form of an object which is not in fact affecting the senses from without, but which corresponds to an aspect of such an object in 'imagination'. It is this 'positing' of a finality 'in imagination' which, as desire, relates sensation and movement. And it is this 'faculty' or ability to 'take on' the form of position which allows the activity of thinking in Man.

The principle of abstraction of form from matter, which first appears in the reception by the special senses of the form, or rather a form, an aspect of the form, of an 'outside' object, and which in thought is itself actualised in common sense - in the heart - is thus 'framed' in 'imagination'. And, as we have already seen, the primary 'dimension' in which 'imagination', the Image, is articulated in Time: imagination is correlative with the function or 'faculty' of a Memory which abstracts from the inarticulate 'now' of present sensation, and posits an Action extended over time. For example it allows us to posit an imagined sensation as 'past', to recognise an actuality of that sensation 'in' the form of 'the past', allows 'experience', *ἐμπειρία*, to be articulated in the frame of a Time in which logical and physical orders are correlated, and a 'practical' order of conception elaborated.

The next step of abstraction, from the Imagination of Common Sense to the faculty of Thinking, embodied in sublunary matter by Man alone, completes the abstraction of Form from Matter that begins in sensation. But this second abstraction (if the abstraction 'in Time' from Sensation to the Imagination of Common Sense be the first) is not a simple iteration of that primary work of abstraction. Indeed that primary 'working' or faculty can only be properly understood in relation to the Active Reason which informs Thought. For the possibility or potentiality in the forms thus far discovered in Common Sense - the 'positing' of an object as

'behind' (as it were) the sensations of the special senses, in their common frame of Place and Time and specific differences, and the correlative form of distinction of form and matter in general, by which we perceive that we perceive, already embodies the formal configuration of thinking. This formal possibility of thinking is called Passive Reason. What more than this form of thinking already implicit in Common Sense, then, is involved in actual thinking? Here we find a strange circularity: what is additional to this configuration of forms in which thinking is - as soon as we think about it - implied, is simply the actuality of this possibility of thinking, its actualisation. The forms of (in) Passive Reason are the matter of Active Reason - but this distinction is itself formally inscribed in Passive Reason. What is the difference between this potential distinction of Active and Passive Reason in Passive Reason, and the actualisation of this distinction in Active Reason? This circularity by which Active Reason defines or posits its own actuality amounts, in Aristotle's terms to what, in the coming-to-be of Man 'alone comes in, over and above (the elements) from outside, and is alone divine' (1), and it is somehow like the element of the stars (in their association with their 'Intelligences' or moving principles) in its embodiment. This 'circularity' of Active Reason, indeed, corresponding to ethical finality, choice, the human faculty of rationally initiating action, of determining independently of mechanism the actualisation of a certain form as the finality in relation to which rational action is initiated, partakes of that divinity which is thought thinking thought, the Form which defines itself by distinguishing itself as 'outside' the empty logical and physical orders which constitute the bare frame of Actuality abstracted from its working, a bare formal possibility of Actuality. It is this Active Reason, we might say, which distinguishes the actual order of thinking from the purely 'imaginary', the simply formal, circularity by which one might suppose the logical 'in' to be defined by a distinction of the logical and physical orders of the mark (of position) abstracted (through this distinction) from the physical order in which the distinction is marked. This purely imaginary self-determination of formal distinction might then be associated with Passive Reason, actualised when the working of this 'empty' logical order of distinction is understood in its part in the working of Actuality as such (rather than its simple 'logical' articulation as a term) in the frame logically articulated in terms of the Categories.

1: On the Coming-to-be of Animals, 736<sup>b</sup>27-8 - cf 736<sup>b</sup>85-2 context  
736<sup>a</sup>24-7.

That is: we reach here, in the consideration of Active Reason, the Actuality of Reason (rather than its merely formal or logical articulation in the physical scheme of the human animal) just that question of the inscription of the logical 'being-in' in Actuality, and the recognition that Being is 'outside' the logical order of classes, which must be themselves understood in terms of the constitution or 'working' of this logical order in the actuality of our thinking. And we reach the parallel recognition that our actuality, inscribed according to the articulation of our imagination, sensibility and embodiment in the 'form' of Active Reason, here distinguishes itself - as our very actuality, or actual power of action (my recognition<sup>and assertion</sup>/that it is I who am now writing, for example, rather than myself or somebody else imagining when they write this that they are the 'I' that writes that it writes) from the empty 'physical' configuration of a bodily mechanism that might or might not actually be me. In a wider frame, this recognition parallels Actuality actually marking or expressing the distinction between a possible physical order of Movement, and the actuality of the First Movement in which, as the 'is' of Time, the movements of (say) this writing or your reading are actually inscribed. The relation of this Active Reason and the God of the Metaphysics and First Mover of the Physics and On the Heavens is not clear and occasioned much subsequent controversy. <sup>Perhaps</sup> ~~The~~ best that one can say on the basis of the various texts where the Active Reason is treated or alluded to, is that it somehow corresponds to our participation in the form of divinity as σοφία, 'wisdom', the actual knowledge of the act of knowing, in which the specific knowledge of particular substances must be, in the end, inscribed, if it is to be truly knowledge.

We have not quite (yet) come full-circle: for this discovery in ourselves of Active Reason, responding, as it were, to the finality of our - and Aristotle's - Inquiry, has not yet determined the inscription of this activity and finality of Inquiry in the Kosmos which it is understanding, as it proceeds (this much it now knows) towards the recognition of its own place and actuality in this Kosmos as its own finality, its self-positing as the perfection of its form.

We have discovered the principle of human finality, though, in the rational choice in which the primary actuality in us of Active Reason

articulates our rational activity in relation to that 'end' or 'good' or finality which is simply the participation in this rationality which freely initiates the movement towards the fuller recognition that this free activity is itself the highest Good, a participation in divinity. As this recognition is reached by induction, by inquiry, and this inquiry must itself be pursued by embodied individual human 'substances' or beings, we must ask about the place of this Inquiry in human life in general, and the articulation of human life in relation to the Good found by induction to be most directly expressed as the actualisation of (Active) Reason in or through this movement of Inquiry towards an understanding of the principle of this movement as Good and Reason.

Now, a 'good' is what is the object of a choice, a true good the object of rational choice, choice-like true knowledge - 'according to causes' or following the order or working of things. By analogy with the order of form and theoretical knowledge, the practical knowledge of good or goods must be arrived at by induction from the results of particular choices - by 'learning' - or, if this learning is itself articulated according to a prior knowledge of the good in the teacher, by 'education'. Again by analogy with theoretical induction, this practical knowledge will be a knowledge of the coordination or 'right proportion' of partial goods, subordinate finalities, in actual choices (this leads Aristotle to a rather vague emphasis on virtue as a 'mean' or intermediate between contraries, even though, in his classification of animals, he understands that the articulation of genera in specific differences cannot proceed simply <sup>(binary)</sup> by 'division' into contraries inscribed within contraries until the highest genus is reached). The end of education will then be the complete induction which leads beyond the practical recognition of particular goods in particular kinds of situation to the <sup>theoretical</sup> recognition of the common principle of good in all specific goods, to 'wisdom'.

One might note here, in passing, that there is no consideration of that 'circular' principle of the choice involved in defining the situation of choice, and so the choice to be made. Yet this circularity is itself an analogue of the circular 'actuality' of Reason and its 'freedom' (from mechanical economy of Matter) in which alone choice has any sense or actuality. As we will see, this fundamental principle, earlier (at the beginning of

this Part One) identified as the simple figure of Mystery, in which Mystery inscribes itself in Economy as distinguishing itself from Economy, amounts to the most radical criticism of the aristotelian Economy of Kosmos: for Aristotle's initial choice of Inquiry as the Method by which to determine this same Inquiry as the highest good will be seen, itself, to unwittingly partake of this same order of circularity, instituted in his School in abstraction from 'pythagorising' mystification. The 'next step' after the elaboration of the peripatetic frame of Inquiry is constituted by the inscription of this simple mystery of Choice in two rather 'simplistic' systems or schemes, in which Inquiry is simply one secondary element in a primary dramatic frame of activity - the choice of this frame (stoic or epicurean) being of far greater practical importance, in the frame, than any inquiries which might have led to such a choice, or which might proceed within it.

Insofar as 'learning' of virtue, or the principles of finality, does not reach that participation in wisdom or Reason knowing itself by which the induction or inquiry into virtue comes full-circle, it remains the incomplete 'practical' knowledge and exercise of 'moral' virtues. The highest of these, μεγαλοψυχία, 'greatness of soul', corresponds to the virtue of the man who, knowing the articulation of good in the frame in which he acts, recognises his own <sup>part or</sup> place in this activity.

Higher still, though, than this - as the wisdom which comprehends the axioms of the logical order is higher than the deductive knowledge of relations within the logical order - is the theoretical wisdom - this same σοφία - which participates in the actuality of Reason in which the frame of human activity, and the working of it of Reason as the highest good, is itself constituted and comprehended. As this 'intellectual' virtue is the virtue in which all other virtues are thus 'comprehended', activity over a life which is the actualisation of this virtue of Reason in our humanity, is, as Aristotle sees it the highest 'happiness', the most complete participation of the soul or personality, of our individual form (as ~~one~~ primary actuality) in Good; εὐδαιμονία. This is the closest approach of our form to its finality of self-position in the choice of this movement towards such a coincidence of formal and final cause, which itself is already in part embodied in this free initiation of <sup>a</sup> movement towards itself. (And this finality as the perfection of Form simply as such must be the God of Metaphysics Λ, and the First Mover of the Physics).

What, then, is the 'theoretical' comprehension of this 'frame of activity', in which the highest 'moral' or practical knowledge is the knowledge of our part in that frame (which then reflects the highest 'intellectual' virtue of knowledge of our part in the wider frame of Kosmos in which human Community, like the logical order of 'being-in', is constituted) ? What is the wisdom which 'comprehends' the 'ethical' order of inscription of one finality within another, within the 'political' community of our interaction? What, that is, is the finality of the community or political order (the State), in which the finality of our individual activity is to be inscribed? Its end must surely be the integration of the ends of individuals in a common end, the perfection of that common humanity of the individual citizens - just as the 'form' of community in which this finality is at work, moving towards itself in initiating a rational political order, is simply the integration of individual activities within the activity, the 'working' of the State or Community as a whole or unity. Thus the end of the State is the 'good life', the happiness of the individual, which can only be fully actualised in participation in such a community of ends: for the happiness of the individual is the practice of that Virtue which is participation, directly or indirectly, of Reason, Form, moving of itself toward perfect self-expression: this movement of Perfection is itself the actuality of Good, by inscription in which all partial goods are partly good.

This information of human Community - of our common humanity - by Reason, expressing itself in the rational direction of our affairs towards a common good, expresses itself in the 'political' direction of the State. The 'ideal' constitution of the State would simply reflect the constitution of the wider frame of Kosmos: government by a 'godlike man'. - But actual states, unlike Kosmos, must be understood in their practical integration in a wider context. A state is, as it were, only (like the philosophical practitioner of intellectual virtue) moving towards the realisation of such an ideal, and this within the material economy of its embodiment. The primary ill or pathology of the state, which must be balanced in a practical constitution is thus the subordination of political direction to an unenlightened economy of individual ends. This inversion of the best order is exemplified by the organisation of the exchange of 'goods' by an individual's end of monetary profit. It is this embodiment of the partial economy of individual ends in the rivalry of a rich and poor class, oligarchy and democracy (the latter leading, almost inevitably, to tyranny) that the true end of the state is lost sight of, and disintegration, the perver-

sion of the State begins. Practically the best constitution thus appears to lie in the balancing of political direction and the economy of not-altogether-rational individual ends in the power of a 'middle class' whose interests lie in the preservation of that integration of political direction and individual interest embodied in the Assembly and courts of Law. Such a constitution is analogous to the integration of rational soul and desire in the human constitution of the individual citizens - and in this configuration we at last find the place of Inquiry and Education in the Kosmos it reveals.

For in this configuration of the practical wisdom of the individual citizen at work in the practical management of affairs, Education, and the Inquiry it articulates according to a wisdom which is itself the result or perfection of Inquiry, amounts to an analogue in the Constitution of the State to the Active Reason in the individual. In the simple mirroring of the 'form' or activity of the individual citizen in the form or activity of the State, Education amounts to the self-moving actualisation of a common form of humanity, expressing itself in the extension of moral virtue in that process of widening integration of individual finality in the common finality of the Community, which itself makes the good of this movement more apparent - the life and health of the State, actualising the form of humanity. And the end of Education, towards which this 'inductive' movement finally leads, is just the intellectual virtue which sees, at the end of Inquiry, this movement through practical knowledge to theoretical wisdom, as the highest human good: the participation in the actualisation in Matter of the self-expression of Form. And this possession of this highest good Aristotle calls 'contemplation', *θεωρία*.

Thus, once again, in *θεωρία*, Reflection comes full-circle to find its part in the Kosmos it reveals. *θεωρία* is the 'perfection' of Inquiry, the recognition in Form distinguishing itself as primarily this activity of distinguishing itself, of the finality 'at work' in Inquiry from the start. - From that initiation of (this) inquiry in the recognition of the constitution of 'logical' form, logical 'in' in the actual activity of thinking, 'at work' in the frame of the Categories. - And in the parallel recognition of an 'ontological' actuality of form 'at work' in the 'physical' order of Change. Passing then to the integration of these two orders in the rational animal, and to the 'ethical' articulation of the

finality of Reason, and to the final self-expression of Form, Actuality, in the *θεωρία* which is a participation of our reason in the Good which distinguishes itself in the State as frame of our activity, from the elementary coordination of the logical and physical orders of Action or 'working', which is 'at work' in the (merely) practical articulation of our activity. The Induction, beginning with the bare act of 'position', the minimal act of assertion, now returns, closes upon itself, as the self-assertion of Method in the aristotelian Education instituted in the State of Athens as a School, the Lyceum.

- A School, with a 'life' of its own - a frame or framing of Inquiry in which this framing is itself inscribed, so that its relations in a Kosmos it frames, can themselves be 'assimilated' to the 'working' of this frame or form of Inquiry. Assimilated, inscribed in the Economy of that frame, unquestionable since it determines, from the limit of induction and questioning in the empty form of 'position', the order of questioning itself. In this 'circular' self-assertion of Inquiry in a Kosmos it frames lies the very working of the Method and the School.

- An 'Economy' of Kosmos, a universal frame in which every question has its place, inscribed within a series of questions-within-questions, an induction leading at last to the question of the bare 'working' of the logical, physical, or ethical order, and to Kosmos as simply What Works, Actuality - which 'works', actually works to show that Actuality simply is what works. From this unquestionable self-expression, then - in which Actuality simply expresses its 'nature' as self-expression, as the Form of distinction of Form and Matter in Matter, in the primary frame of 'Action' or 'working' - the deduction 'works back' to resolve the initial question.

- An Economy in which the various orders of earlier 'theory', embodying, as through an incomplete induction, some image of the simple self-expression of Actuality in the frame of the Question, are themselves inscribed, their particular limitations subject to Aristotle's questioning in those 'inductions' from earlier theory which constitute the introductions to the various sections of the 'system', in which the framing of such a section is deduced - we have already noted the place of the summary of pythagorean 'theory' in the first book (A) of the Metaphysics. Aristotle thus plays the Critic, standing 'outside' the various short-circuits of earlier theory, and inscribing their limited 'workings' in an



induction framed in the 'logical' order of working of theory simply as such, presented by him as an introduction to the other works as a whole, an introduction which does not proceed (like introductions to sections of the system) by the consideration of earlier theories, for here, as Aristotle tells us at the close of this general introduction, he has had no predecessor(1).

- An Economy, that is, framed in the logical circuit of the Question taken simply as such, as simple complement of assertion or position, in which the various 'short-circuits' of earlier steps in the 'induction' towards this general Economy are themselves inscribed, like the subordinate heavenly cycles within the First Movement of the Sphere of Kosmos, in which the physical economy of the whole is inscribed, mirroring the logical economy of Thought, inscribed within that thinking of thinking which is the formal actuality of this same First Movement. - And the inscription of the 'logical', 'physical' and 'ethical' frames of the Parmenides, Timaeus and Laws in the Economy of the Question, of which these are, as we have seen, primary and correlative orders, amounts, as was suggested at the outset, to one simple 'step' from the last configuration of Plato's reflection - and a simple converse of that 'pythagorising' step by which the Academy continued the same configuration of reflection.

Where the Old Academy 'turns Philosophy into Mathematics', integrating the Question of the Parmenides with the physical frame of the Timaeus, by identifying the self-assertion of the One which resolves the dialectical or logical symmetry of One and Indefinite Dyad, with the primary Act or Actuality of Creation, and proceeding to articulate Kosmos within mathematical Symmetry, Aristotle has construed this mathematical frame, the model of Science in the Posterior Analytics, as simply a 'short-circuit' of Kosmos by the abstraction of the 'logical' order of 'position' (and the correlative psychical order of self-positing Thought) from its actual context. In Aristotle's Economy this 'mathematical' order of 'applied logic' - this order of 'analysis' and 'synthesis' (induction and deduction) abstracted from the primary 'position' of an individual substance to the empty form of 'position' in the point and its unity or identity, might be said to be complemented by a 'medical' or physiological frame of Observation, insofar as the frames of these two sciences meet, in that Economy, and in their 'theoretical' limits, or first principles, the logical and physical (or rather, 'psychological') orders from which, around the middle of the transition

from the first pythagoreans to the last writings of Plato, they had been abstracted by Hippocrates of Chios and Hippocrates of Kos. - And these 'logical' and 'physical' orders, presented around that same time by Philolaus and the Atomists respectively, themselves find their parts as two 'sides' of Aristotle's Kosmos, this integration in many ways reflecting the empedoclean scheme from which these two 'sides' might be taken to be converse developments.

I paralleled that athenian economy of competing theories, at the beginning of the peloponnesian war; with a wider athenian economy of greek political organisation at that time, and I later suggested a relation between the athenian recognition of macedonian aims, around the middle of the fourth century and the transition in Reflection marked by Plato's death and Aristotle's departure from Athens. Indeed, Aristotle's elaboration of the Economy of Reflection or Inquiry parallels the macedonian integration of Greece, and of this Greece with the World from which it was marking its independence, its autonomy, around the time of the first pythagoreans. Aristotle's pupil Alexander might be said, in a way, to have fulfilled his teacher's scheme of the 'great-souled' man who knows his part in the frame of his activity - but in the interpretation of that part he did not remain within the limits of the city-state. His part was rather to integrate within the frame of his activity the two 'sides' of that frame as marked at some particular point in his progress. The man of action whose activity has not attained to the intellectual vision of his part in Kosmos cannot be expected to understand the limits recognised in contemplation to the best size of State. He must try and integrate the relations of 'within' and 'without' any apparently arbitrary limit to his power, within the range of his action, just as the student who has not attained to the intellectual vision of the limits in which the logical order of 'in' and 'out' is constituted, must try and reach a logical determination of the relations of 'within' and 'without' such limits.

By the time of his early death in Babylon in 323, Alexander had more or less 'induced' his Army to extend his frame of activity throughout 'the World', and rebelled (like the student of logic) - so runs the story - at the thought that 'there were no more worlds to conquer'. With his death the passing unity of his authority immediately fell to pieces (but the World as frame of greek activity remained) and Athens (for example) rebelled. Aristotle, facing (like so many others before him) a charge of 'impiety', left for Chalcis where he died the

following year. To the Lyceum, or rather to Theophrastus (who had left the Academy for the Lyceum) whom he had appointed as his successor, he left his Library - the largest then known, the first Research Library (one might say) of Antiquity. - When around the end of the century the first Ptolemy (that general of Alexander's who, following the latter's death made himself master of Egypt) engaged Theophrastus' pupil and eventual successor Strato to set up a School (in the alexandrian Museum or Temple of the Muses), he at the same time engaged his fellow-peripatetic Demetrius of Phaleron to set up a Library. These parallel 'institutions' mark another step in the Tradition - from, say, about 331: Alexander's foundation of the model capital of Egypt, and his journey through the libyan desert to the oracle of Amun-Ra, the Hidden Sun, where he was recognised as the son of God - a dramatic vision of his part in affairs that Aristotle, despite his ideal of rule by a 'godlike man', must have found hard to countenance.

Ptolemy I Soter - the 'Guardian' - proclaimed himself King in 304, founding a line that did, more or less, 'preserve' Alexandria from the disorders following Alexander's death (in Syria and the East, but most particularly in Hellas itself) down to the incorporation of Egypt in the Roman Empire in 30. The Ptolemies maintained the Museum and Library as a sort of scientific and educational department of the State, Inquiry abstracted from the question of the relation of the closed circuit of aristotelian theory in which it was instituted (or which was instituted in it) to its context. Most notably, this Inquiry was 'abstracted' from the aristotelian answer to that question, as the inscription of the ethical or political frame of Education and Inquiry, in the scheme of Inquiry itself. The rule of the Ptolemies was not 'in question': rather was aristotelian abstraction instituted 'from without' in the practical or political frame of the model City, with its School modelled on the Lyceum, but engaged exclusively in the methodical application of the aristotelian frame to various orders of questions within the instituted abstraction of the School, not itself open to question.

Strato, the first head of the Museum, was called *ὁ φυσικός*, the Physicist, from his emphasis on the 'physical' side of the System - he may well be the author of the Mechanics later ascribed to Aristotle himself, in which elementary mathematical 'symmetries' are applied to the 'logic' of the elementary 'physical' scheme of Movement. Demetrius of Phaleron instituted the 'applied poetics' that characterised the literary

systematising of the Library, and by the middle of the third century, around the time of Ptolemy II Philadelphus' death, the activity of the alexandrian School was dominated by what I have suggested may be taken to be the three primary expression of 'applied theory' - the Mathematics of Euclid, Aristarchus and Apollonius, the Medecine of Herophilus and Aristotle's grandson Erasistratus, and the 'Music' - or 'Philology' (or 'Grammar') - of the great librarians. This exemplary configuration around the middle of the century may be taken to mark a mid-point of that phase of the Tradition (the first 'half' of the First Part treated in this section) which leads from the first pythagoreans to the beginning of our Era.

The 'abstraction' from the limiting circuit of Aristotle's theoretical Economy of Kosmos (from the discovery, as the finality of Inquiry, of its proper place in Kosmos - just as the finality of the elements is to find their 'proper place') to this alexandrian figure of Application, amounts, as will perhaps be evident, to a simple 'figure' or scheme of 'abstraction' from the fundamental 'ethical' frame of Aristotle's Inquiry, from the questioning, within Inquiry, of Inquiry itself as one 'activity' among others. At Alexandria the 'activity' or 'work' of Inquiry was a fairly secure 'job', within the frame of the State whose direction was somebody else's business or job. These different 'economies' of School and Government had their different parts in the City that had succeeded Athens as the economic centre of a hellenistic (rather than hellenic) World. A simple abstraction is effected from the inscription of such 'political' economy in the wider economy of Aristotle's Kosmos, to the 'political' inscription of Inquiry and the School within the primary frame of the State, itself abstracted from its part in the cosmic order of Heaven and Earth, to the practical management of political and economic activity in a fairly disordered greek World - or rather, graeco-oriental World.

On the other side of the Sea, in Athens, a complementary 'abstraction' from the systematic theoretical Economy of Kosmos develops, paralleling the alexandrian School, presenting, as it were, the other side of a common figure of the 'application' of Theory.

- But is not all this business of 'figures' and 'sides' and 'parallels' very 'schematic'? .. too schematic? What relation does it bear to the irreducible implication of such figures, schemes, in the unlimited material of History?

- This is just the point, it will be remembered where Aristotle's complaint against the Old Academy came in. Indeed, is the schematic inscription of 'Aristotle's Economy of Kosmos' in the circle of a complete induction from the simple figure of the Question, of Position, true to Aristotle's 'position' in Reflection?

... But then.. to the extent that such 'schemes' are 'at work' in Aristotle's text, do they not amount to a certain 'actuality' - which corresponds, indeed, to the very figure of Truth as the inscription of the actuality or 'form', working, of the object, in the bare form of distinction of Form (distinguishing itself) from the material in which it is embedded?

... And does not Aristotle himself tell us that 'Poetry has more truth than History' because it presents the elements of History, of that open possibility of unlimited accounting, inscribed in the closed form of an Action? (1) And then, again, is not the subsequent athenian criticism of unlimited Inquiry precisely - and avowedly, purposely - schematic? .. inscribed in this same figure of 'poetic' or rather, 'dramatic' truth? And, moreover, is not this poetic closure of Truth itself embodied in the circuit of Aristotle's reflection, which arrives back at the point whence the whole Induction or Inquiry began? And is not this 'theory' thus in some sense an example of that form of 'practical' knowledge which is theoretically opposed to theory? And does it not belong also to that 'productive' art of Rhetoric which knows how to articulate an argument or inquiry in relation to a certain end - in this case a 'theoretical' determination of theory as the frame of deliberation (determination, decision)? Why should one choose that way of determining the frame of choice, and so of Action? Might not the 'dramatic truth' of finding one's part in Active Reason through seeing how, in a book one is reading, the part of this reading in Active Reason is described, itself be an abstraction from a more radical Drama? - Just as this Active Reason is, in a way, an abstraction (like Parmenides' Truth) from the interaction of 'inside' and 'outside' the elementary 'poetic' frame of Action simply as an open possibility, from an actuality of Choice, in which the self-expression of Active Reason interacts in the individual substance of a particular agent or protagonist, with that empty frame of an 'Action', in which the physical and logical orders of 'position' are first integrated, on the 'elementary' level of simple potentiality or possibility?

In tracing the circuit of Aristotle's Inquiry from the primary 'logical' determination of this elementary frame as Position in Thought, *θέσις*, to the 'position' of this starting-point in a Kosmos unfolded

from it as theoretical origin (like the 'point' in Euclid's Elements), the two works devoted to the 'poetic' or 'productive' frame of Action were left 'out'. Now, if we turn to the Rhetoric and (incomplete) Poetics, we find, in the latter, that its inscription 'in' the corpus, as an account of 'dramatic truth' in terms of the theoretical Economy of Kosmos, is reflected in an account of the 'working' of Drama as a sort of abstraction from the autonomy of that Imagination which we have found to constitute an intermediate order between elementary sensation and the abstraction of Thought, a common frame of Time in which they meet, and which, of itself, does not distinguish between Appearance and Truth... except insofar as the form of this distinction is inscribed in its working, and in some sense might be said to constitute Passive Reason.

This Imagination, says Aristotle, 'imitates' a reality, and the closest imitation is that Drama which imitates an Action by an (other) Action. In the analogy of form of the two actions we find the 'poetic' frame which abstracts at once from those two correlative poles of Imagination, 'self'-consciousness and the actual reference of sensation to an object 'outside' consciousness or Imagination. The 'acting' of the Drama is strangely intermediate between these two poles - at once 'outside' our consciousness, or the merely 'internal' workings of Imagination in the heart, yet not (like a true or real object of consciousness 'outside' ) altogether independent and separate from this 'internal' working. It belongs, one might say to a 'middle' term which ought, perhaps, to be 'excluded'. It must, at any rate be excluded from Reason, except insofar as it is rationally determined as the distance of Sense from Reason in such Contradictory relations of 'inside' and 'outside'.

In this strange intermediate zone of a sort of autonomous order of Imagination, framed in a Time and Place intermediate between internal consciousness and external object, our 'self' seems somehow to be identified with the apparent 'selves' reflected in the actor's mask or persona, and we are somehow 'in Imagination' involved in the working-through or working-out of the Action. But this means - at the same time - that the configurations of Pity and Fear which 'internally' distort by their impulses to movement ('emotion') the rational order of our activity, are themselves being 'worked-out' of our 'system', our constitution. For when, at the close of the imaginary action, we 'come back to ourselves', the workings of the disruptive economy of emotion (like the irrational motives

which disrupt the analogous Constitution of the State) are banished, by the rational perception of the true relations of self and World, as a mere dream and fiction. The masks lie empty, and our rational self-consciousness reasserts itself, distinguishing itself from its implication in the imaginary order of actions which are not actual and do not threaten us - from the subordination in Imagination of Reason to Sense - and so more closely approaching that good which is its proper finality, the contemplative detachment of the <sup>rational</sup> soul as it participates in Form, in the actuality of Form as distinguishing itself from Matter.

Thus the *κἀθάρσις*, the poetic ablution of the soul from the contradictions and confusions, the disruptive movements of irrational Sense, effected by Drama (or rather by its primary form, tragic poetry) within the aristotelian Economy of Kosmos, also amounts to a parallel 'working-out' of the autonomous drama of Choice, of the autonomy of Imagination, from the rational unity of Inquiry, from the rational coherence of Aristotle's Economy of Determination. And these two sides of *κἀθάρσις* each partake of the primary hippocratic figure: the loss of the unity of the soul in a disruption of the formula which balances the elements of the constitution, the working-out of this disruption to *κρίσις*, and the expulsion of morbid matter, the restoration of the unity or balance of the soul, its government of the body in health.

- There is nothing in Aristotle's account to suggest the place in the dramatic festival of that other face of *κἀθάρσις*, the 'purification' of the Mysteries, the common 'orphanic' elements in the origins of Drama and in, for example, Empedocles' *Καθάρσις*. No sense that the 'middle term' between self-consciousness and its object might mark some more radical actuality from which rational self-consciousness and independent external Nature are themselves abstractions - no sense that Tragedy is a mysterious dramatisation of the blindness of rational self-consciousness to its abstraction from this deeper Reality. - No sense of this, even though Aristotle's primary example of Tragedy, King Oedipus, is the most direct expression of this failure of human finitude to know itself, in the history of attic drama..

- Only an emphasis upon the rational articulation of Plot, of one action within another within the Action, the Drama, of the whole. Only a recognition, as primary frame of the action, of a configuration of Character, and a dynamic of Thought, turning about a mistake of Judgement.

The next step in the Drama of athenian Thought, and its dynamic involves two 'characters',  $\eta\epsilon\alpha\iota$ , markedly differing from that of Aristotle - Zeno of Citium in Cyprus, a phoenician representing that meeting of greek and semitic 'character' that would eventually dominate the Reflection of Antiquity (and this most notably at Alexandria) - and Epicurus from Ionia. Towards the end of the century each presented at Athens - the first in the Painted Porch or Stoa in the Agora, the second in a walled garden - a dramatic scheme of that 'best and noblest tragedy.. an imitation of the best and noblest life.. the very truth of Tragedy' announced by the Athenian Stranger in the Laws. - And the dramatic truth of these schemes lay, like the dramatic truth of platonic dialogue from which Aristotle had abstracted Philosophy, in the place within the scheme of the choice to act out one's life within that scheme, that Choice which lies hidden behind the mask of Reason in the inquiries of Oedipus and Aristotle. In these two schemes the aristotelian circle of Reason, which finds at the end of Inquiry a finality which initiated the Inquiry, is narrowed down to two opposed Dogmas, secure in the dramatic short-circuiting of the peripatetic scheme in which Reason and Imagination are integrated in a frame which, once chosen or accepted, confirms as it is lived out this initial step. A third School, appearing about the same time, with equal dogmatism insisted upon the circularity of all judgement, drawing arguments from the contradictory certainties of Epicurus and Zeno - it was this Scepticism, purporting to teach life in accordance with open probability, which came, in the person of Arcesilaus, to dominate the Academy around the middle of the third century.

Whereas in Alexandria Inquiry, as instituted by Ptolemy Soter was abstracted from the limiting circuit of Aristotle's reflection within the unquestioned frame of the <sup>hierarchical</sup> ptolemaic state, in Athens Zeno and Epicurus were making a converse abstraction from that same limiting circuit of theory in another direction - abstracting rather a frame of activity which might replace the vanished civic frame of hellenic reflection. Just as the two dominant directions in the applied sciences (or philosophy, rather) studied under state patronage in the alexandrian Museum corresponded to the 'logical' and 'physical' sides of the aristotelian frame, abstracted from the ethical or political frame of Inquiry presented by Aristotle, so do the ethical schemes presented by Zeno and Epicurus abstract from the Economy of the Method or System as a whole two complementary schemes of Kosmos, corresponding to these same two 'sides'. - But at Athens one might better (perhaps) speak of two corresponding 'concretions' of the mirroring of



Form and Matter in the dramatic frame of Imagination, of that Action in which Reason distinguishes itself from the confusion of Sense. Epicurus' scheme, in its theoretical outline, seems very largely to have reproduced that Atomism which the mature Plato, and Aristotle after him, had laboured to integrate with the logical articulation of Form. Zeno professed, it appears, to derive the outlines of his scheme from Heraclitus, identifying  $\Lambda\acute{o}\gamma\omicron\varsigma$  as governing Reason, with elementary Fire.

Each 'scheme' is framed by its Founder in the same simple figure: the 'circle' by which one enters into right contemplation,  $\theta\epsilon\omega\rho\epsilon\acute{\iota}\alpha$ , precisely by seeing one's acceptance or affirmation of the primary figure or frame, as marked or determined within that frame. Once the simple step has been made into such a frame of vision, the further unfolding of the vision, as of the practical rules of life seen in this first step to be implicit in the vision, will be inscribed within the first simple frame, according to the principle of inscription of detail in whole which is itself one element of the elementary scheme or frame (1).

The common figure of 'choice' or 'freedom' then, corresponding to the step into either frame, may be seen to amount to (two complementary versions of) a simple 'step' out of the theoretical Economy of Aristotle's Kosmos, and into the dramatic actuality of choice or freedom from which that theoretical circuit - an Inquiry whose end is to find the finality of its initiation - is a simple abstraction. It is as though, by the step into a dramatic frame of Kosmos - an affirmation of the subordination of physical to logical, or logical to physical orders, expressed in terms of such a subordination - the circuit of Aristotle's Economy might be seen to be itself inscribed in that frame as delusive Abstraction - as an Abstraction in which the dramatic order of Action appears to be determined from a wider circuit of theory, whereas - in practice - this apparent determination simply inverts the more fundamental order of Action in which this abstraction should itself be inscribed.

I don't want to suggest that Zeno and Epicurus should be understood as dissident aristotelians. Their 'initial' steps were made in an unlimitedly complex configuration of reflection, 'outward' situation, and confused activity (following Alexander's death, in the contests of the  
1: Epicurus, Letter to Herodotus (see below) & Cicero, On the Nature of the

Δικ' ἄλλοι , 'Successors', for control of various parts of 'the World'), and not in any simple abstract scheme of the development of Reflection. Their precise relations with the various athenian schools towards the end of the fourth century are not very clear. - But one may identify in their parallel 'schemes' of Kosmos and our place in it, as one primary component 'at work' in the scheme, a step from the circular 'abstraction' embodied in analogous ways in the various schools, into the 'dramatic' figure of Action. And this common 'step' may be most simply expressed in relation to the systematic Economy of Aristotle's Kosmos: in the 'dramatic' frame corresponding to an inscription of Aristotle's Inquiry in the figure of Drama (whose inscription in the Economy of that Inquiry thus defines the move of 'abstraction' to be inverted) the differences of, say, Epicurus' scheme from those of the various former schools parallels this determination of his difference or distance from Aristotle. They were all going round in the same circle of abstraction (Epicurus might have said with characteristically general contempt for all other 'theory'), and it was out of this circle that Epicurus and Zeno made their analogous steps. If I express this step in terms of the most general embodiment of that circle in Aristotle's Inquiry, this is only because this allows the simplest and most general determination of what is common in the positions of Zeno and Epicurus, and indeed in the various positions of their successors. - For these two simple 'circles' in which the step of affirming stoic or epicurean principles is itself asserted 'within' the frame or scheme of such principles (into which it marks the transition, the radical and primary act of 'choice' or freedom, in which subsequent activity is then systematically seen, 'proleptically' (in Epicurus' terms) to be to be implied) define what is constant in those two violently opposed sects, over the five or six centuries of their continuation. - Five or six centuries in which stoicism dominated the general frame of Reflection, until it was finally absorbed in the third century of our Era in a new rivalry (of 'christian' and 'pagan' Philosophy) - and in which 'epicurean' theory remained almost completely fixed in its Founder's vision, its history being the history of the application of this vision in a changing World.

That is (then): we move now into a 'dramatic' frame of Theory, in which the circuit of an aristotelian Economy is itself inscribed as one of the many expressions of that 'abstraction' from which the step into that Drama may be (and may have been) made. While our step into the 'dramatics' of stoic or epicurean Kosmos may at first appear to be determined in aristotelian terms, when the step is effected we will see that this 'determination'

is simply the primary theoretical component of the step - a step whose primary determination is then seen to be (in Aristotle's terms) 'practical' rather than 'theoretical'. In this light, then, the 'theoretical' determination of the step will be seen to be one among many practically equivalent 'steps' into the circuit of stoic or epicurean Vision.

In 'aristotelian' terms, then, we may say that what is reflected or inscribed in that Economy as the frame of Imagination,  $\delta\epsilon\upsilon\sigma\alpha\sigma\iota\varsigma$ , is properly the 'dramatic' frame of Kosmos from which the closed circuit of theoretical abstraction itself derives, as a sort of - imaginary - limit. - As a formal frame abstracted from the actuality of our freedom or choice. Thus the limiting and complementary embodiments of Form and Matter - self-position (God or First Mover) and the bare possibility of position, without definite specification or reference - are <sup>now</sup> taken to be empty abstractions from the primary Actuality of an intermediate dramatic frame. In this frame everything is irreducibly 'material', even the stoic God, and the starting-point of the schematic circuits of reflection which define the two 'visions' or dramatic actualities of Zeno and Epicurus, lies in the unquestionable Sense of the actual person to whom the vision is - actually - being imparted. The next step (in each case) is to recognise Reason distinguishing itself in and from this Sense in the primary frame of Imagination, of which Reason and Sense are two sides. And, as in the analogous configuration of aristotelian Tragedy, the closing of the circle of the demonstration which confers the vision of stoic or epicurean principles, lies in the experience of  $\kappa\lambda\epsilon\theta\alpha\sigma\tau\iota\varsigma$  afforded by rational 'detachment' from the confused subordination of Reason to Sense. It is as though the formal position,  $\theta\epsilon\acute{\omicron}\varsigma$ , of aristotelean Logic, and the complementary abstraction from this empty 'position' (as Matter) of Aristotle's God were seen as complementary limits 'in' Reflection of a dramatic actuality corresponding to the figure (in Aristotle's frame) of the Drama, intermediate between the 'logical' (or 'psychological') order of Reflection, and the 'physical' order of its object. - As though the Reflection which drives the inquiries of Aristotle or Oedipus is itself one 'movement', one side, which cannot, properly, be abstracted from the more fundamental 'intermediate' dynamic of Analogy, of the confusion of 'inner' and 'outer' in an Imagination which frames Action in Time.

- We do not begin in fact (that is) from some formal separation of Form and Matter corresponding to an abstract 'inner' space of Thought,

but rather in some particular situation, in which this formal 'framing' of that situation is simply one option among others, one action, one actuality, amongst a range from which it is open to us to choose how to frame our situation. The first expressions of what is thus open in the aristotelian 'Economy' of inscription of figure within figure, we find, naturally enough, in stoic and epicurean affirmations of a 'psychical' or 'ontical' actuality of Choice - in affirmations of the logical determination of the relations of logical and physical 'in' and 'out' (or a corresponding physical determination with Epicurus) where the affirmation itself is chosen, expressed, as determined within the very order ('psychical' or 'ontical') which it asserts or affirms. - Affirmations, that is, which themselves dramatically exemplify in the act of affirmation, the breaking of the symmetry of 'logical' and 'physical' sides of the 'poetic' order of Drama, from one 'side' (logical or physical 'in') or the other. The breaking of the symmetry of the two 'sides' of the imaginary order of Imitation - the 'poetic' order, is thus actually inscribed in the dramatic figure which 'results' from the breaking. The analogue in Aristotle's Economy is simply the self-assertion of the primary actuality of Form in the distinction of primary Form and Matter: but this actuality of Form - or Active Reason - appears only as a formal limit, in that Thought which is abstracted from the combination of form and matter in our selves. Active Reason responds (as it were), to the formal open-ness, in Aristotle's Economy, of whether there really is an actual instance of that Economy at all. And Active Reason asserts itself in distinction to the merely potential or Passive Reason embodied in the formal Economy of Kosmos, in the very situation in which we find ourselves actually asking the question. - But this 'situation', like the situation of the man who (in Metaphysics Γ) questions the axioms of Logic, the logical distinction of 'in' and 'out' which expresses itself by distinguishing itself from the 'outward' 'in' and 'out' of the physical order by (or in) which the distinction is marked - plays no part in the Economy of Kosmos, whereas the stoic or epicurean analogue is posited as the primary frame of these systems - the situation in which the question of the framing and significance of our particular situation presents itself.

That is: the 'theological' order of aristotelian Actuality distinguishes itself from the primary poetic order of bare 'position', only when this poetic order has already been abstracted from any particular reference. Zeno and Epicurus, on the other hand, begin in the actual sit-

uation from which the bare frame of position, with its implicit separation of 'in' and 'out', logical and physical, has been abstracted by an individual choice which does not recognise itself as such. In this 'choice' of abstraction, the individual forgets himself or herself in an unthinking identification with the thinking 'I' which is simply one empty formal pole of abstract 'position'. The 'dramatic' frame of this identification then appears, as it were, in an inverted form, as the identification we make with the 'I' of the actor, somehow intermediate between the two formal poles of the poetic frame of position, a rational 'I' that thinks, and its (my) object, which it ('I') posits. 'Drama' then, as which this 'confusion' of the two poles, of 'inside' and 'outside', is inscribed in Thought, marks the very frame in which Thought actually distinguishes itself from the confusion of Sense, in some actual situation. Yet our identification with this 'rational' principle is not dramatically asserted in some poetic frame in which Reason might actively distinguish itself. Rather does the rational inscription of Drama in the rational Economy of Thought exemplify that 'unthinking' movement of abstraction from activity, which comes full-circle with this movement of abstraction asserting itself as the finality of an 'I' quite distinct from my self, recognising itself - in Thought - as the end of my activity.

Zeno and Epicurus start, rather, from our actual situations, from an initial dramatic confusion of Sense and a Reason which does not know itself at first through any 'rational' distinction of positing Thought and posited object. This Reason distinguishes itself from Sense in Sense, and in the primary meeting of Reason and Sense in our own confusion. Form and Matter, said Aristotle, must be understood through the actuality of Form distinguishing itself from the Matter in which it finds itself embodied. But we should not begin, then, from some formal distinction of these two: for then we are already assuming some distinction abstracted from the primary situation in which it is itself made out. We must begin, rather, with the confusion of Sense - and this in us, actually - and find how Reason first distinguishes itself in fact. We must somehow find the movement of abstraction that comes full-circle in Aristotle's Economy as it first appears in the situation 'intermediate' between the perfect distinction of a formal 'I' 'inside', thinking, positing, some object 'outside'. We must begin in the radical analogy of 'inside' and 'outside', by which this 'outward' opposition comes to mark a 'rational' internal distinction of our 'inside' and 'outside'. We must begin in

the dramatic open-ness of our situation, before we have abstracted to an unquestioned formal distinction of two 'sides' of the 'poetic' frame of activity in which we find ourselves - in which we find ourselves somehow identified with these material bodies.. before we have somehow decided that the formal 'I' by which we identify ourselves in these speaking 'bodies' is more fundamental than the questionable identity of Aristotle or Zeno or Epicurus, or me or you, which somehow is involved in that decision. The logical circle by which this formal authority of thinking in us decides the radical question of how we are to assert ourselves, by deciding the formal frame in which the question is to be posed, and so its own formal part in deciding the question (as instance, precisely, of choice or decision) itself comes into question: why make that initial step? - We cannot ask the 'I' that 'takes over' in such a resignation of personal choice - for who is this 'I': not me or you. We must rather ask 'individuals': 'Why frame your situation that way, by imagining that some unquestionable 'I' decides that such a frame is unquestionable? 'Let us rather go back to the start, to the confusion of identity which that formal assertion of thinking only appears to resolve, and try and find our part for ourselves...'

- Thus both Zeno and Epicurus begin from the actual situation in which they, or we, find themselves (or ourselves). The ground of decision and choice, the 'criterion', κριτήριον, by which we decide, among other things, how to decide upon these criteria, is to be discovered as it distinguishes itself from our initial confusion, as it distinguishes itself in Sense. Aristotle had simply left open the actual operation of the Active Reason which distinguishes between its formal part in the Economy of Kosmos and its actual part. There is, as it were, no way to return from the bare complementarity of a general Economy of inscription, and the 'Active Reason' formally marked in that Economy as deciding the actual order of framing figure within figure, to the particular situation in which we first imagined a distinction of logical and physical orders of 'position'. Now, though, this activity of Reason is to be discovered at work in the confused situation in which this initial distinction first appears.

- Epicurus, for example, presents the very words of his exposition as the most radical starting-point:

Πρῶτον μὲν οὖν τὰ ὑποτιταγμένα τοῖς φθόγχοις, ὡς Ἡρόδοτος, δεῖ εἰληφέναι, ὅπως ἂν τὰ δοξαζόμενα ἢ ζητούμενα ἢ ἀπορούμενα ἔχωμεν εἰς ταῦτα ἀναγαγόντες ἐπικρίνεν, καὶ μὴ ἀκριτὰ πάντα ἡμῖν εἰς ἄπειρον ἀποδεικνύουσιν ἢ κινούς φερόντες, ἔχωμεν. (1)

First of all, Herodotus, must be grasped [taken-in] what is ordered by sounds, so that we have it in us to decide about opinions, whether in inquiry or difficulty, led along by these, and to avoid having everything undecided in demonstrations without limit: to avoid having empty sounds.

The Letter to Herodotus or 'Little Epitome', is one of three letters (the only texts of Epicurus to come down to us) introduced into the tenth and last book of the biographical history of philosophy composed (or compiled) by Diogenes Laertius in the third century of our Era. The last of the ten books of the Lives and Opinions of the most eminent Philosophers is given over entirely to Epicurus and his School, and the history as a whole closes by 'making its end the beginning of the happy life':

Καὶ δεῖρα οὖν δεῖ νῦν τὸν κοροφῶνα, ὡς ἂν εἶπω τις, ἐπιθῶμεν τῷ παντὶ συγγράμματι καὶ τῷ βίῳ τοῦ φιλοσόφου, τὰς κυρίας αὐτοῦ δόξας παραθέμενοι καὶ ταύτας τὸ πᾶν σύγγραμμα κατακλείσαντες, τίθει χερσάμενοι τῇ τῆς εὐδαιμονίας ἀρχῇ. (2)

And come, then, let us now set the seal, so to speak, on the whole composition, and on the philosopher's life, by citing his own 'Master Principles' and with them bringing the whole composition to a rounded close, making its end the beginning of the happy life. [the Κυρία Δόξα follow, closing the book]

The exposition of the epicurean system is framed by this First Letter, whose opening and closing themselves present it as framing the system in its συνεχῆς περίοδος, 'continuous circuit' (3). The articulation of this letter, indeed, within the primary division of Philosophy into the three coordinate parts of Logic, Physics and Ethics current from Zeno and Epicurus onwards, frames fairly exactly

1: Lives, X,37

2: X,138

3: X,36

Lucretius' presentation of the Medecine to Rome, the bitter draught sweetened with the 'honey of the muses': As children drink amarum absinthii laticem when the physician smears the rim of the cup with honey, and deceptaque non capiatur, though deceived are not betrayed, but restored to health, so Lucretius presents his doctrine which seems tristior esse quibus non est tractata, bitter to those by whom it is untried, quasi musaeo dulci contingere melle, as though touched with the sweet honey of the muses, and so

..tibi forte animum tali ratione tenere  
versibus in nostris possem, dum percipis omnem  
naturam rerum ac persentis utilitatem. (1)

..perhaps in such a way hold your mind in my verses, while  
you see the whole nature of things, and perceive its application.

The 'logical' circuit of Epicurus' Letter to Herodotus itself frames its 'physical' and 'ethical' applications in the letters to Pythocles and to Menecea (these themselves presented as its continuation), just as it frames the coordination of logical, physical, and ethical orders within the circuit of Lucretius' verse epistle around the middle of the first century before our Era.

The opening of the exposition in the First Letter, already cited, is itself preceded by an introductory section in which the letter announces itself as the 'continuous circuit' of elements - of first or 'master' principles, τὰ κυριώτατα (2). - Presents itself as the radical, the most general or universal, frame of the Whole, τὸ ὅλον, in which, through its framing of the universal principles of questioning and decision, all more specific questions may in principle be inscribed: framed and decided. The circuit embodied in the Letter, as such a primary frame of 'decision' is itself to be inscribed in Memory, μνήμη, and so frame in us our primary movement of ἀκροβολή, assertion, in which the circle is framed precisely as framing this its assertion.

This framing, then, itself appears as a simple assertion of our physical actuality. The frame is itself 'decided' by the radical physical or ontical actuality which determines the relations of logical and phys.



ical 'sides' of the poetic order of the text, and of the poetic or dramatic frame of the Whole presented 'in' the text which presents itself 'in' this physical Whole which it presents.

- Thus we begin the circuit with the very words of the texts, these 'sounds', *ἡχοί*, under which things are ordered. And in 'taking' the words at the outset in this way, we are, as it were, acting-out in the words which express this 'conception', *ληψίς*, the inscription of the logical order of the words in the physical order of the image. The 'first step' presents, in emphasizing the inscription of the logical order of the words in their 'other', physical, side, a 'physical' assertion of just this inscription, through the spatial 'grammar' of the images in which this *ληψίς*, this 'taking' or taking-in, 'comprehending', of the words, is expressed. And this determination of the subordination of their logical to their physical order in the words thus determined as 'sounds', amounts to our initial participation (or invitation to participate) in an 'ontical' actuality, which asserts itself in the actual configuration of this first step.

- And thus the first figure amounts to an assent to our part in the figure, an inscription of that assent or affirmation within the figure thus affirmed. And this amounts to a primary actuality of the physical 'side' of things, and of our situation, marking itself in the radical symmetry and confusion of logical and physical sides in the poetic order of the word: the primary distinction which, as principle of 'decision', *ἡμετέριον*, frames the 'circle' of the text as marking the 'physical' order in which it is inscribed, is found in the open play of figure which is Sense, rather than imposed upon this radical Sense in the formal opposition to Sense of Form and Reason, Abstraction. The inscription of that very figure of abstraction in Sense had, in Aristotle's Economy, to be exercised as Fiction, the empty poetic order of Imitation, Analogy, Illusion. - And the figure of Being, an 'analogy' outside the strict logical order of Aristotle's Categories, now appears, identifying itself with the physical actuality which has distinguished itself in the primary play of Analogy, of figure, of inscription, whereby the logical order of inscription of logical text in physical context, has actually inscribed itself in the physical order of the spatial image. (We will shortly find, with Zeno, an exactly converse affirmation of a primary logical - or psychical - order).

This primary physical actuality of Context, in which our first

has, if we assent, inscribed itself, implicitly contains a complete 'logic' of Figure, of Analogy. And the frame of this 'logic' is simply the initial figure of the physical determination of the mirroring of physical and logical sides of the poetic order: - Simply the inscription of the assertion of the physical determination of the relations of logical and physical orders, in a physical Image. - The logical order of the inscription is itself inscribed as one 'side' of an image: 'this' side, the side of inscription of figure within figure in the movement of assertion, a movement whose primary impulse is the assertion of the inscription of this very figure in the physical order of its two 'sides'.

Thus in the simple play of figure which is Sense, a physical or ontical actuality asserts itself in our inscription of our assent to this order in this order. It responds to and fulfills the movement of 'imagination' 'through' the otherwise 'empty words'. And this response corresponds simply to what frames the poetic order of our assent, which inscribes itself within that frame or framing as primary Frame, as Whole. The response is constant, not shifting like the words and figures inscribed within its actuality. The figure of a simple difference through which we assert the inscription of 'this' side of our assertion in the unity of its 'two' sides must itself be a constant correlate of this fundamental frame which responds to our assertion of it. There is no more fundamental difference in which this figure might be inscribed. A difference of two sides of physical actuality: an inside of Body, and an empty Emptiness or Void 'outside' Body. How? then are changing figures to be inscribed in this constant frame of Body and Void?

- Why, as changing configurations of Body. And such configuration corresponds, then, to the poetic order of word and image. The primary actuality of Body is somehow 'behind' that order of Sense, and we accede to it not in the play of Sense simply as such, but through a certain radical application of certain figures in this play to the play itself, as when we assert that 'that' side of the play is primary, when we assert the inscription of 'this' side of assertion, in 'that' side. In such a working of analogy a non-sensible actuality expresses itself in or through the figuration or configuration of Sense. The constant elements of configuration thus 'known' behind two-sided Sense may be called 'indivisibles',  $\alpha\tau\omicron\mu\omicron\iota$ , 'atoms'. From a consideration of this 'figure' of the atom, we can understand (though not 'see' with our senses) that these principles of config-

uration are, of themselves, 'in' Movement - in the 'figure' of movement - in an unlimited or infinite Void (for these atomic 'bodies' are themselves the only principles of limitation of Void or Place). They must exclude one another from what and so where they are, and so must 'interact' in Void, through this 'solidity'. Such interaction will give rise to the configurations we see (without seeing the elementary interacting components). This which we call 'The Kosmos' is itself not the Whole, which is in principle unlimited, but simply one passing configuration of a certain number of atoms, momentarily locked (as it were) in this Place.

What then, are the 'images' of sense, 'in terms' of these radical first principles? They must, of course, be 'physical', and so composed of 'atoms', going from 'outside' this configuration we call ourself and passing somehow 'inside', or interacting with our surface. This is the only way an image can be inscribed in the primary figure of Actuality distinguishing itself in an initial confusion of the Image, of Sense: This is the only way that will 'work' - Sense as a manifestation,  $\epsilon\omega\sigma\tau\epsilon\iota\alpha$ , of the  $\epsilon\nu\epsilon\rho\chi\epsilon\iota\alpha$ , underlying 'working' of the basic primary principles.

These 'images',  $\epsilon\iota\delta\omega\lambda\alpha$ , must be somehow determined as they pass from 'inside' to 'outside' of the configuration whence they proceed to us - they must somehow embody the configuration of the surface or limit of the composite body. And they must move imperceptibly fast, with that movement 'comprehended', 'taken-in', 'grasped', only in the Thought in us which partakes of the same principle of radical movement - not in the Sense which 'takes in' only the passing integration or interaction of invisibly many such unimaginably fast movements in the 'pulsation' of a composite body, like our own. The correlation or mirroring of radical movement 'in' us and 'outside' us articulates that  $\delta\iota\epsilon\lambda\eta\psi\iota\varsigma$  which is the activity of continuous  $\lambda\eta\psi\iota\varsigma$  according to the basic  $\kappa\epsilon\iota\tau\eta\rho\alpha$ . Indeed, since in this correspondence of movement we know Time, we may 'comprehend' what is 'outside' the present relations of internal and external movements in a  $\pi\rho\acute{o}\lambda\eta\psi\iota\varsigma$  which, as only formally 'containing' or 'comprehending' its corresponding object, is liable to error. Indeed this figure of a formal containment which goes 'beyond' the evidence of a present mirroring of movement within and without, is the very figure of Error. It determines the relations of logical and physical 'sides' of the image from 'this' side, rather than assuring knowledge by inscribing this relation in its context, in 'that'

side: corresponding to the fundamental figure of an assertion, ἐπιβολή, which is the inscription of the movement of thought in the primary configuration of Movement, there is a νοεῖν and a δύναι. But there can be no κρέναι (the great stoic principle, 'providence') which would be an inscription of πρόληψις in the figure of Knowledge.

What, then, can we know of the atoms? - First of all we may deduce, from the elementary figure of the atom in the Void, a common principle of Movement in all the atoms, which Epicurus associates with a movement, a 'fall' in one direction of the Void. Other directions, though, are equivalent - movement to the 'right' is quite symmetric with movement to the left, or forwards, or backwards: there is no prior figure which would determine any such differential movement (and, I suppose one must say, all these 'directions' are relative one to the other, and together to the fundamental 'down'). Elsewhere Epicurus deduces an imperceptible κλινόμεν or bending of the fall of the atoms: otherwise there would never have been any interaction, only parallel fall. And this elementary self-expression of physical Being in the individual atoms corresponds directly to the movement of will by which we inscribe our assertion in the primary Nature we (by this) assert. - Here again is that figure of Knowledge as inscription of a figure in the primary figure of that κριτήριον corresponding to the inscription of the distinction of 'physical' and 'logical' sides of the poetic order as two sides of the physical order of the Image.

Thus Thought or knowing is known to be the primary movement of the finest or most mobile atoms in our composite bodies, in which the grosser movements corresponding to sense are as it were inscribed. And this 'inscription' corresponds to the figure of ἐπιβολή, the movement of assertion of something 'behind' the mere passing qualities, σύμπτωματα of sensation. - Though it is also the 'anticipation' in sense of the ascription of those 'qualities' of form and size and movement which are truly known in the analogical knowledge of the atoms, and their combinations - συμβεβημένα.

- Thus we can truly know, for example, the figure of this 'World' in terms of the mechanical configuration and interaction of atoms - as also those of life, and, indeed, this language, these words, in which these truths are expressed in the order of the Image. We can know that the 'order' behind the visible heavens is not that of human whim - this divine 'intention' and 'providence', says Epicurus, is just our ignorant projection of our own

misunderstood will in the mirror of the Image. The only actual or effective will is that which inscribes itself in the mechanical order of heavens and earths. This assertion, framed in and framing  $\phi\upsilon\sigma\iota\kappa\omicron\lambda\omicron\gamma\iota\kappa\acute{\alpha}$ , universal knowledge, cannot come into conflict with some opposed assertion or intention, since it is simply an inscription of our activity or actuality in the unitary order of the physical or ontical Frame of things, which is not opposed to or by anything 'outside' it, having no 'outside'. From our inscription of our 'selves', then, in this frame, proceeds  $\acute{\alpha}\tau\alpha\rho\alpha\zeta\epsilon\lambda\upsilon$ , freedom from conflict and confusion, abstraction from the irrational confusion by which we are tied to an illusion of self in the play of a Sense which has not itself been inscribed in the frame of Reason. - The play of Sense, of figures, images, their 'leptic' inscription on either 'side' of the Image itself, and the inscription of these 'sides' in the economy or play of Sense, without such inscription itself being framed by the radical figure of Inscription, of Figure and Word, Conception and Object, itself. - And the primary figure of conflict, contradiction and confusion arising in this play, is simply the mirroring of proleptic intention in the Image, the symmetry of the two 'sides' of Sense, unresolved by the criteria of Reason.

The natural movement or direction of our activity within such a scheme is the movement (as in the Philebus) of abstraction from this painful conflict - and most particularly, from the Fear which is the implication of, and loss of, peaceful Reason in the conflict of Reason and Sense. - Here the aristotelian figure of  $\kappa\alpha\theta\alpha\rho\epsilon\sigma\iota\varsigma$  <sup>(1)</sup> reappears in the primary 'dramatic' or poetic frame of our activity in general. - In the third letter, this movement away from conflict, in which Reason distinguishes its stasis in and from the play of restless Sense, this 'pleasure', is (as it were) first 'anticipated' in the bodily figure or image of self-containing Reason, in a stomach, 'comprehending' (as it were) its initially external nutriment. Here again the simple platonic figure of Reason mirrored in Sense, as rational 'faculty' mirrored in nutritive (or assimilative or appetitive) faculty, is simply inscribed in the epicurean scheme, whose 'originality' lies rather in the inscription of familiar figures within a first dramatic step of 'framing' choice and decision, rather than in the detailed inscription of particular figures in this 'elementary' frame.

- Indeed, towards the close of the Letter to Herodotus, Epicurus insists upon the 'continuous memory' of the elementary frame presented in this letter, and the inscription in it of the figure of Fear or Mental Pain and Conflict, as universal remedy for all ills (2). - In Memory: for the

Frame assented to in the elementary step of asserting this assent in the terms of that frame, inscribing the radical 'movement' of ἐπιβολή, will, in that frame, and this in the particular situation in which the frame presents itself as question or option, corresponds exactly to the dramatic frame of Aristotle's poetic Imagination, in which the analogy of 'internal' and 'external' 'sides' of the Image is framed in Time, in the correlation of 'inner' and 'outer' in the converse movements of abstraction from the radical poetic symmetry of the two 'sides' of Action, Drama - in the converse movements or figures of Memory and a constant external Object. - In the dramatic differentiation of the two 'sides' formally distinguished in elementary assertion or 'position', θέσις, where the inscription of the subject-term in the predicate on 'this' side, directly reflects the constancy of a substance of which an action or actuality in Time is thus asserted. Indeed the fundamental 'dramatic' frame which Epicurus invites his reader to step into, by thus continuously asserting this frame in Memory, amounts to a radical Actuality of the situation of an individual, from which Aristotle, at the outset of his Inquiry, has formally abstracted two sides, 'inside' and 'outside', logical and physical, form and matter. In Epicurus' frame, these two sides are discovered 'at work' distinguishing themselves in the radical confusion from which we must begin, if we are to return at last to our actual starting-point, rather than some formal reflection of that beginning in some closed frame of Abstraction; where the radical actuality of Reason distinguishing itself from Sense in Sense is marked simply as the question of an Active Reason, an actual Actuality of Reason, distinguishing itself from the mere inscription of the passive figure of this distinctive actuality in a formal Economy of the Whole.

Epicurus answers that question, in closing the 'circuit' of the Frame of Action, to be constantly asserted in Memory - in which we are thus to constantly inscribe our self-assertion, our activity, beyond any fear of conflict with some other actuality 'behind' the Image, behind the scene of our activity. For any particular situation may be inscribed in this frame, simply by following the pattern of inscription which, articulated inwardly in Memory, frames right action. Everything may be thus inscribed in this circuit, all <sup>ἐν λογισμῷ</sup> δεικνύμενα, all discursive activity of Reason. - Everything, that is, except the more radical circuit in which, as we see the place, in the frame, of the words by which it is expressed, we at last abstract quite from this last Image, <sup>τῆς δεικνύμενης</sup> and standing outside discursive Time, like epicurean gods between the innumerable Worlds, partake, in

seeing our very movement of assertion of Actuality framed in the radical actuality of Movement it asserts, in the absolute peace or stasis in movement of Reason knowing itself: Serenity, *ἡσυχιασμός*, in which the letter comes full-circle and closes upon itself:

ὅσα εἰ μὴ παντελῶς αὐτῶν τῶν ἀποτελωνμένων ἐκ τούτων  
εἶσιν ἢ κατὰ τὸν ἄνευ φθογγῶν τρόπον τῆν ἅμα νοήματα  
περίοδον τῶν κυριωτάτων πρὸς ἡσυχιασμὸν πεποιμένα.

Whatever is not quite comprehended in this completed circuit of principles, follows from it - except that way, beyond sounds, in which the circuit of principles is known all-at-once, begetting serenity (1)

Around the middle of the first century before our Era, the roman lawyer (politician, writer..) Cicero - who according to tradition had, around 51, edited Lucretius' poem for publication, after the latter's suicide - retired from public life (his part in it had vanished with the Republic) and in 45-44 set about presenting, for the first time, the whole frame of greek reflection to Rome. In the resulting series of dialogues - in which translations from or summaries of greek originals are organised, as it were, as contending sides of the case to be decided by an academic critic or judge - we find our primary source for early stoicism. Insofar as the representatives of the Stoa in this academic court distinguish the various parts of their brief deriving from different phases of the stoic tradition down to Cicero's time, we may trace in outline the part of Zeno as follows:

He starts, like his contemporary and rival Epicurus, from Sense, and the confused situation of our actual reflection. - From the same figure of two sides of an image, and a certain image of these two sides corresponding to the poetic order of words. Yet Zeno's principle of inscription of figure within figure, his frame, his criterion, which distinguishes

1: Letter to Herodotus, end: Lives, X, 83

in the radical frame of Analogy common to him and Epicurus, amounts to a direct converse or conversion, a mirroring, of Epicurus' assertion of the physical inscription of the relations of 'logical' and 'physical' sides of this assertion.

- For Zeno's 'criterion' or principle of decision, corresponding to the primary figure or frame of 'inscription' of figure within figure, is logical: the κριτήριον λογικόν . And like Epicurus' fundamental principle of 'decision', this 'logical criterion' is itself embodied or exemplified in the step into the stoic frame of activity. It, itself, decides the inscription of this initial step in the frame of activity which it chooses, and to which this inscription of the initial assent or decision is the entry. In this frame, the figure of the interface of logical and physical 'sides' of the Image, is the tabula rasa, a blank tablet, on which an 'outside' first impresses itself upon us, like a seal making an impression in wax. - But what is here logically 'outside' the distinction of the two 'sides' of this tablet or blank surface, is the physical symmetry of the two 'sides' of the impression or image. The logical articulation of this primary figure of distinction cannot, itself, come from the symmetric physical order of simple Sense, from which it thus distinguishes itself. It distinguishes itself by finding its image as 'this' side of the tablet, and in thus inscribing itself in the 'outside' which is the physical symmetry of the two sides, begins, as it were, to write or draw upon the tablet, to assert itself in the articulation of images within this primary image of distinction. As the order of inscription of image within image, figure within figure, it thus distinguishes itself in and from the free play of inscription which is symmetrical Sense. We partake of this 'logical' order of Reason distinguishing itself from Sense in the play of Sense by choosing, deciding, to inscribe our assertion of this distinction in the figure of this Distinction, this Reason. In distinguishing this logical order from the physical order of the 'two sides' of the interface of me and not-me in which it first expresses itself, we are simply asserting our part in this expression, this self-expression of Reason, distinguishing itself in the otherwise open and disordered play of figure, of Sense. In asserting the primary actuality of Reason, we are actually exemplifying this actuality we assert: by this logical criterion, by the inscription of further figures in this initial figure of assurance or assertion which itself exemplifies its object, we can know with certainty, and distinguish 'this' knowledge - as simply 'this', from the confusion of Sense. - A confusion which is thus seen to be exemplified in an extreme form by Epicurus



forgetting that it is he who is deciding to inscribe decision in the 'outward' configuration of mindless matter - or so the stoics would have it.

- For what kind of distinction is Matter from Void, that fundamental difference in which Epicurus inscribes all the articulation of this ordered Kosmos? What is Void? - Nothing. -And how can anything be distinguished 'from' no thing? Matter, for Zeno, is rather the first embodiment of the activity or Actuality of Reason: Epicurus' initial distinction is itself nothing, empty. First Matter is Light, Fire, distinguishing itself from sensible darkness - it is the first embodiment of figure, in which Reason is already at work. Void is nothing - there is no void 'in' Kosmos, just as there is 'nothing' outside the perfect sphere of Kosmos, which is the Whole - which has, as it were, only this one side.

Reason, then - self-expression, Λόγος, coincides with Matter in this initial figure of Light - and in this figure Actuality of the frame of things expresses itself as distinguishing itself, in Light or Fire, Aether, from the Darkness of passivity, the 'physical' order of matter insofar as this is distinguished, in a secondary sense, as passivity, from the organising actuality of Fire.

In this elementary frame, then, the 'logical' order of inscription of part in Whole is simply one 'side' of the 'physical' inscription of figure within figure, and the two 'sides' coincide in the primary actuality of God or Reason or Word, Λόγος articulating this secondary distinction of two 'sides' of itself, Light and Dark. In particular, the order of Reason in which we inscribe our assent to this same Actuality of Reason, comprehends our action, just as the frame of Kosmos comprehends, within the circuits-within-circuits of the stars, the bodily framing of this action of assertion or assent - as of all our rational activity inscribed within that fundamental movement of assertion, which is simply the inscription of all our action within the governing order of Reason itself.

- On the analogy of the union of the 'rational' and 'bodily' sides of this action in our activity, our life, we may see in the duality of Reason and Fire in the Whole a Life of the Whole: properly speaking, indeed, we must understand our life as a participation in this primary Life of Nature, which comprehends particular lives just as the figure of Reason comprehends

pre

prehends our assertion of our part in Reason. - And this Life or - to take the primary figure in which it is articulated or inscribed - Breath,  $\pi\nu\omega\mu\alpha$ , 'Spirit', of Nature, is in principle articulated by a perfect actuality of Reason - whereas our life, within this whole, involves a confusion of this Reason, framed in the Light of the all-comprehending heavens, in the Darkness of Matter. In us the figures of Reason, Life, Sense, Matter are jumbled in the opacity of earthly confusion, whereas in the primary frame of the whole, each figure is inscribed in another according to the writing, the 'Fate', fatum (assertion, 'what is spoken') of the Reason which articulates this frame in distinguishing itself within it. Here, as in the analogous figures of aristotelian Tragedy or epicurean  $\alpha\lambda\epsilon\gamma\epsilon\tau\iota\kappa\acute{\alpha}$ , Reason abstracts itself from the confusion of Sense, in which the figure of this Reason has itself been blindly inscribed. But here reason in us inscribes itself in a Reason which is the primary Actuality of the Whole, in which our own assertion or choice is itself somehow mysteriously inscribed, within the nested figures of Reason's plan of this Whole.

In particular, our assertion, like all our actions, is inscribed rationally in the figure of Time, articulated as the primary frame, corresponding to Life, in which Reason or Fire distinguishes itself from the darkness of Sense,  $\pi\kappa\theta\omicron\varsigma$ , passivity. All the elements of the scheme of Reason's self-assertion are inscribed in the rational frame of the Scheme as a Whole. This inscription does not take place in Time, like our planning and scheming, which cannot comprehend all the elements involved in some action (and amounts to a kind of interaction of the Reason which stands 'outside' this Time, and our involvement in the uncertainties of Time as we try to 'comprehend' its order and articulation). Rather is Time articulated 'in' the primary frame of this Reason. We, though, can see our place in that scheme, that figure of the inscription of Time in 'providential', fore-seeing, proleptic, Reason, Word, and so can overcome the uncertainties of this our individual or particular life by choosing to inscribe it in Nature, Spirit, the Life of the Whole. This then, is the figure in which we should inscribe our life or activity, and by which (then) we can decide between the courses of action open to us in the frame of the Whole, of a rationally articulated Kosmos. We cannot see this order 'outwardly' in our affairs, comprehending the infinite details in our finite imagination, but we can see in principle - in their principles of inscription in the Frame of the Whole - how the whole of this unimaginably complex detail is 'comprehended', detail within detail, in the fundamental frame we can know.

The primary figure of Time inscribed in Reason, then, as the 'logical' (or psychological) determination of the articulation of the poetic order of inscription of figure within figure, of Analogy, is that all-comprehending circuit of Eternity already familiar from Plato and Aristotle and Epicurus: the inscription of Time in the *stasis* of Reason, in the constancy of 'is', in which the movement of our assertion somehow participates, or can participate. Outwardly this circle of Time amounts to the recurrence, in the unfolding of the initial figure of Reason distinguishing itself from the symmetry of the bare order of Sense, in an initial 'filling' of the Frame by Light or Fire, of this same initial figure. As this initial symmetry is disrupted (in a figure of the beginning and end of Time, of the poetic order of universal narrative, with its converse dimensions of foresight and memory) the bare circuit of Eternal Reason is disrupted into those astral circles of light-in-darkness which frame Time within the all-embracing circuit of Time as such, the simple 'is' in which Reason asserts itself as Actuality. This movement 'into' Time seems to correspond also to a sort of partial abstraction of Reason from its simple coincidence with Matter as Light - Zeno thus derives cycles of elements from the primary circuit of Fire or Aether through the whole Creation, into which, at the end of the story, these elements, and all things articulated in this initial separation of Light and Dark, are again resolved.

I will not attempt any hypothetical reconstruction of the further details of Zeno's frame - we know, indeed, that the systematic articulation of this simple frame was effected largely by his successors in the third century, Cleanthes and Chrysippus. The latter, in particular, is usually credited with the systematic logical elaboration of the principles introduced by Zeno, and developed by Cleanthes (whose Hymn to Zeus, articulating the vision in a poetic dramatisation of our reason's discovery of its part in Reason, is extant), in a theoretical economy or System.

Two aspects of Zeno's presentation may, however, be emphasised. First, the place of the recurrence of the fundamental principle of Reason, *ἄνους*, distinguishing itself or Himself, in the step by which we affirm the inscription of that step in Reason. - This amounts to a sort of midpoint in the unfolding of Reason's scheme, between one 'conflagration', *καταστροφῆς*, and the next. The scheme of Providence, *ἀρχῆς*, Reason ultimately manifesting itself directly as Light or Fire, seems somehow to turn about our recognition of the option of (as it were) co-operating with

the Scheme. Our step into the figure of Reason distinguishing itself in response to our assent to or affirmation of Reason, seems to be a radical or primary component of the Frame of the Whole itself.. but the figure of Destiny or Fate attributed by Plutarch simply to 'the stoics' without further qualification - a configuration of elements in which our open choice is itself inscribed (as part of the configuration)(1) - is presumably a response to later academic criticism. This question of the part of our will in the Whole, this spark or seed <sup>(ἀσπρὸς αὐτὴν ἡλικὸς)</sup> in us of the universal Fire, and the actuality of this our rational part outside its individuation in our body, amounts, indeed, to a radical question, associated with the basic circularity of a logical or psychical determination of the relations of logical and physical sides of the poetic order of Analogy. It is such circularity, of course, and the figure of Question corresponding to the logical closure of the circuit, which leads to the 'stoic paradoxes' - which might appear, almost, to be applied by the true stoic to the strengthening exercise of reason, distinguishing itself from the appearance or 'sense' of contradiction, in which it seems to be involved. Credo quia absurdum...

- And, second: the form or frame of Zeno's exposition - as related, for example, by 'Balbus' in the second book of Cicero's On the Nature of the Gods (in which Balbus presents the first principles of stoicism, assembled from various sources for Cicero's presentation of the case)(2).

- A 'form..brief and summary': certain principles - reason, wisdom, happiness, eternity, consciousness, life, intelligence - are found in the Whole; these could not be 'in' a part without being in what as frame, comprehends the part - the Whole,  $\pi\alpha\sigma\iota$ ,  $\kappa\alpha\tau\alpha$ , universum. 'And then, as was his custom, he rounds off his argument with a comparison:

If flutes playing tunes were to grow on olive-trees, would you not infer that the olive must have some knowledge of the flute? Or if a plane-tree were to bear lyres playing in harmony, would you not similarly infer that the plane-tree was something of a musician? Why then will you not admit the universe to be a conscious intelligence, since conscious intelligences are born from it?" (3)

-Zeno, having presented 'the circle of a closed argument'(4), embodies the figure of the argument in an image, an analogy. We already know from Velleius' attack in the first book of the same work, that Zeno had written a commentary on Hesiod's Theogony, in which he interpreted stories of gods

in a parallel manner. Such stories were 'images', analogies, transpositions of primary cosmic figures of the Whole, into the terms of our own finite activity - ἀλληγορία, allegory, 'other-speaking', 'figurative' language, whose truth lies in a transposition from its apparent reference, the 'image', to the order or 'forces' which are the primary embodiment and actuality of the figure. - Yet as embodied in the activity of popular religion, these stories work to the extent that they articulate the 'practical' order of our activity within the primary actuality of a cosmic Story or History from which these 'anthropo-morphic' stories abstract certain 'elements'. - Abstract certain elements of the universal 'poetic' order of rational Providence (inscribing all activity within the Actuality of the Whole) to the image of this universal order in the finite articulation of a story, and the finite integration of the elements of some human activity, which can be comprehended in our imagination. The third and last book of The Nature of the Gods, taken up with Cotta (the academic)'s criticism of Balbus (the stoic)'s exposition of Providence in the second book - and most particularly with Balbus' interpretations of the world-order in relation to mythological figures (Velleius the epicurean calls them 'dreams') - concludes with Balbus most radical defence:

Well, Cotta, you have made an exceedingly violent attack upon the views of the stoics, although in my view their theory of the Providence of God has been evolved out of a spirit of piety, and bears itself the mark of Providence (1)

\* \* \*

.. This then was the end of our discussion and we went our ways, Velleius thinking that Cotta had the best of the argument, while to me it seemed that the reasoning of Balbus brought us nearer to an image of the truth (2)

- an image of the truth: and it is precisely in the practical or 'moral' order of activity that the stoic story of God as the 'Author' or 'artist' of the cosmic Story in which all figures (including that of the image or story) are inscribed, one within the other, presents itself as a 'poetic' or dramatic Truth more radical than the logical force of academic criticism of details.

This 'dramatic truth' was, over the two centuries or so between Zeno's teaching and Cicero's period of study under his 'successor' Posidonius, extensively developed within the primary dramatic frame of the as-

sent of our finite reason to its inscription in the figure of Reason - in the primary frame of inscription - and of the decision this implies. The choice of frame inscribes itself in the frame it thus chooses, and constitutes the primary figure of the Criterion - *φανταστικὴ καταληπτικός*, *katalepsis*, which Zeno is said to have expressed by the image of one hand holding, containing, grasping, the other hand that itself contains, *λαμβάνει*, in imagination, *φαντασία*. - The figure of containment of one figure within another (1)

This development stands, as has already been intimated, in marked contrast with the stasis of epicurean doctrine over the same period: for while the primary step of the epicurean drama is a sort of abdication which precludes or fore-closes upon further 'logical' determination of a physical frame in which logical assertion has at the start asserted its own inscription, the zenonian logical framing of the relations of logical and physical 'sides' of the Image, invites a process of successive re-inscriptions of this initial figure within an ever-wider 'logic' of the poetic inscription of figure within figure.

- And this 'theoretical' contrast is itself simply one aspect or side of a radical practical contrast between the two schools. The epicurean 'criteria' applied to the framing of our action, lead towards a progressive abstraction or detachment from any self-assertion, any proleptic 'scheme' or plan of activity, any imaginary end or finality. In particular, the aristotelian figure of the finality of a community as participation in a common end, the self-expression of Reason or Form, the actualisation of a common humanity is quite inverted by Epicurus: the end of community, of friendship and justice, is simply the negative one of providing a frame in which we are least likely to be surprised by circumstances which induce us to assert ourselves. - As though, in an epicurean economy of abstraction, a minimal assertion of friendship saves greater assertion or exertion resulting from a neglect of friendship. The only end of activity is to abstract oneself from finality and its associated anxiety: activity according to the epicurean criteria is to be dramatically inscribed within the primary figure of the initial step into the epicurean Frame - within the figure of inscribing the logical assertion of inscription, judgement, decision (and in particular the assertion of this inscription itself) in the physical order of Movement.

The stoic criteria, on the other hand, require the inscription of our activity within a providential scheme, within the frame of the initial

inscription of the rational assent to a Λόγος or Reason framing this first step, this bare assertion of participation in a Reason which asserts itself in this assent. The inscription of one's subsequent choice or decision within this primary figure corresponds to stoic 'life according to Nature', which is also simply 'life according to Reason' - an inscription of choice of the finality of one's finite schemes and ends in the unitary finality or Providence of the whole Scheme. The right choice then - acting one's part in the scheme of the Whole - is simply τὸ καθήκον, framed in κατάληψις.

- In particular, the mirroring of governing Reason and the economy of Nature in the Law of the Whole, the framing of all action as inscription of figure within figure, and part in Whole, amounts to our participation in the figure of a universal or cosmic State, in Kosmos as πόλις, as 'cosmopolis', κοσμοπόλις. From Zeno on the Socrates who played out his part in the scheme of cosmic Justice to the last scene was revered as the very model or image of the stoic 'wise man', who had inscribed his very choice, his will, in decisive Reason. To epicurean abstraction from activity (save insofar as an action leads to abstraction from further action) is opposed the stoic movement towards ever-wider inscription of one's 'own' schemes and actions within the rational government of Kosmos, the 'progress in virtue', acting so as to better participate, next time, in Reason - 'abstracting', indeed; like the epicurean, from all personal schemes or ends - but by inscribing these each time more completely in providential Reason, rather than in the Movement which (alone) is constant, stasis, peace.

- An ever-wider or more exact inscription, then, of Sense, of the finite frame of the Image, in a frame of Reason which first distinguishes itself in distinguishing two sides of the Image, in the image of κατάληψις, comprehension, containment - and this 'dramatically', in the primary act of rational assent to the actuality of Reason in this very assent. And this 'logical' assertion of one's part in the actuality of Reason is but the entrance into the ethical certitude of τὸ καθήκον, one's part - 'office', officium (Cicero's translation) - 'duty': what is ethically or 'morally' contained or comprehended in one's 'part' or situation within the primary Frame of rational Kosmos.

Thus the final or ideal detachment of the stoic 'wise man' from the 'irrational' mirroring of two sides, finite self and its finite ends, inside and outside, in Sense, in the Image, itself exactly reflects the

converse abstraction of the 'serene' epicurean. The figure of an initial inscription of the difference of two 'sides' of the Image in one side, coming full-circle, is common to the two 'economies' of abstraction, to their exactly converse movements. For a moment the initial assertion is itself comprehended in the Frame it asserts, and the sage is quite 'outside', abstracted from, the confused symmetry of Sense. His finite self has been dissolved, as it were, in Reason or Movement, and stands outside the Time in which the symmetry of the physical and logical sides of the poetic order of the Image is first articulated in Action. He participates selflessly in the simple Actuality, the constant 'is', of the figure by which the primary resolution of the symmetry of the two sides of the Image in our assertion of the inscription of this assertion in a self-assertion of Reason or Nature, is itself 'seen' within the Reason or Nature it affirms. For a moment, for a certain time, this moment or time of our abstraction is inscribed in the figure of Time itself. The play of figure is, in the figure of Time, inscribed in 'another side' of Time, in 'Eternity': Sense for a moment is seen or inscribed in the figure of Reason coinciding with Nature. And yet the stoic and epicurean sages are, in the assertions by which they enter into this common figure, irresolubly opposed, caught in the conflict of two 'sides' of a common Imagination from which both begin, caught in two irresolubly conflicting images of the common figure of abstraction, in two opposite economies of the same abstraction or detachment from the Image, from Sense.

You have your two diametrically opposed and conflicting 'criteria' of certainty, says Arcesilaus to a second generation of athenian stoics and epicureans; How is one to decide between your conflicting certainties? Where is the criterion which will decide the right criterion? - It's no use simply applying your own criterion to establish the certainty that it is the right criterion... that isn't argument, but simply assertion of your criterion against another. One has to accept the criterion in order to apply it to determine its own acceptability. What can you do to persuade someone who questions the criterion itself?

Thus begins the Middle Academy, around the middle of the third century. I have already referred to the development of stoic doctrine in reply to academic criticism, and to the part of the academic Cotta in Cic-



ero's framing of greek Philosophy. But how does the continuity I attributed to the Academy as a School lead from a pythagorising Speusippus, himself (it seems) guilty of moving in the circle of a formal determination of the relations of Form and Matter (of One and 'Indefinite Dyad'), to his successor Arcesilaus who, about a century later, is inscribing his reflection in the figure of the Question, following Timon the sceptic's assertion that all assertion is either circular or involved in an unlimited regression (Epicurus' 'empty sounds')?

I have already suggested the part that might have been played in this transition from 'Old' to 'Middle' Academy by Pyrrho ὁ κειρατικός, the 'sceptic', 'looker', 'examiner' - questioner. Pyrrho was a fairly exact contemporary of both Zeno and Epicurus, and had accompanied Alexander outside the circuit of greek Reflection and Culture to India, as a young man. He then retired to Elis, whence his disciple Timon the 'sillographer' (or writer of ἄλλοι, short satirical poems) came to Athens towards the middle of the third century. Pyrrho wrote nothing: it seems he insisted that we can know how to act - say, in asserting this itself - but that this ethical actuality cannot be framed in a general way - as though, perhaps, the dramatic configuration of Action is in some way essentially 'open', and the right course of activity involves a progressive 'opening' up of possible activity and choice through inscribing the closed circuits of dogmatic assertion (seen in limiting form in Zeno and Epicurus) within the more radical figure of the Question. We know, at least, that Timon inscribed the assertions of philosophers in such an 'open' frame of the Question, as either circular or infinitely regressive, and that in his satires upon philosophers he embodied the figure of the Critic, standing outside (as it were) the 'comic' spectacle.

We know also that Arcesilaus' predecessor as head of the Academy, Crantor, insisted that the 'narrative' of the Timaeus was to be taken 'allegorically', as the presentation 'in' Time of an 'eternal' constitution of Kosmos 'outside' Time - 'in' which the Time in which the narrative is inscribed is just one form, or element of figure.

Now this (which is all we do know about Crantor) amounts, precisely, to a mirroring of the 'physical' frame of the narrative, the 'probable' assertion of Timaeus, in the logical frame of the Parmenides, in which Time appears as the primary frame of coordination of figures or Forms

within and without one another. Thus Arcesilaus' further step, to a recognition of our part in framing action, of the part of assertion in the poetic circuit or closure of the 'scheme', amounts to a dramatic perception of the common 'poetic' figure of the conflicting stoic and epicurean schemes, as closed circuits within a more general 'poetic' frame of Analogy, of the open play of figure-within-figure from which the distinction of Actuality appears, in the circuit of the Parmenides, as Question. - And this recognition of a common 'dramatic' frame from which the Question of the Parmenides and the assertive narrative of the Timaeus are abstracted as two complementary 'sides', logical and physical, brings full-circle and closes the 'Old' Academy which began with the inscription of the 'physical' scheme of the Timaeus within a formal resolution of the Question posed by the Parmenides: the logic or mathematics of inscription comes full-circle in the question of Time, the 'moving image of Eternity' in which Sense mirrors Reason 'outside' Time.

Thus the primary figure of Arcesilaus' ἐποχή, 'withholding' of assent - the open-ness of the Question attaching to the closure of the poetic frame of figure as such, and our part in 'framing' action - which marks the transition from 'Old' to 'Middle' Academy, around the middle of the third century at Athens, also corresponds to a wider 'dramatic' frame in which the converse stoic and epicurean 'abstractions' from Sense can be inscribed - inscribed as two primary and contrary expressions of the 'circularity' of dogmatic assertion simply as such. - And this figure also incorporates the 'critical' figure of Pyrrho's sceptical abstraction, which in Timon has taken on the negative form of satire. Around the same time, Cleanthes is incorporating this 'poetic' figure into stoicism, and Colotes, the disciple of Epicurus attacked at length by Plutarch(1) is dedicating his epicurean framing (and ridicule) of all previous and contemporary Philosophy to Ptolemy Philadelphus.

The Stoa's criticism of academic criticism was simple enough: we have to act - isn't our assertion of an ethical actuality of Providence, which - in part, at least - works, better than inaction until we have some complete account of our choice? Can you, beginning with a completely - dogmatically - open mind, find a better criterion than  $\phi\upsilon\nu\kappa\sigma\iota\kappa\alpha\ \kappa\alpha\tau\alpha\ \lambda\omicron\gamma\iota\sigma\mu\omicron\varsigma$ ? The first step of the Stoa is perhaps one-sided - but at least it is a first step. Without being in some sense one-sided, how can one even hope to resolve the fundamental symmetry of Sense? Is not the choice of whether to start somewhere or not to start at all, more radical than the

question of where to start? That is: we have a coherent frame of action, even if we haven't yet fully integrated in this frame the question posed by a certain circularity - what basis have you for choosing the activity of questioning that frame of activity, rather than our primary assertion of that frame?

Arcesilaus replied that we do not need, for our moral direction any 'universal' criterion, any unquestionable assertion of criteria. For the choices we must make are always made in particular situations. The principle of action is rooted in such specificity - there is no ground for 'deciding' a frame of action in abstraction from the irreducibly particular or individual case. The primary moral configuration of choice is the dramatic figure of which the stoic and epicurean criteria present two imaginary limits, frames in which all assertion can be framed, and in which the assertion of this universality is itself framed as certainty in unquestionable circularity. Rather does our assertion - our self-assertion in activity - in a situation whose very framing itself partakes of that order of assertion - know itself as ethical or moral in interaction with the configuration of what is open to us in successive situations, in whose unfolding or development our previous framing of what is open to us plays its part. Our choice and activity is thus rooted in the figure of τὸ εὐλογον - the 'reasonable' or 'probable' - that order, precisely, in which the Timaeus presents the 'framing' of the physical order, and might perhaps be taken as an extreme case.

Arcesilaus thus set the frame of inquiry of the Academy down to the time of Cicero - or rather down to the time of the schism induced by the headship of Antiochus (under whom Cicero studied in Athens) between about 70 and 50, in whom the Academy and Stoa converged - a development paralleled in the 'eclectic' stoicism of his contemporary Posidonius.

The Stoa, in Chrysippus, reacted to Arcesilaus criticism by incorporating the fundamental frame of the Question as a sort of 'theoretical' or logical space in which the closed circuit of the frame of the whole could be inscribed like the spherical Kosmos in Nothing. Everything was to be systematically inscribed in the figure of the exemplification of Reason in the initial assertion of Reason as primary frame of inscription, of which the material Sphere was simply the physical 'side'.

Carneades, as head of the Academy around the middle of the second century, developed, in turn, an equally systematic criticism of Chrysippus,

a radical frame of questioning in which the closure of Chrysippus' system was itself inscribed. Beginning with the figure of the Image, he emphasised the complementarity of its two 'sides'. Within this basic frame he developed a systematic theory of τὸ πιθανόν, likelihood. Corresponding to the simple mirroring of subjective and objective dimensions (sides) of the Image is simple opinion or belief. These figures of belief are then articulated in the familiar play of figure within figure, they are correlated - and this amounts to a different degree of 'likelihood'. Within this play or economy of belief, then, there distinguishes itself an actuality or working of certain figures, as it were in response to our 'subjective' assertion of such figures. - In particular, this figure of our assertion itself 'works' in this sense: our will is 'self-acting', and in this partakes of the highest degree of 'working' or actuality: it works.

Carneades (the model for Cotta in Cicero's 'dialogue' On the Nature of the Gods), while on an athenian embassy to Rome in 156 (as Plutarch records in his life of the elder Cato) aroused the suspicions of the conservative patrician Cato by giving two lectures on Justice on two successive days - in the first he presented Justice as the frame of all things, in the second as a delusion - this being an exemplary exposition of the principle of the Question in relation to the primary stoic circuit of cosmic Law. Cato persuaded the senate to send him home to Athens lest he disrupt the Law which was the very frame of roman life. At about the same time Panaetius introduced stoicism to Rome, where he (unlike Carneades) stayed for many years, until the <sup>assassination</sup> of his friend Scipio the Younger in 129. This association of Scipio and Panaetius might be taken to mark a first step in the cultural integration of Greece (or rather the hellenistic east) and Rome, reflecting the political integration of the Mediterranean by Rome for which Scipio, who had taken part in the defeat of Macedon in 168, and who had literally obliterated Carthage in 146, was in no little measure responsible. Panaetius imagined Rome to embody the stoic cosmopolitan ideal which Zeno had first seen in Alexander. From about the beginning of the fifth century the roman Republic had expanded from an isolated city to mastery of the Mediterranean - the World, almost - always within the constant frame of Law and Constitution, this frame itself developing legally and constitutionally as prescribed in the frame at any point of its development. And the slow progress of political dominance partook of the same figure of an 'internal' determination of the relations of the two 'sides' of the limits of the State, so wildly pursued by Alexander.

In transposing the 'cosmopolitan' frame of stoic activity from a greek idea to a roman reality, Panaetius at the same time transposed the correlative ideal of the stoic 'wise man' into a practical principle. The closed circuit of stoic Kosmos appears as a figure of the actuality of Reason, responding to our rational framing of activity in particular circumstances. In the primary frame of human interaction in (a roman) Law and State, the closed circuit of stoic Reason, and the academic analogue of this circuit in the actuality of 'the reasonable' in particular actions, appear as two complementary sides or figures abstracted from human Law as primary frame of all 'actual' situations. Our activity is no longer to be inscribed in the limiting circuit of a unitary Reason, in which the duality of Reason and Nature is rationally articulated from beginning to end of a unitary cosmic cycle in universal conflagration. Reason is simply one side of an everlasting Life of the Whole, in which it is constantly at work in our activity, which <sup>(or can embody)</sup> embodies the rational distinguishing of Reason and Nature or Sense in particular situations - and, most particularly, in the rational framing of our interaction in Law we make or frame. This actuality of Reason is Providence at work, in which work we play our part. And just as the dramatic frame of a Law-in-the-making, framing our activity as we frame further laws, replaces the ideal frame of cosmic Reason in which the articulation of Time itself is inscribed, so the correlative figures of 'astrological' inscription of our activity in the primary astral articulation of Time, and the correlation of present and future in divination, current in the Stoa (it seems) from Zeno on, are left behind by Panaetius.

This configuration of reflection, corresponding to the first integration of the World of Antiquity in a roman 'frame' of government (however remote this still remained from the 'particular situations' of activity in Greece or Syria or Egypt) around the middle of the second century may be taken to mark a simple configuration of transition from Reflection (and its outward situation) in the third century, to Reflection in the first, from Arcesilaus, say, down to Cicero. For in Cicero's dialogues the opposition between the simple stoic scheme of the third century, and a critical Academy has been more or less overcome through the integration of the less radically opposed schemes of Panaetius and Carneades. Panaetius' framing of the particular situation emphasised in the Academy in a sort of limiting case, the Law as frame of interaction, provides, as it were, a (literally) 'positive' element which should enter into our framing of action in particular cases. Carneades' critical principles constitute another

'side' of this business, and the primary frame of deliberation finds its figure or model in the meeting of these two sides in a particular 'case', in the Court whose primary proponent Cicero, towards the middle of the first century, had become.

It was, indeed, Cicero's 'acting-out' of such principles in the Roman assemblies which had led to his retirement from public life around the middle of the century, and his murder at Mark Anthony's instigation in 43, following the fierce attacks upon Anthony's ambition in a series of speeches following Caesar's assassination (of which he approved) the previous year.

'Externally', the extension of Roman dominance to the limits of the 'civilised' World (more or less) by the middle of the second century, was immediately succeeded by the internal divisions in which, by the time Caesar crossed the Rubicon and entered Rome with the Army of Gaul in 49, the military forces which had extended the limits of Roman domination without, had become irretrievably involved. The disruption of the rational order of the legalistic republican constitution, supported by the 'middle' commercial class to which Cicero belonged, in the conflict of a senate (which had, over the latter period of external expansion, become a virtual oligarchy) with the 'democratic' forces of the lower class of plebeians, embodies just that primary figure of political pathology defined by Aristotle: an oligarchic suppression by the rich of the interests of the multitude leads sooner or later to a democratic revolution (represented at Rome by Marius) which in turn leads to tyranny (Julius Caesar, and his successors). The subordination of the organisation of the State to sectional interests, when the expansion which has fuelled the development of these interests reaches a limit, rapidly leads (or led) to 'economic' chaos, and the disintegration of the rational order of political direction distinguishing its own finality in the frame of Law. Yet out of the disorder in which the old separation and balance of 'upper' and 'lower' classes is itself inscribed in a wider economy of sectional interest, and the Conflict previously expressed in the relations of 'within' and 'without', and dominated from within, itself appears 'within' (having assimilated all that was 'without') arises a new order. The initial idea of such a new order appears around mid-century with the 'imperium' of Caesar, and his proposed rational extension of unitary Law, <sup>economy,</sup> and government (and military order) throughout the 'World'. Its implementation, as far as practically possible, was effected by his heir Augustus, towards the beginning of our Era.

It is this augustan World which frames the Question of the Incarnation of Λόγος which marks the beginning of our 'Era', our Time. I will shortly try to suggest how the figure of this Question may be seen to attach to that unitary frame of Law simply as such - as the frame of 'the World'. Augustus restored the elements of the republican constitution, constitutionally integrated in an Empire where his own authority was in all things 'decisive', without yet being arbitrary - as it was to become under his immediate successors. In this framing of Augustus' action, one may see a coincidence of the stoic and academic figures of action. Cicero's court has become a World framed in Law, with Augustus legally presiding as Judge. In such 'self-activity' (in Carneades' phrase) Augustus partakes of the figure of divinity, accorded to him by the constitution itself. His assertion, in this Frame of the World, frames the force of this assertion itself. World and Stage coincide. According to tradition he called, just before he died, for a mirror, and arranging his hair asked those about him 'Did I play my part well? If so, applaud'.

Now this 'self-activity' of Augustus ('consecrated')'s part in such a World is itself simply one component of the Question or Mystery of 'Incarnation', <sup>of Λόγος</sup> a limiting case of a more general figure in which it is itself implicated. In order to inscribe the more general figure in this text, I must bring in one further component, and show, among other things, how around this time the alexandrian tradition, which I have left with Ptolemy Soter at the beginning of the third century, <sup>with those of Athens and Rome</sup> converges <sub>in a</sub> Question or Mystery, just as the political and economic frame of that tradition is integrated in the World which frames the Mystery, through egyptian recognition of roman sovereignty in the middle of the second century, Caesar's intervention in the dynastic conflict a century later, and Augustus' final incorporation of Egypt as a roman province after his defeat of Anthony (in 31) who had divided with him the World after the assassination of Caesar, and ruled in the East with Cleopatra, the last of the Ptolemies.

Here I must be still more schematic than before, and yet at the same time must apologise for the complexity of the frame here elaborated from the initial configuration of the pythagorean mystery at Croton, down to the 'mystery' which marks - since the sixth century of our Era - the beginning of this Era. When all the elements which I have interposed between these two 'mysteries' have been set out - in a few more pages - it should be possible to see rather more clearly their coordination or articulation within the rather simple figure of transition from the first mystery to the second. - And on this basis the transition from the beginning of our Era to the inscription of these transitions in this text should itself begin to become clearer.

We left Alexandria with the founding of the Museum and Library, under the direction of Ptolemy Soter, Strato and Demetrius of Phaleron, around the beginning of the third century. I suggested a parallel between the School of Alexandria and those of Athens, drawn in terms of two complementary steps forward from the aristotelian Economy of Kosmos. The two dominant athenian schools at the beginning of the century - those of Zeno and Epicurus - I suggested might be seen to be framed in two opposed 'versions' of a common figure of abstraction from Aristotle's Economy (or rather: a common figure of 'concretion'). This figure was reflected in that Economy as the 'poetic' frame of Drama, 'acting', Action. The athenian 'step' then, into this figure of Action, involved the inscription of the theoretical circuit of Aristotle's Economy of Kosmos in a more radical frame of dramatic assertion within a play of Figure, a poetic order of Analogy, of the Image, of figure-within-figure, where no figure of this 'inscription' could frame 'from outside' this play: the figure of inscription must itself be found at work in this initial confusion. Aristotle's starting-point, then - an initial 'verbal' separation of two sides of the Image, in abstraction from the question of the 'imagery' of this distinction - appears in this more radical frame as 'arbitrary', a choice of the framing of questions which does not know itself as such - which is not itself in question.



The stoic and epicurean 'criteria' might, I suggested, be seen to incorporate two converse 'versions', within a radical play of the Image, of a primary figure of choice or inscription. - Choice being, as it were, an 'inscription' of what we 'choose' in a primary frame of 'Actuality' or working - a primary frame correlative with the inscription in it of 'choice' or inscription itself: this being the 'actuality' of choice - choice as a kind of self-inscription, 'deciding' its own actuality, identifying itself by exemplifying itself in the act of defining itself, in its own 'definition'. - This amounts then to a 'concretion' of a more radical intermediate order from the abstract poles of Form and Matter, or from those of self and object - 'this' side and 'that' side of the Image. - And this 'concretion' is in a way 'open' in the aristotelian Economy of Figure - as a choice which frames its own inscription, and so 'actualises' (as it were) the figure of Active Reason, distinguishing itself from its merely formal or nominal inscription in the peripatetic Economy of In and Out, of Contradiction and Excluded Middle.

I suggested that <sup>in</sup> the Mathematics and Medecine which dominated the Inquiry of the alexandrian Museum, one might find a parallel 'abstraction' from Aristotle's limiting theoretical circuit - an abstraction, precisely, that mirrors the stoic and epicurean 'concretions' of Action or Drama, in the common figure of a determination of the two 'sides' of Figure or Image from one side: - A common figure, indeed, of a 'mirroring' of one side in the other, framed by the 'poetic' symmetry of the two sides, 'logical' and 'physical'. I suggested that the incorporation of the 'model' school of the Lyceum within the carefully planned ptolemaic State, its 'egyptian' hierarchical organisation, corresponded to an 'abstraction' of Theory from the 'ethical' or 'political' frame which Aristotle had made a sort of theoretical 'mirror', with Theory and Kosmos as its two 'sides'. This 'abstraction', then, like the stoic and epicurean 'concretions' of Theory into a practical vision, a framing of the mirror of Reflection and Kosmos in activity (as itself the very frame of Action or activity), involves the inscription of the circuit of 'pure' Theory in a more radical frame of activity of which it is seen to be but one side, a sort of imaginary limiting case, a pole. In Athens, then, this figure of the inscription of theory in Action (inverting Aristotle's theoretical determination of Action abstracted from 'Drama' or the 'play' of Figure) appears in terms of a figure of inscription or choice of a frame of inscription, in which this initial choice is itself inscribed, exemplifying what it chooses. In Alexandria, on the contrary, the 'theoret-

ical' framing of Theory or Inquiry is replaced by a 'political' framing, which is not itself 'in question' - questions are rather inscribed in the activity of a School which is itself 'inscribed' in the political framing of activity in the egyptian State. The Museum carries on inquiries into Mathematics and Medecine, and towards the middle of the century Callimachus establishes the 'alexandrian' school of Music or Philology ('applied poetics') which dominates activity in the Library.

But how, more precisely, do alexandrian Mathematics, Medecine, and 'Music' in the third century embody analogues of the stoic, epicurean and academic 'concretions' of activity or Actuality, <sup>of</sup> that 'working' which frames the aristotelian Economy?

Mathematics, first of all: Euclid, a contemporary of Zeno and Epicurus, who probably studied at the Academy before teaching in Alexandria, set out a 'frame' of mathematical inquiry, in which all further development was 'in theory' inscribed until the beginning of our Era, when 'neopythagorean' elements were beginning to appear (just as analogous 'neopythagorean' elements began to appear in combination with the stoic frame of Kosmos, notably at Alexandria). The first 'step' into this frame, into the 'Elements' (Στοιχεῖα - alphabet, A-B-C) of the 'point', σημεῖον, 'mark', an empty 'logical' determination of that figure of 'position' which is an empty image of the self-position which 'frames' Aristotle's Kosmos. The initial inscription of such a 'point' in a correlative 'frame' of mathematical 'space', with its three 'dimensions' or orders of points 'standing outside' our initial affirmation of simple 'position' ('a point is what has no part' is the first assertion, the opening, of the first of the thirteen books of Elements) may be viewed as a direct analogue of Zeno's initial assertion of the rational inscription of the figure of assertion in the limiting or primary 'logical' frame of <sup>λογος</sup> Reason, Word. <sup>the first</sup> The book opens with <sup>thirteenth</sup> "Ἄρα, 'definitions': the <sup>λογος</sup> <sup>λογος</sup> is that of <sup>λογος</sup> <sup>λογος</sup> itself:

ὄρος ἔστιν, ὃ τινός ἐστι πέρας

ὄρος is that which is the limit of anything

A 'point', in the third ὄρος, 'defines' 'line', γραμμή, 'inscription':

γραμμῆς δὲ πέρατα σημεῖα

The limits of a line are points

The second  $\epsilon\lambda\epsilon\gamma$  relates the first, third, and thirteenth in a definition of extension in one dimension, line, on the analogy of the 'points' which are its parts, as that which, rather than having no 'parts', has no 'breadth'; has only one sort of 'limit' or part, and this itself with no parts, a 'point':

$\gamma\lambda\lambda\lambda \delta\epsilon \mu\eta\kappa\omicron\varsigma \kappa\alpha\tau\alpha\tau\epsilon\iota\varsigma$

A line is extension without breadth

Then a figure,  $\sigma\chi\eta\mu\alpha$ , is an order of such 'inscription' of figure within figure, eventually reaching the irreducible figure of point:

$\Sigma\chi\eta\mu\acute{\alpha} \epsilon\sigma\tau\iota \tau\acute{o} \dot{\upsilon}\pi\omicron \tau\iota\upsilon\varsigma \eta \tau\iota\upsilon\upsilon\varsigma \delta\epsilon\omega\upsilon \pi\epsilon\pi\epsilon\sigma\chi\acute{o}\mu\epsilon\upsilon\omicron\iota$

A figure is what is contained in any  $\acute{\omicron}\rho\omicron\varsigma$  or  $\acute{\omicron}\rho\omicron\iota$

The 'space' in which figures can be articulated or constructed is then itself determined by a series of five 'postulates': a 'straight' line can be drawn between any two points, and any such line can be extended without limit; a 'circle' can be drawn with any point as 'centre', and with any 'diameter'; all 'right' 'angles' in all figures are equal - and, the historically important 'fifth postulate', that two straight lines cut by a third so that the internal angles on one side of the figure are less than two right angles, eventually meet on that side - the 'parallel postulate'.

The axioms or 'common knowns' of any question follow, defining principles of inscription or containment of figure within figure, just as the aristotelian 'axioms' common to all knowledge or 'science', those of Contradiction and Excluded Middle, define the two 'sides' of a distinction simply as such.

The development of the Elements then proceeds 'logically' from the point, through the various principles of figure ultimately reducible to the point, through the prior figures from which they are constructed, to the construction of the five symmetries of Space - the 'platonic' or 'cosmic' regular solids, with which the 'physics' of the Timaeus begins. In this sense the inscription in a formal Space, in the simple symmetry of its 'points', of the 'elements' of Matter corresponds to a figure of 'dialectical' or 'logical' determination of the Frame of Kosmos, as articulated between the bare figure of 'position' and a correlative frame of

'geometrical' Space. 'Arithmetic', or the symmetries inscribed within the initial distinction of 'two' sides of logical distinction, is itself inscribed within the 'geometrical' logic of figure, of 'spatial' inscription, and a mathematics where the figure of question is 'decided' by the rules of inscription of figure within figure, articulated between the complementary poles of point and space. - Just as stoic 'decision' is analogously articulated between the two poles of an initial affirmation or 'thesis', and the primary frame of a Reason, in which the initial assertion is just the assertion of its own inscription. The 'concretion' of the initial stoic figure in this 'mirrors' the abstraction which 'defines' the frame of euclidean mathematics,

Euclid's abstraction thus partakes of the same 'logical' figure of a logical determination of the two 'sides' of an image of 'containment'. But whereas the stoic 'criterion' concretises the merely formal distinction of these two 'sides' of Figure in an act of distinction which is the inscription of itself in the order of inscription of one side in the other, Euclid, on the other hand, quite abstracts from any 'personal' involvement in his theoretical narrative, his very 'object' being defined from the outset in terms of a purely formal distinction of what is or is not 'contained' in any 'figure', a 'definition',  $\delta\epsilon\sigma\varsigma$ , which actually constitutes the 'figure' it defines, rather as the stoic criterion actually 'decides' or defines its own application.

'By definition', then, within the primary figure of definition defined as  $\delta\epsilon\sigma\varsigma$ , the logical order of inscription as assertion of certain characters in a figure, exactly mirrors the physical order of inscription of one figure within another, the two orders coinciding in the point, and the symmetries of its spatial frame, with which the Elements open and close. There is no distinction between a logical 'figure' of inscription and its 'physical' or spatial embodiment, and thus no 'identity' of matter 'in' which a particular logical figure is embodied, and no corresponding figure of movement or time. The 'time' of the Elements is a logical time of demonstration, of analysis and synthesis, decomposition and composition of figure from or to its 'logical' elements. Figure has been quite abstracted from the figure of Action, within the frame of a formal determination of 'inscription', abstracted from the physical order of 'definition' of an actual body in time. - This through the figure of 'boundary',  $\sigma\epsilon\mu\alpha\varsigma$ , 'term', in which a logical order of 'position' posits itself, inscribes itself si-

lently in 'mathematical' Figure, as the figure of 'inscription' of one figure within another - point in line, line in triangle or surface or circle- which in turn constitutes these figures as 'ideal', mathematical, and constitutes itself 'ideal' definition, like the figure of mathematical 'boundary' or limit, which it repeats in its own implicit 'definition' as logical order of 'definition'.

Euclid died, like Zeno and Epicurus, around the end of the first third of the third century. Archimedes, the foremost mathematician of Antiquity (and, according to many of the foremost mathematicians since, the foremost in any period including Antiquity) was born in Syracuse about twenty years before Euclid's death, where he returned, after studying at Alexandria under Euclid's successor Conon. Syracuse in his time still dominated the affairs of Greater Greece, which has been exempt from the macedonian conquests of Philip and Alexander, like that phoenician colony and mother-of-colonies Carthage, her great rival in trade and influence. Archimedes died in the roman sack of Syracuse<sup>(212)</sup> after the siege of three years in which his machines, according to the account given by Plutarch in his life of the roman general Marcellus (who was besieging the city), were the very defence of the city:

All the other syracusans were only a body for Archimedes' apparatus, <sup>(ἐπινοημάτων)</sup> and his the one soul moving and turning everything: all other weapons lay idle, and the city then used his alone, both for offense and defence. In the end the romans became so filled with fear that, if they saw a little piece of rope or wood projecting over the wall, they cried 'There it is, Archimedes is training some machine <sup>μηχανή</sup> upon us', and <sup>turned</sup> fled. Marcellus, seeing this, abandoned all fighting <sup>and</sup> assault, and for the future relied on a long siege (1)

(This siege, following an alliance of Carthage and Syracuse in the second carthaginian ('punic') war, <sup>effectively</sup> ended the independence of Greater Greece from Rome).

(μηχαναί)

These 'machines' were the applications of Archimedes' mathematical principles which he himself regarded (the applications) as of very secondary importance<sup>(2)</sup> - And these 'mechanical' principles amount to the inscription in the euclidean frame of the figure of movement, and

1: Life of Marcellus, ch 17, 4, 3. 2. <sup>his</sup> ch 17, 3-7

correlative mass or matter. This figure of 'mechanics' constitutes one side of Archimedes' mathematical activity (the 'physical' side, one might say). His activity as a whole, expressed in his communications with Alexandria (with the mathematical school attached to the Museum) may be characterised by the more general figure of configurations 'abstracted' (or rather concreted) from the 'elementary' articulation of figure reducible to euclidean 'synthesis' from the limiting figure of point. His work is marked by the integration of the converse 'movements' of analysis (decomposition) and synthesis (construction and proof, reconstruction) in particular configurations, generally involving some 'mechanical' element (for example, 'mechanical' curves that cannot be constructed with ruler and compass - with straight line and circle, but which are defined by a point 'moving' within certain formal constraints - a 'spiral', for example: a point moving uniformly along a straight line uniformly turning about a fixed point). This 'logical' <sup>(mathematical)</sup> determination of the 'poetic' frame of Action in the simplest figure of Movement is in a way parallel to the extension of stoical principals to the poetic frame of Cleanthes' hymn. More generally, it might be said to be inscribed in the figure of transition from a thoroughly 'one-sided' determination of the poetic frame of inscription around the beginning of the century, towards a more symmetrical determination around the middle of the century.

- τα μηχανικά (μετακίνησις τεχνή?)

To be more specific: the Mechanics <sup>with</sup> introduces into the euclidean frame only the simple correlation of matter a simple asymmetry of Space - a correlation of matter and a direction of movement, 'fall' (familiar as Aristotle's fundamental 'physical' principle, and as that of Epicurus). 'Mechanics' is then inscribed in the simple symmetry (in this movement) of 'balance': if a uniform line or rod (or more complex configuration, symmetrical about the 'direction of movement' as represented by a line through a fixed point of the configuration) is fixed at the central point (equidistant from each end), then it will 'balance', for any principle that would cause one end to fall (and the other, then, to rise) would, if applied to the same configuration seen, as it were, from the other side, cause that first end to rise and the other to fall: so there can be no such principle of movement, and the rod will 'balance' at the centre, an equal 'force' or 'power' being exerted by the 'weight' or mass on either side tending to turn the rod about the centre.

Consider, then, forces exerted at two points, at distances A

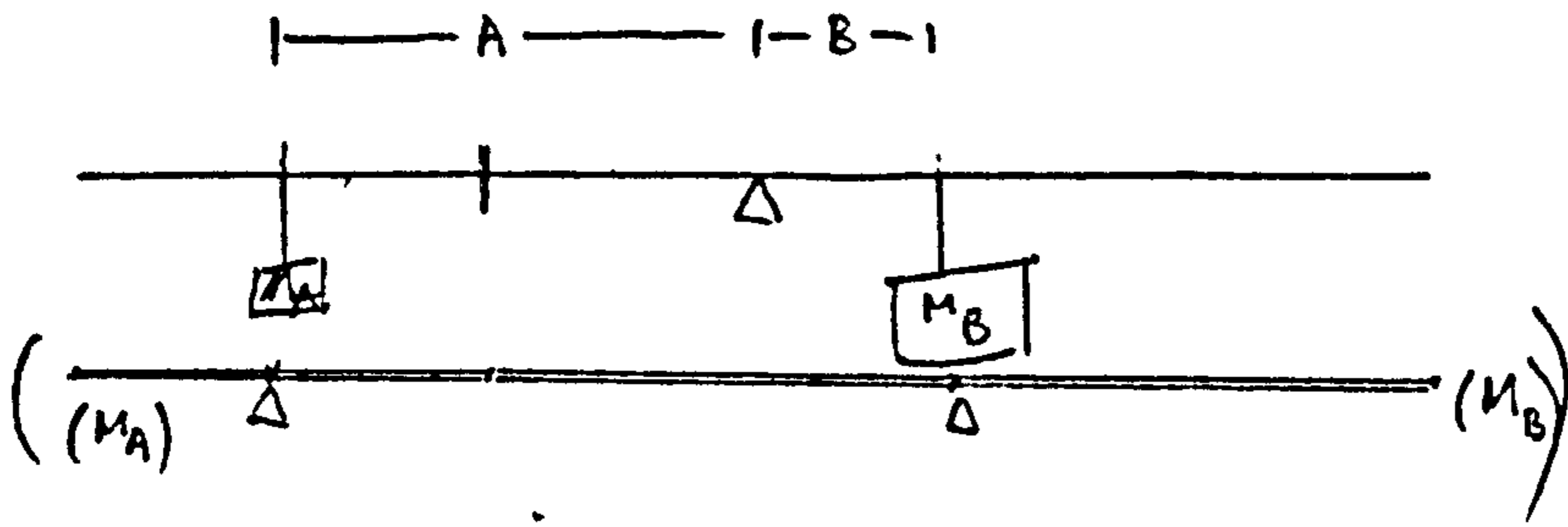

and B from a fixed point of a weightless rod. Again from principles of symmetry, the forces at these points, corresponding to weights  $M_A$  and  $M_B$ , might be considered to be applied in the form of two lengths,  $M_A$  and  $M_B$ , of a uniform strip of material of constant width. And since the forces will be the same no matter how these strips are fixed at A and B, we may consider them fixed along the rod, and we may suppose that the lengths are such that the ends of the strips just meet. But then we will have, in effect a massive strip of length  $M_A$ -plus- $M_B$  balanced at our fixed point - and so this fixed point must in fact (from the earlier fundamental symmetry of balance) be the midpoint of the combined length.

Then A must be  $\frac{1}{2}(M_A + M_B)$  less  $\frac{1}{2}M_A$  or  $\frac{1}{2}M_B$  in some units of length and weight in which B is  $\frac{1}{2}(M_A + M_B)$  less  $\frac{1}{2}M_B$  - or  $\frac{1}{2}M_A$ , and we have the general principle of the balance or lever (applied in the 'roman balance,' with fixed pan and fulcrum, and movable weight, while our initial principle corresponds to the ordinary balance or 'scales'): the relative distances of the weights applied, A and B, are directly proportional to the weights applied on the other side - or: the product of <sup>the</sup> weight and the distance from the fixed point or fulcrum at which it is applied is the same on either side. Archimedes goes on to define the 'centre of gravity(or weight)' of complicated bodies and configurations as the point of intersection of lines through the configuration which are imaginary extensions of the line formed by a string from which the body is hung. Equivalently it is a point which, if fixed, balances the configuration or body. He constructs or calculates the centres of gravity of various such complex configurations, each new figure being inscribed in the elementary figure of balance according to the principles of euclidean inscription or geometry.

If, then, we are to use a lever to raise a weight attached (or otherwise acting) at a certain distance from the fixed point or fulcrum of the rod or lever, we must apply a contrary force at such a distance that the products of force and distance from fulcrum are equal (together with some minimal initial impulse, as small as we like, to produce movement). If, now, we consider the work done in raising the weight  $M_A$  a small distance  $A/n$ , this will be equivalent to the work done in reversing the movement, and raising  $M_B$  through the distance  $B/n$  (since we can make the

unbalancing impulse as small as we like - any additional weight will tilt the balance: such a moving force simply is 'extra weight').

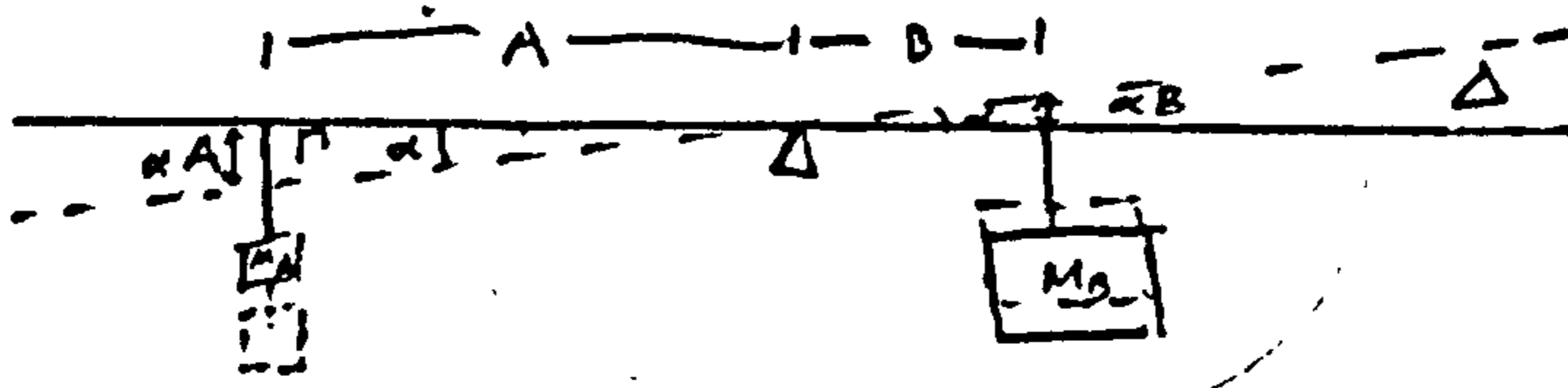

- Thus the weight or force on either side compounded (multiplied) with the distance through which it moves (this distance being, from the geometry of the configuration, proportional to the distance, A or B, of the weight or force from the fulcrum) is equal on either side. <sup>(the areas  $\Gamma, \Delta$  are equal)</sup> The 'work' done on one side, 'put in', is equal to the work effected on the other - the work we 'get out' of the machine. And further, the movement, κίνησις or momentum, given by the initial impulse on one side (say, the weight compounded or multiplied with the speed of the imparted movement) is, from similar considerations of the 'symmetry' of the system, equal to the impulse produced on the other side. What we put 'in' to the system on one side is ('ideally') what we get 'out' at the other. The net 'work' or 'momentum' of the closed system, considered in abstraction from its context, remains the same, unless something is put 'in' or taken 'out', from or to the context of the 'closed' system.

These elementary 'symmetries' of movement are enunciated <sup>by Aristotle</sup> ~~without~~ any demonstration in the fifth chapter of the seventh book of the Physics, and they are used, in such a form, to demonstrate the 'working' of <sup>two of</sup> the three 'elementary' machines (lever and pulley: from these, together with the inclined plane, all composite machines can be 'constructed') in the pseudo-aristotelian Mechanics (probably due to Strato, the first head of the Museum). Archimedes frames the basic principles of 'statics' - of equilibrium or balance - there developed (and dating back, in some form, to Plato's pythagorean contemporary Archytas) within the geometrical Figure of Euclid's Elements. And this within the simple figure of correlation of matter and a direction of movement, in which Aristotle had framed Physics. The mathematical configuration of an Action thus introduced around the middle of the third century develops eventually into the primary mirror of 'logical' and 'physical' orders - the mathematical frame - of the 'scientific revolution' which I take to mark a sort of midpoint of the Tradition of Reflection as a whole. A 'midpoint' in that it embodies the simplest symmetry (of logical and physical orders of the Tradition) in a simplest or minimal form - a



simple 'poetic' symmetry of the Tradition as a Story, a History (of Reflection) - a simple expression of the figure of that 'transition' itself, in which the various phases, themes, elements, of the Tradition may be inscribed as so many components of a unitary frame of Action - of a Drama or Story.

Thus (for example) the 'mechanics', the mathematical physics in which my contemporaries frame this 'here' and 'now' and material embodiment of this my writing, is itself framed by the simple figure of an abstraction of (concretion of, rather) the 'mathematical' frame of Archimedes' Action, from the euclidean limits of mathematical Space and mathematical point. And just as, at Athens, an analogous 'concretion' from the formal limits of position and Kosmos (the aristotelian frame of 'here' and 'now' and 'matter', of Action) was being effected in the figure of Action or Drama, the inscriptions of its 'positing' in the frame posited, chosen, so now does the concretion from euclidean point and its purely formal 'position' or positing, embody just that same figure of Drama, in a form closest to Arcesilaus' expression or presentation of the figure. To take a further 'example' of such 'historical' symmetry, in relation to this figure of Action: the transition from the 'middle' phase of the Tradition (turning about the 'scientific revolution' of the seventeenth century), to this latter phase, towards whose close I am now writing, is marked in 'mechanics' or mathematical physics by the systematic articulation of mechanical configuration in general, within the simple figure or symmetry of Action first clearly presented by Archimedes. - Towards the end of the eighteenth century of our Era Lagrange articulated mechanics within the figure of Action as (in his terms) 'a geometry of four dimensions - Time and the three dimensions of Space' - one mechanical configuration inscribed within another in terms of a generalisation of 'positions' and 'momenta' of components, abstracted from the limiting case of 'positions' and 'momenta' in euclidean Space. Around the beginning of this succeeding 'latter' phase of the Tradition, Laplace applied this method to the systematic inscription of the movements of the 'planets', the wandering stars, in a 'mechanical' frame of Kosmos.

Archimedes appears to have applied his fundamental principles of Action - or work, or movement, to at least the pulley in a lost work on Machines. The principle of the pulley, corresponding to the fundamental

principle of a 'closed' system discovered 'at work' in the lever, is simply that the work put in by a weight of force  $M_A$  falling through a distance A is (ideally) equal to the work 'got out' of the machine in raising a weight  $M_B$  through a distance B:  $M_A$  compounded ('times') A is equal to  $M_B$  'times' B:

- In the fourteenth chapter of his Life of Marcellus, Plutarch relates how Archimedes told his kinsman Hiero, king of Syracuse, that with a given force it is possible to move any given weight. He exemplified his principle, at Hiero's request, by pulling towards himself a heavily laden ship: 'he pulled gently with his hand at the end of a compound machine' which the commentators of Antiquity tell us was a compound pulley. It was this that induced the king, says Plutarch, to engage Archimedes in the construction of military machines.

(Augustus' 'engineer' Vitruvius relates another celebrated story connecting Archimedes and Hiero (in the preface to the ninth book On Architecture) in the discovery of the fundamental principle of fluid mechanics. Archimedes, having found that his body was subject to an upward force equal to the weight of water it displaced in the public baths is said to have run home naked crying εὕρηκα - I've found it! His Floating Bodies begins with the simple configuration of a body exerting force at a point in a fluid, due to its weight, - its tendency to fall. The configuration of complex floating bodies in a fluid are then derived from the elementary principle that (in effect) if the force exerted on some part of the water in some direction is greater than that exerted in the opposite direction the water will move: in a static configuration the balanced forces acting at any point amount to a compression or 'pressure' at that point - if the pressures at two communicating points at the same level are unequal, the water will flow from the point of higher, to that of lower, pressure.)

Archimedes' assertion that any given force can in principle

move any given weight ('Give me somewhere to stand and I will move the Earth'), depends upon the 'arithmetical' principle that any given extension, taken a suitable number of times, will exceed any (other) given extension ('Archimedes' Principle'). This principle of the unitary character of number (the relations of any numbers are themselves contained by a number) or extension - the principle, in effect, that all spatial relations can be measured by a single given 'unit' or measure (thus he calculates the number of grains of sand that would fill the Kosmos) - lies at the base of his work in geometry proper (as of his 'arithmetic'). This work is mainly concerned with the systematic elaboration of the Method of Exhaustion, first demonstrated by Plato's associate Eudoxus. His main exposition of the Method is in his work On the Sphere and Cylinder, which he regarded as his masterpiece. Cicero, when quaestor in Sicily, discovered Archimedes' tomb, on which was inscribed a cylinder containing a sphere, and the λόγος, ratio, of the volumes of containing cylinder and contained sphere.

Archimedes proceeds by defining an 'element' of length, area or volume, described in terms of a set of 'parameters', of which the chief is the number of such 'elements' contained in, and containing the figure to be determined or 'measured', 'squared' (measured by the basic unit). Thus, to square the circle, we would consider an 'inscribed' and 'circumscribed' regular polygon of  $N$  sides:

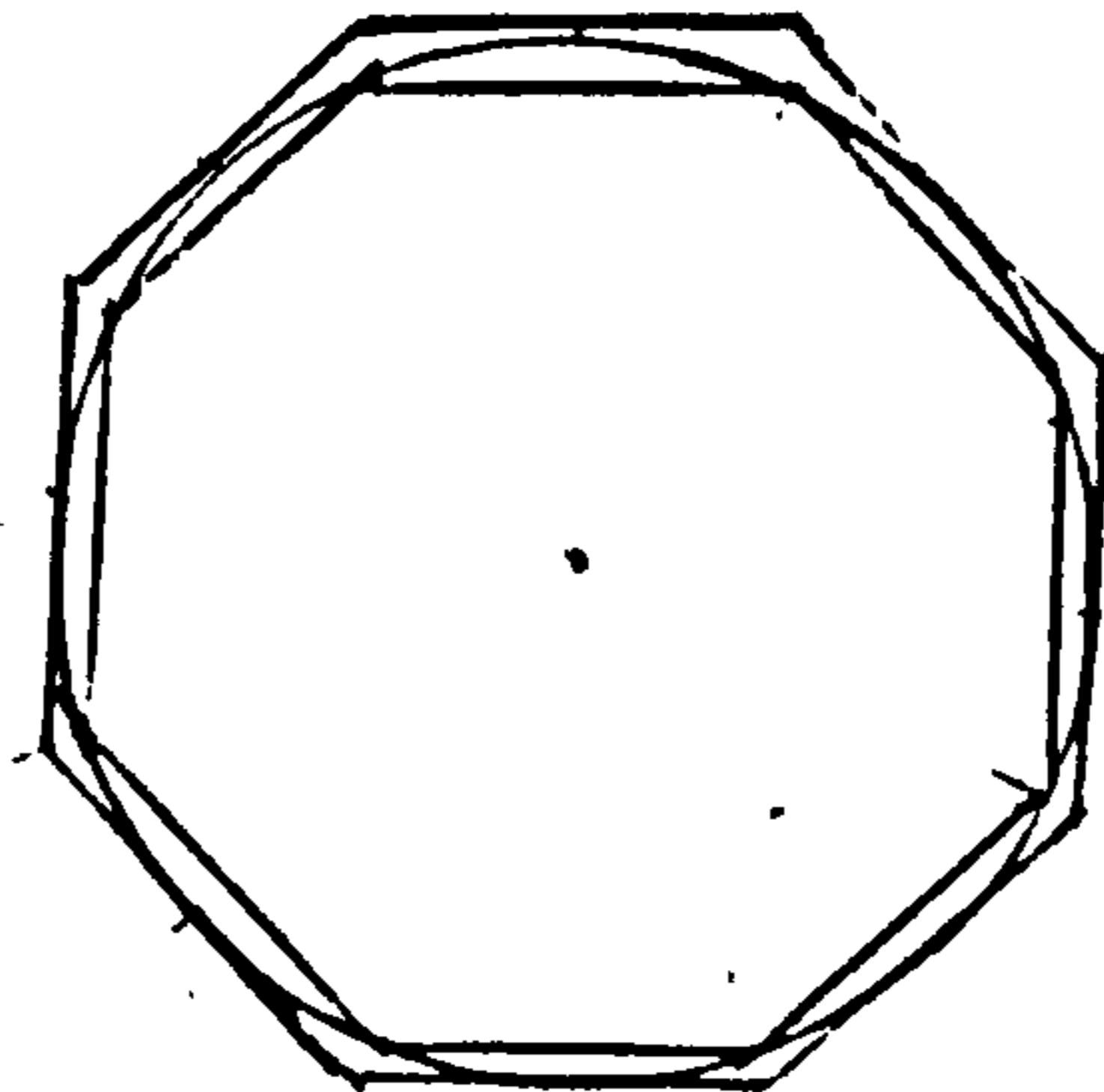

here, for example,  
( $N=8$ )

We may then approximate as closely as we like to the circumference or perimeter of the circle by making  $N$  sufficiently large. By considering the relations between the corresponding 'elements' of approximations to the volume of cylinder and inscribed sphere, Archimedes shows that the volume of the cylinder is  $4/3$  times the volume of the contained sphere. A definite, exact relation, is abstracted from two 'parallel' indefinite or unlimited processes of approximation. Within the frame of this demonstration, Archimedes finds relations between the fundamental circular 'measure' of the circumference of the circle in terms of its diameter taken as unit (first denoted by a definite 'term' around the middle of the seventeenth century), and various areas and volumes defined by simple solids combined in various ways with one another and with planes or lines

which 'cut' these figures in various ways. Thus he in effect considers, within the euclidean frame, definite relations among elementary figures that cannot be expressed in terms of a definite unitary reduction of the figures or configurations to point and unit. The relations thus belong to an intermediate domain of 'figure' abstracted (or, again, 'concreted') from the elementary correlation of euclidean point and the simple symmetry of such 'points' of an empty euclidean Space. Here, as in the analogous abstraction from the elementary frame of the Mechanics, one simple principle (other than 'Archimedes' Principle' which is in effect the basis of the euclidean arithmetic of the Elements), serves to frame the whole development within the euclidean frame taken as primary. At the beginning of the work On the Sphere and Cylinder, Archimedes defines what it is for one line to be 'inside' another, on the basis of the principle that a 'straight line' - which Euclid had defined <sup>in the fourth ~~book~~</sup> as one which 'lies in the same way with its points',  $\acute{\epsilon}\xi\ \tau\omega\sigma\ \tau\omega\tau\epsilon\ \acute{\epsilon}\phi'\ \acute{\epsilon}\lambda\upsilon\tau\eta\varsigma\ \sigma\upsilon\gamma\mu\acute{\alpha}\tau\omega\varsigma\ \kappa\acute{\alpha}\tau\alpha$  - is 'the least of those lines with the same end-points'. Euclid's definition amounts to saying that a 'straight' line has every part 'straight': any section has the same figure as the whole - the 'straight' line is defined by two points (and is thus the next 'figure' to be defined after 'point' in the first definition of the Elements, and 'line' in the second (and their general relation in the third)). This principle, together with the fundamental principle of the Mechanics, together constitute the frame of determination of physical actuality, as I write: the Principle of Least Action. The mathematical inscription or articulation of the physical order within this principle (the frame of Action already alluded to does not decide between various possible orders of inscription of action within action; the principle of Least Action completely determines the 'physical' order of a configuration). In particular, the articulation of physical 'Optics' as primary instance of this frame (here the 'principle of least action' appears in the form of a 'principle of least time' or 'least optical path') was effected around the middle of the seventeenth century (by Fermat); the still more particular case of 'catoptrics' or the articulation of reflection in mirrors was recognised by the great engineer Hero of Alexandria (perhaps around the beginning of our Era - Hero's dates are not sure).

Towards the end of the third century the polymath Eratosthenes, who had succeeded Callimachus<sup>nval / Apollonius of Rhodes</sup> as librarian (and who was a close friend of Archimedes, and one of his principle correspondents) set about integrating the various geographical and historical materials at his disposal in a unitary frame of Chronology and 'Geography' based upon Astronomy - a unitary frame of Time and Place which might be said to parallel Chrysippus' 'rational' framing of the stoic World around the same time at Athens, where indeed Eratosthenes had studied for a while. At the Museum, mathematical activity was, at this time, dominated by Apollonius of Perga. Eratosthenes was apparently for some reason called  $\epsilon$ , Apollonius  $\rho$ ; we do not know why.

We do, however know why Apollonius was called the 'great geometer':

(His predecessors investigated the sections of a cone by a plane in particular cones, always cutting one side of the cone in a right angle) But later Apollonius of Perga proved generally that all the sections can be obtained in any cone, whether right or scalene, according to the different relations of the plane to the cone. In admiration for this, and on account of the remarkable nature of the theorems in conics proved by him, his contemporaries called him the Great Geometer.'(1)

A cone is defined by a circle and a point 'outside' the plane of the circle - as the surface<sup>(formed by the meeting of)</sup> (containing all lines) through a point on the circle and the single point (vertex) outside the plane of the circle. The intersection - the points of coincidence - with a plane is a 'conic' - a conic section or section of the cone. What is characteristic of Apollonius' work is that relations in this plane are understood through 'embedding' the plane in the third dimension including the cone, and this leads to a general analysis of 'four-line loci' in the plane. - That is of 'loci' or lines constituted by all the points defined (by Pappus) by the following constraints:

If straight lines be drawn (from the point) to meet at given angles four straight lines given in position, and the ratio of the rectangle contained by two of the straight lines (ie, their product) so drawn towards the rectangle contained by the remaining two be given, then.. the point will lie on a conic section (thus) given in position. (2)

In the 'three-line locus', one of the products ('rectangles') is replaced by the square of the third line (ie, two lines of the more general four-line locus coincide). The whole treatment (analogously with all the cases con-

sidered thus far) is framed by the 'projection' onto any plane of the figure earlier shown (in the discussion of the early pythagoreans above) to embody Pythagoras' Theorem, relating linear and square measure:

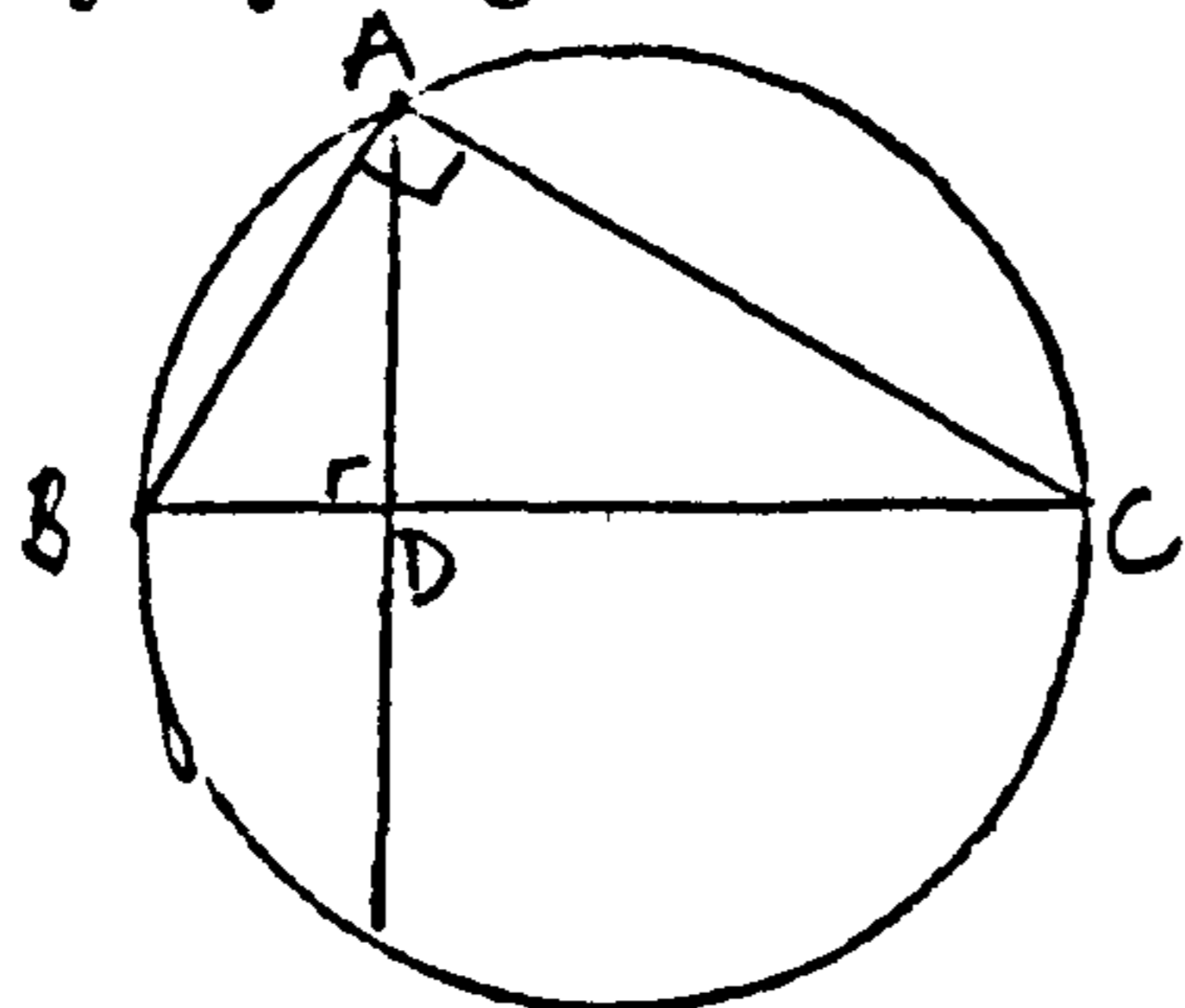

- The angle in a semicircle is a right angle, and so  $BD:DA = AD:DC$  (since the triangles  $BDA, ADC$  are similar) and thus  $BD \cdot DC = DA \cdot AD$ , the square on  $AD$  is equal to the 'rectangle' with sides  $BD, DC$ .

The general analogue for conic sections is derived from the figure:

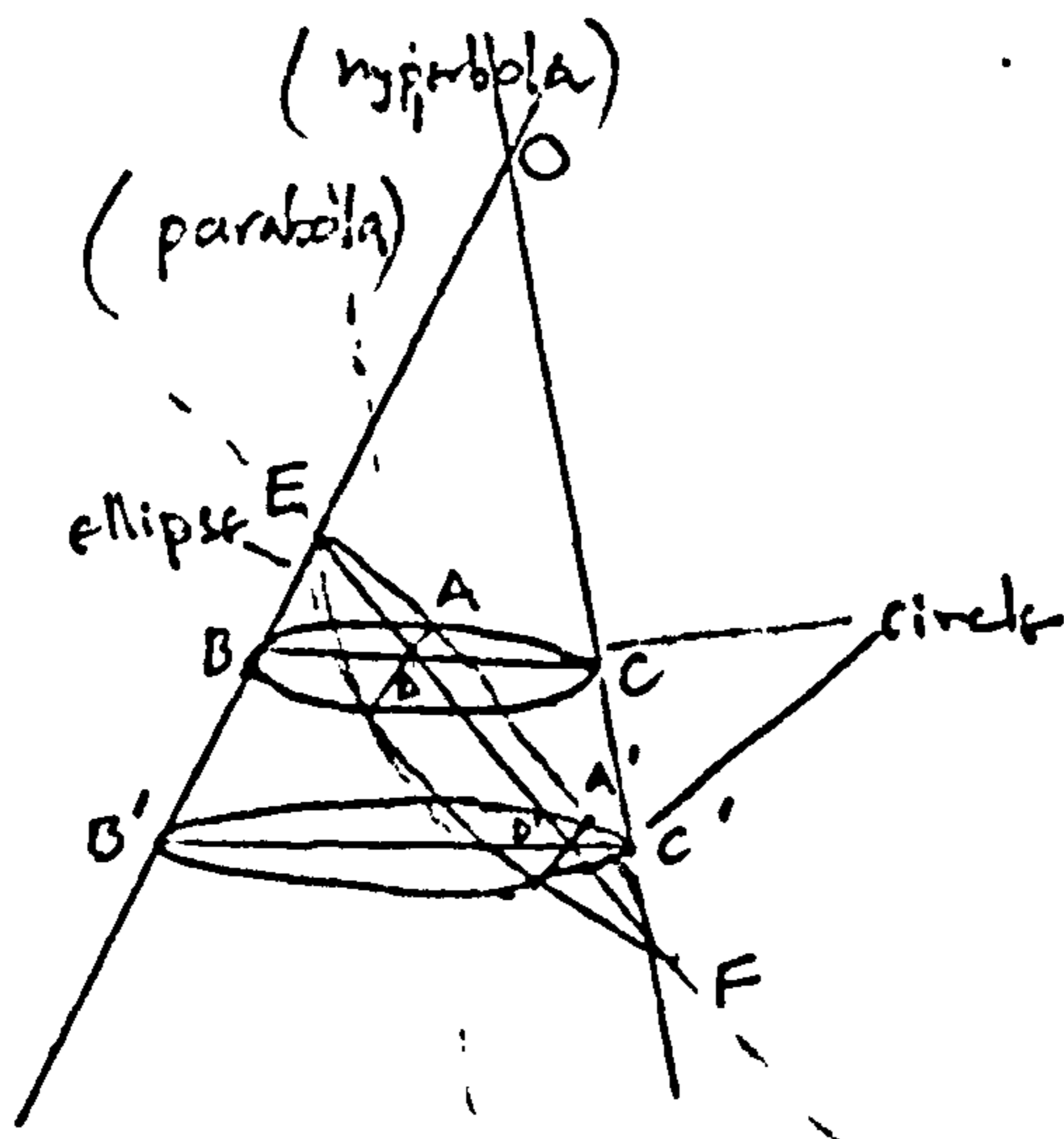

- Since the triangles  $EDB, ED'B'$ , and also  $CDF, C'D'F$  are similar, it should be obvious that the square on  $AD$  (or  $A'D'$ ) is to  $ED \cdot DF$  (or  $ED' \cdot D'F$ ) in a fixed proportion (as  $A$  'moves' along the section) depending only on the vertical angle of the cone,  $BOO'$ , and the angle of incidence of the plane,  $EDB$ . The same argument applies for the 'hyperbola' whose second 'vertex',  $F$ , lies on the cone extended above  $O$ . Where the section is parallel to a side of the cone (parabola) there is no second vertex, and  $DC$  is constant ( $ED$  being parallel to  $OC$ ), so the square on  $AD$  is proportional to  $ED$ .

That is, in Apollonius' language, if  $E, F$  are the 'vertices' of a conic section ( $EF$  an 'axis' or 'diameter'), then the square on the perpendicular from any point  $A$  on the conic to the diameter, cutting it at  $D$ , is in a fixed proportion to the rectangle on the line  $AD$ , with side  $DF$  (where  $F$  is the other vertex of the diameter), if the section be a circle, ellipse or hyperbola, or to

AD if it be a parabola:

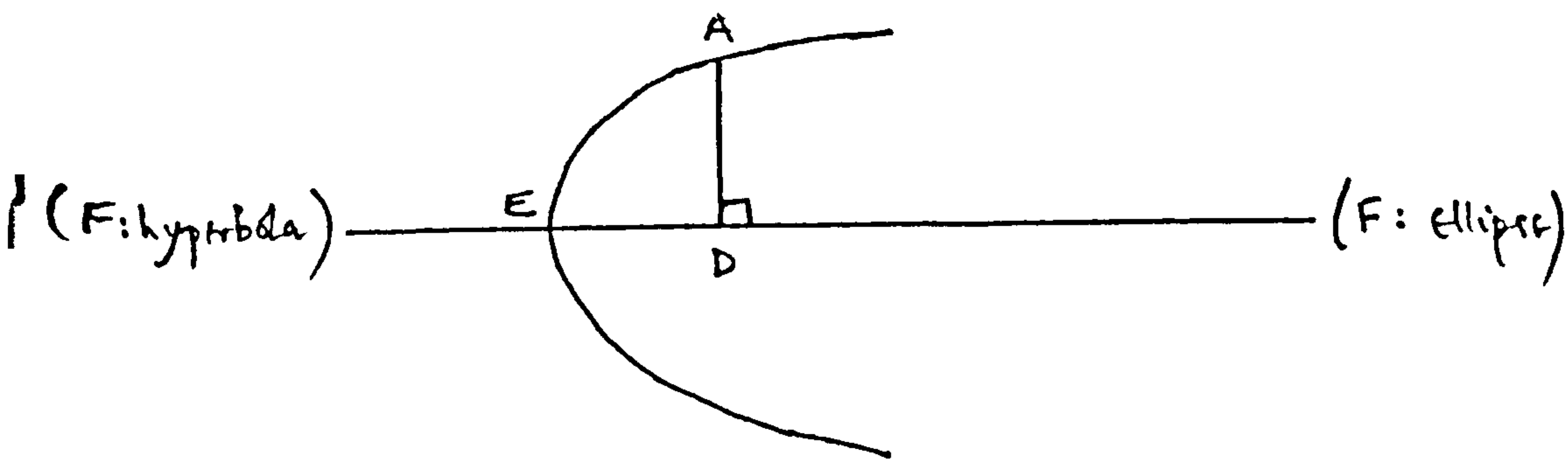

It seems unlikely that Apollonius did in fact fully work out the 'four-line locus', although in propositions 74-6 of the extant third book he gives, in effect, a demonstration of the converse of the three-line locus. The preface to the work as a whole seems to correspond to a projected systematic revision of the initial sketches of eight books already published - Pappus tells us that Apollonius was 'very proud of having expanded' the treatment of the locus, 'though he left the most part of his Conics incomplete' (1). A complete systematic treatment would in effect have amounted to a systematic treatment of curves defined by certain 'parameters' referred to given lines (distances and 'squares' of distances), and the solution of problems involving relations of lines, 'rectangles' and 'squares' by consideration of the intersections of conics representing the loci, sets of points, corresponding to component constraints of the problem.

Now this would involve a systematic abstraction of the consideration of relations between parameters involving general composition-in-square - an abstraction of what would eventually become 'analytic' geometry - from the synthetic geometry of Euclid. Indeed it was from Pappus' discussion of Apollonius' four-line-locus that Descartes, in the first half of the seventeenth century, developed an 'analysis' of loci - specifically conics and their intersections with one another and with lines in a plane - in terms of perpendicular distances of points on a curve (such as a conic, or curve of the 'second order' - involving products and squares of distances) from two fixed (given) perpendicular 'axes' or straight lines, chosen in the plane. In the second half of that century Newton applied this mathematical 'analysis' of a point on a plane 'moving' within certain constraints or parameters to the question of the path or curve traced by a material 'point' moving under the constraint of 'physical' parameters. Although Newton obtained his results by methods embodying the configur-

uration of archimedean exhaustion and apollonian plane analysis in abstraction from the euclidean frame of geometrical Space, he yet presented his results in a strictly 'synthetic' form in his Mathematical Principles of Natural Philosophy. This duality of perspective will be seen to be characteristic of that transition we call the 'scientific revolution'.

Euclid, Archimedes and Apollonius, over the third century, thus present to us a mathematical configuration (the euclidean correlation of point and Space, Archimedes' treatment of intermediate Figure, and Apollonius' projected systematic 'analysis' of plane figure) which reappears in the seventeenth century of our Era to define the mathematical frame of the 'scientific revolution'. The transition from this definitive phase of the 'first alexandrian school' (the mathematics of the third century before our Era) to an equally definitive phase of mathematical theory corresponding to the 'scientific revolution', is itself framed by the developing abstraction of the 'arithmetic' articulation of Measure from its geometrical expression in terms of analysis and synthesis of spatial figure. The emerging dominance of such arithmetical considerations in Antiquity corresponds to the emergence of 'neopythagorean' numerology (the sense of this term will become clearer in the sequel) in Alexandria towards the beginning of our Era. One 'side' of this emerging frame, may be seen in the development of an 'analytic' astronomy from the presentation of its elements by Hipparchus in the century following Euclid, Archimedes and Apollonius, to their systematic integration by Ptolemy in the second century of our Era. 'One side' of the principle of transition, in that the primary circuit of the celestial Sphere, within which the circuits of the stars are 'resolved' into their components of uniform circular motions, 'wheels within wheels', one inscribed within another, amounts to a simple or radical abstraction from empty euclidean Space as limiting frame. The 'arithmetical' symmetries of Number abstracts from that central principle of Figure, intermediate between the two 'sides', limits, of euclidean Space and euclidean point. Corresponding to the 'astronomical' ('sphaeric', as this theory was generally called in Antiquity) abstraction from the limit of empty euclidean



Space, is the 'other side', a corresponding abstraction from point and line to the correlation of length (difference between two points) and 'angle' (difference or distance between two lines) which constitutes the 'trigonometrical' frame of 'harmonics' by which any complex or composite stellar motion may be 'resolved' into uniform components, 'eccentrics' and 'epicycles'. Consider, for example, a typical configuration in the analysis of a planetary motion:

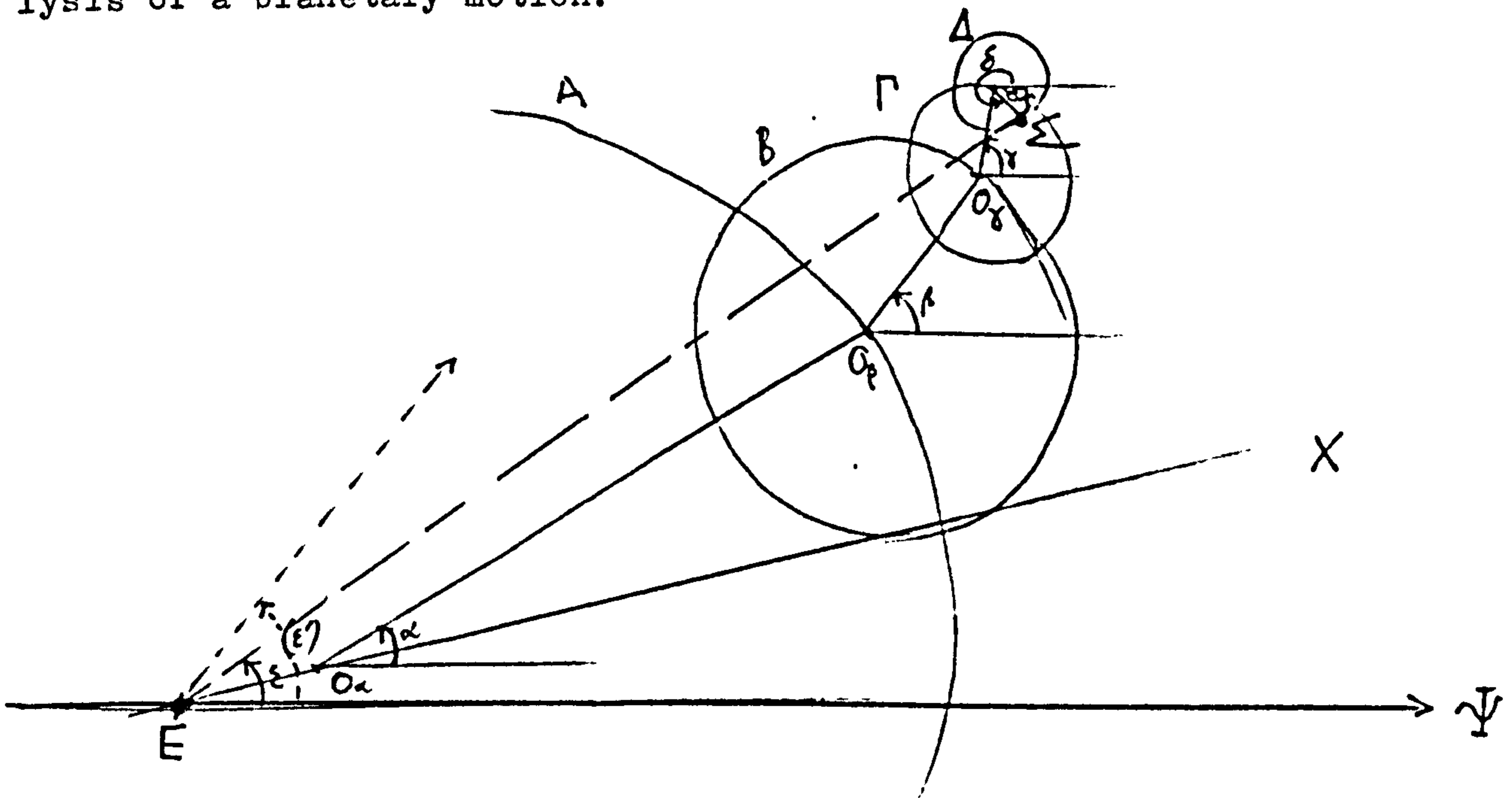

E is the centre of the earth,  $O_\alpha$  the centre of an 'eccentric' circle,  $O_\beta$ ,  $O_\gamma$ ,  $O_\delta$  'centres of three successive 'epicycles', moving uniformly about the centres of the next-lowest epicycle or eccentric. The planet moves in the plane  $\Sigma EX$ . Hipparchus devised various instruments to measure the angle  $\zeta$  between the line joining his observatory and the star, and a fixed direction in the plane of motion ( the orientation of this plane relative to a fixed plane, the celestial equator - or perhaps the plane of the sun's circuit, the 'ecliptic' - being determined by previous measurements. A whole circuit (a great circle of the Sphere of Heaven) he followed the babylonians or 'chaldeans' in dividing into 360 'degrees', each of these being further divided into 60 'minutes' (pars minutiae primae) and those into 60 seconds' (pars minutiae secundae, in the latin). Given the measurement of  $\zeta$  at various successive times,  $\epsilon, \epsilon', \epsilon'', \dots$  and the principles of 'trigonometrical' determination of  $\zeta$  and  $\epsilon_\zeta$  from the components of the figure (eccentricity, radii and angles), the resolution of the planet's circuit into even cycles becomes a simple matter of analysis. The simple principle involved in such analysis is the addition of components of orientation and distance of the star, resolved along two perpendicular directions in the plane of motion:

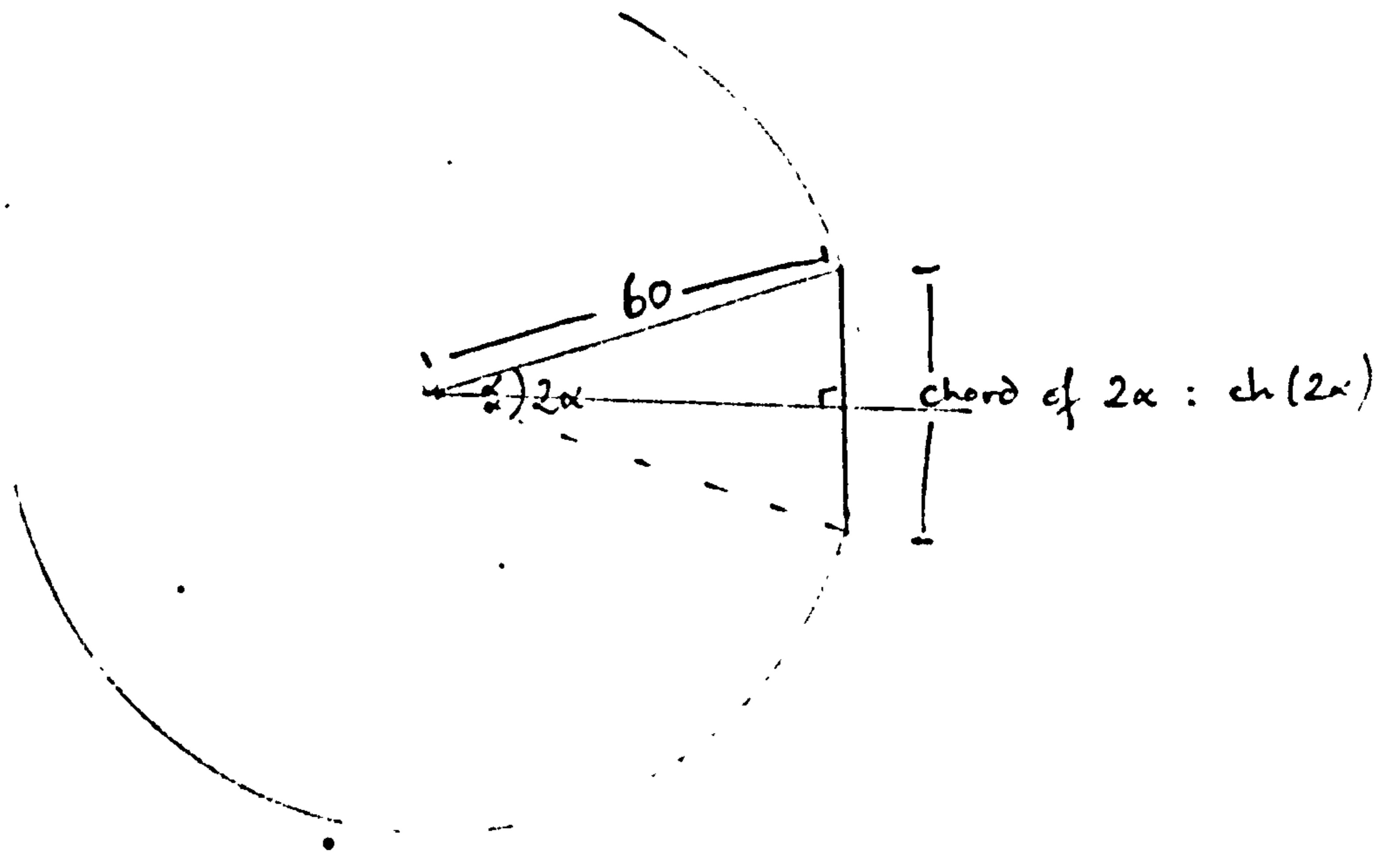
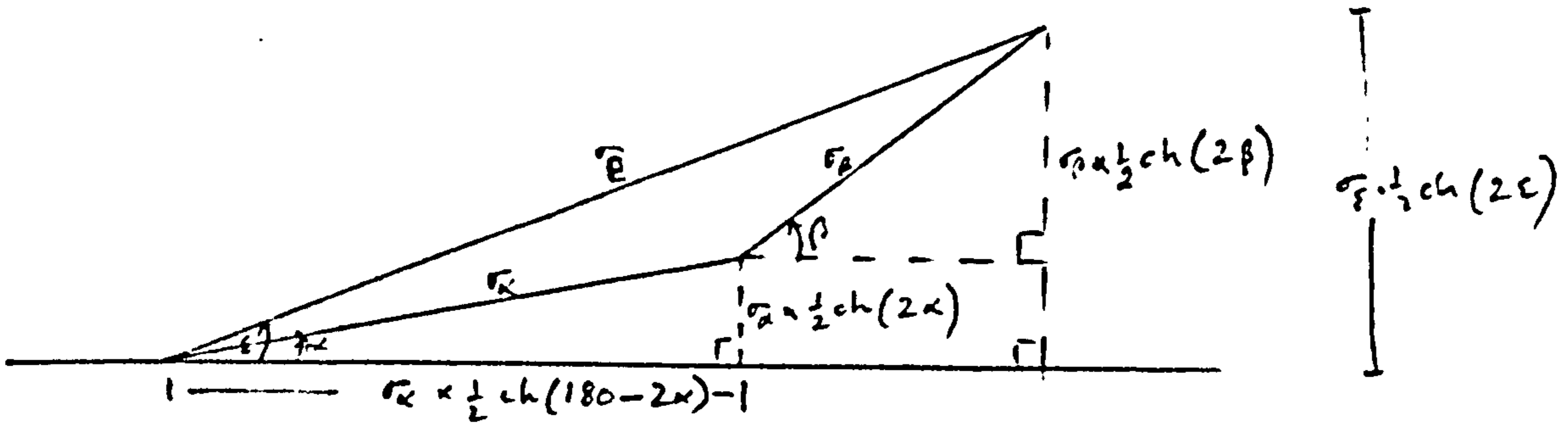

Here  $\sigma_e \cdot \frac{1}{2} \text{ch}(2\epsilon)$  is the sum of  $\sigma_\beta \cdot \frac{1}{2} \text{ch}(2\beta)$  and  $\sigma_\alpha \cdot \frac{1}{2} \text{ch}(2\alpha)$ ;  $\sigma_e \cdot \frac{1}{2} \text{ch}(180-2\epsilon)$  is the sum of  $\sigma_\alpha \cdot \frac{1}{2} \text{ch}(180-2\alpha)$  and  $\sigma_\beta \cdot \frac{1}{2} \text{ch}(180-2\beta)$ . Thus  $\epsilon$  may be found in terms of  $\alpha, \sigma_\alpha, \beta, \sigma_\beta$ . Hipparchus took as 'reference' circle one with diameter divided into 120 parts (radius = 60), and calculated a table of chords to enable him to pursue his analysis in a systematic way. From the symmetry of the equilateral triangle (for example), we see that the 'chord' of 60 'degrees' of the circle is 60 units. Several other basic chords may be derived from other simple considerations. The table is then constructed from formulae for the chords of sums (and differences) of angles, in terms of the chords of those angles. These formulae, in turn, are derived from a simple theorem ('Ptolemy's Theorem', probably due to Hipparchus):

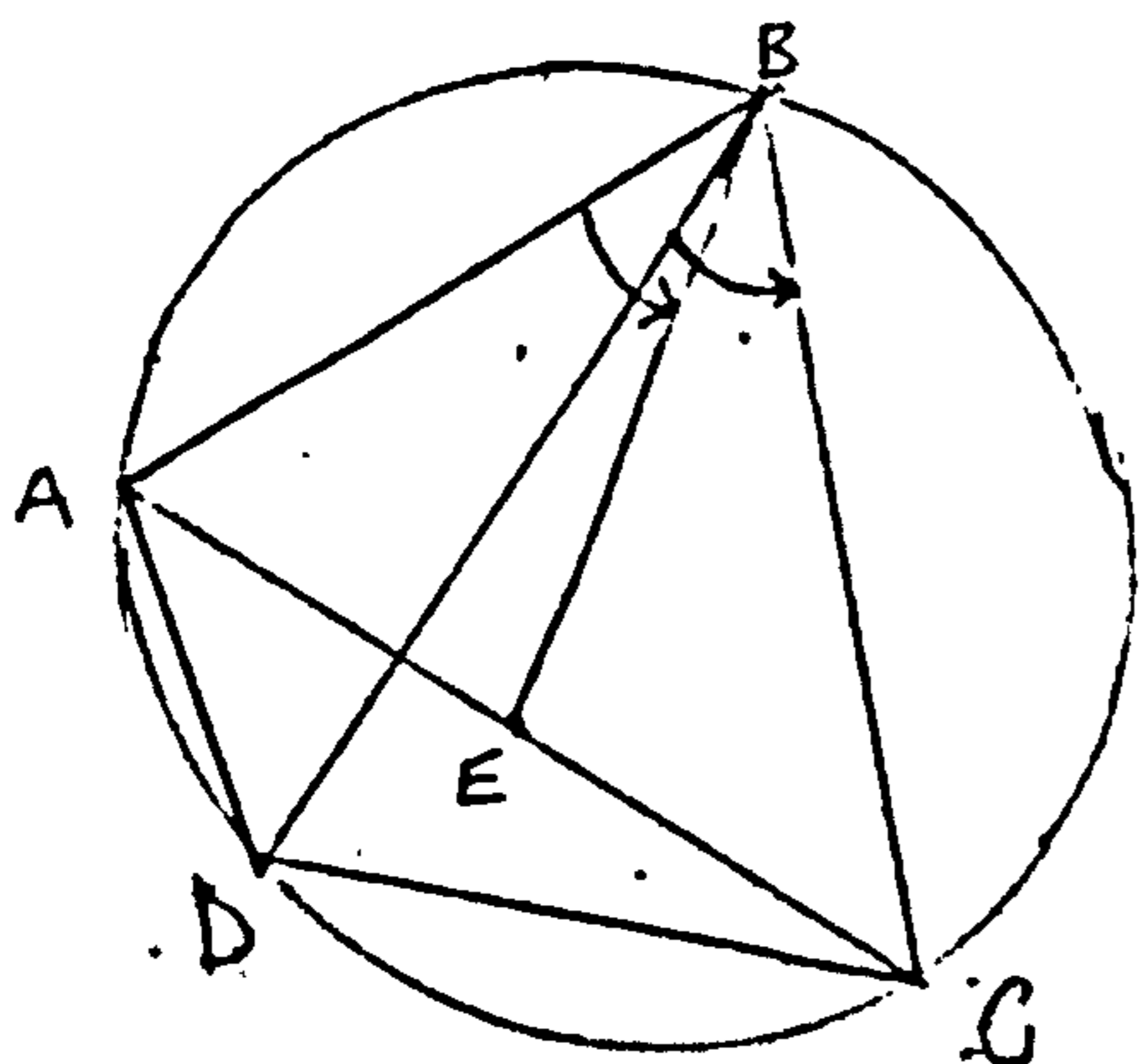

$$AC \cdot BD = AB \cdot DC + BC \cdot AD$$

This simple theorem relates lengths (of chords) and angles (subtending these chords). In effect, chords of sums of angles (eg chord AC is subtended at B by the sum of the angles subtending AD, DC) are expressed in terms of sums of chords. The 'arithmetic' (addition and multiplication) of length and angle are related by this simple formula, in which all further relations of angle and length may be inscribed, just as all mechanical symmetries may be inscribed within the simple symmetry of Archimedes' balance.

It may be illuminating to analyse the articulation of the figure by which the theorem is 'demonstrated'. The demonstration involves two subordinate 'figures' or symmetries of figure:

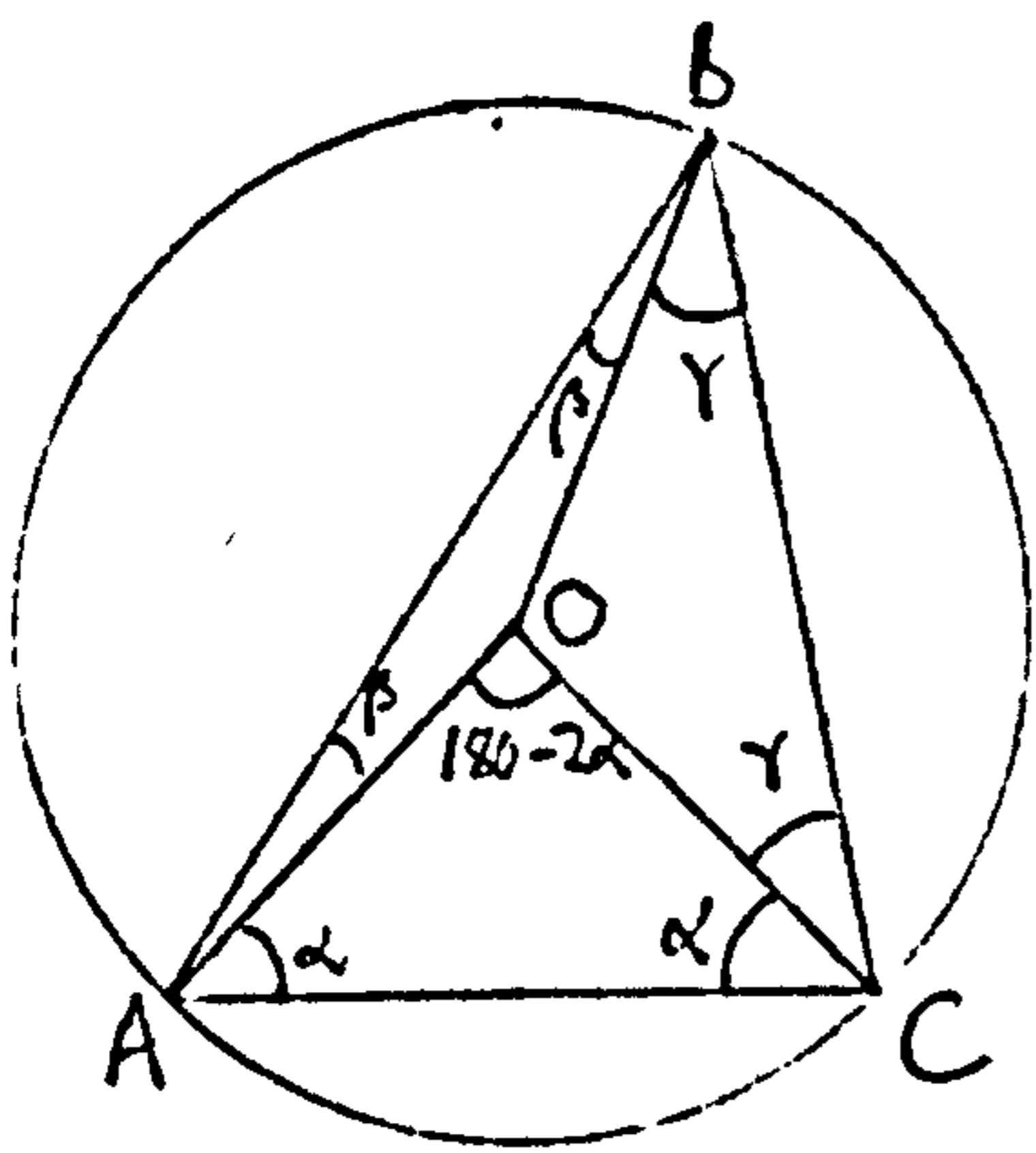

I

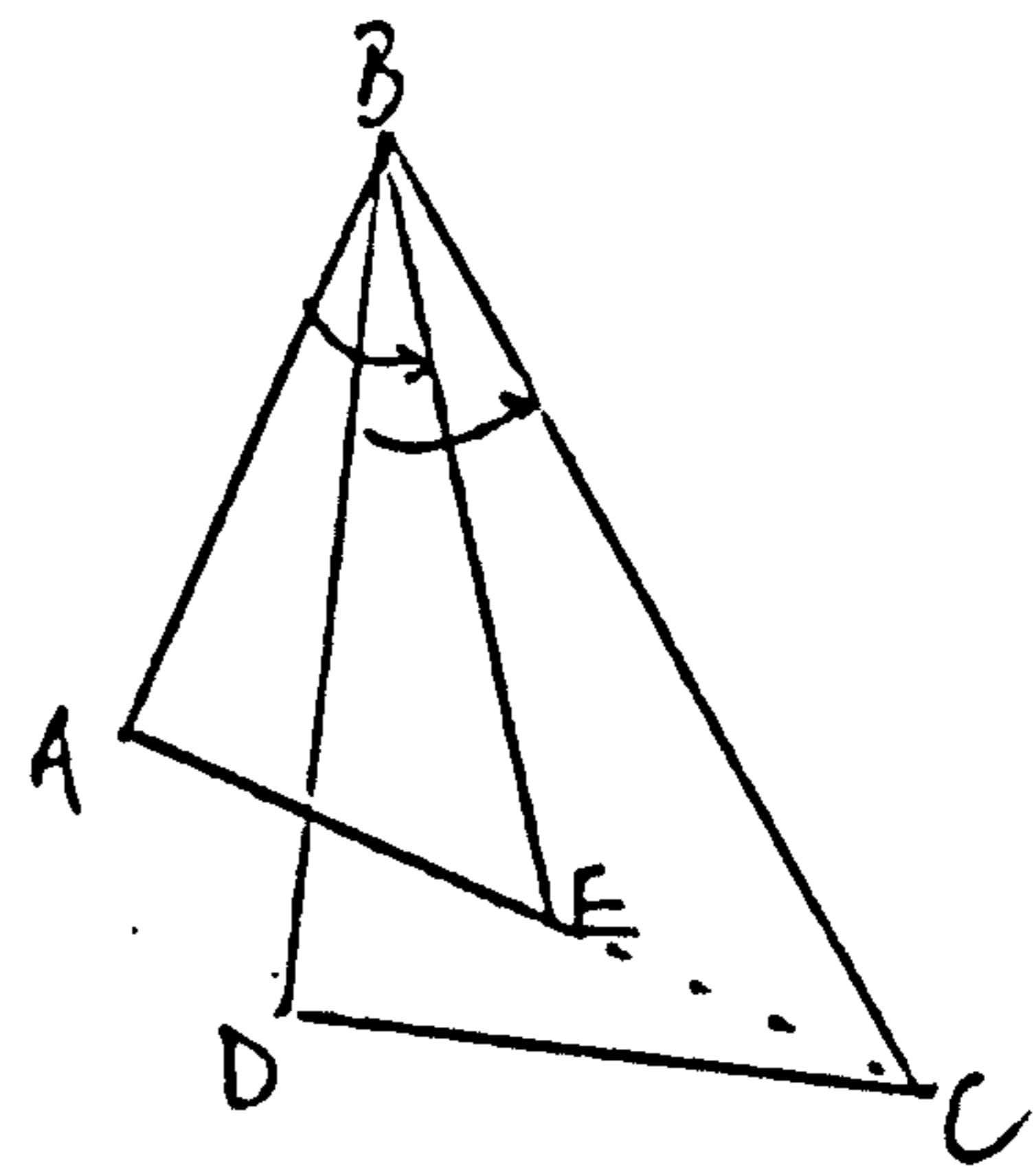

II

I: From the symmetry of the two sides of triangles which are both equal radii of a circle (this is the definition of 'circle', to have equal radii to all points on the circumference - it is the 'locus' of a point in a plane whose distance from a fixed point (centre) is fixed) - eg,  $OB, OC$  - we see that the angle  $ABC$  ( $\beta + \gamma$ ) is half of angle  $AOC$ : for  $AOC = 180 - 2\alpha$ , and  $2\alpha + 2\beta + 2\gamma$  is the sum of the angles in  $AEC$ , and so  $\alpha + (\beta + \gamma) = 90$  and  $(\beta + \gamma) = 90 - \alpha$  or half of  $AOC$ .

II: To prove the theorem the figure  $ABCD$  is complicated by the introduction of another point,  $E$ , such that the angles  $ABE, DBC$  are equal (the 'construction' - along with the line  $BE$ ). Then the triangles  $ABE, DBC$  have their <sup>respective</sup> angles equal, and differ only in scale, so that their respective sides are in a fixed proportion.

Since triangles  $ABD, EBC$  are also 'similar', and  $AC = AE + EC$ , the result quickly follows from a simple analysis of the 'constructed' figure, in which the initial relations 'enunciated' in the theorem have themselves been 'inscribed'.

- For from (I), for example, the angles BAC, BDC, each being half the angle subtended by the chord BC at the centre of the circle, are equal, and so triangles ABE, DBC are similar; similarly, triangles ABD, EBC are similar, and their sides proportionate. The result follows from the correlation of these proportions in the common side BD.

From figure (I), again, the most elementary application of the figure of 'Ptolemy's Theorem' to the resolution of the complex configuration of lengths and angles in a stellar motion may be easily seen:

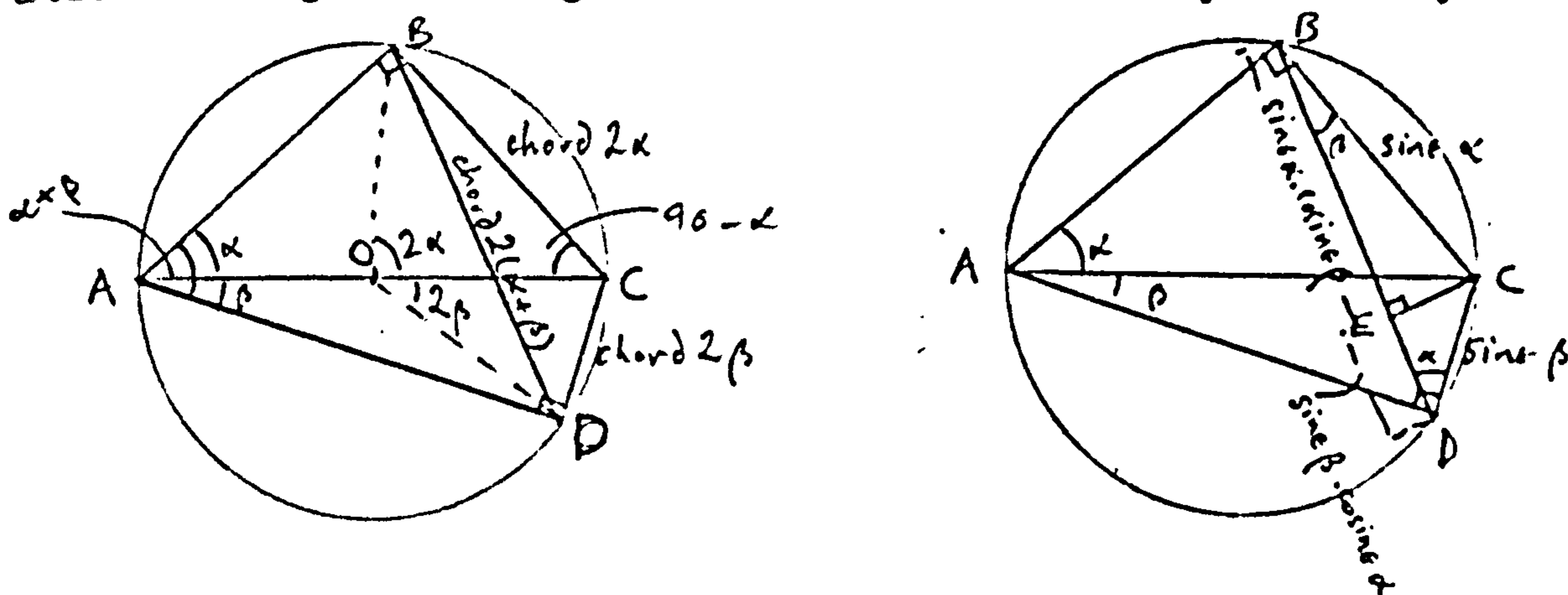

Here, in later terminology, putting 'sine  $\alpha$ ' =  $\frac{1}{2}$ chord  $2\alpha$ , and 'co-sine  $\alpha$ ' = sine  $(90-\alpha)$ , we may see that  $BD.AC = AB.DC + AD.BC$ , or, Taking the diameter AC as a unit length,  $\text{sine}(\alpha+\beta) = \text{sine} \alpha \cdot \text{cosine} \beta + \text{sine} \beta \cdot \text{cosine} \alpha$ . If we repeat the construction made in the demonstration of the theorem, we can see how, in this case, the demonstration amounts to the principle of composition of two orthogonal 'projections', and thus serves as the basis for a 'logic' of projection by which the various components of a stellar motion may be 'projected' onto the unitary frame of the heavenly sphere, there corresponding to the basic observational datum of the 'position' of a star at some 'point' in time - the 'position' for whose determination Hipparchus' instruments were constructed. The complete 'arithmetical' abstraction of the arithmetic of length and angle from from its euclidean representation in terms of point and line, and the relation of this arithmetic to stellar movement in a circuit quite abstracted from a uniform resolution into circles within circles, is a primary aspect of the more general abstraction of mathematical symmetry from geometrical representation (of 'analysis' from euclidean 'synthesis' in terms of point and Space) which frames the 'scientific revolution' of the seventeenth century.

Hipparchus probably studied at Alexandria, and made observations there towards the middle of the second century before our Era. Most of his observation, though, was carried out in Rhodes, whence Panaetius had gone to Rome around this same mid-century, and where his successor as leader of the stoics Posidonius was to teach towards the end of the century, and whence the latter went, around 70, to Rome to join, among others, his erstwhile pupil Cicero. Posidonius died in Rome about the year 51. In the third century, Apollonius of Rhodes, alexandrian librarian under the secon Ptolemy, and predecessor of Eratosthenes in that post, left Alexandria for Rhodes after quarelling with Callimachus over philological principles - this, perhaps, around the time of accession of the third Ptolemy, Euergetes. Rhodes had risen, during the third century, to the dominance of sea-transport in the Mediterranean, maintaining her independence from the various factions quarrelling over Alexander's succession. Like Alexandria, which was becoming, over the same period, the dominant Market of the Mediterranean, Rhodes represents, in an important way, the intercourse of Greece and 'barbarian', non-greek, initiated by Alexander - and most particularly, the meeting of Greek and Syrian culture, before the Mediterranean became more systematically integrated under 'barbarian' roman policy.

Interaction with Syria, and 'chaldeans' in the syrian hinterland, dominates egyptian policy down to the submission of both kingdoms - the Ptolemies and Seleucids (each deriving from one of Alexander's generals) to Rome, towards the middle of the second century. The abatement of the cultural energy of Alexandria under the first three or four Ptolemies over the third century runs parallel to increasing conflict between Egypt and Syria, focussed in the small intervening state of Palestine, whose 'semitic' culture reflects this meeting of egyptian and syrian or egyptian and chaldean, and this over the last few centuries before our Era, just as over about two millenia before. The 'focussing' or convergence of the complex cultural relations of egyptian, chaldean, greek and roman in this jealously independent little state of Palestine defines, traditionally, the beginning of our 'Era'.

Before attempting to mark in the terms of this 'Story' of Reflection, the question posed by, or corresponding to, such 'cultural' convergence of the 'World' of Antiquity, a few more elements must be set in place.

First of all, the component 'cultures'. Towards the middle of the third century Ptolemy Philadelphus had Manetho, the high-priest of Amun-Ra at Helopolis, 'Sun City', the centre of the cult, compile from temple records a systematic presentation of egyptian 'culture', from mythical beginnings, down to the time of the Ptolemies themselves. At about the same time, according to tradition, he obtained from the high-priest of the Jews, in Palestine, a deputation of 72 teachers of the Law of the Jews (six from each of twelve 'tribes' or families into which the jews were divided) to translate into greek the jewish Law, ascribed in jewish legend (preserved in the Law itself) to the Moses who had led the twelve tribes from Egypt to Palestine almost exactly one thousand years before (this date being derived from the correlation of Manetho's records and the jewish Law). At the same time, <sup>in seleucid Syria</sup> Berossus, high priest of Bel at Babylon, was compiling (in greek) a systematic account of 'chaldean' culture, which had so powerfully influenced the jewish culture during the 'babylonian captivity' of the sixth century, and from which, according to the jewish tradition or legends, preserved (from the end of the sixth century on) by the priests of Jerusalem, jewish culture had itself emerged around the time of the fall of the first chaldean culture of Southern Mesopotamia or Sumeria, and the rise of Babylon (at the beginning of the second millenium). Berossus' account, beginning with a systemisation of the astral mythology of the chaldeans dominates what one might call the graeco-syrian axis of Reflection from the third century on. In particular, this configuration is evident in the graeco-syrian (cilician) Aratus, whose poetic rendering of Eudoxus' theory of the heavens within a stoic frame (composed probably at the court of Macedon around the middle of the third century) marks a point of transition from Eudoxus to Hipparchus, whose commentary on this poem is the only extant work of the latter. Furthermore, the second book of Cicero's On the Nature of the Gods, presenting the stoic cosmology, contains extensive quotations from Cicero's own translation of this same poem - an early work, perhaps dating from his study under Posidonius at Rhodes. <sup>The syrian</sup> - Posidonius who himself emphasised the 'chaldean' aspects of stoicism, present from the time of the phoenician Zeno.

These parallel systematisations of 'semitic' (or hamito-semitic) culture, in turn parallel the main activity at the alexandrian Library around the middle of the third century, dominated by Callimachus whom the second Ptolemy had engaged to compile a systematic catalogue of the half-million rolls then in the royal collection. I have already noted the

work of Eratosthenes (librarian from about the middle of the century, after Apollonius of Rhodes) in articulating a universal spatiotemporal frame in which all the material in the library (in particular, the histories of Berossus, Manetho, the 'Seventy', and the Greeks) might be correlated and integrated. Callimachus was engaged in the preliminary work of establishing 'canonical' texts, correlating rolls (including duplicates) of 'books' of the same work, and applying <sup>the</sup> critical principles to the elaboration of 'canons' and to the correction and annotation of texts, developed (largely by him) around this time.

At the same time, and directly complementing this 'applied poetics', Callimachus was establishing an Alexandrian 'canon' for original composition, based upon the systematic integration of the various components of a text within the primary poetic frame of the whole. Traditionally, it was the conflict over this 'canon' with his librarian Apollonius, that determined the departure of this, his erstwhile pupil, to Rhodes. The conflict was, and may be, seen in the two major productions of the rival poets. Each of these deal, like Berossus, Manetho, and the Seventy Jews, with the primary 'mythological' frame in which culture and its history or histories, are inscribed.

Callimachus' Origins ( *Αἴτια* : Aristotle's 'account' or 'cause') dealt with legendary origins - framing - of customs, festivals, names. It was constructed from short poetic 'episodes', each devoted to one subordinate 'reason' or 'origin', and all articulated in an 'analogical' frame of transposition of one into another (a structure borrowed by Ovid in his *Metamorphoses*, towards the beginning of our Era). Also typical of Callimachus are <sup>short</sup> ~~the~~ *ἰαμβοί* or iambic verses, in which the poet stands outside some configuration, in the satirical mode of the Critic.

There is a direct parallel in the *Iambs* with the *Σίλλων* of Timon, and between Callimachus' poetic canon and the 'poetic' or dramatic frame of Arcesilaus' middle way between Stoics and Epicureans. In each case, the 'place' and authority of the poet - 'inside' or 'outside' the poetic frame of <sup>Callimachus'</sup> didactic poem or satire respectively - is integrated 'in' that frame as one symmetrical component, just as Arcesilaus' poetic framing of Actuality involves a primary figure of the 'working' of a frame in which the choice or assertion of that frame is one element.

Yet there is a closer parallel between the 'poetic' frame of the

Middle Academy in mid-third-century Athens, and the 'applied poetics' of mid-third-century Alexandria as a whole - in its whole range. Within this range, Callimachus' central inscription of his own 'authority' within his canon, his inscription of the locus of assertion within the poem or epigram, parallels the stoic inscription within the unitary frame of all-comprehending Reason of the rational choice or assertion of this frame.

Callimachus found Apollonius' poetry too long, and too diffuse. He wrote a long poem on the Voyage of the Argonauts (which traditionally induced the breach with Callimachus) characterised by a dominance of description, scene, in which the author effaces himself (as, perhaps, the epicurean abdicates any self-assertion). Perhaps the strongest of the scenes, telling of Medea's growing infatuation with the argonaut's captain, Jason, might be seen to embody in Medea's emotion the confusion of 'object' and subjective imagination definitive (as we saw in Aristotle's poetics) of the dramatic frame of 'identification' (Euripides' Medea is, after King Oedipus, the dominant example in Aristotle's discussion of Tragedy). - A confusion which itself embodied in the narrative the 'confused' identification of the author or reader with the protagonist (this scene became the model for the love of Dido for Aeneas in Virgil's Aeneid, roughly contemporary with Ovid's Metamorphoses).

To complete the parallel, one might find in the dramatic frame of the syracusan Theocritus' εἰδύλλια, 'images' (a diminutive of εἶδος) an 'alexandrian' analogue of Arcesilaus' ἑποχὴ (Theocritus is 'alexandrian' in much the same sense as his fellow-citizen and contemporary Archimedes). Theocritus does not deal with the wider frames of Callimachus' and Apollonius' poetry, but with everyday scenes. He does not efface himself in description, neither does he frame his 'idylls' within some unitary authority, but rather enters into the dramatic picture or image as one 'person' (the 'first person') among others, in a 'play' of perspective.

Together with the 'applied logic' (or 'mathematics') and the 'applied poetics' of the 'alexandrian schools' of geometry and 'music' in the third century, I have already suggested one might consider the 'alexandrian school' of medicine, whose primary representatives (like



Euclid, Archimedes and Apollonius in geometry, and Callimachus, Apollonius of Rhodes and Theocritus in 'music') belong to the third century, to the first century of activity of Museum and Library, under the first three or four Ptolemies.

Here, as in noting the alexandrian school of 'poetics', I will only briefly suggest how the parallel between developments at Athens and at Alexandria might perhaps be framed.

Here again, we meet with two rival schools (the 'Dogmatics') founded in the first half of the century by Herophilus and Erasistratus, the first men to practice dissection of the human body (Aristotle had dissected only animals), and a reaction against the one-sided dogmatism of both of these in a third school, the 'Empirics' with their 'tripod' or triple base of observation (*ἰμμετρικὰ*), previous history of the subject or patient, and analogy or 'transition from like to like'.

The Dogmatics and the Empirics are concerned with the 'working' of the primary interface of 'inside' and 'outside', the 'body'. Herophilus frames his account, as it were, from the 'inside', Erasistratus (borrowing the atomic theory of Epicurus) from the 'outside'. Herophilus articulates the 'working' of the body in the frame of the 'internal' distinction of 'inside' and 'outside': against Aristotle he maintained that the brain directs this 'working' through the system of nerves (following Alcmaeon of Croton) correlating the 'working' of subordinate organs (of sensation, digestion, motion, and so on). His pathology was 'local' in the sense that a disfunction of the whole was attributed to the disfunction of some part. In particular, the working of the heart, intermediate (as in Plato) between brain and liver (a sort of mirror, as Timaeus puts it) he monitored in the pulse, the ebb and flow in arteries and veins, a sanguinary system (as it were) parallel to the directing nervous system centred in the brain. Disfunction of the blood-system he treated by venesection, other disfunctions he treated with counteracting drugs.

Erasistratus, Aristotle's grandson, on the other hand, might be said to inscribe the body, as interface of 'inside' and 'outside', in outside Nature - thus, like Epicurus he inscribed the workings of the various subordinate systems in the body within the primary function of digestion or assimilation. Whereas Aristotle makes the heart the primary organ, then, Herophilus substitutes the 'higher' function of the brain and nervous

system, Erasistratus the 'lower' function of stomach, liver and digestive system'. Each of these two Dogmatics proposes to systematically inscribe the working of various component 'systems' or 'functions' which together make up the body, within a primary frame of distinction of 'inside' and 'outside' - within a primary 'identification' of the subject or patient, a primary working or 'actuality' of the whole. - This, as it were, from their two different 'sides' or perspectives. Thus erasistratean pathology is inscribed or articulated within the primary disorder of excess nutrition or assimilation, whereas Herophilus sees the disorder of the whole as rooted in the disfunction of some particular subordinate system - a 'local' pathology or disorder, induced by a 'local' cause, and throwing out the integrated working or activity of the whole, exciting 'symptomatic' disfunctions in related systems or parts.

In the face of such contradictory dogmatic generalisation, the Empirics (paralleling in this the move of Arcesilaus faced with the contradictory dogmas of stoics and epicureans in Athens) base their approach on the framing of pathology or disfunction, incorporating the interaction of 'external' and 'internal' factors. From this 'middle' point of view, Dogmatism presents two limits or extremes of such 'framing' of pathology, each equally and wrongly abstracted from the primary actuality of medical Practice - from the 'working', in practice, of the dramatic figure of the part in practice of the 'framing' of a case, in its particular circumstances.

There is a parallel, after the third century, between the progress of Medecine and Mathematics. Towards the beginning of our Era, Mathematics begins to be dominated by the elementary articulation of 'arithmetic' relations of figure, abstracted from the systematic geometrical presentation of the third century (the latter based upon the 'euclidean' coincidence of logical and physical 'sides' of Figure in the correlation of point and Space). In Medecine there arises a new school of 'Methodics', breaking with the alexandrian systems of the third century and their complex pathology of function and disfunction inscribed in the elementary interface of 'psychical' and 'physical' sides of the body. Asclepiades, giving up rhetoric for medecine, and moving to Rome, introduces a simple scheme of interaction of these two 'sides' (based upon the constriction or relaxation of 'pores' in the body). The elder Pliny, in

the third chapter of the twenty-sixth book of his Natural History (written a century after Asclepiades' arrival in Rome with his 'Method') describes the great and precipitous success of the new school, with its incorporation of Medecine within the simple frame of Activity, according to the figure of the 'pores'. Anyone could understand the Method, and see the simple sense of the exercises and bathing enjoined by Asclepiades and his disciple Themison. Pliny makes Asclepiades in large part responsible for the introduction to Rome and Italy about this time of the public baths that were to quickly become such a prominent feature of roman life.

The parallel extends to an analogy between Ptolemy's systematic integration of Astronomy and Geography ('Sphaeric') in the second century of our Era (based on the alexandrian mathematics of the third century, framed in Hipparchus' scheme of the second), and Galen's systematic integration of alexandrian medecine about the same time - this within the scheme of a highly stoical platonism developed from its beginnings in Panaetius (through Posidonius and the alexandrian configuration of Reflection around the beginning of our Era, to which we are now almost ready to turn). I will indicate the part of this analogy in the transition from the configuration of Reflection at the beginning of this our Era, to that of its third century when I have considered the initial configuration of this 'Era'. (And will then try to bring out figures of transition from that third century to the close of classical Antiquity between the fifth and sixth centuries, then from this close to the opening of a 'middle phase' of Reflection - as here 'framed' - in the thirteenth).

Nearly all the 'elements' of the 'initial configuration of our 'Era' ', as framed here, are now in place. It remains only to complete the figure of transition from the pythagoreans of Croton to this 'initial configuration', by relating the subordinate transitions from pythagoreans to fourth-century Athens and third-century Alexandria or Athens to the transitions from these intermediate configurations of Reflection and Context to the roman dominance in the Mediterranean established in the second, and consolidated at the beginning of the first century of our Era, under Augustus.

In the delineation of the Context of Reflection (insofar as it mirrors as 'outside' the 'text' or texts of Theory, within the general

figure of complementarity of 'logical' and 'physical' (or 'internal' and 'external' ) orders of Reflection, identified in the initial pythagorean 'point' of this account), a few details remain, relating to the transition, in the East, from Alexander's successors to a universal roman Imperium under Augustus.

A decline in original activity at the alexandrian Museum and library towards the end of the third century - under the fourth and fifth Ptolemies - parallels, as I have already noted, a decline in egyptian dominance of relations with Syria, and this, most particularly in Palestine, where the kingdoms meet. Alexander had settled large numbers of jews at Alexandria: they were to form a third part of the population of his model city, along with a third part of greeks, and a third of egyptians. The first Ptolemy, annexing Palestine in 301, carried off another hundred thousand Jews, and from this point they formed, with greeks and egyptians, a parallel strand in the egyptian state, with their own institutions, becoming more or less independent of the central authority of Jerusalem - this, more markedly when, around the close of the third century, Antiochus III (the Great) of Syria recovered Palestine from Egypt. By 169 his son Antiochus 'Epiphanes' (or Epimanes: the Madman) was in Egypt itself, but was forced to withdraw the following year by the romans, whose sovereignty over the three great hellenistic kindoms of Macedon, Syria and Egypt was acknowledged that same year. Henceforward Egypt became the primary source of roman corn, and, under roman protection and safe from external aggression, expended much energy in the family conflicts of the Ptolemies.

Over the period 168-146 (from the initial defeat of Macedon and establishment of guardianship in Syria and Egypt down to the destruction of Carthage and Corinth in the latter year) Antiochus 'the Madman' had attempted to integrate jewish culture with graeco-syrian, and caused a jewish revolt, concluded by the establishment of an independent jewish state ruled by a high court or Council ('Sanhedrin') of seventy wise men plus a judge (usually the high priest) elected from the members of the council - the priestly aristocracy established by the leaders of the revolt ('Sadducees'), 'elders' of the community, and 'Doctors of the Law' - generally Perushim, 'separated' initiates of the various degrees of 'pharisaic' purity. The Sanhedrin was established under roman protection in 145, and the jewish state retained its independence until the beginning of our Era, when it was incorporated in the roman prvince of Syria, which had lost its independence in 63. Babylon and the eastern

parts of the seleucid kingdom had been lost to the parthians (who had begun to establish a 'magian' or zoroastrian state in the eastern part of Alexander's legacy in the third century) around the middle of the second century.

The final incorporation of Syria and Egypt as roman provinces (with roman government) dates from their involvement in the 'internal' conflicts of the various contending parties who have already been noted in the transition from the conflict of oligarchy and democracy in the first half of the first century, to Augustus' success against Anthony and Cleopatra (who were in effect founding an eastern empire) which concluded in the extinction of the Ptolemies in 30. Egypt, unlike other provinces, became the direct property of the 'Emperor', ruled by his appointed prefect (of the middle or knightly order), rather than by the senate - for Egypt had become the key to the economy of the Empire. Nobody of senatorial rank might even visit the country without express permission from the Emperor, for fear of conspiracy, of the economy falling into the hands of some faction.

What, though, does all this 'outward' activity have to do with Reflection? Surely, for example, Carneades' embassy to Rome in 156 - between the defeat of Macedon at Pydna in 168 and the destruction of Carthage and defeat of the Achaean League of greek states in 146 (after which Greece became a roman province) involves so many factors that we cannot hope to, as it were, resolve it into 'components' - of which one might be the reflection of cultural relations between Athens and Rome in the 'political' configuration of an embassy? Or rather: we may find in such an 'action' so many aspects or 'components' - how can we 'abstract' a simple configuration of a meeting of greek and roman 'culture' in the 'scene' of Carneades lecturing to the young men of Rome? How can we presume to abstract any finite or definite system of relations from an action, a 'historical' action, rooted, unlike, say, the closed frame of a book, in an unanalysable network of relations? Is that not simply to confuse the 'closed' frame of a fiction with the open range of aspects and accounts of a given historical 'action'?

...Is it not this Carneades himself - who wrote nothing - who seems (from the record of his successor Clitomachus) to have argued so forcibly against such a confusion? He would not, it seems, go so far as to abstract any 'account' from the particular circumstances of its utterance. How then can we - I - presume to fix the part of this same Carneades in a scheme of Reflection itself!

- How can I presume to inscribe the difference, say, of Carneades' visit to Rome, and Panaetius long stay there with Scipio, in some sort of stoic scheme of the unfolding of Reason, Λόγος ... of a 'logical' order in the outward physical order of Greece and Rome in the second century?

Perhaps we might get a little nearer a resolution of this 'incommensurability' of the finite frame of an account, and the unlimited complexity of 'historical fact', if we consider what becomes of the opposition of a 'carneadean' view and a 'panaetian' view (the latter containing as one element this opposition of views..) towards the beginning of 'our Era' (an arbitrary frame of accounting indeed, it seems: a conventional marking of some nominal reference point in uniform symmetric Time).

As we began to see a while ago, Cicero presents us with a sort of integration of the views of Carneades and Panaetius. Indeed, although he is avowedly an 'academic', not wishing to fall into any 'fiction' in which the assertion of the fiction, its certainty, is somehow one element of the fiction - yet his moral treatise, On Offices ('parts', 'duties') is, from the very title on, <sup>directly</sup> derived from the views of Panaetius. Only the presentation is Cicero's - just as it is only the 'presentation' to Rome of epicurean views that is Lucretius'..

...Yet.. 'we are not merely translators, but contribute our own judgement in deciding what to select, and how to present it'(1)

.. Cicero frames the argument.. Cicero the lawyer..

He is almost a stoic.. and yet, in a way, he is a more radical 'academic' than Carneades. For the very 'part' of academic questioning, 'open-ness', ἀνοιχτή, itself comes into question, in the framing of action. Balbus in the dialogue has at the end complained: It seems

1: On Offices, <sup>1.1.16</sup> I 16

to me that the stoic account of Providence 'itself bears the mark of Providence' - and Cicero concludes: 'It seemed to me that the reasoning of Balbus brought us nearer to an image of the truth' than did the criticism of the academic Cotta. - As though the rightness, the 'moral' truth (the word, like so many others in our 'philosophical' vocabulary, is due to Cicero) of an action might be somehow more radical than a negative 'critical' ability to as it were stand 'outside' the inevitable abstraction of any account from the irreducible question posed by its very 'abstraction'. An 'abstraction' that corresponds to the 'moral' actuality of stoicism, framed in the 'circular' assertion of the part of Reason, Λόγος, in the assertion of the part of Reason in things.

That is: in Carneades' terms, might it not be morally 'right' to assert the place of 'rational' assertion in the scheme of things? Might it not 'work' better to assert this Reason in things, rather than not - even though we know that the circular assertion of the part of such Reason in our inscription of that assertion in the frame of Reason cannot be abstracted in some 'logically' closed scheme?

- That is not to face the symmetry of Panaetius' assertion and Carneades' criticism, and see this as the critical base for a definitive judgement in favour of a 'rational' framing of Kosmos. - Philo of Larissa, who had succeeded Clitomachus as head of the Academy, had, in effect, posed just this question of moral certainty. Cicero had studied, at Athens, under both Philo and his successor Antiochus, and definitely rejected (along with many 'academics') the identification by Antiochus of this 'question' at the root of the framing of Kosmos. Antiochus extended the carneadean principle of the 'working' of a certain framing of action to the Kosmos as frame of all such 'working', and so combined stoic Reason and aristotelian Actuality within a 'critical' frame of what he called the 'Old Academy', marking a break with the 'New' Academy of Carneades, and a return to the cosmological frame of the Timaeus (which Cicero translated into latin).

The difference between the perspectives of Cicero and Antiochus (they might perhaps be regarded almost as the roman and athenian 'successors' of Philo respectively) will provide another example of the kind of correlation of 'figures' (or figurations, or configurations) of text and context that is now in question. - Cicero's frame of action -

including the activity of writing - is the Court of Law, its drama of 'accounting' for action, framed in the finality of Judgement:

Nos autem nec subito coepimus philosophari nec mediocrem a primo tempore aetatis in eo studio operam curamque consumpsimus et cum minime videbamur, tum maxime philosophabamur, quod et orationes declarent refertae philosophorum sententiis et doctissimorum hominum familiaritates quibus semper domus nostra floruit, et principes ille Diodotus, Philo, Antiochus, Posidonius a quibus instituti sumus. Et si omnia philosophiae praecepta referuntur ad vitam, arbitramur nos et publicis et privatis in rebus ea praestitisse quae ratio et doctrina praescripserit. (1)

I have not suddenly begun to philosophise, nor have my effort and interest spent from an early age in that study been but average; and just when least seeming to, I most philosophised, as is shown both by speeches full of views of philosophers, and by the association with the learned men always seen about my house, and those leading philosophers Diodotus, Philo, Antiochus, and Posidonius by whom I was educated. And if the precepts of philosophy relate in the end to our lives, I judge that both in public and private matters I have acted as my reason and doctrine prescribed.

..multa esse probabilia, quae quamquam non perciperentur, tamen, quia visum quemdam haberent insignem et inlustrem iis sapientis vita regeretur.

Sed iam, ut omni me invidia liberem, ponam in medio sententias philosophorum de natura deorum. Quo quidem loco convocandi omnes videntur qui quae sit earum vera iudicent..(2)

there are many probabilities which, although they cannot be certainly known; may yet appear so clear and distinct that the life of a wise man may be directed by them.

But now, to free myself of all presumption, I shall first set out the views of philosophers on the nature of gods. At this point indeed all seem called to join in judging which of these views is true..

..ut adsint cognoscant animadvertant, quid de religione pietate sanctitate caeremoniis fide iure iurando, quid de templis delubris



sacrificiisque sollemnibus, quid de ipsiis auspiciis quibus nos praesumus existimandum sit..(1)

..let them come into court, weigh up the evidence, and return their verdict as to what we are to say of religion, piety, sanctity, ritual, faith, taking oaths, what of temples, shrines, solemn sacrifices, what of the very auspices over which I myself preside..

Cum multae res in philosophia nequaquam satis adhuc explicatae sint, tum perdifficilis..et perobscura quaestio est de natura deorum, quae et ad cognitionem animi pulcherrima est et ad moderandam religionem necessaria. (2)

There are many questions in philosophy that have so far not been adequately explained; but the question of the nature of gods is the most thoroughly difficult and obscure of all, and both bids fairest to give a knowledge of our own mind, and is essential to the organising of religion.

..quod vero maxime rem causamque continet, utrum nihil agant, nihil moliantur, omni curatione et administratione rerum vacent, an contra ab iis et a principio omnia facta et constituta sint et ad infinitum tempus regantur atque moveantur.. (3)

..indeed the whole matter and the whole case comes just to whether they effect nothing, intervene in nothing, above all concern in and direction of things; or whether on the contrary everything is by them formed and organised from the start, and governed and worked through all time..

..haud scio an pietate adversus deos sublata fides etiam et societas generis humani et una excellentissima virtus iustitia tollatur. (4)

..I hardly know whether, if dutiful conduct towards the gods were taken away, good faith, the alliance of the human kind, and justice, the single most eminent virtue, would go with it.

1: I.vi,14

2: I.i,1

3: I.i,2

4: I.ii,3

Antiochus' frame of writing (on the other hand) is the School; an instruction, a 'theory', which reflects Kosmos in the intermediate frame of social interaction. - In a frame of a societas generis humani, a 'society', a human 'World', which this theory in turn inscribes theoretically in its Kosmos.

How far may one call these two frames of writing and reflection 'roman' and 'greek'? Surely it is no mere chance that Cicero's reflection is that of a roman lawyer, and Antiochus' that of an athenian philosopher? And surely these two 'sides', roman and athenian, of the marriage of Stoa and Academy, may also be found embodied in the persons and reflections of Panaetius and Carneades in the second century, and down through the development of that dual reflection to Cicero and Antiochus. Might one not then 'inscribe' this figure of duality, this 'two-sidedness' of reflection in Greece and Rome, this more or less systematic difference of perspective, in a wider figure of mediterranean Culture - in which are inscribed also the 'political' interaction of Greece and Rome which brought Carneades to Rome, the 'economy' of mediterranean activity, in which roman policy had been so successful in its constant frame of Law and the Assembly, its roman World as frame of activity, indeed of actuality?

Can we not, as it were in Carneades' terms, see roman Law and greek Theory, say, as two 'frames' of activity, of self-assertion, in a primary dramatic frame of their interaction with one another, and with so many other figures and corresponding 'forces' in a 'graeco-roman' World. A 'World' indeed which as primary figure, frame, must itself be 'in question', in a radical way questionable, since the roman and greek perspectives embodied in the reflection of Cicero and Antiochus do not, so to speak 'agree to differ': each frames their interaction from its own 'side', and they do not 'agree' upon any higher jurisdiction which might decide the matter, upon a shared frame in which the two perspectives might be inscribed as different 'points' of view in some unitary Space and Time of Activity and its Actuality simply (somehow) 'as such'.

This figure of the 'World' as general Frame of activity, of interaction of different principles of framing activity, different 'cultures', 'worlds', may yet be seen to correspond to a common figure,

an analogy, between the 'roman' perspective of Cicero, and the 'athenian' perspective of Antiochus. - In its simplest form, this figure is already implicit in Carneades' figure of Action (or Activity or Actuality, the 'working' of a given - or rather, chosen - frame). We know ourselves in the 'figure' of choice as 'self-activity'. And this is simply one instance of a figure of Actuality as what - to some extent - 'works' in the framing of Action. That is: the figure of 'framing' action itself 'works', has a certain actuality, although we cannot stoically abstract it to some closed circuit in which it immediately knows itself 'at work' in knowing itself (as Reason).

Now in Cicero this same figure finds what is, in a way, a more radical application. We have a choice between fixing a frame of choice (although this is in some sense, as Carneades showed in his roman lectures, 'arbitrary', uncertain, not 'true' in the strictest sense) or not. And we find that in, as it were 'provisionally', deciding to make decisions in a certain way, we are involved in a 'moral' actuality more radical than 'theoretical' truth. Balbus, although he is 'wrong', as Cotta shows, is yet in a way right to be thus theoretically wrong. He makes the mistake of taking the working of moral actuality, of 'Providence', in a particular figure, as the truth, as a definition of Providence. Cotta shows that the definitive truth cannot lie in such 'stories'. And yet the figure of Providence, of the organisation of Actuality 'like' a story, with action inscribed within action, within the Action or Drama of the whole is indeed at work at a more radical level than the figure of exact definition. It is in some way right at some point to act according to a mere 'story', rather than refuse to choose because one hasn't adequate grounds for a definitive choice. In particular, moral actuality, Justice, itself corresponds to a general decision to frame deliberation in a fixed frame, chosen at the outset: it involves a kind of 'providing' for deliberation, bringing the possibility of deciding now about how a future decision will be made into question: and the 'working' of this choice is simply the actuality of Law, the establishment, as it were, of a 'court', deciding how to decide, in general, how to frame decision, simply as such. 'A wise man may well adopt (this) as a rule of life'.

Yet Cicero does not try to give any definitive account of the place of such 'moral actuality', such responsibility or accountability, in a wider frame of Kosmos. The choice of deliberation is a more radical framing: it is up to everyone to understand this choice for them-

selves. The place of deliberation in Kosmos is itself a matter for deliberation, not a matter to be resolved by the head of some School, then to be posed as the question of whether or not one assents to the cosmic scheme of that school rather than another: for how then is one to decide between the dissenting Schools?

- There is, then, a moral actuality of framing action within rules of deliberation, within Law - and this is the primary frame of deliberation and activity, in which reflection is one element, one side. Cicero's 'philosophy' is but one side - as he himself insists - of his activity over his whole life - of his asserting, within the frame of roman Law, the primacy of that frame - of his self-assertion in Law, as the leading advocate of Law and the republican Constitution. This step itself, 'into' the Law (after his early studies under Philo (then in Rome as a refugee from Athens in the parthian war), Phaedrus the epicurean and Diodotus the stoic), frames his activity - and part of that activity is the theoretically 'open' question of this step, of the 'closure' of this deliberative frame which Cicero has decided to enter. But this essentially 'open' question of the place of such choice, such a frame of choice, in its widest context (whatever that may be asserted to be) is itself determined, 'morally', 'in practice', as simply one side of deliberation itself. There is no way to 'theoretically' decide the question posed by the moral actuality of choice, by inscribing it (like Antiochus in Athens) within some last 'theoretical' symmetry of the two sides of the question. The figure of Actuality presented by this question of Choice is in a way the same in Rome and in Athens, and amounts, in a way, to the 'actuality' of the difference of perspectives, 'practical' and 'theoretical'; but as in the case of the similar 'symmetry' of stoic and epicurean assertions around the beginning of the third century, the common 'dramatic' frame of roman and greek reflection only appears later.

One element of this common 'dramatic' frame is, as I have now, I think, suggested in various ways, is the cultural configuration of the augustan integration of the 'World'. One last component in the 'Reflection' that amounts to one 'side' of that World remains - it derives from another of Cicero's teachers, Posidonius, who was born at Apamea in Syria, studied under Panaetius, and taught at Rhodes - when he was not travelling about the World. Hipparchus who must have died <sup>about the time</sup> Posidonius left Syria had, as we saw, set out at Rhodes the mathematical frame of the heavens. He had also, in his work on the trigonometry of the sphere,

applied his theory to the navigational requirements of the rhodian merchant fleet, which dominated mediterranean sea-trade (as Alexandria dominated the markets of East and West, through this trade). Within this abstract frame, Posidonius sought to effect a grand stoic synthesis - to articulate the whole World within this frame of Heaven and Earth as a great Story, a 'natural history', the Story of Nature. In a way, this amounts to a position which combines Cicero's moral or practical self-assertion in the frame of Law, with the cosmic scheme of the Timaeus re-introduced by Antiochus: Posidonius presents us with a 'graeco-syrian' version or interpretation (as it were) of the same simple figure of the Frame of Action and Actuality. The World is dramatised: moral actuality turns upon the figure of Choice, of self-assertion by which divine Reason, Λόγος, distinguishes itself in Nature from the underlying Economy of Necessity. The 'syrian' element is perhaps most strongly marked in the dual 'economy' of this posidonian Kosmos: the frame of Necessity, Matter, is as it were 'doubled' by a 'supernatural' economy, and the two meet in our choice, in our moral activity. The frame of divine Reason doubles mechanical Matter, and operates through our entry into, and participation in it, through choice, moral self-assertion. The drama extends from one limit of Kosmos - the all-comprehending outer Sphere of God, the Creator, through subordinate stellar circuits where the divine Actuality of Choice is mixed to a greater and greater degree with dark Matter, down to these our earthly bodies. Yet we can (it seems) enter into the framing of Actuality in these nested stellar circuits, by framing our own activity in the supernatural economy of choice or Freedom whose circular figures of inscription of assertion in the frame it asserts, correspond to the astral cycles of the stars. In particular, we may rise, by such activity, into 'higher' circuits or actualities, at death, when a spirit that as it were grows by moral activity distinguishes itself from the earthly matter in which this activity has, over a life, been framed. From its new stellar circuit it may then take part in the 'framing' of what happens in lower circuits, and so rise further to higher and purer spheres of self-activity, until at last it reaches the 'comprehensive' sphere of the fixed stars and the divinity which knows itself as divinity. Posidonius' part in the scheme, then, lies as it were at the centre - in framing the scheme itself, <sup>rather</sup> like Empedocles before him.

Here, at last, is where we come in. For one more step - to the beginning of our Era - presents us, in the very object of our inquiry, with that figure of the 'framing' of an Action with which we were confronted by Carneades. What grounds, we wondered (I wondered, at least, I hope you did too) might be asserted for fixing Carneades' 'position' in a schematic 'story' or configuration of text and context, of two 'sides' of the action of framing in words an action? We moved from this question (reflected, as it were, in Carneades' abdication of writing, of written assertion, abstracted from its particular situation) to a succeeding configuration, about a century later (around the middle of the first century) in which we found the lawyer Cicero asserting the moral force of choosing a frame of choice and action. At Rhodes, Posidonius was elaborating, towards the middle of the century, a sort of cosmic drama of 'framing' Actuality, and at Athens the Academy was split between those who assented to Antiochus' theoretical step into a closed Kosmos as primary frame of question and inscription or reflection, and those who remained 'critically' outside such a circular assertion of primary circularity.

The next step, in a strange sort of way, involves us: for it involves a configuration of 'History' as frame of activity - Time asserted as this Time, as Now (rather than inscribed in Reflection in abstraction from the time of this inscription) in which we, simply in virtue of being 'after' that step (the 'beginning of our Era') are somehow or other involved: We also are 'in' this History, whose (retrospective) marking in Time, as a sort of question of the two 'sides' of Time, of the Time of Reflection and the Time in which reflection on Time takes place.

To return to the aristotelian figure of the Drama, the mirroring over a common Time of 'inner' and 'outer' reality or actuality, the confusion of 'inner' and 'outer' in the 'poetic' play of figure, we might see in our 'Era', our Time, a primary figure in which, as 'interface' of 'inner' imagination and 'outer' reality of 'things', the complementary actualities of two 'sides' are themselves articulated. Articulated both 'from within', in 'imagination', and 'from without'. But finding ourselves in this Time, this interface, it is in part up to us to decide what is 'inner' and 'outer'. In this lies the figure - does it not? - of our self-assertion, in which even our consideration of whether or not it does, itself partakes. We're in it, that is, whether we like it or not - we have no choice, but to be thus involved in choice, in this Drama, in which

we read and write, and have a common story or 'History' of some sort - common, at least, to the extent that these very words are a sort of index of interaction, of 'community'.

The transition into 'our' Era amounts to a radical question, corresponding to the interface in the 'poetic' frame of Figure of 'inside' and 'outside', a radical 'working' or actuality of 'figure' in which an 'outer' Frame of Kosmos, its articulation in narrative Time 'responds' as it were to the radical question posed by my part in framing any account (of anything). In this radical question of the 'poetic' closure of 'framing' the two figures of Zeno and Epicurus, *λογος* and Matter, coincide in the academic frame of Action or Drama. But just as these stoic and epicurean 'dimensions' or components of a common actuality of Choice or self-activity were 'concretised' from Aristotle's abstract Economy of Inscription, of 'in' and 'out', and the academic figure of the particular situation was 'concretised' from these relatively abstract 'poles' or figures of stoic and epicurean Choice, so is the 'frame', the figure towards which, as the beginning of an 'Era' or Story, these three components converge, 'concretised' from their common figure of 'abstraction' from the particular situation of this abstraction, these abstractions, in a common context of Space and Time, and indeed, a common frame of their interaction.

Within this common frame - the simple actuality of the 'story' that 'the World' works in some sense as History, as Story - we can take a step back from the (thus far formal or nominal) convergence of contending figures of Reflection or assertion in a sort of 'zero-point' of Time - of our Time - and find again the elementary configuration of different 'imaginary' figures of Reflection, of 'this side' of the mirror of inner and outer actuality in Time, in the 'outward' frame of their interaction in a World, a common frame of Space and Time (and so much else besides). Thus, we may take a step back from this point of convergence of different 'framings' of the activity of framing action to a mirroring, for example, of Carneades' framing of two speeches in Rome, in the context of this initial cultural interaction of Athens and Rome. Or we may step back to the mirroring of the 'internal' relations of Cicero's Law and Antiochus' academic or athenian Kosmos, in the 'external' relations of the roman and athenian situations of these two activities of 'framing' activity.

Or- more generally - I might assert my 'part' in a configuration of 'internal' and 'external' relations of texts, as framing this configuration in the figure of a story - as a History. - As a History 'in' which my external relations with Cicero and Carneades and others in a common Frame of Time and Space, on a common 'Earth', reflect 'internal' relations between this figure of a History, and Cicero's or Carneades' framing, 'figure', of their relations with earlier Reflection.

Cicero's 'frame' is 'moral'; this more 'radical' frame -in which the 'working' of Cicero's moral actuality may be inscribed and correlated with the part, the figure, of Cicero the lawyer, we might call 'dramatic'. For it amounts to the actuality of Figure 'working' simply as such, within the 'primary' figure of two 'sides', 'inner' and 'outer', articulated in a common time - Aristotle's figure of Drama.

To identify this frame as embodied in the configuration of Reflection at the beginning of our 'Era' is, then, to 'participate' in this frame by framing the transition into this 'Era' in the figure of Drama. And this 'works' in the sense that the story that the World is framed as a Story, may be found at work in that transition - in the simple figure of this Story or History 'turning' about the recognition that such a 'story' in some sense 'works', corresponds, like Carneades' figure of assertion as the 'working' of the figure of framing, to a radical 'actuality' and possibility of action: to a 'part' in History.

To put it another way: the question that faced us in the person of Carneades was: how can any framing of Carneades' position - and in particular such a schematic one as that given above - 'work'? In a sense the question is irresoluble. Any 'account' works to the extent that it is indeed an 'account': that is not nothing, but a 'working' of the figure of story, framing, account. But why choose any one account rather than any other? The question is partly resolved by Cicero: We can choose, and not-choosing is simply one possibility among others. In choosing, we discover that choosing a frame of choice 'works', corresponds to a moral actuality of Justice. And we may then rightly try to give an account of Carneades' scepticism or questioning any choice, as either a just or unjustified manner of proceeding in general. Scepticism is itself questioned as an activity.

And now Cicero's assertion of Morality, the (moral' actuality



of Rule, Custom - mos, from which Cicero constructs one of his many new words, moralis - can in turn be 'inscribed' in a more 'radical' working of framing simply as such. - More radical in that it incorporates as complementary 'components' or aspects Cicero's 'practical' or 'moral' criticism of scepticism (as abdication of responsibility, choosing not to choose) and a converse sceptical criticism of Cicero's 'circular' argument for choosing a certain frame of choice, 'providing' for any future deliberation, and (then) applying just such a principle of deliberation to decide that it is 'right', and should 'rule' our activity. - In a more radical 'dramatic' frame, Cicero's 'rational' determination of a rational frame of deliberation, may be seen to define his part in the conflict of factions, his part of Lawyer, asserting the actuality of Law, yet failing to persuade other factions to be so rational as to decide upon a rational resolution of the conflict, and assent to the rule, through the courts, of his own 'middle' knightly class. The choice of Law or Rule which, as judge, he makes on behalf of all parties, ignores the Economy of choice, which can divest him of the part of representative, in which rationality is only one component, one 'moment' (to borrow a term of 'mechanics'). If the argument for Law is to be altogether general, and to evoke in fact that consensus (another ciceronian word) to which, in reason, it is entitled, one must be assured (all must be assured) that everyone else will also be reasonable, consent or assent to be ruled by reason.

But why should they consent? The romans in general are not the fictional participants in a ciceronian dialogue (condition of entry into which is determined - unlike entry into the actual roman assemblies - by Cicero himself). The Law decides cases, ultimately, in relation to the 'parts' played by various individuals; but the initial distribution of parts - which has one man the millionaire Crassus, one man Cicero the lawyer, one man born a slave, is not itself rationally decided. For the millionaire or slave to consent to Law already involves a choice in a wider Economy of interest. It just happens that the interests of the knightly class of Cicero leads him to identify Law as the natural choice of a frame of deliberation. He naturally sees himself as 'disinterested', for it is in his interest that everyone should be thus 'disinterested'.

This difficulty naturally leads to the question of a wider Economy in which it would make sense for everyone to agree to agree, to be bound by impartial deliberation. Yet this wider Economy of Providence

about which Cicero deliberates in the fictional tribunals of reason that replace the real tribunals overthrown by the dictator Ceasar, is itself treated from the deliberative standpoint that it must, in turn, determine or substantiate.

That is: the initial 'circular' abstraction to the Lawyer's rational determination of the relations of rational and irrational, cannot itself determine a more general frame in which this abstraction can be 'justified'. The Law cannot ultimately decide the 'rightness' of the lawyer's perspective, cannot determine why a man in general should deliberate like a lawyer, any more than the Law in fact decides whether a man is born <sup>(to be)</sup> lawyer, slave or millionaire.

The abstraction to a 'part' of lawyer, corresponding to an initial 'identity' abstracted from the poetic frame of 'identification', from the dramatic play of figures of 'me' in my part, and 'that' or 'him' or 'her' outside my part, outside the articulation of my choice, and my activity, is at the same time an abstraction from the actual interaction of 'Heaven' and 'Earth' which the lawyer hopes may 'justify' the part of the lawyer and rational deliberation. - An abstraction from the radical figure of Drama as Mystery into which Cicero had been 'initiated' on his first visit to Athens, in the form of the eleusinian mysteries of Demeter and Persephone, of Life and Death - Mystery as instituted at Athens.

How, then, can be framed, a last step of 'concretisation' of the figure of Drama, a step into a dramatic Frame, a more radical 'activity' or working, in which the 'working' or actuality of Cicero's moral assertion may in its turn, be inscribed?

Such a 'frame' (for want, meanwhile, of a better term for the frame itself, within such a 'frame') must embody, at least, the common or analogous principle of circular 'actuality' in Zeno's first 'step', and Epicurus', and Cicero's - and Carneades', Panaetius', Posidinius', Antiochus'...

- And it must involve some principle of correlation of these different 'versions' of Choice or Action - relating somehow the 'outward' differences by which we differentiate between 'Cicero' and 'Carneades',

for example, to the 'formal' transpositions, logical relations, of their 'views', perspectives, assertions (or - in Carneades' case - non-assertion).

Indeed, this in itself is perhaps enough. - A principle of correlation in a common frame of different perspectives on that frame, with different 'positions' in that frame. And such a principle has already been presented in Aristotle's account of Drama, of the poetics of Action - the correlation of the open Economy of the Possible, the potential, and the closed circuit of Active Reason, in a radical analogy of 'inside' and 'outside', 'self' and 'thing', positing and posited - and this in the elementary frame of the Image, in and from which Reason - Λόγος - distinguishes itself.

This 'dramatic' frame is 'radical' - a 'root' of different 'frames' insofar as these may themselves be determined 'in' terms of this radical frame: the frame itself incorporates a principle of differing from it - as a whole it contains within itself the distinction of part and whole; elements or components of the frame, embodying a common 'dramatic' principle at different 'points' in the frame, do not themselves 'comprehend' their partiality.

Radical also, in that our determination of the frame - mine, at any rate - must themselves be 'inscribed' within the frame. The 'frame' is not simply some 'story', some 'account', of independent Fact (which might be supposed to somehow tell its own story, speak for itself): the position from which the 'story' is asserted is itself 'part' of the story. I do not intend, for example, to comprehend Carneades' non-assertion in some comprehensive and definitive History. I only assert that a certain actuality of criticism, of the Critic, 'in' Carneades, may be 'inscribed' in some more general 'working' or Actuality, which actually determines an interaction of Critic and his Situation, in a wider Economy to which the Critic, as such, is 'blind'. - The figure of its working is not 'comprehended' in the figure of the Critic's framing of his Situation.

I suggest (that is) that the 'beginning of our Era' is marked by a figure of that radical play of Figure, 'analogy', of which (for example) the complementary stoic and epicurean figures of this 'drama' are

themselves two 'poles', and two components. The suggestion involves the implication of this very figure of the assertion that such a figure marks the commencement of our 'Era', in the figure or Drama it asserts - and this as an irreducible component.

This, then, involves the assertion of the embodiment in that transition of the figure of a question: it amounts to the identification of the most radical circularity of assertion (of which the circular criticism of Carneades, say, and the circular 'morality' of Cicero are two 'partial' expressions) as question. - As the question of our part in Actuality, which each one of us can - indeed must - decide for ourselves. I cannot, for example (this from the very nature of the case) play the part of the rational judge who assumes your consent to my 'rational' determination of your part in this figure of Drama. In this the element or figure of Question is more positive than Cicero's positing of Law, of the frame of deliberation which must decide the frame of deliberation. It incorporates the responsibility of each of us to frame for ourselves the frame of our deliberation, and corresponds to a possibility closed to Cicero's readers.

The figure then, of what happens in the transition depending upon our framing of it, is itself embodied in the transition. The transition asserts itself as question.