

INITIATION AND CONTROL OF GAIT FROM FIRST PRINCIPLES

**A MATHEMATICALLY
ANIMATED MODEL OF THE FOOT**



By

Craig Nevin

Presented to the University of Cape Town

Department of Human Biology, Exercise Science and Sports Medicine

in fulfillment of the requirements for the degree of

Doctor of Philosophy

August 2001

ABSTRACT

The initiation and control of gait from first principles: a mathematically animated model of the foot, a doctoral thesis by Craig Nevin examines the anatomical locations of the dynamic pressures that create the first five footprints when a standing person starts to walk. It is hypothesized that the primary activity starts with the dorsiflexion or lifting of the great toe. The metatarsophalangeal region of the forefoot where the first action is believed to begin was studied from three directions.

- ❖ Viewed side-on, the great toe free-body is found from a detailed post hoc analysis of previous kinematic data obtained from cadavers to operate as a cam. The cam model also follows closely from Aristotle's ancient description of the hinged instrument of animate motion.
- ❖ In cross-section, the first metatarsal *torsion strength* was estimated in 13 human, 1 gorilla, 3 chimpanzee 1 orangutan and 1 baboon set of dry-bone specimens of the hands and feet. The first metatarsal bone alone contributes 43% of the total strength of all the metatarsal bones. A result unique amongst the hominids and apes studied.
- ❖ The dynamic components and principle axes of the footprints of 54 humans (32 years \pm 11, 32 male, 22 female) were studied whilst standing on a 0.5m pressure plate, and then immediately when walking over a 2m plate (4 sensors per cm^2 sampled at 100hz). Two footprints were obtained during the initial stance posture, and the first three footprints of the initial walk.

Three new *principles of animate motion* were deduced from the divergent results obtained from complete and dissected cadavers: The *metatarsal cam* (from the sagittal side view) the *ground reaction torque* (from the frontal coronal view) and the *amputation artifact*. The philosophy of experimenting on inanimate cadavers rather than living subjects was intensively researched.

Instead of assuming that gait is a uniform or regular motion as is usual, the foot was analyzed rather as if it was a beam attached the ground. Engineering equations were used to determine the flexural properties of the foot every 0.01 seconds, including the principle axes, radius of gyration and the local shear stresses on the sensors spaced 5-7mm apart. A sequence of these impressions creates a mathematically animated model of the footprint.

The local force under the foot was normalized against both the total force and contact duration. The forces under the foot were each divided between 10 anatomical regions using individual masks for each foot strike. Producing a 54-subject database from which the normal behavior of the foot could be quantified. The group showed a surprisingly low right foot dominance of only 54%.

The combination of the radius of gyration and impulse in particular produces a succinct but powerful summary of the footprint during dynamic activity. The initial angle and magnitudes of the loads that are applied and removed demonstrates that the body first rocks onto the heels after the instruction to walk is given. The feet simultaneously invert and their arches rise off the ground as anticipated.

The principle axes were then animated in a mathematical four-dimensional model. The horizontal radius of gyration is on average 5 cm during heel strike, but increases to 20 cm as the forefoot comes into contact with the ground, finally rising to 25 cm at toe-off. Significantly the applied load during the fore-foot loading phase is more widely distributed than the load being removed. A new and unanticipated result that is believed to be a special characteristic of the animate foot.

The standard deviation of the force under the great toe is the first mechanical parameter to converge in the 54 subjects. Conclusively verifying the hypothesis that the great toe both initiates and controls gait.

CONTENTS

ABSTRACT	iii
CONTENTS	v
ILLUSTRATIONS	xi
GLOSSARY OF ABBREVIATIONS	xv
ACKNOWLEDGEMENTS	xix

1. INTRODUCTION

1.1 BACKGROUND	1
1.1.1 Principle premise	2
1.2 ORGANISATION OF THESIS	3
1.2.1 Advance in knowledge	3
1.2.2 Original point of view	3
1.2.3 Results of research	4
1.3 THESIS OVERVIEW	4
1.3.1 Views of thesis	5
1.3.2 Observed phenomena	6
1.3.3 Projected views	6
1.4 METHODS AND MATERIALS	7

2. VIEWS & REVIEWS

2.1 VIEWS OF THESIS	9
2.1.1 The ancient view—Aristotle's anima	9
2.1.2 The empirical view	10
2.2 HYPOTHESES	11
2.2.1 Biomechanical hypothesis—the body action force	11
2.2.2 Anatomical hypotheses	12
1. First metatarsophalangeal joint arch raising function.	12
2. Osseo-ligamentous control of the MTP-1	13
3. The instantaneous joint center of the MTP-1	14
4. The key action of the MTP-1	15
5. The cam action of the MTP-1	16
2.3 REVIEWS OF ANTITHESES	18
2.3.1 Overview—Newton rules biology	18
2.3.2 Newton's view	18
1. Ætherial medium	19
2. Power of the Will	19
3. Neo-Newtonian review	20
2.3.2 Gait as uniform motion	21
2.3.3 Gait as posture	23
2.3.4 The Galilean view—the real evidence	23

2.3.5	Review of neuromuscular control	25
1.	Muscles in marionettes	25
2.	Muscle as a thermodynamic motor	26
3.	Electromyographic evidence	27

3. FREE WILL AND THE FREE BODY DIAGRAM

3.1	THE BIOMECHANICAL FREE BODY DIAGRAM	29
3.1.1	Procedural steps	30
3.1.2	Definition of body	30
3.1.3	Known and unknown qualities	31
3.2	HISTORICAL ORIGINS OF FREE-BODY	31
3.2.1	Galileo, Aristotle and free fall	31
3.2.2	Aristotle's unmoved mover	32
3.2.3	Galilean constrained body	32
3.2.4	Descartes and Aristotle	33
3.3	CARTESIAN FREE WILL	35
3.3.1	Cartesian Free Will diagram	36
3.3.2	Incorporating the scientific mind	39
3.3.3	Application of Cartesian free will diagram	41
3.4	MATHEMATICAL FRAME OF MIND	43
3.4.1	Cartesian mind	43
3.4.2	Imaginary mind	43
1.	Orthogonal frame.	43
2.	Imaginary frame.	43
3.	Complex frame.	44
3.4.3	Agreement between minds	44
3.4.4	Mathematical origin of animate force	46
3.4.5	Mathematical principles in Galileo's Dialogues	48
3.5	FREE BODY DIAGRAM OF THE UNMOVED MOVER	50

4. ANIMATING THE FIRST METATARSOPHALANGEAL JOINT

4.1	PREVIOUS WORK	51
4.1.1	Unmoved frame of reference	51
4.1.2	Kinematic projected transformation	52
4.1.3	Cadaver layout	52
4.1.4	Great toe kinematics	54
4.2	RESULTS AND FINDINGS	55
4.2.1	Cam and hinge kinematics	55
4.2.2	Fracture kinetics	55
4.3	POST HOC ANALYSIS	56
4.3.1	Kinematic artifacts—the unknown qualities	56

1. Phalangeal artifacts	57
2. Metatarsal artifacts	58
4.4 PRINCIPLES OF ANIMATE MOTION	59
4.4.1 Metatarsal cam	60
4.4.2 Ground reaction torque	61
4.4.3 Amputation artifact	63
4.5 RE-ANIMATION OF CADAVERS	65
4.5.1 Cam effect in free gait	66
4.5.2 Amputation artifact in free gait	67
4.5.3 Galilean pedestal—support for a proximal origin	68

5. METATARSAL FORM AND FUNCTION

5.1 INTRODUCTION	69
5.2 VIEWS AND REVIEWS	69
5.3 HYPOTHESIS	71
5.3.1 Torsion in thin walled bone	71
5.3.2 Torsion in thick walled bone	71
5.3.3 Torsion in an irregular bone	72
5.4 METHOD AND MATERIALS	73
5.5 RESULTS	74
5.6 DISCUSSION	76
5.6.1 Anatomy of the ground reaction torque	76
1. Definitions and domains	76
2. Internal metatarsal torsion	77
3. Distal twist relative to proximal origin	79
5.6.2 Biomechanical joint torque	79
5.7 SUMMARY	80

6. PRESSURE PLATE IMPRESSIONS

6.1 INTRODUCTION	81
6.2 METHOD AND MATERIALS	81
6.3 THEORY	83
6.3.1 Principle axes of the footprint	84
6.3.2 Shear stress	88
6.3.3 Impulse	90
6.3.4 Radius of gyration	90
6.4 RESULTS	91

6.5	DISCUSSION	91
6.5.1	Major premises	91
	1. Biomechanical	91
	2. Anatomical	92
6.5.3	Principle axes	96
	1. Initial posture	96
	2. Gait	96
6.5.4	Radius of gyration	98
6.5.2	Impulse	100
6.5.5	Pressure	102
6.5.6	Shear	105
6.6	SUMMARY	108

7. SYNTHESIS

7.1	INTRODUCTION	109
7.2	FREE BODY THREE VIEWS	110
7.3	MECHANISMS OF CONTROL	112
7.3.1	Shear, torque and control	112
7.3.2	Toe torsion	112
7.3.3	Metatarsal shear and ground reaction torque	113
7.4	FUNCTIONAL ANATOMY	114
7.4.1	Cam and arch	114
7.4.2	Bipedal locomotor framework	115
7.4.3	Cam and cruciate structures	116
7.4.4	Amputation and the cam	117
7.5	CADAVER ANIMATION	118
7.5.1	Cadaver models	118
7.5.2	Constrained body diagrams	118
7.5.3	Cadaver self-propulsion	120
7.5.4	Incorporating mind	121
7.6	MATHEMATICAL ANIMATION	122
7.6.1	An animated model of the foot print	122
7.6.2	Bipedal walking	123
7.6.3	Mathematical form of the amputation artifact	124
7.7	ACADEMIC SYNTHESIS—ADVANCE OF KNOWLEDGE	125
7.7.1	A historic defense	125
7.7.2	Arch of knowledge	126
7.7.3	Rope of knowledge	127
7.7.4	Anatomy of Newton's phenomena	128

8. CONCLUSIONS

8.1	STARTING TO WALK	131
8.2	BIOMECHANICAL POINT OF VIEW	132
8.2.1	Rest and motion	132
8.2.2	Aristotle's unmoved mover	132
8.2.3	Free-body analysis	133
	1. Choice of free-body	133
	2. Isolation of free-body	133
	3. Unknowns	133
	4. Choice of mathematical frame of reference	134
8.3	ANATOMICAL POINT OF VIEW	135
8.1.1	Principles of animate motion	135
	1. Metatarsal cam	135
	2. Amputation artifact	135
	3. Ground reaction torque	136
8.4	HISTORICAL POINT OF VIEW	137
8.4.1	First principles	137
8.4.2	Mathematical principles	137
8.5	RECOMMENDATIONS	138
8.5.1	Technology	138
8.5.2	Future directions	138

REFERENCES	141
-------------------	------------

APPENDIX A: Computer user interface panels	153
---	------------

APPENDIX B: Cinematically animated axes of the footprint	157
---	------------

ILLUSTRATIONS

Fig. 0-1. Dance of Shiva.....	i
Fig. 1-1. The hypothetical body action force that acts through the great toe of the initial stance foot (Mann et al., 1979).	2
Fig. 2-1. The long 'bootstrap' muscles of the great toe (Nevin, 1995).	13
Fig. 2-2. First metatarsophalangeal joint angle during walking (Nicol, 1987).	14
Fig. 2-3. Phalanx motion (Sammarco, 1980).	14
Fig. 2-4. The mitred hinge of the ankle (Inman et al., 1981).	15
Fig. 2-5. Metatarsal cam in normal MTP-1 (Nevin, 1997).	16
Fig. 2-6. Metatarsal hinge in dysfunctional MTP-1 (Nevin, 1997).	16
Fig. 2-7. Cam action at the knee.	17
Fig. 2-8. Accelerographic analysis of pathological gait (Lettre & Contini, 1967).	22
Fig. 2-9. A trained runner's speed sampled at regular 10cm displacement intervals during a 60m run using a rip chord attached to a waistband (R de Wit, personal communication).	22
Fig. 2-10. Cartoon explaining muscle action during gait (Inman, Ralston and Todd, 1981).	25
Fig. 2-11. Homunculus detail.	25
Fig. 2-12. Figure from <i>De Humani Corporis Fabrica</i> , (Vesalius 1543).	26
Fig. 3-1. Three examples of biomechanical free body diagrams.	29
Fig. 3-2. The Cartesian 'Free Will' diagram, after René Descartes' partitioning of body and mind.	37
Fig. 3-3. The Cartesian Free-Will diagram extended to include some anatomical form and contemporary science.	38
Fig. 3-4. Descartes' neuromuscular control loop.	40
Fig. 3-5. Reincorporating Descartes' physiological and physical bodies of knowledge using the Free-Will diagram and a two phase rotation of the unit imaginary vector in <i>res cogitans</i> space.	42
Fig. 3-6. Disorientated imaginary mind-space.	44
Fig. 3-7. Complex orientation of real-imaginary mind-space	44
Fig. 3-8. Two independent minds merge.	46
Fig. 3-9. Re-emergence of like-minds with common mechanical reference vector. The 'Galilean friend' model.	46
Fig. 3-10. The Cartesian individual mind. A real axis or dimension constructed from individual four dimensionless imaginary coordinates.	46
Fig. 3-12. Fixed length of chord between foci traces an ellipse. A model for animate muscle.	47
Fig. 3-13. Frontispiece of Galileo's <i>Dialogue on the Great World Systems—Ptolemaic & Copernican</i>	49
Fig. 3-14. Aristotle's helmsman/oarsman required for propulsion. (a) Diagram of external unmoved mover. (b) Diagram of the internal unmoved mover with internal translation brought to rest.	50

Fig. 4-1. Kinematic projected transformation of the MTP-1. A novel method for describing the proximal phalanx as Aristotle's internal unmoved mover (Nevin, 1995, 1997).....	52
Fig. 4-2. Kinematic projected transformation cadaver layout.....	53
Fig. 4-3. MTP-1 clamp detail from plantar view (plane A_2).....	53
Fig. 4-4. Transverse view of metatarsal clamp (M_3).....	53
Fig. 4-5. Conventions for the alignment of various frames, planes and axes.....	57
Fig. 4-6. MTP-1 plantar rotation artifact.....	57
Fig. 4-7. Segment rotations compared to a boat. (a) Starting position, (b) metatarsal motion as a composite supination-pronation, (c) inversion-eversion, (d) adduction-abduction, (e) flexion-extension (Kapandji).....	58
Fig. 4-8. 2D cam shape artifact of a classical hinged motion.....	59
Fig. 4-9. 3D metatarsal cam artifact with the transverse cam axis acting as a real-imaginary lever arm.....	59
Fig. 4-10. Ground reaction torque in the metatarsal shaft.....	61
Fig. 4-11. (a) The 'Archimedian cadaver' floating in water to isolate the ground reaction torque. (b) Counter rotations needed to maintain free-body at rest. (c) Gravity constraint once floatation removed.....	62
Fig. 4-12. Laboratory stacking arrangement.....	65
Fig. 4-13. Thought experiment rearrangement.....	65
Fig. 4-14. Self-animated rearrangement.....	65
Fig. 4-15. Unmoved mover rearrangement.....	65
Fig. 4-16. Artificial reattachment after amputation that gives rise to the amputation artifact.....	68
Fig. 5-1. First metatarsal as internal supinating antagonist to internal pronating lesser metatarsals.....	70
Fig. 5-2. Lesser metatarsals acting as bipedal supination agonists to the first metatarsal of the opposite foot.....	70
Fig. 5-3. Derivation of elastic torsion formulae; (a) thin cortex, (b) thick cortex, (c) irregular cortex.....	72
Fig. 5-4. Lasso principle for measuring bone perimeters.....	73
Fig. 5-5. Minimum metatarsal shaft perimeter in man and apes.....	74
Fig. 5-6. Minimum metacarpal shaft perimeter in man and apes.....	74
Fig. 5-7. Relative metatarsal and metacarpal shaft sizes in man and apes normalized on the third ray.....	75
Fig. 5-8. Relative metatarsal and metacarpal torsion strengths in man and apes.....	75
Fig. 5-9. Ground reaction torque hyperbola showing the anatomical and environmental domains of constant torque and twist.....	77
Fig. 6-1. Pressure plate layout.....	81
Fig. 6-2. Continuous rest hypothesis. The leg modeled as a mechanical beam.....	83

Fig. 6-3. Pressure plate sensor array, divided into discrete cells and clusters of sensors.	84
Fig. 6-4. Mean pressure distribution on plate.	86
Fig. 6-5. Moment profiles arising from an evenly distributed force.	86
Fig. 6-6. Second moment profile produced by an evenly distributed force, in two orthogonal directions superimposed on a footprint.	87
Fig. 6-7. Clusters of nine sensors consisting of four cells of four.	88
Fig. 6-8. Principle axes of a cell of sensors.	89
Fig. 6-9. Shear vectors at cell boundary.	89
Fig. 6-10. Cluster of resultant cell shear vectors summed at central sensor position.	89
Fig. 6-11. Total force profiles beneath the foot; mean of fifty-four subjects.	93
Fig. 6-12. Relative distribution of forces beneath the foot; mean of fifty-four subjects.	94
Fig. 6-13. Standard deviation of forces beneath the foot, mean of fifty-four subjects.	95
Fig. 6-14. Foot angle defined by principle pressure and impulse axes with and without great toe in fifty-four subjects.	97
Fig. 6-15. Radius of gyration for total force and positive and negative impulses; median of fifty-four subjects.	99
Fig. 6-16. Impulse distribution; mean of fifty-four subjects. Steps 1-3.	101
Fig. 6-17. Impulse distribution; mean of fifty-four subjects. Steps 4-5.	102
Fig. 6-18. Maximum pressure per region; mean of fifty-four subjects.	103
Fig. 6-19. Relative pressure per region. Median value as a percentage of mean step pressure in 54 subjects.	104
Fig. 6-20. Maximum shear in the horizontal foot sole regional maxima in fifty-four subjects.	106
Fig. 6-21. Normalized ratio of maximum shear to maximum regional pressure during transition from posture to gait in fifty four subjects.	107
Fig. 7-1. Three views of the forefoot free-body, the forefoot buttresses of the arch.	110
Fig. 7-2. Three modes of shear in the boundaries of forefoot MTP-1 free body.	111
Fig. 7-3. Maxwell's suggested method of exercising 'animate' control over physical body without doing mechanical work (McDougall, 1911).	112
Fig. 7-4. Triplanar strains in a control frame; the inevitable three-dimensional twist associated with simple plane torsion about one axis.	113
Fig. 7-5. The basic relationship between (a) Archimedian rotation, (b) Shear strain and the ground reaction torque.	113
Fig. 7-6. Cam replaces metatarsal arched beam.	114
Fig. 7-7. Metatarsal cam and key-bone action. Insert, twist, lock.	114
Fig. 7-8. Modeling plantar pressure support using the kinematic projected transformation experimental frame.	115

Fig. 7-9. The KPT metatarsal frame transformed into a rudimentary bipedal skeletal locomotor framework with an external 'black box' torque coupling.	115
Fig. 7-10. Torque linkages (a) series, (b) parallel.	116
Fig. 7-11. Connections that enable counter rotations in four-rod torsion linkage such as occurs in the knee.	116
Fig. 7-12. Toe, knee and hip cams linked in series.	117
Fig. 7-13. Galilean Cadaver. A closely observed body, controlled by a helmsman and propelled by external forces.	119
Fig. 7-14. Archimedian Cadaver (a) free-floating free-body; (b) fixed-hinged constrained-body type.	119
Fig. 7-15. Cartesian Cadaver isolated in a thought experiment or meditation.	119
Fig. 7-16. Mechanical constraints acting on the Cartesian cadaver. (a) Cartesian G-clamp; (b) Aristotle's body animation hinge-instrument; (c) control via free-will, gravity, torque and cam interaction.	121
Fig. 7-17. Mathematical animation sequence of the bipedal human body action force axes using a center of pressure impulse model.	122
Fig. 7-18. The position of the body action force inferred from the shifting ground reaction force during gait; (a) at the start, (b) during double-stance phase.	123
Fig. 7-19. Oldroyd's representation of the <i>arch of knowledge</i> derived from Newton's <i>Question 31</i> of the <i>Opticks</i>	126
Fig. 7-20. The rope of knowledge as a twisted set of historical definitions.	127
Fig. 7-21. Operational mappings of the <i>res cogitans</i> field of nomena onto <i>res extensa</i> phenomena. (a) Four-dimensional arguments in a circle; (b) Newton's arch of knowledge, inductive leg.	128
Fig. 7-22. Constraints defining the problem of initiating gait. (a) Newton's axioms; (b) Aristotle's proximal origin.	129
Fig. 7-23. Argument in circle as a historical fiber forming a helix in the rope of knowledge.	129
Fig. 7-24. Arch and rope of knowledge.	130
Fig. 7-25. Arch and rope of knowledge compared to the anatomical structure of the foot.	130
Fig. A-1. Main screen with menu bar for data processing routines.	153
Fig. A-2. Computerized footprint identification and subdivision into 10 color-coded regions.	154
Fig. A-3. Computerized footprint region selection based on the pressure distribution.	155
Fig. A-4. Manual footprint region editing and verification screens.	155
Fig. A-5. Contact time bar charts for the ten footprint regions taken separately from two plates.	156
Fig. B-1. Cinematically animation of the principle axes of the footprint of a 38 year old male.	157

GLOSSARY OF ABBREVIATIONS

{ } ₁	first ray of toe or finger, subscript identifier
{ } ₂	second ray of toe or finger, subscript identifier
{ } ₃	third ray of toe or finger, subscript identifier
{ } ₄	fourth ray of toe or finger, subscript identifier
{ } ₅	fifth ray of toe or finger, subscript identifier
1	metatarsophalangeal joint in cadaver preparation
2	junction between metatarsal base and foot, the cam follower at metatarso-cuneiform joint
3	junction between cadaver torso and dissection room bench B
4	junction between compliant element D and bench B'
5	junction between compliant support element D and the drawing board A
6	G-clamp between metatarsal and cam drawing board
7	sliding junction between drawing board and projected metatarsal and phalanx positions
8	clamp or tie between amputated specimen and experimental apparatus support frame E'
2D	two dimensional (x,y)
3D	three dimensional (x,y,z)
4D	any four dimensional system of coordinates; e.g. relativistic [3L+1T], Cartesian 4i <i>res cogitans</i> , <i>res extensa</i> second moment of area framework, tensegrity tetrahedron
A	frame where kinematic data is gathered during KPT experiment
A ₁	sagittal plane or side-view of kinematic frame A , the drawing board plane used for the cam
A ₂	transverse horizontal plane, view of kinematic frame A
A ₃	coronal or frontal view of kinematic frame A ; cross section of forefoot
a ₁₂	anterior-posterior axis of kinematic frame A at intersection of planes A ₁ and A ₂
a ₁₃	superior-inferior axis of kinematic frame A at intersection of planes A ₁ and A ₃
a ₂₃	medial-lateral axis of kinematic frame A at intersection of planes A ₂ and A ₃
A	area
Ā	area enclosed by a cross section of the outermost perimeter rim of bone shaft annulus
B	bench supporting cadaver
B'	bench supporting cadaver part, differing in height from bench B by height h .
BAF	body action force
C	cadaver torso proximal part
CoF	center of force
CoM	center of mass
CoP	center of pressure
D	compliant element of undetermined stiffness
d	distance variable
E	external experimental apparatus applying force
E'	external experimental apparatus applying force against own resistance
EHB	extensor hallucis brevis muscle
EHL	extensor hallucis brevis muscle
FDL	flexor digitorum longus muscle

F	foot part of cadaver
FDL	flexor digitorum longus muscle
FHB	flexor hallucis brevis muscle
FHL	flexor hallucis longus muscle
G	ground or gravity reference frame
G₁	vertical side-view, gravity/ground reference
G₂	horizontal plane, gravity/ground reference
G₃	frontal cross-section view, gravity/ground reference
g₁₂	horizontal fore-aft axis at intersection of planes G₁ and G₂
g₁₃	vertical axis at intersection of planes G₁ and G₃
g₂₃	horizontal transverse axis at intersection of planes G₂ and G₃
GRF	ground reaction force
GRT	ground reaction torque; ground reaction twist
HL	lateral half of heel footprint
HM	medial half of heel footprint
h	vertical distance between supported body C on bench B and non-compliant bench B' on ultimate ground support G ; Galilean pedestal height
I	second moment of area
i	imaginary mathematical unit; $\sqrt{-1}$
J	polar second moment of area
KPT	kinematic projected transformation experimental method
L	isolated laboratory reference frame
[L]	length dimension
[M]	mass dimension
M	frame clamped to first metatarsal bone
M₁	sagittal plane or side-view of metatarsal frame M
M₂	transverse, approximately horizontal plane of metatarsal frame M
M₃	coronal cross-section or frontal view of metatarsal frame M
m₁₂	long axis of metatarsal bone at intersection of planes M₁ and M₂
m₁₃	superior-inferior metatarsal axis at intersection of planes M₁ and M₃
m₂₃	medial lateral anatomical axis at intersection of planes M₂ and M₃
M1-L	first metatarsal head region of left footprint
M1-R	first metatarsal head region of right footprint
M2-L	second metatarsal head region left of footprint
M2-R	second metatarsal head region right of footprint
M3-L	third metatarsal head region of left footprint
M3-R	third metatarsal head region of right footprint
M4-L	fourth metatarsal head region of left footprint
M4-R	fourth metatarsal head region of right footprint

M5-L	fifth metatarsal head region of left footprint
M5-R	fifth metatarsal head region of right footprint
MC	metacarpal bone in hand
MF-L	mid-foot region of left footprint
MF-R	mid-foot region of right footprint
MT	metatarsal bone in foot
MT-1	first metatarsal bone
MTP	metatarsophalangeal joint
MTP-1	first metatarsophalangeal joint
P	frame clamped to first proximal phalangeal bone
P₁	sagittal plane or side-view of proximal phalangeal frame P
P₂	transverse, approximately horizontal plane of proximal phalangeal frame P
P₃	coronal cross-section or frontal view of proximal phalangeal frame P
p₁₂	long axis of proximal phalanx at intersection of planes P₁ and P₂
p₁₃	superior-inferior axis of proximal phalanx at intersection of planes P₁ and P₃
p₂₃	medial lateral anatomical axis of the phalanx at intersection of planes P₂ and P₃
P_i	universal joint clamped to phalanx to enable phalanx frame P to coincide with frame A
PL	peroneus longus muscle
q	shear force
R	outer radius
r	generic radius, inner radius
RoG	radius of gyration of footprint in horizontal ground plane
s	distance
T	tensile soft tissues in foot
T	torque
t	thickness; time
τ	shear stress
[T]	time dimension
T1-L	great toe phalanx region of left footprint
T1-R	great toe phalanx region of right footprint
T2-5-L	lesser toe phalanx regions of left footprint
T2-5-R	lesser toe phalanx regions of right footprint
TA	tibialis anterior muscle
TP	tibialis posterior muscle
X	x coordinate of center of pressure
x	cartesian <i>res extensa</i> primary horizontal coordinate
Y	y coordinate of center of pressure
y	cartesian <i>res extensa</i> secondary horizontal coordinate
z	cartesian <i>res extensa</i> vertical coordinate

ACKNOWLEDGEMENTS

Supervisor:	Prof. TD Noakes	Department of Human Biology, Exercise Science and Sports Medicine, University of Cape Town, Sports Science Institute of South Africa
Co-Supervisor:	Prof. LP Adams (retired)	Biostereometrics University of Cape Town
Technical Sponsor:	Mr Jean-Pierre Wilssens	Director RSscan INTERNATIONAL Olen, Belgium
	Mr Bart Jacobs	Software Development RSscan INTERNATIONAL Olen, Belgium
Others:	Dr Lucy-May Holtzhausen	Department of Anatomy University of Cape Town
	Dr Stephan Praet	Sports Physican Praet Health Consultancy Eindhoven, The Netherlands

1.

INTRODUCTION

“It seems reasonable to begin the description of walking with a discussion of the translation of the body as a whole through space.” — Inman, Ralston and Todd¹

1.1 BACKGROUND

Starting to walk from a standing posture is an effortless task. But the scientific problem of how we start to walk is much more complex, not least because it is difficult to explain how disembodied thoughts exert any control whatsoever over the motion of our physical bodies.² The basic problem is not a new one. Zeno of Elea (470 BC) for example pointed out a famous paradox³ that arises when one attempts to study the motion of an elite athlete for example by dividing it into finite intervals.

The modern gait analysis method arguably began though with Braune and Fischer (1896-1904), whom were the first to combine the then new technology of cinematic animation⁴ with Newton's mathematical principles. This cinematic animation method however relies precisely on the type of finite time-interval data that Zeno found so paradoxical. What's more modern cinematic *animation* is barely recognizable as the *anima* that the ancient believed was the *first cause* of all movement.

Aristotle (384-322 BC) wrote several books on the *Anima*, although he is perhaps better known as the author of the original *Physics*.⁵ The influence of the *Physics* lasted almost two thousand years until Johannes Kepler (1621) choose to describe the universal *anima*, the principle that was assumed to move the heavens, as a *physical force*.⁶ Soon thereafter Galileo Galilei (1638) launched the new mechanical sciences,⁷ forging a reputation as an experimental philosopher at Aristotle's expense. French philosopher and mathematician René Descartes (1644) also rejected the old interpretations of the Aristotelian Schools and sought to explain human movement in terms of mechanics and physiological reflex. But it was ultimately Isaac Newton (1687) who replaced the theology of the heavens animated by cherubs and angels with the mathematical principles of mechanical physics.

Ironically, Galileo and Newton's hypothesis of *uniform motion*, which superceded the physics of Aristotle's *unmoved mover*, has itself long been eclipsed by the modern physics of quantum mechanics and relativity theory. But in biomechanical schools where one deals with physics on a human scale, these newer and older theories are known only through occasional anecdotes. It is very much the scientific view that “Newton rules biology”⁸ despite the fact that Newton unlike Aristotle wrote very little on the movement of animals, and even that which he specifically did write has been almost entirely disregarded in favour of his mathematical principles of motion.

Unlike gait itself, which has been studied extensively through cameras, the initiation of gait phase has mostly been studied experimentally using electrodes on the muscles, and a force plate beneath the feet to measure the ground reaction force. These methods presuppose that gait is under *active neuromuscular control* and best described in terms of propulsive Newtonian forces. So it is sensible to first see what can be inferred from these data.

¹ *Human Walking*, 1st edition (1981).

² Mario Bunge (1980) writes “The mind-body problem is a notoriously hard nut to crack—surely even more so than the problem of matter.”

³ The 'Achilles paradox'.

⁴ Muybridge (1887).

⁵ Aristotle's texts have historically been divided between the *Physics* and the *Metaphysics*. Not as I propose *Physics* and the *Anima*.

⁶ Jammer (1957), p.90.

⁷ Galilei (1638) *Dialogues and mathematical demonstrations concerning two new sciences pertaining to mechanics and local motions*. See Ascenzi, (1993).

⁸ Pennycuik (1992).

1.1.1 PRINCIPLE PREMISE

Newton's first law requires that a force be impressed to move a body from a state of rest. Impressed forces arise specifically according to Newton from pressure, percussion and centripetal forces such as gravity.⁹ Newton's third law of motion suggests that for every action there is an equal and opposite reaction directed to contrary parts. Thus, if the human body initiates action, like starting to walk, there must be a ground reaction effect exactly in the opposite direction. A simple plot of the progression of the *ground reaction force* [Fig. 1-1] indicates that the causal *body action force*, which is presumed to be the motivation behind the movement, is directly aligned with the first metatarsophalangeal joint (MTP-1) of the great toe of stance foot.

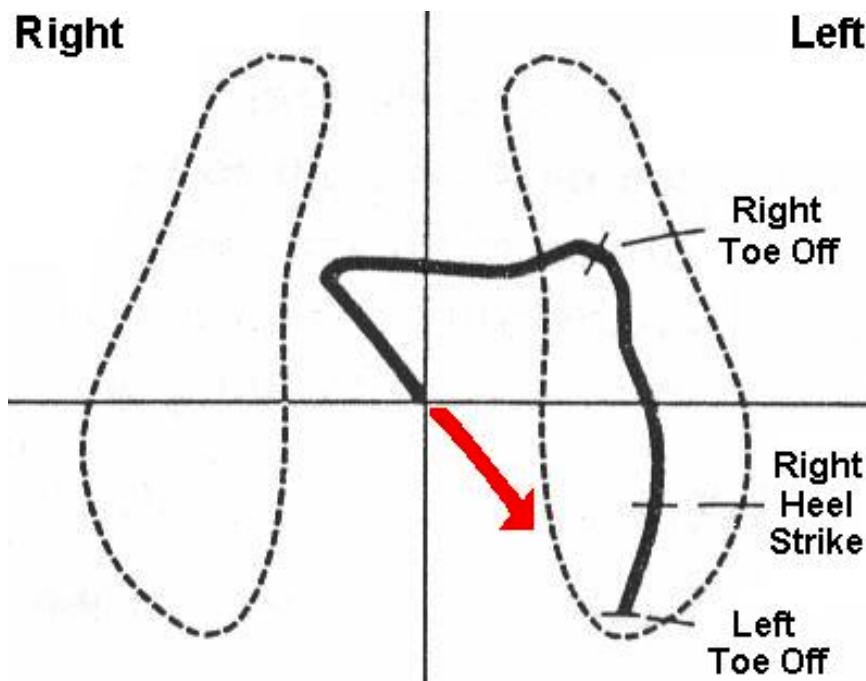

Fig. 1-1. The hypothetical body action force (arrow) that acts through the great toe of the initial stance foot. The arrow in the left forefoot quadrant is superimposed here on a center of force diagram adapted from Mann et al. (1979).

The *principle premise* of the thesis is therefore that the anatomical, physiological, mathematical and biomechanical mechanisms needed to animate the body via a voluntary human bipedal body action force can be determined directly from an analysis of the motion of the great toe.

⁹ Newton (1726). *Principia*, Definitions 3-4.

1.2 ORGANISATION OF THESIS

A thesis has several forms. An academic thesis is simply a written dissertation advancing an original point of view as a result of research leading to an advance in knowledge.¹⁰ From this definition three basic requirements emerge:

- ❖ The need for a *new and original point of view*.
- ❖ A description of how this *original point of view* is based on the *results of research*.
- ❖ A demonstration of how this *new and original point of view* leads to an *advance in knowledge*.

1.2.1 ADVANCE IN KNOWLEDGE

Given the academic requirement for advancing knowledge, the dialectic thesis format of Hegel is preferred. Whereby a proposition (thesis) is transformed into its opposite (antithesis) and preserved and fulfilled by it, the combination of the two being resolved in a higher form of truth (synthesis); the ultimate synthesis being that of the mind or thought.¹¹ Another good reason for preferring the dialectic format is that philosophers such as Hamblin (1963) recognize that stopping and starting is not really an empirical problem at all and hence unlikely to be resolved by a simple discussion of empirical methods and materials.¹²

The two types of thesis, dialectic and academic, also start with different philosophical premises:

- ❖ *Academic* premises are based entirely on original observations of experimental phenomena.
- ❖ *Dialectic* premises follow directly from the perceived fallacies and deficiencies of the philosophical foundations of the opposing views.

Besides these traditional tests of knowledge, reference is also made to Descartes' *Principles of philosophy*, particularly those parts *On human knowledge*, and Oldroyd's (1986) thesis of an *Arch of knowledge*, which is based in part on Newton (1730) Question 31 in the *Opticks*.¹³ The arch of knowledge model allows a succinct comparison between the higher structures of intellect required for Hegel's synthesis and the anatomical concept of a bony arch of the foot and its plantar supporting structures that provide the subject material for this thesis.

1.2.2 ORIGINAL POINT OF VIEW

The basis of a thesis is an original hypothesis. But the word *original* has at least four meanings:

- ❖ **Novelty**. A unique or innovative method or observation.
- ❖ **Precedence**. The first of its kind, attributable to a specific point in time, a historic date or event.
- ❖ **Mathematical** origin. A dimensionless mathematical point, with no property but position.
- ❖ **Anatomical** origin. Start of a nerve or muscle; the proximal or immobile end, as opposed to its distal mobile *insertion*.

¹⁰ **thesis**; Reader's Digest Universal Dictionary.

¹¹ **dialectic**; Reader's Digest Universal Dictionary.

¹² An empirical scientific thesis traditionally draws *conclusions* from a *discussion of results* after having applied certain *methods* to specific *materials* following from an *hypothesis* that is established as novel by an exhaustive *review* of the literature.

¹³ Oldroyd (1986, pp.78-84).

Most important of all is the mathematical point—the *original dimensionless point* from which the *original point of view* of a scientific thesis ultimately depends. This point, which has no property except position, nevertheless has to be linked with appropriate anatomical and historical origins.

The *novel anatomical origin* is the distal proximal phalanx of the great toe. In a historical sense, this origin follows logically from Aristotle's physical solution of the mind-body problem in his third book *On the Anima* where he described the origin of motion arising in an animate hinge joint. But this choice of historical origin in the *Anima* is unique because Aristotle in the *Progression of animals*¹⁴ preferred to locate the origin *proximally* near the heart, not in the *distal* segment of the toe. Vainly contriving to establish an honorable hierarchical 'proper place' for the origin of human motion.

Consequently in anatomical schools, the *origin* of a nerve or muscle is fixed in the proximal segment, with the assumption that it moves the *insertion* at the distal segment. But in reality it is often the distal segment that is fixed on the ground during gait and the proximal segment that moves most. By shifting Aristotle's original *origin of movement* to the distal portion of the great toe at rest, the thesis begins the process of reversing the ancient hierarchy of the theory of human movement control in an original anatomical, mathematical and historical sense.

1.2.3 RESULTS OF RESEARCH

The *novel method* that lays the phenomenal foundations for the present thesis, comes from a prior dissertation of mine.¹⁵ I shall refer to this method as kinematic projected transformation (KPT). It is novel because it provides an unprecedented description of the *relative rotations* of the inanimate cadaver great toe. The KPT method basically provides experimental support for Aristotle's theory of the *unmoved mover* applied to an *animate hinge*.

Another novel aspect arises specifically when Aristotle's arbitrarily elevated 'proper place' for the soul is discarded and replaced by an ostensibly less honorable *osseo-aponeurotic* model of gait initiation and control centered in the great toe. This philosophy originates in my reading of Hick's (1954) who provided a new and original description of the functional anatomy of the great toe in the dead and paralytic where active neuromuscular control was entirely absent.

The thesis in essence combines the results of this previous research in the mechanics of the inanimate MTP-1 with Aristotle's description of a hinge joint, which is then mathematically re-animated using an extended set of Cartesian coordinates physically attached to the great toe.

1.3 THESIS OVERVIEW

Aristotle was at the forefront of the academic tradition to first review the views of others.¹⁶ Einstein noted that new insights and theories develop gradually and should not be compared to knocking down an old barn and building a sky-scraper in its place.¹⁷ Perhaps here a comparison can be made with a hiker walking along a wilderness trail through a jungle of data. The "views" are panoramas from existing paths. The veritable jungle of data can be viewed close up from the paths with all its snags, thorns and bugs; or overviewed as a distant vista from a clear supposedly well-established historical vantage point. The well-trodden paths constitute the received view, academic starting points that lead to specific view-points. The data may be said to be viewed or reviewed respectively depending

¹⁴ 706b.

¹⁵ Nevin (1995). The design and cadaveric assessment of a new artificial first metatarsophalangeal joint replacement for the great toe. Masters dissertation.

¹⁶ Zeno's paradox's are for example preserved through Aristotle's review.

¹⁷ *The evolution of physics*, Einstein and Infeld (1971) p.152.

on one's current or historical viewpoint and the direction of progression relative to these official route indicators or established traffic flow.

At specific junctions the historic trails naturally diverge. One deliberate or implicit choice of intellectual direction at a dichotomous junction leads to the view point of the thesis and the other to the opposite view point of the antithesis. In terms of the Hegelian synthesis these *view points* are just different vistas of the same mountain of experimental evidence. It is ultimately the combination or synthesis of these disparate views that increases to our knowledge by providing a more comprehensive map of the subject matter.

The function of the *review of the antithesis* in Chapter 2 is not to busy ourselves preventing weed encroachment by eliminating opposing views at the most popular neo-Newtonian viewpoint. But rather to open up new and often surprisingly old trails, all the time *re-viewing* or viewing afresh the data back to an historical *starting point* from whence one can synthesize a novel solution to the problem of initiating gait.¹⁸

1.3.1 VIEWS OF THESIS

The first observation is that gait is invariably viewed as a state of *uniform motion*, despite the fact that there is arguably no experimental evidence to suggest that a state of uniform motion is ever achieved. The very words walking and running for example imply motion. Hence it is exceedingly difficult to distinguish how the concept of walking or running for example differs from the motion itself.¹⁹ Uniform motion has by definition no beginning or end.²⁰ Hence the common view that gait is a state of uniform motion, actually creates the problem under scrutiny, that of initiating gait.

The *uniform motion* postulate thus forms the natural antithesis to the thesis. Paradoxically, any true solution to the initiation of gait problem is compelled to undermine the postulate of uniform motion. This is not as simple as one might suppose, because the postulate of uniform motion otherwise known as the Galilean invariance, forms one of the main foundations of classical physics.²¹

One could argue the point dialectically for example, by taking an academic position contrary to Galileo or Newton's fundamental premise of uniform motion.²² But I forgo this opportunity; conceding instead that the premises of Galileo and Newton are as valid as just every academic presupposes. But then I go further to hypothesize that the neo-Newtonian school of researchers that has championed these theories, have failed to apply Newton's philosophy with *sufficient* rigor.

Rigorous application of Newton hypotheses of animal motion for example requires a consideration of *aether* and the *Power of the Will* and several other factors such as the mechanisms of *anatomical choice* that are touted in Question 31 of his *Opticks*. All of which are almost completely ignored by existing classical biomechanical models with Newtonian pretensions. Galileo for example, in his famous example of his invariance aboard a ship, concludes that one cannot distinguish between moving uniformly and standing still. Yet through the classic gait and posture divide, biomechanists routinely do. The primary criticism of the antithesis therefore is based on simple self-contradiction in the philosophical foundations in the biomechanics rather than technical imprecision in its application.

¹⁸ I am indebted to Prof. Laurie Adams for the insight that any robust claim to originality (novelty) is more than likely to be an unfortunate admission of an incomplete literature review.

¹⁹ Many philosophers throughout history have used walking specifically as *an example* of a state of motion. Opposing it to a state of rest.

²⁰ An inference exploited by Zeno.

²¹ The term 'classical physics' applies here to the sense used by Penrose (1989), i.e. to continuum mechanics as distinct from quantum mechanics.

²² The traditional scholastic dialectic tradition, of arguing a thesis from the false premises of the opposing view, necessarily leads to a situation where Newton's hypothesis of equal and opposite reactions for example can be right only if Aristotle's hypothesis of an unmoved mover was wrong.

1.3.2 OBSERVED PHENOMENA

Dialectic squabbles are ultimately settled by reference to anatomical data. The empirical evidence I choose to submit for detailed post hoc analysis is my own original data on the kinematics of the MTP-1 of the great toe (Nevin, 1995). The principal conclusion of this prior research (Nevin, 1997) is that the MTP-1 functions, not as a well-oiled hinge or windlass as proposed by Hicks (1954) but as a cam.

The metatarsal *cam model* is the original *anatomical premise* of the thesis and provides the results of my personal research upon which the original observations of the present thesis are based.

Traditionally the anatomical *form* of the foot is seen as a bony *arch*. The arch is a classic structure. Many imperial stone arches have stood for thousands of years without moving an inch.²³ Yet the anatomical arch of the foot which includes the great toe as its distal buttress, must move at least one foot²⁴ every second. It is important to recognize that a cam is a mechanical element whose behavior is primarily dynamic; in contrast with the arch which is primarily static. It is therefore my view that the dynamics of great toe that are implicated in the initiation of gait phase are best compared to a cam.

The cam hypothesis is based on data from inanimate cadavers, dead bodies that need to be reanimated so to speak. The necessary *mathematical reanimation* is achieved through the philosophy of Aristotle, and the mathematics of a Cartesian frame of reference. Aristotle wrote that the *anima* attaches to the physical body in the region of a hinge joint. Comparisons with modern force plate data indicate the location in question is MTP-1 hinge joint [Fig. 1-1].

Aristotle also hypothesized that there is always something *unmoved* within the individual that rests on something *unmoved* outside. Although not its original declared intention, my previous experimentation into great toe kinematics provides a very good experimental test of Aristotle's philosophy of the internal unmoved mover that rests on something unmoved outside.

The anatomical study of MTP-1 motion by Hicks (1954) leads to a rather surprising hypothesis. Namely that the action of the toe (and perhaps through its anatomical relations, other structures of the body involved in gait) appear to be primarily *passive* and *aponeurotic*; *not active* and *not neuromuscular* as many might intuitively suppose.²⁵

1.3.3 PROJECTED VIEWS

Starting from these observations, the ultimate goals of the thesis are to:

- (1) *Describe* the functional anatomy of the great toe with respect to the foot.
- (2) *Develop* the new anatomical principles that Newton argued were essential for animate motion.
- (3) *Determine* and *demonstrate* the anatomical extent, action and control function of this novel anatomical system within the stance foot and leg.

²³ 0.0254 m.

²⁴ 26 bones or 0.3048 m.

²⁵ This counter-intuitive hypothesis appears to be supported by an unusual observation by Basmajian (1976) the pioneer of EMG studies who noticed the paradox that the neuromuscular signals during gait were often diminished when they were most expected.

1.4 METHODS AND MATERIALS

Chapter 2 presents the views of the thesis summarized above, contrasting them with the reviews of the antithesis. The overwhelming sentiment is that “although Einstein may have changed our view of the universe, our view of gait is still Newtonian.”²⁶ (Cavanagh, 1990). Strict application of Newton’s first law for example naturally divides biomechanics into two fields of research:

- ❖ Gait—the study of the body moving in uniform translation; and
- ❖ Posture—the study of the body at rest.

The first task of the thesis is therefore to define how we move from the *static posture* of standing to the *dynamic posture* of gait. This however is a complex task because it is necessary to bridge or replace the implicit gait-posture biomechanical classification divide.

Emphasis should be directed to the fact that the thesis is based on Newton’s *first* constraint of his first law, and hence is based on Newtonian first principles.²⁷ Gait is viewed intrinsically as a continuous *static* standing posture, governed by a new *dynamic* anatomical structure the *metatarsal cam*. This contrasts starkly with the *antithesis* that defines gait as an intrinsically *dynamic process* of uniform motion *supported* by an entirely *static anatomical form*, the arch of the foot.

Chapter 3 starts with a fundamental step in the mechanical analysis—drawing a free body diagram. Although drawing a free-body diagram should be the basis of all mechanical analysis, the drawing of the biomechanical free body diagram is sadly neglected in the literature. The upgrade from a mechanical to a biomechanical free body diagram is achieved by using Descartes’ *Principles of Philosophy* which incorporate an essential but elusive Free-Will component.

Chapter 4 describes the physical consequences of imposing the conditions implicit in the mechanics of drawing a free body diagram. The chapter contains an in-depth post hoc analysis of the results of a previous dissertation where the great toe was *amputated* from cadavers. This amputation allows the effects of actual physical isolation of the MTP-1 body to be compared to the effects of intellectual isolation of the free body by analysis. At the very end of the thesis the mathematical effects of amputating the great toe will be assessed in a computer model.

The detailed analysis of previous work reveals three previously unrecognized kinematic artifacts. These artifacts it must be emphasized are intrinsically intractable. A sizable proportion of the thesis focuses on improving our knowledge and understanding of these previously unknown qualities. They are qualitative rather than quantitative unknowns, and hence become new principles. Newton (1730) criticized the Aristotelians precisely because they perceived that, “Forces and actions arose from qualities unknown to us,” and are thus presented as “incapable of being discovered and made manifest.” But Newton suggests that this “is to tell us nothing”. “But to derive two or three general Principles of Motion from phænomena, and afterwards tell us how the properties and actions of all corporeal things follow from those manifest principles, would be a very great step in philosophy”.

Therefore the identification of the following original principles from Aristotelian phenomena is considered the major original contribution of the thesis.

- ❖ Metatarsal cam.
- ❖ Ground reaction torque (GRT).
- ❖ Clinical amputation artifact.

²⁶ Since ‘our view’ here does not coincide with my view, this statement represents the view of the neo-Newtonian antithesis.

²⁷ Newton’s first law states “Every body will remain in its state of rest (thesis; first constraint) or continue in a state of uniform motion (antithesis; second constraint) unless compelled to changed that state by forces impressed.”

In Chapter 5 it is hypothesized that the *ground reaction torque*, a previously unknown energy transient—rather than a preconceived state of uniform motion—is the mechanical parameter upon which the anatomical form or design of the human bipedal skeleton depends. The presence of the GRT within the bipedal foot is verified by analyzing the anatomical structure of the human metatarsal arch. The relative sizes of the metatarsal and metacarpal bones in the feet and hands of several primate species including man, chimpanzees, a gorilla and an orangutan were compared.

The findings appear to confirm the novel hypothesis that the GRT, not the arch, is the defining characteristic of the human bipedal foot anatomy. The principle of the GRT is then combined with the MTP-1 cam action to explain the anatomical cam and cruciate ligament structure of the knee. The fact that the knee is also a cam affords us with the opportunity to generalize the anatomical cam and cruciate principles developed for the great toe to the whole body.

In Chapter 6 the GRT is examined directly at its source on the ground. Much additional new information is obtained by coupling a static description of the initial stance phase on a 0.5m pressure plate with a dynamic description obtained from a 2m plate. A novel method is developed to determine various mathematical characteristics of the footprint under dynamic conditions. The output from a pressure sensor array is acquired for the two footprints of initial stance period and the first three steps thereafter in 54 active subjects, using for the first time²⁸ the following parameters:

- ❖ Timing of foot contact, divided into ten anatomical regions including the great toe.
- ❖ Instantaneous principal axes of the footprint.
- ❖ Vertical impulse.
- ❖ Horizontal surface shear.
- ❖ Radius of gyration (RoG), which is a measure of foot stability.

The appendices describe some of the computer user interface panels of the LabVIEW ® programs constructed to process and display the data.

Chapter 7 contains a synthesis of all the information. A basic requirement of a free body diagram is the complete isolation of the chosen body. An imaginary three-dimensional box is constructed around the MTP-1 joint. The sagittal side of the box is formed by the cam. A cross-section through the metatarsals taken from chapter 5 forms the coronal view and the pressure plate data from chapter 6 forms the superior view. This box completely isolates the MTP-1 from its surroundings. It also demonstrates how the sum of the various parts of the thesis contributes to the whole picture.

The thesis ends by explaining how the novel metatarsal cam acts as an original alternative to existing anatomical arch descriptions of the foot held together by the plantar aponeurosis tie-rope or windlass cable. At the end of the day one should have a greater respect for the considerable insights that were afforded by Aristotle, but foiled in the end by an unjustified desire on the part of our antecedents to attach an elevated hierarchy of reasons for things being the way they are.

²⁸ European Patent Application No. 00200568.4-1265. *A method and apparatus for determining a flexural property of a load applied to a discretely sampled pressure sensor array.*

2. VIEWS AND REVIEWS

“Einstein may have changed the way in which we view the universe, but our view of the human body is still essentially Newtonian.” — Peter Cavanagh¹

2.1 VIEWS OF THESIS

Ever since Braune and Fischer’s pioneering work (1896-1904) empiricists have used a combination of finite time interval photography² and Newton’s classic laws of motion to study gait. But with limited success.³ Zeno of Elea (470BC) of course had anticipated this in a famous paradox.⁴ Any analysis of motion that begins by assuming finite time intervals, cannot explain precisely how motion starts or ends. Authentic philosophers correctly point out that starting and stopping is not actually an empirical problem at all. One philosopher has scrutinized the logic of starting a car for example.⁵ Another has even tried to explain the relationship between wiggling the toes and starting a car.⁶ Yet few have explained precisely how wiggling the toes may be related to starting to walk.⁷

2.1.1 THE ANCIENT VIEW—ARISTOTLE’S ANIMA

For eons a ghost-like soul, an *anima* or *pneuma* was thought to control the movements of man and animals. But by the beginning of the twentieth century the empirical onslaught of classical mechanics caused William James to concede that souls were out of fashion. McDougall (1911) nevertheless argued that certain aspects of ancient animism were indeed defensible on purely mechanical grounds unaware that Einstein (1905) had already revealed that the axioms of classical mechanics were only a special case of a much broader reality. But this unusual 20th century account is tantamount to putting the horse before the cart.⁸ The rational search for seat of the soul, effectively starts with Aristotle’s *de Anima* because as he explains:

“The soul is the cause and *first principle* of the living body...being that from which the movement itself is derived.” (*de Anima II.4*). “There are two distinguishing characteristics by which people mainly define the soul; motion in respect of place; and thinking, understanding and perceiving.” (*de Anima III.3*).

Aristotle’s motion in respect of place, is described in *On the movement and progression of animals*. But only the actual source of voluntary movement need concern us here.

“The sources of movement [are] desire and practical thought. The object of desire is the *starting point*...The instrument by which desire produces movement is something bodily. Hence it must be investigated amongst the functions common to the body and soul.” (*de Anima III.10*).

¹ *Biomechanics of Distance Running*, Peter Cavanagh, (1990) p.8.

² Commonly referred to as *animation*.

³ Cavanagh (1990) p.31.

⁴ See Zangari (1994), Honderich (1995).

⁵ *Starting and Stopping*, Hamblin (1963).

⁶ *Toe wiggling and starting cars: a re-examination of trying*. Green (1994).

⁷ Bojsen-Møller and Lamoreux (1979); Mann and Hagy (1979); Hughes, Clark and Klenerman (1990).

⁸ The transposed form of the metaphor is used here to emphasize the modern biomechanical propensity to prioritize the laws of *mechanics* (the cart) over those of *animate biology* (the horse).

Remarkably, Aristotle identifies the body component we seek—the anatomical instrument of the anima:

“To speak in summary fashion for the present—that which produces movement instrumentally is found where a beginning and end are the same, e.g. in the hinge joint; for there the convex and concave are respectively the end and the beginning of the movement (hence the latter is at rest and the former moves), the two being different in definition, but spatially inseparable. For everything is moved by pushing and pulling; hence as in a circle, one point must remain fixed and the movement must begin from this.” (*de Anima III.10*).

Thus the *hinge joint* becomes the seat of Aristotle’s locomotor soul. Newton’s third law of motion⁹ applied to empirical data (Mann et al., 1979) directs our attention specifically to the hinge joint of the MTP-1 situated in the great toe. Then as we shall see, Aristotle’s unmoved mover, the universal *animation instrument*, becomes the fixed concave seat of the proximal phalanx upon which the convex head of the first metatarsal bone articulates.

Fortuitously, the mechanism implicated by this novel synthesis of Aristotle’s animation and Newton’s mathematical principles—a synthesis I refer to as mathematical animation—has already been measured as part of a previous dissertation (Nevin, 1995). The bipedal movement, and hence the thesis begins from this.

2.1.2 THE EMPIRICAL VIEW

Morton (1952) studied cinematic photographs of men starting to walk from a standing position. The heel, he observed is not initially lifted up by the calf muscles as is commonly anticipated because the line of action of the soleus and gastrocnemius would cause the body to fall over backwards. I concur that it is “self-evident, that some other force other than muscle action is responsible for the initiation of the forward movement.” He attributed this to gravity acting in a helpful manner at the level of the hip. Morton’s extensive insights remain however largely unknown because they are rarely reviewed or cited in subsequent studies.

Following chronologically, Carlsöö (1966) did indeed observe the initial slacking of the soleus muscle through quiescent electromyographic (EMG) signals. However these early observations do not appear to have set a trend (Basmajian, 1976). Carlsöö’s article is also the earliest of a fairly comprehensive series of 22 articles reviewed by Halliday et al. (1998). Force plates were used in 21 of these, EMG electrodes in 11, cameras in 9, electrogoniometers in 3 and accelerometers in 2. The choice of these methods indicates that gait is most often studied using Newton’s principles,¹⁰ and presupposes, through the use of EMG, that gait is widely believed to be under active neuromuscular control—both models that will later be associated with the antithesis.

Mann et al. (1979) appear to be the first to plot the initial path of the center of pressure [Fig. 1-1]. This basic pattern is reported by other authors (Breniere and Do, 1986) and is found in young, elderly and Parkinson’s diseased subject groups (Halliday et al., 1998). But the *complete* starting phase from the initial stance to the third step, after which most authors consider gait to be fully developed (e.g. Miller & Verstraete, 1996) has not apparently been studied using pressure plates.

⁹ Newton’s third law is in fact redundant because Aristotle uses a similar principle in his text *on the progression of animals*.

¹⁰ The definition of force stems from Newton’s *second* law or axiom (Newton, 1687).

2.2 HYPOTHESES

2.2.1 BIOMECHANICAL HYPOTHESIS—THE BODY ACTION FORCE

Almost all mathematical gait analysis is governed by the implicit biomechanical postulate “Newton rules biology”. Newton’s *first* law or axiom of motion simply states that:

“Every body continues in its state of rest, or of uniform motion in a right line, unless it is compelled to change that state by forces impressed upon it.”¹¹

Newton specifies that to change from a state of rest, forces need to be impressed on the body. However in his definitions¹² he provides examples of only three types of impressed force:

“But impressed forces are from different origins, as from percussion, from pressure, from centripetal force.”

Newton does not limit us to only these examples. Therefore Newton’s first law serves as a foundation for three hypotheses:

- ❖ Postulate a *voluntary impressed* or self-animation force, the *original bipedal body action force*.
- ❖ Measure directly the *gravitational percussion* and *pressure* as gait starts.
- ❖ Remove all known and unknown impressed forces including percussion, pressure and the gravity centripetal force from the analysis, thus leaving the body in a state of permanent rest.

The principle premise however also follows from the postulate of a body action force and Newton’s third law, which asserts that:

“To every action there is always opposed an equal reaction...directed to contrary parts”.

It is thus possible to deduce that the *ground reaction force* beneath the feet is the result of a casual *body action force*. Yet incredulously there is little or no mention of any such primary *body action force* in the literature.¹³ But if the human body is free to take some entirely voluntary action, like initiating gait from a state of zero inertia, it is difficult to determine which internal mechanism initially impresses the required forces *on the body*.¹⁴ Newton must have been well aware of this problem when he wrote:¹⁵

“The *Vis inertiae* is a Passive Principle by which Bodies persist in their Motion or Rest, receive Motion in proportion to the Force impressing it, and resist as much as they are resisted.¹⁶ By this Principle alone there could never be any Motion in the World. Some *other* Principle was necessary for *putting Bodies into Motion*: and now that they are in motion, some *other* Principle is necessary for *conserving*¹⁷ the Motion.” But he “scruple[s] not to propose the Principles of Motion above-mention’d,” leaving “their Causes to be found out.”¹⁸ [my emphasis].

Clearly a principle *other than Newton’s three laws* has to be included to solve the problem of initiating gait.

¹¹ Motte’s 1729 translation of the *Principia*, revised by Cajori, 1934.

¹² Definition IV, *Principia*.

¹³ The closest is the *Vis vitae*; the living (moving) force that later metamorphosed into kinetic energy.

¹⁴ Essentially the internal mechanism of the human body *is* the body and thus subject to equal and opposite reactions. An equal and opposite action and reaction by and on the contrary body parts of muscle and bone result in no net force and hence no acceleration in terms of Newton’s second law; i.e. the body remains permanently at rest. Therefore Newton’s third law is merely a confirmation of his first constraint on the action of ‘every body’. This cyclic definition can only be accessed by the intrusion of an arbitrary impressed force.

¹⁵ *Opticks*, Query 31.

¹⁶ This single ‘Principle’ is a composite of Newton’s three laws.

¹⁷ Newton recognizes in the *Opticks* that “Motion may be got or lost” by rotating a body in uniform translation. Motion is also lost when meeting bodies “go on and penetrate one another’s dimensions.”

¹⁸ *Opticks* (1952), p.399.

SUMMARY OF BIOMECHANICAL HYPOTHESES

- ❖ If the human *body initiates action* like starting to walk, there must be an *initial ground reaction* exactly in the opposite direction.
- ❖ The retrogression of a quantifiable *ground reaction force* clearly implies that a *body action force* is the progressive motivation behind the movement.
- ❖ Preliminary data indicates that any such body action force is initially aligned with a specific anatomical structure, the *first metatarsophalangeal joint* (MTP-1) of the great toe of the *stance* foot [Fig. 1-1].¹⁹
- ❖ The beginning of motion occurs in the hinge joint as described by Aristotle.

2.2.2 ANATOMICAL HYPOTHESES

1. First Metatarsophalangeal Joint Arch Raising Function.

The biomechanics of the MTP-1 were originally described by Hicks (1954) who observed that:

“In a normal living foot that is weight-bearing, as in ordinary standing, passive extension of the big toe at the metatarso-phalangeal joint will be observed to result in the following effects:

- (i) the arch appears to rise;
- (ii) the posterior part of the foot assumes an ‘inverted’ position (supinates);
- (iii) the leg rotates laterally;
- (iv) there appears a tight band in the region of the plantar aponeurosis.”

Hicks deduced that the metatarsal head acts as a windlass, the drum of a winch around which the plantar aponeurosis winds.²⁰ When the great toe is dorsiflexed, the plantar aponeurosis draws the heel and forefoot together, apparently raising the arch of the foot. Furthermore:

“An attempt to oppose this [arch raising effect] will reveal that—so long as metatarso-phalangeal extension is achieved—the downward shift of the metatarsal head is irresistible.... This [irresistible downward shift of the first metatarsal] disappears when the toe is allowed to flex.”

The *irresistible* downward shift of the metatarsal head is a phenomenon that, if resisted by the ground for example, would indeed compel the arch to rise. Passive arch raising, however cannot occur without an implicit contravention of the *first law* of thermodynamics in terms of which all energy can be equated or reduced to the raising of a weight in a gravity field.²¹ Application of the *second law* of thermodynamics (Atkins, 1984) reveals ultimately though that no passive body will spontaneously raise itself up against gravity.

Hick’s (1954) thus correctly observed that the arch only *appears* to be raised by passive means. The metatarsal arch in Hick’s model is theoretically crushed between an *irresistible downward force* and an *upwardly immovable object*. Hence the other effects mentioned by Hicks—namely supination of the foot and external rotation of the tibia—become the prime focus of the thesis.

¹⁹ The line of action of the body action force also passes through the swing heel at the other end, where Morton (1952) and Carlsöö (1966) noticed the relaxation of the muscles. New data on the double stance phase will show that this does not conflict with the premise of the thesis.

²⁰ The plantar aponeurosis is a broad band of fascia, a ‘cable’ found in the sole of the foot stretching between the calcaneus and the toes.

²¹ The first law of thermodynamics is the law of conservation of energy. Originally stated as follows by James Prescott Joule in a 1847 lecture *On Matter, Living Force and Heat*: “You see, therefore that living force [kinetic energy] may be converted into heat, and that heat may be converted into living force, or its equivalent attraction through space [gravitational potential energy]...We can therefore express the equivalency in definitive language applicable *at all times and under all circumstances*.” (Olenick et al., 1985, p.245). My emphasis.

2. Osseo-Ligamentous Control of the MTP-1.

A second anatomical hypothesis follows directly from another observation by Hicks (1954). The passive extension of the MTP-1, which apparently raises the arch, does not require *muscle activity*. He explains:

“No muscle is directly concerned in the mechanism which is entirely bony and ligamentous, the work of raising the arch being done usually by body weight....The concept that emerges is that the action is not necessarily the result of the arch raising muscles but is a movement that must occur in every foot, even if dead or paralytic, every time the toes are extended.”

Independent dissections of the dead (Arthornthurasook and Gaew, 1990) indeed support Hicks thesis because there are no superior muscle attachments capable of raising the first metatarsal bone directly. The only muscles that might raise the arch are tibialis anterior (TA) and the toe extensors. TA however inserts mostly onto the medial cuneiform bone, with only a minor communication to the first metatarsal.²² The toe extensor tendons all bypass the metatarsals to insert directly onto the phalanges.

The main muscle attached to the first metatarsal is peroneus longus (PL). This is a powerful foot pronator that runs diagonally under the foot²³ [Fig. 2-1]. Additional but minor muscle attachments such as the first interosseous all reveal that the primary metatarsal function is a *twisting rotation* about its long axis.²⁴ There is also a remarkable antagonistic arrangement between osseo-aponeurotic supination induced by passive hallux dorsiflexion and the *neuromuscular* pronation induced by PL.

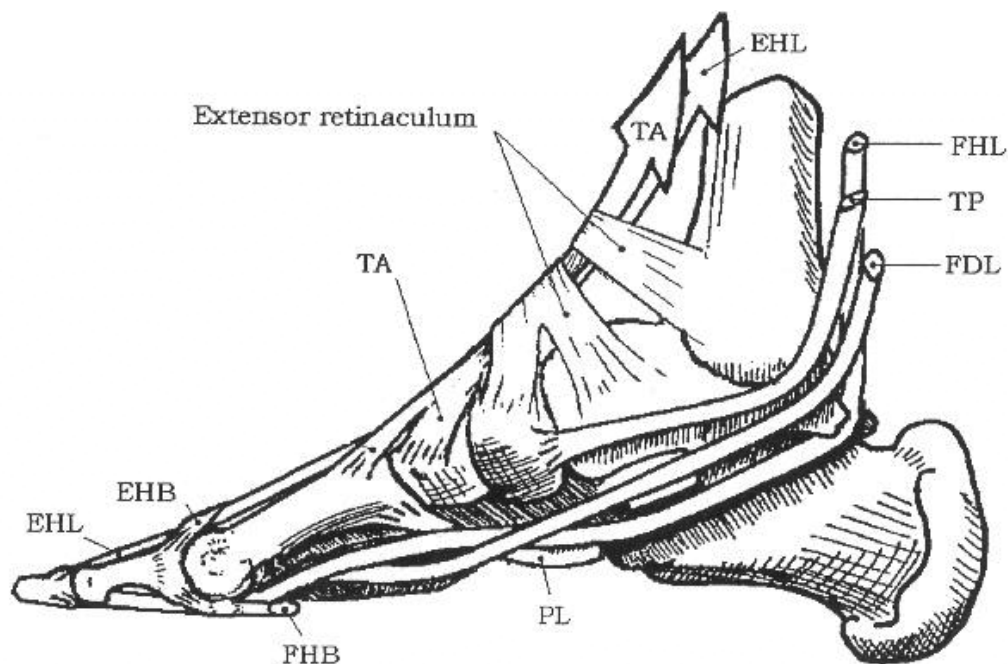

Fig. 2-1. The long ‘bootstrap’ muscles of the great toe (Nevin, 1995).

²² The term ‘bootstrap muscles’ is used because (1) the position of the insertion; (2) the task of raising oneself up by one’s own bootstraps is an impossible one.

²³ Pronation is defined as the inward roll of the first metatarsal, supination as the outward roll; roll being defined here as a log rolling action.

²⁴ A small interosseous spans the first metatarsal space, causing the second metatarsal to pronate and the first metatarsal to supinate. It has origin on a slip of Peroneus Longus (Kalin and Hirsch, 1987) which suggests that it’s primary role is proprioceptive.

Several of the big muscles that attach to the great toe are flexors; e.g. flexor hallucis longis (FHL), flexor hallucis brevis (FHB) and abductor hallucis (ABH).²⁵ However *despite* their great size and nomenclature, these muscles *do not* actually flex the hallux during gait [Fig. 2-2]. I hypothesize therefore that these muscles may have a different role, which is easily explained by postulating a new *anatomical origin* for the leg muscles in the toe.

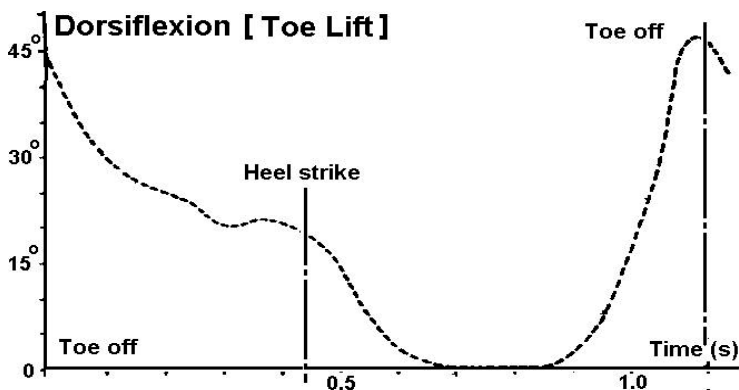

Fig. 2-2. First metatarsophalangeal joint angle during walking (Nicol, 1987).

Anatomical conventions dating back to Aristotle stipulate a *fixed proximal origin* and *mobile distal insertion* for muscle.²⁶ Hypothetically it is possible to reverse this convention by a simple exchange to a distal origin and proximal insertion. The toe muscles would then have their *origins in the toes* and insertions in the foot or leg. The muscle sizes (but not their names) would then be more appropriate because they would then move the massive upper body insertion rather than the miniscule great toe.

Because I locate the original soul (anima) in the MTP-1, it is logical to define the muscle origin here as well. It also resolves what many see as the obvious failing in Aristotle's philosophy that caused him to locate the source of movement in the heart not the brain. But I contend that the location in the heart (cardio-respiratory origin) or the brain (neuromuscular origin) is equally unlikely in terms of the osseo-aponeurotic origin of movement relocated down in the toe rather than up in the brain.

3. The Instantaneous Joint Center of the MTP-1.

Sammarco's (1980), Shereff et al. (1986) and Hetherington et al. (1989) all describe the motion of the *phalanx* relative to a stationary metatarsal. Sammarco (1980) show the phalanx potentially moving into the ground [Fig. 2-3]. But the goniometer data of Nicol (1987) shows that the MTP-1 does not plantarflex at all during walking. A better description of MTP-1 motion is required.

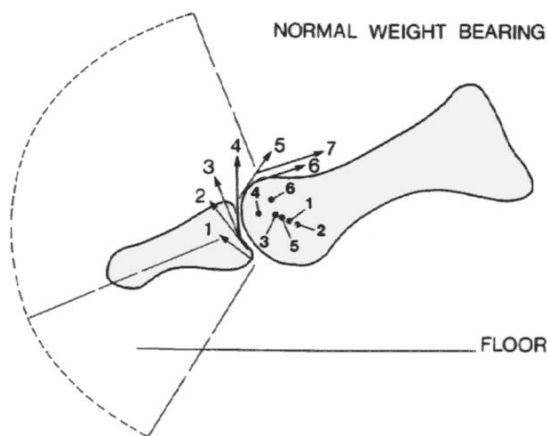

Fig. 2-3. Phalanx motion (Sammarco, 1980).

²⁵ Despite its name, Abductor Hallucis, has insertions that are positioned to act principally as flexors.
²⁶ Movement of animals.

Although there is a dire need for a biomechanical joint center to calculate moments and angles for joint function, no obvious joint center appears to exist in the MTP-1.²⁷ This novel yet fundamental “no-joint-center” hypothesis which is based on observable phenomena, is the antithesis of all the biomechanical models that depend on fixed joint centers between rigid segments.²⁸

4. The Key Action of the MTP-1.

Passive osseo-ligamentous great toe dorsiflexion irresistibly supinates the foot (Hicks, 1954), which is inexorably linked through the skeleton to lateral the rotation of the tibia (Olerud and Rosendahl, 1987) through the mitred hinge of the ankle [Fig. 2-4]. However, any explicit connection between the motion of the toe and the mechanics of the knee is rarely if ever made in the literature.

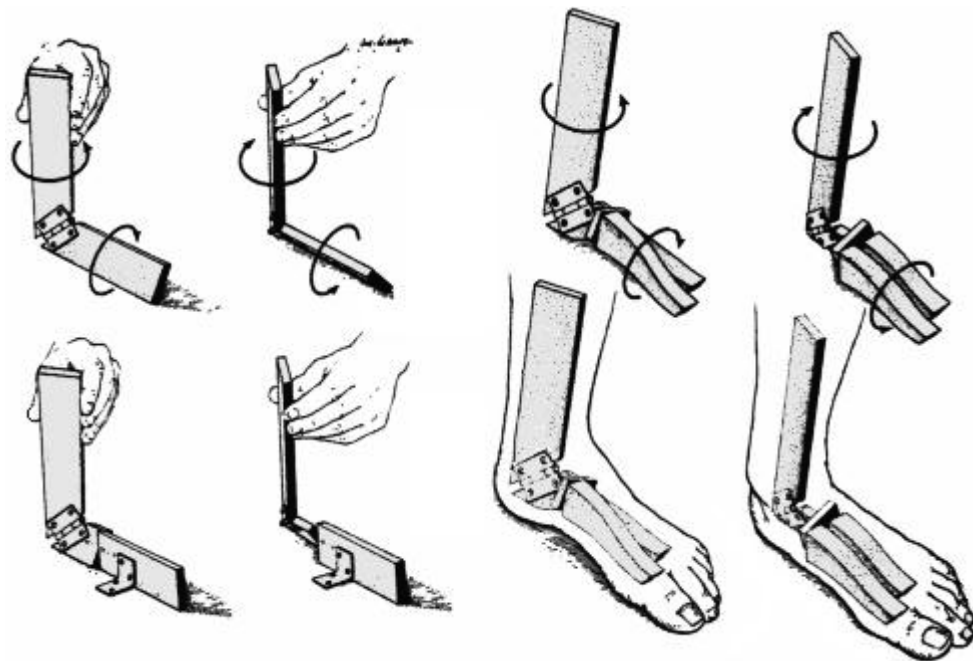

Fig. 2-4. The mitred hinge of the ankle (Inman et al., 1981).

The reason I believe is simply that the foot bones appear to “form” an arch and therefore are, incorrectly I suggest also assumed to “function” as an arch. The *form* of the arch presupposes a static weight-bearing *function* for the bones of the foot. Consequently most papers on foot biomechanics emphasize the *arch* and its so-called “supporting” soft tissue structures. Few authors envisage any *active* or *dynamic* function for the foot bones.²⁹

In general medial rotation of the tibia—here induced by great toe dorsiflexion—tends to lock the knee open, lateral rotation tends to lock it closed. But it appears to be a novel hypothesis that the supination of first metatarsal bone, can be envisaged as the rotating *key* mechanism. Specifically, when the MTP-1 is activated under passive dorsiflexion, the metatarsal literally acts as the physical *key bone* that dynamically rotates in supination to *lock* and/or *unlock* the knee cam.

²⁷ Strictly speaking the ‘observation’ of a non-existent quality, is in fact a rejection of the positive antithesis. This observation is thus the primary dialectic hypothesis of the biomechanical thesis.

²⁸ Rene Descartes (1644) quotes Archimedes the father of classical mechanics as saying, “give me a point (both) fixed and mobile and I shall move the earth”. The implicit corollary is that given a hypothetical fixed and mobile point such as a biomechanical joint center, one should then anticipate the movement of the earth. An environmental hypothesis that has been omitted under advisement because it cannot be linked conclusively to MTP-1 activity except through the postulate that metatarsal bone breaks when clamped.

²⁹ The hypothesis that the foot is not actually a static arch was a conclusion of my paper, “The first metatarsal: the ‘Rosetta Bone’ of human bipedal evolution?” In: Programme and abstracts, 27th Annual Congress of the Anatomical Society of Southern Africa, Cape Town, 1997.

5. The Cam Action of the MTP-1.

I have previously developed and described a novel method of imaging the *relative rotations* of the toe bones of the MTP-1 (Nevin, 1995-1997) where a *cam-like* behavior of the normal first metatarsal was identified for the first time [Fig. 2-5a]. Shigley (1977) suggests that:

“The use of cams to convert rotary motion into reciprocating motion is well known. In fact, one or more cam-and-follower mechanisms can be found on almost any machine we care to inspect. These cams perform such important functions in many cases that the behavior of the entire machine is dependent on the design of the cam motion.”

Cams are used primarily used as timing and control mechanisms. They are not often used directly for power or energy transfer such as a windlass, which is Hick’s preferred model of MTP-1 function. It is certainly a novel proposal to use a single solid fixed cam [Fig 2-5b] to replace the mobile phalanx, MTP-1 and metatarsal unit, to form a fixed forefoot arch buttress that has the same dynamic characteristics of the mobile MTP-1.

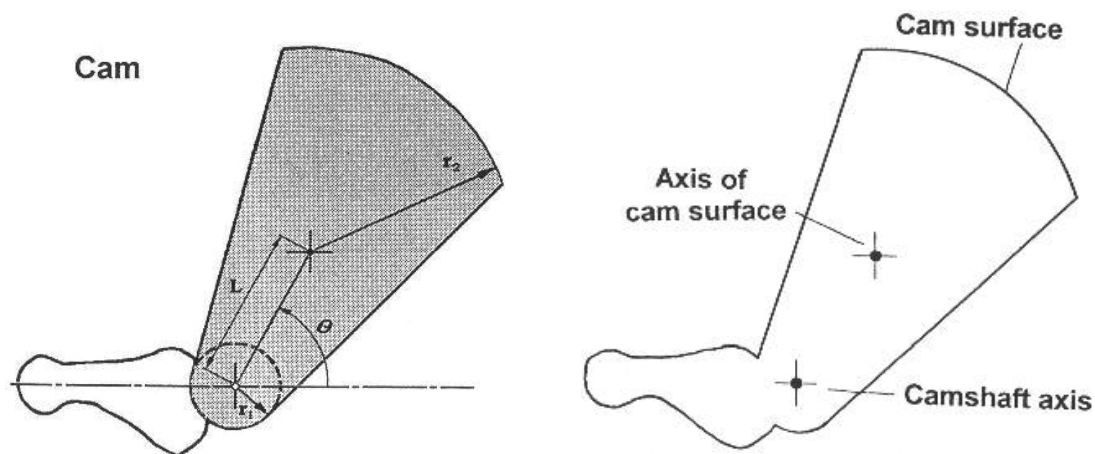

Fig. 2-5. Metatarsal cam in normal MTP-1 (Nevin, 1997).

In my 1997 article I furthermore hypothesize, based on the data, that the generic biomechanical hinge-joint model may be better associated with dysfunction and amputated MTP-1 joints rather than normal MTP-1 joints. The descriptions of the metatarsal cam and dysfunctional hinge models [Fig 2-6] are extensions of my previous work that serve as the observational substrate for the present thesis.

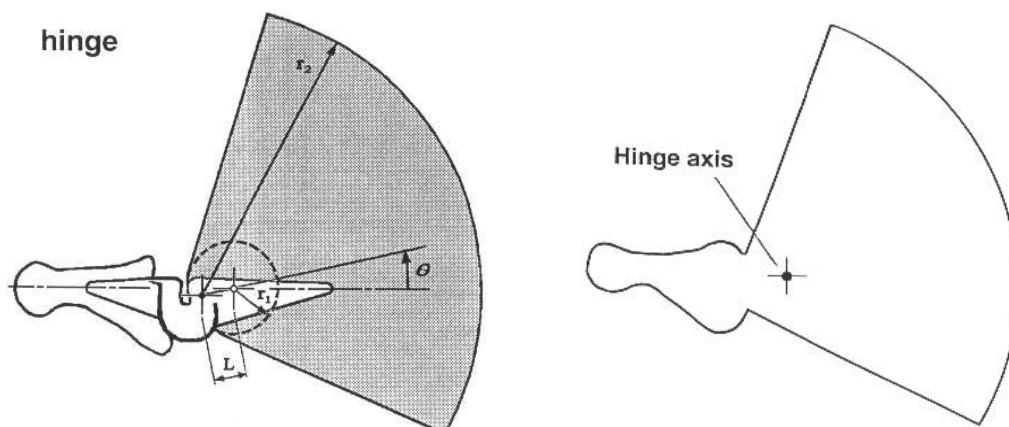

Fig. 2-6. Metatarsal hinge in dysfunctional MTP-1 (Nevin, 1997).

The great toe cam mechanism can only be passively activated by body weight if the heel is raised to enable great toe dorsiflexion. With the toe flexed the knee must also be flexed if the leg is to support weight. The “no-joint-center” hypothesis also tentatively applies to the knee joint which is more obviously a cam [Fig. 2-7] (Soudan et al., 1979; Panjabi et al., 1982). The potential interaction of the toe and knee cams has not been described in the literature. Even though the interaction can be deduced from the motions of the intervening joints.

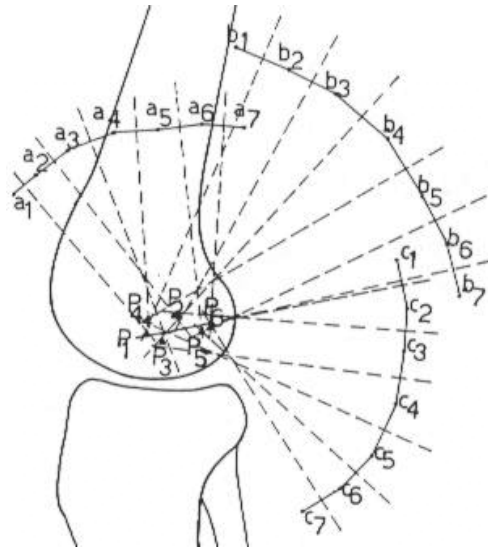

Fig. 2-7. Cam action at the knee.

SUMMARY OF THE ANATOMICAL VIEWS OF THE THESIS

- ❖ The MTP-1 joint is implicated in the *initiation of gait* by the initial direction of the progression of the center of pressure from a standing posture.
- ❖ The MTP-1 is implicated in the *dynamic control of gait* via the inherent dynamism of the anatomical form of the *rotary locking cam and key action* of the great toe and the knee.
- ❖ The *scope* of the thesis is naturally confined to the anatomy below the knee because of the complementary anatomical mechanisms.
- ❖ The first metatarsal physically acts as a dynamic *key bone* in the foot, functioning by rotating in supination rather than functioning as a static *key stone* in an arch.
- ❖ The *static arch model* of foot function and the *rigid hinged-segment* model of the foot and leg are misleading and can be replaced by a fixed *dynamic cam model*.
- ❖ The biomechanics of the MTP-1 are principally osseo-aponeurotic rather than neuromuscular.
- ❖ The functional *anatomical origin and insertion* of the toe and foot muscles have to be swapped from the proximal to the distal end.

2.3 REVIEWS OF ANTITHESES

2.3.1 OVERVIEW—NEWTON RULES BIOLOGY

Cavanagh (1990) speaks for most when he writes that “Einstein may have changed the way in which we view the universe, but our view of the human body is still essentially Newtonian.”³⁰ I categorize this common cause, the “our view” of the *philosophical antithesis* under the dictum “Newton rules biology”.³¹ The presumption is that Newton’s axioms of motion were somehow approved for animal applications after their first appearance in 1687 but insufficiently refuted by Einstein after 1905.

Certainly for the sheer *quantity* of experimental content the above view is valid. Any reader in biomechanics will attest that almost all gait analysis nowadays is implicitly linked to the axioms of motion in the *Principia*. But I contend that this *experimental quantity*³² is undermined by its *philosophical quality* because all of Newton’s biomechanical hypotheses are found in the *Opticks*, not the *Principia*. Few if any authors abide by the *limitations* that Newton himself placed on these laws.

2.3.2 NEWTON’S VIEW

It is my thesis that Newton’s view is different to that implicitly attributed to him via his mathematical principles because there is little or no mention of any application to animal motion in the *Principia* until the *very last* paragraph where he writes:

“And now we might *add* something concerning a certain most subtle spirit which pervades and lies hid in all gross bodies; by the force and *action* of which....the members of animal bodies move at the command of the will, namely by the vibrations of this spirit, mutually propagated along the solid filaments of the nerves, from the outward organs of sense to the brain, and from the brain to the muscles.” Newton then immediately concludes, “But these are things that cannot be explained in a few words, nor are we furnished with that sufficiency of experiments which is required to an accurate determination and demonstration of the laws by which this electric and elastic spirit operates.”

By *adding* these comments in the *concluding* sentences of the *Principia*, he implies that the subject of animal motion has not been addressed in this text. He also attributes animal motion to vibrations of a subtle spirit. A medium he clearly excluded in the *very first definition* of the *Principia*.³³ Newton also points out that the *laws* of animal motion *had yet to be accurately experimentally determined and demonstrated*. Therefore I regard modern biomechanical philosophy as a neo-Newtonian embodiment based only on Newton’s wishful thinking.³⁴

Newton’s first actual biomechanical hypothesis appears as Query 24 of the *Opticks* (Newton, 1717):

“Is not *Animal motion* performed by the Vibrations of this [Ætherial] Medium, excited in the Brain by the Power of the Will, and propagated from thence through the solid, pellucid, and uniform Capillamenta of the Nerves and the Muscles, for contracting and dilating them?” [my emphasis]

³⁰ The references to “we view” and “our view” here are not inclusive of the thesis. Therefore these are views of the antithesis.

³¹ *Newton rules biology*, Pennycook (1992).

³² I do not question the *experimental quality* of modern biomechanical research. On the contrary I uphold the principle that all the data is valid and that none should be rejected.

³³ “I have no regard in this place to a medium, if any such there is, that freely pervades the interstices between the parts of bodies.” Definition I, *Principia* (1726).

³⁴ Newton (1687) in a scholium limited his model *to*: “the motions of the planets, the comets, the moon, and the sea.” But immediately added that, “I *wish* I could derive the rest of phenomena of Nature by the same kind of reasoning from *mechanical principles*...or from some *truer method of philosophy*.” [my emphasis]

Despite the vast body of modern literature claiming to be Newtonian, there is almost no mention of Newton's hypotheses of a vibrating 'Ætherial Medium' the primary action of the 'Power of the Will' and even less regard for Newton's thoughts on a potentially 'truer method of philosophy'.

1 Ætherial Medium

Newton likened his spirit medium or æther "to air in all respects, but far more subtle".³⁵ But confessed he did not really know what it was.³⁶ The explicit rejection of the luminiferous æther hypothesis by Einstein in 1905, has had little impact on gross anatomy³⁷ because of the quantitative association to the speed of light.³⁸ It is ironic that modern researchers ignore Newton's æther as an explanation of animal motion, while at the same time claiming no use for Einstein's theory that actually provides the only mathematically and experimentally verified substitute for Newton's æther.

I find the historical explanations evoked to "save the æther" by Fitzgerald (1892) and later Lorentz therefore intriguing because of their potential to save Newton's *neural æther*. Einstein and Infeld (1971) recognized that classical physics reduced the problems of motion to a few essential difficulties.³⁹ Biomechanical comparisons I proactively venture without in-depth discussion include:

- ❖ A standard biomechanical metric via the concept of *rigid body* segments;
- ❖ *Instantaneous* centers of joint rotation between rigid segments;
- ❖ Mechanism of *agreement/disagreement between observers* given different frames of reference;
- ❖ The improvements in animation in a 4D kinematic continuum (Ariel et al., 2000).

In summary, I believe the use of fixed-length rigid segments as the implicit biomechanical metric leads to an intrinsic *lack of agreement* between observers as to the position of the *instantaneous* joint center. But whether these effects all sum to a *neural æther* I leave as an open question.

A much neglected area of research is the mechanics of *relative rotations* rather than *uniform translations*.⁴⁰ Briefly, I contend that the *relative rotations* of the toe bones about an intractable *instantaneous* joint center between variable length foot and leg segment, currently assumed to be *rigid rods*, possibly stem from the non-linear cam-like behavior of biomechanical joints that form the starting point of the experimental thesis.

2. Power of the Will

Newton's æther hypothesis is linked directly to his hypothesis of the Power of the Will. Newton's hypotheses of animal motion however were probably discarded after a key experiment by Luigi Galvani (1791).⁴¹ Galvani tied the sciatic nerve of a decapitated frog to a metal railing during an electrical storm, reducing Newton's Power of the Will hypothesis from an all-powerful spirit resident in

³⁵ Letter to Boyle, February 28, 1678/9, (Cajori, 1934).

³⁶ "for I do not know what this Æther is", Query 21, *Opticks*, 1730.

³⁷ Einstein, interesting enough, does not explicitly reject the neural æther, merely the luminiferous æther.

³⁸ The materials of biological bodies differ from the electrodynamic structure of space and time that Einstein described in terms of electrodynamics of moving bodies. Few scientists acknowledge the possibility of a similar description applying to the elastodynamics of other moving aetherial media such as the neural aether indicated by Newton.

³⁹ Features of special relativity are that (1) rigid measuring rods appear to change their length, dependant on the state of the observer, (2) simultaneous events are not instantaneous to all observers, (3) motion is conserved in accordance with the Lorentz transformation of Reiman's 4D metric, rather than a Galilean transformation of the 3D Euclid's geometry. Special relativity predicts the equivalence of mass and energy. General relativity predicts the equivalence of inertial and gravitational mass. General relativity applies *to all frames of reference* not just those moving uniformly. The direct application of general relativistic model to 4D animate joint motion unfortunately exceeds the scope of this thesis and is thus omitted under advisement even though 4D animation techniques offer decided advantages over 3D methods.

⁴⁰ The theoretical impracticality of studying the *relative rotation* of a large inertial body around a small one is reportedly a matter of speculative cosmology (see Kittel et al., 1973, pp.110-111).

⁴¹ *De Viribus Electricitatis in Motu Musculari: Commentarius*.

the heavens to a mundane *electric* discharge.⁴² The brain, according to this substitution, uses structures and processes that are not well known to somehow initiate and distribute bio-electronic action potentials to the muscles, which act in some highly coordinated, but still poorly understood manner to induce a walk.⁴³

Galvani's lightning experiment in practice altered the problem of initiation and control of animal motion from control of a divine power, to one of neural *coordination* of electrical impulses generated in the brain. It may seem obvious to many now that the brain rather than a passing electric storm generated by a controlling heavenly will, organize and coordinate the so-called electro-biochemical *action* potentials which drive the muscles at appropriate times to animate the skeletal marionette.

But the problem is that EMG experiments of Basmajian (1974) and others show that these impulses do not arrive exactly where anticipated (Basmajian, 1976). Also the ubiquitous muscles are not correctly positioned in the foot to do some of the obvious functions assigned to them (Morton, 1952). Particularly if rigid segment hinged models like Inman's marionettes are used [Fig. 2-10].⁴⁴

Hill (1970) amongst others demonstrated from thermopiles that nerve impulses did not provide the actual physical *motive power* like an electric motor. He therefore assumed that the nerves were for control signals, and that the power came from muscle itself. The muscles became heat engines functioning on metabolic fuel from aerobic and anaerobic pathways, and the control from the neural system.⁴⁵ This physiological model shifts the original power back to the heart, the muscular motor of the cardio-respiratory system that is in perpetual motion.⁴⁶

3. Neo-Newtonian Review

The modern Newtonian biomechanical model does not appear to be based on Newton's views of animal motion at all, if ever. Cavanagh (1990) considers Fischer's work seminal because he writes,

“With minor changes, the methods formalized by Braune and Fischer are almost exactly those used by today's investigators” (p.22). Although, “When reviewing the history ... it is hard to escape the verdict that despite the tremendous advances in computing power and instrumentation ... we are basically still trying to answer many of the questions posed by Fischer ... 90 years ago” (p.31).

Fischer's work of 1904 (Braune and Fischer, 1896-1904) was published only one year before the demise of Newtonian physical science.⁴⁷ Nowadays unlike in Newton's lifetime, biomechanical data is no longer the limiting constraint in gait analysis. Frederick (1985) in fact appealed for more *synthesis* of existing data. The focus of the thesis is therefore to provide a comprehensive *synthesis of data* rather than simply piling more biomechanical data onto shaky and overloaded philosophical foundations.

⁴² Atmospheric lightning is often seen as a symbolic demonstration of *God's Will*. Lightning is an extremely powerful electronic discharge. Hence Newton's philosophy of brain function involving the *Power of the Will* maps almost unnoticed onto the modern version of an electronic brain.

⁴³ The action *Of the Will* described by Descartes in *Passions of the Soul*, Article XVIII, is perhaps typical for the time. “we desire to take a walk, it follows that our legs move and we take a walk.”

⁴⁴ The author's implicitly recognize the difficulties with their model as can be seen from the drops of sweat emitted from the sprite at crucial times.

⁴⁵ The supply of oxygen, the living breathe or *pneuma*, should not be confused with Aristotle's *anima*. However Aristotle notes that the “connate *pneuma*...seems to bear the same relation to the psychic origin as the point in the joints, which moves and is unmoved, bears to the unmoved.” *Movement of animals*, 703a. Muscle physiology based on Thales *pneuma* unfortunately diverges too far at an experimental level from the Aristotelian hinge jointed *anima-soul* to demonstrate the synthesis here.

⁴⁶ Hill (1927, p85) briefly mentioned the ‘will’ in the context of the advanced central nervous system of the electric ray. A rare occurrence in modern biomechanical texts.

⁴⁷ After 1905 it cannot be argued correctly that Newton's laws are representative of all physical laws with respect to all observers—contrary to the position adopted by Van Ingen Schenau (1980). The position of the observer, is crucial to the interpretation placed on these results. A precise specification of the position of the observer (anatomical, mathematical, philosophical, and historical) is therefore essential.

SUMMARY OF NEWTONIAN REVIEW

I hypothesize that the apparent lack of theoretical progress since Fischer, despite the increase in computing power, is due to:

- ❖ A misapplication of Newton's *Principia* at the fundamental level of domains and definitions.
- ❖ Prioritizing without sufficient experimental evidence, the *second* constraint of Newton's first law (uniform motion) above the *first* constraint of the first law (the requirement of continuous rest).
- ❖ Ignoring Newton's explicit mechanisms and finer nuances incorporated in his hypotheses such as neural aether and Will.

2.3.2 GAIT AS UNIFORM MOTION

Human gait includes walking, running and sprinting when alternate feet act as the sole means of support. One amongst many perceived transitions, the initiation of gait from a standing start⁴⁸ is reportedly complete after three steps (Miller and Verstaete, 1996). Nissan and Whittle (1990) reported that the starting phase of gait is often neglected in scientific studies. Indeed it was Inman, Ralston and Todd (1981) who suggested that:

“The complete description should include how starting, stopping, changes in speed, alterations in direction, and modifications for changes in slope are accomplished. These events, however, are transitory activities that are superimposed on the basic pattern [moving at a constant or uniform speed]. *Nearly all studies of walking* have considered this basic operation, a *restriction that is appropriate...*” [my emphasis].

Yet, despite adopting the uniform motion postulate, the same authors had already recognized the contrary:

“The body *must* slow down and then speed up again during each step because the support provided by the legs does not remain under the body at all times. This motion is difficult to see but easy to sense when a person carries a shallow pan of water. It is *almost impossible* to prevent the water from surging backwards and forwards as a result of the alternating accelerations and decelerations of the body.” [my emphasis]

While apparently *appropriate* to describe walking as a constant translation, it is paradoxically *imperative* to consider walking as acceleration and deceleration. The possibility of analyzing gait as a continuum of overlapping starts and stops rather than a pre-existing smooth motion⁴⁹ is seldom entertained. This is despite all available evidence that the step to step fluctuation during a walk or sprint is about 10% of the speed [Figs. 2-8 & 2-9].⁵⁰

⁴⁸ For other starting postures see Baumann (1976); Gagnon (1978).

⁴⁹ Smooth motion is essentially perfect everlasting motion, essentially perpetual motion, and unobtainable ideal.

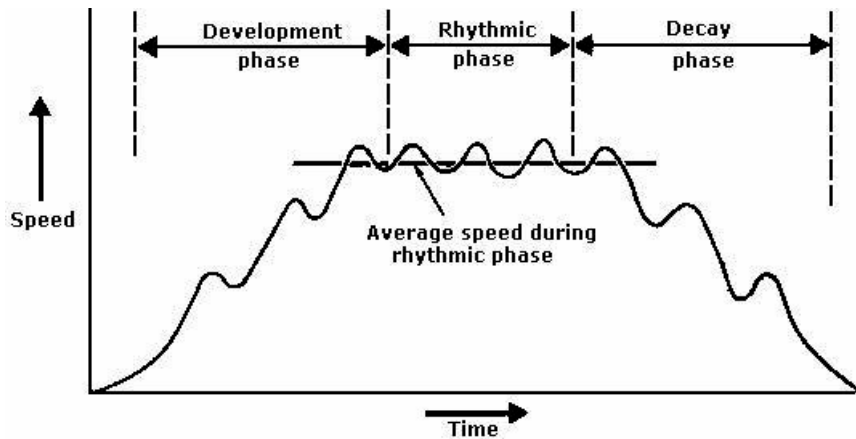

Fig. 2-8. Accelerographic analysis of pathological gait (Lette & Contini, 1967).

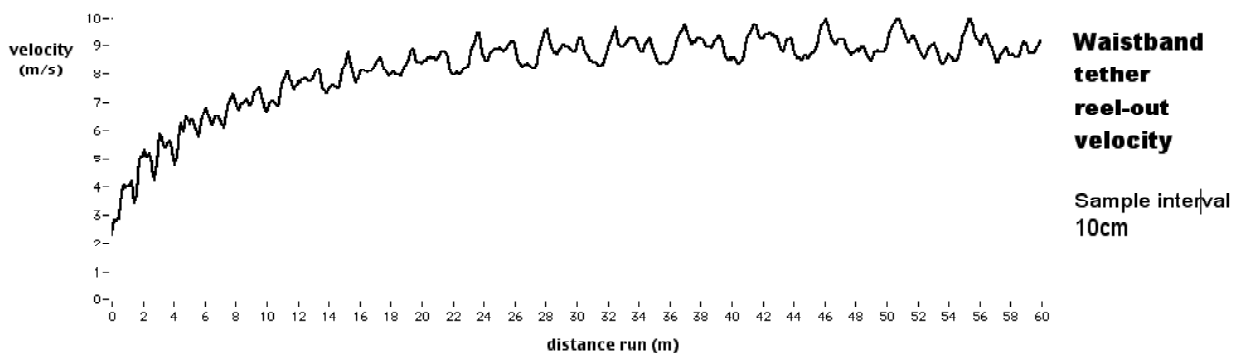

Fig. 2-9. A trained runner's speed sampled at regular 10cm displacement intervals during a 60m run using a rip chord attached to a waistband (R de Wit, personal communication).

Crucially, at no stage in any of these accounts does the anatomical subject achieve a state of uniform or constant translation. Newton's law however does not *stipulate* that uniform motion need exist, merely that *if it does exist* it may continue to exist. Sooner or later it is necessary to *experimentally* establish the validity of the uniform motion axiom.

Ralston (1960) made a cursory attempt to do so on a treadmill. He reported no significant differences between treadmill and overground gait but crucially failed to control for the physiological effect of oxygen debt accumulation.⁵¹ Numerous subsequent treadmill comparisons have reported at least one significant difference irrespective of method employed or primary variables assessed. Although Van Ingen Schenau (1980) made a partial attempt to do so on theoretical grounds, it is I contend impossible to justify the uniform motion postulate on the *observed* biomechanical evidence alone.

⁵⁰ The two examples chosen to illustrate this point are methods that do not use cinematic animation.

⁵¹ When his data is controlled for drift, a trend indicative of a difference is discernible.

2.3.3 GAIT AS POSTURE

Hypothetically Newton's first constraint of his first law of motion (continuous rest) leads to the biomechanical term *posture*. His second constraint (uniform motion) is likewise referred to as *gait*.⁵² But if one confines oneself to Newton's first constraint of his first law first—which is essential for a thesis based on first principles—then *gait* must be defined as a dynamic upright posture in a continuously constrained dynamic state of rest.

Then it is illogical to view the initiation of gait phase as a separate or subsidiary problem of gait itself.

The antithesis of uniform motion is I believe based rather on a characterization of gait according to Newton's *second* constraint. The semantic tangle is however only revealed when one tries to convert a resting standing posture into gait, because gait is already technically a constrained standing posture. Strictly speaking *walking* for example would then be indistinguishable from *standing*. Indeed it will be argued that Galileo in his famous statement of the Galilean invariance suggests that under conditions of uniform motion it is impossible to tell if a body is *moving* or *standing still*.

2.3.4 THE GALILEAN VIEW—THE REAL EVIDENCE

The uniform motion postulate was defended by Van Ingen Schenau (1980) when he reasoned that:

“The real evidence for the mechanical equality of overground and treadmill locomotion follows from the Galilean invariance. This invariance, invoked in many textbooks on mechanics (e.g. Kittel et al., 1973) indicates that the fundamental laws of Newton are identical in all frames of reference that move at uniform speed with respect to one another.”

This statement is important for several reasons. Firstly it provides a means of *experimentally* testing the uniform motion hypothesis.⁵³ Secondly it demonstrates a definite observer bias for a Newtonian physical model,⁵⁴ because the text of the cited authority (Kittel et al., 1973, p.115) actually reads: ‘the fundamental laws of physics’ not as cited above, ‘the fundamental laws of Newton’.⁵⁵

However, perceived observer bias alone should not distract us from the ‘real evidence’ of the Galilean invariance because the statement of the Galilean invariance play a central part in a broader spectrum of physical laws. Olenick et al., (1985) provide the following precise of Galileo *Dialogues*:

“Shut yourself up ... in the main cabin below decks on some large ship....have a large bowl of water with some fish in it....With the ship standing still... the fish swim indifferently in all directions. When you have observed...carefully...have the ship proceed with any speed you like, so long as the motion is uniform....You will discover not the least change...nor could you tell...whether the ship was moving or standing still.”⁵⁶

A direct analogy can be drawn between Galileo's ship carrying a bowl of water, and Inman's human subject carrying a pan of water. Direct observation of the pan of water aboard our “animate ship” beneath our skin however would inform us exactly of a biomechanical fact we are encouraged to ignore, whether we are moving or standing still.

⁵² When the body is neither at rest nor in uniform motion, it is subject to an impressed force that operates according to Newton's second law.

⁵³ I do not feel obliged to test this hypothesis, because it has been examined often enough already, although seldom from a philosophical vantage point.

⁵⁴ Van Ingen Schenau (1980, abstract) concludes “All differences found in locomotion patterns must therefore originate from other than mechanical causes.” He definitely equates the laws of physics with the (mechanical) laws of Newton, apparently unaware of Newton's observation in the *Opticks* (1730, *Queries and Questions* 24-31).

⁵⁵ The equivalence of the laws of physics in uniform motion is the second postulate of special relativity theory (Einstein, 1905). However the conclusion Einstein draws is entirely different from that attributed to Galileo or Newton!

⁵⁶ The unabridged text starts “Shut yourself up in a cabin with a friend....”. The presence of the friend, omitted in the precise, may be listed in accordance with the instructions of Meriam (1980) as extraneous information when drawing a free body diagram. However, I believe it right to include the friend because in relative physics, the status of the observer is critical to the interpretation placed on events.

Galileo also raises the issue of coordination and control of movement. Having given instructions to the helmsman to proceed, we have no independent means of *confirming* whether these instructions have actually been carried out. That is whether we are moving or still standing still, or indeed, whether it is possible for the helmsman to carry them out as intended, let alone using the mechanisms supposed. Especially if we accede to the stipulation of ignorance of the accelerations as the movement starts.

While classic physics has traditionally enforced the equivalence of rest and uniform motion; it has apparently gone unnoticed that the biomechanical components “moving” and “standing still” are also indistinguishable in terms of the Galilean invariance. Therefore why not use *standing still* as a description of gait instead of *uniform motion*?

Van Ingen Schenau’s (1980) conclusion is that any discrepancies are due to non-mechanical causes⁵⁷ and incorrect choice of a fixed frame of reference.⁵⁸ He unfortunately admits no exceptions to Newton’s laws, yet ultimately is forced to appeal to these exceptions. The non-mechanical causes are implicitly assumed to be due to perceptions of the mind. Of course few authors throughout history have provided an adequate *mechanical formulation* for an active *mind*. It is perhaps necessary therefore to develop some mathematical framework for the human mind preferably expressed in terms of the Galilean invariance that supports uniform motion.

SUMMARY OF BIOMECHANICAL HYPOTHESES

- ❖ An artificial schism exists between the biomechanical *gait* and *posture* domains.
- ❖ Bridging this division raises the traditional *biomechanical* problem of initiating gait.
- ❖ The biomechanical problem is distinguished from the *anatomical* problem where no state of uniform or constant translation is observed to exist.
- ❖ Newton’s first constraint on the motion, a state of continuous rest, provides the first mathematical principle for a novel *gait* analysis philosophy.
- ❖ Gait can be viewed as a continuously constrained standing posture. Therefore the presently distinct problems of the *initiation of gait* and *control of gait* reduces to as a single mechanical continuum, with a single solution.

⁵⁷ “All differences found in locomotion patterns must therefore originate from other than mechanical causes.”

⁵⁸ “The difference in opinion is often related to the coordinate system which implicitly or explicitly is used.”

2.3.5 REVIEW OF NEUROMUSCULAR CONTROL

An *osseo-aponeurotic* thesis of gait initiation and control, which is a necessary consequence to the observations of Morton (1930) and Hicks (1954), generates a dialectic *neuromuscular* antithesis. The deficiencies of which are now reviewed.

1. Muscles in Marionettes

Perhaps the simplest mechanism of the animal motive form is the pin, lever and pulley marionettes of the type profusely illustrated by Borrelli in 1680. The simple gait cycle [Fig. 2-10] illustrated by Inman, Ralston and Todd (1981) for example incorporates some traditional ideas. First it *starts* with the body already *in motion*. Secondly it starts with the leg *descending*. Lastly it appeals to a homunculus, an ancient but unsustainable explanation where the finest physical particles of the celestial bodies,⁵⁹ somehow become the most intelligent and capable of influencing physical mechanisms the most.

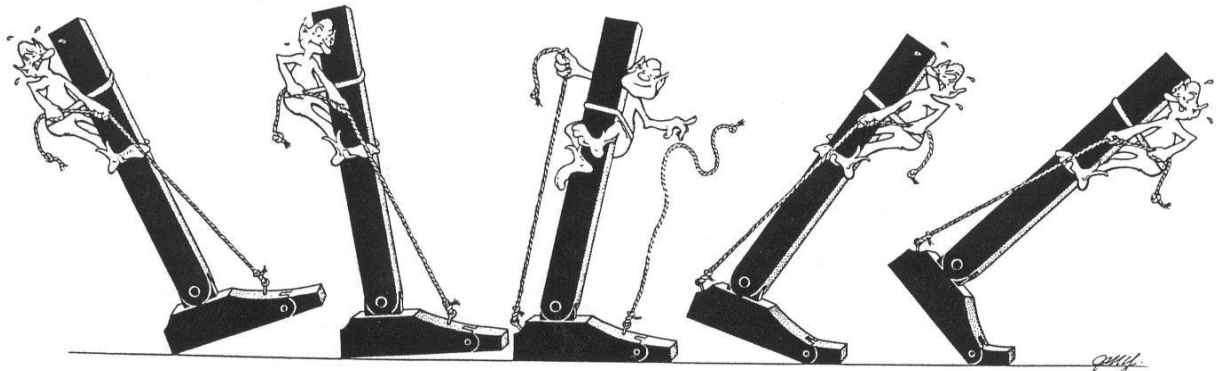

Fig. 2-10. Cartoon explaining muscle action during gait (Inman, Ralston and Todd, 1981).

No explanation is provided however on how either the initial speed or initial elevation of the bipedal body was obtained using muscle. According to Newton's third law, a muscle acts on both ends equally, essentially pulling one part of the body towards another part of itself. Morton (1952) noted by studying the line of action of the muscles that the body simply falls over backward if the calf muscle initially act to move the upright body.

This effect is apparent even in the simple gait model. Notice how the final *body posture* of the muscle homunculus in Fig. 2-10 has regressed in order for the limb of the marionette to progress.⁶⁰ The homunculus attempts to draw attention away from the anatomical-mechanical problem of how a muscle initiates action when it itself is part of the body. But inevitably the insurmountable difficulties reappear in the finer detail, as testified to by the sweated brow of the homunculus [Fig. 2-11]. The sweat from the brow is also symbolic of the perplexing complexity of the indeterminacy of the brain and energy losses in the associated physiological models.



Fig. 2-11. Homunculus detail.

⁵⁹ The material of the stars was called the *aither*, which merged with similar concepts like *aether* and *ether*.

⁶⁰ The homunculus has changed position 180° with respect to the rigid skeleton.

There is also an uncanny resemblance between the final detail from Vesalius (1543) [Fig. 2-12] and Figure. 2-11. Both figures are supported at the pelvis, one seated on the ground, and the other on a sling. Neither model is capable of true bipedal support and propulsion. Clearly, the biomechanical explanation of muscle still used in 1981, has progressed little since 1543.



Fig. 2-12. Figure from *De Humani Corporis Fabrica* (Vesalius, 1543).

Vesalius (1543) used the big toe to illustrate musculo-ligamentous action [Fig 2-12]. Meijer et al., (1988) note that the owner of the muscles pull on them with his own hands, but raised the fundamental question as to what entity pulls the muscles when they are on the inside of the body.⁶¹

2. Muscle as a Thermodynamic Motor

Latash (1998) notes that muscle has numerous features that look weird to an external observer, some of which look even sub-optimal and bizarre. He starts:

“Skeletal muscle is a machine (a “motor”) that converts chemical energy to mechanical work and heat. It is probably the most amazing motor there is.”⁶² [But it possesses] “features that seem terrible when looked through the eyes of a 20th century engineer.”

This is perhaps not as surprising as it seems because the typical 20th century biomechanical engineer, is invariably schooled only in Newton’s 17th century mathematical principles of natural philosophy. Not in the major premises underlying 20th century physics—relativity and quantum mechanics. Is it possible that if these 20th century principles were correctly applied to biological mechanisms, the design of muscle might well seem less bizarre?

One noteworthy example is that the mechanical efficiency of gait is found to be far higher than the thermodynamic efficiency of individual muscles (Whipp and Wasserman, 1969). When this “problem”⁶³ was first encountered the efficiency was almost exactly twice that expected (Lloyd, 1967).⁶⁴ With

⁶¹ Important distinctions between an internal view and external view were recognized by Gustav Fechner (1860).

⁶² A motor converts some form of energy into mechanical work. It is technically distinguished from a engine by the fact that the latter consumes fuel locally.

⁶³ This “problem” is actually a thermodynamic advantage!

⁶⁴In an addendum Lloyd (1967) wrote, “Since this paper went to press, the solution...on an analogue computer has indicated that the efficiency with which a runner uses metabolic energy to accelerate and to overcome air resistance may well be nearer to 50% than to 25%.”

various ad hoc adjustments this value now ranges from 30% to 150% (Hollander, 1998). Another commentator⁶⁵ identifies a corresponding lack of understanding at the metabolic level:

“I explained ... that not only do muscles use metabolic energy whenever they do work, but ... I did not explain properly how the metabolic energy that is needed for particular activities is used: the reason is that neither I nor (I think) anyone else understands it properly.”

It has been established that an isolated muscle can apparently do more work *after* it has been stretched (e.g. Cavagna et al., 1968) and also through the action of biarticular muscles following compression (e.g. Van Ingen Schenau, 1984). Nevertheless, this stretch-shortening theory begs the question as to which anatomical mechanism stretches the muscle in the *first place* or where the initial energy for compression comes from when there is no inertia or drop-height. Whilst these explanations produce a perceived improvement in the efficiency of pin and lever models of the antithesis, they nevertheless greatly amplify the physical difficulties of taking the first step for the thesis, and therefore cannot be viewed as solutions-in-themselves, but rather as hindrances.

Stainsby (1976) noted, and I concur, that the efficiency of muscle is typically that which an engineer might expect of a brake. Many might believe it is absurd to suggest a priori that muscle is systematically optimized to brake motion, rather than to act as the biological *active principle*.⁶⁶ Mechanical prime movers such as engines and motors do act as brakes when the energy cycle is reversed.⁶⁷ The philosophical difficulty here is not in conceiving muscle as an energy optimizing brake, for which there is much physiological data, but in conceiving muscle as a predominantly passive mechanism, and acceding active control to the antithesis of osseo-ligamentous action.

3. Electromyographic Evidence

Basmajian (1974) a pioneer in the field of muscle activity monitoring, rightly devoted many pages to the experimental recording of the electromyography (EMG) of gait. However in a later publication Basmajian (1976) retrospectively refers to an “unpalatable fact”:⁶⁸

“One basic observation is lacking there [Basmajian, 1974] as in all recorded discussions of human gait; very little electromyographic activity appears in any of the muscles during normal moderate-speed walking....In study after study, my colleagues and I have noted that walking elicits very slight EMG activity in the thigh and leg muscles compared to voluntary free movements....This has been remarked on by others also (e.g. Koczocik-Przedpelska, Toebela and Gruszczynski, 1966).”

Proponents of passive walking Ruina, Coleman and Garcia (personal communication, 1998) assembled a gravity powered, brainless walking toy. Characteristics of this assembly are that it is *dynamically stable* but *statically unstable*. It also lacks any intrinsic neural controls and is powered entirely by gravity. This model demonstrates experimentally the viability of the foundations of the thesis: (1) the dominant state of *dynamic rest*, (2) the secondary role of active neuromuscular controls, and (3) the need for a yet to be determined active anti-gravity principle. The passive dynamic walker is limited to walking *down* slopes. How human bipeds might manage to walk *up* a slope remains of course *the* critical question in passive dynamic gait analyses.

Data extracted from other sources also supports elements of passive osseo-aponeurotic control. Bobbert et al. (1992) for example found that muscle activation levels could not explain the rapid

⁶⁵ The author is believed to be RMN Alexander, in a contribution to the Scientific American Library.

⁶⁶ Muscles produce force at constant length in running turkeys (Roberts et al., 1997). In other words they act primarily as brakes.

⁶⁷ Particularly cam operated internal combustion engines when the expansion-compression power cycle is reversed.

⁶⁸ Presumably unpalatable to the neurocentric control hypothesis.

changes in the knee rotation moment after impact.⁶⁹ Indeed De Wit et al. (2000) found that the angle of barefoot strike was actively controlled by the angle of *knee flexion* before impact, indicating perhaps that passive control may indeed come from a simple combination of the toe and knee cam angles in a manner yet to be determined.

SUMMARY REVIEW OF ANTITHESIS:

- ❖ Semantic structures induce the false perception that gait exists as uniform motion.
- ❖ Muscle is invariably viewed as the active principle, but functions better passively.
- ❖ The brain is not required for all aspects of gait control.
- ❖ A passive theory of gait control is lacking.
- ❖ Part of the missing control function may be incorporated in the *anatomical design* of the bone and aponeurosis arch raising mechanism of the MTP-1 and the cams of the great toe and knee.

⁶⁹ A nerve fiber, conducting at a physiological maximum of 120m/s in a heavily myelinated nerve fiber to the brain and back 1.2m away takes a minimum of 20 milliseconds for a round trip without any signal processing. Many unmyelinated fibers and neural synapses in the chain increase this time considerably.

3.

FREE WILL AND THE FREE BODY DIAGRAM

“And who can doubt that it will lead to the worst disorders when minds created free by God are compelled to submit slavishly to an outside will?” — Galileo Galilei¹

“Is not Animal motion performed by the Vibrations...excited in the Brain by the Power of the Will?” — Isaac Newton²

3.1 THE BIOMECHANICAL FREE BODY DIAGRAM

Meriam (1980) strongly advises that drawing:

“the free-body diagram is the most important single step in the solution of problems in mechanics.”

The mechanical free-body diagram is so named because the body subjected to analysis is hypothetically “freed” from all external influences, which are then replaced in theory by drawing in only the “known” mechanical forces.³ Yet despite its obvious importance in *mechanics*, there is very little *biomechanical* literature dedicated to drawing the animate free body diagram [Fig. 3-1]. One reason is that animate bodies appear to possess a *free will*, a capacity to spontaneously initiate actions like starting to walk that circumvents deterministic calculations.

Nevertheless the ancient concept of *will* is central to the thesis because *the will* was conceived as the *mental faculty* responsible for acts of volition such as choosing, deciding and *initiating motion*.⁴ The mechanical *free-body* diagram therefore should be extended to incorporate a *free will* component.

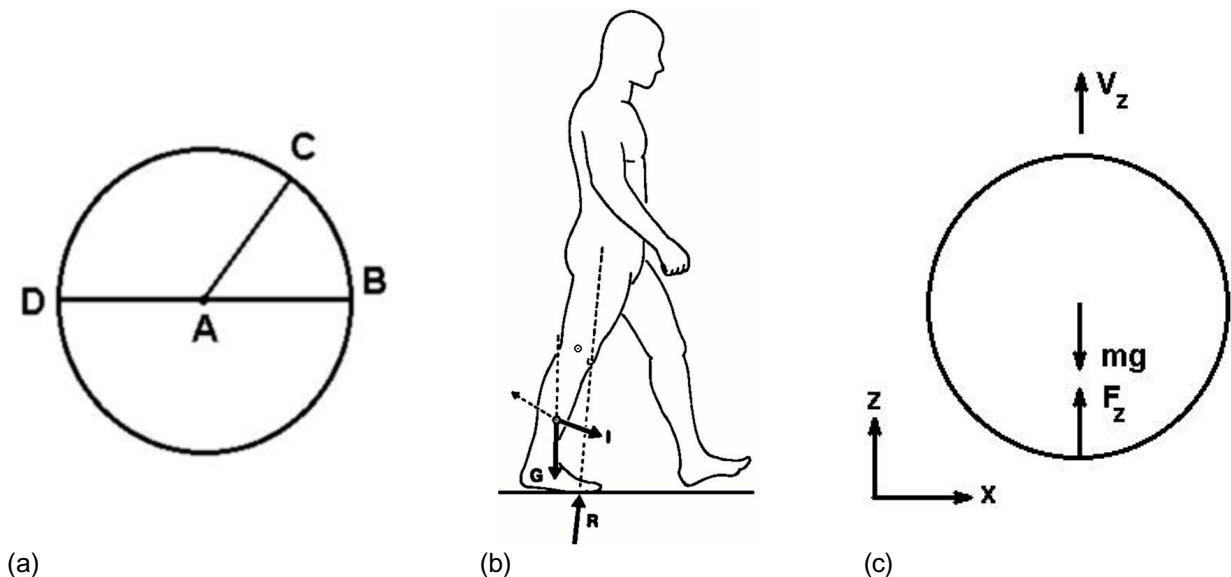

Fig. 3-1. Three examples of biomechanical free body diagrams. (a) *Movement of animals*, Aristotle (1981). (b) *Human walking*. (Inman, Ralston & Todd, 1981). (c) *Power equations in endurance sports*. (Van Ingen Schenau & Cavanagh, 1990). See original texts for explanation of symbols.

¹ A note in Galileo’s handwriting in the margin of his own copy of the *Dialogue on the great world systems*. De Santillana, 1953, p.x.

² Opticks, Query 24.

³ This chapter investigates what we might claim to know about the known forces.

⁴ *will*, Oxford Companion to Philosophy.

3.1.1 PROCEDURAL STEPS⁵

1. The first step is the *choice of body* or combination of bodies to be isolated. The choice of the MTP-1 body stems from experiment and a combination of Aristotle's *anima* and Newton's third axiom of motion.⁶ This original combination requires a synthesis of Newton's and Aristotle's principles of inertia and the unmoved mover which are historically seen as dialectic antitheses of each other.
2. The second step is the complete *isolation* of the chosen body. This is achieved by actual amputation of the joint (Chapter 4). But because amputation is only feasible in inanimate cadavers, the results need to be generalized to a fully animate body by analysis of constraints and artifacts.
3. The third step requires that the effects of all the *known* and *unknown* forces, due to removed, contacting and attracting bodies be indicated on the chosen boundary. These unknowns include four previously neglected intangibles such as Newton's *aether*, *Will*, anatomical mechanism of *choice* and some unspecified form of *active principle* which are described in Newton's *Opticks*.
4. The fourth step, is the choice of mathematical frame of reference. Biomechanical motion is usually described in terms of two *res extensa* (x,y,z) Cartesian frames of reference. The thesis however incorporates Descartes' original and less well-known *res cogitans* system with its complementary *res extensa* to form one complete individual. This novel mathematical reference replaces the traditional combination of two *res extensa* required by the Galilean invariance.

3.1.2 DEFINITION OF BODY

The definition of body is important because the definition itself is a means of isolating the substance of the body and hence freeing it from its surroundings. The word *body* originally meant the wrappings of the soul.⁷ But nowadays a body is the entire material structure and substance of an organism, especially of a human being or animal.⁸ Thus the ancient and modern view of a free body is one free from non-material (i.e. spiritual) control. Newton's mystical hypotheses on *Will* and the scholastic cherubs⁹ and angels deputizing for Aristotle's universal unmoved mover that adorned medieval scientific drawings both fall in this spiritual category.

Newton defined body as a *passive entity* because in unpublished¹⁰ revision he wrote:

"I call 'body' every tangible thing that resists things touching it, and whose ~~aetion~~ resistance, if it be great enough, can be felt. For it is in this sense that ordinary people always take the word 'body'. And of this kind are stones,...bones, meats, water, milk, blood, air,... I add the celestial bodies..." [emphasis added].¹¹

The need for a passive definition are not at first obvious. But the cancelled word ~~aetion~~— certainly implies that active bodies with an actualized free will do not fall within the scope of Newton's definition of body. Descartes like Newton also defined body as passive.

"By body I understand all that which...can be moved in many ways not, in truth, by itself".¹²

Thus the mechanism that causes a body *to initiate the movement* is not defined as part of the body in either a Cartesian or Newtonian system. In a sense it must be an entirely imaginary addition, a *free will* as it were. McDougall (1911) notes that philosophers of old, quite unlike today believed almost

⁵ Abbreviated from Meriam (1980, *Statics*, p.71-75).

⁶ The term *mathematical animation* is used to distinguish the method from the *spiritual animation* of the scholastics and biomechanical *cinematic animation* used for inverse dynamics.

⁷ Rée, (1974).

⁸ **body**, Reader's Digest Universal Dictionary.

⁹ See Fig. 3-13, p.49.

¹⁰ Cohen (1971, p37). Newton intended this definition to be placed before the *Regulae Philosophandi* in the *Principia*.

¹¹ The modern biochemical search for the body action force focuses on meats (muscle), blood, air, milk (lactate) exhalation (VO₂) salts (cell membrane ion action potentials) etc. These physiological components develop from the *pneuma* or living breathe as source of motion, and fall outside of the scope of the *anima* thesis. Aristotle in *Movement of animals*, 703a, however notes that the "connate *pneuma*...seems to bear the same relation to the psychic origin as the point in the joints, which moves and is unmoved, bears to the unmoved."

¹² Descartes, *Meditation 2*.

without exception in a separate animating principle. The *aim* of this chapter is to isolate the unknown mathematical form of this animating principle.

3.1.3 KNOWN AND UNKNOWN QUALITIES

The Newtonian forces in a typical biomechanical free body diagram essentially arise from *anatomical qualities* that are only vaguely known. Following Newton's criticism of the Aristotelians, this is to tell us nothing. There is a need to develop two or three general principles from experimental observations of *animate phenomena* that apply specifically to the *animate free body*.

An *unknown* effect can be either a quality or quantity. Most readily understood is the *quantitative* unknown, which is an algebraic term such as the (x,y,z) notation of Descartes. The mathematical "form" of these unknowns is known, but its numerical value is not. Contrarily, *qualitative* unknowns are elusive because they have no such mathematical form or formulation.

Unfortunately the postulate of the antithesis, that Newton rules biology expeditiously side-steps the problem of qualitative unknowns altogether. This deficiency is addressed here by giving a definite Cartesian mathematical form to Newton's qualitative unknowns that are not found amongst his *mathematical principles*. Specifically his hypotheses of *will*, *choice*, *aether*, and some other unspecified *active principle*.

3.2 HISTORICAL ORIGINS OF FREE-BODY

3.2.1 GALILEO, ARISTOTLE AND FREE FALL

The ideal free body of course is one free falling in a void. Historically the Galileans used the free fall of two inanimate bodies to contradict Aristotle's primary requirement for a mechanism to continuously push and pull to maintain a body in motion. Consequently as Cooper (1972) points out, Galileo is often portrayed as the founder of *experimental dynamics* at Aristotle's expense.

"It is still a common belief in America, that having ascended the leaning tower of Pisa, by a single dramatic experiment refuted an assertion by Aristotle [that marked] a turning point in the history of science."

But Cooper's thesis is that this crucial experiment is a myth based on hearsay. What he calls "a half-literary exercise". Furthermore he suggests that,

"We might suspect that few 'scientists' have examined for themselves are evidence on the relations between Galileo and Aristotle; Galileo probably did better than most [although] on occasions he affects to quote from Aristotle words that are not found in Aristotle's writings."¹³

It is important therefore to refer to what Aristotle actual wrote, and if necessary re-evaluate the inferences drawn from Tower of Pisa experiment. The tower serves as a useful icon, nevertheless because it represents any elevated *pedestal* that provides an initial potential energy source for gravitational free fall, which arguably acts as the essential fuel source for the inertia of horizontal uniform motion. These two principles, potential energy and uniform motion, regularly appear from nowhere in the traditional description of a gait cycle, which starts with the heel strike of a descending leg then continues pushed by horizontal inertia.

¹³ Galileo errs by attributing the following words to Aristotle, "Aristotle says that, 'an iron ball of one hundred pounds falling from the height of one hundred cubits reaches the ground before a one-pound ball has fallen a single cubit.'" Aristotle actually pointed out that if a heavy stone fell faster than a light stone in a void then the earth, itself a very much bigger stone, would fall away the fastest of all! Aristotle concluded that the earth did not fall because it was in its proper place. It is this theory of proper places that leads him to seek a proximal 'proper place' for the soul.

But these historical starting axioms do not transform at all well into anatomical faculties. Their hypothetical existence encourages many to evade critical questions. Particularly as how it is that the descending leg was first raised by muscle pull onto the *Galilean pedestal*, or how the forward inertia of the *Galilean invariance* were first generated at the start of gait. Clearly when one starts to walk these energies need to be supplied by the body itself. They cannot both be postulated into existence. It is not surprising therefore that there is *still* no complete functional neo-Newtonian or Galilean account in the literature of how the muscles push and pull in a controlled sequence to obtain or maintain the human body in uniform motion.¹⁴

3.2.2 ARISTOTLE'S UNMOVED MOVER

The Galilean's somewhat embellished experimental reports were however only one reason why Aristotle's authority fell into disrepute. Aristotle emphasized in the *Movement of animals*¹⁵ that there must be something unmoved both outside and inside the individual to produce self-movement:

“It is worth stopping to consider this statement, for the statement applies not only to animal, but also to the motion and progression of the universe. Just as there must be something *in* the individual which is unmoved¹⁶ if it is going to move itself, so even more there must be something unmoved *outside* the animal, supported upon which that moves itself moves.”

Newton's third law ensures that any physical unmoved mover must be of infinite mass, which essentially becomes a supernatural, non-mechanical or spiritual being. Hence the unmoved mover responsible for the physical progression of the universe is often viewed as “Aristotle's god”¹⁷

This common but incorrect perception, is due in part to the fact that the bulk of Aristotle's texts were preserved by religious scholars¹⁸ who were preoccupied with the universal unmoved mover described in the *Physics*, and the so-called *First Cause* of motion in the heavens (*de Caelo*).¹⁹ Early western scholars in particular were unaware of Aristotle's *Movement and progression of animals* where the principle of the unmoved mover is applied both inside and outside of animal bodies.²⁰ Unfortunately Aristotle's name has become synonymous with bad science, partly due to Galileo's criticisms.

3.2.3 GALILEAN CONSTRAINED BODY

Descartes for one was critical of Galileo's *Two New Sciences*, which seemed to him to be:

“very deficient, in that [Galileo] is continually digressing and does not stop to give a complete explanation in any matter. This shows that he has not examined things in order and that, without considering the first causes of nature, he has only sought to account for some particular effects, and thus he has built without foundation. (AT ii. 380.)²¹

¹⁴ Hatze (1977) claimed a complete set of equations, but by his own accounts makes numerous assumptions and omissions.

¹⁵ 698b.

¹⁶ Preus, p.25 recognizes an ambiguity in the Greek text between *unmoved* and *immovable*, but prefers the former because it makes a weaker claim.

¹⁷ The existence of a supernatural spirit endowed with Divine Reason inaccessible to humans incidentally also leads to a problematic hierarchy of control.

¹⁸ The Andalusian Arab Averroës (c.1126-1198) had many of Aristotle's texts transcribed to prevent their destruction. But omissions included the *Movement of animals* and *Progression of animals* which survived only in eastern Byzantine transcriptions (Preus, pp. 1-15). These texts were therefore probably not known to scholastics such as Aquinas (1224-1275) for example.

¹⁹ Almost all references to Aristotle's unmoved mover refer to the *Physics VII*, *de Caelo* and Plato's *Phaedrus 245c-e*. Although sometimes encountered as an historical anecdote, I have encountered no experimental analysis of Aristotle's unmoved mover in its original biomechanical context.

²⁰ This situation has an unfortunate modern parallel because many scientists routinely apply Newton's *Principia* to animal motion, which controversially do not explicitly deal with the topic, while simultaneously neglecting his hypotheses in the *Opticks* that actually do.

²¹ Letter to Mersenne on 11 October 1638, (Gaukroger, 1989, p.105).

Descartes argued rather for a method founded on solid first principles, because in his *First Meditation* he notes that:

“For owing to the fact that the destruction of the foundations of necessity brings with it the downfall of the edifice, I shall only in the first place attack those principles upon which all my former opinions rested.”

In gait analysis, the former opinion or received view of many is the Galilean invariance²² and the arch of the foot that supports the Galilean pedestal. But Galileo’s views were not always well received. He was expressly prohibited from teaching, charged with heresy, then detained by the Holy See before dying under house arrest.²³ Thus while Galileo may have had a free mind, he himself could not simultaneously lay claim to an officially sanctioned *free body*.²⁴ The concept of a free body in a mechanical sense gradually developed sometime thereafter.

3.2.4 DESCARTES AND ARISTOTLE

The circumstances surrounding Galileo’s heresy had a constraining effect on Descartes²⁵ who was then planning a treatise on *The World*. This was to have contained a revolutionary section on human physiology entitled *A treatise on man*. But partly due to the ecclesiastic constraints that effectively constrained the Galilean body, the physics of the Cartesian *World* and physics of *Man* diverged into the two disparate scientific disciplines of *physics* and *physiology*.²⁶ Unfortunately Descartes’ detailed explanation of the relation between the two is no longer extant.

The modern biomechanical model therefore starts afresh, after Darwin²⁷ had cleared the way, with Braune and Fisher (1896-1904) applying Newton’s *Principles* to animated pictures of gait in a Cartesian mathematical frame of reference, unaware perhaps of the constraints on the original Galilean body. Newton had of course dissociated the scientific community from Aristotle. Galileo had dismissed Aristotle on the grounds of experimental observation, whilst Descartes had summarily rejected the definitions of the Aristotelian “Schools”²⁸ on the grounds of incomprehensibility.

Yet it is within the volumes of the preeminent Schoolmen such as St Augustine (354-430)²⁹ and St Thomas of Aquinas (1224-1275) that I believe the origins of the modern mechanical free-body diagram are to be found. I cannot summarize the two thousand years between Aristotle and Newton better than McDougall (1911, p.34) who in his extensive history and defense of animism writes:

“Aquinas like his predecessors in the schools, claimed to have returned to the true Aristotelian doctrine. But he denied the separability of the active reason and insisted that the soul is a unitary being; consistent adherence to Aristotle’s principles would then have lead him to the denial of immortality. But [being a Christian philosopher] this was impossible to him; therefore, instead of binding fast the [Divine] reason in the body together with the [Aristotelian] nutritive and sensitive faculties, he rather *set free all alike from the body* and declared the whole unitary soul to be immortal” [parentheses and emphasis added].

²² Van Ingen Schenau (1980), p.260 .

²³ See de Santillana, (1953).

²⁴ Galileo incidentally has never been fully pardoned by the Church.

²⁵ Descartes was baffled by the basis of the charges. “Which heresy?” he inquired (, 1953, p.xlix).

²⁶ JS Haldane, in the 1908 Presidential address to the Physiological Section of the British Association noted, “That the meeting-point between Biology and Physical Science may at sometime be found, there is no reason for doubting. But we may confidently predict that if that meeting point is found, and one of the two sciences are swallowed up, that one will not be Biology.”

²⁷ Darwin postulated a new *Origin of Species* (1859) that facilitated *The Descent of Man* (1871) from his original lofty pedestal.

²⁸ The Schoolmen or scholastics were the original “learned Doctors”. The forefathers of the university entitlement *Doctor of Philosophy*

²⁹ St Augustine, the preeminent Doctor of the Western Church, apparently did not read Greek and had only had a scrappy knowledge of the 800 year of tradition that preceded him (Honderich, 1995). Nevertheless with 97 texts, he was the most prolific author of the time. I believe that much of the subtle meaning in the Greek was lost at this stage because as I understand it (Preus, 1983), Latin and Anglicized grammar does not have the Greek middle passive tense that allows objects to move themselves independently of the external subjective and objective agencies; allowing us only action and reaction, in mechanical terminology.

An immortal soul was equivalent in philosophy to being in uniform or perpetual motion because motion itself was equivalent to life. Aristotle assigned diverse roles to the soul (e.g. nutrition, sensation, conation, locomotor, and rational). The scholastics however allowed only one immortal and indivisible soul to each body, so obviously did not see fit to locate it in the toe.³⁰ Neither did Aristotle for that matter. Aristotle's physics survives now only in name. Nevertheless Aristotle's proximal location of the origin of motion still persists in *anatomical* teachings in the description of nerves and muscles.

In my reading of Aristotle however the anima is attached to the body in the region of the hinge joint (*de Anima III.10*). More specifically Aristotle goes so far as to attach the soul or anima to the concave joint surface, which effectively means the proximal phalanx of the great toe. But unfortunately Aristotle, in the *Movement and progression of animals* chose rather to emphasize the importance of a proximal location near the heart.³¹ However, Aristotle's logic here appears circular. He locates the soul in the center because this is its proper place and vice versa.³² Locating the origin in the toe explicitly inverts Aristotle's honorable hierarchy.

The current thesis is unique because most commentators shift the origin of movement to the brain (neuromuscular system) *up* away from the heart (cardiovascular system) and center of mass of the body. Not in the opposite direction *down* to the great toe (osseo-aponeurosis ligament system).³³ Critically a distal shift reduces the historical role of Aristotle's *Physics* and *de Caelo*, and emphasizes a novel role for the *Anima* prioritizing the unmoved mover *inside* the body and toe rather than somewhere out there in the heavens.³⁴ This thesis conjointly reverses the conventional origins and insertions of the muscles in the lower limb that have survived through antiquity.³⁵ A change that has its roots in an osseo-aponeurosis model of passive toe action (Hicks, 1954).

³⁰ Unlike Rabbi Ushaia in 210 AD (See Helal, 1981). In eastern philosophy Yoga exercises for example often start by first achieving balance with the great toe. See also the 12th Century Brahmanical bronze statue *Cosmic Dance of Nataraja*, from the Madras Museum, used here as the frontispiece on the thesis title page, and the description by F. Capra., *Tao of Physics*, pp.230-233; A.K. Coomaraswamy, *The Dance of Shiva*, pp. 83-85.

³¹ *Movement of animals*, 706b.

³² "Bipeds have their up towards the up of the universe...man most of all...for the origin is more honorable, and up is the more honorable than down...It works well to say it the other way around, that because the origin is in these parts, they are more honorable." *Progression of animals*, 706b. Also *Movement of animals*, 702b, "the origin always has to be in something higher up".

³³ Aristotle however observes in the case with plants, that 'up' is sometimes 'down' *Progression of animals*, 705b.

³⁴ *Movement of animals*, 700a.

³⁵ *Movement of animals*, 698b.

3.3 CARTESIAN FREE WILL

The concept of *will* is so old that it is difficult to trace its origins³⁶ although according to Kenny (1979):

“It is a commonplace of Aristotelian scholarship that Aristotle had no theory of the will.”

Therefore the philosophy of a will was introduced sometime after Aristotle but before Newton. Whatever its origin the whole ancient faculty of will has practically vanished as a biomechanical concept, being entirely subsumed into the modern philosophy of an indeterminate³⁷ neuromuscular skeletal muscle system. Newton’s philosophy of *Will* as explained in the previous chapter reduces to an indeterminate source of neural action potentials in the brain, and thus is not developed further here because of the proximal origin.

Although many suppose that “Newton rules biology”, Newton (1730) himself reiterated that his passive *principles of motion* alone were inadequate to introduce any motion in the world. The prerequisite active principle—the free will component—is therefore introduced from Descartes’ *Principles of philosophy* (1644) which are preferred to Newton’s *Mathematical principles of natural philosophy* because unlike Newton’s they are explicitly suited to a *biomechanical* synthesis.³⁸

Descartes, after first recognizing that all knowledge is doubtful,³⁹ and pointing out that we often follow opinions that are merely probable,⁴⁰ then argues why we might even doubt sensible things⁴¹ in particular the demonstration of mathematics.⁴² Principle 6 however, contains his first *axiom* of knowledge:

“That we possess a Free-Will which causes us to abstain from giving ascent to dubious things, and thus prevents us from falling into error.”

Descartes’ use of Free-Will here is untraditional in the sense that it is not used to initiate or control motion. It is rather used to govern our scientific judgements and choices, impinging thus into the scholastic realm of the rational Divine Will. Newton (1730) himself later emphasized the need for a mechanism of choice in animal motion, and it is the Cartesian Free-Will that hypothetically gives the thesis that choice.

But I believe the axiomatic character of Descartes’ “we possess a Free-Will” clause introduces a fundamental dichotomy because it arbitrarily extends the private knowledge, the “I” of his forthcoming well-reasoned “I think therefore I am” argument of *Principle 7*, to the collective or public “we” of the knowledgeable scientific community. Remarkably Descartes’ other important axiomatic use of the public term “we know” occurs, not as in the section *On Human Knowledge*, but in *Article 7* of the *Passions of the Soul* (1649) where he writes:

³⁶ Discussion of will go back to the *akrasia* of Socrates.

³⁷ Kenny (1979) notes that: “According to a view familiar in modern philosophical tradition, the will is a phenomenon of introspective consciousness. Volition is a mental event which precedes and causes certain human actions. The freedom of the will is to be located in the indeterminacy of these internal volition’s.” Bernstein (1966) in his last paper defined the neuromuscular system as redundant or indeterminate.

³⁸ In a letter to Abbé Claude Picot, Descartes explained: “Thus philosophy as a whole is like a tree whose roots are metaphysics, whose trunk is physics, and whose branches, which issue from this trunk, are all the other sciences. These reduce themselves to three principal ones, viz. medicine, mechanics and morals—[from which] one culls the fruit.” (Haldane and Ross, p.211). Newton on the other hand in a Scholium in the *Principia* (1687) wrote “Then from these forces, by other propositions which are also mathematical, I deduce the motions of the planets, the comets, the moon, and the sea.” Immediately continuing that, “I *wish* I could derive the rest of phenomena of Nature by the same kind of reasoning from mechanical principles...or from some truer method of philosophy”. Biomechanical applications of the *Principia* are thus essentially nothing much more than an extension of wishful Newtonian thinking.

³⁹ Principle 1. “That in order to examine into the truth, it is necessary once in one’s life to doubt of all things, so far as this is possible.” Application of this principle allows us to doubt the indubitable, that Newton indeed does rule biology.

⁴⁰ Principle 3, that “we are frequently obliged to follow opinions which are merely probable, because ...as frequently happens with two courses of action, we do not perceive the probability of one more than the other, we must yet select one of them.” This principle explains why one might presuppose for example that gait is best described as a state of uniform motion rather than a state of rest.

⁴¹ Principle 4. “Why we might doubt of sensible things.”

⁴² Principle 5. “Why we might likewise doubt of the demonstration of mathematics.”

“We know finally that all these movements of the muscles, and also all the senses, depend on the nerves, which...all proceed from the brain” [emphasis added].

Here the “we know finally” clause links *our knowledge* to the antithesis of an active neuromuscular control system through commonly perceived simple *actions* such as walking. Not through any introspective *rational* principle as does the Free-Will postulate.⁴³ Hence Descartes’ philosophy presents ambiguously as either:

- ❖ An original individual thesis, which can methodically doubts the action of the neuromuscular system.
- ❖ A traditional active neuromuscular control antithesis based on the pre-existing ability to walk.

A very important metaphor in Descartes’s axiom of Free-Will is the reference to an *ascent to knowledge* and *falling into error*. This makes truth a vector quantity based on our perception of gravity, very much in line with Aristotle’s vain requirement for an honorable hierarchy for the soul. Newton incidentally also used the concept of ‘fall’ as an analogy for ‘error’ in a letter to Bentley.⁴⁴ This appears as a unifying point common to Aristotle’s, Galileo’s and Newton’s philosophies, an *elevated location* for the rational cognitive principle, a neurocentric equivalent to the Galilean pedestal principle perhaps.

This somewhat arbitrary elevation of the process of human rationalization terminates I suspect in Bernstein’s philosophy of indeterminate neurocentrism, and even in anatomical frauds like Piltdown man.⁴⁵ All of which emphasize the role of the brain in human evolution rather than his bipedal feet. The evolution of the foot was well described by Morton (1922-1952) but his work is sadly neglected.

3.3.1 CARTESIAN FREE WILL DIAGRAM

The Cartesian Free-Will diagram follows from the hierarchical structure of knowledge implicit⁴⁶ in Descartes four *Parts* of his *Principles of Philosophy* which are: (1) *human knowledge*; (2) *material things* including corporeal body; (3) *the visible world*; and (4) *the earth*. He also describes how a fifth part on plants, and a sixth part on animals were planned but voluntarily suppressed by his own account due to a lack of experiments.⁴⁷ Hypothetically Cartesian ‘Free Will’ links “doubting mind” to “materials things” to create scientifically dubious things, as depicted schematically in Fig. 3-2.

⁴³ The *Passions* are in fact Descartes’ active principles. “The *action* and the *passion* are always one and the same, although having different names.” (*Article 1. The Passions of the Soul.*) His description of the *action of the Will* in *Principle 9*, unlike in his *Passions*, is explicitly confined to the imagination, rather than walking or nutrition. Also in his *Second Meditation*.

⁴⁴ Torretti (1983) p. 33.

⁴⁵ A notorious fraud involving a orangutan jawbone and a homo sapiens sapiens skull brain case, purporting to be the proverbial missing link with a large skull on an ape body.

⁴⁶ Descartes disavowed the work of the Cartesian Henri Le Roy because he disregarded the intrinsic order implicit in Descartes writing.

⁴⁷ Principle CLXXXVIII.

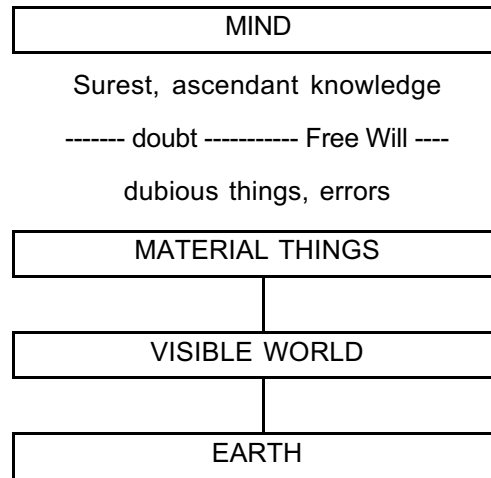

Fig. 3-2. The Cartesian ‘Free Will’ diagram, after René Descartes’ partitioning of body and mind.

But, Descartes always claimed we knew our minds better than our bodies,⁴⁸ although many empiricists today might believe the opposite. The original empirical content of the Cartesian *World*, as represented in the expanded Free-Will diagram [Fig. 3-3] has long since been replaced by Newton’s *Principles* retaining only Descartes primary structure of mind. It is important however not to confuse Descartes’ physical theories with his philosophical structure of mind. Descartes’ physics may have fallen into disrepute. But his structure of scientific reason and mathematics has endured.⁴⁹

Newton’s famous axioms of motions were anyway a compilation of many contemporary ideas.⁵⁰ Newton also further transformed Kepler’s physical force, that had itself only recently been transformed from the ancient anima, into the mathematical principle of gravity. Also it is known through his correspondence⁵¹ that Descartes did intend to compare the actions of the soul to gravity in some way in his physics, although the original bridging text is no longer extant.

The main purpose of the Free-Will diagram presented here is to demonstrate that the mind’s relation to the specific body it resides within. Whilst the mind’s relation to the external world is quite different.⁵² The diagram also shows that efficacy of the mind and truthful or rational reason is intimately bound to the gravity vector. This is important because gravity and inertia are physically indistinguishable to a physical instrument without a mind. A fact that makes motion analysis with instruments problematic.

Galileo’s and Newton’s science are traditionally seen to converge on the principle of inertia, as expressed in Newton’s first law of motion—the axiom that defines the problem of initiating gait. However as can be seen in the introductory quotes at the beginning of this chapter, Galileo’s and Newton’s opinions appear to diverge dramatically over the efficacy of the Will.

⁴⁸ Principle 11. How we might know our mind better than our body.

⁴⁹ Descartes’ and Newton’s conflicting theories of *The World* were ultimately resolved by Maupertuis’ surveying expedition to Lapland in 1736/7.

⁵⁰ Newton for example adopted Galileo’s principle of inertia as his 1st law, and Newton’s 2nd and 3rd laws of motion bear remarkable resemblance to Descartes 1st and 2nd Laws of Nature in *The World*. See Rée (1974) p49. Newton’s famous *Mathematical principles of natural philosophy*, owes its title to Descartes’ *Principles of philosophy*. Although Newton haughtily dismissed Descartes’ philosophy of *The World*, declaring, “error, error” Cartesian philosophy (*Principle 1*) is based on the recognition that everything ever taught in philosophy is probably erroneous anyway.

⁵¹ Correspondence with Princess Elizabeth of Palatine 10-20 June 1643, (Vesey, 1964, p.50).

⁵² Gustav Fechner (1860, pp.1-6) makes this point very eloquently in the introduction to his *Elements of psychophysics*.

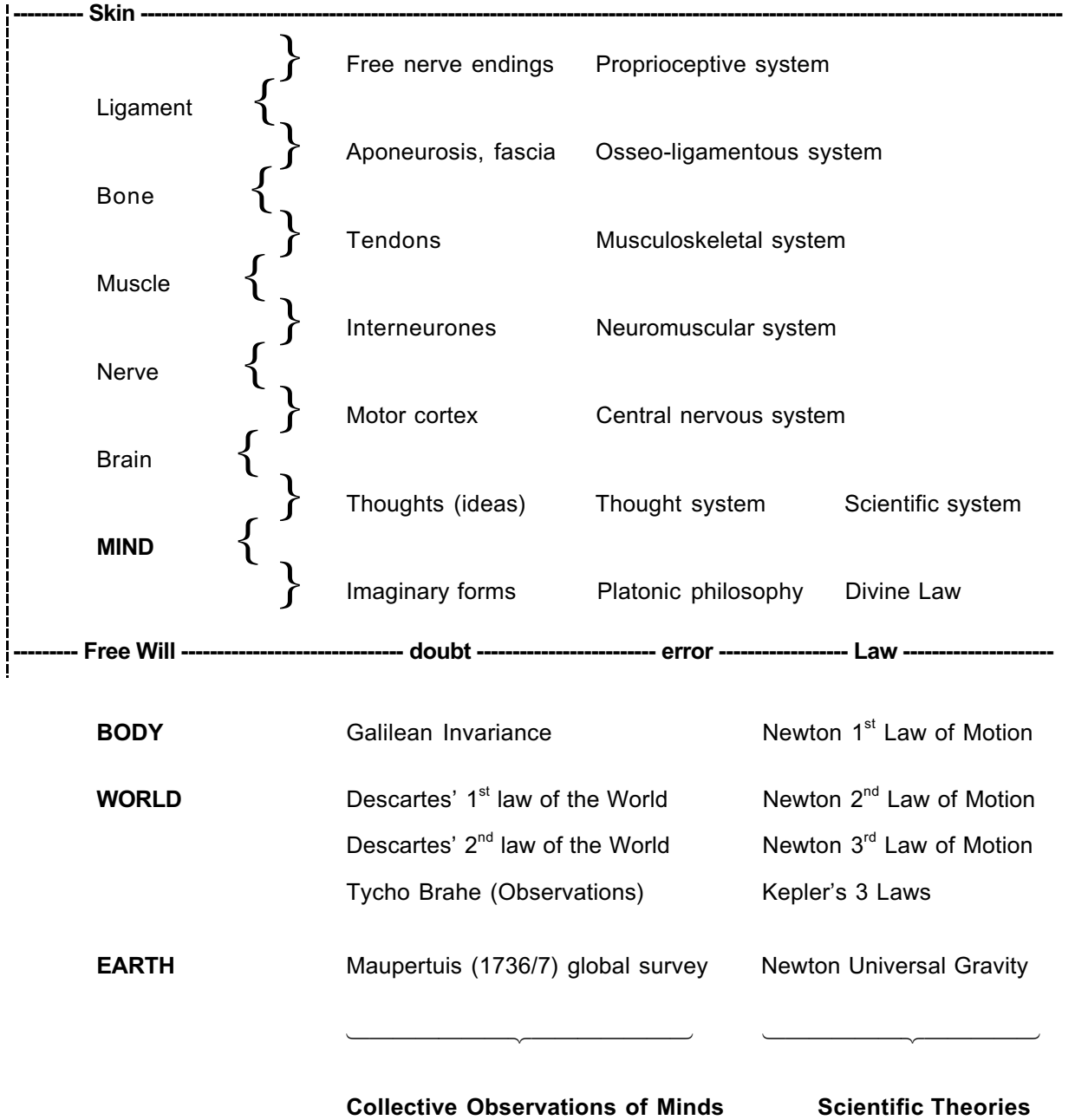

Fig. 3-3. The Cartesian Free-Will diagram extended to include some anatomical form and contemporary science.

3.3.2 INCORPORATING THE SCIENTIFIC MIND

Descartes' *cogito ergo sum* argument which is the basis of his philosophy is an individual basis for knowledge. The Cartesian Free-Will diagram therefore needs to be modified to incorporate a *mechanism of consensus* of many observant and doubting scientific minds.⁵³ In accordance with Descartes own *Rules*⁵⁴ it is possible to divide Descartes third part on the *Visible World* into two further parts, *observations* and *theories* of the world. These correspond roughly to the academic (observational) and dialectic (argumentative) modes of science.⁵⁵

In the definition of Free-Will phrases such as 'ascent' to knowledge and 'falling into error' presuppose a free-fall gravity model to orient the body, as well as the spiritual soul. The upper case Free-Will reflecting a privileged ecclesiastical frame of reference also needs to be reduced to a lower case *free will*. This is achieved by recognizing the historical transposition of Aristotle's instrument of the *anima* with the *First Cause* of motion in *de Caelo* and the elevated, rational and spiritual *animus* of St Augustine and Aquinas.

The tendency to link *falling* to *error* was not confined to Descartes.⁵⁶ This concept coincides with the scholastic categorization of knowledge where the earth representing the lower damnable easiest obtained state, and the most rarified air or aether the highest almost unobtainable ideal. It also coincides with Aristotle's 'honorable' proximal origin for the muscles and nerve and incorporates human rationality with refined spirit, especially Galen's animals and vital spirits.

Descartes and Newton's theories on animal motion both included aspects of the *animal* and *vital spirits*, which were really an anatomical combination of Aristotle's *pneuma* mixed with his vegetative and sensitive souls. It was long believed that these fine particles of spirit rose up like a proficient vapor to mingle in the brain where they somehow exercised physical control over the body.⁵⁷

In terms of the first law of thermodynamics⁵⁸ all energy can be reduced to the *raising of a mass in a gravity field*. Creation of mass and energy—equivalent to the spontaneous *elevation* of the body or its soul in a gravity field—is a traditional function of Divine Will⁵⁹ rather than man's Free-Will. But an anatomical mechanism that appears mysteriously to raise the anatomical body if only briefly in the dead and paralytic, such as Hick's arch raising mechanism in the foot, might well resolve Newton's questions on the Power of the Will and infuse it with the required active qualities.⁶⁰

As for the anatomical location for the will, Descartes like Newton and Aristotle reasoned that the locus of motion control must be in a central position. Unlike them however he choose the pineal gland in the brain⁶¹ [Fig. 3-4]. Descartes' choice of the pineal gland, like Aristotle's choice of the heart is widely regarded as a mistake. McDougall (1911, p.52) for example comments:

⁵³ Traditionally, the hypothetical observations of a small isolated group Galileo's friends Salviati and Sagredo has subsequently been expanded to a whole scientific community through the principle of the Galilean invariance and the myth of the Tower of Pisa.

⁵⁴ *Rules for the direction of our intelligence's in the sciences*.

⁵⁵ The diagram includes two examples of observations. Brahe's data was used in the formulation of Kepler's laws that converted the anima to gravity force. His point data relating to imaginary areas swept out by planets relative to the sun focus, is similar in principle to the point data I used to describe the animate area swept out by a cam. Maupertuis' survey of Finland is included because it validated Newton's theory of the world, and discredited Descartes theory. The Finland survey is also mentioned here because it contains many important correlates to my own unpublished global survey of the earth's gravity field from maps.

⁵⁶ Newton, in letter to Bentley wrote, "That one body may act upon another at a distance through a vacuum...is to me so great an absurdity that I believe no man who has in philosophical matters a competent faculty of thinking can ever fall into it." (Torretti, 1983, p33).

⁵⁷ In fact Descartes conceived the nerves as if bell-ropes pulling on the brain to open valves that let in animal and vital spirits into the inner cavities of the brain. The recently discovered fact that the nerves were solid no doubt caused Newton to suggest an interstitial neural aetheral transmission medium. Greek anatomists did not generally distinguish between nerves and tendons.

⁵⁸ i.e. the law of conservation of energy.

⁵⁹ *De Magistro*, St Augustine (389 AD).

⁶⁰ Newton's example in the Opticks of capillary action in animal glands certainly appears to defy gravity, and hence qualifies in Newton's speculations as an active principle.

⁶¹ *Passions of the Soul*, Article XLIII.

“This was an unfortunate shot in the dark; for modern research has shown that no part of the brain is less concerned in our mental processes than the pineal gland, which seems to be a vestigial remnant of a median eye carried on top of the cranium by a remote ancestor of the human species.”

Nevertheless the pineal gland is an intriguing choice for several reasons. Firstly, the near total lack of neural connections to the pineal gland does not conflict with an hypothesis of aponeurosis action. The pineal gland is a major source of hormones that drive the Cartesian passions and actions. The gland is also a noteworthy element in Descartes’ stereographic reflex loop that also contains the cruciate optic chiasma.⁶² Also as a remnant third eye, the gland might give us an innate capacity for 4D vision and insight needed for integrating a complex mathematical structure of the mind.

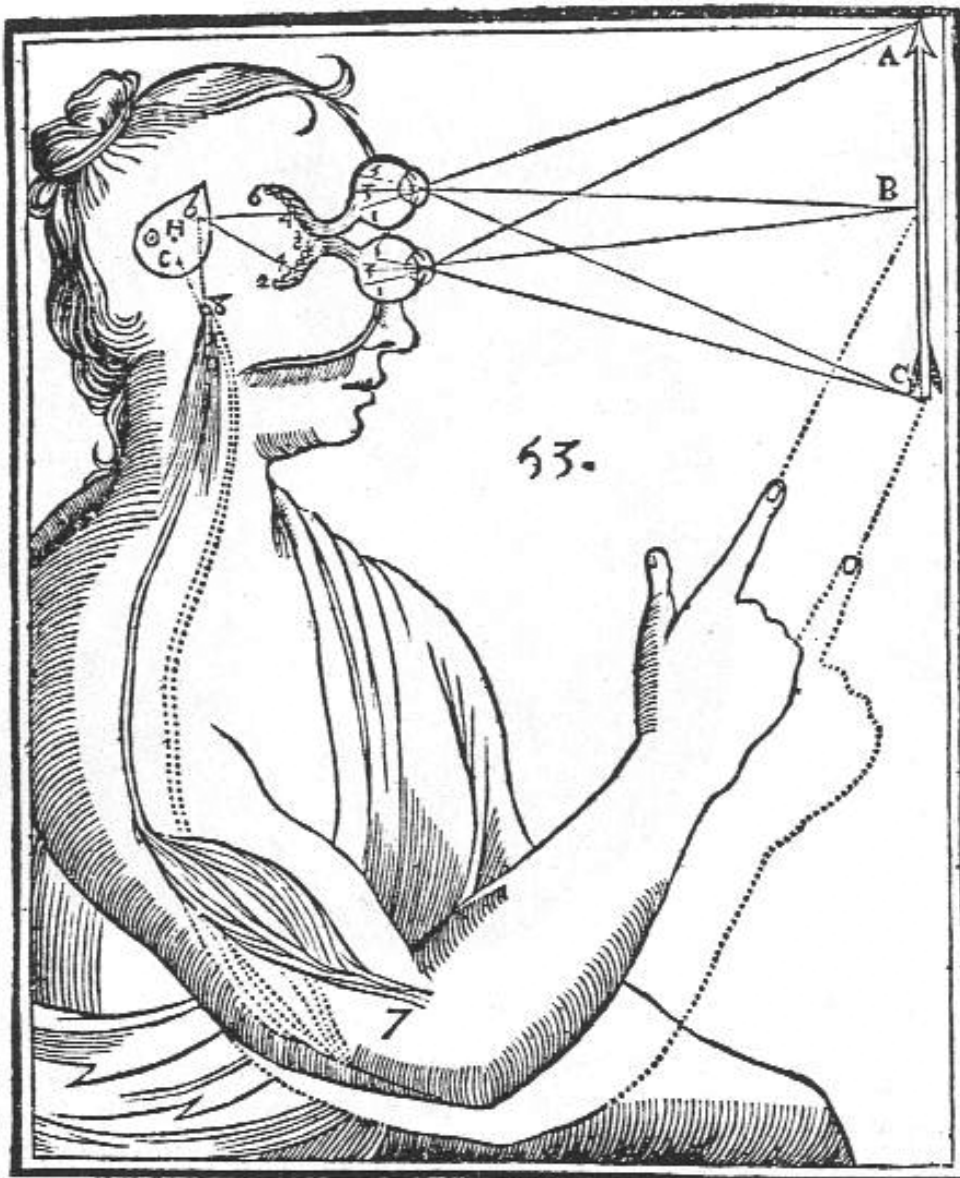

Fig. 3-4. Descartes’ neuromuscular control loop.

⁶² a general form of anatomic structure that will be encountered again as the origin is shifted first to the toe then to the knee.

3.3.3 APPLICATION OF CARTESIAN FREE WILL DIAGRAM

Cartesian Free-Will diagram reflects a psycho-mechanical structure that incorporates *Will* as a definitive *mechanism of choice* between scientific truth and error. The basis of the diagram is the broken line between the mind and the body. The gaps in the line represent the doubts, flaws or uncertainty that naturally exist between the solid parts, which represent definitive axioms, laws or assumptions.⁶³ The background page, which is emphasized here by suppressing several physical dimensions, represents the qualitative unknowns or grey areas from which additional principles still need to emerge.

Axioms are definitions, and hence do not enclose any grey areas. Orthogonal parts of this axiomatic line for example close off an area of scientific knowledge. The overall diagram takes a “doubtful region” of science, the indefinite background page representing all ill-defined factors such as mind, will, aether, spirits, motions etc., and attempts to organize these into formal areas of knowledge.

The Free-Will boundary, the dividing line between mind and body, is based on Descartes’ principle of methodological doubt. (The doubt being the holes between the axiomatic dashes). The free-will makes these choices explicit and hence amenable to review and interpretation. The broken line hypothetically acts as a sort of quantum state ‘black box’ erected between states of ignorance and states of perceived knowledge.

In a classic use of the diagram, Newtonians implicitly use up their Cartesian ‘Free-Will’ option to place Newton’s laws ‘beyond all doubt’ below the broken line in Cartesian-Newtonian scientific ‘scheme of things’. The bulkheads of Galileo’s cabin in a sense create such an intellectual black box that encourages us to ignore the initial accelerations to enable us to formulate the theory of inertia. According to this very popular view, all mechanical objects operating in the so-called human zone of middle dimensions⁶⁴ fall *within* the linear boundaries of Newton’s three laws. In this domain there is apparently no need for improvements, and no exceptions to the laws⁶⁵ notwithstanding Newton’s own explicit reservations.

But Newton himself clearly stated in the *Opticks* that his passive principle of motion taken alone meant that there could be no motion in the world, leaving open the possibility of a subtle interstitial *aether* that regulated amongst other things animal motion. In terms of the Free Will diagram this aether acts as an interstitial fluid amongst the scientific theories, just as it was supposed to act amongst physical atoms. It is not necessarily a physical object like a hyperfine atom, but could appear as a new elemental force or concept capable of circumventing gravitational collapse.⁶⁶

Relativity theory and quantum theory, both first proposed in 1905 obviated the need for the hypothesis of aether. But in biomechanics where these principles are not applied, there is still a need for a passive anti-gravity principle to *explain* why the animate bipedal human body does not fall down quite as easily as man-made mechanical bipedal robots.⁶⁷

⁶³ It is known through many rigorous theorems such as Gödel’s theorem, Heisenberg’s uncertainty principle and the irrationality of geometric lines that there are always “holes” in any scientific theory. Descartes’ *first principle* of philosophy and his *first principle* of human knowledge recognizes this reality.

⁶⁴ Capra, *Tao of Physics*.

⁶⁵ The unquestioning acceptance of Newton’s principles in the biomechanical schools is perhaps similar to the unquestioning acceptance of Aristotle’s philosophy in the renaissance Schools.

⁶⁶ Newton refers to capillary action in the glands as an example of a potential source of action in the animal model. But during gait there are no walls to pull up on. The animate principle that elevates the body must be some form of internalized anti-gravity system. A foot arch that is ostensibly designed to raise the body under its own weight is a good example of this anatomical requirement.

⁶⁷ Manmade bipedal robots tend to topple unless in highly controlled artificial environments. And to paraphrase Dretske (1994) if you can’t make one, you don’t really know how it works.

Hick's (1954) passive arch raising hypothesis provides a promising beginning for such a principle. I also propose that the body of knowledge of physics can be integrated with the body of knowledge of physiology by folding the Free Will diagram along the imaginary Cartesian mind axis [Fig. 3-5].

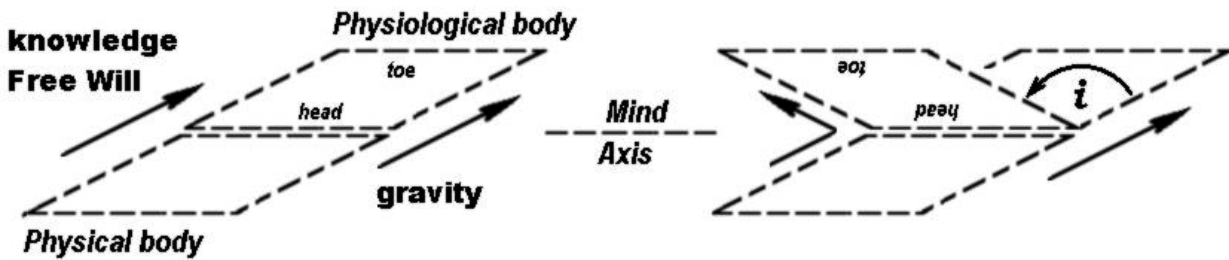

Fig. 3-5. Reincorporating Descartes' physiological and physical bodies of knowledge using the Free-Will diagram and a two phase rotation of (i) in *res cogitans* space.

The folding of the mind vector in this manner is apparently arbitrary. However, the mathematical changes involved can indeed be shown to conform to Descartes' *res cogitans* mathematical structure of mind. When applied to the Keplerian-Galilean constrained body, this folding causes the mind vector, historically aligned with the control of gods and kings to reverse its sign with respect to the gravity vector.⁶⁸ Incidentally this brings the toe-end of the Cartesian physiological body into more intimate alignment with Descartes' theories of the earth, and his missing fifth and sixth part on animal physiology.

⁶⁸ One might also leave the classic scientific hierarchy of minds undisturbed and introduce a 4D gravity curvature model for physiological body.

3.4 MATHEMATICAL FRAME OF MIND

3.4.1 CARTESIAN MINDSET

Descartes' *Rules for the direction of our intelligence's in the sciences* explains the process of division of problems into smaller parts for analysis. But taken to its logic conclusion, sooner or later all problems will require atomic, sub-atomic and aether-like solutions. Descartes' scientific method however applies only to body because unlike an infinitely divisible body, he believed that mind consisted of an *indivisible* substance, the *res cogitans*.⁶⁹

- ❖ The *res cogitans* model of an entirely imaginary mind-substance that is introduced here, broadly fulfills the same role normally assigned to the entirely imaginary physical aether.
- ❖ The *indivisible* character of the Cartesian mind can be directly related to the geometric center point of Aristotle's geometric hinged figure [Fig. 3-1], which Aristotle claims is also indivisible.

The introduction of a formal mathematical system to deal with concepts that are intrinsically intractable to physics is a necessary step that is needed to assess the logic of the Galilean invariance and hence solve the anatomical problem of initiating gait.

3.4.2 IMAGINARY MINDSET

Even though the mind is imaginary, it appears to be a fairly novel hypothesis to use an entirely imaginary mathematical field to describe its action. The fundamental mathematical imaginary unit 'i' is defined as the square root of -1 . This dimension can be combined in at least two different ways to describe an imaginary field. One could for example use the familiar Euclidian 3D orthogonal *res extensa* as a model; or one could raise i to the power i, which according to Gullberg (1997) forms "the most imaginary number imaginable". Both these alternatives are now explored.

1. Orthogonal Frame.

An orthogonal frame is defined where each dimension is independent of the others.⁷⁰ Dimensional permutations of the imaginary unit are:

- ❖ i^0 which by the way of logarithmic integer continuity, is equal to the mathematical identity 1.
- ❖ i^1 is a 1D line or imaginary vector i that has no real form.
- ❖ i^2 is a 2D area ($i \times i$) that is real, but has a negative coefficient (-1).
- ❖ i^3 is a 3D volume ($i \times i \times i$) that is both negative and imaginary (-i).
- ❖ i^4 is a 4D field ($i \times i \times i \times i$) that is a free unit vector with a real value of 1.
- ❖ i^5 is similar to the imaginary vector i^1 .

The unitary imaginary field appears uniquely defined by four rather than three unique orthogonal dimensions because $i^0 = i^4 = 1$ and $i^1 = i^5$ indicates that the sequence repeats with an exponent of 4. Hypothetically the real entity of this 4D *res cogitans* field is the principle real Cartesian identity, what Descartes refers to as the "I" in his primary principle "I think therefore I am".

⁶⁹ Descartes points out in Article XXX *Passions of the Soul*, that one can be in two minds, but not in two souls or half a soul. Unity and indivisibility are characteristics the scholastics attached to the soul.

⁷⁰ In classical mechanics is that there are only 3 orthogonal spatial dimensions.

The 4D imaginary notation developed here was not used by Descartes.⁷¹ He was content with the clear and distinct geometric idea that $2+2=4$ and $2 \times 2=4$. These mathematical operations represent two of the three basic mathematical notations, the additive and multiplicative.⁷² The third form is the positional notation.⁷³ The essence of the positional notation I believe is conveyed by the capitalization of the Free-Will postulate and Aristotle's honorable hierarchy.⁷⁴

2. Imaginary Frame.

The field structure of a purely imaginary 4D frame of reference like the hypothetical MTP-1 center has no single point of origin. Similarly no one has yet found the actual physical seat of the soul or mind, which is both a product and source of imaginary ideas.

According to Gullberg (1997) the most imaginary number imaginable is i^i . Euler's formula⁷⁵ can be used to show that i^i is in fact a real number $e^{-\pi/2}$ (see also Penrose, 1989). Using this definition the *res cogitans* is a *real quantity* that is composed of both *transcendental* (e) and *irrational* (π) components. This differs from the *transcendental* but *rational animus* of the pre-Cartesian scholastics, even though there are mathematical similarities between their philosophical systems.⁷⁶

3. Complex Frame.

One way to create a mathematical origin, is to combine two of the four imaginary dimensions to create a real plane. The 4 imaginary coordinates reduce to 2 imaginary coordinates and 2 real coordinates when combined by the principles of Cartesian analytical geometry.⁷⁷ Then the two remaining imaginary components are freed to create a complex orthogonal Argand frame with spatial representational vectors $i, -1, -i, +1$ [Fig. 3-7].⁷⁸

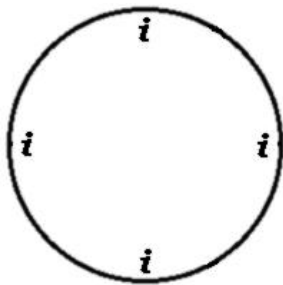

Fig. 3-6. Disorientated imaginary mind-space.

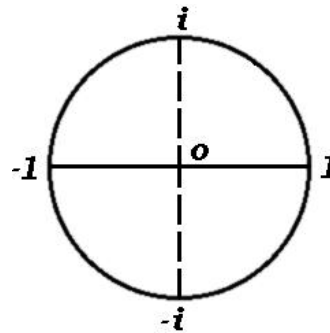

Fig. 3-7. Complex orientation of real-imaginary mind-space.

⁷¹ The first trace of a 4D structure of mind is through Schopenhauer, who was strongly influenced by Eastern philosophy (Honderich, 1995). Schopenhauer's works include *On the Fourfold Root of the Principle of Sufficient Reason* (1813); *The World as Will and Representation* (1818); *On the Freedom of the Will* (1841).

⁷² Neither of these two simple examples however involve a negative numeric form encountered in the complex sequence defined by the multiplication of the imaginary unit. Descartes in fact referred to "-1" as a "false root". The square root of this false root (the imaginary unit) is in this sense the cubic false root. A non-existent (negative/internal) mind volume to complement his positive cubic xyz body volume perhaps?

⁷³ Gullberg (1997) p.32

⁷⁴ A positional hierarchy is fundamental to the philosophy of the Doctors of the western church such as St Augustine (AD 389) and St Aquinas. Although not a mathematical philosophy at all, its strict application conditioned the minds of many scholars. The position of the hierarchical First Mover or First Cause bound together science and religion in an unfortunate brace.

⁷⁵ $e^i = \cos(x) + i \sin(x)$.

⁷⁶ Galileo by observing the irregularities on the moon threatened to replace the irrational area (π) of the perfect celestial spheres, a necessary component of the philosophy of the school system. Their objections to Galileo were however not expressed mathematically.

⁷⁷ The principle of analytical geometry is based on the notion that $2 \times 2=4$ as seen by drawing 4 squares with sides of 1. This perceived geometrical relationship between areas is then linearized algebraically by the premise that $2+2=4$.

⁷⁸ For the historical invention of the complex mathematical plane see Gullberg (1997) pp.87-88.

But the unit vector i in a truly imaginary field like the disoriented mind [Fig. 3-6] has no real point of origin at all.⁷⁹ The difficulty is that the Argand origin ($0 + 0i$) is arbitrarily defined as real due to the residual real coefficient (0). Also the real plane needs to be orientated and given the descriptive property of rotation, which is only possible if a real fixed-point origin exists. Thus the different postulates, Aristotle's animate unmoved origin and Newton's mass centered origin, are fundamental to the mathematical description of the anima.

Physically the 3D body associated with the imaginary Cartesian identity in positional notation has dimensions $i^1 i^2 i^3$ which are bounded between $i^0 = i^4$. The portion that comprises the 3D body vector ($i, -1, -i$). The negative sign of the bounded real component (-1) I believe reflects the intrinsically complex *resistive* character of body. Furthermore, the complete mind (i^4) which reduces to the Cartesian identity (1) is most easily juxtaposed with the notion of resistive body (-1).

A complete hypothetical individual is formed by adding the full imaginary identity $i^4 = 1$ of the *res cogitans* to this 3D body form. Producing an individual with mathematical dimensions $[i, -1, -i] + [1]$. The terms in square parentheses represent the body and mind substance respectively. If the two imaginary components in the body term are ignored, which is quite easy since they are imaginary, it is possible to replace the imaginary-bounded component of body (-1) with Cartesian coordinates x, y, z . The mind substance (1) can be replaced with either ($-i^2$) or (i^4).

The second order form of Pythagorean theorem⁸⁰ can then be used to link these dimensions through their only real manifestation (a real area, notation s^2) to arrive at the mathematical equation of an 4D body form $x^2 + y^2 + z^2 - i^2 = s^2$. This is the basic equation of 4D relative physics⁸¹ with which Einstein denied any form to the luminiferous aether.⁸²

It is interesting that in quantum physics, the imaginary orthogonal components ($i; -i$) between the opposed real states ($-1; 1$) [Fig. 3-7] are used to represent opposite quantum states called *spins* (See Penrose, 1989). This has an important parallel when the hypothesis of a ground reaction torque is encountered later.

3.4.3 AGREEMENT OF MINDS

Reassembling the Cartesian identity from its components, requires that one free mind (*res cogitans*) be combined with one free body (*res extensa*) to form a free animate individual. The laws of classical mechanics however only currently describe how the material *res extensa* of one body combines with the material *res extensa* of another under conditions of rest or uniform motion. But they appear to ignore the combination of *res cogitans* altogether. This ignorance is not actually an oversight, but is a systematic error incorporated in the Galilean invariance.

The Galilean invariance combines 4 frames of reference. The two *res cogitans* and two *res extensa* of the two friends in a hypothetical cabin of a ship.⁸³ The fusion of the *res cogitans* of any two individuals occurs when both agree to contribute one imaginary component "mind form" to generate two free vectors of the real "body form" [Fig. 3-8]. The merger of minds once completed appears to generate a real vector [Fig. 3-9] that points separately to the center of each involved mind. The

⁷⁹ The purely imaginary frame has no real zero origin ($0i$). Which is subtly different from the complex zero origin with a zero but nevertheless real component ($0 + 0i$). The Argand plane itself is a section of a 3D stereographic projection of a 4D Reinman spherical surface with an origin at negative infinity (Penrose, 1989 p.344). The 4D Argand origin is derived by splitting an infinite Maclaurin series expansion of sine and cosine in Euler's formula $e^i = \cos(x) + i\sin(x)$ into positive and negative components thereby assuming that the origin of the Taylor expansion is at zero (Gullberg 1995, p.770-792). The mathematical philosophy behind these assumptions and their impact is beyond the scope of the present thesis.

⁸⁰ Pythagoras's theorem is quite versatile in this regard. Friedrichs (1965).

⁸¹ Einstein (1951) p.60, equation 54.

⁸² Whether it is possible to use a similar equation to replace Newton's neural aether remains an open question because in this thesis I deal primarily with the first order real 2D forms of inertia and gravity rather than the geodesic 4D gravity-inertia equivalence in general relativity.

⁸³ Galileo commands "Shut yourself up ... in the main cabin below decks on some large ship with a friend".

internal similarity of the final products becomes apparent when a sign convention is defined relative to each's own primary personal outward vector *i*. The resultant is two individuals of like mind,⁸⁴ who bring a perception of clarity to the disoriented emergent state during the actual merger [Fig.3-9].

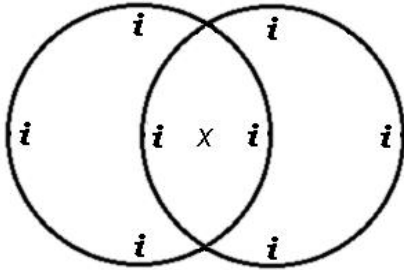

Fig. 3-8. Two independent minds merge.

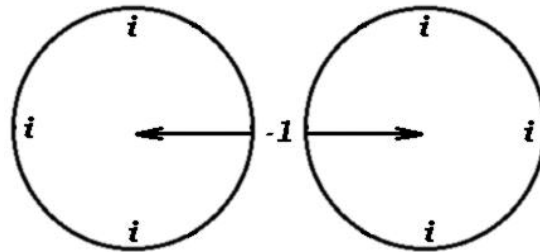

Fig. 3-9. Re-emergence of like-minds with common mechanical reference vector. The 'Galilean friend' model.

A real mechanical reference that links the Cartesian mind *res cogitans* to the body *res extensa* can be generated from these mathematical forms in two ways. Either as a Galilean group, or as an individual by:

- ❖ aligning two independent minds [Fig. 3-8] in orthogonal 3D temporal-spatial space [Fig 3-9].
- ❖ at the line of intersection of two real-imaginary planes of a single mind [Fig 3-10].

Hypothetically these basic *res cogitans* forms form the basis of Galileo's "empirical scientific" model incorporating collective empirical agreement, and Descartes' introspective "philosophical" model that is consistent within itself. In both cases the vectors are real. It remains to be seen how these forms can be related to Aristotle's animated unmoved mover.

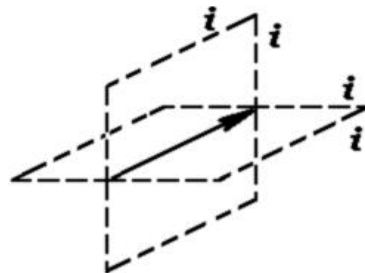

Fig. 3-10. The Cartesian individual mind. A real axis or dimension constructed from individual four dimensionless imaginary coordinates.

3.4.4 MATHEMATICAL ORIGIN OF ANIMATE FORCE

According to Jammer (1957, p.90) Kepler (1621) was the first to describe the universal *anima* as a physical force, when in an annotation in his *Mysterium cosmographicum* he wrote:

"If you substitute the word "soul" for the word "force" then you have the very principle on which the celestial physics of...Mars etc. is based."

Kepler described Mars as a *body constrained* by chains sweeping out equal areas in equal times [Fig. 3-11]. The area was an ellipse with the sun at one focus, the other focus being "empty". Newton

⁸⁴ These individuals of like mind may be classed as 'friends'.

(1687) took this imaginary 2D *area* that is swept out by the planets, and coupled it directly to a *gravity vector* in 3D space using the Galilean invariance.⁸⁵ Einstein (1915) revealed gravity to be analogous to *free fall* along a 4D geodesic of curved time and space.⁸⁶ Penrose (1989) has even envisaged a primordial link between the behavior of the animate mind and an even more advanced quantum theory of gravity.⁸⁷

The relevance to animate anatomy is that Kepler introduced a second (imaginary) focus into planetary theory. This split the indivisible center of Aristotle's Prime Mover. I believe that a similar effect is bound to happen in biomechanics, when a second (imaginary) focus is introduced in the form of a cam axis into the standard system of rigid linkages.

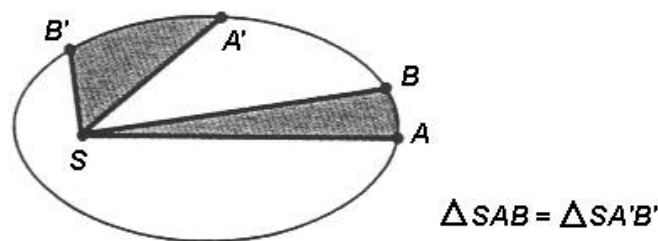

Fig. 3-11. Kepler's 2nd Law equating the Universal Anima or Prime Mover to an elliptical area.

Morton (1952) strongly emphasized the reciprocal link between gravity and the locomotion of the human body in his study of gravity and man. There may however be a direct link from Aristotle *anima* to the *anatomical cam* through the concept of swept area that does not detour through Newton law's at all. This direct link may I believe circumvent the intractable biomechanical problem of initiating gait entirely, which arises when one has to move from a state of rest to state of uniform motion.

An elliptical area is drawn geometrically using a fixed length of chord attached to the foci [Fig. 3-12]. I envisage that a similar mechanism applies for a fixed length muscle model that is needed to supplement the variable length osseo-ligamentous cam action. The chord here represents the anatomical muscle, and the ellipse the extended cam profile produced by the bone. The bone cam hypothetically exercises control by forcibly separating out the foci of the muscle insertion and origin. The muscles exercise control in the earth's gravity field by either varying or simply maintaining their lengths.

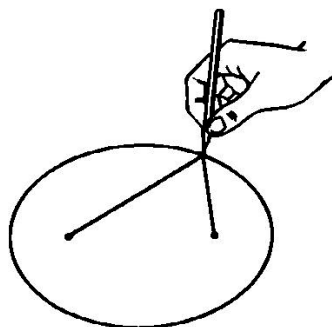

Fig. 3-12. Fixed length of chord between foci traces an ellipse. A model for animate muscle.

⁸⁵ Newton (1687) described gravity as a 3D mathematical central force.

⁸⁶ Einstein proved that the physics of gravity in a local region, for example the cabin of Galileo's ship or a modern free-falling elevator, is indistinguishable from inertia except by convention. Basically in the classic Galilean-Newton 3D model the vertical and horizontal components are independent (orthogonal) and go by the names gravity and inertia. The two can only really be distinguished in Newtonian law under the condition of uniform motion or rest.

⁸⁷ Penrose (1989) linked the mysteries of the mind to the yet-to-be-discovered "correct theory of quantum gravity".

3.4.5 MATHEMATICAL PRINCIPLES IN GALILEO'S DIALOGUES

It is really the hypothetical nature of the transition from rest to uniform motion that effectively renders the problem of initiating of gait intractable. It is therefore vital to investigate the mathematical structure of this historical statement. Remarkably the roles of the characters in Galileo's Dialogues can now be mathematically re-defined to analyze the classic mode of agreement that up until now has been implicit in the Galilean invariance.⁸⁸

The 4 positions in the complex model (i, -1, -i, 1) can be assigned to specific characters in Galileo's *Dialogues*. The imaginary numbers are properly assigned to Galileo's friends because Galileo refers to their Dialogue as a "mathematical fantasy".⁸⁹ The interlocutors Salviati (i) and Sagredo (-i), are Galileo's imaginary friends who in combination arrive at a real opinion (1) and an erroneous dialectic opinion (-1). The respective *res extensa* of these friends are aligned⁹⁰ by common observations of a free-falling drop of water.⁹¹ Galileo's then attempts to align the *res cogitans* of two of the interlocutors with the opinion a third individual Simplicio who as a representative of a whole school of thought (-1) that is naturally *opposed* to the views of Galileo's friends.⁹²

It was Galileo's literary style to show that Simplicio held dogmatically onto Aristotelian beliefs that Galileo then exposed as mutual contradictions. Aristotle's unmoved mover is as we have seen, is related through *de Caelo* to *de Anima* through the *First Cause* of motion the Prime or Universal unmoved mover. The crucial issue here is the mathematical explanation as to how the two separate Galilean friends ultimately can be persuaded to each perceive internally in their minds the *same nature* of external events.

Indeed there is an infinite amount of natural mathematical confusion as to the true vector direction during and before the merger of the Galilean minds—the disoriented ($i \times i$) subset area in Fig. 3-9. Historically Simplicio fulfills the role of this terminally "confused" position during the actual merger of minds, that naturally in Galileo's friends' minds defaults to the (-1) position. Galileo appears to have used this property to good effect to undermine the dogma of the Aristotelians, through the repeated contradictions projected onto Simplicio and hence Aristotle.

The fourth key person excluded from Galileo's dialogues in the cabin is the ship *helmsman*. The helmsman it should be recalled is the all-important controller who is required to maintain uniform motion of the whole ship while Galileo observes his experimental controls. In a three-dimensional dialogue, the hypothetical helmsman has no formal position. But appears only as an obedient automaton, or slave with the power to control the ship, but not the authority to deviate from a straight-line course ordered by the captain. He is here potentially the product of the fourth imaginary dimension (+1).⁹³

Any action of free will on the helmsman's part (accelerations or deviations from unity in the 4th dimension) would be measured as jolts or deviations from uniform motion, and appear as an *experimental artifact*. Newton's laws would explain away these artifacts as an *impressed force* acting on the ship, or strictly to motions of the tides and the sea. However in our *animate ship* analogy with the human being carrying the bowl of water, they might appear as new laws of the *anima*. The animate bipedal body action force.

⁸⁸ It is known from modern physics that the very act of scientific observation can play an active role in the solution, rather than merely existing as a passive spectator.

⁸⁹ In a *Note to the judicious reader* (de Santillana, 1953, p.7).

⁹⁰ The friends may be said to be of one mind.

⁹¹ Torretti, 1983.

⁹² The name Simplicio is a reference to Simplicius (c.600 AD) who wrote a commentary on Aristotle's *de Caelo*.

⁹³ In the scholastic model the helmsmen are the cherubs and angels that maintain the heavens in motion.

All the key elements discussed above appear in Galileo's frontispiece [Fig.3-13]. Notice the ship in the middle distance and the tower to the right, symbols of the Galilean invariance and the Galilean pedestal respectively. The cherubs elevated in the top corners are the scholastic representatives of the Prime mover, "Aristotle's god". Inclusion of these elements in a modern free-body diagram is of course discouraged under the criteria of excessive extraneous details.⁹⁴ They are important however when reassigning animate potential to inanimate free-bodies from first principles.



Fig. 3-13. Drawing in Galileo's *Dialogue on the Great World Systems—Ptolemaic & Copernican*.

⁹⁴ Meriam (1980, p.75). "Step 4...Note that the free-body diagram serves the purpose of focusing accurate attention on the action of external forces, and therefore the diagram should not be cluttered with excessive extraneous information."

3.5 FREE BODY DIAGRAM OF THE UNMOVED MOVER

Aristotle observed early in his *Movement of animals* that the helmsman cannot personally move the ship unless he pushes on something unmoved outside.⁹⁵ Nor can he blow into the sails. Galileo however is unconcerned with the mechanics of the ship's propulsion.⁹⁶ He specifically encourages us to ignore these particulars, "shut yourself up with a friend in the cabin of a large ship" he urges.

Aristotle's ship is depicted here as a simple punt [Fig. 3-14]. The necessary connection detail between the punt pole and the ground is circled about the point of constraint. Hypothetically the pole resting on the sea-bed is a description of the *external* unmoved mover. Geometrically this diagram looks very similar to Aristotle's cryptic "free-body diagram" [Fig 3-1].⁹⁷ A description of the *internal* unmoved mover free-body is provided by the deck boards under the feet of the oarsman/helmsman. When the translating deck boards are reduced to a state of rest and a hinged oar fixed to the deck is used, a diagram of the *internal* unmoved mover is produced [Fig. 3-14.b].

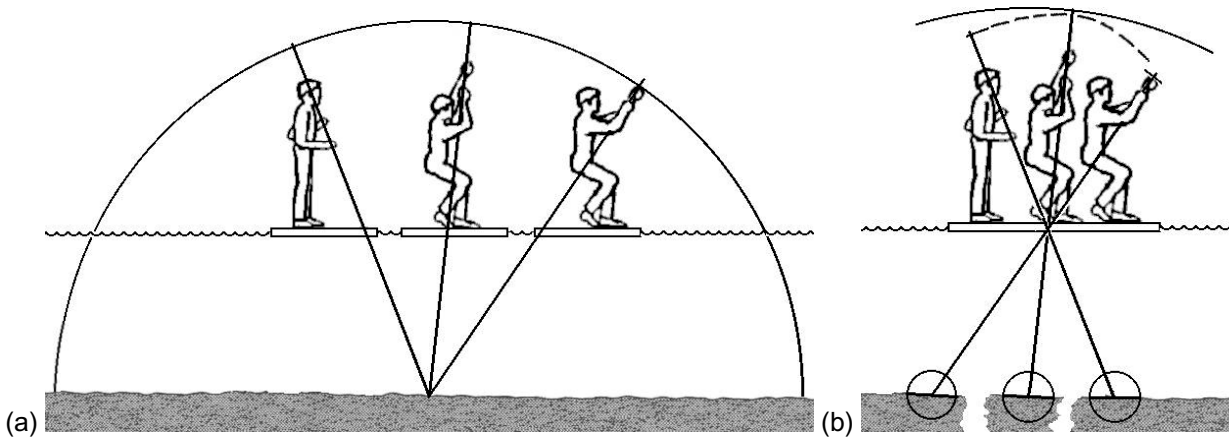

Fig. 3-14. Aristotle's helmsman/oarsman required for propulsion. (a) Diagram of external unmoved mover. (b) Diagram of the internal unmoved mover with internal translation brought to rest.

Aristotle's free body diagram can be reconstituted for gait with the first metatarsal acting as the propulsive punt-pole. The pole corresponds here to the "instrument" of Aristotle's anima—the metatarsal bone. Essentially, the upper end of the punt-pole in Fig. 3-14b plots out the cam shape, as does the metatarsal in the unmoving kinematic projected transformation configuration.

If the sea that supports the ship is adjudged comparable to the ubiquitous aethereal support medium, then the pole feeding into and out of the water mimics Newton's criterion for inducing neuromuscular "contraction and dilation" in the aethereal medium. The *varying proportion* of the propulsive pole in the water is what creates the cam profile.⁹⁸ In the human foot this slack is absorbed by metatarsal bone depressing into the soft tissues. The constrained horizontal motion of the floating punt that is necessary to create the internal unmoved mover diagram [Fig.3-14b] by forcing the punt positions into coincidence is perhaps analogous to the plantar aponeurosis tension.

⁹⁵ *Movement of animals*, 698b.

⁹⁶ The ships at anchor in Fig. 3-11 illustrate this point. Jammer (1957) points out that Aristotle has difficulty explaining how motion continues without inertia, but it is Galileo that has difficulty explaining how motion *starts*. It is necessary to combine the models to explain adequately how the motion starts and how it continues.

⁹⁷ *Movement of animals*, 698a.

⁹⁸ See Section 2.3.2. I also venture that it is similar perhaps to the rigid body lengthening first suggested by Fitzgerald (1892) as an explanation for the lack of a discernible aether in physical experiments.

4.

ANIMATING THE FIRST METATARSOPHALANGEAL JOINT

“To speak in summary fashion for the present—that which produces movement instrumentally is found where a beginning and end are the same, e.g. in the hinge joint.” — Aristotle¹

4.1 PREVIOUS WORK

4.1.1 BACKGROUND

Aristotle claims in *de Anima* that motion originates in the hinge joint, and that the movement begins from this. Newton’s third law² indicates that the hinge in question is the MTP-1 of the stance foot. These motions of the MTP-1 have already been measured in five inanimate cadavers in a previous dissertation (Nevin, 1995). This chapter presents a *post hoc* analysis of this novel previous work except that it uses the Aristotle’s animate frame of reference for the first time.

Several authors have described the kinematics of the MTP-1 as a vector motion of the proximal phalanx.³ But an obvious deficiency in these accounts is that it permits the phalanx to move into the ground.⁴ This anomaly persists because it is much easier to wiggle the toe with the foot raised, than it is try move the whole cumbersome body around the toe while it is pressed onto the ground as occurs during gait. An original method for imagining the toe as an unmoved mover circumvents this problem.

4.1.2 ARISTOTLE'S UNMOVED FRAME OF REFERENCE

Already analyzed for its historical significance,⁵ Aristotle’s theory of the unmoved mover restated below is applied here to animal motion as originally intended. As Aristotle explains:

“Just as there must be something *in* the individual which is unmoved⁶ if it is going to move itself, so even more there must be something unmoved *outside* the animal, supported upon which that moves itself moves.”. He later continues “one of the extreme points must remain at rest, and the other must move; we said that the mover must support itself on that which is at rest.”

Thus to verify Aristotle’s hypothesis, the reference frame attached to the extreme point of the toe must be brought to rest with respect to the frame of support. This is achieved using the method of kinematic projected transformation.

¹ *De Anima*, III.10.

² Invoking Newton’s third law is potentially redundant because Aristotle in *Movement of animals* 702a, observed that, “passive and active have the same sort of nature *as we have often said*, whenever one is active and the other is passive, and neither fails to fulfill its definition, immediately the one acts the other is acted upon.”

³ Sammarco, (1980); Shereff et al. (1986); Hetherington et al., (1989).

⁴ Fig. 2-3.

⁵ Discussions of the universal unmoved mover can be found in *Physics VII* and *De Caelo* where presumably there is no mention of the animal unmoved mover. There is nothing sinister about this. In ancient philosophy all motion was animated, and to talk of *animated* motion was to exaggerate.

⁶ Preus (1981) recognizes an ambiguity in the translation from Greek. He prefers *unmoved mover* to the equally feasible *immovable mover* because the former makes a weaker claim.

4.1.3 KINEMATIC PROJECTED TRANSFORMATION

A transparent reference grid was clamped directly to the proximal phalanx, so that when the great toe was wiggled, the reference frame moved with the phalanx. Thus making it appear from the phalanx's perspective that the phalanx is stationary and that it is the metatarsal that moves, and not the other way around. The term kinematic projected transformation (KPT) is appropriate for this method because the *kinematic*⁷ motion of the phalanx is *transformed* by *projecting* an image of the stationary bone onto the frame of reference of the moving bone, making the unmoved bone appear to move and vice versa [Fig. 4-1]. It so happens⁸ that the KPT method reproduces the basic animated picture of the relative rotations of the MTP-1 that corresponds with Aristotle's animated unmoved mover.

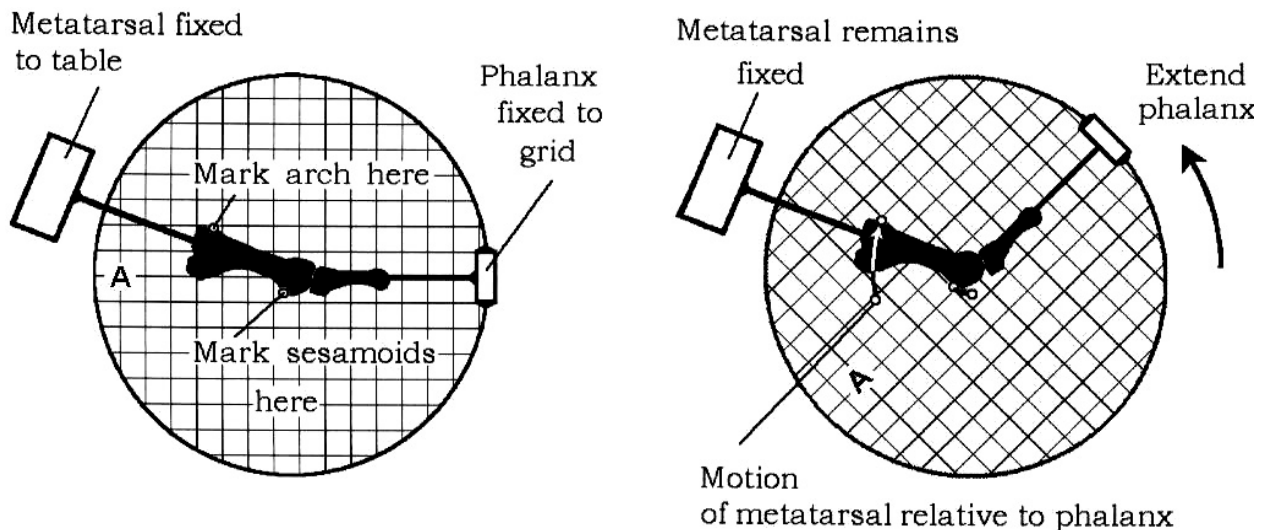

Fig. 4-1. Kinematic projected transformation of the MTP-1. A novel method for describing the proximal phalanx as Aristotle's internal unmoved mover (Nevin, 1995, 1997).

4.1.4 CADAVER LAYOUT

The previous experiments were performed on five intact cadavers in a laboratory [Fig. 4-2]. All components and frames of reference are labeled in bold letters in the figures.⁹ The specification of some components is left deliberately vague¹⁰ except at the sites of physical intervention in the system (the junctions labeled **1-8**) where there was a movement detected or amputation effected.

The inanimate cadavers lay supine on a heavy dissecting room bench **B** on the ground **G**. One cadaver foot **F** was positioned protruding over the edge of the bench supported at the calf of the intact cadaver **C**, with the first metatarsal approximately horizontal. Two clamps were then inserted through skin incisions along the medial side of the proximal phalanx **P** and along the first metatarsal **M**. This procedure effectively made the clamps rigid extensions of the bones and therefore the clamps are also labeled **P** and **M**.¹¹

⁷ Kinematic refers to motion according to position and time only. Kinetic refers to the mass of the components. The form rather than the mass of the bone is important in these experiments. Therefore the method is a kinematic one.

⁸ These experiments were originally performed to produce a classic description of the relative rotations of the joint because as Meriam (1980, *Dynamics* p.327) advises, "Without the ability to determine accelerations correctly from the principles of kinematics, it is frequently useless to attempt application of the [Newton's] force and moment principles of motion" it being "necessary to first master the kinematics and *relative accelerations* before proceeding."

⁹ See text for abbreviations. Also bookmark Fig. 4-5 p.57 and the Glossary.

¹⁰ Actions and reactions between parts are always equal and opposite in terms of Newton's third law and Aristotle's text, and hence cancel.

¹¹ Aristotle refers the hinge joint sometimes as acting two and sometimes as one. Here it is assumed that the clamped junction acts as one. Therefore the same notation is used for the parts. The mechanics at the crucial bone-clamp interface will be addressed in Chapter 5.

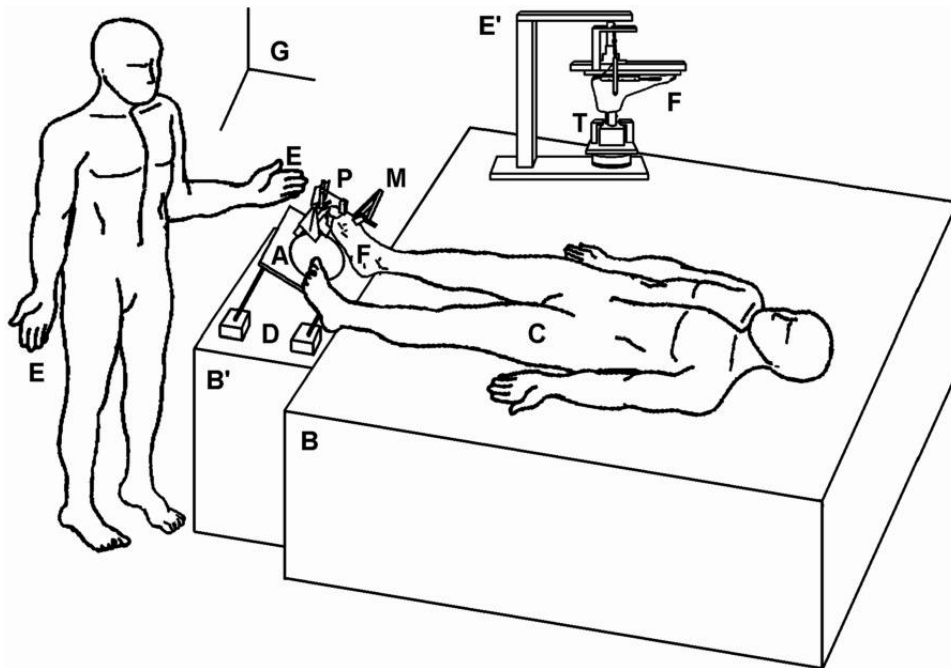

Fig. 4-2. Kinematic projected transformation cadaver layout.

The clamp-on kinematic apparatus consisted of the two separate parts. One part was an articulated mechanism P_i rigidly clamped to the phalanx [Fig. 4-3]. The other was a rigid non-articulated C-shaped frame M that held the metatarsal shaft parallel to a drawing board A_1 [Fig. 4-4]. A_1 was the principle kinematic plane where the major movements of the MTP-1 in the sagittal plane were recorded. The four legs of the drawing board frame A_1 were placed on a lower portion of the bench B' and adjusted until A_1 was *parallel* to the metatarsal sagittal plane M_1 .¹² Another orthogonal plane A_2 was assumed *perpendicular* to both the sole of the foot A_3 and the drawing board surface A_1 producing a cross-sectional view of the metatarsal shaft M_3 .

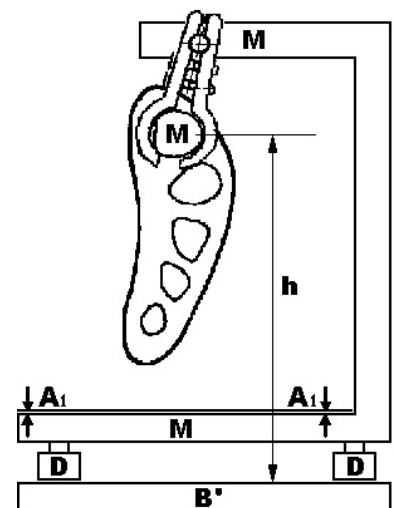
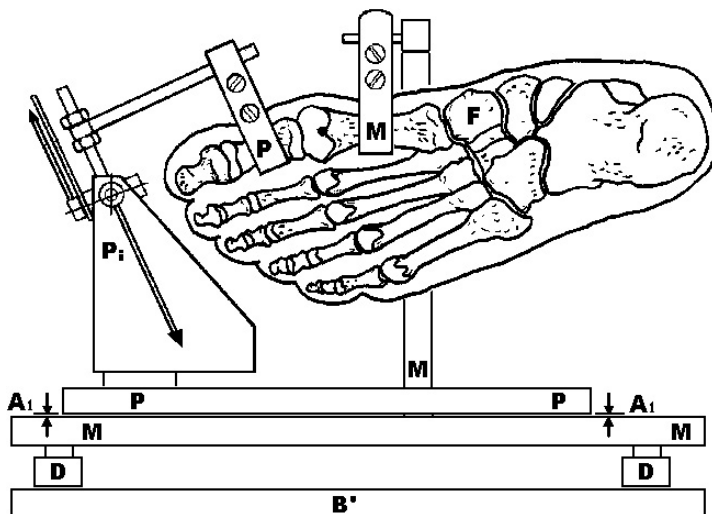

Fig. 4-3. MTP-1 clamp detail from plantar view (plane A_2). **Fig. 4-4.** Transverse view of metatarsal clamp (M_3).

¹² See Fig. 4-5 on page 57 for the alignment of the various frames and axes. It is advisable to bookmark page 57 as a referral.

Following Hicks (1954) some foot supination was anticipated when the toe was dorsiflexed. Therefore the drawing board legs supporting **A** were mounted on soft foam rubber cushions of unspecified compliance **D**.¹³ In a disused corner is placed a hypothetical device **E'** typical of that used to artificially enclose, clamp and compress amputated anatomical specimens of the lower leg.¹⁴

4.1.5 GREAT TOE KINEMATICS

The free-body procedure requires that the entire boundary of the body be specified. Two landmarks are at opposite ends of the rigid metatarsal are sufficient for this. Thus two anatomical landmarks from the metatarsal were projected onto the principle plane **A₁** using two orthogonal abutting right squares. One landmark was located at the sesamoid bones beneath the MTP-1. The other was located at the dorsum of the foot, at the base of the first metatarsal near the top of the arch [Fig. 4.1]. Of the two landmarks, it is the kinematic behavior of the *proximal* metatarsal that is of principle concern.¹⁵

The proximal phalanx bone **P** was clamped to a mobile reference frame **P_i** that consisted of the bracket and bone clamp connected via an universal joint to a vertical sliding extension attached to a transparent plastic disk **P₁**.¹⁶ This disk which had rectilinear gradations inscribed under it [Fig. 4-1] was placed flush but loose on top of the drawing board **A₁** so that all three of the main sagittal planes—that of the phalanx **P₁**, metatarsal **M₁** and principle plane of the KPT itself **A₁**—appeared coincident in the sagittal view.¹⁷

The universal joint **P_i** mounted on top of the vertically sliding bracket allowed unfettered MTP-1 articulation within the physiological range. The point of rotation had three degrees of freedom; as did the plane of translation—a total of six degrees of freedom. Except the origin of rotation was separated by a nominal distance **h** from origin of the translating coordinates. Metatarsophalangeal bone alignments outside the sagittal plane **M₁** were indicated by two pointers attached to the two shafts of the universal joint **P_i** that could be locked in place or left mobile.¹⁸

To move the phalanx, dexterous pressure **E** was applied to the sole of the great toe, which was either plantarflexed by pulling down and dorsiflexed by pushing up. These inputs caused the disk's gradations to slide over the metatarsal landmarks. The positions of which were then marked at successive joint angles directly in phalangeal segment (x,y) sagittal plane Cartesian coordinates in plane **A₁**. Thus it appears that the metatarsal is moving in **A₁** whilst in fact, except for the moderation of compliance **D**, it is constrained to the laboratory frame of reference **B** by gravity **G**.

¹³ It is possible that the magnitude of the compliance **D** relative to **B** effects the kinematic outcome. This effect will be discussed later by considering the compliance of **B** as a rigid or free-floating body support.

¹⁴ This particular device from Huang et al., (1993) was not part of the experiment, but is typical of that used to study the biomechanics of the foot. It is included as an example for the purpose of dialectic review only.

¹⁵ The proximal point on the metatarsal should not be confused with the point on the metatarsal adjacent to the proximal phalanx. The proximal phalanx derives its name from the anatomical relations of the first interphalangeal joint (IP-1) not the MTP-1. Locating the origin of motion in the *proximal phalanx* does not therefore mean, despite its name, that the origin of motion of the MTP-1 is in fact in the *proximal joint segment* that is nearest the heart as Aristotle imagined.

¹⁶ The indices of **P_i** refer to the fact that the articulated (angular) phalanx motion has components in all three (translating) orthogonal planes **A₁**, **A₂**, **A₃**. This is because the two origins do not coincide. See Fig 4-3 and 4-5.

¹⁷ The planes were however physically separated laterally by a nominal height **h**.

¹⁸ Locking the universal joint was necessary prerequisite to determine the kinematics of amputated joints where the soft tissue supporting structures were missing. This locking action and this locking action alone ensured that the amputated MTP-1 could not be classified as a free-body. The results on amputated specimens therefore apply only to constrained bodies.

4.2 RESULTS AND FINDINGS

Several results of the experiment have already been described previously (Nevin, 1995; Nevin, 1997). I will not elaborate unduly on these here. The objective here is to deduce what happens when the various frames of reference are all brought into coincidence with Aristotle's animated frame of reference of the proximal phalanx.

4.2.1 CAM AND HINGE KINEMATICS

The sagittal kinematics of the MTP-1 have been previously lead to the description of the metatarsal as a cam in normal cadavers [Fig. 2-5] and the MTP-1 as a hinge in all surgically altered joints [Fig. 2-6]. To summarize this result, each end of the dry metatarsal nominally moves in a circle, an effect of the naturally incongruent bone surfaces. The distal circle defines a hypothetical camshaft axis in addition to the conventional MTP-1 joint center axis.¹⁹ The proximal portion of the outer circle is defined by the center of curvature of the cam-follower, in this case the 1st cuneiform bone.

If the centers of rotation of the distal and proximal circles were coincident, then the joint motion would definitely be hinge-like²⁰ and the nominal length of the metatarsal bone segment would not alter. The mechanical action of the joint would then be a pulley and lever configuration about a hinge. This *cam action* is important because it allows:

- ❖ The effective segment length of the MT-1 to vary with MTP-1 angle.
- ❖ The metatarsal bony arch to apparently rise with the changing MTP-1 angle.

But an essential conclusion of the KPT is that the *hinge-like motion* about a single origin is associated with a *dysfunctional* anatomical state (Nevin, 1997). This conclusion needs to be emphasized because it implies that most classical biomechanical models that are based on hinge-joint models and rigid segment lengths may themselves be considered dysfunctional because they are not arguably representative of the normal anatomical state. I shall not attempt to justify this contentious issue here, but defer judgement until the functional benefits of the alternative cam model have been determined and demonstrated.

4.2.2 FRACTURE KINETICS

Another result²¹ not adequately explained before, was the presence of unexpectedly large clamping forces that were needed to hold the bones rigid (i.e. unmoved) with respect to the portable laboratory reference frame. The shafts of the metatarsals in cadavers with dysfunctional hallux pathologies,²² both fractured under what was perceived to be the minimum clamping pressure needed to hold the metatarsal unmoved during passive hallux dorsiflexion.²³ The shafts of these bones were *perceptively weaker* than of those bones in feet without MTP-1 dysfunction, where no fractures were observed to occur.²⁴

¹⁹ The joint center was located by a center of gravity iteration of points on the peripheral locus, which in effect produces a series of perpendicular bisectors of consecutive points. Similar to Reuleaux's method (Rose and Gamble, 1994, p.38-39).

²⁰ The difference between the cam and hinge is highlighted in Fig. 4-7.

²¹ Nevin, (1997 pp.133-4).

²² 1 specimen hallux valgus; 1 specimen hallux rigidus; 3 normal specimens.

²³ The weak pathological metatarsal shafts prevented the prosthesis design from progressing to clinical trials. The anticipated ethical problem of inducing fractures in living patients, motivated the search for a *theory* capable of projecting the results in cadavers to living subjects. The concluding Section 4-5, *Re-animating the cadaver*, is aimed at resolving this problem.

²⁴ The experimental study was limited sample of only 2 pathological specimens. This result is therefore qualified as a *postulate* .

Metatarsal shaft fractures were severe enough to prevent *in vivo* trials of the prosthesis design. Clinically, there is already a disturbingly high proportion of clinical MTP-1 implant failures.²⁵ Therefore an important question had to be asked, and preferably answered by ethical theoretical means.

- ❖ Do the metatarsal fractures detected in cadavers predict fractures mechanisms *in vivo*?
- ❖ And if so, how?

It was the search for answers to these practical questions that provided the incentive and ethical motivation for the present thesis.

4.3 POST HOC ANALYSIS

The mechanical experiments were performed on passive *inanimate* cadavers. These need to be modified to describe *animate* motion. This is achieved by:

- ❖ Setting up a suitable frame of reference to include an Aristotelian *unmoved mover* so that the body has the animate capacity to *initially move itself*.
- ❖ Rearranging the inanimate *in vitro* cadaver configurations detailed above so as to emulate animate gait *in vivo*. A process I refer to here as *re-animating the cadaver*.

To fully animate the cadaver, the body has to remain intact, and all the experimental paraphernalia needs to be eliminated—the experimental analogue of isolating the free-body from everything. Every action is then necessarily internal because no action can pass across the body boundary.²⁶

An important consideration is that the cadaver is not yet moving itself, but is being moved by the experimental intervention. Thus it is still necessary to eliminate all the constraints of the experimental apparatus except the outside ground support **G** to fulfill Aristotle's condition of "that which moves itself".

4.3.1 KINEMATIC ARTIFACTS—THE UNKNOWN QUALITIES

A biological *artifact* is simply a structure or substance not normally present but produced by some external agency or action.²⁷ Artifacts derive from real phenomena, but present themselves as unknowns in one context, but uncontrolled experimental outcomes in another. The various artifact "forms" emerge in different frames of reference, including the bones themselves, and various components of the apparatus.²⁸ In this context, phenomena occurring altogether outside the *chosen* kinematic frame of reference (i.e. sagittal plane **A₁**) are described as kinematic artifacts of the kinematic projected transformation.

²⁵ See Nevin (1995).

²⁶ This state is of course Newton's *first constraint* of his *first law*, which states that every body will remain at rest unless a force is impressed.

²⁷ **artifact**, Reader Digest Universal Dictionary.

²⁸ The experiment attempts to recreate an inertial frame for the metatarsal bone. Einstein (1971) however notes that we know of no reliable scientific rule for determining an absolute inertial frame. Therefore the attempt to create such a frame is always associated with a physical artifact, which in this case is gravity.

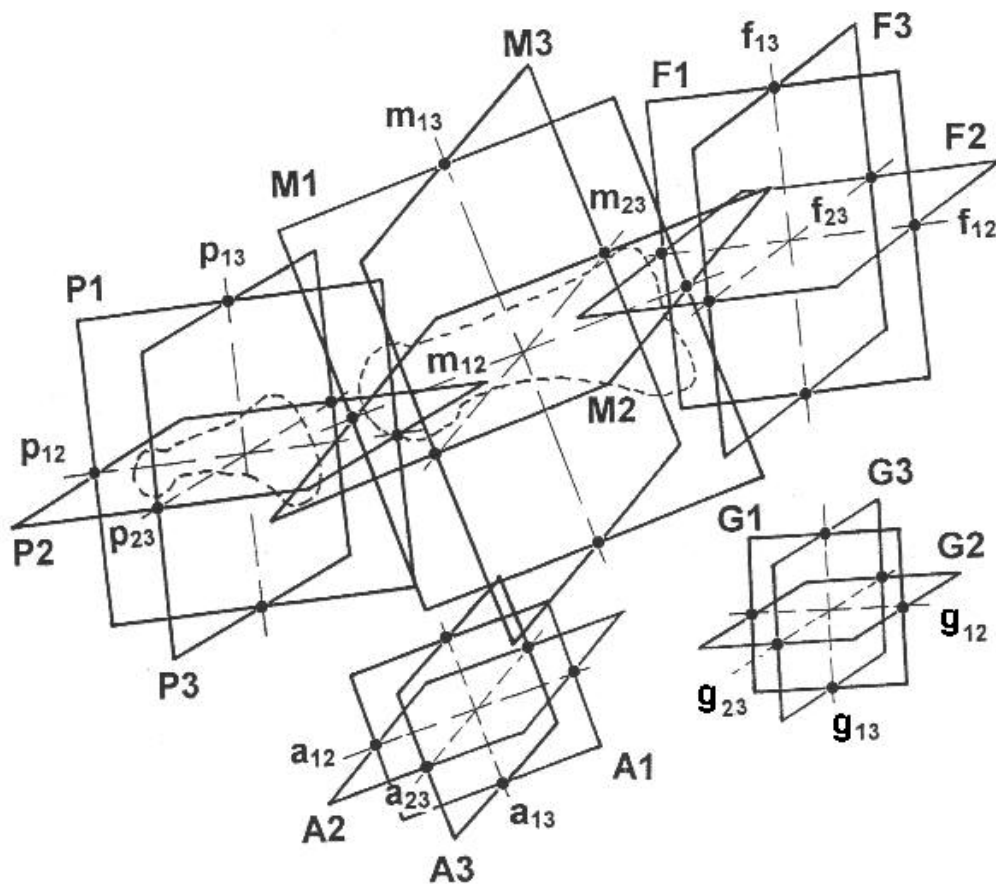

Fig. 4-5. Conventions for the alignment of various frames, planes and axes.

1. Phalangeal Artifacts

The principle phalangeal artifact arises because the transverse axes of the concave base of the phalanx (a parallel of p_{23}) and of the convex metatarsal head (a parallel of m_{23}) are forced into coincidence in the sagittal plane, to form a nominal MTP-1 joint center. This nominal joint center has no anatomical landmark, but will nevertheless be referred to as either the MTP-1 hinge axis or camshaft axis as appropriate.

An artifact that is discarded is the minor ($\pm 5^\circ$) kink or fold in the drawing paper that follows the main axes of the bones P_1 and M_1 as they cross the MTP-1 [Fig. 4-6]. The artifact arises when this valgus MTP-1 kink²⁹ is first shifted from the universal joint to the focus of the phalangeal base, then flattened onto the 2D drawing board sagittal surface A_1 . These limitations are probably not projected into the foot, because photographs through a glass floor show that the phalanx does indeed rotate in this plane during the final stages of toe-off.

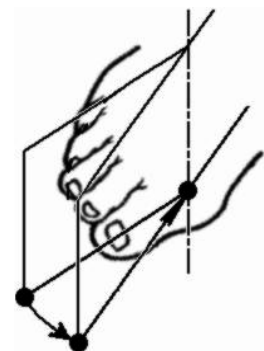

Fig. 4-6. MTP-1 plantar rotation artifact.

²⁹ The relative deviations of these axes from one another, as determined by the UV-joint pointers, did not exceed $\pm 5^\circ$ in either planes P_2 or P_3 .

2. Metatarsal Artifacts

All the metatarsal planes (M_1 M_2 M_3) bear a fixed relationship to the respective kinematic reference planes (A_1 A_2 A_3) because they were deliberately clamped together. Hence certain movements of the metatarsal cannot be detected in the kinematic plane A_1 because the whole frame of depiction simply tracks the metatarsal movement. The extent of this shadow motion is limited only by the strength and efficacy of the clamped bone interface, magnified by the parameter h . Unlike the phalangeal artifacts which are translations on surface A_1 the metatarsal artifacts of the KPT are primarily rotations.³⁰

- ❖ *supination-pronation* of the metatarsal about its long anatomical axis m_{12} ,
- ❖ *abduction-adduction* of the metatarsal about its superior anatomical axis m_{13} .
- ❖ *flexion-extension* of the metatarsal, a rotation about the cam or hinge axis m_{23} .

These components can be compared to the alignment of a boat bobbing on the sea³¹ [Fig. 4-7]. There is a supination roll³² around the anterior or forward axis g_{12} , and a spin or yaw around vertical axis g_{13} resulting an adduction-abduction slip of the great toe across the ground G_2 . The fore-aft pitching is essentially the cam motion in the sagittal plane. The unrestrained rotation about an axis m_{23} that is perpendicular to plane A_1 combined with slip of the disk P . It is noticeable that these are artifacts of irregular non-Galilean motion which all fall within the *helmsman's* domain of control.³³

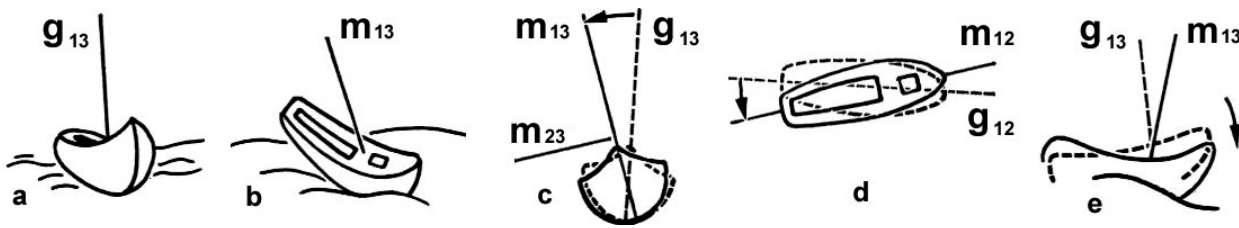

Fig. 4-7. Segment rotations compared to a boat. (a) Starting position, (b) metatarsal motion as a composite supination-pronation, (c) inversion-eversion, (d) adduction-abduction, (e) flexion-extension (Kapandji).

Forces that intersect any of the center axes (m_{12} , m_{13} , m_{23}) cause the metatarsal to either translate, rise vertically in the rectangular channel in bracket M or slip sideways rather than rotate, carrying the entire kinematic frame with it; i.e. the boat M , deck A and stowage P . Any other forces passing off-center from the metatarsal axes create a torque that causes the bone M and frame A to rotate in unison. But only to the extent that the support at D or P_i is perfectly compliant, and all clamps and constraints perfectly rigid.

The failure of the rigidity criterion is however inevitable and systematic and should in terms of the thesis be *treated as distinct*³⁴ from the arbitrary nature of experimental errors.

Any *translations* of P_1 on M_1 appear as composite curves³⁵ on the x-axis and y-axis of the transparent phalangeal grid A_1 that define the cam area artifact [Fig. 4-8]. There is a third orthogonal translation along a_{23} which is perpendicular to the flat 2D cam. This is the height h of the sliding bracket P_i that separates M_1 and A_1 . This height is arbitrary, and has no theoretical influence on the kinematics in A_1 . However any force component parallel to plane A_1 at height h does not in practice cause a

³⁰ The metatarsal artifacts appear as rotations because the bone was clamped and limited in translation. The phalanx artifacts appear primarily as translations because the phalanx was connected to a universal joint.

³¹ In his own words, Newton's *Principia* apply to the 'motion of the sea', not directly to the motions of the boat itself.

³² Supination is defined here purely as a "log-rolling" action of the metatarsal, which in the anatomical situation often includes inversion-eversion and adduction-abduction components depending on the orientation or flexion-extension of the axis of the joint.

³³ A similar artifact occurs at every joint, capable of rotation and translation. It is the accumulation of these artifacts at every joint that makes biomechanical calculations of inverse dynamics indeterminate, and consequentially the neuro-musculo-skeletal system appear indeterminate.

³⁴ Synonyms for *distinct* include *orthogonal*, *independent*, *additional* or *artifact* in 3D, or *imaginary* in a 4D mathematical complex.

³⁵ The KPT is not a Galilean or Euclidian transformation.

rotation because the *wide* flat disk P_1 does offer torsion resistance to rotation about all axes other than m_{23} which passes through the disk P_1 table B' before being damped by compliance D .

This creates an artificially stiff transverse axis m_{23} that is perpendicular to the flat cam area parallel to the camshaft axis [Fig. 4-9]. It is postulated therefore in 3D that the flat 2D cam form is accompanied by an rotational *artifact* acting on a transverse metatarsal axis m_{23} that depends in part on the orthogonal height h and the resistance provided by the radius of the extended bone element.

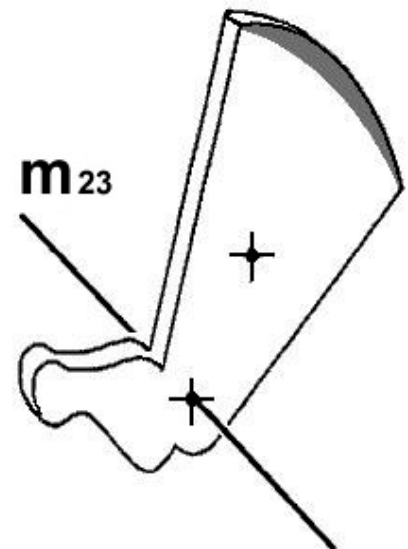
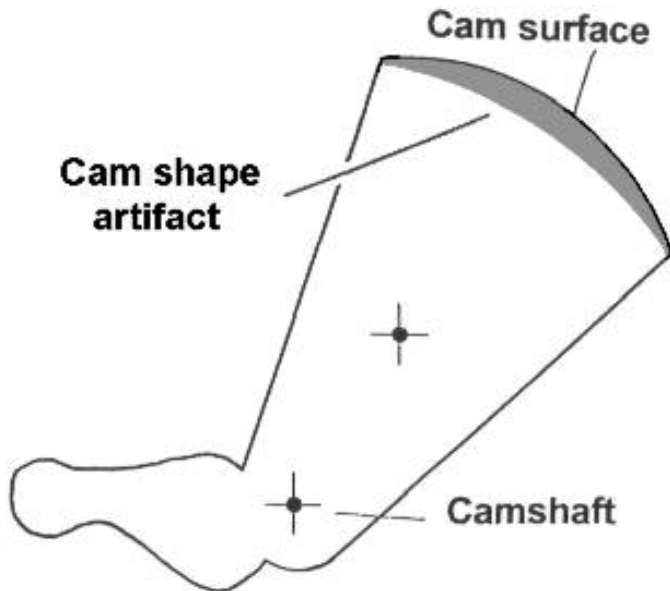

Fig. 4-8. 2D cam shape artifact of a classical hinged motion. **Fig. 4-9.** 3D metatarsal cam artifact with the transverse cam axis acting as a real-imaginary lever arm.

4.4 PRINCIPLES OF ANIMATE MOTION

Inevitably³⁶ there must be *kinetic artifacts* associated with these *kinematic artifacts* defined for the bones. The various components of MTP-1 relative motions can be merged as three principal or composite 3D artifacts. The principle artifacts derived from the kinematic projected transformation are the kinematic *cam*, the kinetic *ground reaction torque* (GRT) and the functional closed-loop *amputation artifact*.

These are the original principles of animate motion that accrue to the thesis.

The kinetic artifact component applies to the physical forces that tilted the small drawing board clamped to the metatarsal, which were large enough in some cadavers to break the bones.³⁷ However, these forceful artifacts could not be immediately quantified, because they were not anticipated from any literature reviewed. Nor were they apparent in my own pilot study on amputated specimens (Nevin, 1995, p.40). Hindsight nevertheless permits me to attribute this omission to the *kinematic cam* and associated *kinetic ground reaction torque* artifacts that are absent in amputated joints but arise in complete cadavers and hence also presumably in the living subject.

³⁶ Einstein and Infeld (1971) pointed out that every absolute mechanical frame of reference (Galilean frame) in 3D is inevitably associated with some form of force artifact. The most common artifact is gravity itself, which is mechanically indistinguishable from inertia.

³⁷ The term irresistible force springs to mind (See Anatomical hypotheses, Chapter 2.2.2.)

4.4.1 METATARSAL CAM

The cam is a 2D object, which has been visualized by projecting it from frames **P** and **M** onto a common parallel surface **A₁**. Defining a cam surface from fixed phalangeal coordinates creates a solid area that protrudes into the first cuneiform region. It is this protrusion that defines the cam shape [Fig. 4-8]. The cam is an imaginary object that fits in the first metatarsal space and replaces the two bones and the intervening joint with one solid component. It does not exist when the metatarsal is defined as the *unmoved proximal origin*.³⁸ Thus from the traditional perspective using rigid linked biomechanical hinged segments, the MTP-1 cam is an artifact produced by the KPT.

The cam profile is a trace of discrete points on the metatarsal bone perimeter as the phalanx moves. Even though the phalanx is moved, it is nevertheless described as unmoved throughout.³⁹ The cam geometry is drawn in the unmoving frame of reference of the phalanx. But the cam is also simultaneously deduced from experiments where the metatarsal is defined as unmoved; i.e. acting as an inertial frame. The term unmoved mover thus applies equally to the phalanx and the metatarsal. The cam is strictly a transitional form between the unmoved frame of the phalanx, and the actual physical (Galilean inertial) unmoving frame of the metatarsal. Since both parts of the joint are unmoved movers, the whole *solid cam model* can therefore be described as an unmoved mover.

The MTP-1 cam model is an *imaginary* rather than *absolute* area.⁴⁰ And is therefore best described in *res cogitans* Cartesian coordinates. Hypothetically two of these dimensions combine to form the only real component capable of manifesting in three *res extensa* dimensions. An *indivisible* area [L]² defined in the sagittal kinematic plane **A₁**.⁴¹ The cam therefore, although composed of imaginary elements is very real in terms of its physical action.

The experimental force **E** applied beneath the toe moves the phalanx and the attached reference grid with it. Hence the applied plantar force cannot produce an “active” acceleration in the phalangeal reference frame. Remarkably however, the active *distal* plantar component under the phalanx re-appears at the *proximal* end of the metatarsal in the region of the first metatarso-cuneiform joint. Where it is called the cam artifact. Essentially the previously hidden ground reaction has passed through the anatomical MTP-1 hinge joint mechanism, transferred by the imaginary cam action.

A cam is a mechanism that *controls* the power distribution in a mechanical system through the non-concentric curves of its profile that converts rotations into translations. A cam however does not generate or store power of its own, it merely distributes it. The actual physical power that the kinematic cam distributes appears as the associated kinetic artifact, the *ground reaction torque*.

³⁸ The cam shape only exists in a joint surface itself if there is an off-center solid bony protrusion, such as in the knee.

³⁹ The fact that the phalanx does move at some stage during gait relative to the ground is accounted for by the ‘amputation artifact’.

⁴⁰ The cam is a composite area of time and space coordinates. Similar to gravity and Kelper’s laws of planetary motion.

⁴¹ There are only three fundamental dimensions in classical mechanics, length [L] mass [M] and time [T].

4.4.2 GROUND REACTION TORQUE

Mechanical torque is the product of force and a distance perpendicular to the line of action of the force. It has the fundamental dimensions $[M][L]^2[T]^{-2}$, which are the classic dimensions of energy. The ground reaction torque (GRT) obtains its name from the fact that the lever arm of the bone-clamp and bracket creates a torque equivalent to force and distance between the plane of support G_1 and M_1 . The lever arm of the torque is the height of the bracket above the kinematic plane A_1 in the experiment KPT layout [Fig. 4-4] moderated by the compliance element. But in the foot it is simply

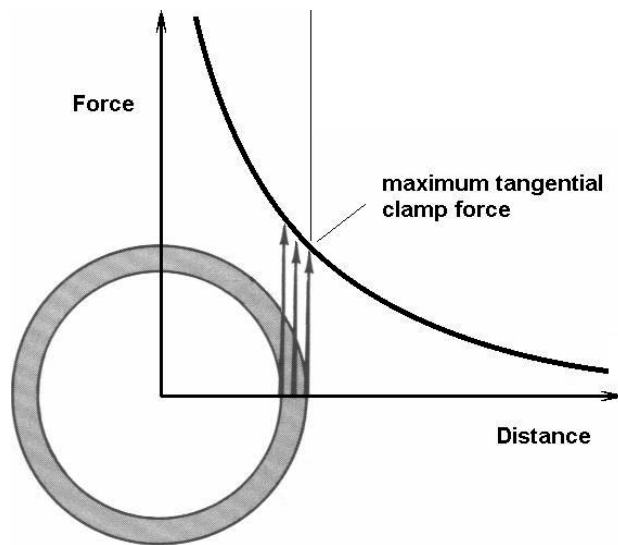

the radius of the metatarsal bone. The region inside the bone is the source of bone torsion. The region outside the bone is the source domain for the external postural moment or torque.

As the lever arm reduces to zero inside the bone, the force goes to infinity [Fig. 4-10]. This would make any form of internal clamping impossible, which is indeed the experimental and clinical experience.⁴² However, it is possible that the GRT as a physical parameter does not disappear at the physical limit of the external lever arm, but remains in the body as a postural strain. This hypothesis is examined in more detail in Chapter 5.

Fig. 4-10. Ground reaction torque in the metatarsal shaft.

It is hypothesized that when the cadaver hallux is passively dorsiflexed, the foot supinates and the limb rotates externally *raising* the cadaver torso on the bench *against gravity*.⁴³ The net energy transfer rather than the anatomical location thereof is of concern here. Gravitational potential energy is added as the cadaver *posture* changes due to an external force E . Kinetic energy is zero when the cadaver is stationary. Therefore only gravitational energy is added between any two equilibrium postures corresponding to successive static data acquisition nodes when the body is brought to rest in a different posture. Thus the GRT is a measure of the *dynamic potential energy* that is added and stored in changing *body posture* in a constraining gravitational environment.

A quantifiable torque however, is only generated when any part of the bone or rigid anatomical extension is coupled to an inertial mass such as F or C . This occurs when a rigid extension of the anatomy or attached experimental apparatus A makes contact with the ground G or a rigid extension thereof such as the bench B or the stiff elements of the compliance D .

The external GRT artifact can be reduced completely in two ways. First by making the lever arm of the clamp as small as possible; i.e. the same size as the bone perimeter. When the clamp dimensions are reduced to zero, there is no clamp and hence no artifact, but also no experimental

⁴² Ruch and Banks (1986, p. 198) explain, "One of the primary guidelines of the AO system is that no [MTP-1] implant can withstand the unsupported stresses of weight bearing and the package insert for Synthes products carries this statement."

⁴³ See Fig. 2-4 for the anatomical details of the ground reaction twist.

data. The second is to place the cadaver⁴⁴ in a bath of water [Fig. 4-11] or on an infinite air cushion⁴⁵ where there is no resistance to the motions induced by plantar pressure.

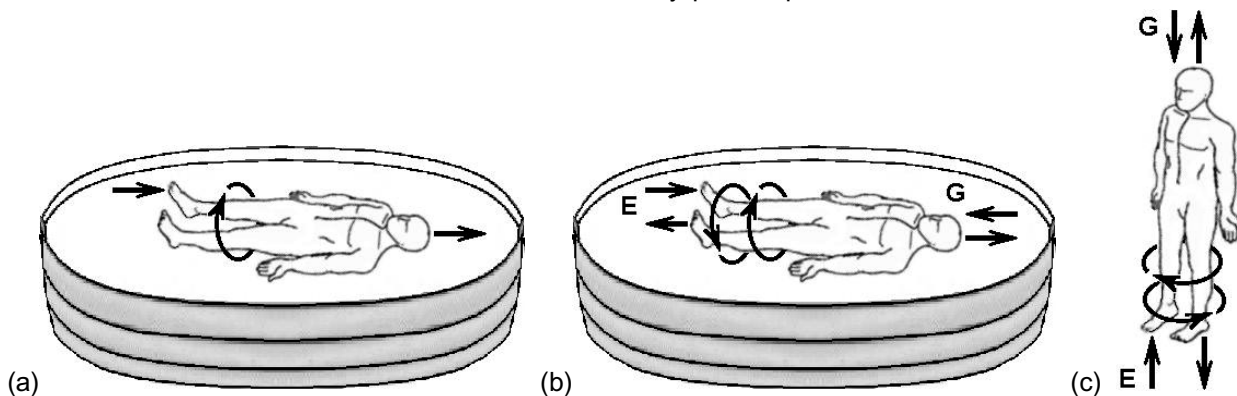

Fig. 4-11. (a) The ‘Archimedian cadaver’ floating in water to isolate the deleterious effects of the ground reaction torque. (b) Counter rotations needed to maintain free-body at rest. (c) Gravity constraint once floatation removed.

This internal strain can be deduced from the Archimedian cadaver [Fig. 4-11]. If there is no resistance the applied toe force **E** propels the cadaver headlong. Without resistance, rotation could not be forcefully resisted, and hence there would be no torsion to break the metatarsal bone. But the cadaver would then spin endlessly [Fig. 4-11a]. The only way to contain this translation without experimental paraphernalia **E'** is to orient the body vertically and use gravity **G** to return the body to the ground [Fig. 4-11.b-c]. The opposite (passive) pronation action/reaction in the foot is supplied by the body weight **G** acting on the off-centered talus.

It is believed that the physiological function of the first metatarsal cam is to facilitate the transfer of an energy transient, the supinating ground reaction postural twist component of the ground reaction torque [Fig. 4-11a] that counters the passive pronation [Fig. 4-11c].

But the passive arch raising potential recognized by Hicks (1954) cannot be stored by raising a weight in the gravity field⁴⁶ that is simultaneously inducing MTP-1 dorsiflexion. It is stored rather in dynamic state of instantaneous postural twisting that is generated and transmitted via metatarsal supination against the very resistance of body weight that induced foot pronation. The apparent contravention of the law of conservation of energy that would inevitably accompany absolute arch raising is thereby avoided. This is because counter-rotation, unlike raising the load-bearing arch, does not change the position of the body’s center of mass in the vertical direction.

The GRT energy is distributed and stored as inertial-elastic strain energy throughout the body as counter-rotating parts. Particularly for example in the adjacent metatarsals, the tibia and fibula, and the opposite arms and legs.⁴⁷

⁴⁴ I call this the Archimedian cadaver because of a famous “Eureka!” incident when Archimedes reputedly discovered the laws of buoyancy while floating in a bath of water. The relationship between the Archimedian cadaver and the animate hinge anatomy is discussed further in Chapter 7.

⁴⁵ Such as in terrestrial orbit.

⁴⁶ The Galilean pedestal principle.

⁴⁷ The component expressed as motion is often called *internal work* when related to a local joint inertial frame.

4.4.3 AMPUTATION ARTIFACT

The postulate of an amputation artifact stems from the second result of the KPT or observation that the surgically-altered MTP-1 functions as a hinge *in vitro*, and no longer as a cam. It is known from my previous experimental experience that the ground reaction torque does not appear in laboratory frame of reference using amputated specimens. Thus it is postulated as an artifact of the *amputation procedure* that produces the ideal hinge joint of the antithesis.

For good reasons quantitative *kinetic data* is lacking,⁴⁸ but it is hypothesized that the bones of the dysfunctional inanimate hallux, invariably fractured when clamped tight enough to obtain a suitable kinematic description in the cadaver. Experience revealed that there was little leeway between:

- ❖ clamping the metatarsal too tight so that it broke, or
- ❖ clamping it too loose so that it slipped relative to the kinematic plane, confounding the resulting description of the *unmoved mover*

Bone fractures were entirely preventable by reducing the clamp pressure to sustainable levels, but this simply confounded the kinematics description of the *unmoved mover* because the bone simply slipped and moved between the clamp jaws, voiding the *unmoved criterion*. Nevertheless it was observed that the metatarsals from apparently normal intact feet did not fracture in the cadaver when motion were limited to about $\pm 2\text{mm}$, which is significantly within the functional range of plantar aponeurosis action.⁴⁹ In this range the ultimate normal bone strength seemed to hold some relationship to the torque transmitted through the metatarsal.

The dilemma was that a stationary bone of a supine cadaver joint, that is not constrained in any obvious way⁵⁰ should not inexplicably induce a fracture in its conjugate partner when using a kinematic protocol that is by definition isolated from causal forces.

Certainly when one carefully reviews Hicks descriptions of MTP-1 action, one encounters the phenomenon of an *irresistible* force acting on an *immovable* object. Under these circumstances something must be expected to either break or move.

However, only after the derivation of the cam model did a potential reason emerge. The bone fractures hypothetically induced by constraining the GRT, are associated with the cam behavior. Remove the cam effect, and the danger of ground reaction *twisting fracture* is also eliminated; and vice versa if the ground support is removed by isolating the amputated foot from its self-sustaining inertial anatomical reservoir.

But the corollary of this remedy is counter-productive *in vivo*. It is well known from Wolff's law⁵¹ and cosmonauts in *perpetual free-fall* where bones are not loaded chronically, that bones reduce in strength.⁵² Similarly the added stresses of cam action can be removed if there is a reduction of gravity pronation, or if the bone functions as a hinge. In the latter case a hinge shaft is subjected to less stress than a camshaft. This provides I believe the key difference between the mechanical and bio-mechanical behavior of the system that should reflect a difference between the mechanical and bio-mechanical free body diagrams.

⁴⁸ A quantifiable description requires that the joint motion be stopped so that data could be obtained for position of the two distal-proximal metatarsal landmarks simultaneously, essentially under static equilibrium conditions. Therefore any dynamic energy inherent in the system would need to be released into altered body posture before measurement, and hence appear never to have existed.

⁴⁹ 6mm according to Nevin (1997).

⁵⁰ A universal joint mounted on an orthogonal sliding bracket presents no intrinsic obstacle to motion.

⁵¹ The adaptation of bone architecture to the stress applied was noticed by Wolff in 1892 (Larsen, 1997).

⁵² Terrestrial orbit in space provides the only laboratory frame where the isolated human (free) body can be experimentally studied in chronic free-fall. A parabolic flight is only suited for acute free-fall.

The more perfect an *inanimate* mechanical steel hinge is for example, the better it performs and the longer it survives. But paradoxically from the KPT it appears that the perfect mechanical hinge is not ideal for maintenance of *animate* bone integrity.

It is hypothesized that the post-mortem attempts to re-impose physiological cam function, absent when alive due to misalignments such as hallux valgus may have induced the fractures in bone weakened by prior, and hence causal chronic *kinematic* dysfunction.⁵³ It is probable that the reduced demand for bone stock required for classic orbital hinged-motion, induces chronic resorption of the metatarsal shaft, making it weaker *in vivo*. A weakness that is not apparent *in vitro*, because of the lower demands required for inanimate amputated hinge action. The weakness however re-appears when one *experimentally* re-imposes Aristotle's requirement for an unmoved mover.

From this it is possible to conclude that the normal anatomical structure of the MT-1 bone in the bipedal foot is not an indeterminate static weight-bearing arch or beam as a classical model presupposes. Rather it is a fully determinable *dynamic torsion element* capable of sustaining the ground reaction torque.⁵⁴

SUMMARY OF PRINCIPLES OF ANIMATE MOTION

- ❖ The ground reaction torque (GRT) is essentially the instantaneous dynamic self-constraining energy artifact of a posture frozen in time.
- ❖ In principle the GRT serves as a bridge between the static *gait at rest* and the *dynamic posture* domains of thesis and antithesis.
- ❖ The cam and GRT artifacts that arise in the distal joints need to be taken into account when one arbitrarily isolates a free body in the foot.

⁵³ Hallux valgus is a bone misalignment, and hallux rigidus is a limitation on motion . Both are kinematic causes with kinetic effects.

⁵⁴ A novel hypothesis examined in Chapter 5.

4.5 RE-ANIMATION OF CADAVERS

The kinematic descriptions of toe motion were deduced under constraints that need to be removed in order to animate the free-body. A process referred to here as re-animating the cadaver. The constraints that cannot be removed altogether need to be rearranged to isolate their anatomical function. To this end, several interactions labeled 1 to 8 can be observed or deduced from thought experiments.⁵⁵

Fig. 4-12 is a schematic of the components as they were arranged in the laboratory. The cadaver torso **C** is held to the bench **B** by gravity. The kinematic reference frame **A** is in series with cushion **D** resting on a lower pedestal **B'** and in parallel with external loads **E**. The difference between **B** and **B'** is a nominal height **h** (the Galilean pedestal). All components ultimately share a common base **G** the ground. A thought experiment that does not alter any relationships is to down-sized the earth to the same size of the other elements and bring them into line in a closed-loop system [Fig. 4-13]. Initially the MTP-1 loading device **E** acts on the phalanx **P** receiving from it an equal and opposite reaction as indicated.

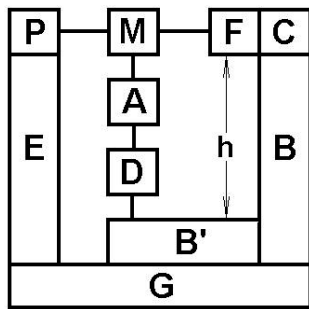

Fig. 4-12. Laboratory stacking arrangement.

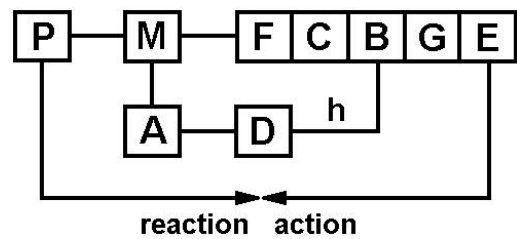

Fig. 4-13. Thought experiment rearrangement.

To simulate gait, the first rearrangement is to stand the previously supine cadaver up vertically. This involves several unspecified postural adjustments including supination, pronation and axial roll [Fig. 4-11].⁵⁶ In the second phase of the thought experiment the active experimental loading device **E** (here a fully animate researcher depicted in Fig 4-2) is merged with the inert or inanimate cadaver **C**. After the merger the cadaver **C/E** now appears as internally self-animated [Fig. 4-14].

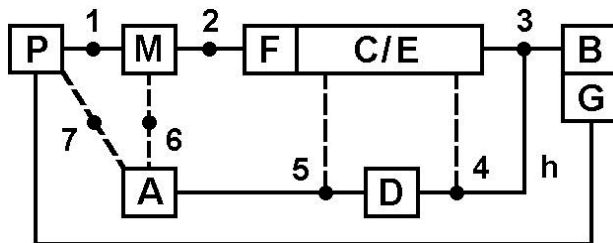

Fig. 4-14. Self-animated rearrangement.

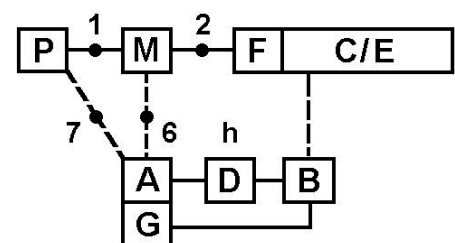

Fig. 4-15. Unmoved mover rearrangement.

The merging of bodies **C** and **E** alters two internal and external relationships in the closed loop [Fig. 4-14]. The *internal* connection between **B** and **G** is not altered. Although there is a sign reversal of the forces between **EB** and **EG** as they cross the external torso-ground link 3. The sign change

⁵⁵ Interactions between abutting segments that are represented by letters are assumed to either cancel internally in terms of Newton's third law or are transmitted via a series of equal and opposite reactions to one of the a numbered sites where they can be detected.

replicates transferring the capacity of the *active* animate researcher to the *passive* inanimate cadaver. The *active* experimental input **E** below the foot has been converted to the *passive* gravitational pressure of the foot supported by the active body passing through the bony toe links **1** and **2**. However this change is immaterial to the stationary phalanx.

A standing model of gait with continuous ground support under the phalanx is created by bringing the unmoving phalanx frame **P** (visualized through **A**) into coincidence with the ground **G** (link **7**). This recreates the conditions of Aristotle's unmoved mover applied to the animate MTP-1 [Fig. 4-15].

The pathway **D-h-B** remains. This can be incorporated into the body by noting that **B** is the rigid body support element. Thus it is analogous to the bony *skeleton*. The compliant element **D** is analogous to the soft tissues such as muscles. The compliant pathway **D-h-B** is parallel with the inertial constraint **A-6-M**. Parallel pathways must of course perform similar functions.

Once the inertial constraint **A-6-M** is removed, the neuromuscular system must perform in synergy as a direct agonist or antagonist to inertia, which is from the point of view of physics indistinguishable from gravity. Unfortunately because the MTP-1 is primarily osseo-aponeurotic, the opportunity does not exist in terms of the principle premise of the thesis to explore this *muscle-gravity synergy* further here.⁵⁷

4.5.1 CAM EFFECT IN FREE GAIT

The load of the body **C** during upright standing must pass distally through the foot **F**, metatarsal **M**, and phalanx **P**, to the ground **G** [Fig. 4-15] because the route passing proximally *in vitro* through link **3** between the cadaver torso **C** and the bench **B** [Fig. 4-14] is not available during bipedal activity. The forces travel internally *in vivo* through the distal end **1** and proximal end **2** of the metatarsal; i.e. through the hinge or camshaft mechanisms in the foot. Important changes occur when the ground **G** is shifted back to where it belongs—under the phalanx **P** [Fig. 4-15]. Here it provides the necessary foundation for gait, via the support frame **A** connected through link **7** to **P** and through links **7** and **1** to **M**. This route is in parallel with **A-6-M**, the “inertial clamp” that kept the metatarsal unmoved.

The experimental fusion of **M** and **A** provides a description of Aristotle's animated unmoved mover coerced into in an inertial frame of reference. But in unrestrained free gait, the rigid link **6** is not present and must be replaced by a description of the unmoved cam (link **A-7-P-1-M-2-F**) and the remainder of the musculoskeletal support system **D-h-B** which includes the muscles and bones of the heel and lateral forefoot.

There is a direct analogy between physically removing this inertial clamp **6** and removing the neuromuscular components **D** and theoretically and historically removing Galileo's theory of inertia (uniform motion) and the Pisa pedestal **h** from the biomechanical model of gait.⁵⁸

Aristotle's description of the distal concave phalangeal unmoved mover, merges the ground (the external unmoved mover **G**) with the internal unmoved mover **P** through the hinge center **A**. Hypothetically however, the center **A** is actually better described as a cam with two centers, not an indivisible hinge as Aristotle supposed.⁵⁹ By employing a mathematically complex Cartesian model, the indivisible hinge *can* be separated into two orthogonal components. One a real plane (the *res extensa*) and the other a set of orthogonal imaginary axes (the *res cogitans*). The latter are indivisible because they cannot be physically cut like the plantar aponeurosis.

⁵⁶ The exact anatomical sequence is mathematically indeterminate in a 3D system (Ariel et al., 2000).

⁵⁷ See page 47 Fig. 3-12 for my expectation of the most likely form of the muscle model.

⁵⁸ Galilean inertia, it should be recalled, is the antithesis that prevents a solution to the problem of initiation of gait.

⁵⁹ *Movement of animals*, 698a.

These orthogonal (i.e. independent) components in 2D are potentially the two parallel axes in the cam model. For these imaginary axes to remain orthogonal in 3D 'reality' they must exist as parallel or non-intersecting axes.⁶⁰ But in 3D the parallel axes need not remain parallel because any non-intersecting axes are always separated by a perpendicular distance (i.e. $h \neq 0$). In 3D therefore there arises the problem of excessive degrees of freedom.

It should be apparent from Fig. 4-14 that in any constrained animate system,⁶¹ a change in axial length in the metatarsal cam **A** is accompanied by a reciprocal change in compliance **D** and/or height **h**. This nominal height **h** represents the Galilean pedestal, or "arch raising height", which is a novel conjugate to and hence realistic substitute for, the problematic notion of Galilean uniform motion.

In the bipedal situation on an unyielding surface [Fig. 4-15] the compliance **D** is merged with the animate body itself **C/E**. As such, it mimics the soft tissues and *muscular compliance* that accompanies the cam-like rigid bone articulations of the osseo-aponeurotic structure. The result is two apparently independent systems, the osseo-aponeurotic, and the neuromuscular. These have been related through similar complex mathematical transformations of the rigid supporting structure **B**. Since **B** here is the skeleton, any changes in the rigid support from **B** to **B'** effectively involve the osseo-ligamentous cam effect **h**.

4.5.2 AMPUTATION ARTIFACT IN FREE GAIT

The inanimate cadaver cannot be considered free because the foot has yet to leave the ground. For free bipedal gait, the ground-torso link **3** must be severed and remain open indefinitely, so that the torso **C** can "progress" as Aristotle said with respect to the ground **G**. This separation is generalized *in vitro* as the amputation artifact. The biomechanical *function* of the amputation artifact during gait can be deduced as follows.

In the cadaver experiments, the *amputation artifact* was a surgical amputation. But in the case of animate gait it may simply be a temporary non-destructive functional separation within the anatomical circuit, such as the foot in Fig. 4-15 leaving the ground. The instantaneous separation of inanimate link **3** *in vitro* causes the supine cadaver torso to momentarily rotate on the bench as a new stable static *posture* is sought. A transient state therefore exists briefly (say less than 1 second) before the body stabilizes in a new posture.⁶² Wherever the resection occurs in the loop, the effect would be the same—a short-lived dynamic energy transient⁶³ between the old and new postures or states of static equilibrium.

During this time span, kinematic data acquisition is not feasible because some ground resistance is always needed to force a change in the pointer positions on apparatus **A** and hence create an *experimental record* of the event. Otherwise the kinematic instrument and the anatomical part-in-motion move together in unison. Contrarily, the ground reaction torque artifact actually manifests when a measurement is attempted; and hence might well be misinterpreted and actively dismissed as an experimental nuisance rather than an essential part of gait.

I hypothesize that these experimental nuisances are regularly encountered in the literature and just as regularly disposed of by rashly amputating the cadaver foot or fixing the specimen to a supporting frame **E'** (link **8**). Figure 4-16 for example depicts the foot bones *in vitro* configuration using *amputated specimens*. Artificial attachment **8** between the specimen and the enclosing loading apparatus **E'** appears essential, either via the tensile soft tissues **T**, or some arbitrary but necessary

⁶⁰ In Kepler's law these axes are the foci of the ellipse. When the foci coincide, then the model reverts to the perfect spheres of the scholastics.

⁶¹ Featuring the constrained Galilean body; i.e. clamp configuration **E'**.

⁶² It requires a spacecraft in orbit to substantially alter this condition. In such conditions there is a chronic atrophy of bone strength.

⁶³ A transient energy term manifests as power (watts). Power is the rate of transfer of energy and hence power cannot be stored. The energy can however be stored as potential, kinetic, elastic or biochemical strain. Storage of energy as chemical or metabolic heat is not sufficient.

bone or muscle fixation to the experimental apparatus. Link 8 distinguishes the Galilean constrained body from the free-body.

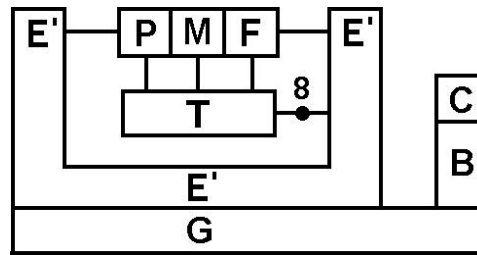

Fig. 4-16. Artificial reattachment after amputation that gives rise to the amputation artifact.

The amputation artifact serves a crucial natural function because it occurs naturally when the foot leaves the ground every step, which cannot occur if artificially constrained by bone or muscle substitutes attached to a laboratory framework. The amputation artifact is also difficult, if not impossible to imagine using other methods such as cinematic animation because it merges effortlessly with the indeterminate gaps between the static animated images. It has no net potential or kinetic energy. It is an internal postural strain energy.

4.5.3 GALILEAN PEDESTAL—SUPPORT FOR A PROXIMAL ORIGIN

The conventional MTP-1 clinical examination, with the subject seated and the foot raised, is denoted in Fig. 4-14 through link 5. Link 5 represents the distal support between the ground **G** and the torso **C**. The distal shift of constraints from 3 (lying or sitting) to 4 or 5 creates a *mechanical short-circuit* around **D**. Inserting links 4 and 5 interferes with the superior postural balancing function 3, and the distal functioning of the toe because the only connection available during gait is through the sole of the foot (links 1 or 2 Fig. 4-15). The proximal mechanical short circuit 4 or 5, like the amputation artifact affects the functional role of the toe by substituting another external proximal link for link 3 rather than removing it altogether.

It can be deduced from Fig. 4-15 that the clamping torque or external postural moment necessary to statically isolate the metatarsal free-body in plane M_1 [link 6] is the same as the torque applied to the ground through links 3 and 4 in a closed loop system Fig. 4-14.⁶⁴ This is the GRT. The tangential friction of the *clamp-face torque* 6 may be seen as a good first approximation of the physiological isometric torsion within the first metatarsal when the cam acts [link 7] because the soft tissue **D** can twist but not really apply resistive torque.

Closely related to the free stride constraining-link 3, is link 4 between the kinematic descriptor and the bench and the distance **B-B'** [Fig. 4-14]. This indeterminate distance which is a component of the height **h** is partly merged with the compliance **D** [Fig. 4-4]. Depending on its location within the analysis and the constraints imposed on the body, the term **h**—the cam effect—can be defined in terms of two components:

- ❖ 'Vertical' height in the gravity field (Galilean pedestal, gravitational potential energy) [Fig.4-11c].
- ❖ 'Horizontal' postural *lever arm* for the ground reaction torque (non-gravitational inertia) [Fig. 4-4].

In conclusion it can be said that the *Principles of animate motion* deduced here regulate the interaction between these classic forms of energy.

⁶⁴ A closed loop system is effectively an isolated free-body.

5.

METATARSAL FORM AND FUNCTION

“Bipedalism refers to the ability to walk upright and encephalization refers to the increase in brain size. These two adaptations are responsible for most if not all, of the other advances in human evolution.”

— Philip G Zimbardo¹

5.1 INTRODUCTION

Anatomical *function* is traditionally deduced from anatomical *form*.² One such example is the arch of the foot. But the compelling imagery of a stone arch may mislead one to suppose that the primary function of the foot bones is to bear and support weight. The MTP-1 clearly forms the anterior buttress of the arch. However when the phalanx is fixed to the ground, experiments show that the metatarsal appears to function not as a static stone-like foundation, but as a cam.

A cam provides a very necessary *dynamic* basis for movement, something the *static* arch fails to provide. It has also been deduced in the previous chapter that the cam action is accompanied by an energy transient the ground reaction torque (GRT). This chapter investigates two basic mechanisms for transmitting the ground reaction torque in man and some apes. Firstly as torsion *within* the metatarsal itself, secondly as an external *torque* or postural *twist* in the adjacent metatarsals.

5.2 VIEWS AND REVIEWS

The static arch structure of the antithesis amalgamates the constituent bones into an amorphous mass. But in the fully animate condition when the great toe is dorsiflexed the foot arch structure is immediately compromised because one of its two buttresses, the heel, is bearing no weight at all. It is therefore common to find the metatarsal bones modeled as mechanical beams fixed at one end and supporting loads at the other. Researchers have estimated metatarsal bone strengths using a variety of methods. For example:

- ❖ Cross-section measurements, sagittal curvature and plantar pressure (Abramson, 1927).
- ❖ Axial compression to failure (Morton, 1952).
- ❖ Cantilever beams (Stokes et al., 1979 & 1979; Hutton and Dhanendran, 1979 & 1981; Gross and Bunch, 1989).
- ❖ Mechanical bone-strain (Sharkey et al., 1995).
- ❖ Failure testing using four-point bending (Courtney et al., 1997).
- ❖ Bone mineral density (Muehleman et al., 1999).

Most models are however limited by the nature of the theoretical assumptions employed. The strength of the shaft in *bending* for example depends not only on its cross-section,³ but is proportional to its length. Therefore the unfortunate practice of normalizing bone morphology according to bone length⁴ introduces a confounding factor in studies of *twisting* where bone length plays little role. Fresh data is therefore required.

The importance of metatarsal *torsion* in maintaining foot form and function has largely been ignored. The bending data is inevitably confounded by the experimental reality identified in Chapter 4 where amputated foot specimens tend to pronate and collapse even before data on metatarsal strains can be collected. For example Sharkey and colleagues (1995) report:

¹ *Psychology and Life*. Philip G Zimbardo, 1992.

² It has been said that function without form is a ghost, form without function is a corpse.

³ The bone cross-sections in question tend to vary. See for example Courtney et al., (1997).

⁴ Larsen (1997).

“We found that when we attempted to apply an axial load to a[n amputated] cadaveric foot [with the heel raised 10mm] without simulated muscle activity of the plantar flexors, the foot pronated and collapsed medially even at low loads.”

Sharkey and colleagues overcame the problem by applying simulated muscle tension.⁵ However Basmajian (1974) in EMG experiments exposed the fallacy that the missing arch support in the animate subject is provided by the muscles.⁶ Morton (1952) had previously anticipated that the above result because of the medial position of the talus relative to the calcaneus axis. Or as he eloquently puts it:

“Bodyweight received on the foot by the [medially off-centered] talus would therefore meet the same fate as a person trying to sit on a three-legged stool with the third leg missing.”

Medial support from the first metatarsal is fundamental to counter the pronation in the lesser metatarsals induced by the off-centered talus loading if the body is to progress in a straight line forward. But rather than model the metatarsals as beams, the thesis models them as shafts in torsion best viewed in cross-section [Fig. 5-1]. This model follows logically from Hick’s (1954) observation that passive dorsiflexion of the great toe induces supination (inversion) of the foot and external rotation of the tibia. This relationship is possibly unique to the habitual bipedal foot, particularly during human running when only one foot is ever on the ground.⁷

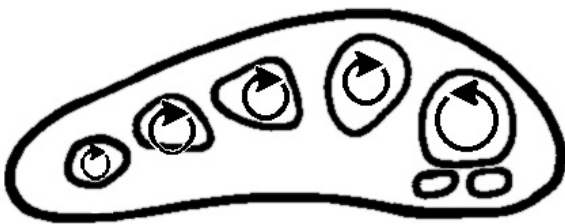

Fig. 5-1. First metatarsal as internal supinating antagonist to internal pronating lesser metatarsals.

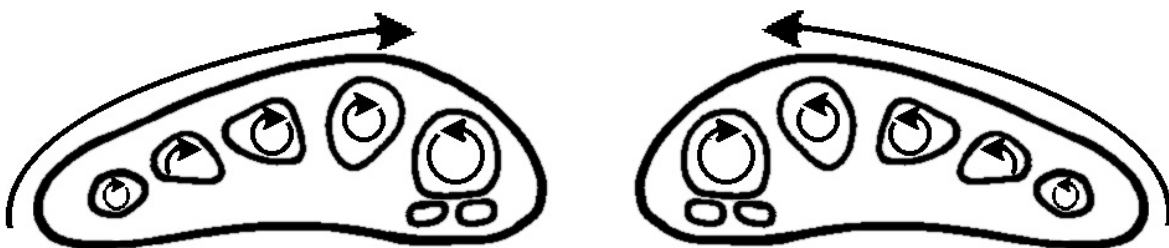

Fig. 5-2. Lesser metatarsals acting as bipedal supination agonists to the first metatarsal of the opposite foot.

It is likely that in the quasi-bipedal primate foot, the lateral metatarsals can absorb more load by adopting a side-to-side waddling walk [Fig. 5-2]. Note that the direction of the lesser metatarsal twist in either foot is the same direction as the first metatarsal twist in the opposite foot. A waddling walk can therefore be adopted by humans to compensate for lack of supination secondary to MTP-1 failure, but this is not an optimal means of straight line progression, particularly at higher speeds where humans rather than the lesser apes are most proficiently.

⁵ These muscle attachments are to an external frame similar to E' in Chapter 4; a condition not permitted in normal gait.

⁶ EMG in seated subjects reveal that the muscles are not recruited to support the arch even when loaded by up to double bodyweight. Morton (1930) had previously drawn attention to the lack of empirical evidence that it is the muscles that maintain the arch.

⁷ Morton (1924, p.14) however reasoned that this relationship evolved from arboreal walking.

5.3 HYPOTHESIS

It is hypothesized that the supination torque T_1 in the bipedal first metatarsal regularly equals the pronation torque in the other metatarsals.⁸

$$T_1 = T_2 + T_3 + T_4 + T_5 \quad [5-1]$$

If it is assumed that $T_2 \approx T_3 \approx T_4 \approx T_5$ and that T_3 is taken as representative then:

$$T_1 = 4T_3 \quad [5-2]$$

$$\frac{T_1}{T_3} = 4 \quad [5-3]$$

5.3.1 Torsion in thin walled bone

The mechanical torsion formula [Eqn. 5-4]⁹ relates the torque (T) to the shear stress (τ) via the geometric polar moment of area (J), outer shaft radius (R), inner radius (r), and cortex thickness (t) [Fig. 5-3].

$$T = \tau \left(\frac{J}{R} \right) \quad [5-4]$$

$$J = \pi \left(\frac{R^4 - r^4}{2} \right) \quad [5-5]$$

For a *thin-walled cylinder* [Fig. 5-3a] the polar moment of area can be estimated through the substitution $r = R-t$ in Eqn. 5-5. This eliminates the 4th order term, and after ignoring the low order terms, the polynomial expansion becomes:

$$J \approx 2 \pi R^3 t \quad [5-6]$$

Substituting for J in the torsion formula Eqn. 5-4, it is deduced that for thin walled cylinders:

$$T \propto \tau t R^2 \quad [5-7]$$

5.3.2 Torsion in thick walled bone

For a *thick-walled cylinder* [Fig. 5-3b] the shear force (q) is the product of the tangential shear stress and the cross-sectional area (A).

$$q = \tau A \quad [5-8]$$

Using infinitesimal elements:

$$q = \int d\tau dA \quad [5-9]$$

Torque T is the product of the shear force (q) and the radial lever arm (r). The tangential force profile in a homogeneous twisted elastic shaft is inversely proportional to the radius ($1/r$). Therefore

$$T \propto \left(\frac{qr}{r} \right) \quad [5-10]$$

Substituting q from Eqn. 5-9, ignoring radial components that would cause the bone to translate, and taking an infinitesimal cross section in the form of a ring element ($2\pi r.dr$) with radial limits 0 to R .

⁸ The metatarsals are labeled here with subscripts 1 to 5.

⁹ Popov (1978).

$$T \propto \int_0^R \tau (2\pi r) \left(\frac{r}{r}\right) dr \quad [5-11]$$

$$T \propto \tau R^2 \quad [5-12]$$

Therefore for both a round elastic cylinder, whether it be thick or thin-walled the torque is proportional to the square of the outer radius.

5.3.3 Torsion in an irregular bone

The results above are based on a convenient mechanical simplification that bones are shafts with perfect cylindrical forms which are common in mechanics but rare in biology. Actual bones have an *irregular-shaped* hollow section¹⁰ of *variable thickness* [Fig. 5-3c]. A shape for which Bredt's formula¹¹ provides a solution:

$$T = \tau t \int r ds \quad [5-13]$$

The product (τt) is a quantity called the shear flow which, like water flowing in a pipe, is constant or conserved in a closed loop. The tangential shear is multiplied by an infinitesimal element of area to define a force. This in turn is multiplied by the radius to the local tangent of length (ds) determines the *torque* ($t.r.ds$) about an arbitrary center.

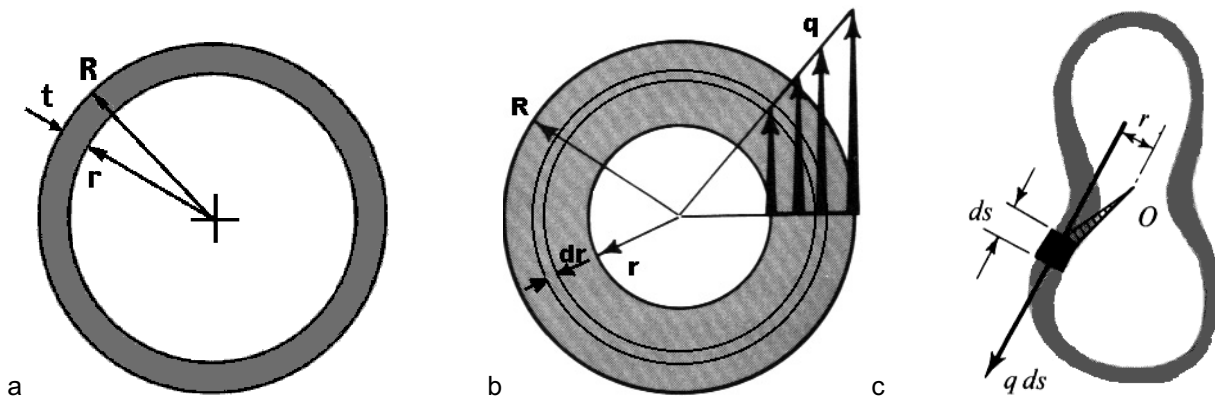

Fig. 5-3. Derivation of elastic torsion formulae; (a) thin cortex, (b) thick cortex, (c) irregular cortex.

Provided the cortex is relatively thin¹² the circular integral $\int r ds$, is essentially the perimeter multiplied by the mean radius. It is equal to twice the enclosed area because the area of a triangle is half the product of its base (ds) and height (r). Therefore the torque acting on a *hollow* shaft with an enclosed area (\hat{A}) is:

$$T = \tau t 2 \hat{A} \quad [5-14]$$

Within physiological limits of Wolff's law, over stressed bone naturally resorbs and over-stressed bone strengthens. Therefore the stress term (τ) in the functional bone may be assumed to be evenly spread. For an optimal physiologically constant shear stress (τ) varying in inverse proportion to a near constant wall thickness (t) this simply reduces to:

¹⁰ Human metatarsals have a tubular "O" form. Metacarpals appear more "D" formed.

¹¹ Popov (1978) pp.80-82.

¹² Gross and Bunch (1989) report metatarsal cortical thickness between 2.1 and 2.6 mm, and diameters between 7.0 and 14 mm.

$$T \propto \dot{A} \quad [5-15]$$

Assuming that a nominal length of perimeter $2\pi R$ encloses a cross section of bone with a nominal enclosed area $\dot{A} = \pi R^2$, the torque capacity becomes as before:

$$T \propto R^2 \quad [5-16]$$

Thus it appears from equations 5-7, 5-12 and 5-16 that the torque bearing capacity of bone shafts is not overtly affected by wall thickness or shape. Recalling Eqn. 5-3, substituting Eqn. 5-16 and taking the square root, the experimental premise $T_1/T_3 = 4$ reduces to:

$$\frac{R_1}{R_3} = 2 \quad [5-17]$$

5.4 METHOD AND MATERIALS

The hypothesis that the metatarsals are optimized for torque transmission according to the ratio of their shaft diameters is verified here by comparing the relative sizes of metatarsals and metacarpals of the hands and feet of humans and a range of primates. But because torsion in the bone need not be normalized according to its length, it is possible to normalize the bone dimensions in the cross sectional view instead. Normalization proceeds according to the diameters of the bones in the *same* foot or hand, basically ignoring the length of the bones.¹³

Metatarsals and metacarpal specimens¹⁴ from four species, 3 chimpanzee, 1 gorilla, 1 orangutan, and 1 baboon (*papio ursinis*) were compared with 13 modern human samples.

Data on the minimum peripheral circumference of the bone shafts was obtained with a cotton thread lasso [Fig. 5-4] placed around each bone and pulled tight. The length of the residual tail subtracted from the total length of the thread including the loop gives an indication of the circumference of the bone. The noose is easily slid along the bone until the minimum diameter is located. Although the method may appear somewhat primitive, the lasso was calibrated at various sites on 3 sizes of machined metal shafts, and was found to be as accurate as vernier calipers, which have a resolution of 0.1 ± 0.05 mm.¹⁵

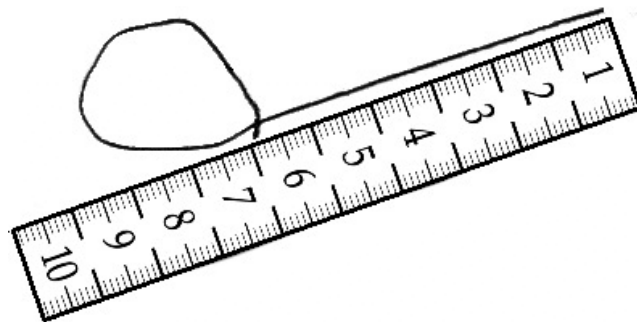

Fig. 5-4. Lasso principle for measuring bone perimeters. The bone is inserted through the loop. The actual lasso used had a quick release clip fixed to the ruler and thread, which have been omitted here for clarity.

¹³ See Morton (1922-1924) for a comparison of bone lengths and shapes of primate feet.

¹⁴ Dry-bone collections in the South African Museum and in the Department of Human Biology at the University of Cape Town.

¹⁵ The bone area \dot{A} can be measured using radiographs, CAT or MRI scans. But with cadavers this is often impractical and unnecessary both in terms of expense and accuracy. If the bone cortex is equally thick in the adjacent bones, as has been reported in the literature for the metatarsals, then the relative outer perimeter of the bone shafts can be used directly as an indication of the bones' strength in torsion. The torsion hypothesis can of course be tested in tibia and fibular cross sections in the leg using these methods. The prediction being that the tibial torsion strength alone would be half the torsion strength of a section of the tibia and fibular combined in their natural anatomical relations.

5.5 RESULTS

The outer mid-shaft perimeter of the hand and foot bones are compared in the ten columns of Figs. 5-5 & 5-6. The human first metatarsal is clearly seen to be much larger than all the others.

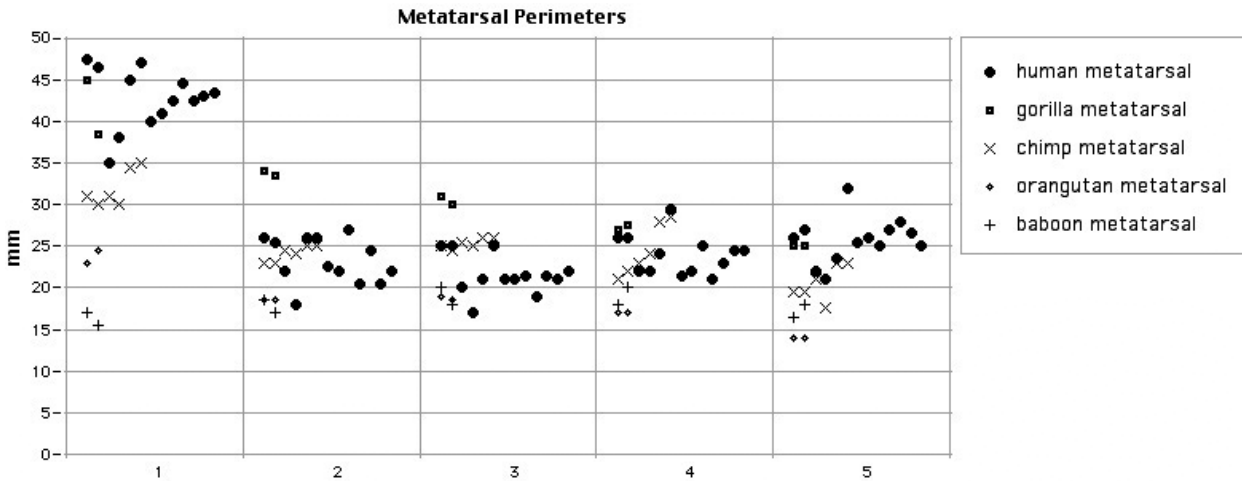

Fig. 5-5. Minimum metatarsal shaft perimeter in man and apes.

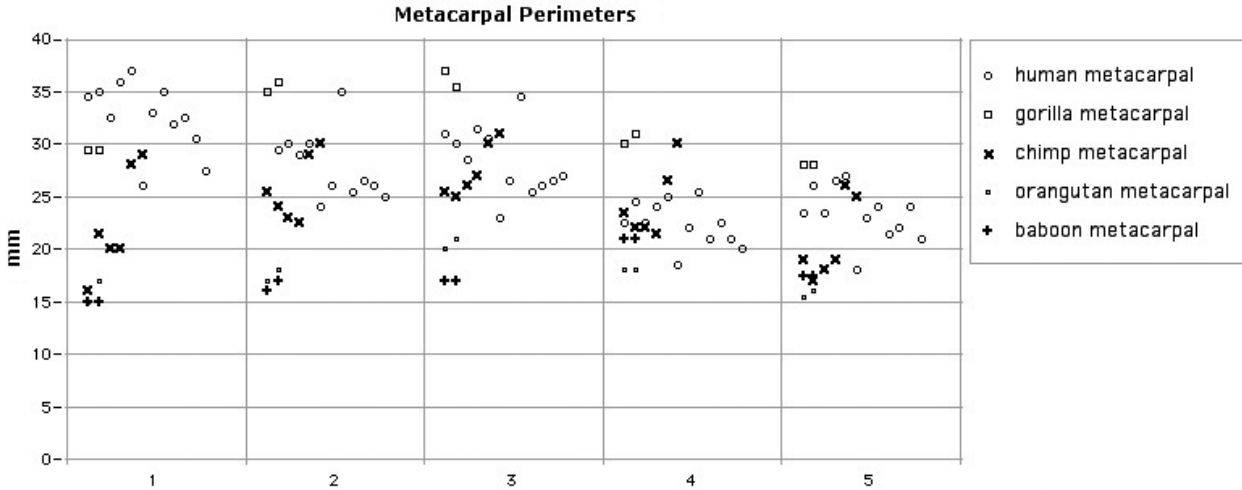

Fig. 5-6. Minimum metacarpal shaft perimeter in man and apes.

In relative terms [Fig. 5-7] the human first metatarsal has twice the periphery ($199\% \pm 8\%$ SD) and hence twice the radius and four times the torsion strength of the smallest metatarsal from the same foot as anticipated [Eqn. 5-17]. The range of similar ratios in the other primate hands and feet is only $155\%-170\% \pm 8\%$ SD for the metatarsals and $101\%-108\% \pm 11\%$ SD for the metacarpals. For the human thumb the ratio is $140\% \pm 10\%$ SD.

The torsion strength of the first ray expressed as a percentage of all five rays using Bredt's formula, reveals three distinct bands [Fig. 5-8]. The top band 45% ±2% contains only the human foot. The second band 32% ±2% contains the other primate feet and the human hand. The third band 16% ±2% contains all the other animal's hands and the only sample of a monkey's feet included in the study.

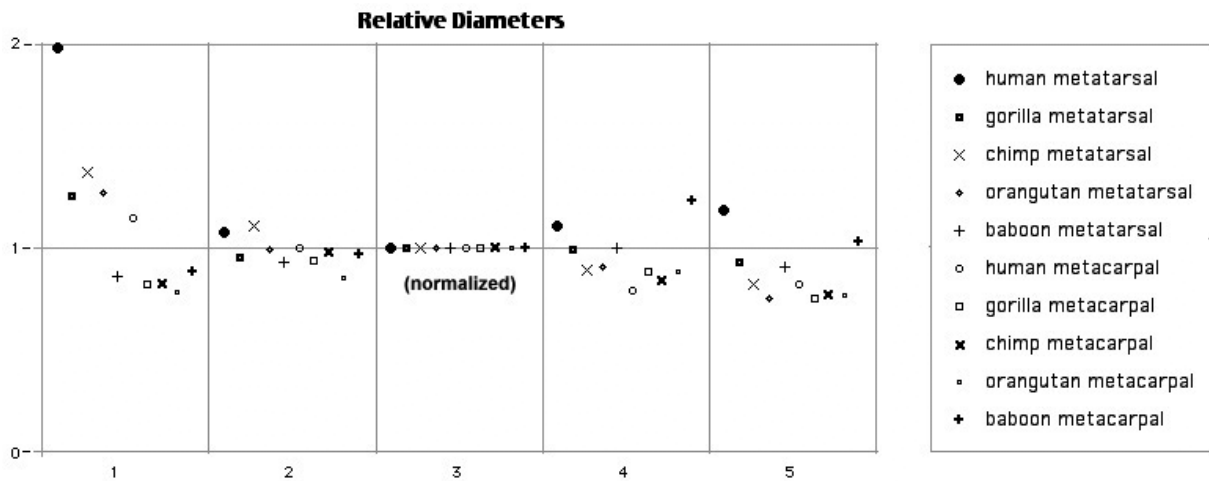

Fig. 5-7. Relative metatarsal and metacarpal shaft sizes in man and apes normalized on the third ray.

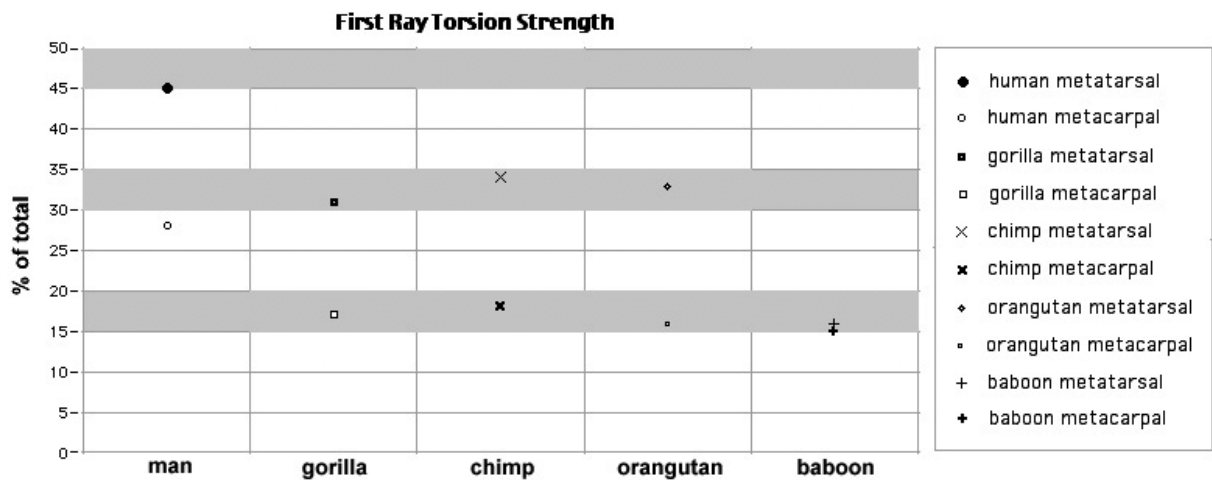

Fig. 5-8. Relative metatarsal and metacarpal torsion strengths in man and apes. First ray as percentage of total.

The thinnest shaft in the human foot is the third metatarsal. In other primates it is typically the fifth metatarsal or metacarpal. The baboon in direct contrast, which is to only monkey included in the study, has the thinnest shaft in the first ray in both its hands and feet (91% and 94%).

5.6 DISCUSSION

The results indicate that the human MT-1 is uniquely optimized for torsion as anticipated. The human foot has a demonstrable capacity to balance supination and pronation torques across the metatarsals. It is certainly possible given the strength of the bones that the MTP-1 joint transmits the dynamic ground reaction torque during the enforced supination of the first metatarsal by passive MTP-1 dorsiflexion.

The new results confirm those of Morton (1952) who appreciated that the 2:1:1:1:1 diameter ratio in the metatarsals seen in static radiographs, leads to a 4:1:1:1:1 distribution of force during locomotion. He attempted to verify this theory with tests-to-failure on five sets of metatarsals in axial compression¹⁶ and data from a staticometer “pressure box”. Gross and Bunch (1989) found that the first metatarsal has a major shaft diameter (14mm) that is twice that of the minor diameter of all the other metatarsals (7mm). These proportions are optimal for the transmission of counter-rotating torsion.

But the new data on metatarsal strengths in the present thesis show something else. A clearly defined quantum banded structure in the anatomical design of the hand and foot bones of man and apes. The regular spacing of the bands in steps of 15%-16% suggests that some form of novel underlying mathematical principle. Philosophically, the advanced bipedal anatomical strata of Fig. 5-8 represents a evolutionary hierarchical form amongst primates that is normally reserved for the human brain.¹⁷

5.6.1 ANATOMY OF THE GROUND REACTION TORQUE

1. Definitions and domains

Any torque is the product of a force and a radial lever arm. A constant GRT for example forms a hyperbola on a force distance graph.¹⁸ The GRT spans two broad regions, the anatomical and the environmental, which are characterized by the extent of the lever arm [Fig. 5-9].

The anatomical region under the skin can itself be divided into two zones separated at the metatarsal perimeter. Inside the metatarsal perimeter, where the forces are large and the distances small, the GRT manifests as bone strain energy—metatarsal torsion. Beyond that, outside the bone the GRT must be stored in external postures in various anatomical relations as a *postural twist*. The forces in this *posture domain* are relatively low compared to the distances. To highlight the dominance of either the force or distance parameter respectively, the internal metatarsal region may be said to convey a *ground reaction torque*, and the region under the skin a *ground reaction twist*, both abbreviated to GRT because they are fundamentally similar in principle.

Inside the bone, energy is transferred longitudinally, axially or serially through the joints. Outside in the posture domain, energy is transferred laterally to the adjacent parallel elements, especially to the lesser metatarsals. Outside the entire human body, is the domain of environmental effects. These can be divided firstly into a *local environment* such as pressure plate, shoes and the flexibility of the floor etc, and secondly on a *global environment* on a geological scale not normally associated with physiology.¹⁹

¹⁶ Morton (1952) p.60. However, in 4 of the 5 first metatarsals tested the fracture point was not reached due to technical limitations.

¹⁷ See introductory quote at beginning of Chapter 5.

¹⁸ The hyperbola serves as a constant baseline reference and it should not be inferred from this alone that the torque is necessarily constant.

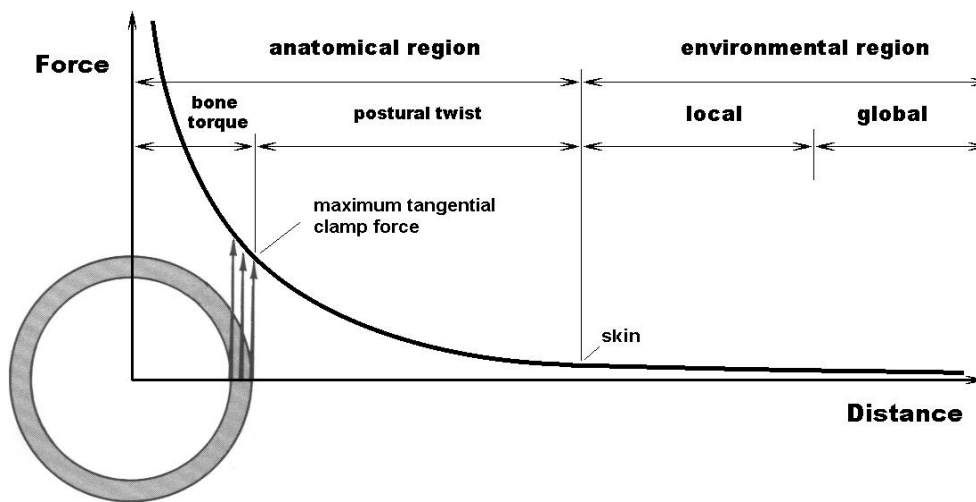

Fig. 5-9. Ground reaction torque hyperbola showing the anatomical and environmental domains of constant torque and twist.

The reason the GRT was detected at all can be inferred from the clamping arrangement for the metatarsal. The rigid structure of the metatarsal bone cortex is effectively extended by the steel clamp, which serves to mechanically amplify the internal torsion effect into the postural domain and transmit it through the skin into the local environment region. The clamp in the previous experiments was at the physiological limit of the metatarsal bone, which explains the perception during the time of the original experiment of a fine tolerance between clamp slip and bone fracture.

2. Internal Metatarsal Torsion

In the torsion region the forces are high compared to the distances, and the material is rigid bone. It is therefore appropriate to study the bone torque using the theory of mechanical stresses and strains. Unlike in cadaver studies where the specimens could be readily tested to failure, ethics requires that the situation *in vivo* needs to be inferred if possible directly from clinical experience.

In solid mechanical shafts, shearing in torsion is the most likely mode of failure.²⁰ A bone in torsion must therefore have an equally strong cortex all around. Contrarily in bending the medial and lateral cortex wall can be thinner on the sides.²¹ The resulting thin bony side wall required for bending may well break if clamped. This may have been the case (Nevin, 1995) where the dysfunctional²² MT-1 bone cortex was simply too weak to support the GRT generated by passive loading of the hallux *in vitro*.

When the lever arm of the GRT is small the force tends to infinity. Which explains rather succinctly why bones are hollow. It also explains and why implant manufacturers suggest internal fixation in the MT-1 is not practical *irrespective* of internal fixation devices.²³ There is additional clinical evidence in the form of a recommendation by surgeons (Ruch and Banks, 1986) that a first metatarsal shaft

¹⁹ There is no theoretical limit to the extent of the lever arm, but in practice it reaches to the edges of the earth's tectonic plates.

²⁰ Popov (1978) p.298.

²¹ The metatarsals in the mid-shaft region have a smooth rounded tubular form with few intracortical trabeculae. As a contrast, the metacarpals are best described as semi-circular or "D" shaped with a flat inferior underside. Sliding the lasso up and down the shaft demonstrated that although the shaft changed shape, the periphery increased only over the tubercles of the muscle insertions, and maintained its dimension in the sections between, evidence which favors a torsion model. With a bending model the optimal shaft dimensions would be expected to increase progressively from the center.

²² Dysfunctional here is synonymous with hinge-like behavior.

²³ AO standard (Ruch and Banks, 1986, p. 198).

osteotomy requires 10 weeks immobilization rather than the usual 6 weeks for other bone repairs. Coincidentally the recommended recuperation ratio of 6:10 weeks (a ratio of 1.67) is practically indistinguishable to the ratio of the relative effective torsion stress bearing capacity of the metacarpal and metatarsal shafts 28%:45% (a ratio of 1.61).²⁴

The reason for extended recuperation time is because of the complication of distal fragment elevation, where the first metatarsal head tends to elevate when the convalescing patient bears weight prematurely. Ruch and Banks (1986, p.198) have commented on the fact that the distal bone fragment, i.e. the MT-1 head, is forcibly raised by passive hallux dorsiflexion. The elevated bone fragment has of course *no muscle attached*. This reaffirms the anatomical hypothesis that it is the osseo-ligamentous mechanics rather than the muscles that apply the extreme stresses to the metatarsal shaft.

The addition time required for the MT-1 to heal can be explained as follows. New bone that is laid down in the medullary canal at a constant rate, increasing the cortex thickness all around. According to Bredt's formula [Eqn. 5-14] this would reduce the shear stress in direct proportion. Contrarily if bending rather than torsion was the critical mode of failure, bone could be laid down preferentially on the superior and inferior aspects where required, allowing faster repair for the same amount of bone replenishment.

The additional stresses are almost certainly due to the demands placed on it by the divergent joint centers of the cam. This is because when any arbitrary point moves in a circle, as each end of the transfixated metatarsal does, it accelerates towards a center. Accelerations define forces. The cam that is anchored to the phalanx has two divergent centers of rotation; a sure enough indication of complex forces in the metatarsal region.

The GRT force is infinite at the center of the bone shaft. Unlike pure bending where the forces at the center are minimal, it is important to recognize that Bredt's formula is *independent* of the *position* of the chosen center; i.e. its location does not affect the torsion bearing capacity of the bone. This is quite unlike the bending center or hinge-joint center, which if not centrally located might cause the entire structure suddenly to become unstable, and burst apart like a badly stacked pile of bricks.

The arch model of the antithesis therefore requires much more assistance from "arch supporting structures". The danger of the bones bursting apart at the joints would greatly increase if the arch actually conspired to move. The torsion model is far better at providing support for heavy objects that actually do move,²⁵ compared to the arch that really only provides support for stationary objects. Most important of all is that foot anatomy designed for torsion does not require a fixed joint center to maintain stability. Besides the *de facto* situation regularly observed in biomechanical experiments, where fixed joint centers do not appear to exist, the torsion model *greatly simplifies* the animate control mechanisms that would be required.

²⁴ This ratio is also the ratio of the Fibonacci sequence 1.618 which is the ratio of the manual digit lengths (Littler, 1973). The resultant equiangular spiral was first discussed by Descartes in 1638. It is the equation of conservation of angular momentum for a particle moving at a uniform radial speed. Jakob Bernoulli was so intrigued by its property of self-similarity whereby any magnified portion of the curve is identical to any other portion, that he had it inscribed on his tombstone. It is the equation's property of [Aristotelian?] self-generation that caused Vollgraff (1953) to refer to it as the *equation of life*.

²⁵ Some famous military tanks such as the German Panther, which are heavy objects designed to move fast over irregular terrain, use torsion bars for their suspension.

3. Distal Twist Relative to Proximal Origin

The segments transferring the GRT can also be arranged *in series*, when rotation is externally induced from one end [Fig. 4-11a]. Passive MTP-1 dorsiflexion imposes a net supination rotation on the connected segments. But since humans do not spin around in circles when they walk, there must be an anatomical mechanism capable of producing a counter-rotation in the opposite direction to maintain their orientation [Fig. 4-11c]. This requires either an external physical constraint (**E'** in Chapter 4) or a form of inertial reservoir such as upper body provided by the floating Archimedian cadaver.

A force or torque applied to a fixed Aristotelian frame does not move that frame. But the effort used must nevertheless be stored as elastic strain²⁶ in an adjacent element of the body. In a twisted body, the lower distal elements of the foot, which have the least inertia are likely to twist first. The twisting then progresses proximally until it is blocked by an equally immovable object applying a torque in the opposite direction.²⁷

Crucially at some stage the initial applied torque from the toe supination will wane and cease altogether when the foot leaves the ground. But then the proximal end of the series of segments that has all along been gathering inertia against the unmoving frame, will continue to rotate as before due to their accumulated inertia.

Only when the foot is "unfixed" by the amputation artifact at the distal end, do the larger *proximal segments* that are now rotating relatively slowly, assume their *traditional* role of a fixed origin of motion. The smaller distal segments then begin to unwind in the opposite direction due to the strain-energy accumulated in the twisted anatomical chain. As the segment junctions twist and untwist, the segments oscillate or vibrate continually if there is no ground resistance.

The oscillation will in reality only endure a part of the gait cycle because there a certain amount of pre-established harmony in the anatomical design. Ideally instead of waiting for the anatomical chain to untwist, one can swap legs so that the untwisting action in the one leg works in synergy with the twisting action of the other. Therefore supination rotation induced in one foot might appear in the other foot at the end of the anatomical chain as pronation, through an anatomical route and mechanism that is yet to be determined.

5.6.2 BIOMECHANICAL JOINT TORQUE

A comparison needs to be made between the GRT and the biomechanical joint torque. The traditional metatarsal-phalanx hinge joint allows the metatarsal bone to be treated as a simple mechanical two-force member.²⁸ With one force acting at each end, the resultant passes symmetrically along the bone's central axis. Any unbalanced components orthogonal to the main axle of motion cause the segment to rotate. These rotations, are known as *biomechanical joint torques*, and their time derivatives *joint powers*.²⁹ But it is important not to confuse these with the GRT which is an artifact of the classical model. The biomechanical joint torque is envisaged principally in the sagittal plane.³⁰ Whereas the GRT arises principally in the bone cross-section.

²⁶ Strain is simply the structural balance between two translation surfaces of an element. Strain can be in compression or tension. Axial strain I postulate is similar to the "cam effect". Twisting is a merger of translation restrained by rotation (the ground reaction torque).

²⁷ It has been deduced from the anatomy that the opposite *pronation torque* is applied by gravity through the off-center talus.

²⁸ Two-force members are typically components of a lattice structure (e.g. Braune and Fisher, 1987 p.127; Inman, Ralston and Todd, 1981). In biomechanics they are usually referred to as *rigid segments* or *rigid links*.

²⁹ The concept of joint torque is most often applied to the three big joints, the ankle, knee and hip. Stefanyshyn and Nigg (1997) measured the MTP-1 joint power. In terms of their running model, the MTP-1 absorbs large amounts of energy (20.9 J) and generates almost none (0.3 J). This confirms the observation that the MTP-1 is indeed a passive joint.

³⁰ Fig. 3-1(b).

Besides the fact that the GRT is an artifact of the sagittal plane rotations, the major difference is that GRT acts *on* the whole joint complex in any direction,³¹ rather than simply *around* the local joint axis or axle where the major motion occurs.

The biomechanical joint power refers to the surplus kinetic energy that appears 'absorbed' or 'generated' once the joint resistance has been overcome. The ground reaction torque, on the other hand is an isometric type of strain energy generated by 'unmoved' counter rotating parts. Any further attempt to reconcile the joint torque with the ground reaction torque has to first deal with the lack of precision of the biomechanical joint center location; a systematic theoretical error in the biomechanical model that masquerades as an experimental quantification error (Panjabi, 1979; Panjabi et al., 1982).

5.7 SUMMARY

- ❖ The human first metatarsal is relatively stronger by an order of magnitude than the metatarsals and metacarpals of other primates.
- ❖ The human metatarsal bones are optimally designed for torsion.
- ❖ Torsion strength in irregular hollow bones is independent of the location of the torque center.
- ❖ The traditional arch model of foot function is redundant during the dynamic phases of gait and should be replaced by a cam model.

³¹ For convenience the GRT is depicted as acting about a cross section of the segment. Although strictly speaking it rotates the whole sagittal plane of the segment, which can be rotated in almost any direction.

6.

PRESSURE PLATE IMPRESSIONS

“For in entering [the Royal Gardens, visitors] necessarily tread on certain tiles or plates.” — Rene Descartes

6.1 INTRODUCTION

Rene Descartes (1637) recounts a visit to the French Royal Gardens, which has been described as a veritable 17th century Disneyland.¹ The gardens had a set of hydraulically operated automations. The actions of which were initiated by the *foot pressure* of a passerby:

“For in entering [passersby] necessarily tread on certain tiles or plates, which are so disposed that if they approach a bathing Diana, they cause her to hide in the rosebushes, and if they try to follow her, they cause Neptune to come forward to meet them threatening them with his trident.”

Descartes supposed that the human body might consist of a series of passive reflexes. Initiated in the Royal Gardens at least by hydraulic *foot pressure*. Newton (1687) also listed *pressure* as one of only three examples of force that causes a body to leave its state of rest. If one considers that there is no initial *percussion* during quiet stance and accepts the prevailing modern view that there is no such a thing as an *animation force*, then the bipedal body action force essentially arises from the *pressure* and *percussion* under the feet due to *centripetal gravity*. Which is about as a comprehensive description of Newton's first principle or axiom of motion as one can possibly get.

6.2 METHOD AND MATERIALS

Fifty-four active² barefoot subjects (22 female, 32 male; 18-69 years old, mean 32 ±11 years standard deviation) were recruited from patrons and staff at a public sports gymnasium. Most were injury free or had only mild foot maladies.³ They were asked to stand quietly on a 0.5m pressure plate, then were prompted to walk over a 2m long pressure plate placed in front of them [Fig 6-1] sufficient distance to capture three walking steps. Thereafter a level walk-off area was provided to encourage a smooth gait pattern after the 2m plate. The subjects were given one or two familiarization walks to optimize their starting foot position. The starting posture was in practice constrained by the width of the sensors on the plate (0.32m). Walking speed and starting foot were not otherwise specified.

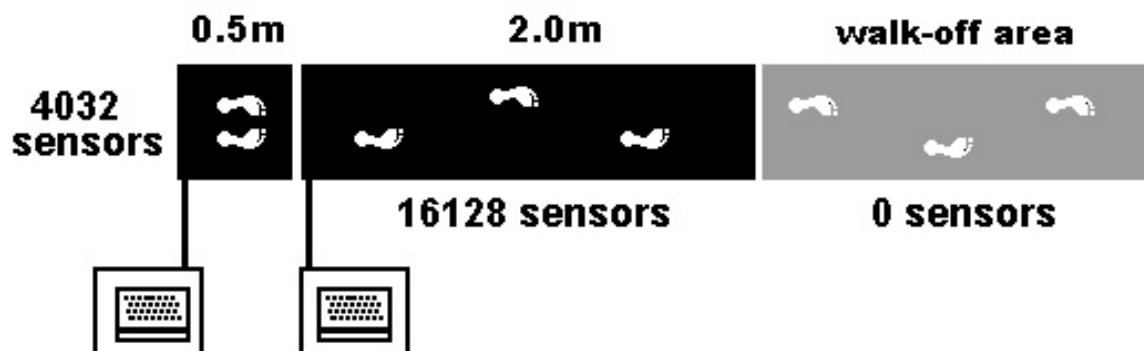

Fig. 6-1. Pressure plate layout.

¹ Flanagan (1991). Disney is synonymous with the 20th century art form of *cinematic animation*. But the 17th century entertainment hub apparently worked through *foot pressure animation*.

² Capable of walking 2.5 metres unaided in less than 2.5 seconds.

³ One male had a right knee replacement, and one was recuperating from neurological trauma to the head after a motor vehicle accident.

Both pressure plates were from RSscan International (footscan® 3D). Data was collected from an array of electrical contact points beneath a resistive mat, spaced 0.5 cm apart laterally (x direction) and 0.75 cm apart anteriorly (y direction). The 0.5 m plate had an array of 63 x 64 active sensors, and the 2 m plate an array of 63 x 256 sensors. When butted together there was a 9 cm dead zone between the active arrays.⁴ The plates were controlled independently from two computers and their dedicated control box that contained the digital signal processing hardware and software (a custom modification of Footscan® 3D Multistep version 6.1) necessary to measure the foot pressure at 100hz. The control boxes were synchronized by cable. Data collection began when the first plate was triggered from the computer keyboard as the subject was standing quietly looking straight ahead. A few seconds later after a brief period of quiet standing, the subject was prompted to walk. The second plate was triggered automatically by foot contact.

The first two footprints (called *steps* here for convenience, although they were not steps in the traditional sense because they had no heel strike) were obtained from the stance phase. The foot that leaves the ground first is called the swing foot (step 1) and the one that remains behind is referred to as the stance foot (step 2). During stance there is no heel strike to define the beginning of the step. These footprints are therefore somewhat arbitrarily defined by a multiple of the time elapsed between the initial toe-off of the first and second feet. The first footprint data trace was cropped at the time equivalent to twice the difference between the first toe-off events of opposite feet. The second footprint is cropped at the same time, resulting in a nominal step duration of three times the toe-off differential. The graphs of steps one and two are therefore synchronized in time but not duration or total force.

The next three footprints, step numbers three, four and five were obtained from the walk. These simply start with heel strike and end with toe-off. The dominant foot is the first to lift and land.

Each subject repeated the sequence 5 times, producing a total of 1350 footprints for analysis. However, only the 5 footprints from the first trial of each subject were used, a total of 270. Of these one subject's data was scrapped because of external electronic interference. Eight subjects either started moving in an inappropriate manner, or at inappropriate times, or stepped off one of the edges of the plates at some stage. These data were all replaced from the next successful surplus trial of the same subject.

The data was processed offline by algorithms especially designed and written by the author and implemented in conjunction with RSscan International capable of the following tasks.

For the whole plate:

- Filtering for hardware artifacts and spurious faint signals.
- Identification and sequencing of left and right footprints.

For each step:

- Dividing each footprint into 10 anatomical regions comprising: (1) great toe; (2) lesser toes; (3)-(7) 1st to 5th metatarsal heads; (8) midfoot; (9) medial heel; (10) lateral heel.

For each sensor, anatomical region and step:

- Finding the maximum pressure, mean pressure, force, maximum shear stress, impulse, start time, end time and duration of contact.

For each frame each step:

- Finding the principle axes and radius of gyration of the footprint.

⁴ The 0.5m plate was turned 90° from the specified 'static' direction in order to ensure a consistency between sensor array dimensions.

- Finding the principle positive and negative impulse axes and radii of gyration.

For each region each frame each step:

- Finding the principle axes and radius of gyration of the footprint with the great toe digitally amputated in order to assess the function of that region.

Almost all these methods are unique developments in the field of dynamic foot pressure measurement. Appendix A contains some examples of the LabView user interface panels developed. To eliminate the variation in the mass of the subjects, foot size and cadence, all steps were *normalized* for:

- step duration.
- force magnitude.

Each step was divided into 100 time intervals (% contact time as the abscissa). Each sensor output was expressed as a percentage of the total force from all sensors over the whole step. This value was then multiplied by 100 to determine its percentage contribution in time, and multiplied by 100 again to determine percentage contribution as a force (% of step load as the ordinate). In many cases relative units were used rather than absolute units. Ordinates are expressed in physical units if appropriate, or as factors of the average for the whole foot.⁵

6.3 THEORY

Gait has long been used as an example of uniform motion despite the lack of *experimental* evidence to corroborate this premise. Without recourse to uniform motion, it must be inferred from the first constraint of Newton's first law that the pressure plate, foot and leg of a free body are all structures that could be grouped together and depicted as a single *body at rest* under compressive load.⁶

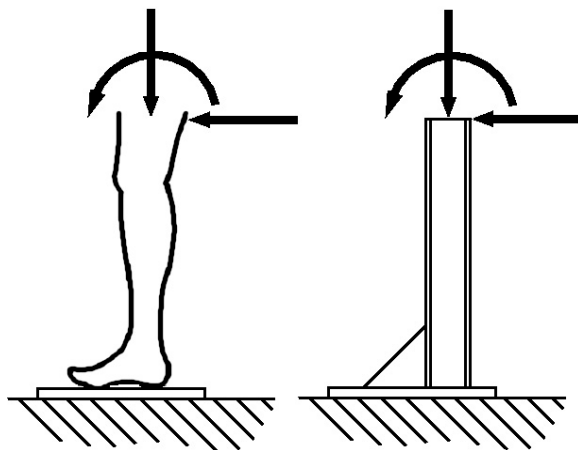

The body is hypothetically analogous to a mechanical beam fixed to an immovable earth [Fig. 6-2] even during activities such as walking and running. In mechanics, the peak forces in a beam are generally calculated from the beam geometry. But in the new *anatomical beam thesis* the opposite applies. The actual forces at various locations on the pressure plate can be measured experimentally; then from these it is possible to deduce the instantaneous structural properties of foot anatomy (Nevin, 2000).

Fig. 6-2. Continuous rest hypothesis. The leg modeled as a mechanical beam.

The center of force is easily calculated. But a *ground* reference axis is also required to visualize the *ground* reaction torque. Inanimate steel beams of irregular cross section such as in Figure 6-2, are routinely described by their principle axes. It makes sense therefore to define the principle axes of the footprint dynamically using the principle axes as the basis for further analysis.

⁵ Because the feet share the weight-bearing at different times and proportions, the ordinates are not necessarily directly comparable after normalization. It is really the shape of the curve that is important.

⁶ The load is entirely compressive because the plate and foot are free surfaces.

6.3.1 PRINCIPLE AXES OF THE FOOTPRINT

To begin, an evenly distributed force (F) is first assumed to act continuously on the plate in the vertical z -direction with equal components (dF) acting on each sensor. The entire plate of area (A) theoretically resists this distributed force at a single point, the center of pressure CoP with coordinates (X, Y) located in an arbitrary coordinate system (x, y) that conveniently coincides with the edges of the pressure plate [Fig. 6-3]. The differential spacing of the pressure sensors x and y determines the centroid coordinates X and Y , given that dF is the measured force at each sensor [Equations 6-4 and 6-5].

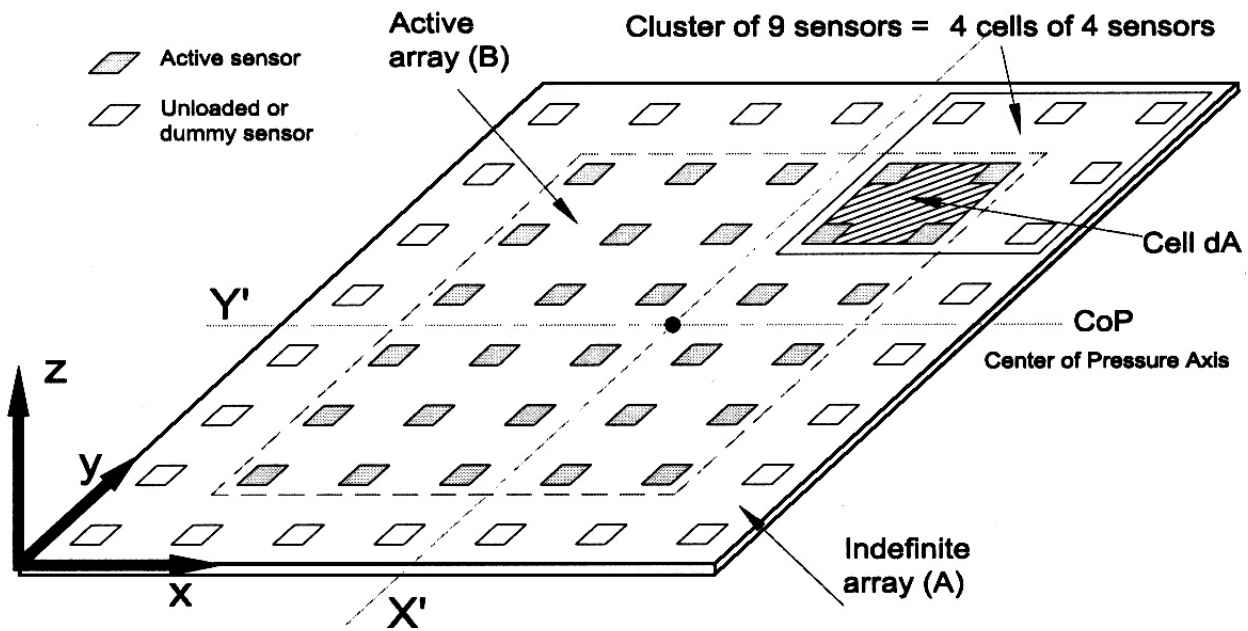

Fig. 6-3. Pressure plate sensor array, divided into discrete cells and clusters of sensors.

Pressure (P) by definition equals the total vertical force (F) spread over the total horizontal area (A) such that:

$$A = \frac{F}{P} \quad [6-1]$$

But the total force F is divisible⁷ into components dF which are the local force applied to the small area dA of the foot around each sensor producing a local pressure dP [Fig. 6-4] such that:

$$dA = \frac{dF}{dP} \quad [6-2]$$

$$A = \sum dA = \sum \frac{dF}{dP} \quad [6-3]$$

The total force pressure is centered at coordinates (X, Y) in the (x, y) plane [Equations 6-4 & 6-5].

$$X = \frac{\sum x dF}{\sum dF} \quad [6-4]$$

$$Y = \frac{\sum y dF}{\sum dF} \quad [6-5]$$

⁷ A necessary condition of the Cartesian *res extensa* coordinate system.

The forces in a static beam are related to a geometric property, the second moment of area I_{yy} and I_{xx} , which is defined relative to the x and y axes and the sensor area dA [Equations 6-6 and 6-7]. An additional term, the rectangular product moment of area I_{xy} is defined relative to both axes [Equation 6-8].

$$I_{yy} = \sum x^2 dA \quad [6-6]$$

$$I_{xx} = \sum y^2 dA \quad [6-7]$$

$$I_{xy} = \sum xy dA \quad [6-8]$$

The instantaneous principle axes of the footprint are defined where the moments due to the distribution of applied forces are a maximum and a minimum. These principle axes pass through the center of force or pressure (CoP). The reference point of calculation is transferred from the corner of the plate to the center of force (X,Y) using the parallel axes theorem and substituting dF/dP for dA [Equations 6-9 to 6-11].

$$I_{x'x'} = \sum y^2 \frac{dF}{dP} - Y^2 \sum \frac{dF}{dP} \quad [6-9]$$

$$I_{y'y'} = \sum x^2 \frac{dF}{dP} - X^2 \sum \frac{dF}{dP} \quad [6-10]$$

$$I_{x'y'} = \sum xy \frac{dF}{dP} - XY \sum \frac{dF}{dP} \quad [6-11]$$

The minimum and maximum second moment of inertia (I_{min} , I_{max}) and the angle (ρ) the principle axes forms with the posterior edge of the pressure plate (x-axis) and the maximum shear stress (τ_{max}) are then calculated using the Mohr's circle construction [Equations 6-12 through 6-15].

$$I_{max} = \left(\frac{I_{x'x'} + I_{y'y'}}{2} \right) + \sqrt{\left(\frac{I_{x'x'} - I_{y'y'}}{2} \right)^2 + (I_{x'y'})^2} \quad [6-12]$$

$$I_{min} = \left(\frac{I_{x'x'} + I_{y'y'}}{2} \right) - \sqrt{\left(\frac{I_{x'x'} - I_{y'y'}}{2} \right)^2 + (I_{x'y'})^2} \quad [6-13]$$

$$2\rho = \arctan \left(\frac{-2 I_{x'y'}}{I_{x'x'} - I_{y'y'}} \right) \quad [6-14]$$

$$\tau_{max} = \left(\frac{I_{max} - I_{min}}{2} \right) \quad [6-15]$$

Equation 6-16 defines the radius of gyration (RoG) about the center of pressure. The RoG is a mathematical property that characterizes the load distribution.

$$RoG = \sqrt{\frac{(I_{max} + I_{min})}{\sum \frac{dF}{dP}}} \quad [6-16]$$

The value of the seemingly trivial substitution $dA = dF/dP$ needs perhaps to be explained. The effect of regions of peak pressure can be quantified by first assuming an evenly spread force. The local pressure term dP is normalized to unity using the subject's weight divided by the footprint area [Fig. 6-4]. The term dF/dP is then proportional to dF everywhere because dP is constant over the whole footprint [Fig. 6-5]. The pressure on any part of the plate is then invariant and can be treated as constant. This makes invariant *pressure* rather than invariant *area* the baseline parameter for the bipedal body action force.⁸

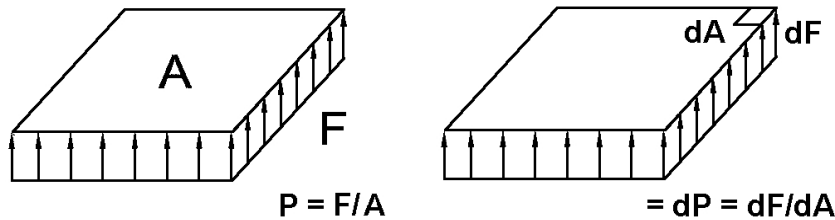

Fig. 6-4. Mean pressure distribution on plate.

The substitution $A = F/P$ allows one to distinguish the effect of a unit force in relative space from its effect in absolute space. The effective weight bearing area dA has to be multiplied by the local force dF relative to the mean pressure dP . This is equivalent to intensifying the force on the local anatomy over a fixed sensor area.

But the rotation induced by the unit force dF about any arbitrary horizontal axis, increases linearly as the force moves away from that axis [Fig. 6-6]. This is purely a *geometric effect* that relates the components of the applied force to their positions in the pressure sensor array. Thus even although the unit pressure is constant, its effect varies with respect to location.

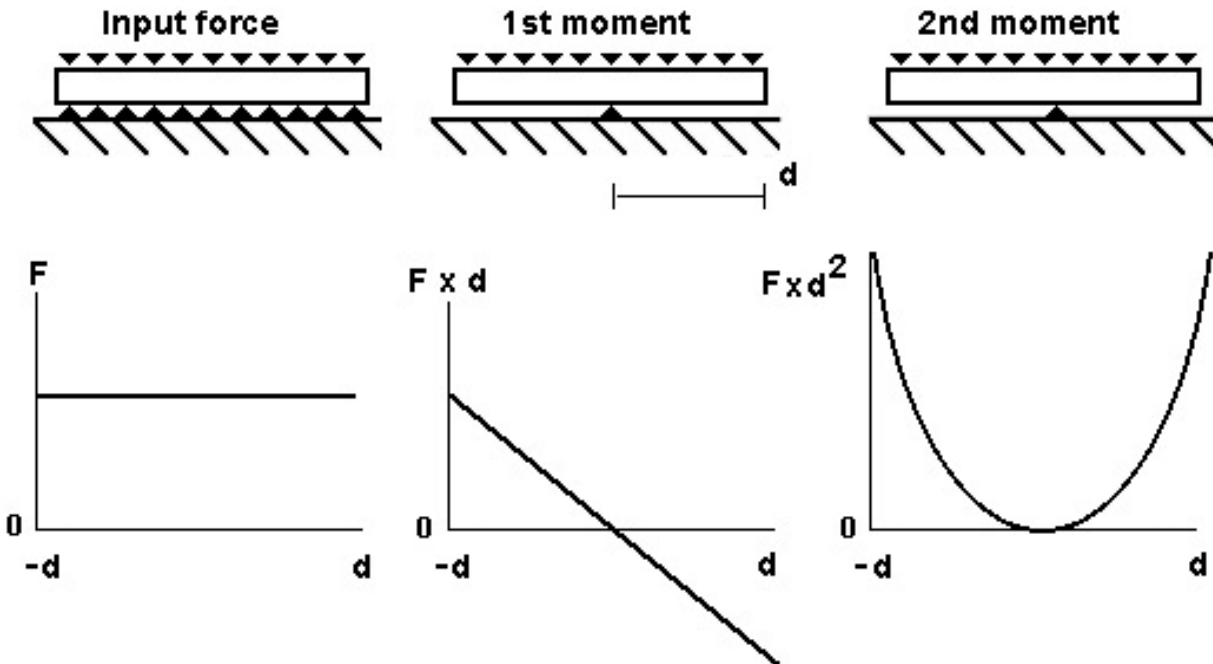

Fig. 6-5. Moment profiles arising from an evenly distributed force.

⁸ A description that is consistent with Newton's characterization of an impressed force (Newton, 1723). Definitions 3-5 as well as Scholium II.

Therefore when the actual footprint is superimposed on the unit force profile schematic that includes the second moment [Fig. 6-6] it becomes obvious why the anatomical descriptions of forefoot supination and heel pronation, are considered clinically important. The peaks in the corners (i.e. supination-pronation directions) are higher than the trough-axes (inversion-eversion; flexion-extension). This means that a unit force applied in the corners of the footprint, especially at the great toe for example, is much more effective at influencing rotation on the pronation-supination axis than a similar force applied to the mid-foot region. It is therefore not surprising that Hicks (1954) observed a connection between passive great toe dorsiflexion and foot supination-inversion.

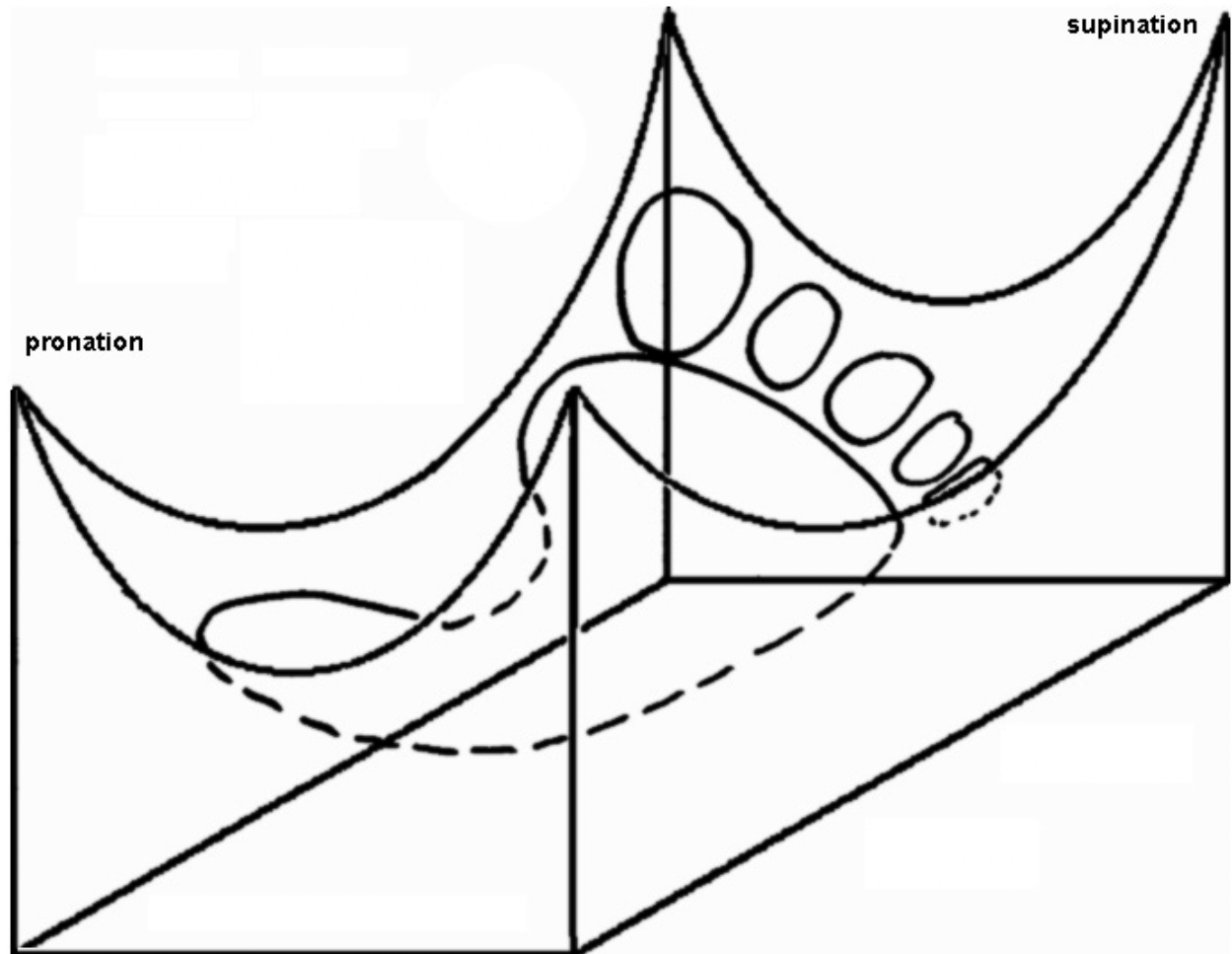

Fig. 6-6. Second moment profile produced by an evenly distributed force, in two orthogonal directions superimposed on a footprint. Note the prominent position occupied by the great toe.

6.3.2 SHEAR STRESS

Instead of treating the leg as a single cantilever beam, the foot can be assumed also to consist of an array of rectangular beams segments with a pressure sensor at each corner. The principle axes and various other properties can then be determined for each beam fiber individually. By comparing adjacent beam fibers variations in the loading conditions under the foot can be estimated.

Importantly the shear stress *along* the principle axes in a beam are zero, and at a maximum when *equidistant* between the axes. This produces an estimate the *shear stresses* in the *contact surface* between the foot and the ground.⁹

The horizontal sensor array was divided into temporary clusters of 9 sensors in 3 rows of 3. Each cluster consisted of 8 sensors in the perimeter and 1 in the center. Each sensor in the whole array in its turn thus formed the center of a temporary cluster [Fig. 6-3 & 6-7]. Dummy or unloaded sensors were added to the rim of the array as necessary. Each cluster was further divided into 4 cells of 4 sensors in 2 rows of 2 [Fig. 6-7].¹⁰ The sensor at the center of the cluster being the common link to all the surrounding cells. Each cell shared one edge with an adjacent cell of the same cluster. The single central sensor being part of all the cells.

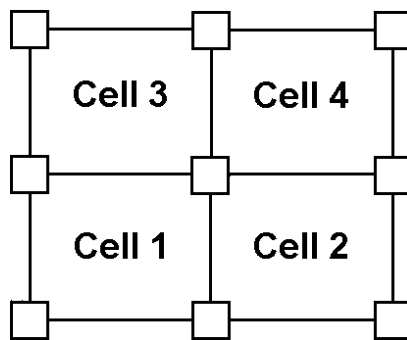

Fig. 6-7. Clusters of nine sensors consisting of four cells of four.

The equations [6-1 to 6-12] are applied to each cell with one sensor at each corner to first determine the orientation and magnitude of the maximum shear stress that occurs at $\rho + 45^\circ$ where ρ is the principle axis direction from the posterior edge [Fig. 6-8]. The shear stress vector components were projected onto the faces of the cell that shared a perimeter with an adjacent cell [Fig. 6-9; Eqns. 6-17 & 6-18].

$$\tau_{x1} = \tau_{\max1} \cos(\rho + 45^\circ) \quad [6-17]$$

$$\tau_{y1} = \tau_{\max1} \sin(\rho + 45^\circ) \quad [6-18]$$

$$F_x = (\tau_{y2} - \tau_{y4}) + (\tau_{y1} - \tau_{y3}) \quad [6-19]$$

$$F_y = (\tau_{y3} - \tau_{y4}) + (\tau_{y1} - \tau_{y2}) \quad [6-20]$$

An arbitrary clockwise positive shear flow convention was assumed for each cell. The contributions of the shear flow along the cell boundaries were summed [Eqns. 6-19 & 6-20] with the resultant net shear vector (F_x , F_y) assumed to act on the sensor at the center of the cluster [Fig. 6-10].

⁹ Patent application EP 00200568.4

¹⁰ The 2x2 grouping is the basic mathematical form of area, similar to Descartes' clear and distinct model.

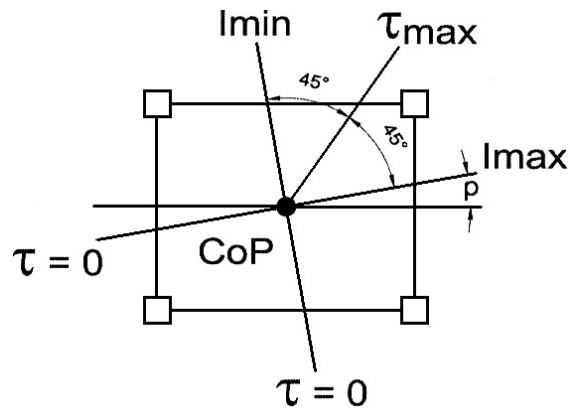

Fig. 6-8. Principle axes of a cell of sensors.

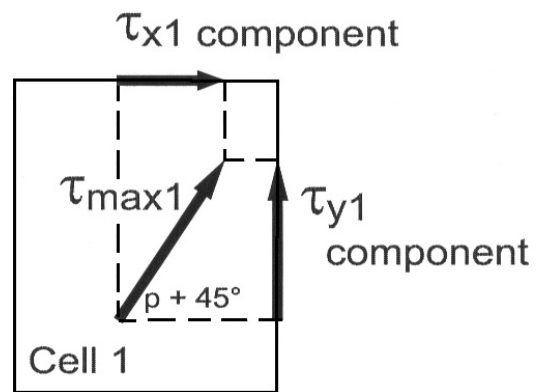

Fig. 6-9. Shear vectors at cell boundary.

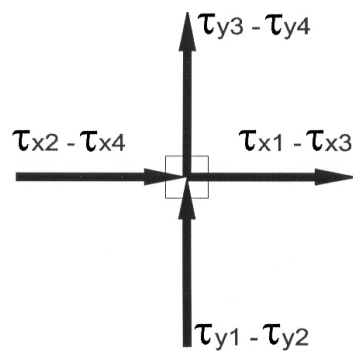

Fig. 6-10. Cluster of resultant cell shear vectors summed at central sensor position.

6.3.3 IMPULSE

Impulse is the product of force and time. It has the same units as *momentum*. It is a quantitative measure of percussion, Newton's second of three examples of the constituents of the impressed force.

The pressure plate area produces a 2D picture or a discrete *frame* of local footprint loads every fraction of a second. By subtracting consecutive frames the change in force (dF) can be determined for each sensor acting over a short time (0.01s). The impulse can thus be viewed as the active component of the total force being applied.

Unlike the applied force which is always compressive (positive), the impulse can be positive (increasing force) or negative (decreasing force). Areas of positive impulse indicate where the load is being applied, and negative impulses indicate where the foot is beginning to lift.¹¹ It is postulated that the changing positive and negative impulses can be effectively treated as separate phenomena, each with its own center and spatial distribution.

The local impulses also potentially act as the primary links in a cinematic animation sequence of foot pressure based on the mathematically-determined 4D second moment of area.

6.3.4 RADIUS OF GYRATION

The radius of gyration (RoG) represents the point or line parallel to the axis where the total force or impulse that is distributed over a wide area can be concentrated in a single line.¹² It provides a useful and succinct summary measure of the whole footprint frame in one parameter.

The RoG however has also been determined for:

- ❖ the total pressure,
- ❖ positive impulse and
- ❖ negative impulse

All of which provide new insights into foot behavior. Whilst the principle axes describe the axis of rotation, the RoG describes the magnitude or direction of the resistance to rotation.

Appendix B contains a cinematic animation of the mathematically determined principle axes and the radius of gyration of the first five footprints of gait initiation of one 38 year old male subject.

¹¹ In all cases the net force is still compressive or zero. The sign of the impulse therefore shows a level of intention or predisposition to later movement.

¹² The RoG is actually a quadratic function of area distribution, that is consequently difficult to visualize as a single dimension.

6.4 RESULTS

Data was collected from the pressure plates, and the equations solved to find the principle axes at every instant. The results of the 54 subjects are presented in Figures 6-11 to 6-21. The curves presented are all averages, medians or standard deviations, and thus not representative of any individual. Consequently, detailed interpretation of the curves needs to proceed with some caution.¹ But it is similarly unwise to present case studies first without some prior population profile assessment because this may introduce observer bias before the normal is established statistically. Case studies are not therefore presented here.² However, the fairly large number of subjects recruited for the study certainly increases the confidence level.

6.5 DISCUSSION

It is not possible to provide a full analysis on all of the data, leaving its mining and analysis for another occasion.³ Discussion is limited to those results needed to:

- *confirm* experimental basis of the *major premises* of the thesis, currently deduced from other sources.
- *investigate* the neglected *percussion* component of the Newtonian impressed force, through the *impulse*.
- *overview* the new anatomical principles, such as the *principles axes* and the *radius of gyration*.
- *preview* the more complicated phenomena such as *shear stress and strain*.

6.5.1 MAJOR PREMISES

1. Biomechanical

The preexisting *force plate* data that lead to the principle premise of the thesis⁴ is reaffirmed by the new regional *pressure plate* data [Fig. 6-12]. Initially the force under both heels increases relative to the forefoot, which means the center of force (CoF) moves backwards. The reduction in pressure under the stance forefoot (step 2, Fig. 6-11) causes the center of force to incline to the swing heel. It then moves across to the stance heel as the force increases under that heel before moving forward to the toes.

¹ This is an unavoidable consequence of the data being normalized on both the time abscissa and ordinate. Averaged data is also problematic when applied to discontinuous variables. These problems are sometimes reduced by presenting median values rather than mean values. The final choice of presentation mode depended entirely on a subjective comparison with a broad range of individuals.

² See Appendices A and B for some of the data from a single trial of a 38 year old male.

³ It should be recalled that the early chapters of the thesis are themselves based on a detailed post hoc analysis of data generated in a previous dissertation, and a similar fate no doubt awaits the new data generated from the principles of animate motion developed in this thesis.

⁴ cf. Fig. 1-1, p.2.

2. Anatomical

- The standard deviations of force in Step 1 [Fig. 6-13] show that the first convergence of *any* action across the subject population is the reduction of force under the great toe. This *statistically* confirms the observation that gait initiation is associated with the initial dorsiflexion of the great toe, more so than with any other factor investigated.
- The total force time-trace [Fig. 6-11] under each foot shows that the force under the initial stance forefoot (step 2) starts to decrease first at 25% of nominal contact time. The initial decrease in total force under both feet means that gravitational potential energy is indeed made available to power the gait passively.
- The force under the swing foot (step 1, Fig. 6-12) does not appear to change initially. However at about 23% contact there is a gradual drop in the MT-1 force, while the force under the lateral heel increases. The lower MT-1 force is due to the arch buttresses lifting; and the lateral increase is due to the heel inverting. Confirming Hick's (1954) observations that the foot inverts upon passive hallux dorsiflexion.⁵
- The total force on the swing foot (step 1, Fig. 6-11) however does not change substantially.⁶ This means that the weight is being *redistributed* between heel and forefoot during this time rather than being applied or removed.
- The *total force* under the swing foot (step 1, Fig. 6-11) begins to *increase* (after 40% contact time) but only after the total force under the stance foot (step 2, Fig. 6-11) has *decreased* from 26% contact time onwards. This is surprising and somewhat counter-intuitive because one might expect the swing foot to be lifted by muscle for example before it moved forward; and the foot staying behind receiving the transferred weight. In the beginning the opposite actually occurs. The pattern is explained better in step 1 Fig 6-12, which details the force distribution by anatomical region.
- The initial swing foot starts lifting at 50% contact time (step 1 Fig. 6-12) which is accompanied by a *lateral weight shift* to the stance heel. Again this shift is seen in the previous force plate data [Fig. 1-1]. There is also a brief period in time (step 2, Fig. 6-12, 64%-74%) after the first heel leaves the ground where the pressure *on the lateral side* of the heel is greater than on the medial side. This relatively high lateral loading, where the average lateral heel load is higher than the medial load, occurs nowhere else in the gait cycle except at the beginning (i.e. steps 1 and 2).
- In the 3rd footprint the first after heel strike (step 3, Fig. 6-12) there is a high MT-1 force under the first metatarsal head compared to steps 4 and 5. This appears to be a continuation of and/or corrective compensation for the lateral sway onto the initial stance heel noted above. This *compensatory control* is essentially completed before the next step (step 4) when the force at the MT-1 head is similar to the other metatarsal heads.

⁵ cf. Section 2.2.2, p.12.

⁶ Actually the total force in step 1 appears to increase a little. But there is a slight chance this 5% increase may be due in part to a non-linear calibration curve for the hardware in the higher pressure range that is experienced under the heel.

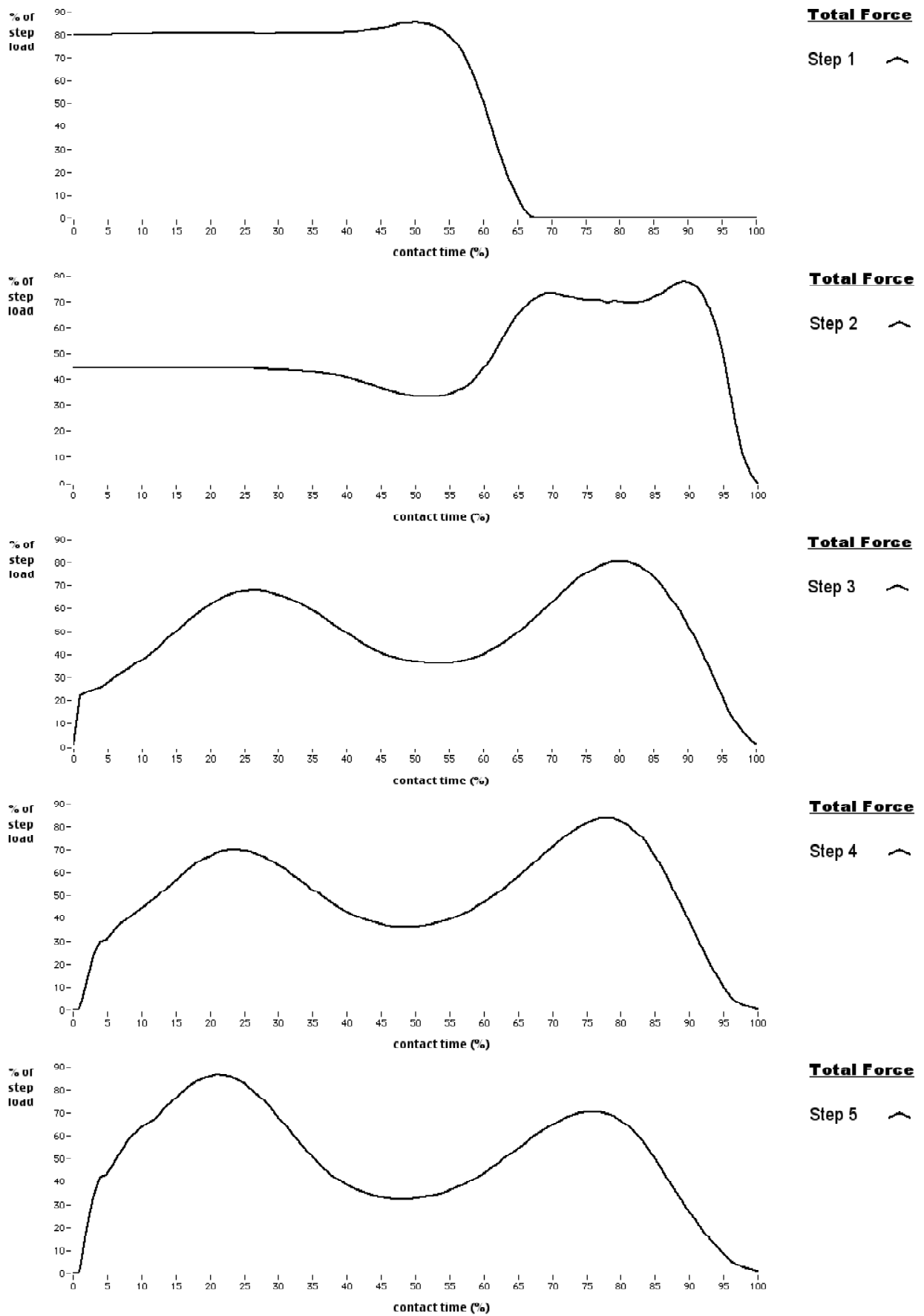

Fig. 6-11. Total force profiles beneath the foot; mean of fifty-four subjects.

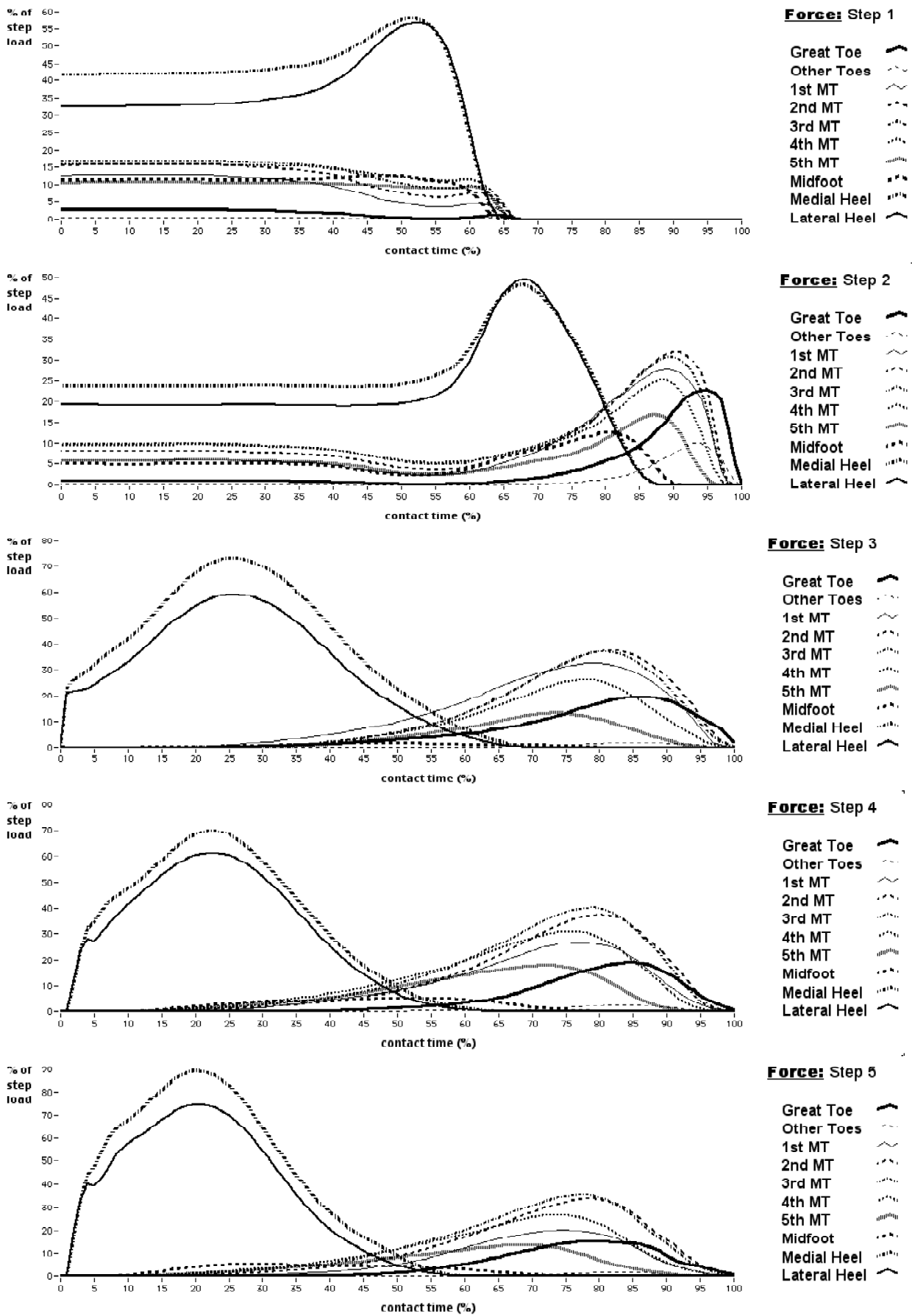

Fig. 6-12. Relative distribution of forces beneath the foot; mean of fifty-four subjects.

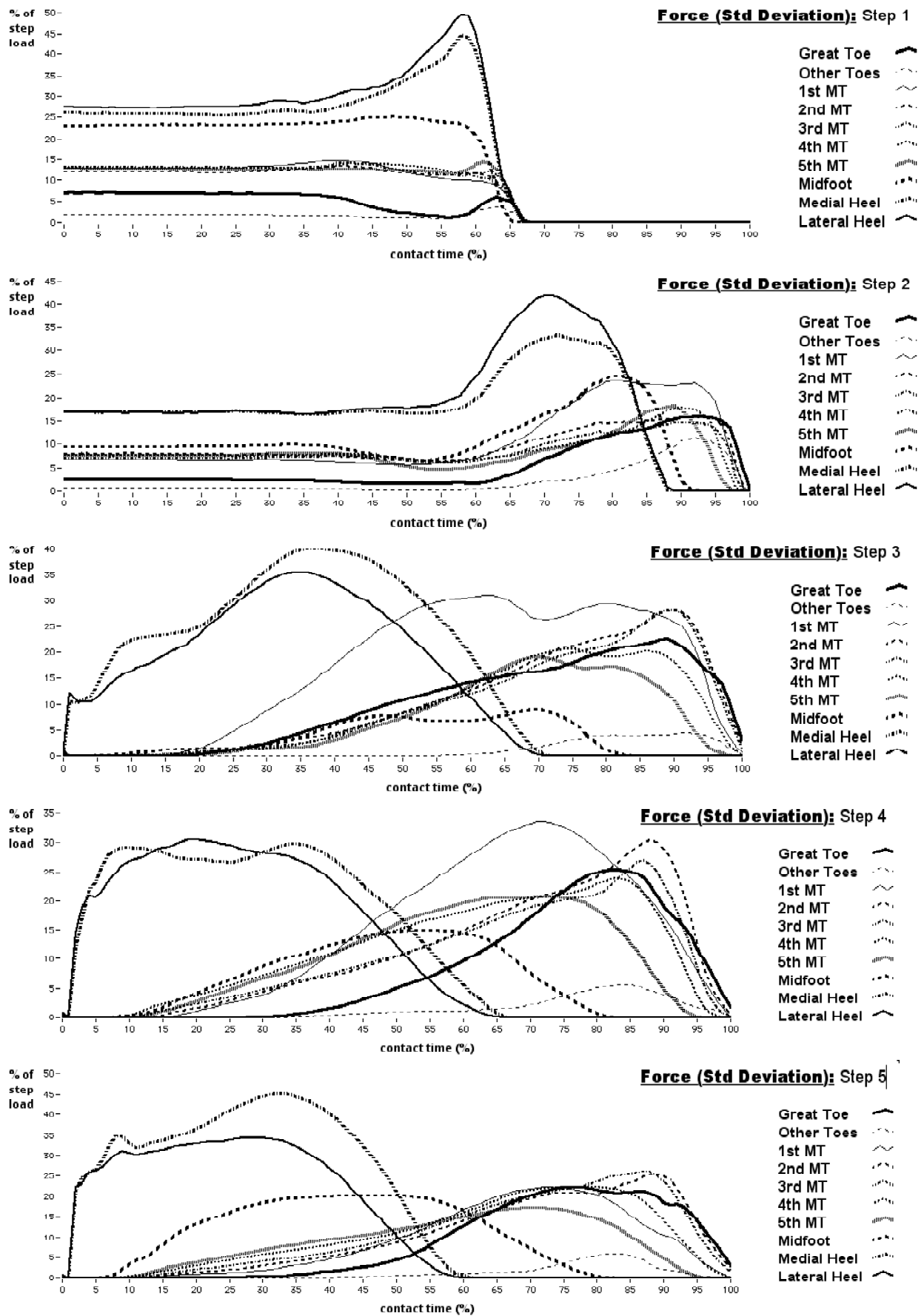

Fig. 6-13. Standard deviation of forces beneath the foot, mean of fifty-four subjects.

6.5.3 PRINCIPLE AXES

1. Initial Posture

The principle axis describes the direction of the dynamic footprint as a *foot angle* from the start line. On average (step 1 and 2, Fig. 6-14) the swing foot is 2 degrees less abducted (71°) than the stance foot (69°). When gait first starts, at about 22% into step 1, the negative impulse axis remains more or less straight ahead (70° - 75°) with a 1° or 2° medial shift. The positive impulse axis is inclined about 5° - 10° to the side, which indicates that both feet invert. Thus the initial load is being preferentially removed from the medial side of the foot and preferentially applied laterally; i.e. the foot inverts and supinates. Hicks (1954) observed that foot inversion and supination are induced by passive dorsiflexion of the MTP-1. The actual dorsiflexion of the MTP-1 is confirmed by the standard deviation of the great toe force (Fig. 6-13). Thus the results verify the first anatomical hypothesis.

However, this inverted-foot stance loading pattern is reversed immediately after the heel is lifted for the first time (step 1, 55%) i.e. when the gait stride begins. Thereafter for every step (step 2 to step 5) the average load is *always* applied medially and removed laterally. Almost certainly due to weight-bearing on the off-centered talus as indicated by Morton (1952). But to achieve this footprint pattern, force needs to be transferred internally from the medial to the lateral side of the foot by either shear or roll, from whence it is removed. The lateral transfer can be provisionally explained by supination of the first metatarsal bone, as an antagonist to lesser metatarsal bone pronation (Chapter 5).

What is remarkable during the initial posture phase, is that the angle patterns of both feet are very similar. This similarity is also seen in the radii of gyration (Fig. 6-15). Thus either foot could adapt at short notice to the role of stance or swing leg. Indeed this is reflected in the *de facto* situation. Twenty nine subjects stepped-off with their right foot first compared to twenty five with their left. A surprisingly small right-side dominance of only 54%.⁷

2. Gait

The small foot angles of the first walking steps (Fig. 6-14, steps 3 to 5) indicate that the pressure is initially directed laterally when the heel lands. As the gait develops, the foot pressure angle shifts more into line with the direction of travel. This initial heel contact phase typically lasts only 5% of the step duration. Detailed examination of individuals indicates that the principle axis angle can change for two reasons. First it may rotate gradually like the hands of a clock, or it may discontinuously switch 90° as the minor and major axes of the second moment of area exchange places. This discontinuous axis change-over is smoothed in Fig. 6-14 by the population average.

Viewed from above during the double-stance phase there is a distinct interaction between the principle axes of the heel of one foot and forefoot of the other when parts of both feet are on the ground. A further observation is that there is a striking coordination between the forefoot and heel contact of opposite feet. So much so, that in many individuals the parts of the two feet can be combined to produce a third footprint. This virtual third footprint may explain why walking is naturally so efficient and also explain natural pace and stride length selection.

The last 5% of each step is controlled by the action of the MTP-1. The magnitude of this control is assessed by digitally removing the great toe and redistributing the load in a computer simulation. The results show that this period is the only time that amputation of the great toe has a marked effect. However that effect is at a critical time when mechanical action is being transferred between the feet during double stance period. If the great toe is amputated, then the effect in living subjects would be evident in a study of this period.

⁷ The hands show about 90% right sided dominance, which is similar to the 91% of runners who exhibit a higher medial load on the right foot (Praet et al., 1999). Right-handedness follows from the specialization of brain hemispheres. The low hemisphere dominance in the foot at the start of gait supports the hypothesis that gait is not primarily neuromuscular.

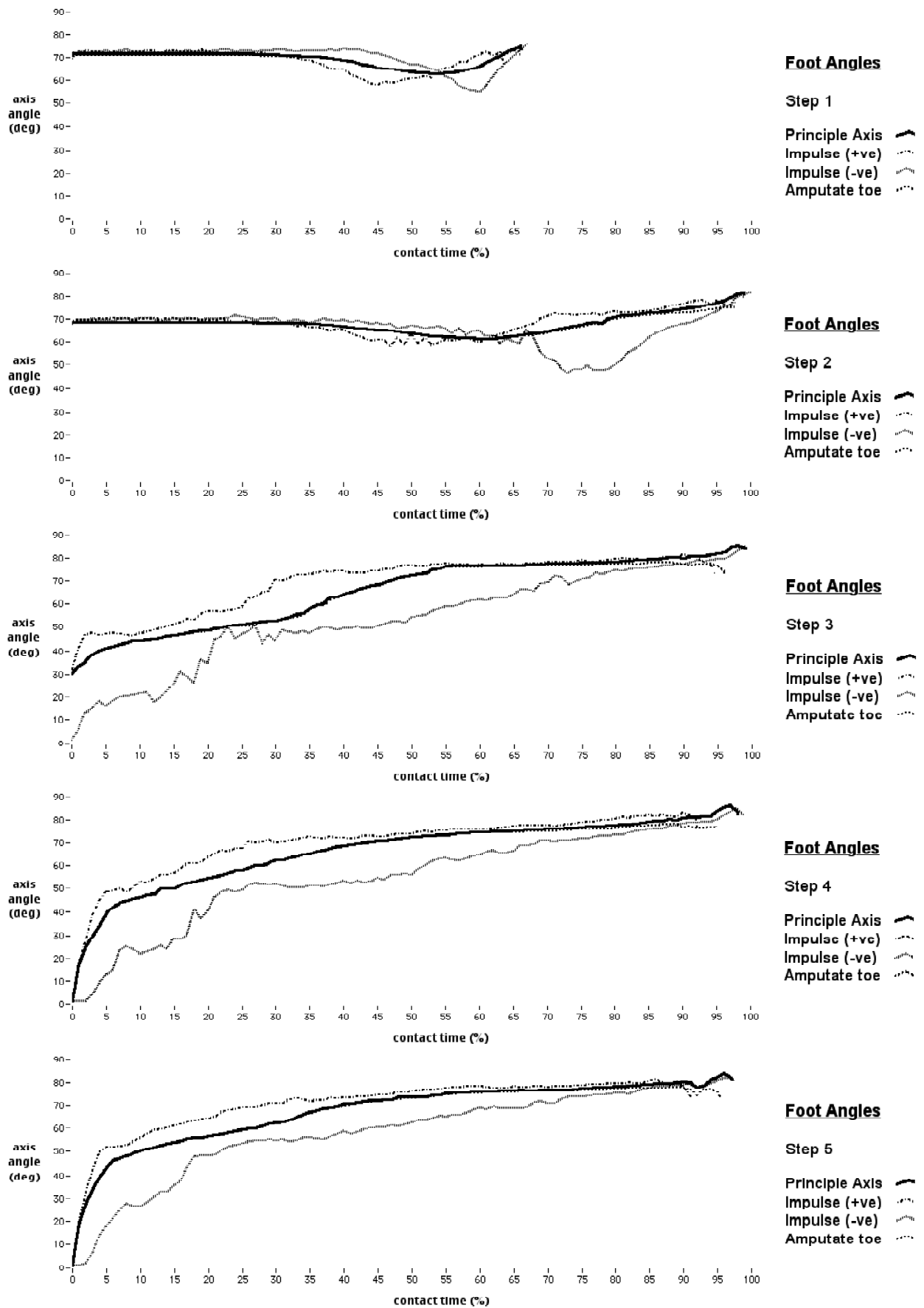

Fig. 6-14. Foot angle defined by principle pressure and impulse axes with and without great toe in fifty-four subjects.

6.5.4 RADIUS OF GYRATION

The radius of gyration [Fig. 6-15] is perhaps one of the more interesting parameters to emerge from the 4D mathematical animation. The radius of gyration is useful because it is a single parameter that summarizes the pressure distribution of the entire footprint frame. When the positive and negative impulses are included, the 4D animation can be reduced to 3 factors that may succinctly quantify dynamic stability, balance and control.

The RoG is formed from the second moment of area which has dimensions $[L]^4$. The cinematic animation of this parameter spanning as it does two consecutive frames, is referred to as 4D mathematical animation. The second moment of area appears in three dimensional form as a single set of orthogonal axes, their angle and relative magnitudes.

The formula for the radius of gyration [Eqn. 6-16] shows that when the pressure is high in the denominator then the radius is reduced. A small radius is thus indicative of a high centralized pressure, as occurs during heel impact for example. A large radius is indicative of a more widely spread pressure, which is consequently more stable.

During standing (step 1 and 2, Fig. 6-15), the radius of gyration is about 14cm. The radius of gyration of both impulses are about 15cm. The fact that the active impulses are more widely distributed than the gross pressure indicates that the standing foot is an intrinsically stable support structure. Gait starts at about 22% into the step with a reduction in the applied load radius. This reduction soon effects the radius of the total force. At 53% the applied and removed loads begin to swap both directions and magnitudes after 55% the radius of gyration increases dramatically to from 10cm to 20cm as the swing foot leaves the ground.

The same overall pattern is seen in the stance foot (step 2 Fig. 6-15), except the radius of gyration climbs to about 24 cm at toe-off. This final stage of the stance posture period is where the radius is largest. In terms of Newton's first law of motion the transition between rest and uniform motion characterizes an impressed force. The result in Fig. 6-15 step 2 demonstrates that the actions that accompany MTP-1 dorsiflexion that occur at the very last stage of the *rest posture* are critical for the transition and hence are key to understanding the nature of the human bipedal body action force.

One may for example compare the balance and control function of the great toe to the tail of an aeroplane because the dorsiflexed toe in the trailing leg always protrudes behind the subject. Direct control and stability during flight is best accomplished from the trailing tailplane section. The same principle applies to human gait particularly during running that has a flight phase.

After the rest posture has ended, and the gait posture has begun (step 3, 4, 5, Fig. 6-15) the radius of gyration at heel strike starts at about 4cm.⁸ It remains reasonably constant at about 5cm until the positive, gross and negative impulses diverge, each in its own in turn, increasing to about 20cm. These transitions are due to the forefoot contact and the heel lifting.

What is remarkable about these curves is that the force applied to any location must by definition be removed from that same location where it was applied in the first place, also in equal magnitude. It is thus a peculiar feature of the animate foot that the distribution of the applied load is broader than the distribution of the removed load. The physical meaning of these curves warrants further attention.

Appendix B contains a cinematically animated sequence of the RoG in plan view from one subject.

⁸ The initial slope at 0%-1% of steps 4 and 5 appears to be an artifact due to a rounding error in the interpolation at the zero time limit. Similarly the rounding error that appear at the 99%-100% limit has been cropped from the graphs in most Figures.

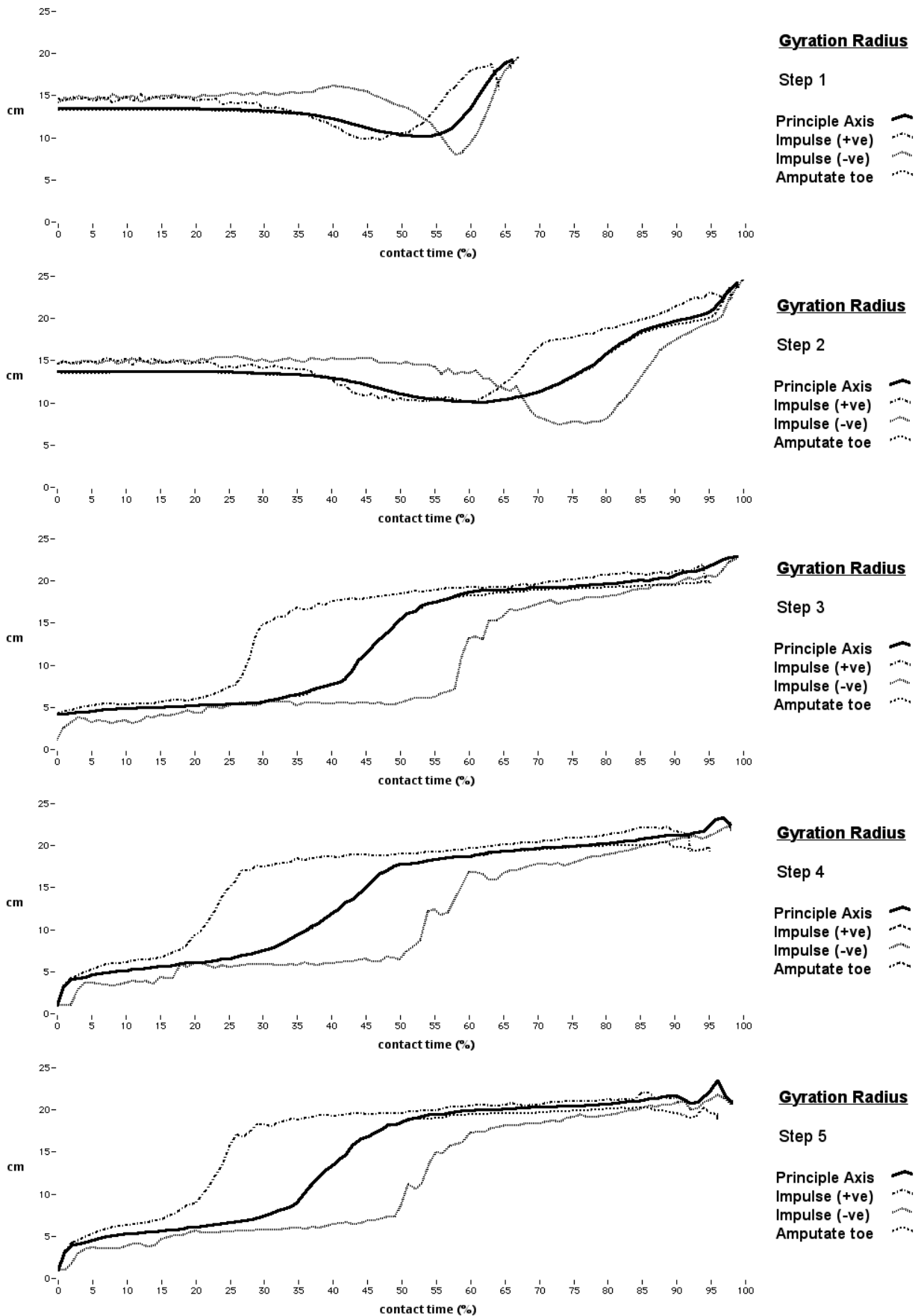

Fig. 6-15. Radius of gyration for total force and positive and negative impulses; median of fifty-four subjects.

6.5.2 IMPULSE

A mechanical *impulse* is the momentum imparted by the product of force and the time duration of its action.⁹ The importance of impulse is that it quantifies the percussion or impact that Newton lists as one of only three examples of an impressed force that might cause a body to leave its state of rest.

An impulse signal can result from an object either bouncing, shearing, sliding or rolling along the pressure plate.¹⁰ Dividing the plate into regions of sensors means that the impulse in a specific region can contain both positive and negative values [Fig. 6-16]. In force plate model where the pressure distribution is reduced to a point force, these impulses would cancel out.¹¹

The positive impulse records a loss of momentum-energy from the impacting body as it compresses and slows during the collision. The negative impulse represents a gain in energy from the surface after the impact as the body rebounds (i.e. lifts vertically), rolls or slides away horizontally (i.e. shears sideways with kinetic energy). The absolute positive impulse minus the absolute negative impulse (the net impulse) quantifies the amount of momentum being transferred perpendicularly through the surface of the pressure plate. A rolling or sliding body would have no net vertical impulse.

The impulses during the initial posture-stance phase are small because there is no heel impact or percussion. Initially nothing dramatic occurs, except for a possible preparatory or anticipatory phase (Fig. 6-16, step 2, 35%-48%) where the background random signals during posture separate to two bands. The impulse profile forms into a regular pattern almost before the first foot leaves the ground from 60% step 2. A pattern that then repeats every step thereafter.

The impact of the heel creates a large spike.¹² After the initial impact spike, the positive and negative heel impulses are almost parallel in steps 3, 4 and 5 from about 12% to 30% of the step (Figs. 6-16 to 6-17). The constant separation over this time reflects a constant rate of momentum transfer by a combination of impact, shear and roll of the heel. On impact, forces are applied to the plate causing the heel to end its descent. The negative impulse thereafter indicates the removal of the body-mass, due either to the foot being lifted, or rolling-off. In both cases during the negative impulse the momentum transfer is into the body, either as strain, or as kinetic energy.

The practice of designing shoes to absorb impact to "protect" the foot from impulse spikes, may in fact cause damage to the foot later in the step. If the positive spike is reduced by compliance in the local environment zone of the GRT for example a shoe, it would spread out in time. Thus increasing the momentum transfer in the mid-foot anatomy during a later phase of the cycle. The potential dangers of artificial foot cushioning have long been recognized by some researchers (Marti, 1989; Robbins and Gouw, 1991 & 1992; Robbins, 1997) but dismissed by others (Frederick and Cavanagh, 1992).

⁹ It is traditionally assumed for impulse that the impact force does not displace the impacted body. A condition that is valid provided the time interval is kept small and the surface does not move much.

¹⁰ The bounce component is related to the cam compression, and the shear or roll is related to the ground reaction torque component.

¹¹ The impulse from a pressure plate reveals considerably more information than a composite net force. Which may explain Newton's choice of examples of impressed forces; viz. percussion, pressure and a centripetal force such as is gravity.

¹² The heel spike has been cropped in Fig. 6-18 step 3, in order to magnify the activity in the forefoot region.

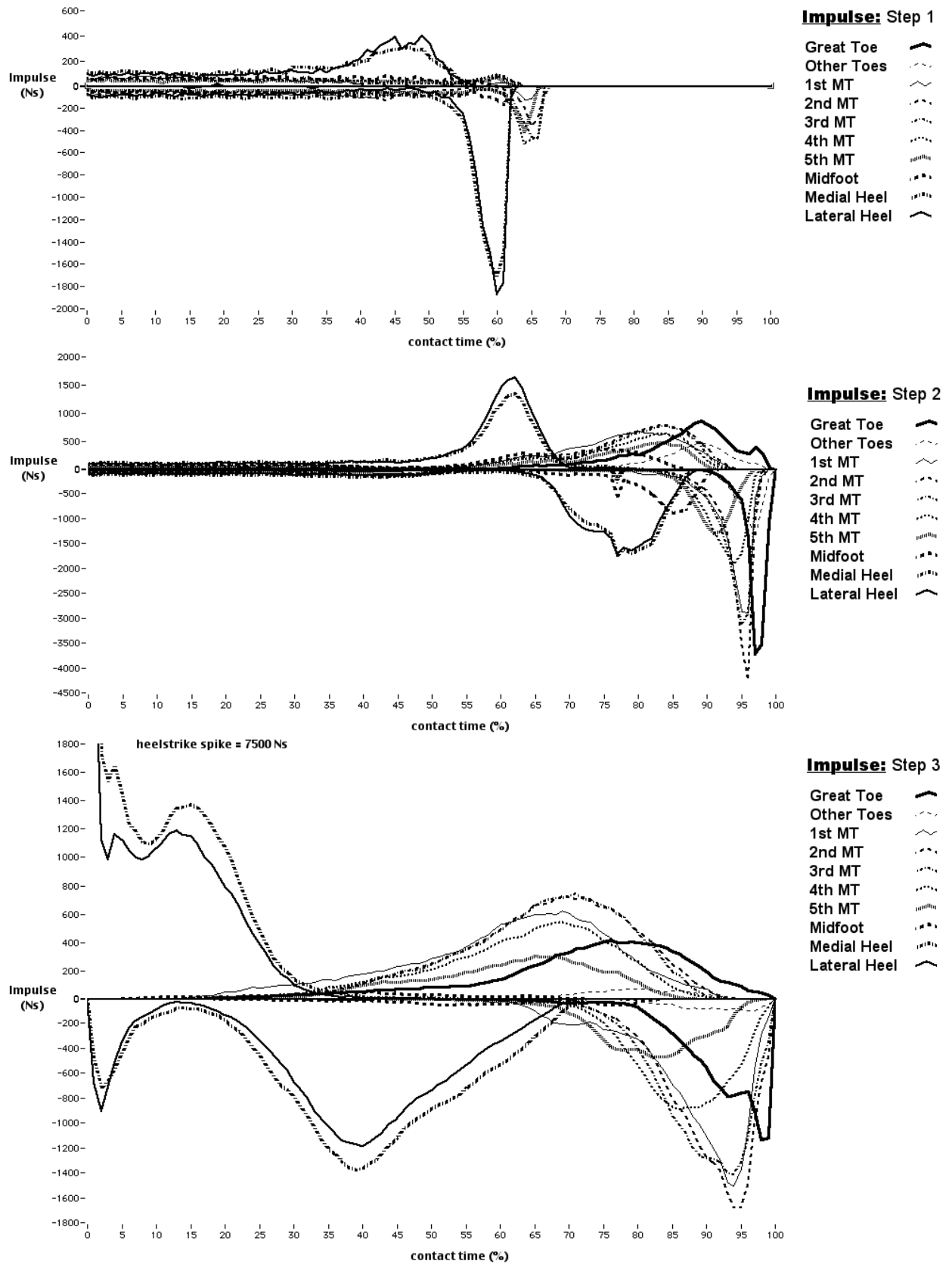

Fig. 6-16. Impulse distribution; mean of fifty-four subjects. Steps 1-3.

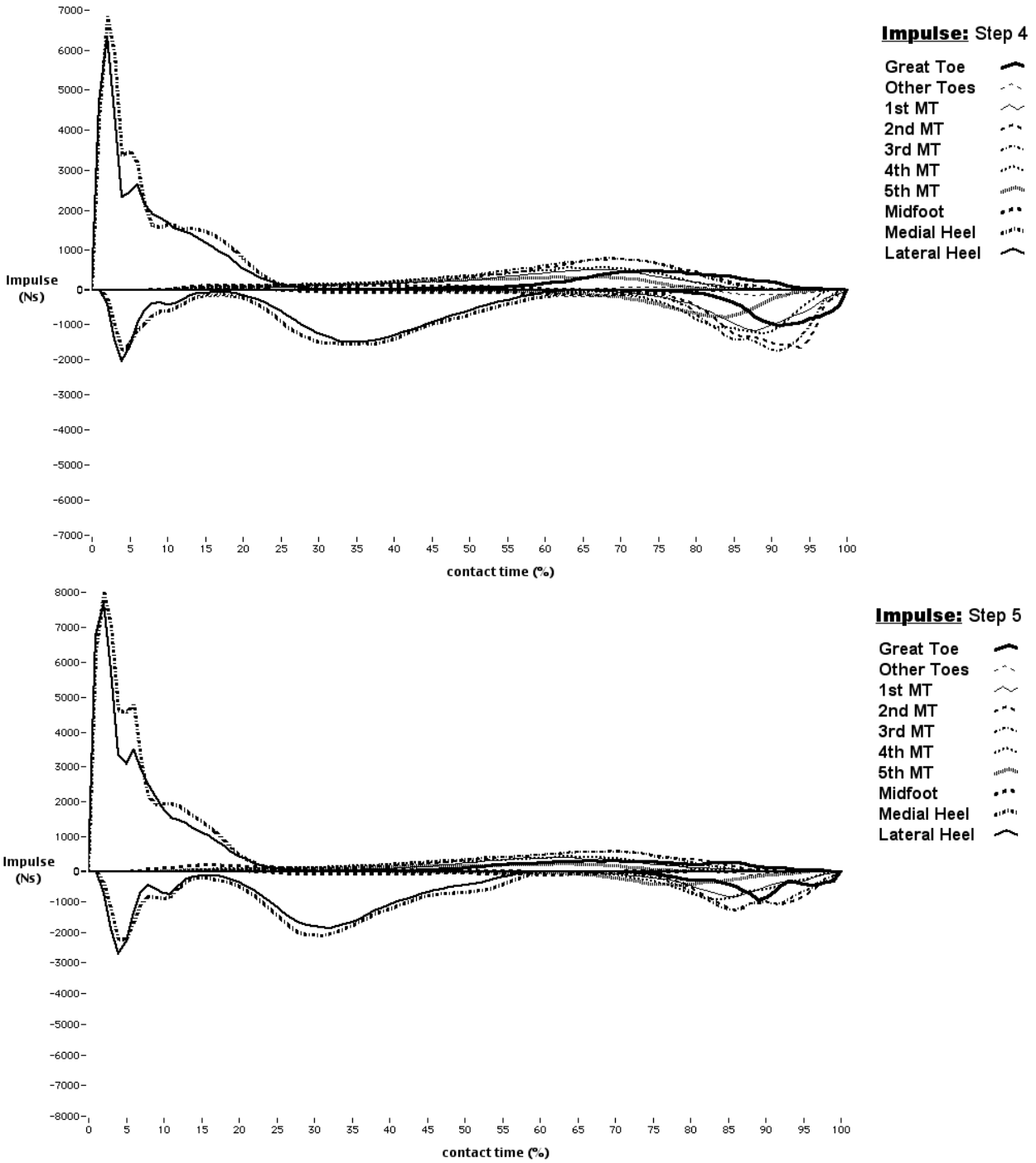

Fig. 6-17. Impulse distribution; mean of fifty-four subjects. Steps 4-5.

6.5.5 PRESSURE

The maximum and relative pressures for each region are presented in Figs. 6-18 and 6-19. These curves are closely aligned with the regional force curves. The irregularities in the median values compared to the mean reflect different foot types and walking strategies in the population.

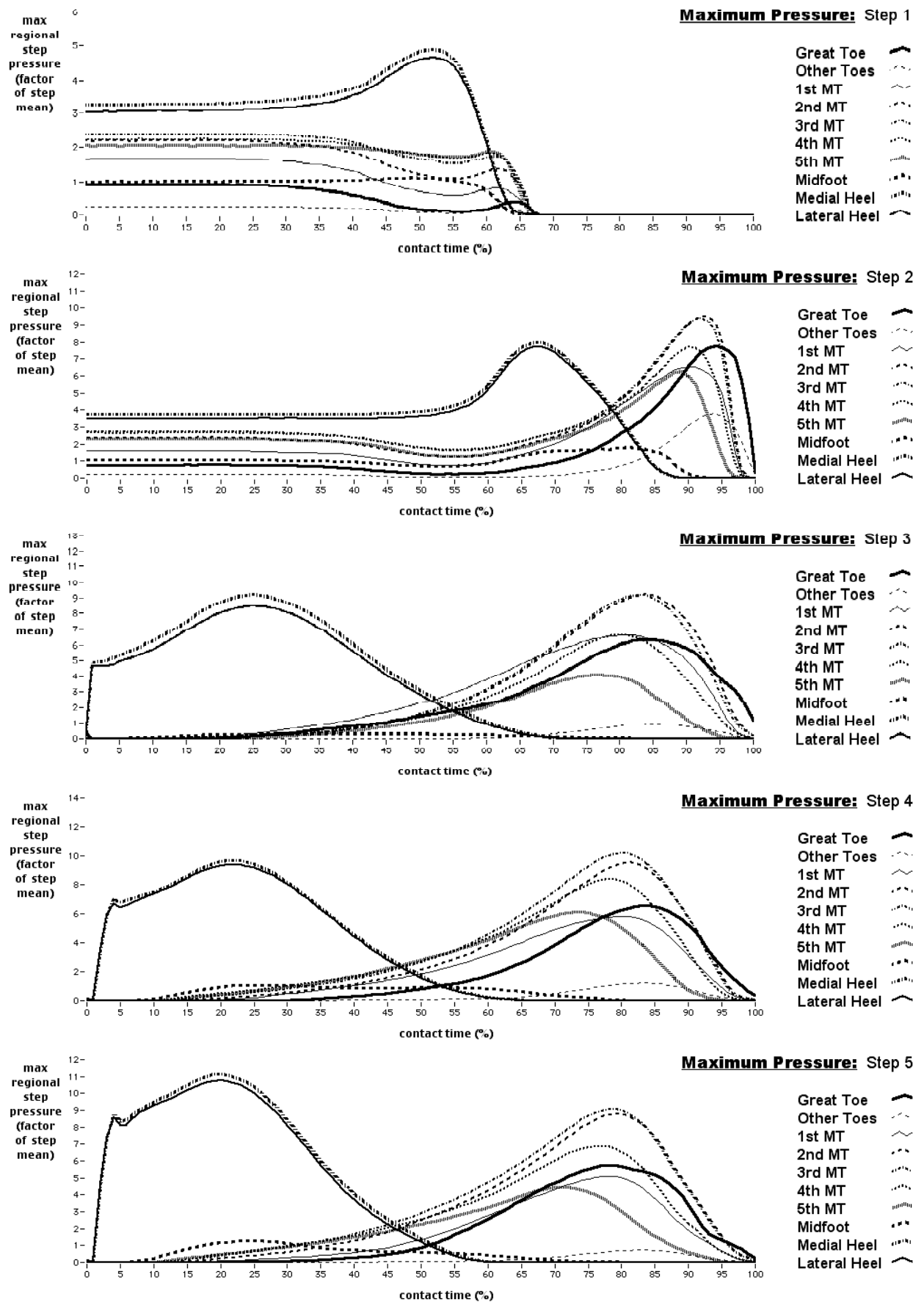

Fig. 6-18. Maximum pressure per region; mean of fifty-four subjects.

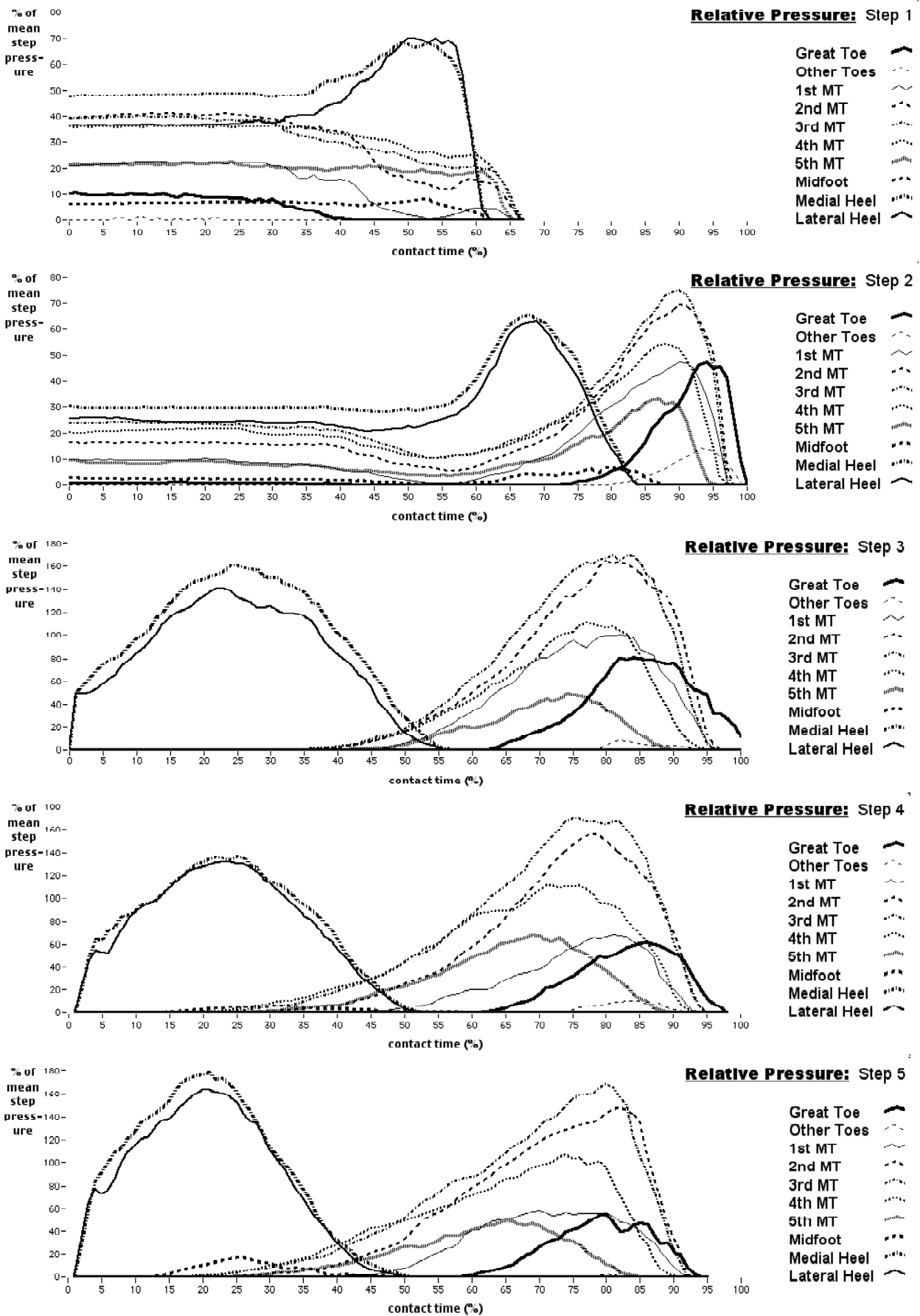

Fig. 6-19. Relative pressure per region. Median value as a percentage of mean step pressure in 54 subjects.

6.5.6 SHEAR

The data on shear stresses presents a unique challenge for the thesis. Galileo was the first to distinguish horizontal motion from vertical. Newton's first law defines forces as linear. Thus in classical mechanics a vertical force applied to the pressure plate has no horizontal components. Any horizontal component between the plate and ground causes the plate to shear (slip) along the ground. This is the form of shear force for example quantified by 3D force plates. However that is not the form of shear referred to here.

The shear stress calculations used here describe the *distortion* of the rectangular plate surface. The shear or shifting of the opposite plate edges relative to each other, *not* the movement of the plate relative to the ground. Because this description is novel, there is presently no indicator, either experimental or theoretical against which the shear stress resulting from the ground reaction torque can be verified.¹³

The problem of verification is compounded by the nature of the shear stress, which for example varies quite considerably in time, magnitude, angle and position within each frame, and between anatomical position within feet as well as between individuals. The results of the foot shear investigation are therefore restricted here to the regional maxima [Fig. 6-20].

Also it has proved difficult to find a suitable *summary parameter* for the shear stress, for example like the radius of gyration for the impulse. One potential parameter is the *shear center*. But this is often difficult to locate even in quite simple mechanisms. However it warrants further investigation because it is the position of zero torque.

A form of normalization is however achieved by noting that the shear calculations are based on the vertical forces on the sensors [Fig. 6-18]. Therefore the ratio of the maximum shear to the maximum normal sensor pressure was calculated for step 1 and 2 [Fig. 6-21].¹⁴

- ❖ The first observation is that the ratio is mostly constant between 0.10 and 0.14 depending on the anatomical region.¹⁵
- ❖ The second observation is that deviations that do occur are mostly confined in the anatomical regions of the lesser toes and also the great toe.

Thus when gait is initiated there is a demonstrable reduction in toe shear. In terms of the ground reaction torque model¹⁶ this justifies the toes, particularly the lesser toes, being treated as a free surface at the distal end of the ground reaction torque chain. This conclusion follows from the fact that there is no shear at a free surface of a free body, and thus the initial ground reaction torque is generated mostly within the first metatarsophalangeal joint as anticipated.

¹³ Verification of the thesis would require deliberate experiments with instrumented mechanical objects, such as sliding, spinning and rolling balls, the inanimate behavior of which could be compared to extrapolation of the pressure plate predictions.

¹⁴ Steps 3, 4 and 5 are omitted because they exhibit a bewildering array of averaged effects and mathematical discontinuities that are perhaps better analyzed in a case study format.

¹⁵ This may correspond to some form of anatomical poisson ratio.

¹⁶ Developed in Chapter 7.

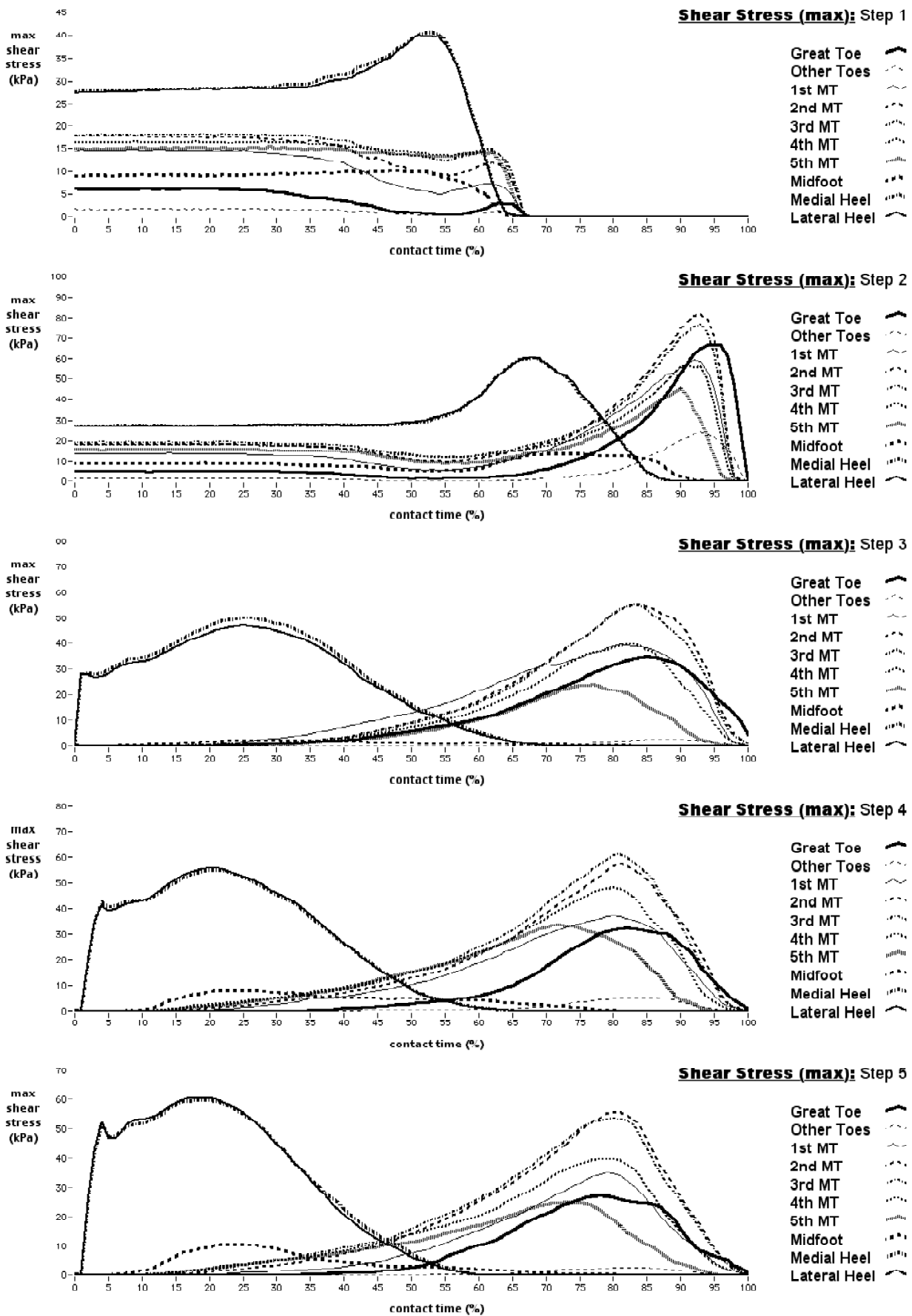

Fig. 6-20. Maximum shear in the horizontal foot sole regional maxima in fifty-four subjects.

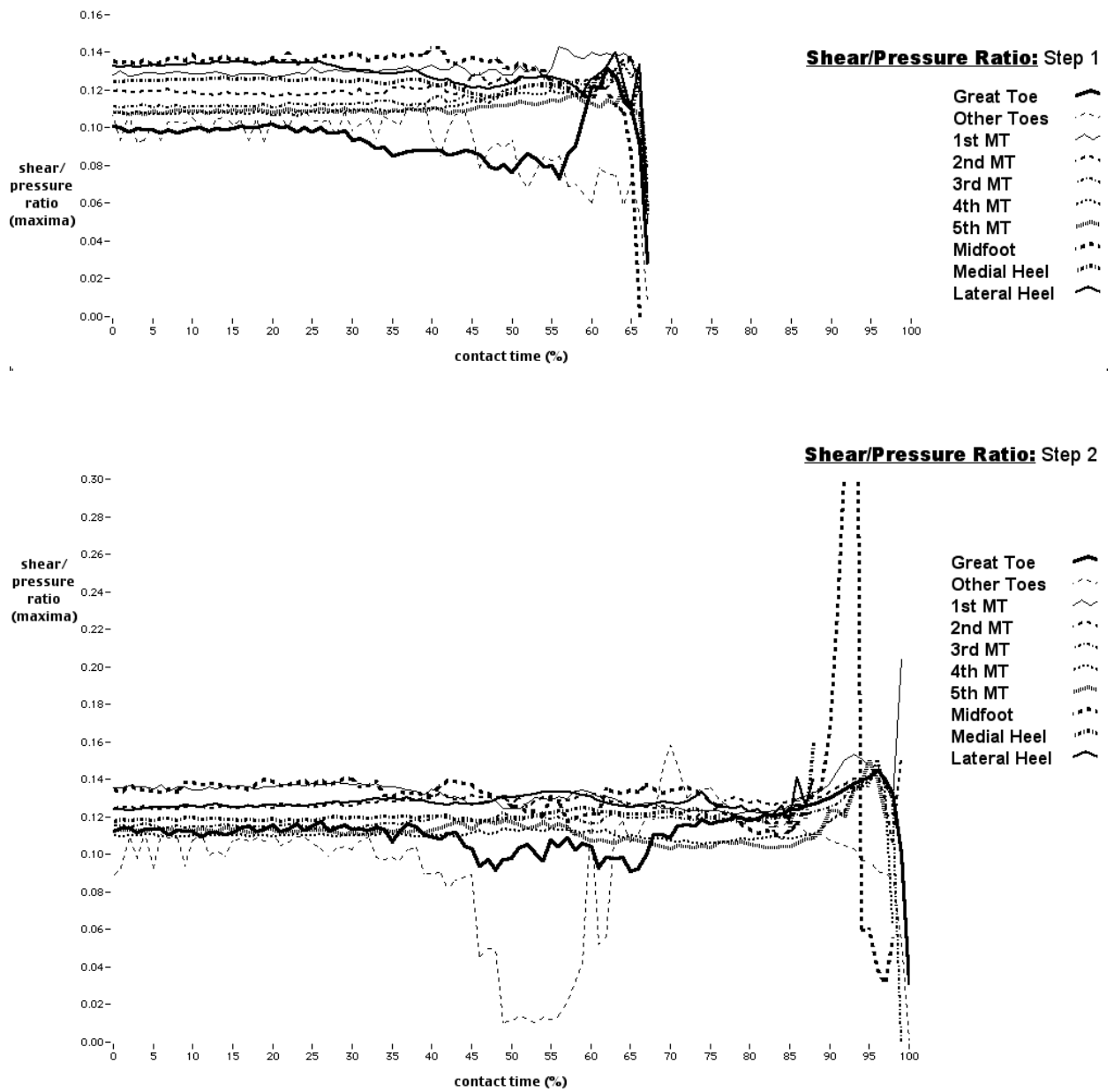

Fig. 6-21. Normalized ratio of maximum shear to maximum regional pressure during transition from posture to gait in fifty four subjects.

6.6 SUMMARY

A comprehensive empirical impression of the human bipedal body action force has been compiled by measuring the dynamic impulses in the ground reaction pressure during the initial stance posture and before the state of uniform motion is established.

The pressure first moves away from the toes and forefoot onto the heels. Pressure also increases on the lateral sides of the heel as both feet invert. Surprisingly when the forces under the stance foot are summed, the total force initially decreases. This indicates that gait is initially at least partly *powered passively* by gravity as anticipated.

During gait (Fig. 6-12, steps 3 to 5), the heel-strike transient is prominent on the lateral side. Indicating that the heel pronates and everts on landing, transferring the weight to the medial heel. As gait progresses, less time is spent on the heel for each step (65%, 60%, 55%). The distinguishing characteristic of the first step of gait (Fig. 6-12, step 3) is an increased force under the first metatarsal head (MT-1). The great toe is thus implicated in the initiation and control of gait and balance because the contra lateral medial pressure appears to correct the initial exaggerated sway onto the lateral heel during the initial movements.

More work on the dynamics of double-stance is indicated.

ACKNOWLEDGEMENTS

The experimental equipment for this chapter were donated by Jean-Pierre Wilssens director of RSscan INTERNATIONAL, who also supplied the hardware needed to gather and display the data. All the software needed for analysis of the data was designed and written by myself with technical assistance from Bart Jacobs, head of software development at RSscan INTERNATIONAL.

7. SYNTHESIS

*"The object of all science is to co-ordinate our experiences and bring them into a logical system."*¹

"That the meeting-point between Biology and Physical Science may at sometime be found, there is no reason for doubting. But we may confidently predict that if that meeting point is found, and one of the two sciences are swallowed up, that one will not be Biology." — JS Haldane²

7.1 INTRODUCTION

This synthesis serves to merge the biomechanical, anatomy, history, mathematics, empirical and dialectic points-of-view of the thesis with the aim of reincorporating the *macroscopic* qualities of *bipedalism* and *animism*.³ The resultant principles deduced from inanimate cadavers and animate subjects are used to reanimate the lifeless cadaver from the observed motions of the foot bones.

The biomechanical synthesis establishes the philosophical and empirical foundations for gait analysis from a standing start. Three empirical views of the forefoot free-body are combined within a common frame of reference including a cross-section of the metatarsal bones, a sagittal kinematic projected transformation of both an in vitro and intact inanimate cadaver toe, and pressure underneath the animate foot. All these views are linked through three new principles of *animate* motion—the *cam*, the *ground reaction torque*, and the *amputation artifact*.

The historical synthesis as it unfolds, assumes a distinctly Cartesian form; a philosophy that is based on an isolated cadaver model. The thesis starts with an *experimental* rendition of Aristotle's animate unmoved mover;⁴ a state of absolute rest that is incorporated here with the Galilean hypothesis of uniform motion. The living capacity is reconstituted from the neglected mathematical form of the *res cogitans* Cartesian system, which has to be recombined with the more familiar Cartesian *res extensa* physical coordinate system. The synthesis of the two Cartesian coordinate systems is believed to provide the necessary basis for self-movement. A capacity the Galilean uniform motion model of the antithesis fails to provide through the classic combination of two *res extensa* coordinate systems. This is important because the ultimate synthesis, according to Hegel, is that of the mind and thought.

Anatomically, the new thesis that the MTP-1 functions as a cam is reconciled with the old antithesis that the MTP-1 is the anterior buttress of an arch. The dynamic cam thesis, which is based on Aristotle's unmoved mover, is thus directly transformed into a description of its opposite,⁵ a static foot arch. The synthesis ends with a comparison between the bony arch and anatomical tie-ropes in the foot and the purely metaphysical constructions of an *arch of knowledge* and a *rope of knowledge*.

¹ Albert Einstein, *The meaning of relativity* (1951).

² Presidential address to the Physiological Section of the British Association, 1908. (See McDougall, 1911, p.190).

³ I follow the philosophy of McDougall (1911) here because he broadly defined *animism* as "those manifestations of life and mind which distinguish the living man from the corpse." I include this old definition of *animism* with the more modern term *animation* which then has the different meaning of recreating the appearance of motion from a gradually changing series of still picture projections.

⁴ Jammer (1957) notes that Aristotle's theory of the unmoved mover creates the problem of continuing motion. But it is Galileo's principle of uniform motion and inertia embodied in Newton's first law that creates the problem of initiating motion.

⁵ Transforming a thesis into its opposite so that it is preserved and fulfilled by it, is the objective of an Hegelian synthesis. See p.3.

7.2 FREE BODY THREE VIEWS

The free-body analysis is the single most important step in mechanics. Therefore it is sensible to coordinate the three views of the great toe region that have been developed in the thesis. The foot, particularly the forefoot free-body, is viewed from the three directions corresponding to the experiments of Chapters 4, 5 and 6. The main medial arch of the foot is divided in the middle into anterior and posterior buttresses by the plane of the metatarsal cross section [Fig. 7-1].

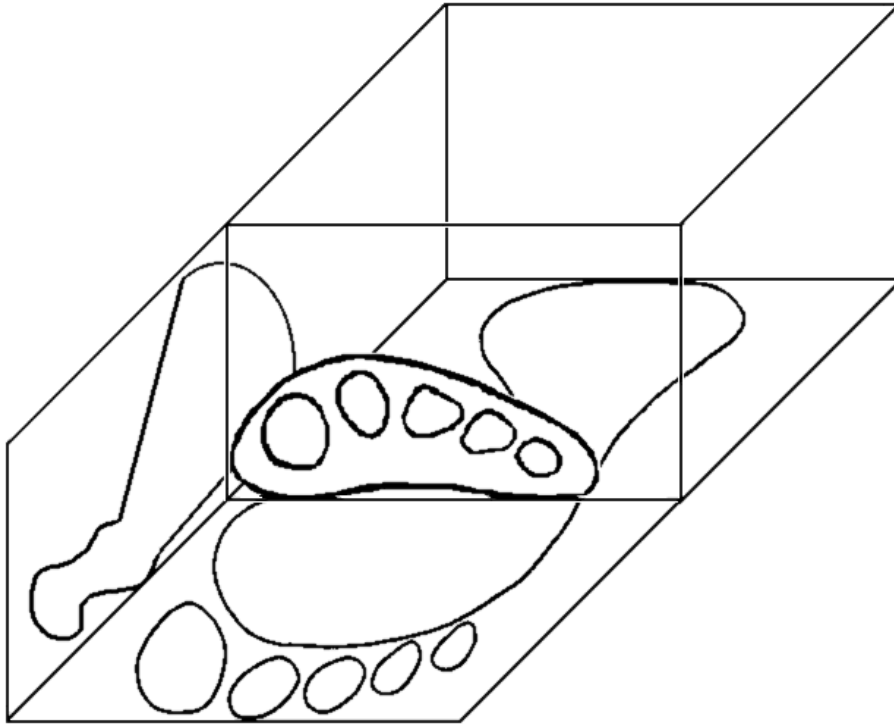

Fig. 7-1. Three views of the forefoot free-body, the forefoot buttresses of the arch.

The free body analysis requires that the chosen body be completely isolated. Therefore imagine for example the forefoot isolated inside a completely closed cardboard box. The contents of the box can be revealed by opening the box at any of its opposite ends, creating a sleeve consisting of 4 hinged side-panels [Fig. 7-2].

If the bottom panel underneath the foot is held flat and unmoving as required for an unmoved mover, the top panel is free to translate or shear in the constrained direction as in Figure 7-2. This model replicates the constraints of Newton's first law because one panel is fixed at rest and the other translating approximately uniformly. A linear interpolation between the two reference states describes the intermediate state of an impressed force.

The open ends of the imaginary cube Fig. 7-2 can be variously aligned with the page or base of support. So that the three main views through the box correspond to the original three views of the thesis determined from experiment. When the box has its:

- (a) sides open, one can imagine that the shear distortion produces a cam (Chapter 4).
- (b) front open, one can imagine the metatarsal cross-sections in shear and torsion (Chapter 5).
- (c) top open,⁶ one can imagine a horizontal shear in the pressure plate (Chapter 6).

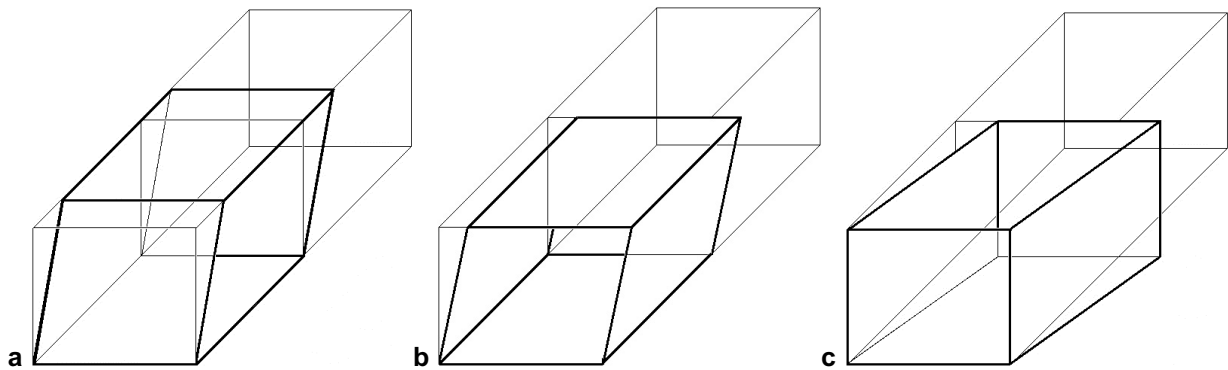

Fig. 7-2. Three modes of shear in the boundaries of forefoot first metatarsophalangeal joint free body.

The *animate* forefoot cubes above all describe a *physical* state that is constrained between a state of rest (fixed panel) and uniform motion (opposite translating panel). In terms of Newton's third law this intermediate state is defined as an impressed force. Thus the real components of the three empirical views describing the contents of the box above characterize the forefoot component of the *bipedal body action force*.

The method of firstly including then secondly removing all the fixed and translating side-panels of the imaginary frames of reference above corresponds with the primary isolation of the physical free body. Ultimately however the hypothetical box can be discarded altogether. Leaving only the *imaginary* side panels and the *physical* artifacts of the frame translation that can be linked to the anatomical subject through a combination of the mechanisms above.

⁶ The configuration in Fig. 7-2c differs from Figs. 7-2a and 7-2b in that there is no gravity component involved with the shear in Fig 7-2c.

7.3 MECHANISMS OF CONTROL

Control of gait is readily supposed to occur through the neural system. However in accordance with the functional anatomy of the great toe, the thesis is not concerned with the neural mechanisms of control and structural hierarchies of commands. It is concerned with the mechanics of movement of the body segments about the original osseo-ligamentous hinge joint center, through the basic principles of cam action, torsion and the timely separation of parts⁷ under the influence of free will.

7.3.1 SHEAR, TORQUE AND CONTROL

The conversion of simple shearing translation into a nominal state of rotation and vice versa accords well with a hypothetical yet basic mechanism identified by James Clerk Maxwell⁸ whereby an animate body could be controlled by a suitably immaterial mind without doing any physical work [Fig. 7-3]. A mechanism of rotary control is essential if an imaginary system such as the imaginary *res cogitans* animate mind is to exercise physical control over an absolute real body.⁹ Aristotle himself incidentally defined the anima or soul as the principle that connects the body parts and prevents them flying apart.¹⁰

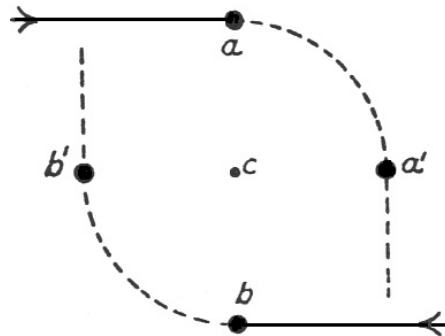

Fig. 7-3. Maxwell's suggested method of exercising 'animate' control over physical body without doing mechanical work (McDougall, 1911). Shearing points **a** and **b** are temporarily linked at a fixed distance **acb** and rotated about the center **c** to positions **a'** and **b'**.

7.3.2 TOE TORSION

The principle premise is that the origin of motion is vested in the distal structures of the great toe, not proximally in the muscles, heart or the brain. The thesis thus follows in one sense Aristotle, but not entirely. If the distal forefoot is fixed unmoved to the ground, then the metatarsals must distort when the ground reaction torque is applied. In reality, any distortion in one plane is accompanied by distortions in all 3D planes [Fig. 7-4].

The shear calculations on the pressure plates at the very start of gait [Fig. 6-21, step 2] have revealed that there is significantly less shear stress under the lesser toes than other anatomical locations. This is an important result because the shear on the surface of a free-body is zero. The conversion to torsion therefore must occur partly in the first metatarsophalangeal joint.

⁷ The untimely separation of parts gives rise to the amputation artifact.

⁸ Maxwell model of animate control is presented here because it was he who formulated the complex equations of electro-magnetic phenomena that essentially triggered the demise of the theory of aether.

⁹ Other ways identified by the thesis are through the product of two or four orthogonal animate imaginary Cartesian *res cogitans* coordinates as described in Chapter 3, and of course the instrument of Aristotle's animated hinge (*de Anima III.10*).

¹⁰ *de Anima II.4*, 415b.

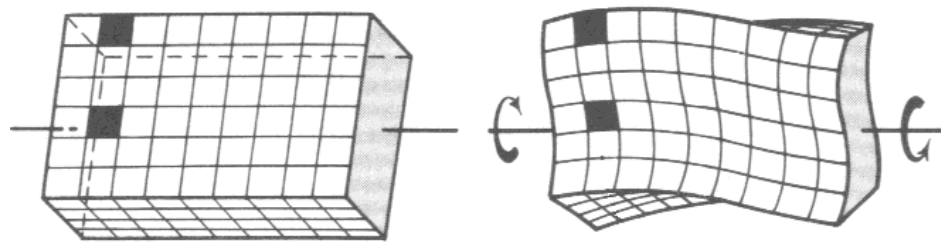

Fig. 7-4. Triplanar strains in a control frame; the inevitable three-dimensional twist associated with simple plane torsion about one axis.

The passive dorsiflexion of the toe that is fundamental to the cam description can however only occur when *the heel is raised* and the foot is bearing weight. At this time the metatarsal cross-section is the only stiff connection between the ground and the remainder of the body, and hence these bones carry the bulk of the torque. Especially when a person sprints at maximum speed.

7.3.3 METATARSAL SHEAR AND GROUND REACTION TORQUE

Shear is defined as the parallel translation of two planes. Shear occurs when for example the opposite sides of the hypothetical box that amputates the metatarsals are subjected to torsion [Figs. 7-2 to 7-5]. Shear *stress* quantifies the ability of the material to *resist* the shearing strain or movement. But as can be seen in Fig. 7-5, if there is no perpendicular resistance to horizontal shear, then the body simply rotates instead of shearing. The relationships between free rotation, shear strain and the ground reaction torque are best summarized pictorially below. Note that only the one edge line of this box section is displayed in the appropriate two-dimensional figures.

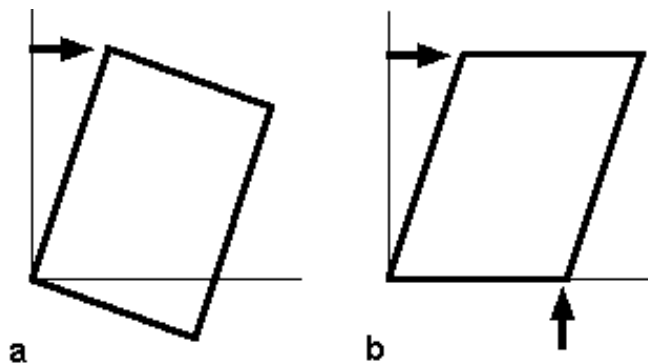

Fig. 7-5. The basic relationship between (a) Archimedian rotation, (b) shear strain and the ground reaction torque.

Incidentally if the displaced rotating body remains orthogonal; i.e. the body does not shear, it can be deduced that there is then no material *ground* resistance to the rotation. It is this form of unrestrained rotation that characterizes the free-floating Archimedian cadaver. Therefore the ground reaction torque can be conclusively related to the amount of strain energy in the distorted metatarsals when the heel is raised during gait.

Also if the box in Fig. 7-5a remains rigid, then the horizontal arrow reflects the strain required to keep the box attached to the reference frame. The resultant *external* stress is essentially the function assigned to the helmsman in the classic Galilean cadaver model.

7.4 FUNCTIONAL ANATOMY

7.4.1 CAM AND ARCH

The arch is a traditional model of foot function. The cam model is coincidentally irrevocably fixed to the ground, and hence it can be used to replace the forefoot buttress of the arch. The cam MTP-1 model is also a *single* solid unit synthesized from the animate behavior of two articulating bones. The cam can therefore be used for example to replace Inman's beam model of the first ray [Fig. 7-6].

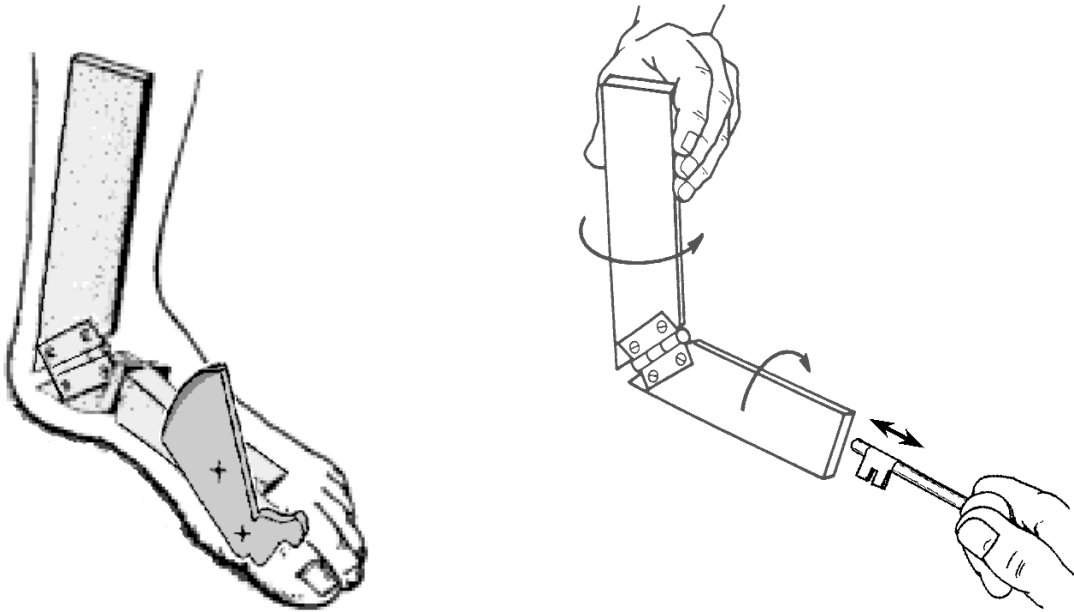

Fig. 7-6. Cam replaces metatarsal arched beam. **Fig. 7-7.** Metatarsal cam and key-bone action. Insert, twist, lock.

The connection between the great toe cam and the rest of the foot appears to be a *cam* and *twist* action via the ground reaction torque. The postulated rotation indicated in Figure 7-7 is in fact due to the GRT that twists the entire MTP-1 complex. To use a metaphor, the first metatarsal is the *key bone* in the foot not the *keystone* in an arch.

The key bone in the picture is twisted here by an external hand.¹¹ Actually the external clamping grip on the metatarsal key bone—the thumb and opposing fingers—are replaced in the anatomical foot primarily by the sesamoid bones in the ligamentous MTP-1 capsule that grip either side of the sub-capital ridge of the first metatarsal bone. The rotation is assisted by the powerful diagonal insertion of the Peroneus Longus muscle. The various muscles, plantar aponeurosis and passive weight bearing parts are all aligned to pull and push the distal metatarsal key bone proximally into the foot. None of the attachments distract the joint.

The two hands in the figure represent an independent external clamping system. The hands here form a closed loop G-clamp system (**E'**) of the antithesis that includes all elements of the body. This is a full-scale homunculus that includes all and only all the anatomical components of the neuro-musculo-skeletal system attached to the great toe.

¹¹ The opposable grip is really another form of the E' G-clamp constraint of Chapter 4.

7.4.2 BIPEDAL LOCOMOTOR FRAMEWORK

The KPT experimental framework used to constrain one metatarsal bone might be generalized to mimic a rudimentary bipedal skeleton. The passive moments originally applied through the reaction feet **D** of the *laboratory apparatus*, can be rotated hypothetically to beneath the animate foot as in Fig. 7-8.¹² To recreate the complete bipedal body from the single cadaver foot, a second foot is added to the framework [Fig. 7-9].

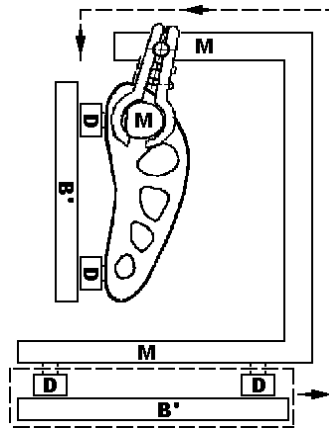

Fig. 7-8. Modeling plantar pressure support using the kinematic projected transformation experimental frame.

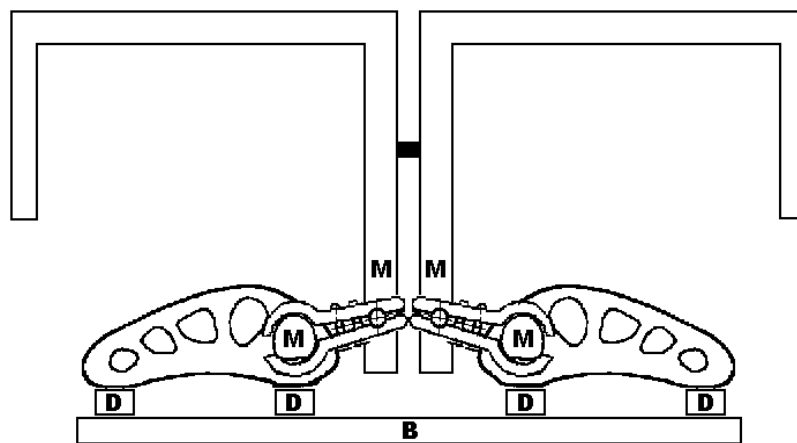

Fig. 7-9. The KPT metatarsal frame transformed into a rudimentary bipedal skeletal locomotor framework with an external 'black box' torque coupling.

The two feet can in theory be joined at any suitable anatomical point on the skeleton such as the ankle, knee, pelvis or even spine.¹³ The crucial junction, represented by a small "black box" in Fig. 7-9, is formed from the imaginary dimension/artifact of each foot framework.¹⁴ This connection between two imaginary dimensions, one each from the left and right side of the body, is crucial to the bipedal body form. It is a physical modality that is perhaps as important to bipedalism as the bi-minded junction is to the Galilean invariance of the antithesis.

¹² The moments applied by living human feet in this model are in fact those applied to the pressure plates in Chapter 6.

¹³ See Gracovetsky (1985).

¹⁴ An imaginary dimension would in fact appear as a physical artifact only if combined with another similar imaginary dimension, in this case from the other foot.

7.4.3 CAM AND CRUCIATE STRUCTURES

Bipedal symmetry is necessary to conserve the angular momentum of the body and prevent it rotating like a top in one direction only. Consequently the basic elements transmitting torque must cross over each in the skeleton. Which requires at least one cruciate tension-coupling in the ankle, hip and/or knee specifically to enable the supination of the first metatarsal ground reaction torque of one foot to communicate with the pronation of the metatarsal in the other foot. This coupling occurs at the site of the black box in Fig. 7-9.

The biomechanics of this torque switching can be illustrated with the aid of four pencil shafts placed end-on-end in two pairs. Torsion-pairs can be defined either as a pair in series or parallel [Fig. 7-10]. Torsion tension or torsion strain—the basic energy storing property of a ground reaction torque—is induced by applying a counter-rotation in any pair of adjacent rods as shown.

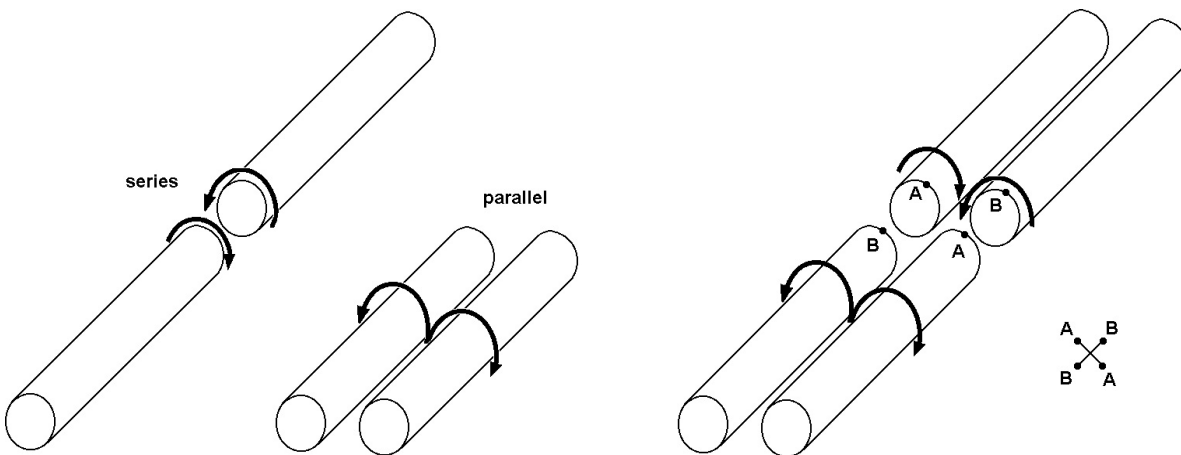

Fig. 7-10. Torque linkages (a) series, (b) parallel.

Fig. 7-11. Connections that enable counter rotations in four-rod torsion linkage such as occurs in the knee.

To optimize the control, serial and parallel counter rotation must exist simultaneously in the anatomical joint system [Fig. 7-11]. The spatial integrity of this basic four-linkage joint is optimized by tying the counter-rotating elements diagonally across the joint because these points tend to rotate in the same direction. The resulting structure is immediately recognizable as the cruciate ligament formation of the knee.

This is a remarkable observation, because the principles of torque and cam action that were deduced from the actions of the toe successfully anticipate the anatomical structure of the knee.

The knee itself consists of two cam-shaped femoral condyles. The upward supination through the first toe and downward pronation induced through off-centered talus weight bearing are both transmitted through the knee cam anatomy. The shape of the toe cam of the one foot is in series with the knee cam of the other leg [Fig. 7-12]. Therefore the action of the great toe appears to operate in synergy with the cam of the opposite knee.

The fused knee cam condyles however cannot counter-rotate axially as postulated in Figure 7-10. Therefore the *other femur* becomes the parallel element above the knee joint, with the hip girdle

acting as the lever arm for the GRT.¹⁵ The femoral necks act as epicycles on the pelvis deferent.¹⁶ These epicycles introduce additional cam action that is driven by the powerful muscles at the hip.

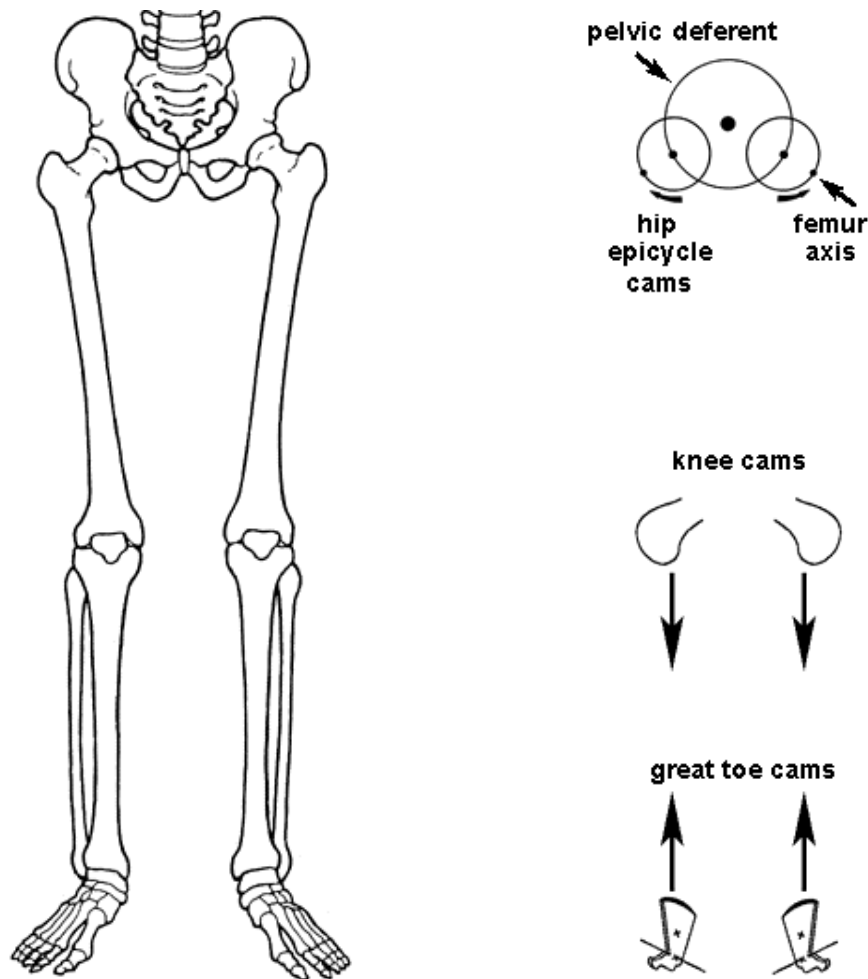

Fig. 7-12. Toe, knee and hip cams linked in series.

7.4.4 AMPUTATION AND THE CAM

Further investigation of the *cam and cruciate* structures above the knee takes us beyond the scope of the MTP-1 thesis. This brief discussion serves to emphasize that the animate principle of cam and torque action is not necessarily confined to either the proximal or distal segment of the foot, contrary to what both Aristotle and Descartes might have supposed about the animation principle.

For example the third principle of animate motion is the amputation artifact. In terms of gait, the amputation of a single foot or even knee does not destroy the gait pattern (Saunders et al., 1953). This is logical, given the postulated communication of the opposite toe and knee cams [Fig. 7-11]. The basic animate capacity of cam and cruciate interaction survives in principle in the other leg and various joints even if one or both feet are amputated.

The importance of a single proximal origin of motion in this case is nullified.¹⁷ Calling into question the whole philosophy of a single unified *animation* principle or hierarchy structure of gait control.

¹⁵ The relatively larger lever arm for the female pelvis would for example lead to a higher incidence of knee injuries in female athletes and would also account for differences in gait transition speeds (Hreljac 1993).

¹⁶ Epicycles and deferent's, i.e. circles on circles, formed the basis of Ptolemaic system of the planets, predecessors of Kepler's laws that replaced the anima.

7.5 CADAVER ANIMATION

7.5.1 CADAVER MODELS

Instead of performing experiments on generic cadavers, it is possible to categorize the cadavers according to their dispositions within a specific laboratory frame of reference. For example:

- (a) The *Galilean* cadaver [Fig. 7-13] represents the archetypal scientific model. It is for all we know resting completely isolated in an enclosed laboratory **L** in the cabin aboard a large ship on a dissection bench **B** in uniform motion afloat on sea of water or ideal aether **D**. The cadaver in the cabin is observed by a group of Galileo's friends, all enclosed with in the same inertial frame **L**.
- (b) The *Archimedian* cadaver [Fig. 7-14] floats directly in a tub of water, the ideal compliant supporting medium **D**, without any intervening surface **B** or enclosed laboratory **L**. The Archimedian cadaver can thus in fact substitute for the entire Galilean ship, including the helmsman and internal mechanics. The Archimedian cadaver was originally employed to counteract the ground reaction torque. But this description is extended hereto describe the fixed hinge attachment to a mechanical mobile platform such as a ship's deck or a train's floor.
- (c) The *Cartesian* cadaver [Fig. 7-15] is modeled on Descartes philosophizing while lying on his bed as was his habit. In a thought experiment or *meditation* he envisages a complete body¹⁸ free of attachments whose animate capacity is either destroyed entirely, or not destroyed at all by amputation.¹⁹ In *Meditation 2* Descartes then began to doubt that he had any body at all.²⁰ From his *Rules* and *Method* we learn that the Cartesian mind consists of an imaginary indivisible *res cogitans* substance and the body is the real infinitely divisible *res extensa* substance. The different substances are joined together by Descartes' underlying principles.

7.5.2 CONSTRAINED BODY DIAGRAMS

The second important characteristic of the *Archimedian* cadaver emerges from Descartes seeking a secure foundation for his philosophy:

“Archimedes, in order that he might draw the terrestrial globe out of its place, and transport it elsewhere demanded only that one point should be fixed and mobile.” Continuing, “I shall have the right to conceive high hopes²¹ if I am happy enough to discover one thing only which is certain and indubitable.”

The one fixed and movable point is in essence either the fulcrum for a lever, or the housing for an axle, hinge or wheel of the hypothetical train, the modern substitute for Galileo's ship. This single joint center can be either fixed to the earth or body. Fixed to the earth, it transforms into a lever capable of raising the body. But if *constrained to the moving body* it becomes capable of moving the earth. Except it will break during the attempt—as is the clinical experience.

¹⁷ The hypothesis of a single united anima was defended indirectly by Newton in the conclusion of the *Opticks*, where he is free in terms of his own mathematical philosophy to discuss "non-mechanical" hypothesis.

¹⁸ “In the first place, then, I considered myself as having a face, hands, arms, and all the systems of members composed of bones and flesh as seen in the corpse which I designated by the name body.” *Meditation 1*.

¹⁹ “We could not in any way conceive of the half or third of the soul,...because it does not become smaller owing to the cutting off of some portion of the body, but separates itself entirely when the union of its assembled organs is dissolved.” *Passions of the Soul, Article 30*. This indivisibility is similar to the free-body criterion of Aquinas' soul.

²⁰ At least he thought “it was as though I had all of a sudden fallen into very deep water, I am so disconcerted that I can neither make certain of setting my feet on the bottom, nor can I swim and so support myself on the surface.” His eventual foothold came with the realization, “I think therefore I am” of Principle 6.

²¹ Notice the elevated status attributed the active reason.

Irrespective of whether it is an Archimedian fulcrum mounting a wheel, or the Newtonian sea²² that supports the translating Galilean laboratory deck, some form of stabilizing deck is nevertheless essential for gait. Human's cannot stand upright on water, and cannot balance on a floating platform with a small resistance arm. The inference is that in order to produce a viable torque to enable gait, one also needs an adequate stable *lever arm* for the *ground reaction force* resistance.

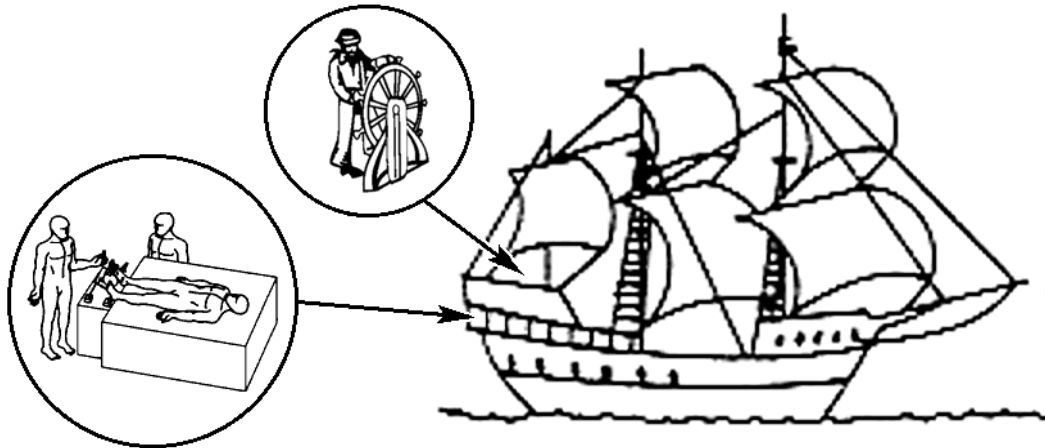

Fig. 7-13. Galilean Cadaver. A closely observed body, controlled by a helmsman and propelled by external forces.

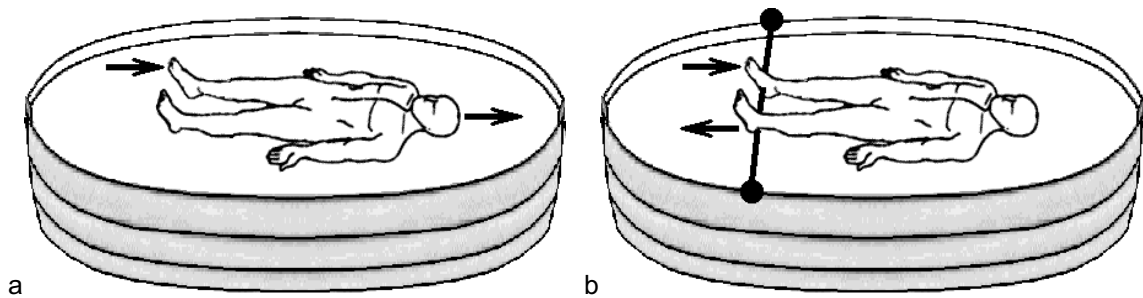

Fig. 7-14. Archimedian Cadaver (a) free-floating free-body; (b) fixed-hinged constrained-body type.

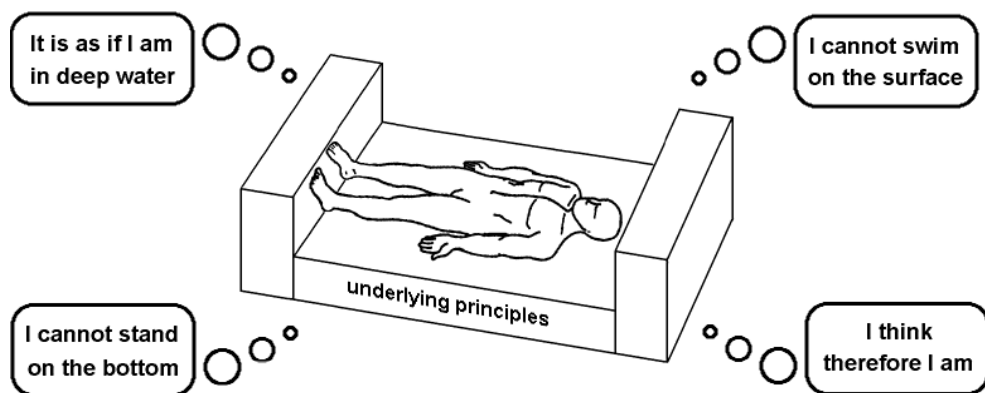

Fig. 7-15. Cartesian Cadaver isolated in a thought experiment or meditation, founded on the underlying principle of methodological scientific doubt and secured by the cognition of primary self-certainty (I think therefore I am).

²² The motions of the sea, unlike animate motion, is one of the explicit subjects of Newton's *Principia*.

7.5.3 CADAVER SELF-PROPULSION

The floating Archimedian cadaver description was introduced to avoid the excessive metatarsal forces by buoying the original cadavers on either a cushion of air, aether or water instead of on a rigid bench. But in terms of propulsion, there would then be nothing for the Archimedian cadaver to push on, and hence as Aristotle pointed out—*self movement* would not *start*.

The naked Archimedian cadaver however is in principle similar to the wooden Galilean ship. The Archimedian and Galilean cadavers differ because external pressure acting under the foot would propel the *free floating* Archimedian cadaver horizontally. Whereas the Galilean cadaver inside the floating cabin is in fact the animate model rejected by Aristotle when he describes the impossibility of moving the ship by pushing on its mast from inside the ship.²³ This means that an homunculus inside the Galilean ship alone cannot ever animate the body, necessitating an external control modality.

Galileo evades this fundamental problem by simply issuing the instruction to "have the ship proceed at any speed you like", with the unhelpful proviso, "as long as it is uniform". This simply defers the problem of initiating motion and places an intolerable burden on the animate helmsman locked alone *outside* who has to implement Galileo's instructions from within.²⁴ Leading to a proprioceptive feedback problem.

But any *horizontal* propulsion is anyway temporary because the propelling device beneath the foot and the propelled body must eventually separate if there is to be any relative propulsion. The cam model incorporates this separation in a formal manner but constrains it to the distance between the cam axes.

Separation or amputation is not a characteristic of the Galilean cadaver. I suspect that the amputation artifact appears in the Galilean model at the level of the constraining unitary *res cogitans* environment—the cabin-walls of the Galilean ship where the only authorized scientific access to the outside observation is through the sealed portholes, or the permeating flux of the gravity vector.²⁵ The physics that we are encouraged to ignore in the derivation of the Galilean-Newtonian model are the accelerations of the intermediate frame of reference²⁶—precisely those accelerations needed to start and control gait.

Essentially the amputation artifact in the Galilean ship is the intellectual isolation of the internal observers from external body-environment accelerations. The cabin "porthole" may serve as a simile for the round transparent disk of the kinematic projected transformation. The closed Galilean "portholes" are a simile for an opaque KPT disk. Basically this Galilean mode of observation encourages a fundamental ignorance of the relative accelerations that Meriam (1980) advised were essential for a proper understanding of the effects of moments. On the contrary, using a transparent KPT disk, is similar to opening the Galilean porthole and observing the relative accelerations of the frame of support. Which hypothetically appears as a cam motion relative to the fixed ground horizon outside [Fig. 7-16b].²⁷

²³ *Movement and progression of animals.*

²⁴ Galileo's helmsman is arguably the mechanical equivalent of the scholastics cherubs, a scholastic invention introduced to advert the logical-moral problem of Aristotle's Prime Mover that converted a moral God, the hierarchical pinnacle of reason and originator of all motions, into a slave who had to perpetually rotate the heavens and earth about their axes.

²⁵ In an anatomical analogy, the cabin of the Galilean ship with its intellectual contents is essentially the anatomical skull with its neural contents—the neuromuscular antithesis. The brain and central nervous system float in cerebrospinal fluid. The Galilean portholes correspond almost directly to the synaptic junctions at the level of spinal column where they exit the bony enclosure.

²⁶ The intermediate frame of reference is the "laboratory reference frame" *L*, which consists of the cabin walls of the ship.

²⁷ Because this KPT porthole or transparent disk is flush with the outside world, there is no difference in position of the centers of rotation and the parallel rays of the observation. A similar physical light transformation is performed by the human eye in the Cartesian control model [Fig. 3-4] and by Galileo's telescope. The KPT therefore minimizes the capacity of the observer to influence events because the optical separation is zero. This means that there is no lever arm in the *optical* separation between the crucial parts that can become confused with the Galilean pedestal height; i.e. the distance between bone shaft to the external point of view, the kinematic plane *A₁*.

7.5.4 INCORPORATING MIND

The Cartesian cadaver is rotated upright at the KPT cam-hinge axis. At the level of his feet we find Descartes' physical understanding of the world. At the level of his mind we have his intellectual understanding.²⁸ The extended mathematics of which form the two buttresses of Descartes' philosophy [Fig. 7-16a]. The cadaver synthesis unifies the Cartesian cadaver body (*res extensa*) and mind (*res cogitans*) with his underlying rules and mathematical principles.²⁹ It is postulated that Descartes' underlying principles create essentially a *cogitans* form of the G-clamp configuration **E'** [Fig. 7-16c] that can substitute for the *physical* constraint of classic Galilean amputated specimens.

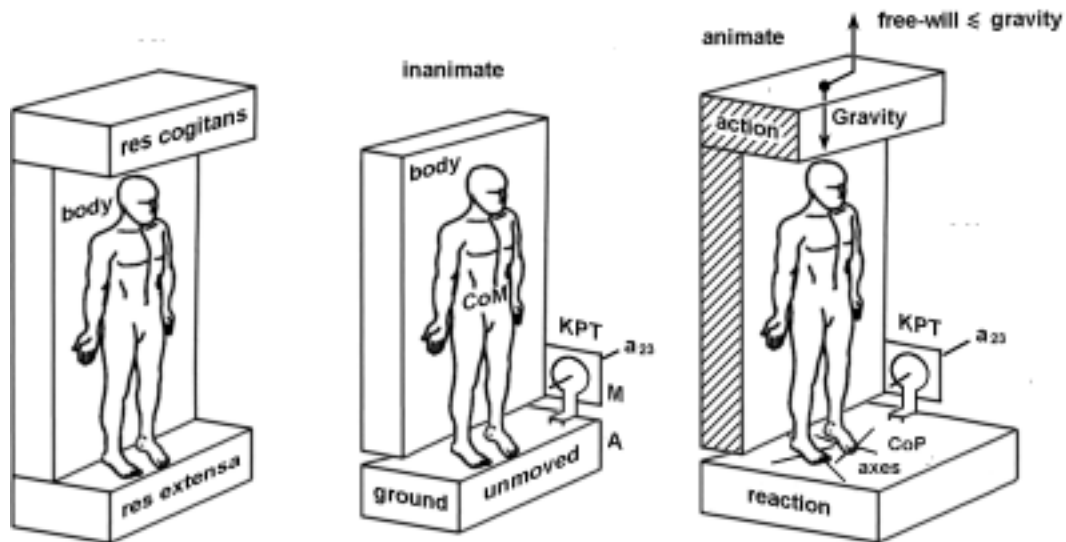

Fig. 7-16. Mechanical constraints acting on the Cartesian cadaver. (a) Cartesian G-clamp; (b) Aristotle's body animation hinge-instrument; (c) control via free-will, gravity, torque and cam interaction.

During unconstrained gait there is no physical clamp to hold the bipedal body, which is indeed the case with the Cartesian model above. The body must therefore contend be supported by the available *real* forms of the *Cartesian res cogitans* vector, which can be reconstructed from:

- (1) The vertical conjunction of two areas [Fig. 7-16b]. One attached to the proximal anatomy and the other to the earth. Each area is an unmoved part. The proximal part is the unmoved inertial frame of the cadaver torso clamped to the metatarsal **M**. The distal kinematic frame **A** of the phalanx³⁰ is unmoved by definition of laboratory coordinates. The two areas are linked by a transverse cam "joint axis" **a₂₃**, the mechanics of which are described in detail in Section 4.5 *re-animation of cadavers*.
- (2) The horizontal conjunction with the ground [Fig. 7-16c]. The compression of the cam and twisting of the GRT is modeled as the bending in the external real components of the imaginary Cartesian clamp **E'** that links the proximal 4D *res cogitans* and distal 4D *res extensa*. The bending moment in the clamp is quantified here through the 4D second moment of area impulse on the pressure plate, using the hypothesis of a static leg beam [Fig. 6-2, page 83] and a free-will moderated torque.
- (3) The center of pressure axes below the body are aligned with the real component of the *res cogitans* vector of the Cartesian individual produced by the Cartesian Free-Will gravity alignment with the centripetal force model of gravity-inertia identified in Chapter 3 [Fig. 7-16c]. The free-will vector can be varied in magnitude (impulse cam effect) and direction but mostly position (GRT lever arm).

²⁸ Aristotle, it is recalled, distinguished two activities of the soul, mental understanding and physical progression. (Section 2.1.1).

²⁹ The antithesis relies exclusively on Newton's mathematical principles to define the problem of initiating gait.

³⁰ The frame of the Aristotelian animate instrument that joins the body and the mind (de Anima III.10).

7.6 MATHEMATICAL ANIMATION

7.6.1 AN ANIMATED MODEL OF THE FOOT PRINT

Newton proposed that an impressed force materializes from *percussion*, *pressure* and a *centripetal force* such as is gravity. Pressure differs from centripetal force by including an area component. Percussion can likewise be quantified in terms of *impulse*. The impulse, which exists between two frames of area data separated by a time interval, is determined by subtracting two frames of force data at discrete times. Thus the impulse parameter has a negative and positive side, which can therefore be modeled as a physical body compressed between two real enclosing areas.

Animating the footprint frames in a cinematic manner at 50hz for example produces a series of mathematical pictures of the force impressed results in a *mathematical animation* of the Newtonian bipedal body action force about the center of pressure [Fig. 7-17]. An example of a full animation sequence for one subject is included in Appendix B.

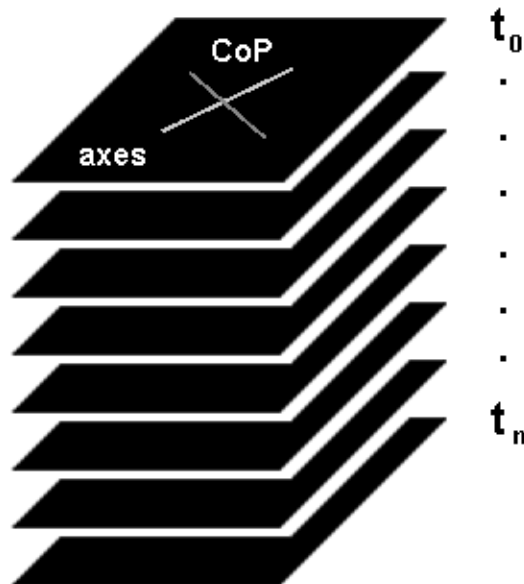

Fig. 7-17. Mathematical animation of the bipedal human body action force axes using a center of pressure model.

Pressure plate data reveals that the radius of gyration of the applied load (positive impulse) is differently distributed to the lifting load (negative impulse).³¹ This is remarkable because it follows from the definition of these phenomena that the applied load is in exactly in the same location in absolute space and is of the same magnitude as the lifted load. The foot does not roll or bounce passively like an inanimate ball. The load that is lifted from the heel is judiciously reapplied to the forefoot area. The spreading of the applied load is presumably indicative of a shear flow through the mechanisms of torque and shear outlined in this thesis. Although the true nature of the animate phenomena requires further investigation.

But the radius of gyration has already found a practical application in tuning the stiffness of prosthetic feet and some unpublished observations suggest this impulse distribution may be associated with anticipation and response. A factor that may prove useful in the study of psycho-mechanics.

³¹ Fig. 6-15, page 97.

7.6.2 BIPEDAL WALKING

The medial foot arch has two buttresses, the forefoot and hindfoot. These are joined by the same metatarsal coupling. The cross-section studied in Chapter 5.³² But the cross-section of the metatarsals that forms the back of the forefoot free-body could also be combined through the ground with the heel of the other foot using the different parts of the footprints in Chapter 6.

The reason for this suggestion is that a new phenomenon became apparent during the double-support phase on the 2m plate. The importance of this timing was revealed through the bar time charts of which there is an example in Appendix A. In many subjects, the forefoot contact of the one foot coincided precisely with the heel contact of the *opposite* foot. Alerting us to the possibility that there may be a fundamental forefoot-rearfoot coupling, not just within the same foot but also between the heel and forefoot bodies of *opposite* feet. Allowing at least part of the ground reaction torque to be transmitted externally through the ground.

During walking the one heel always makes contact ahead of the other trailing toe. The opposite condition to the start phase [Fig. 7-18]. This enables the body-weight to move continually forward during gait instead of going backwards as happens when gait starts. This mechanism maximizes the ground reaction torque lever arm and hence may minimize the anatomical loading. Causing the MTP-1 to appear as a force-energy sink, which explains for example, the findings of Stefanyshyn and Nigg, (1997) that suggest that the MTP joint is an energy absorber. Again a more intensive investigation into this phenomenon is indicated.³³

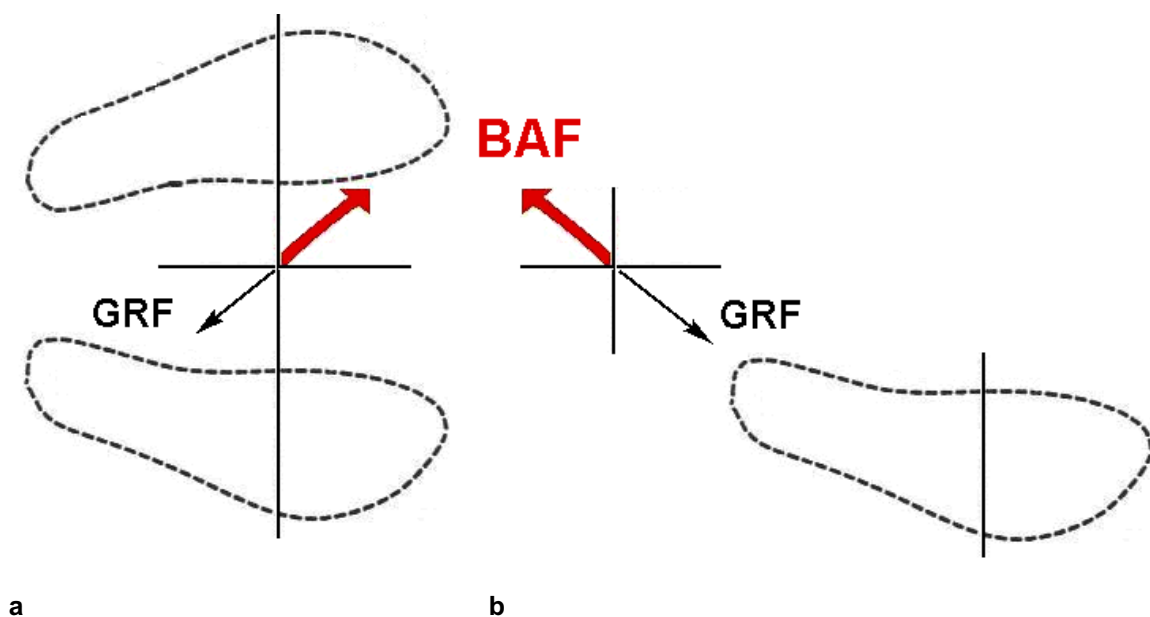

Fig. 7-18. The position of the body action force inferred from the shifting ground reaction force during gait; (a) at the start, (b) during double-stance phase.

³² For details of the anatomical joints see for example Wanivenhaus & Pretterkieber (1989); Latimer & Lovejoy (1990); Reimann & Marlovits (1992); Mak et al., (2001).

³³ This biomechanics of the double-support phase was analyzed on a post hoc basis only in single subjects. Difficulties in synchronizing the plates attached to two computers in addition to the burden of normalizing data for cadence besides the time and force parameters already normalized meant that a definitive study of the double stance phase after the first heel strike had to be omitted here.

7.6.3 MATHEMATICAL FORM OF THE AMPUTATION ARTIFACT

In this section the historic evolution of the anima is briefly reviewed in terms of mathematical form. Historically it was the *unitary* nature of the *animus* that proved of the greatest importance³⁴ because he influential scholastics naturally followed the course of the *First Mover* in Aristotle's *Physics*, rather than the concave hinged-part of the unmoved Aristotle's *anima* that is assigned here to proximal phalanx bone. The latter being postulated here as the first mover in the foot.

The Scholastics treated the *anima* as rational when they redefined it as the active *animus*, which they separated from the body. They also imbued the *animus* with extraneous spiritual *immortality* and *indivisibility* making it infinitely extended in time (eternal) and space (universal). I surmise that the immortality of the scholastic animus is better embodied in the principles of conservation of energy and momentum,³⁵ which can be reduced mathematically to the raised position of the first metatarsal bone in a gravity field—the anatomical principle of foot arch raising. The capacity to raise the spirit has to be reassigned to the body, which is done using Aristotle's instrument of the anima (III.10).

The indivisibility of the human soul is synonymous here with the indivisibility of the sole of the foot or the intact plantar aponeurosis. Which unlike the former can be tested directly by amputation. Both Descartes and Aristotle reasoned that the *anima* as an origin of motion cannot be attached to any peripheral part that can be amputated.³⁶ The issue is revived when the animate origin is shifted to the distal MTP-1 hinge joint, because the Aristotelian instrument that produces the movement can indeed be amputated.

The amputation artifact in the Cartesian cadaver is contained in the impulse component of the cinematic animation frame sequence of the 4D parameter. Impulse is calculated essentially from two 2D area-frames separated in time. The *impulse* so defined is the fundamental *percussion* component of the Newtonian impressed force. The amputation in the Galilean model is not in the foot, but appears to be an intellectual amputation from the effects of acceleration by enclosing and isolating the participants in a cabin.

Mathematically the amputation artifact can be assumed to "cut" the otherwise inaccessible primary *rational* vector of the *res cogitans* axis by introducing an *irrational* area number system. The analytical geometry introduced by Descartes³⁷ assumes the equivalence for example of geometry and algebra. But irrationality or incompleteness of a number line in this combination is present because of the irrationality of the ancient Pythagorean theorem.³⁸ The boundary of a Pythagorean geometric figure is an irrational length, which means that it has numeric holes. Classic Pythagorean-Euclidian geometry therefore inherently incorporates the amputation artifact in the mathematics. Which leads me to conclude that this form of mathematics may not be entirely suited to study of animate gait.³⁹ However a more detailed review and application of these mathematical definitions exceeds the scope of the present thesis.

³⁴ For example Giovanni Bruno (1600) was burnt at the stake for insisting that the stars were suns with separate souls (anima) that could move about (transmigrate) a thesis that century later Newton (1730) was at still at pains to condemn in the conclusion of the *Opticks*.

³⁵ The law of conservation of momentum is often used to derive Kepler's law of planetary motion that replaced the anima.

³⁶ Locating the soul in the foot is not really part of western philosophy. (Helal, 1981). But in eastern philosophy, the Indian Dance of Shiva (Coomaraswamy, pp.1948) indicates with the *fourth down pointed hand*, that the raised foot as the last refuge for the soul. Interestingly the stance foot of Shiva stands on the body of a demon, the symbol of human ignorance. (See *Tao of Physics*, Capra, p.232).

³⁷ The theorem of Cartesian linear and geometric algebra is based on the 'clear and distinct' observation that $4 = (2+2) = (2 \times 2)$. These basic axioms of the *res extensa* (x,y,z) Cartesian coordinates assume areas can be geometrically linearized. But the square root of 2 is *irrational* and the square root of -2 is *complex*. This is not a problem for Descartes because he did not use negative numbers (Gullburg, 1997, p.788). The need for negative distances in a Cartesian frame arises from Newton's central force concept applied to mass in infinitely extended absolute 3D space. Linearization of space in this way provides a central position for Aristotle's hierarchical First mover, which presents as a fundamental dichotomy recognized by Aristotle as the Atlas misconception in *The movement and progression of animals*.

³⁸ Friedrichs (1965).

³⁹ The Cartesian synthesis presented here is merely one solution. Despite the models employed by the thesis, but also because of them, there are now more compelling reasons to believe that body is a 4D tetrahedron structure that operates under the principles of biotensegrity. A model that exhibits the properties identified by the thesis, namely torsion under compression (the ground reaction torque) and a change of form collapsing from an icosahedron structure to that of an octahedron and finally a tetrahedron under extreme compression (the amputation artifact). The feet principle axes stand at 72°, the external angle of the pentagon face of an icosahedron. Johannes Kepler in fact continued to investigate the motion of the planets in terms of these so-called perfect solids.

7.7 ACADEMIC SYNTHESIS—ADVANCE OF KNOWLEDGE

This final section overviews the *meta-science* of the metatarsal so to speak. Demonstrating how an the advance in knowledge in lowly foot anatomy might terminate in a synthesis of mind or thought. The primary anatomical subject matter, the arch of the foot is compared to Oldroyd's (1986) thesis of an arch of knowledge.⁴⁰ The metaphor is extended using an entirely new meta-synthesis, the historical rope of knowledge to include the soft tissue constraining anatomical fibers, that are sometimes described in the literature as arch supporting cables, ropes or ties.

7.7.1 A HISTORIC DEFENSE

The thesis has somewhat unusually followed the precedent of Aristotle, omitting an intensive review of modern Newtonian biomechanics. This approach is unusual, but not without historical precedent. When Aristotle's physics was perhaps as widely taught in schools as Newton's physics is today, Descartes summarily dismissed the paradigms of the Aristotelian schools without reviewing them at all.⁴¹ Surprisingly little has changed in the application of Descartes' *Rules* and *Method*.⁴² Except now one might substitute the names Galileo and Newton wherever Descartes refers to Plato and Aristotle respectively. For example to paraphrase Descartes:

“These men had great minds and much wisdom..., and this gave them great authority, so that those that succeeded them were more bent on following their opinions than forming better ones of their own.” and even “those who have not followed him (amongst whom many of the best minds are to be found) have yet been imbued with his teachings in their youth for it forms the sole teachings of the Schools; and these minds were so much occupied with this, that they were incapable of attaining to a knowledge of true Principles.”

Descartes is referring here Aristotle's influence. But the same criticism nowadays might well be directed against the premise of the neo-Newtonian physical schools, that it is "Newton who rules biology". In defense of Newton, rather than the neo-Newtonian schools,⁴³ I need only draw attention to the *concluding four words* in the *Principia* where Newton himself wished he:

“could derive the rest of phenomena of Nature [including animal motion] by the same kind of reasoning from mechanical principles...or from some *truer method of philosophy*.”

The thesis has deliberately sought that truer method of philosophy mentioned by Newton. But has done so using his predecessors work. Especially, Aristotle's first philosophy, and Descartes' first principle of philosophy.

A popular criticism of Aristotle that he never encouraged experiments. But the exact match between the specifications of Aristotle's *Anima* (Book III.10) and my previous experiment provides more experimental evidence on animate motion in my opinion than does for example Newton's authority on the planets, moon and sea. Either way, I have deliberately focused on Aristotle's *instrument of the anima* rather than the spiritual form extolled by the Aristotelian Schools.

In particular the historical rejection of Aristotle's unmoved mover thesis in *de Caelo* by Galileo for example, is not be extended on an *ad hominem* basis to Aristotle's theory of animate motion in general. Except that Aristotle perhaps did err in assigning a proximal origin to the first movement. But

⁴⁰ It is interesting that the ancient Greek word *arche* means *first principle*, as well as *beginning*. Oldroyd (1986) p.43, endnote 1-53. For the use of *arche* by Aristotle see *Movement of animals*.8, 702a. Preus, p.35.

⁴¹ This task fell to Galileo's *Dialogues*, which engaged with the Aristotelian in dialectic discussions.

⁴² *Discourse on the Method of rightly conducting the Reason and seeking Truth in the Sciences* (1637); *Rules for the direction of our Intelligence's*, (1701). See also the "Author's letter to the Translator" of the book *Principles of philosophy*, "which may here serve as a Preface." Haldane and Ross (1953), pp.203-215.

⁴³ Taking a formal position contrary to an existing academic philosophy is a requirement for an original point of view.

as will be explained shortly in the structure of the arch of knowledge, Aristotle's error arises naturally from an unanticipated mathematically complex transform of the second metaphysical order, not an overt fault in his biological observations.

7.7.2 ARCH OF KNOWLEDGE

Oldroyd likened the processes of logical scientific deduction and the much rarer process of inspirational induction to the two buttresses of the arch of knowledge.⁴⁴ The two scientific legs of the arch of knowledge however, are not equally well developed. The process of deducing observable consequences from principles proceeds rapidly compared to the inductive leg of elevating observations to the aforesaid principles via composition or synthesis [Fig. 7-19]. The analytical leg follows the deductive logic that divides a problem into smaller parts, a characteristic of Descartes' *res extensa* philosophy. On the other hand, the process of induction is a continual uphill struggle so to speak.

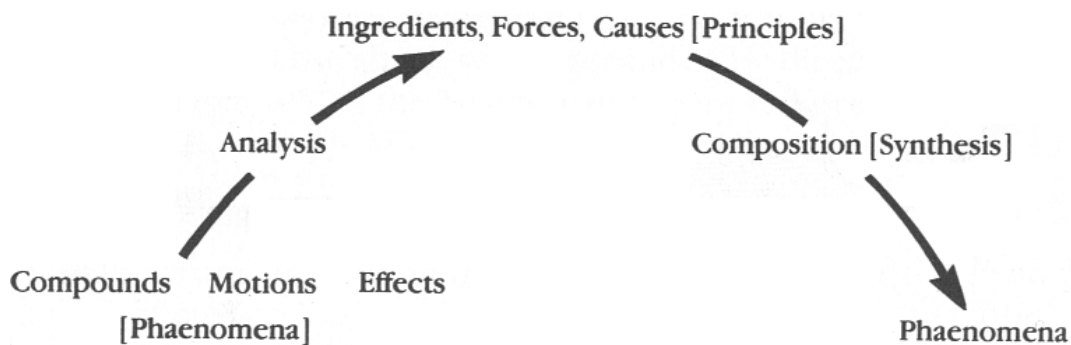

Fig. 7-19. Oldroyd's representation of the *arch of knowledge* derived from Newton's *Question 31* of the *Opticks*.

Oldroyd's thesis however recognizes few *logical rules* for these cognitive associations that go by the name of induction. The postulated reason being that the cognitive process of analysis has passed through an *orthogonal complex plane* of principles, Plato's world of ideal forms and Kant's nomena, and back again to the real world of observable phenomena. In this case, the arch of knowledge bears a resemblance to the real components of the imaginary *res cogitans* mode of thinking. But the process I believe might be better compared to a *rope of knowledge*.

⁴⁴ This metaphor is based on a description of *analysis and synthesis* by Turbanye (1962) “[which] discusses a venerable tradition of a two-fold pathway for the establishment of knowledge—from an examination of observable phenomena to general rational ‘first principles’ (‘analysis’); and from such ‘first principles’ back again to observables, which are thereby explained in terms of the principles from which they are held to be deducible (‘synthesis’).”

7.7.3 ROPE OF KNOWLEDGE

The metaphysical *rope of knowledge* introduced here is similar perhaps to scientific paradigm (Kuhn, 1970) because it is a metaphor used to describe the transformations in the cognitive field of interrelated definitions and observations that reside at the core of science.

The rope metaphor relies on the notion that a rope consists of sets of fibers that are twisted into groups or strands.⁴⁵ The rope fibers are definitions that can be traced to a definitive statement—the historical thesis. Combinations of definitions create the strands that are themselves twisted in bundles⁴⁶ on into a larger rope. Some strands are tight-knit (such as Newton's three laws) while others may seem unrelated (e.g. the Scholastic philosophy).

A cross-sectional slice of the rope represents an instant in history. But in a literature review spanning only a few years or decades, the fibers appear as isolated axioms or points-of-origin for the analysis. However over a longer time, the strands at the beginning (original definitions) do not necessarily consist of the same fibers at the end of the rope. New fibers (definitions) are continually introduced into the existing rope over time just as old fibers (definitions) become redundant. For example the underlying definitions of *physics* has changed completely since Aristotle. *Physicists* today hardly follow the *physics* of Aristotle at all.

Descartes for one recognized that it would take many centuries to implement his scientific program. Indeed science proceeds through gradual modifications in the definitions of terms over many human lifespans. The Galilean-Newtonian model of the biomechanical antithesis for example only consists of a very short section of the rope of knowledge. Using the original physics and anima as an example, a completely different perspective is obtained from a historical time-line that starts for example from the ragged ends of Zeno's paradoxes, through to the equally disjunctive strands of Gödel's theorem [Fig. 7-20].

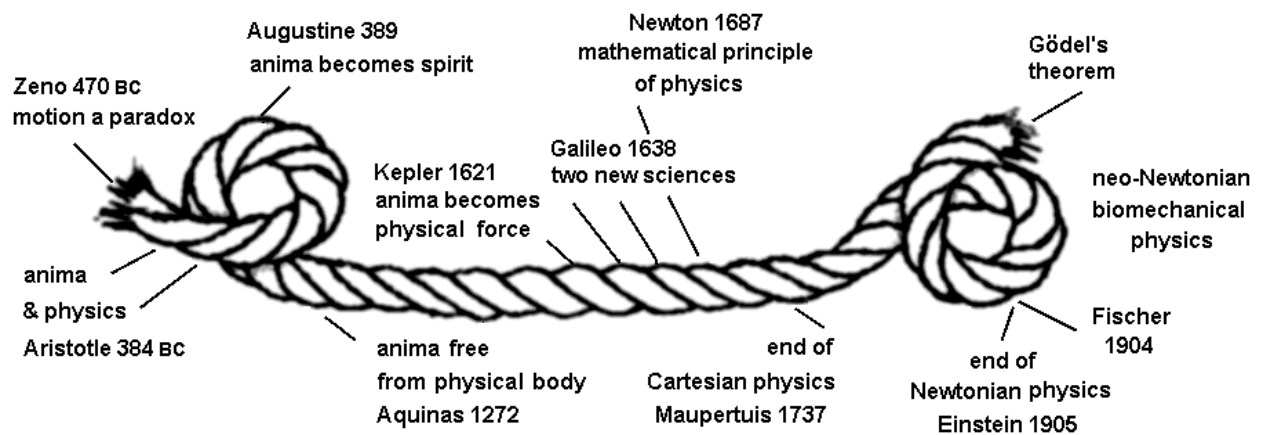

Fig. 7-20. The rope of knowledge as a twisted set of historical definitions. Example physics and anima.

⁴⁵ Axioms or first principles.

⁴⁶ Scientific disciplines or paradigms.

7.7.4 ANATOMY OF NEWTON'S PHENOMENA

The rope of knowledge metaphor differs from the scientific paradigm because the Cartesian cognitive free-will developed in Chapter 3 and 4 can be divided into quarter revolutions in an imaginary plane. Four such rotations from any physical frame of reference bring the user back to the beginning point. A process that appears under specific circumstances⁴⁷ to result in an argument in a circle [Fig 7-21a]. But on a historical time scale, these circular arguments appear more as a helical thread in the rope of knowledge [Fig. 7-23]. The helical path depicted in Fig. 7-20 is for example a fiber of the physics or anima, disciplines we might now call a pure science and scientific art form respectively.

Occasionally however in a laboratory time scale such circular arguments assume the proportions of a scientific revolution that allows the construction of an arch of knowledge. Newton's *phenomena* in this model are simply the deducible *physical science* defined in terms of the circular definitions of mass and inertia.⁴⁸ The inductive leg of the arch of knowledge is established when two cognitive (*res cogitans*) rotations mapped onto observable phenomena⁴⁹ produce a sign reversal in the physical domain of phenomena [Fig. 7-21b].

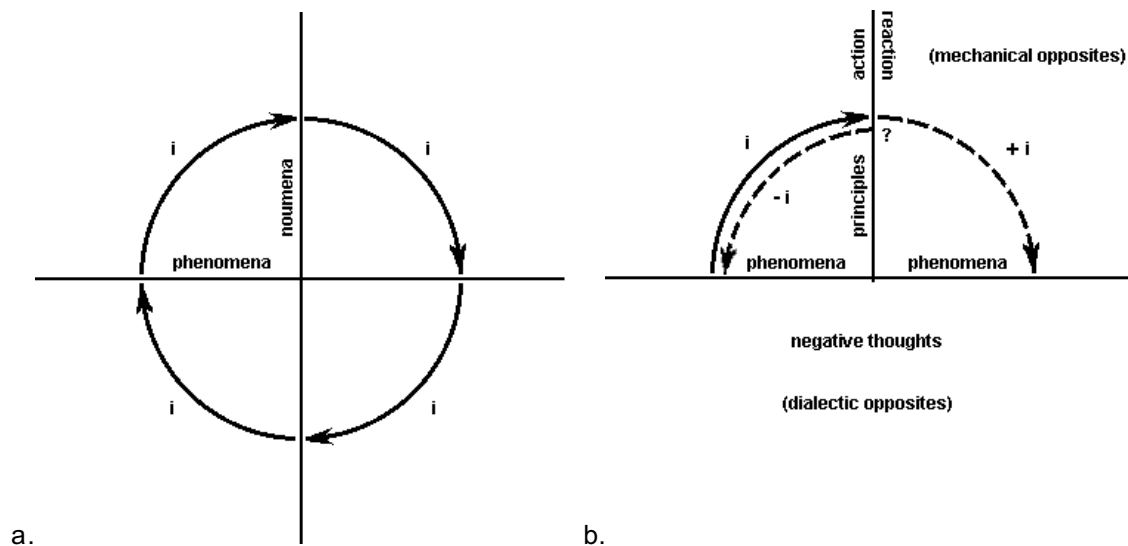

Fig. 7-21. Operational mappings of the *res cogitans* field of nomena onto *res extensa* phenomena.

(a) Four dimensional arguments in a circle; (b) Newton's arch of knowledge, inductive leg.

An important concern is that the origin of the real resultant of the second *res cogitans* dimension is ambiguous, indicated by a dashed line. For example, is the second imaginary rotation completed before its complex sign reverses? Or when it starts? The ambiguity is perhaps obscured in reality by either a change in the action-reaction sign convention, or even hidden in an anatomical left-handed, right-handed coordinate interchange, or in the finite extremities of Zeno's paradox.

Similar fundamental arguments can also be discerned in Newton's axioms of motion that define the problem of initiating gait [Fig. 7-22a] and Aristotle's preference for a proximal origin of motion [Fig. 7-22b]. In Newton's case the end points are the states of rest and uniform motion (Newton's first law); the midline is the proportional principle of inertia and mass (Newton's second law)⁵⁰ and the equivalence of the end points is enforced by Newton's third law.

⁴⁷ Ignorance of the history time-scale in favour of a laboratory time-scale.

⁴⁸ Einstein and Infeld (1971) point out that the definition of mass in terms of inertia and inertia in terms of mass is a circular argument.

⁴⁹ Similar perhaps to the *nomena* of Emanuel Kant

⁵⁰ Force = mass x acceleration.

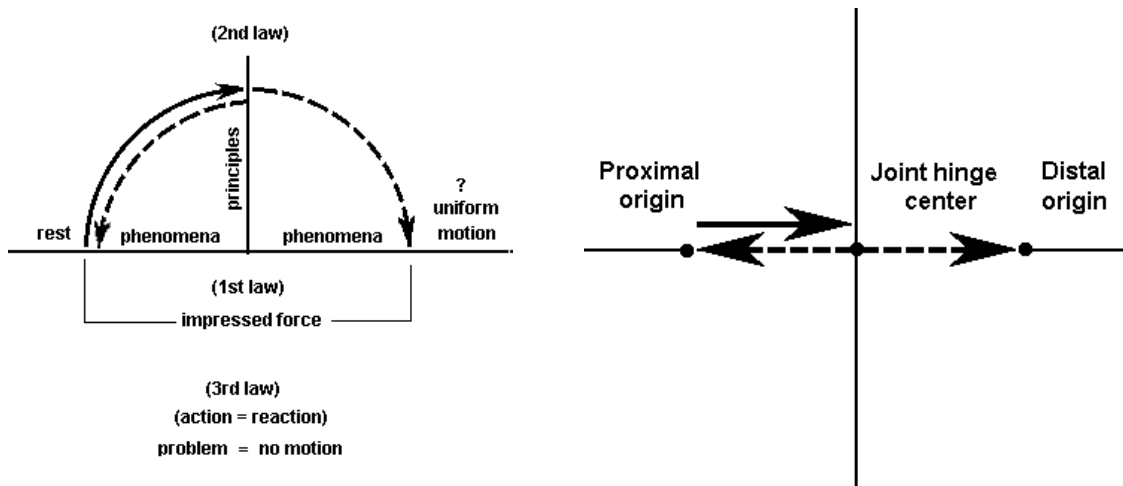

Fig. 7-22. Constraints defining the problem of initiating gait. (a) Newton's axioms; (b) Aristotle's proximal origin.

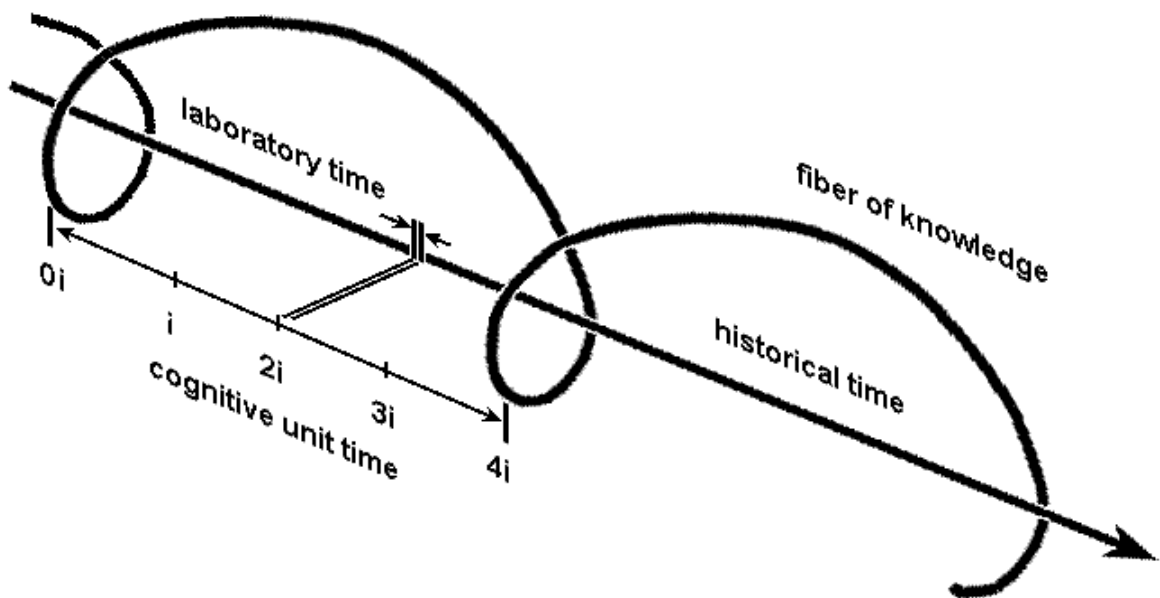

Fig. 7-23. Argument in circle as a historical fiber forming a helix in the rope of knowledge.

Finally the rope of knowledge is combined with the arch of knowledge as in Fig. 7-24 and 7-25.⁵¹ The historical rope of knowledge thesis proposed, is a vehicle intended to help researchers come to terms with the matted web of definitions of physical science in a more structured manner than has feasible at the time this thesis was initiated. And allow the definitions used in biomechanics to be assessed without the aggravation of intractable dialectic opposites.

⁵¹ The rope is depicted here with one end it is looped around the four dimensional bollards provided by Plato in his *Republic* and at the other end by Einstein's relative four-dimensional space time continuum. Briefly Plato, in his *Republic*, 509d-511e wrote, "Take these four affections arising in the soul in relation to the four segments.... Arrange them in proportion, and believe that as the segments to which they correspond participate in truth so they participate in clarity."

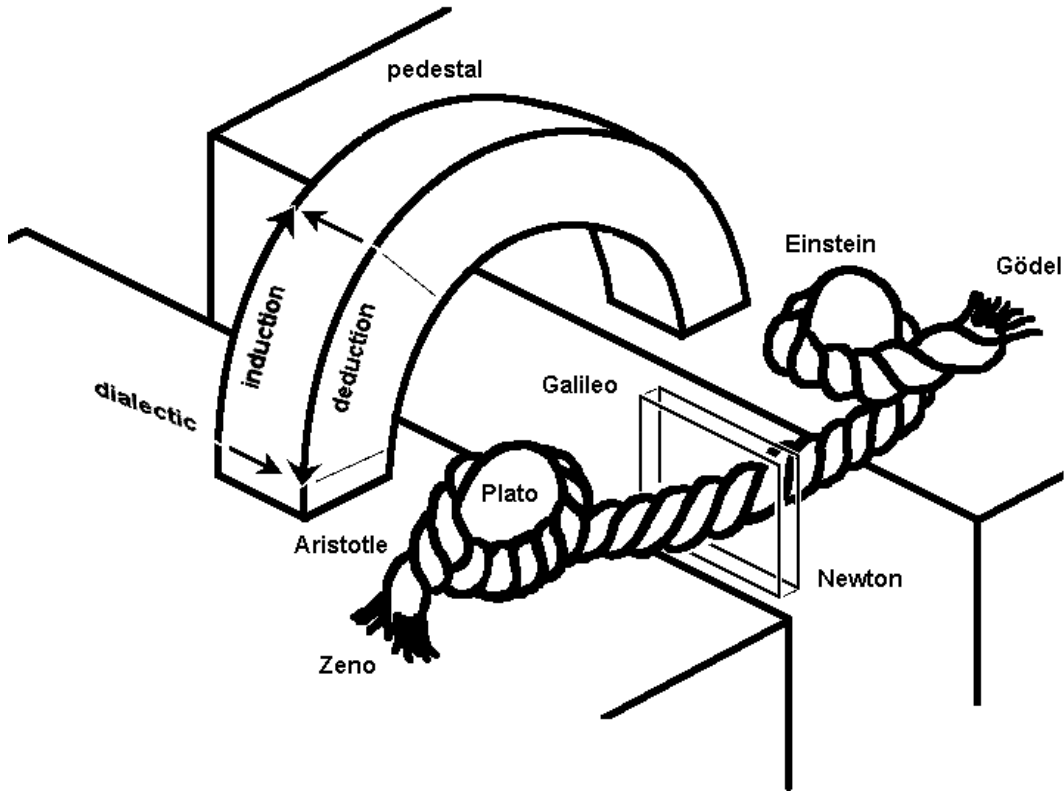

Fig. 7-24. Arch and rope of knowledge.

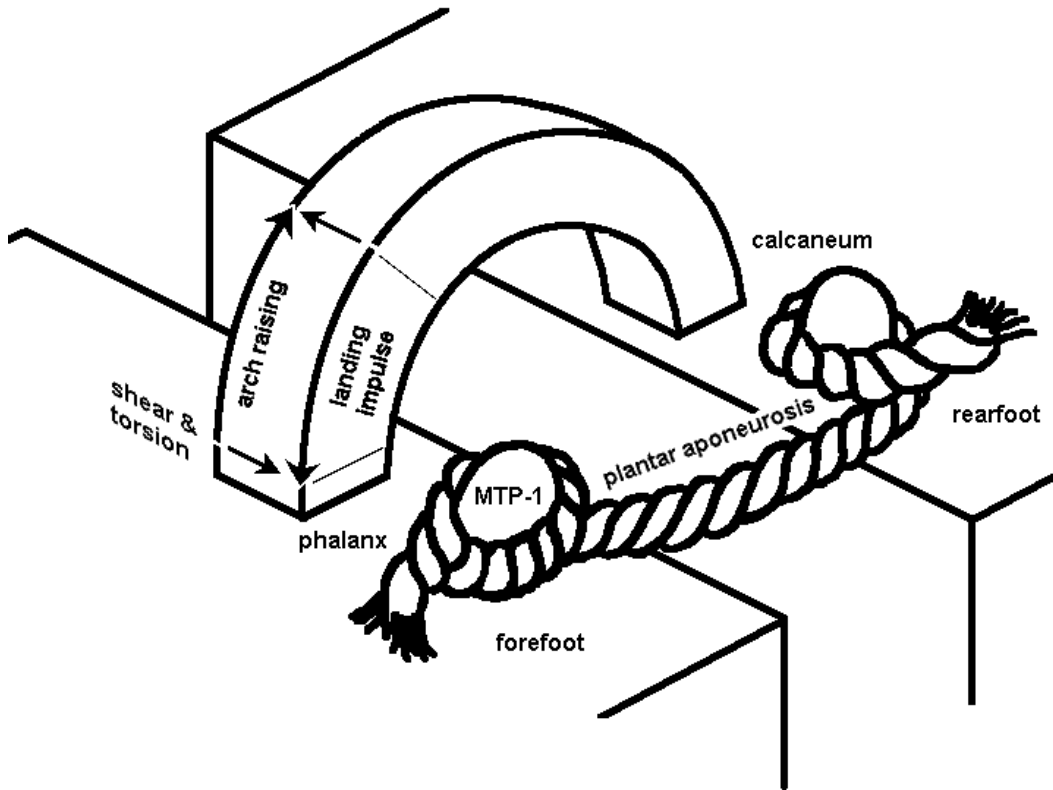

Fig. 7-25. Arch and rope of knowledge compared to the anatomical structure of the foot.

8.

CONCLUSIONS

"I shall have the right to conceive high hopes if I am happy enough to discover one thing only which is certain and indubitable." — René Descartes ¹

8.1 STARTING TO WALK

The first consequence of deciding to walk that was detected on a pressure plate is the raising or dorsiflexing of the great toe. This definite conclusion is possible because the reduction of the force under the great toe is the first action to converge on the standard deviation of the regional force profiles in a subject group of 54 people. Furthermore, the principle axes of the impulse reveal that both feet invert and that the medial arches are unloaded. Both of which are inexorable consequences of first metatarsophalangeal dorsiflexion.²

The lifting of the toes is accompanied by a simultaneous shift in pressure onto both heels. The force applied by the foot that remains on the ground initially diminishes whilst both feet are still on the ground.³ The initial reduction in total force however indicates that gait started by free-will, does so partly powered by gravity free-fall. A link that was predicted after drawing the first biomechanical diagram incorporating a Cartesian free-will component.

The sudden initial dorsiflexion of the toes inevitably causes the body to bear relatively more weight on the heels. The muscles are so aligned that if they were to act initially, the body would respond by falling over backward.⁴ The increasing weight on both the heels would thus appear to indicate that the initial action is controlled by muscle action. But the total force under the feet actually drops,⁵ which indicates that gait is initially at least partly powered by gravity as originally hypothesized. Furthermore, the surprisingly small right-side dominance of 54% suggests that there is minimal active control exercised by a specialized bi-lateral neuromuscular system in the initial stages of gait.

The increased impulse initially seen under the lateral border of the foot is however a peculiarity of the initial stance phase. During gait itself, pressure on average is always applied medially and removed laterally.⁶ This indicates that human bipedal gait is not a simple side-to-side waddle from one foot to the other; a result that was anticipated in Chapter 5 given the relatively large size of the human first metatarsal compared to that of various apes.

The role of the first metatarsal in controlling gait, which is in addition to its role in initiating gait, is demonstrated immediately in the first step when there is increased pressure applied to the first metatarsal. This increased pressure serves to compensate for the initial exaggerated sway onto the lateral border of the foot that initially remains behind after the initial foot lift. This supination action is believed to be controlled by a new anatomical model, the first metatarsal key bone. The new metatarsal cam and key bone models effectively replace the static functions of the traditional forefoot arch.

¹ *First Meditation* on the principles of philosophy.

² An observation by Hicks (1954).

³ This conclusion may be subject to revision once calibrated pressure sensors are available.

⁴ An observation by Morton (1952).

⁵ Appendix A, Fig. A-1.

⁶ The two plates were of different sensitivities and this conclusion is provisional until accurately calibrated pressure platforms are available.

8.2 BIOMECHANICAL POINT OF VIEW

8.2.1 REST AND MOTION

The biomechanical problem of initiating gait stems from Newton's first law of motion, because a person must first leave a state standing at rest before reaching the nominal state of uniform motion known as gait. Newton's examples in his definitions suggest that the transient state is most likely due to an *impressed force* that arises from a *centripetal* source (such as gravity) a *pressure* (force/area) or *percussion* (impulse). Consequently, the initiation of gait has been studied experimentally using the *gravitational pressure* and *impulse* components of the *ground reaction force* on two pressure plates. One to quantify the initial resting posture, and the other to quantify the transient state before the onset of a regular or uniform gait pattern.⁷

It is postulated however that the initial state of rest extends throughout the gait process. This interpretation prioritizes Newton first constraint of his first law, a continuous state of rest, over his second constraint of uniform motion. Allowing one to:

- ❖ Model the leg as a static beam fixed to the ground throughout the gait and posture cycle.
- ❖ Reconsider Aristotle's thesis of an unmoved mover.⁸

The rest model of gait introduces parameters that have not previously been used for gait analysis. Including the principle axes of the footprint, radius of gyration in the horizontal plane, and local shear.

8.2.2 ARISTOTLE'S UNMOVED MOVER

Aristotle's thesis of an unmoved mover located in the most distal toe segment follows from a new form of kinematic data obtained from cadavers where the distal segment is held at rest while the proximal part is assumed to move.

Aristotle's old philosophy of an unmoved mover connecting the body to the mind is verified to a high level of precision in the great toe for animate bipedal walking. Experiments conducted with pressure plate at self-selected pace reveal that the great toe of the stance foot remains *unmoved* in contact with the ground during gait *later* than any other foot part. The footprints on the 2m plate reveal that the first toe of one foot remains unmoved on the ground during walking until the great toe of the other foot is grounded. Immediately thereafter control of the motion is potentially transferred to the first toe of the second foot, which then assumes the role of the unmoved mover for the next step cycle.

⁷ Considered by most researchers to be achieved after a maximum of three steps.

⁸ The theory of an unmoved mover is not allowed in terms of Newton's third law and the law of conservation of momentum.

8.2.3 FREE-BODY ANALYSIS

1. Choice of free-body

The first procedural step was of course to *choose a free body*. The biomechanical free body was identified as the forefoot because the first metatarsophalangeal joint (MTP-1) is situated directly in line with the regression of the ground reaction force.⁹ The forefoot was isolated in three planes.

- ❖ The sagittal view that contained the MTP-1 joint cam.
- ❖ The coronal cross section of the metatarsal shafts.
- ❖ The horizontal transverse section, the pressure plate under the foot.

Each of these planes was studied in a different chapter using different methods and materials.

2. Isolation of free-body

The second step was to completely *isolate*¹⁰ the distal body from its surroundings. The effect of isolating the MTP-1 was also previously been determined from an experiment where several MTP-1 joints were physically isolated after being amputated from cadavers. The work on cadavers¹¹ was studied from both philosophical and experimental perspectives. The emphasis however was placed on drawing a clear distinction between the animate body and the inanimate cadaver, with the objective of isolating the imaginary mathematical form of the animating principle in the living subject.

3. Unknowns

The third step involved determining the effect of the *known* and *unknown* forces acting on the body. In Chapter 4, the physical isolation enforced by amputation was confirmed by observation and analysis of the frames of reference to be associated with three previously *unknown* artifacts:

- ❖ Metatarsal cam.
- ❖ Ground reaction torque (GRT).
- ❖ Clinical amputation artifact.

The three principles of animate motion were deduced from the observable phenomena that occur before and after dividing the plantar aponeurosis and other anatomical tissues in cadavers. The derivation of these principles represents an important step in philosophy.¹²

⁹ Mann and Hagy (1979), Fig. 1-1, p.2.

¹⁰ complete isolation is presumably equivalent to amputation.

¹¹ Nevin C. Kinematics of the first metatarsophalangeal joint in intact and surgically altered cadavers. *Foot & Ankle Int.*, 18(3):132-137,1997.

¹² Newton (1730) wrote, "To derive two or three general Principles of Motion from phænomena, and afterwards tell us how the properties and actions of all corporeal things follow from those manifest principles, would be a very great step in philosophy."

4. Choice of mathematical frame of reference

The fourth step was to select an appropriate *mathematical* frame of reference. The mathematical novelty of the present thesis is to distinguish between the two types of Cartesian coordinates based on the criterion of physical divisibility.

- ❖ The choice of the four dimensional Cartesian *res cogitans* is justified because surgical division of the plantar aponeurosis removes the cam effect, and replaces it with simple hinge model.
- ❖ The distinction between the indivisible *res cogitans* and differentiable *res extensa* is therefore characterized by the cam-thesis and its hinge-antithesis.

Both the horizontal and coronal planes of the metatarsals in the forefoot free-body have been analyzed using the second moment of area parameter which has in the *res extensa* system the units of [length]⁴. Consequently:

- ❖ In the coronal metatarsal cross section, the second moment of area was used to estimate the torsion strength of the bones, confirming the hypothesis that the human first metatarsal is optimized for torque transmission.
- ❖ In the horizontal plane the second moment of area was transformed mathematically into a set of three derivative forms.
 - Principle axes.
 - Principle foot angle.
 - Radius of gyration.

These derived forms were reconstructed in a mathematically animated sequence of the five footprints starting from the beginning of gait to the end of the third step when the regular gait pattern is considered to be have begun.

To test the hypothesis, new computer algorithms were designed to isolate the pressure under the great toe from other regions of the foot.¹³ The second moment of area was developed as a mathematical parameter that is used to animate the foot. The description of the footprint based on the second moment of area produces a 4D picture of the internal mechanics of the unmoved mover acting on a plane inserted between the internal unmoved proximal phalanx and the external unmoved ground support.

A cinematic series of these pictures incorporating the maximum and minimum principles axes of the impulse, their angle and radius of gyration results in the final product of the thesis—a mathematically animated model of the foot.¹⁴

¹³ Appendix A

¹⁴ Appendix B

8.3 ANATOMICAL POINT OF VIEW

8.3.1 PRINCIPLES OF ANIMATE MOTION

Three principles of animate motion were deduced from the observable phenomena that had been made apparent through the method of kinematic projected transformation (KPT).

1. Metatarsal Cam

Cams are regularly used to convert rotary motion into reciprocating motion, and in many cases the behavior of the entire machine is dependent on the design of the cam motion. The cam model of the great toe has therefore justifiably been used as the *primary anatomical model* in the thesis. In addition the cam model:

- ❖ is an *experimental* consequence of locating Aristotle's *first mover* as an internal unmoved mover in the animate hinge of the great toe.¹⁵
- ❖ is based on a fixed and unmoving base of support, therefore replaces the traditional *arch model* of the forefoot.
- ❖ adds the dynamic component that the arch model lacks.
- ❖ describes the virtual lengthening and shortening of the first metatarsal segment as the MTP-1 rotates about a variable point that otherwise constitutes the fixed joint center.

2. Amputation Artifact

The primary cam effect however appears to be *lost* with amputation of the soft tissues. Also suspected of being lost, is some metatarsal torsion bone strength required for the ground reaction torque. There are sound mathematical reasons for this:

- ❖ The cam profile is a physical manifestation of an imaginary area. As such it can be made to disappear by removing one of its *imaginary* dimensions without removing any of its physical dimensions; i.e. cutting the externally attached soft tissues.
- ❖ The *res cogitans* is defined by the characteristic of *indivisibility*, which is not present when one deals with physically or experimentally isolated amputated feet. The act of resection therefore enforces a fundamental Cartesian coordinate system transformation; not a simple x,y,z transposition, but a very fundamental shift of underlying mathematical philosophy.
- ❖ Amputation is linked to a physical outcome because the system in the foot is postulated to be *mathematically complex*. This means that although anatomical systems like the osseo-aponeurosis and neuro-muscular compartments have orthogonal imaginary dimensions, they nevertheless do have real products that link the systems together. Specifically it is two geometrical *areas* or imaginary fields that physically interact during the kinematic projected transformation of the great toe.

¹⁵ *De Anima III.10.*

3. Ground Reaction Torque

The ground reaction torque is an energy transient that is stored in the body in the form of counter-rotating strain energy or potential momentum.

- ❖ It was isolated in Chapter 4 when the frames of reference that constrain the experimental cadaver were analyzed.
- ❖ The MTP-1 was also isolated in Chapter 5, and its torsion strength estimated by taking a transverse section through the metatarsals.
- ❖ The fundamental connection between the ground reaction torque to the human bipedal body action force was demonstrated in the relative torsion strengths of the metatarsals.
- ❖ The ground reaction torque was quantified using the hypothesis of principle axes of a static beam bending theory.¹⁶
- ❖ The principle axes of the footprint and the radii of gyration of the load and impulse were determined from the second moment of area, with the area being replaced by the relative density of the applied force over the mean distributed force.

¹⁶ The philosophy of modeling the foot and the ground as one structure is believed to be obligatory in terms of Newton first law in the absence of uniform motion or an animating force.

8.4 HISTORICAL POINT OF VIEW

8.4.1 FIRST PRINCIPLES

The problem of initiating and controlling gait has been studied from various first principles. Including Aristotle's *First Mover* in his *First philosophy*, Descartes' *First principle* of the *First part* of his *Principles of philosophy*, and Newton's first constraint of his *First axiom or law of motion* in his *Mathematical principles of natural philosophy*.

Historically Zeno of Elea was the first to identify the recursive problem of locating or original source of motion. Aristotle resolved the problem by postulating a *First Mover* that is unmoved. Aristotle's theory was subsequently converted into the theological *animus* or spirit. Whilst his *physical origin* of the *First Mover* evolved into a center of mass model gravity model. The two origins being practically separated by St Thomas of Aquinas in the middle ages, leaving us with the modern day free-body problem. Johannes Kepler converted Aristotle's universal *anima* back into a *physical force* by describing it in terms of a two dimensional spatial temporal area. Isaac Newton assimilated Kepler's ideas into the law of gravitation, which together with Galileo postulate of inertia, assigned Aristotle's philosophy of the universal unmoved mover to the history books. Leaving us with the modern model where it is widely assumed that Newton rules biology.

8.4.2 MATHEMATICAL PRINCIPLES

But instead of using Newton's *Mathematical principles*, in conjunction with the Galilean invariance that allows uniform motion, the thesis has developed the Cartesian mathematics of the neglected *res cogitans* system. René Descartes recognized two substances, the *res extensa* and *res cogitans* the respective components that can be applied to the free-body free-mind problem respectively. The *res extensa* (x, y, z) Cartesian coordinate system, applies to infinitely divisible body and the *res cogitans* to indivisible mind.

The thesis presumes the *res cogitans* to consist of four independent imaginary dimensions. A plot of the relative motion of two points in this imaginary space results in a real negative sign convention with an indeterminate origin. This new mathematical interpretation applied to the old universal anima effectively converts Aristotle's indistinct proximal central location for the first mover into a peripheral distal location. The lack of an origin in this new model is seen as a benefit for the biological tissues that would otherwise be compelled to sustain infinitely high forces.

Following a novel synthesis of Aristotle's and Newton's theses the distal location the focal point of the concave first proximal phalanx of the first metatarso-phalangeal joint of the first toe is the preferred analytical origin of human bipedal locomotion. This position, originally predicted from force-plate data, is conclusively reaffirmed by new data from 54 normal subjects standing quietly on a pressure plate. The result is conclusive because the standard deviation of the force under the first toe is the first parameter to converge after the instruction to walk is given.

A synthesis of all the first principles mentioned above, as well as the new data from pressure plates reaffirms the *principle premise* of the thesis. Namely that the anatomical, physiological, mathematical and biomechanical mechanisms needed to animate the body via a voluntary human bipedal body action force can indeed be determined from an analysis of the motion of the first toe.

3. Ground Reaction Torque

The ground reaction torque is an energy transient that is stored in the body in the form of counter-rotating strain energy or potential momentum.

- ❖ It was isolated in Chapter 4 when the frames of reference that constrain the experimental cadaver were analyzed.
- ❖ The MTP-1 was also isolated in Chapter 5, and its torsion strength estimated by taking a transverse section through the metatarsals.
- ❖ The fundamental connection between the ground reaction torque to the human bipedal body action force was demonstrated in the relative torsion strengths of the metatarsals.
- ❖ The ground reaction torque was quantified using the hypothesis of principle axes of a static beam bending theory.¹⁶
- ❖ The principle axes of the footprint and the radii of gyration of the load and impulse were determined from the second moment of area, with the area being replaced by the relative density of the applied force over the mean distributed force.

¹⁶ The philosophy of modeling the foot and the ground as one structure is believed to be obligatory in terms of Newton first law in the absence of uniform motion or an animating force.

8.4 HISTORICAL POINT OF VIEW

8.4.1 FIRST PRINCIPLES

The problem of initiating and controlling gait has been studied from various first principles. Including Aristotle's *First Mover* in his *First philosophy*, Descartes' *First principle* of the *First part* of his *Principles of philosophy*, and Newton's first constraint of his *First axiom or law of motion* in his *Mathematical principles of natural philosophy*.

Historically Zeno of Elea was the first to identify the recursive problem of locating or original source of motion. Aristotle resolved the problem by postulating a *First Mover* that is unmoved. Aristotle's theory was subsequently converted into the theological *animus* or spirit. Whilst his *physical origin* of the *First Mover* evolved into a center of mass model gravity model. The two origins being practically separated by St Thomas of Aquinas in the middle ages, leaving us with the modern day free-body problem. Johannes Kepler converted Aristotle's universal *anima* back into a *physical force* by describing it in terms of a two dimensional spatial temporal area. Isaac Newton assimilated Kepler's ideas into the law of gravitation, which together with Galileo postulate of inertia, assigned Aristotle's philosophy of the universal unmoved mover to the history books. Leaving us with the modern model where it is widely assumed that Newton rules biology.

8.4.2 MATHEMATICAL PRINCIPLES

But instead of using Newton's *Mathematical principles*, in conjunction with the Galilean invariance that allows uniform motion, the thesis has developed the Cartesian mathematics of the neglected *res cogitans* system. René Descartes recognized two substances, the *res extensa* and *res cogitans* the respective components that can be applied to the free-body free-mind problem respectively. The *res extensa* (x, y, z) Cartesian coordinate system, applies to infinitely divisible body and the *res cogitans* to indivisible mind.

The thesis presumes the *res cogitans* to consist of four independent imaginary dimensions. A plot of the relative motion of two points in this imaginary space results in a real negative sign convention with an indeterminate origin. This new mathematical interpretation applied to the old universal anima effectively converts Aristotle's indistinct proximal central location for the first mover into a peripheral distal location. The lack of an origin in this new model is seen as a benefit for the biological tissues that would otherwise be compelled to sustain infinitely high forces.

Following a novel synthesis of Aristotle's and Newton's theses the distal location the focal point of the concave first proximal phalanx of the first metatarso-phalangeal joint of the first toe is the preferred analytical origin of human bipedal locomotion. This position, originally predicted from force-plate data, is conclusively reaffirmed by new data from 54 normal subjects standing quietly on a pressure plate. The result is conclusive because the standard deviation of the force under the first toe is the first parameter to converge after the instruction to walk is given.

A synthesis of all the first principles mentioned above, as well as the new data from pressure plates reaffirms the *principle premise* of the thesis. Namely that the anatomical, physiological, mathematical and biomechanical mechanisms needed to animate the body via a voluntary human bipedal body action force can indeed be determined from an analysis of the motion of the first toe.

8.5 RECOMMENDATIONS

During the course of the thesis certain technical or theoretical deficiencies were encountered, and promising avenues of research exposed that could not be fully materialized.

8.5.1 TECHNOLOGY

A reading of Newton's Principia make it plain that *pressure* rather than force is a fundamental parameter. Biomechanical studies therefore would benefit greatly from improvements in pressure measurement technology. Specifically:

- ❖ A well-calibrated pressure platform would make the conclusion of this study more definite.
- ❖ On an operational level, a high frequency study of the double stance period is clearly needed to investigate the peculiar behavior of the principle axes of the heel in relation to the toe-off phase of the trailing leg. The operational limitation of 125 Hz for 2 seconds of walking on the 2m plate should be raised to 250 Hz or 500 Hz.
- ❖ Different types of triggers are needed to synchronize pressure plates. Important data during the double-stance phase spanning the two pressure plates was unfortunately forfeited because of a lack of capacity in this regard.

8.5.2 FUTURE DIRECTIONS

Unique data on local shear stresses under the foot was gathered, which may provide useful information on the development of pressure sores in diabetics for example. But this data first needs to be verified against data obtained from different source; for example mechanically instrumented inanimate objects bounced or rolled over the plate.

With verified data the shear stresses might then be used to find the *shear center* during gait. The shear center happens to be the location of zero torque, an important point for any analysis of the ground reaction torque.

Towards the end of the study when the principle axes of the feet were visualized in a plan view, one particularly promising research direction was indicated. That of macroscopic biotensegrity based on the pentagonal geometry of the icosahedron. The reasons for this assessment are many including the torque-tension relationship of the kinematic projected transformation artifacts. A glance at the principle axes of the footprint during stance for example reveals that the feet are placed at 72° , which is the exterior angle of a pentagon. The interior angle of 108° is perhaps the angle of the forefoot to the anterior principle axis, which appears more anatomically correct than the 90° right angle assumed for the analyses performed in the thesis.

Historically the geometry of the perfect solids such as tetrahedron, octahedron and icosahedron formed from twenty pentagons was the model actively favored by Kepler at the time when the anima became juxtaposed by Kepler with the physical force of gravity.

The relationship between the force of gravity and the human locomotor form identified in terms of the free-will diagram was studied in terms of an environmental model using maps in which terrestrial gravity was considered the primary variable rather than a constant. But the results have been omitted from the thesis because they could not be directly related to the forefoot free-body analysis.

The crucial relationship between gravity and the human bipedal locomotor form is believed to be fundamental in nature. An observation emphasized by D.J. Morton, whose life-work involved detailed investigation of the structure of the foot, and championing many views that are expressed in this thesis.

REFERENCES

- Abramson E.
1927.
Zur Kenntnis der Mechanik des Mittelfusses. *Skandinavisches Archiv für Physiologie*, 51:175-234.
- Ariel GB, Buijs RJC, Penny A, Chung SGC.
2000.
Visualizing orientations using quaternions.
Proc. Sixth International Symposium on the 3D analysis of Human Movement. 1-4 May 2000, Cape Town, South Africa.
- Aristotle.
1981.
On the movement and progression of animals. Commentary by Michael of Ephesus, edited by A Preus. Georg Olms Verlag Hildesheim: New York.
- Aristotle.
1989.
De Anima. See Hamlyn.
- Arthornthurasook A, Gaew ImK.
1990.
Anterior tibial tendon insertion: an anatomical study.
Journal of the Medical Association of Thailand, 73(12):692-696.
- Ascenzi A.
1993.
Biomechanics and Galileo Galilei. *Journal of Biomechanics*, 26:95-100.
- Atkins PW.
1984.
The second law. *Scientific American Library*. Freeman and Company: New York.
- Basmajian JV, DeLuca CJ.
1974.
Muscles alive: their functions revealed through electromyography.
Williams and Wilkins, Baltimore.
- Basmajian JV.
1976.
The human bicycle. In: *Biomechanics V-A*, pp.297-302. Komi PV (ed). University Park Press: Baltimore.
- Basmajian JV.
1976.
The human bicycle: An ultimate biological convenience. *Orthopaedic Clinics of North America*, 1976;7:1027-1029.
- Baumann W.
1976.
Kinematic and dynamic characteristics of the sprint start. In: *Biomechanics V-B*, pp.194-199. Komi PV (ed). University Park Press: Baltimore.
- Berstein.
1966.
See Meijer, 1998.
- Bobbert MF, Yeadon MR, Nigg BM.
1992.
Mechanical analysis of the landing phase in heel-toe running.
Journal of Biomechanics, 25:223-234.

- Bojsen-Møller F, Lamoreux L.
1979.
Significance of free dorsiflexion of the toes in walking.
Acta Orthop Scand, 50:471-479.
- Borrelli A.
1680.
On the movements of the animals. See Cavanagh, 1990.
- Braune W, Fischer O.
Der Gang des Menschen. Leipzig: BG Teubner, 1896-1904.
The human gait.. (P Maquet, R Furlong, trans.) Springer-Verlag: Berlin, 1987.
- Brenière Y, Do MC.
1986.
When and how does steady state gait movement induced from upright posture begin?
Journal of Biomechanics, 19:1035-1040.
- Brigido SA, Hilstrom HJ, Bhimji S, Song, J, Berlin JM, Brown KM, Siegler S.
2001.
First metatarsophalangeal joint flexibility: a comparison of hallux limitus, functional hallux limitus and, healthy. 18th Congress of the International Society of Biomechanics, Zurich.
- Bunge M.
1980.
The mind-body problem. A psychological biological approach. Pergamon Press: Oxford.
- Capra F.
Tao of Physics.
- Carlsöö S.
1966.
Initiation of walking.
Acta Anatomica, 65:1-9.
- Cavagna GA, Dusman B, Margaria R.
1968.
Positive work done by a previously stretched muscle.
Journal of Applied Physiology, 24:21-32.
- Cavanagh PR.
1990.
The biomechanics of distance running, Human Kinetics Books: Champaign, IL.
- Cohen IB.
1971.
Introduction to Newton's 'Principia'. Cambridge University Press: London.
- Cooper L.
1972.
Aristotle, Galileo and the Tower of Pisa. Kennikat Press: Port Washington.
- Courtney AC, Davis BL, Manning T, Kambic HE.
1997.
Effects of age, density, and geometry on the bending strength of human metatarsals.
Foot & Ankle International, 18:216-221.
- de Santillana.
1953.
See Galilei.

de Wit B, de Clercq D, Aerts P.

2000.

Biomechanical analysis of the stance phase during barefoot and shod running.

Journal of Biomechanics, 33:269-278.

Descartes R.

1644.

Philosophical works of Descartes, Haldane ES, Ross GRT (eds.), 1967, Cambridge University Press.

Dretske F

1994.

If you can't make one, you don't know how it works.

Midwest studies in philosophy, 19:468-483.

Einstein A.

1905.

Zur electrodynamik bewegter körper. Annalen der Physik, 17:891-921.

Einstein A.

1915.

Zur allgemene relativitätstheorie und bewegungsgesetz. Sitzungberichte der Preussischen Akademie der Wissenschaften zu Berlin, 2:778-801.

Einstein A.

1951.

The meaning of relativity. Methuen: London.

Einstein A, Infeld L.

1971.

The evolution of physics: The growth of ideas from early concepts to relativity and quanta.

Cambridge University Press.

Fechner G.

1860.

Elements of psychophysics. (Adler HE, translator). Holt, Rinehart and Winston, Inc.: New York, 1966.

Fitzgerald GF.

1892.

The ether and the earth's atmosphere. Science 13:390.

Flanagan O.

1991.

The science of mind. MIT Press: Cambridge.

Frederick EC.

1985.

Synthesis, experimentation, and the biomechanics of economical movement.

Medicine and Science in Sports and Exercise, 17:44-47.

Frederick EC, Cavanagh PR.

1992.

Letter to the editor. Medicine and Science in Sports and Exercise, 24:144-145.

Friedrichs KO.

1965.

From Pythagoras to Einstein. Mathematical Association of America: New York University.

- Gagnon M.
1978.
A kinetic analysis of the kneeling and the standing starts in female sprinters of different ability. In: Biomechanics VI-B, pp.46-50. Asmussen E (ed). University Park Press: Baltimore.
- Galilei G.
1638.
Dialogues and mathematical demonstrations concerning two new sciences pertaining to mechanics and local motions. See Ascenzi, 1993.
- Galilei G.
1953.
Dialogue concerning two chief world systems-Ptolemaic & Copernican. S Drake (translator). University of California Press.
- Galilei G.
1953.
Dialogue on the great world systems. De Santillina G. University of Chicago Press.
- Galvani L.
1791.
De Viribus Electricitatis in Motu Musculari: Commentarius. In: Brazier MAB., A history of neurophysiology in the 17th and 18th Centuries. Raven Press: New York, 1984.
- Gaukroger S.
1989.
Cartesian Logic. Claredon Press: Oxford.
- Gracovetsky S.
1985.
An hypothesis for the role of the spine in human locomotion: a challenge to current thinking. Journal of Biomedical Engineering, 7:205-216.
- Green OH.
1994.
Toe wiggling and starting cars: a re-examination of trying. Philosophia, 23:171-191.
- Gross TS, Bunch RP.
1989.
A mechanical model of metatarsal stress fracture during distance running. American journal of sports medicine, 17:669-674.
- Gullberg J.
1997.
Mathematics: From the birth of number. W.W. Norton & Company: New York.
- Halliday SE, Winter DA, Frank JS, Patla AE, Prince F.
1998.
Initiation of gait in young, elderly, and Parkinson's disease subjects. Gait and Posture, 8:8-14.
- Hamblin CL.
1963.
Starting and stopping. The monist, 53:410-425.
- Hamlyn DW.
1989.
Aristotle's De Anima. Claredon Press: Oxford.

- Hatze H.
1977.
A complete set of control equations for the human musculo-skeletal system.
Journal of Biomechanics, 10:799-805.
- Helal B.
1981.
The great toe sesamoid bones: The lus or lost souls of Ushaia.
Clinical Orthopaedics and Related Research, 157(June):82-87.
- Hetherington VJ, Carnett J, Patterson BA.
1989.
Motion of the first metatarsophalangeal joint.
Journal of Foot Surgery, 28:13-19.
- Hicks JH
1954.
The mechanics of the foot. Part 2: The plantar aponeurosis and the arch.
Journal of Anatomy, 88:25-30.
- Hill AV.
1927.
Living machinery. G Bell and Sons Ltd: London.
- Hill AV
1970.
First and last experiments in muscle mechanics. Cambridge University Press, Cambridge.]
- Hollander AP.
1998.
Mechanical efficiency: problems and questions. In: Motor efficiency from muscle to man. Proceedings of the Third Symposium of the Institute for Fundamental and Clinical Human Movement Sciences. Vrije Universiteit: Amsterdam.
- Honderich T. (ed.)
1995.
The oxford companion to philosophy. Oxford University Press: New York.
- Hreljac A.
1993.
Preferred and energetically optimal gait transition speeds in human locomotion.
Medicine and Science in Sports and Exercise 25:1158-1162.
- Huang C-K, Kitaoka HB, An K-N, Chao EYS.
1993.
Biomechanical evaluation of longitudinal arch stability.
Foot and Ankle, 14:353-357.
- Hughes J, Clark P, Klenerman L.
1990.
The importance of the toes in walking.
Journal of Bone and Joint Surgery, 72-B:245-251.
- Hutton WC, Dhanendran M.
1979.
A study of the distribution of load under the normal foot during walking.
International Orthopaedics, 3:153-157.

- Hutton WC, Dhanendran M.
1981.
The mechanics of normal and hallux valgus feet—a quantitative study.
Clinical Orthopaedics and Related Research, 157:7-13.
- Inman VT, Ralston HJ, Todd F.
1981.
Human walking. Williams and Wilkins: London.
- Jammer M.
1957.
Concepts of force. Harvard University. Press; Cambridge.
- Kalin PJ, Hirsch BE.
1987.
The origins and function of the interosseous muscles of the foot.
Journal of Anatomy, 152:83-91.
- Kapandji.
1974.
Physiology of the joints.
- Kenny A.
1979.
Aristotle's theory of the will. Duckworth: London.
- Kepler J.
1621.
Mysterium cosmographicum.
- Kittel C, Knight WD, Ruderman MA.
1973.
Mechanics. McGraw-Hill: New York, pp.100-133.
- Koczocik-Przedpelska, Toebela and Gruszczynski.
1966.
See Basmajian, 1976.
- Kuhn TS.
1970.
The structure of scientific revolutions. Universtiy of Chicago Press: Chicago.
- Larsen CS.
1997.
Bioarchaeology: Interpreting behaviour from the human skeleton. Cambridge: University Press.
- Latash ML.
1998.
Neurophysiological basis of movement. Human Kinetics: Champaign, IL.
- Latimer B, Lovejoy CO.
1990.
Hallucal tarsometatarsal joint in *Australopithecus afarensis*.
American Journal of Physical Anthropology, 82:125-133.
- Lette C, Contini R.
1967.
Accelerographic analysis of pathological gait. (Technical report No. 1368.01, 1967, N.Y. University School of Engineering and Science. Cited by Inman, Ralston and Todd, 1981, p.23).

- Little JW.
1973.
On the adaptability of man's hand (with reference to the equiangular curve). *The hand*, 5:187-191.
- Lloyd BB.
1967.
World running records as maximal performances. Oxygen debt and other limiting factors. *Circulation Res.* XX,XXI, supplement 1:218-226.
- Mak P, Khaw FM, Briggs PJ, Johnson GR.
2001.
The biomechanical properties of the ligamentous restraints of the first metatarsal— an in vitro study. 18th Congress of the International Society of Biomechanics, Zurich.
- Mann RA, Hagy JL.
1979.
The function of the toes in walking, jogging and running. *Clinical Orthopaedics and Related Research*, 142:24-29.
- Mann RA, Hagy JL, White V, Liddell D.
1979.
Initiation of gait. *Journal of Bone and Joint Surgery*, 61A:232-239.
- Marti B.
1989.
Relationships between running injuries and running shoes. In: *The shoe in sport*, W Pörringer and B Segesser, Eds., Chicago, Yearbook Medical Publishers, pp. 256-265.
- McDougall W.
1911.
Mind and body. A history and defense of animism. Meuthen & Co. Ltd.: London.
- Meijer OG, Bongaardt R.
1998.
Bernstein's last paper: The immediate tasks of neurophysiology in the light of the modern theory of biological activity. *Motor Control*, 2:2-9.
- Meijer OG, Wagenaar RC, Blankendaal ACM.
1988.
The hierarchy debate: Tema con variazioni. In: O.G. Meijer & K.Roth (eds.), *Complex Movement Behaviour: 'The' motor-action controversy* (pp. 489-561). Amsterdam: North-Holland.
- Meriam JL.
1980.
Engineering mechanics. Volume 1: Statics. Volume 2: Dynamics. Wiley: New York.
- Miller CA, Verstraete MC.
1996.
Determination of step duration of gait initiation using a mechanical energy analysis. *Journal of Biomechanics*, 29:1195-1199.
- Morton DJ.
1922.
Evolution of the human foot I. *American Journal of Anthropology*, 5(4):305-336.

- Morton DJ.
1924.
Evolution of the human foot II.
American Journal of Anthropology, 7(1):1-52.
- Morton DJ.
1924.
Evolution of the longitudinal arch of the human foot.
Journal of Bone and Joint Surgery, 6:56-90.
- Morton DJ.
1930.
Structural factors in static disorders of the human foot.
American Journal of Surgery, 9:315-326.
- Morton DJ, Fuller DD.
1952.
Human locomotion and body form. A study of gravity and man.
Williams and Wilkins: Baltimore.
- Muehleman C, Bareither D, Manion BL.
1999.
A densitometric analysis of the human first metatarsal bone.
Journal of Anatomy, 195:191-197.
- Muybridge E.
1887.
Animal locomotion. (Vols. 1-11). Philadelphia: University of Pennsylvania.
- Nevin C.
1995.
The design and cadaveric assessment of a new artificial first metatarsophalangeal joint replacement for the great toe. University of Cape Town. (Master of Medicine Dissertation).
- Nevin C.
1997.
Kinematics of the first metatarsophalangeal joint in intact and surgically altered cadavers.
Foot & Ankle International, 18:132-137.
- Nevin C.
1997.
The first metatarsal: the 'Rosetta Bone' of human bipedal evolution?
In: Programme and abstracts, 27th Annual Congress of the Anatomical Society of Southern Africa, Cape Town.
- Nevin C, Wilssens J-P.
2000.
A method and apparatus for determining a flexural property of a load applied to a discretely sampled pressure sensor array. European Patent Application No. 00200568.4-1265.
- Newton I.
1687-1726.
Mathematical principles of natural philosophy. (Translated by Motte, revised by F Cajori).
- Newton I.
1730.
Opticks or A treatise on the reflections, refractions, inflections & colours of light. Dover Publications Inc., New York, 1952.

- Nicol AC.
1987.
A new flexible electrogoniometer with widespread applications.
In: Biomechanics X-B, pp.1029-1033. Jonsson B (ed). Human Kinetics: Champaign.
- Nissan M, Whittle MW.
1990.
Initiation of gait in normal subjects: a preliminary study.
Journal of Biomedical Engineering, 12:165-171.
- Oldroyd D.
1986.
The arch of knowledge: An introductory study of the history of the philosophy and methodology of science.
Methuen & Co., New York.
- Olenick RP, Apostol TM, Goodstein DL.
1985.
The mechanical universe. Cambridge University Press: Cambridge.
- Olerud C, Rosendahl Y.
1987.
Torsion transmitting properties of the hind foot
Clinical Orthopaedics and Related Research, 214:285-294.
- Panjabi MM.
1979.
Centers and angles of rotation of body joints: a study of errors and optimisation.
Journal of Biomechanics, 12:911-920.
- Panjabi MM, Goel VK, Walter SD, Schick S.
1982.
Errors in the center and angle of rotation of a joint: an experimental study.
Journal of Biomechanical Engineering, 104:232-237.
- Pennycuik CJ.
1992.
Newton rules biology. Oxford University Press: Oxford.
- Penrose R.
1989.
The emperor's new mind. Oxford:New York.
- Popov EP.
1978.
Mechanics of materials. Prentice/Hall International, Inc: London.
- Praet SFE, Wilssens J-P, Vanderhaeghen V, Lambrechts W, Schwellnus M, Vaughan C, Noakes TD.
1999.
Right vs left foot pressure dynamics during running.
Proceedings of 17th Congress of the International Society of Biomechanics, Calgary.
- Preus.
1981.
See Aristotle.
- Ralston HJ.
1960.
Comparison of energy expenditure during treadmill walking and floor walking.
Journal of Applied Physiology 15:1156.

- Rée J.
1974.
Descartes. Allen Lane (Penguin), London.
- Reimann R, Marlovits S.
1992.
Biomechanik des grosszehenbogens.
Acta Anatomica, 144:30-35.
- Robbins SE, Gouw GJ.
1991.
Athletic footwear: unsafe due to perceptual illusions.
Medicine and Science in Sports and Exercise, 23:217-224.
- Robbins SE, Gouw GJ,
1992.
Letter to the editor. Medicine and Science in Sports and Exercise, 23:145-147.
- Roberts TJ, Marsh RL, Weyand PG, Taylor CR.
1997.
Muscular force in running turkeys: the economy of minimizing work.
Science, 275:1113-1115.
- Rose J, Gamble JG.
1994.
Human walking, p182. Williams and Wilkins: Baltimore.
- Ruch JA, Banks AS.
1986.
Proximal osteotomies of the first metatarsal in correction of hallux abducto valgus.
In: McGlamry ED, ed. Comprehensive textbook of foot surgery. Vol 1, pp.195-199. London: Williams and Wilkins.
- Ruina, Coleman and Garcia.
1998.
Personal communication.
- Sammarco GJ.
1989.
Biomechanics of the foot. In: Basic biomechanics of the musculoskeletal system. Nordin M, Frankel VH. Lea Febiger, Philadelphia, pp.163-181.
- Sharkey NA, Ferris L, Smith TS, Matthews DK.
1995.
Strain and loading of the second metatarsal during heel-lift.
Journal of Bone and Joint Surgery, 77A:1050-1057.
- Shereff MJ, Bejjani FJ, Kummer FJ.
1986.
Kinematics of the first metatarsophalangeal joint
Journal of Bone and Joint Surgery, 68A:392-397.
- Shigley JE.
1977.
Mechanical engineering design. McGraw-Hill Kogakusha, Ltd.
- Soudan K, Van Audekercke R, Martens M.
1979.
Methods, difficulties and inaccuracies in the study of human joint kinematics and pathokinematics by the instant axis concept. Example: the knee joint. Journal of Biomechanics, 12:27-33.

- Stainsby WN.
1976.
Oxygen uptake for negative work stretching contractions by in situ dog skeletal muscle.
American Journal of Physiology 230:1013-1017.
- Stefanyshyn DJ, Nigg BM.
1997.
Mechanical energy contribution of the metatarsophalangeal joint to running and sprinting.
Journal of Biomechanics, 30:1081-1085.
- Stokes IAF, Hutton WC, Stott JRR.
1979
Forces acting on the metatarsals during normal walking.
Journal of Anatomy, 129:579-590.
- Stokes IAF, Hutton WC, Stott JRR, Lowe LW.
1979
Forces under the hallux valgus foot before and after surgery.
Clinical Orthopaedics and Related Research, 142:64-72.
- Torretti R.
1983.
Relativity and geometry. Pergamon Press: Oxford.
- Van Ingen Schenau GJ.
1980.
Some fundamentals of the biomechanics of overground versus treadmill locomotion.
Medicine and Science in Sports and Exercise, 12:257-261.
- Vesalius
1543.
De humani corporis fabrica.
- Vesey GNA.
1964.
Body and mind. George Allen and Unwin: London.
- Vollgraff JA.
1953.
A geometrical allegory of human life—in Jakob Bernoulli's spirit.
In: *Science medicine and history*. Underwood EA (ed.). Oxford University Press: London, pp.21-27.
- Wanivenhaus A, Pretterklieber M.
1989.
First tarsometatarsal joint: anatomical biomechanical study. *Foot and Ankle*, 9:153-157.
- Whipp BJ, Wasserman K.
1969.
Efficiency of muscular work.
Journal of Applied Physiology, 26:644-648.
- Zangari M.
1994.
Zeno, zero and indeterminate forms: instants in the logic of motion.
Australasian Journal of Philosophy, 72:187-204.

APPENDIX A

COMPUTER USER INTERFACE PANELS

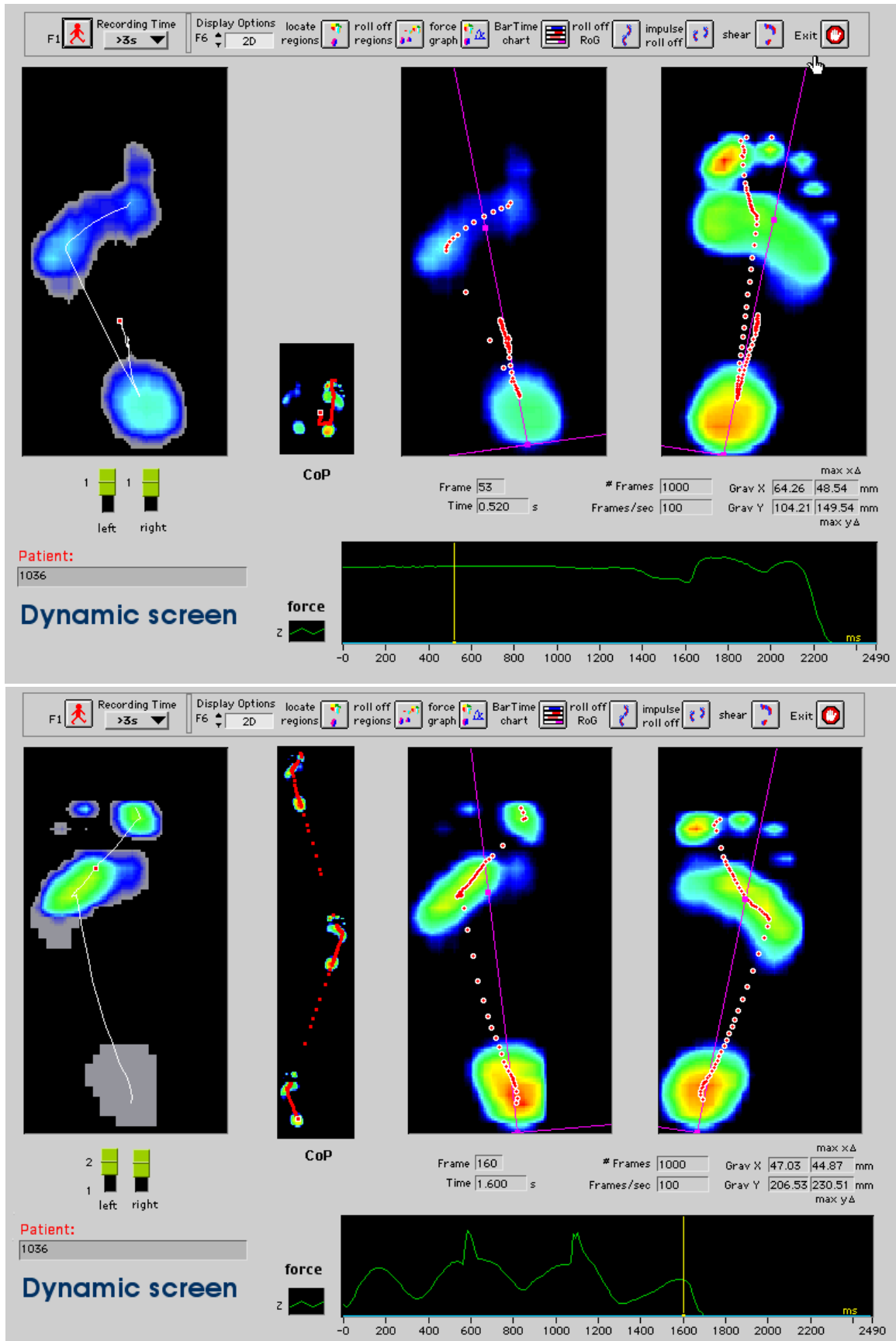

Fig. A-1. Main screen with menu bar for data processing routines. Plates 1 and 2.

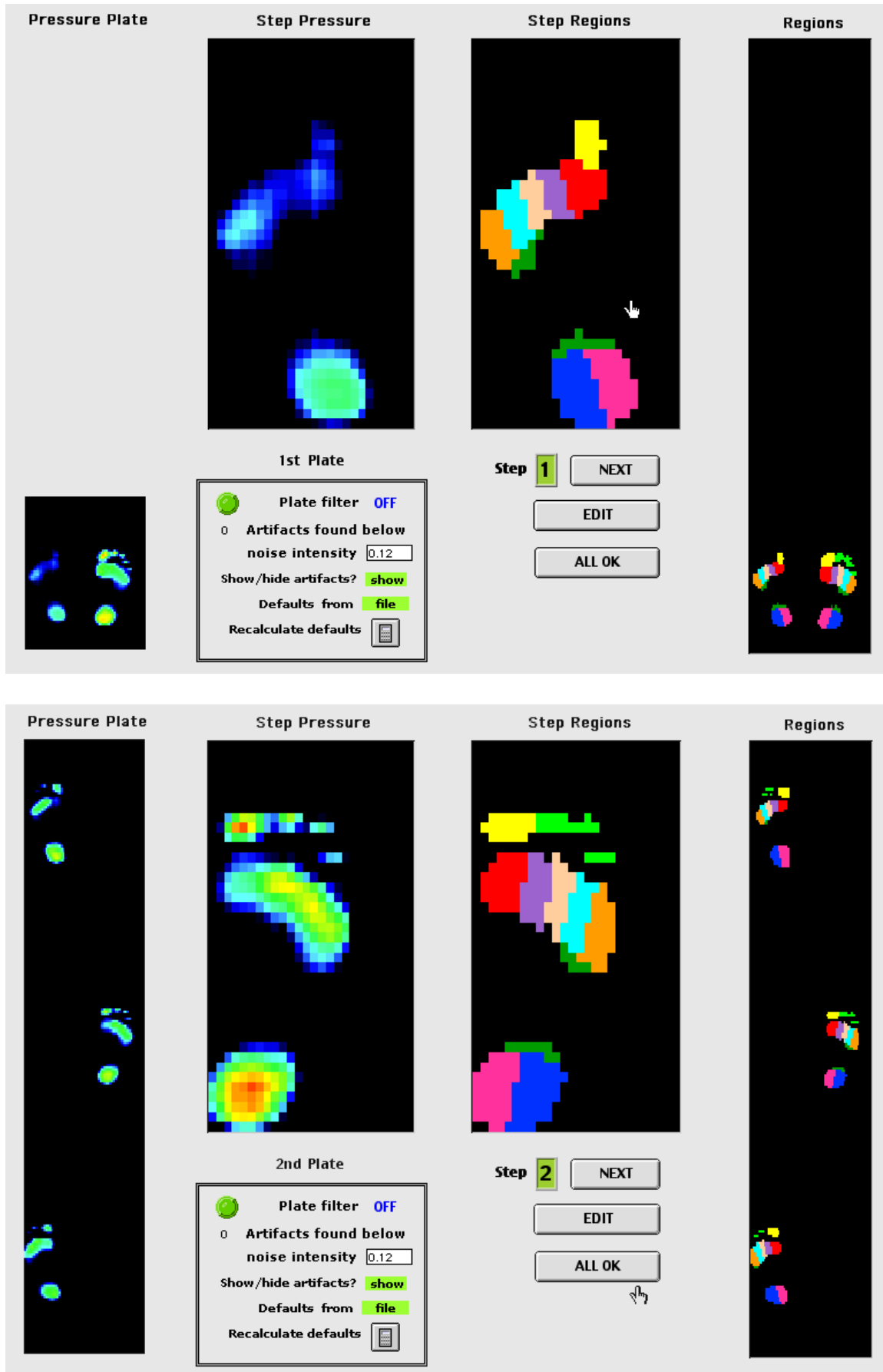

Fig. A-2. Computerized footprint identification and subdivision into 10 color-coded regions. Plate 1 and 2.

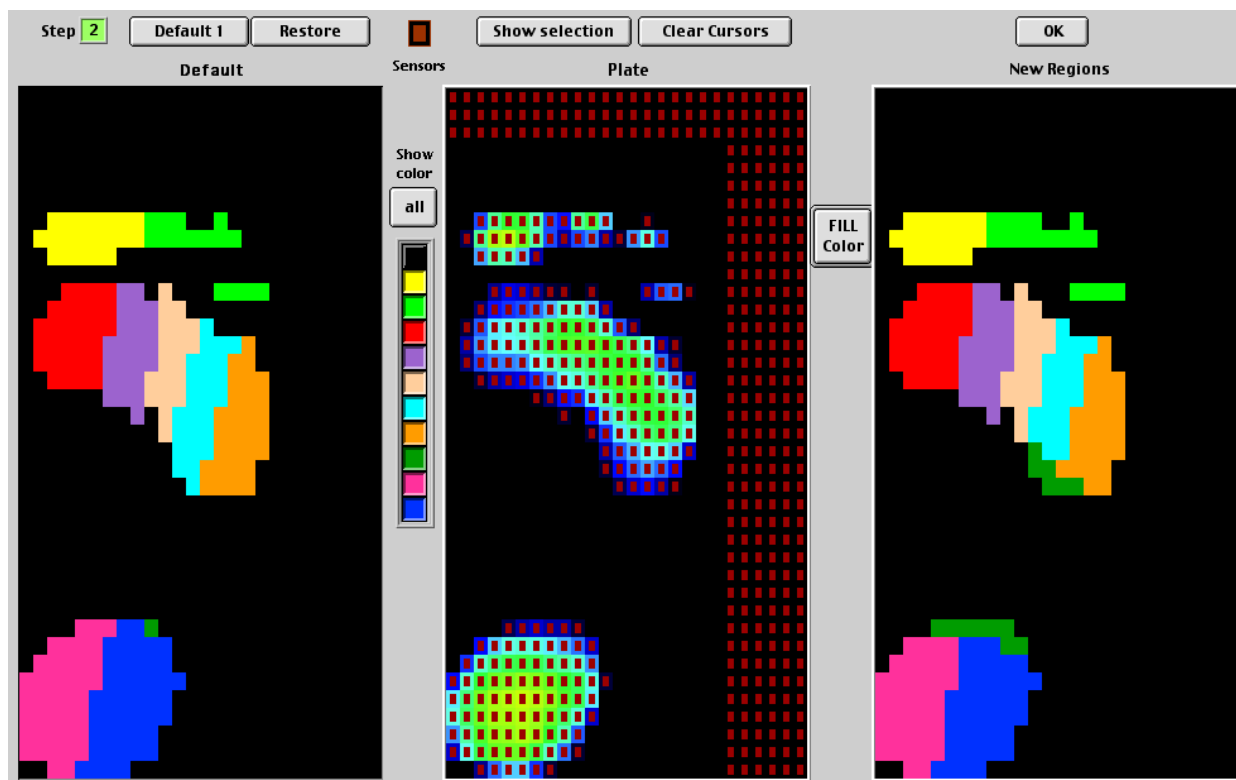

Fig. A-3. Computerized footprint region selection (left) based on the sensor pressure distribution (middle) and final sensor allocation (right).

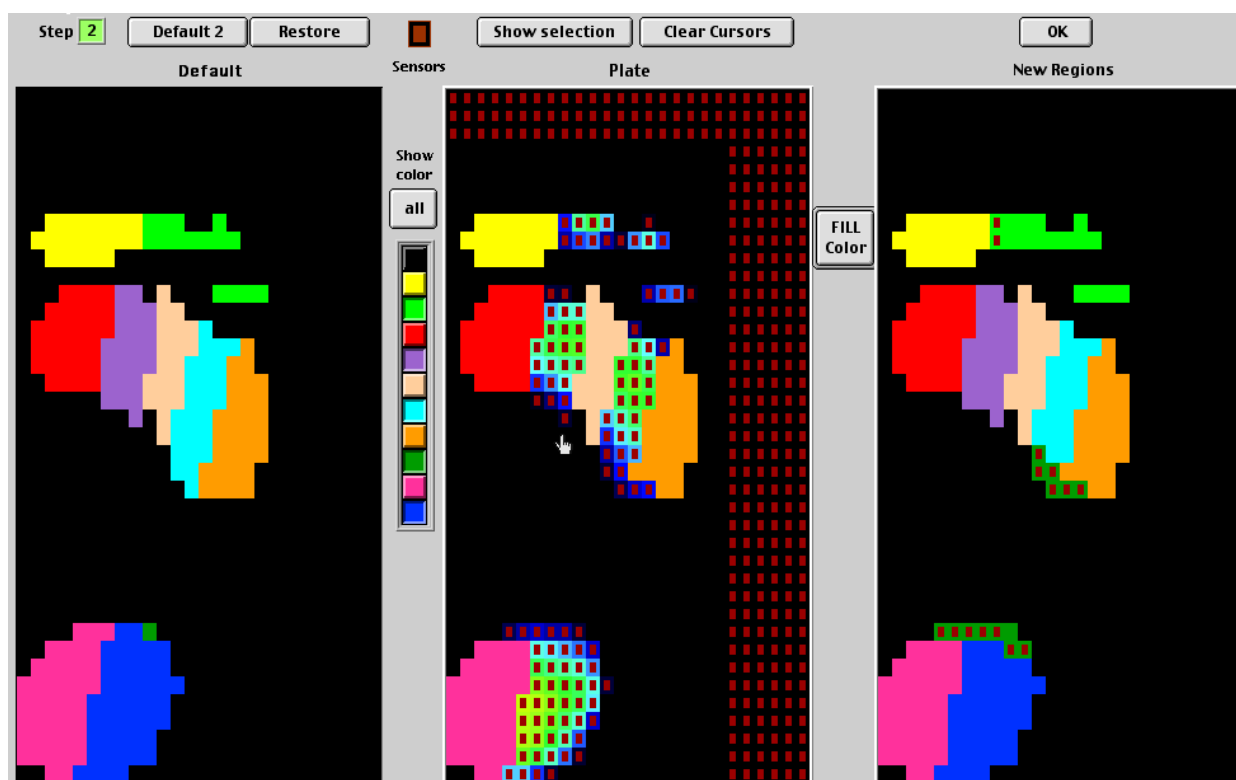
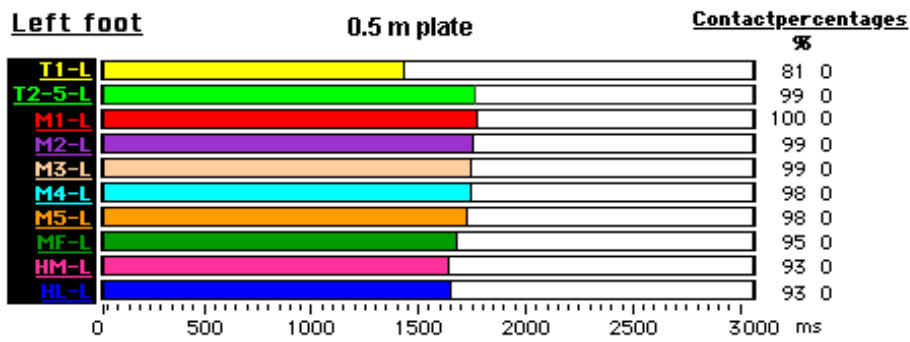
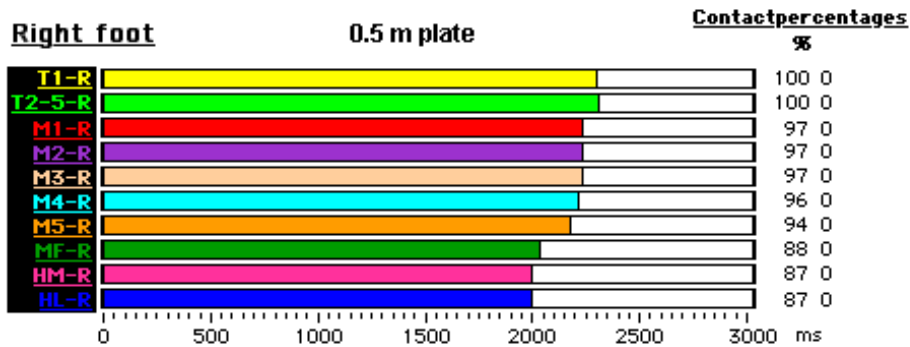

Fig. A-4. Manual footprint region editing and verification screens. The initial computerized selection is on the left. The manual editing screen in the middle shows a selection of region overlays being audited. The final region selection is on the right, with all alterations marked.



Contact time: Left foot step 1 1768 ms



Contact time: Right foot step 1 2309 ms

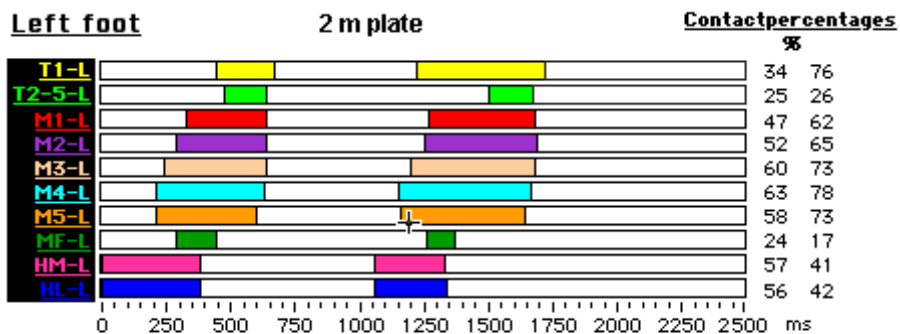

Contact time: Left foot step 1 670 ms
 step 2 658 ms

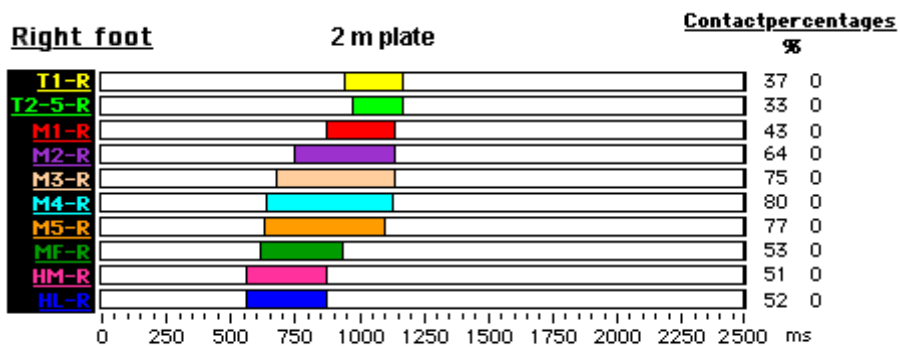

Contact time: Right foot step 1 609 ms

Fig. A-5. Contact time bar charts for the ten footprint regions taken separately from two plates. Note the initial elevation of the left great toe.

APPENDIX B
CINEMATICALLY ANIMATED AXES OF THE FOOTPRINT

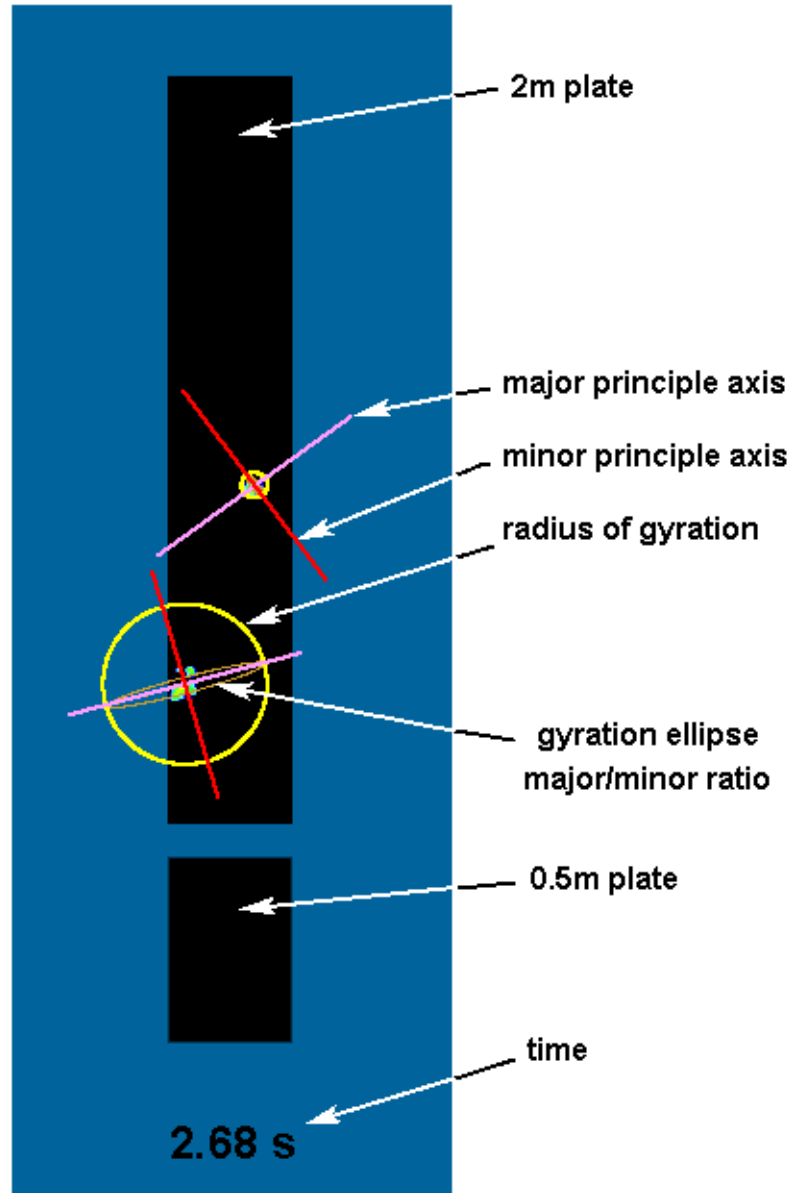

Fig. B-1. Cinematically animation of the principle axes of the footprint of a 38 year old male.

