

# Supplementary motor area structure and function: Review and hypotheses

**Gary Goldberg**

*Department of Physical Medicine and Rehabilitation, Temple University  
School of Medicine, Moss Rehabilitation Hospital, Philadelphia, Pa. 19141*

**Abstract:** Though its existence has been known for well over 30 years, only recently has the supplementary motor area (SMA) and its role in the cortical organization of movement come to be examined in detail by neuroscientists. Evidence from a wide variety of investigational perspectives is reviewed in an attempt to synthesize a conceptual framework for understanding SMA function. It is suggested that the SMA has an important role to play in the intentional process whereby internal context influences the elaboration of action. It may be viewed as phylogenetically older motor cortex, derived from anterior cingulate periarchicortical limbic cortex, which, as a key part of a medial premotor system, is crucial in the “programming” and fluent execution of extended action sequences which are “projectional” in that they rely on model-based prediction. This medial system can be distinguished from a lateral premotor system postulated to have evolved over phylogeny from a different neural source. An anatomico-physiologic model of the medial premotor system is proposed which embodies the principles of cyclicity and reentrance in the process of selecting those neural components to become active in conjunction with the performance of a particular action. The postulated dynamic action of this model in the microgenesis of a discrete action is outlined. It is concluded that although there is a great deal to be learned about the SMA, a convergence of current evidence can be identified. Such evidence suggests that the SMA plays an important role in the development of the intention-to-act and the specification and elaboration of action through its mediation between medial limbic cortex and primary motor cortex.

**Keywords:** action programs; aphasia; apraxia; attention; command neurons; evolution; limbic system; motor system; Parkinsonism; readiness potential; supplementary motor area; voluntary behavior

## 1. Introduction

It has been over three decades since Penfield and Welch (1949) first reported the presence of a second “supplementary” motor area (SMA) situated on the mesial surface of the frontal lobe of the human brain. This report and those that followed (Penfield 1954; Penfield & Jasper 1954; Penfield & Rasmussen 1950; Penfield & Welch 1951) outlined the effects on limb movement and speech produced by intraoperative electrical stimulation of the surface of this area in epileptic patients (see section 3). These findings were verified by the work of Erickson and Woolsey (1951). Further details regarding the anatomic extent, topography, and functional effects of intraoperative and chronic surface stimulation of this area in human patients have been added by the work of Talairach and Bancaud (1966), Van Buren and Fedio (1976), Woolsey, Erickson, and Gilson (1979), and Green, Angevine, White, Edes, and Smith (1980).

Recently, evidence has been converging from neuroanatomic studies (e.g. Murray & Coulter 1981a), cortical unit studies in behaving primates (e.g. Tanji & Kurata 1982), studies of movement-associated field potentials (e.g. Deecke & Kornhuber 1978), clinical case reports of the behavioral effects of damage to this area

(e.g. Laplane, Talairach, Meininger, Bancaud & Orgogozo 1977), and regional cerebral blood-flow studies (e.g. Orgogozo, Larsen, Roland & Lassen 1979) to suggest that the SMA may play a very important role in the physiology of the generation of action. It would then appear that further elucidation of the relevant structure and physiology of this mesially located motor area and of the interaction between this area and other movement-related cortical zones and subcortical structures would be important in furthering our understanding of the generation and control of action by the brain.

The approximate localization of the SMA on the mesial frontal surface of the primate and human brain is illustrated in Figure 1. Also shown are approximate localizations of several other cortical regions that enter into the following discussions.

Although this paper is not intended to be an exhaustive review, several different modes of investigation are examined and juxtaposed in an attempt to construct an overview of SMA structure and function based on an integration of these different perspectives. Other recent reviews have examined evidence pertaining to the function of the SMA in limb control (Eccles 1982; Humphrey 1979; Wiesendanger 1981) and speech (Jonas 1981). Some of the ideas presented have been briefly dealt with else-

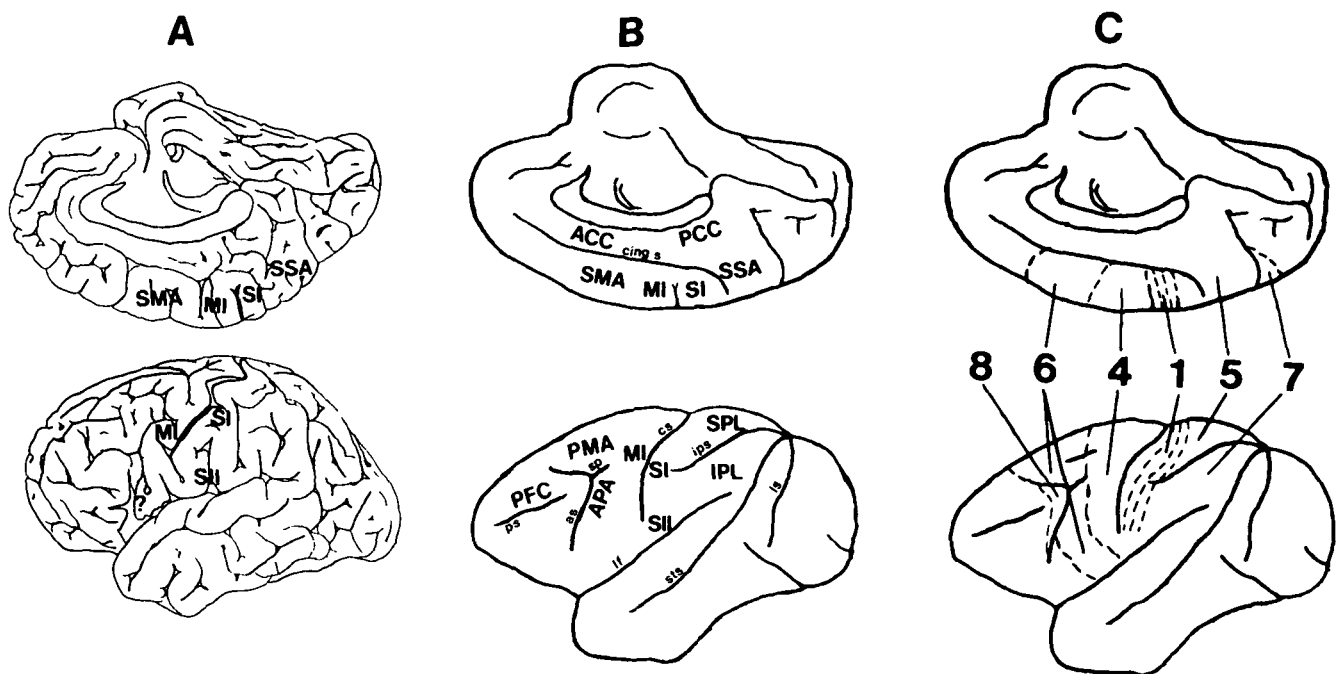

Figure 1. Functional cortical areas shown on the surface of the cerebral hemisphere of the human (A) and the primate (B) brain. The third figure in this composite (C) shows approximate localizations of Brodmann's architectonic zones. ACC: anterior cingulate cortex; APA: arcuate premotor area (intraarcuate area 6); IPL: inferior parietal lobule; MI: primary motor cortex; PCC: posterior cingulate cortex; PMA: premotor area (supraarcuate area 6); SI: primary somatosensory cortex; SII: second

somatosensory area; SMA: supplementary motor area; SPL: superior parietal lobule; SSA: supplementary sensory area; ?: possible analogue of the APA in the human brain. as: arcuate sulcus; cs: central sulcus; ps: principal sulcus; ips: intraparietal sulcus; lf: lateral fissure; sts: superior temporal sulcus; cing s: cingulate sulcus; ls: lunate sulcus; sp: spur of the arcuate sulcus. Figure 1C is adapted from Bowker & Coulter 1981, p. 207.

where (Goldberg 1984). In this paper, it is hypothesized that a medial bilaterally organized premotor system can be recognized in which the SMA functions as a central cortical region. This medial system is distinguished from a putative lateral premotor system in which the arcuate premotor area (Schell & Strick 1984) of the primate brain serves as the premotor cortical focus. Table 1 compares salient features of these two premotor systems.

The structural distinction between these two systems is based on a theory of the evolution of cortical architectonics put forward by Friedrich Sanides (1964). This theory is reviewed in section 2.1. The two systems have different anatomical relationships with the major re-entrant subcortical motor structures, the basal ganglia and the cerebellum (Schell & Strick 1984). This point is reviewed along with other recent anatomic information regarding the connectivity of the SMA in section 2.2. The functional significance of the distinction between these two systems is examined through an analysis of the reported effects of lesions of the SMA in humans and primates (section 4) as well as through an examination of the physiologic approaches to understanding SMA function through cortical unit studies in animals (section 5), regional cerebral blood-flow studies (section 6), and event-related brain potential studies (section 7). A special section deals with the role of these two motor programming systems in bimanual coordination (section 4.3). Some of the conclusions of these discussions are summarized in Table 1. In particular, it is postulated that there are two complementary systems within the cerebral hemisphere, a medial one which derives from the hippocampal formation and a lateral one which derives from the

piriform cortex. The medial system operates in "projectional" action or action that is driven forward by prediction derived from an internal model of the world composed from previous experience which permits the creation of a probabilistic model of the future (Bernstein 1967). The lateral system is part of a system responsible for recognizing and associating motivational significance with external objects and, in relation to action, operates in a responsive mode in which each action is dependent upon an explicit external input. These hypotheses are developed in more detail in the following discussions.

Finally, a new anatomico-physiologic model of the medial premotor system is presented. In this model, the SMA is considered to be a key element in a medial, bilaterally organized system which operates in concert with a variety of other cortical and subcortical structures to perform context dependent selection, linkage, initiation, and anticipatory control of a set of "precompiled" motor subroutines each of which corresponds to a particular component perceptual-motor strategy or schema of the complete action. The operation of this system in the performance of a discrete action is outlined. Action is assumed to be initiated through a developmental sequence in which increasing amounts of detail are specified as the time the action is to be expressed overtly is approached. This microgenetic process of action specification underlying the formation of an action recapitulates the evolutionary process of phylogenetic development of the relevant structures, with each participating structure manifesting its involvement through a component feature of the complete act (Brown 1977). In this context, the SMA is viewed as a crucial link within a widely dis-

Table 1. A comparison of features of the putative medial and lateral motor programming systems

	Medial	Lateral
1. Evolutionary origin	hippocampus	piriform cortex
2. Limbic cortical root	cingulate (periar-chicortical proisocortex)	insular (peripaleo-cortical proiso-cortex)
3. "Premotor" center	SMA	APA
4. Control mode	predictive (feed-forward)	responsive (feed-back)
5. Subcortical dependence	basal ganglia	cerebellum
6. Callosal dependence	high	low
7. Bimanual control	simultaneous (parallel)	alternating (serial)
8. Speech	propositional semantic dependence	nonpropositional auditory self-monitoring
9. Speech output mode	spontaneous	repetitive
10. Skilled movement performance	fluent execution of extended sequences of component actions	input-dependent, slow, segmented execution
11. Spatial dependence	far as much as near	"peripersonal"
12. Sensory dependence	primarily kines-thetic	polymodal
13. Retinal dependence	peripheral	foveal
14. Reaching to target	trajectory (navigating)	acquisition (piloting)
15. Action mode	projectional (anticipatory)	responsive (interactive)
16. Context sensitivity	internal	external
17. Computer analogy	linkage and execution of pre-compiled motor subroutines	interpreterlike, interactive, input-driven execution

tributed layered system of structures involved in the generation of action, rather than a particular site from which voluntary movements are initiated (Eccles 1982). The proposed scheme should be able to provide a framework for the study of the preparatory processes preceding movement, the way such a system participates in the microgenesis of a motor act, and the processes associated with the acquisition of a new skill. Possible experimental approaches to the testing of these hypotheses and further clarification of our understanding of SMA function are suggested.

## 2. Neuroanatomic considerations

**2.1. Architectonics.** Architectonics is the study of the histological structure of brain tissues. Campbell (1905)

completed one of the first architectonic analyses of human cerebral cortex by examining serial sections stained for nerve cell bodies and myelin (see Figure 2). He identified a zone of cortex extending anteriorly from the precentral gyrus on the ventrolateral, dorsolateral, and medial aspects of the frontal lobe, which he called the "intermediate precentral" area. Campbell's map indicates that he felt this zone to be a uniform architectonic field. He identified it as being associated with the highest level of the motor hierarchy postulated by Hughlings Jackson 20 years earlier (Jackson 1884).

G. E. Smith (1907), examining the gross appearance of fresh-cut autopsy specimens, was able to subdivide the human cerebral cortex on the basis of local variations in the whitish stripes of intracortical myelinated fibers called the bands of Baillarger. He found that Campbell's intermediate precentral area could be clearly subdivided into several architectonic fields, including an anterior superior frontal field located dorsally and medially, an intermediate frontal field located dorsolaterally, and posterior inferior and inferior frontal fields located ventrolaterally (see Figure 3).

In the most famous of architectonic maps, that of Brodmann (1908), the differentiation of a superomedial frontal field corresponding to the SMA is not as clear as it appears on Smith's map. This was later clarified by the subdivision of Brodmann's area 6 by the Vogts (Vogt and Vogt 1919).

In a recent architectonic analysis of the human telencephalic cortex, Braak (1980) has clearly separated a dorsomedial part of the premotor cortex from a ventrolateral component (see Figure 4). He has identified these two major zones anterior to the paraganglionic belt of the precentral area:

- the *inferofrontal magnopyramidal region* in front of the ventrolateral part of the paraganglionic belt (corresponding roughly to Smith's inferior frontal field B) and
- the *superofrontal magnopyramidal region* located anterior to the superior and medial aspects of the paraganglionic belt (corresponding roughly to Smith's superior and anterior superior frontal fields)

Although one can conjecture that the former zone is the human equivalent of the primate arcuate premotor area (see Schell & Strick 1984) and may possibly correspond to Broca's area, it is the latter architectonically defined cortical zone that probably comes closest to being congruent with the SMA. Braak (1980) himself suggests the correspondence of this field with the area activated in various motor tasks and identified as the SMA in regional cerebral blood-flow studies (e.g., Roland, Larsen, Lassen & Skinhøj 1980; see further discussion in section 6).

Friedrich Sanides (1964; 1970; 1972), in a careful examination of the patterns of distribution of the architectonic fields of the human frontal lobe, and in an attempt to link these patterns with functional fields revealed by neurophysiologic investigations, has proposed a theory of the evolution of the structure of the cerebral cortex and its phylogenetic differentiation. This work extended a hypothesis initially put forward by Dart (1934) following detailed studies of reptilian brain structure. This concept was further supported by the work of Abbie (1940) on the primitive mammalian brain of the monotremes. The same concept has been recently extended to the human parietal lobe (Eidelberg & Galaburda 1984).

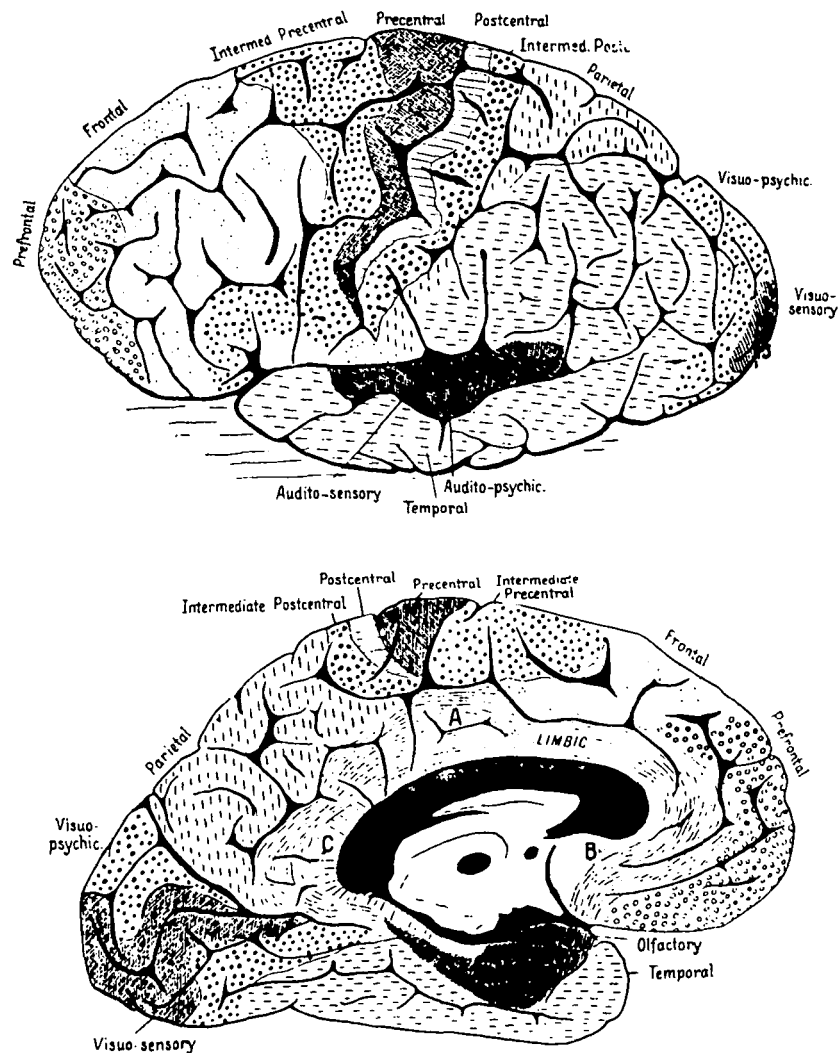

Figure 2. Architectonic map of Campbell (1905). Note his “intermediate precentral” area with both a dorsomedial and a ventrolateral expansion.

This theory views the cerebral cortex as a dynamic, fluid biologic entity whose architectonic structure has evolved across phylogeny. New architectonic fields arise from phylogenetically older regions carrying with them structural likenesses from their predecessors. Progressive systematic sequences of architectonic differentiation, referred to as “protogradations” (Sanides 1964) or “ur-trends” (Sanides 1970), can thus be recognized beginning in the oldest cortical areas and moving through progressively more recent fields. Sanides (1964, p. 280) summarized his theory with the following statement: “The gradations originating from phylogenetically older cortices determine the structure of more recent cortices. Therefore they should be recognized at the same time as evolutionary directions of differentiation.”

In applying this theory to the architectonic structure of the human frontal lobe, Sanides identified three “protogradations” (see Figure 5). One originates in the peripaleocortical proisocortex of the insular region and gives rise to the second somatosensory area (SII) and the ventrolateral part of the premotor cortex – the inferofrontal magnopyramidal region of Braak (1980) in the human brain – corresponding to the arcuate premotor area of the primate (Sanides 1972). The second protogradation originates in the periarchicortical proisocortex of the medial

wall of the frontal lobe, the anterior cingulate area. This medial protogradation then proceeds superiorly on the medial surface and laterally over to the external surface of the hemisphere. The two protogradations interact on the lateral aspect of the hemisphere at the level of the principal sulcus in the primate brain and the inferior frontal sulcus in the human brain. On the inferior surface of the frontal lobe, the two protogradations meet in the area of the prefrontal orbital region. The SMA can thus be considered part of the medial protogradation, a paralimbic “protomotor” zone derived from the anterior cingulate cortex (Sanides 1964). Similarly, the arcuate premotor area, part of the parainsular protogradation, may be considered a lateral “protomotor” zone (Sanides 1964; 1972). Sanides states:

considering our ur-trends of differentiation in evolution from archicortex via the cingulate gyrus medially and from paleocortex via the insula laterally, it was conceived that the supplementary motor representation . . . is an earlier stage of motor control, and the second somatic sensory representation is an earlier stage of sensory control than the respective classic representations. (Sanides 1970, p. 163)

It is thus tempting to speculate that the fundamental dualism of architectonic evolution created by these two



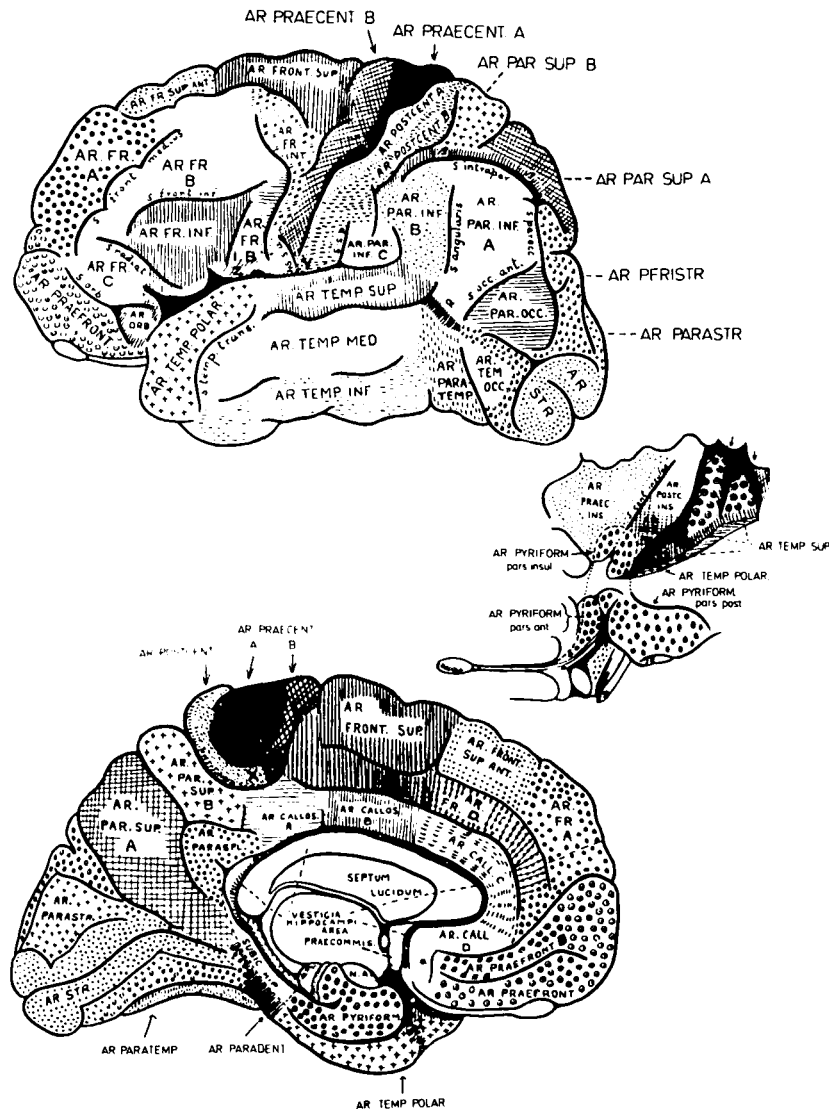

Figure 3. Architectonic map of Elliot Smith (1907). Note the separate dorso-medial (Ar. front. sup. and Ar. fr. sup. ant.) and ventrolateral (Ar. fr. inf.) fields extending rostrally from the precentral area.

simultaneously developing coronal protogradations gives rise to a dualism of limbic-cortical systems and thus dual channels through which sensory input can be neocortically processed and associated with limbic structures (Bear 1983; Ungerleider & Mishkin 1982), and through which action can likewise be generated (see also Trevarthen 1968). It is this idea, as it relates to the regions of the brain that organize action, that is elaborated into the major hypothesis developed in this paper.

The architectonic concept of evolution of cortical structures from separate sources has some interesting implications for connectivity which appear in section 2.2. Sanides (1970; 1972), for example, recognized the relationship between his theory and the dual nature of prefrontal connectivity noted by Nauta (1964). In the primate brain, the region of prefrontal cortex medial and superior to the principal sulcus tends to project medially into the cingulum whereas the region ventrolateral to the principal sulcus tends to project with fibers from the orbital prefrontal system toward the anterior temporal lobe. Furthermore, connections between the prefrontal-premotor regions and parietal cortex seem to be orga-

nized in such a way that the areas ventrolateral to the intraparietal sulcus are most heavily connected with the areas ventrolateral to the principal sulcus in the frontal lobe, whereas the areas medial and dorsal to the intraparietal sulcus tend to project most strongly to the frontal areas dorsal and medial to the principal sulcus (Petrides & Pandya 1983).

There is a third and more recent protogradation identified by Sanides which begins with the classic primary motor cortex (MI) and then proceeds poleward in the anterior direction. Thus, MI is considered to have appeared much later in the evolution of frontal lobe architectonic structure than the previous two protogradations. Sanides (1964) postulated that the primary motor cortex is a relatively recent cortical structure which has evolved for the purpose of controlling discrete fractionated distal contralateral movements, a function appearing late in the evolution of mammalian species and best developed in humans. Sanides (1970, p. 202) suggested that the paralimbic-parainsular neocortical growth rings of the SMA and the ventrolateral premotor areas "serve a general tetrapod function," whereas the

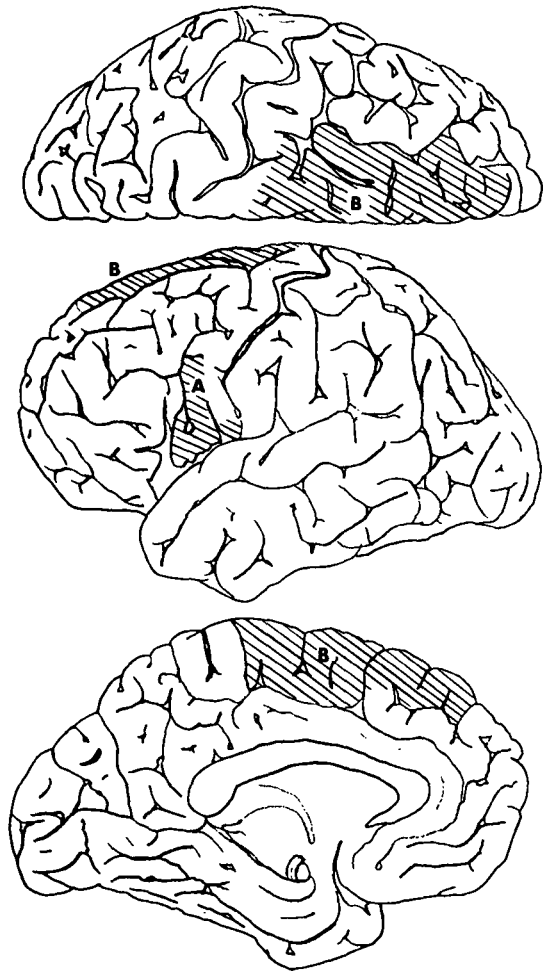

Figure 4. Architectonic map of Braak (1980). Note two separate frontal fields anterior to the paraganglionic belt of the precentral area: the inferofrontal magnopyramidal region (A) and the superofrontal magnopyramidal region (B). Adapted from Braak (1980).

new sensorimotor representation of the classic areas is related to further adaptation to terrestrial life which required the limbs – particularly the forelimb – to be released from “compulsory tetrapody” in order to serve independent adaptive functions, for example, in feeding and in using tools.

It might be argued that the appearance of a phylogenetically more recent primary motor cortex may have relegated the medial “protomotor” SMA to a vestigial role. It would appear more likely, however, that the primary motor cortex arose as a necessary *extension* of the more rudimentary SMA in response to evolutionary “pressure” pushing toward the development of increasingly lateralized distal dexterity and coordinated, prehensile skills. The dolphin, clearly not subject to the evolutionary pressure peculiar to terrestrial life, has a brain that, despite an advanced gyral folding pattern of the cortical mantle, has no evidence of the development of a hypergranular core – the architectonic marker of MI – on the convexity of the hemisphere; instead, the cortical development appears to have been arrested at the parainsular–paralimbic stage of development (Morgane,

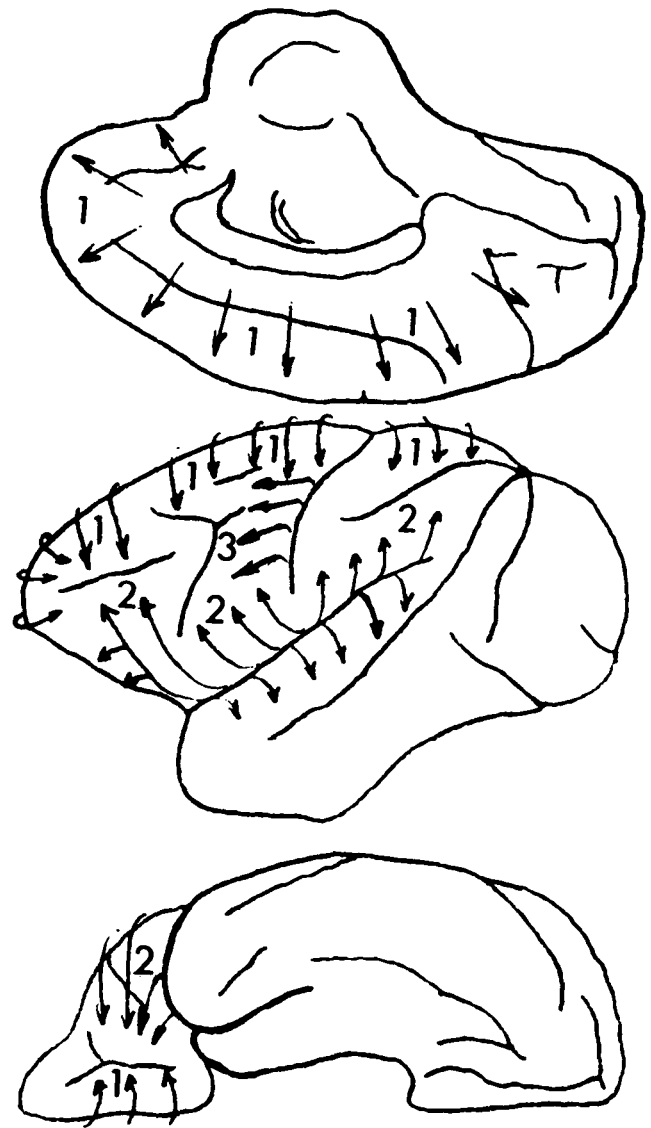

Figure 5. The protogradations of Sanides (1964; 1970). The three directions of neocortical differentiation within the frontal lobe are noted on this diagram of the primate cerebral hemisphere: (1) the medial protogradation taking origin in the cingulate cortex; (2) the lateral protogradation taking origin in the insular cortex. (3) the most recent protogradation beginning in the ganglionic core of the precentral area and proceeding poleward.

Galaburda & Jacobs 1983). Viewed as an *extension* of more medial protomotor cortex, which, through its concentration of large pyramidal cells, provides a direct, multiply-parallel, refined capability for phasic control of extremity musculature, MI would be necessary for the performance of more complex and phylogenetically more recent motor behaviors in animals with developed dextrous limb function. A more basic infrastructure of action in which the aspects controlled by MI are embedded, may be conveyed via the medial (and lateral) protomotor cortex.

What is the functional nature of such a basis for movement for which the medial and lateral protomotor areas may be responsible? A major clue lies in the recognition of a fundamental separation of function based on the

structural derivation of the two protomotor areas from different brain sources – namely, the hippocampus as the source from which the medial protomotor area (SMA) developed, and the piriform cortex as the source from which the lateral protomotor area (APA) was derived.

**2.2. Connectivity.** If we define the term “premotor” to mean the areas of frontal cortex rostral to the primary motor cortex that contain a substantial proportion of cells projecting monosynaptically to the primary cortex in a topographically organized fashion, then the SMA can be considered a “premotor” cortex. Horseshoe peroxidase (HRP) retrograde transport studies have examined the nature of the projection pattern to the primary motor cortex in the primate brain (Matsumura & Kubota 1979; Muakkassa & Strick 1979; Pieper, Goldring, Jenny & McMahon 1980). These HRP studies demonstrate that the major ipsilateral projection to the primary motor cortex arises from the SMA. Less intense projections to the primary motor cortex appear from the ventrolateral premotor area in the posterior bank of the arcuate sulcus, labeled the “arcuate premotor area” (APA) by Strick and his coworkers. These findings have recently been studied in an elegant anatomic study using three different retrograde fluorescent tracers injected into the face, hand, and foot areas of MI (Godschalk, Lemon, Kuypers & Rondan 1984). This study clearly demonstrates the two routes of access to MI: from the SMA and the APA. It further shows that whereas the SMA projects to all three injected zones, the APA projects only to face and hand areas of MI, with those neurons projecting to the hand area being located in the posterior bank of the inferior limb of the arcuate sulcus and around the arcuate spur more rostral and dorsal to the adjacent APA area on the ventrolateral aspect of the precentral gyrus projecting to the face zone. Some projections to MI arise from dorsolateral area 6, dorsal to the upper branch of the arcuate sulcus, but these tend to come from caudal zones contiguous with MI. This, along with evidence from architectonic studies, patterns of connectivity, and stimulation mapping studies, has led Wiesendanger (1981) to propose that dorsolateral area 6 consists of structurally and functionally distinct rostral and caudal subdivisions. The caudal subdivision can be considered a rostral microexcitable extension of primary motor cortex which relates to proximal and axial muscle activation (Murphy, Kwan, Mackay & Wong 1978) with corresponding corticospinal projections (Murray & Coulter 1981a). The rostral extent can be considered motor association cortex with sparse direct connection to motor cortex and prefrontallike connectivity (Künzle 1978) and physiologic activity (Sakai 1978; Weinrich & Wise 1982). This zone can be clearly distinguished from the SMA by its relative lack of direct connections to MI (Matsumura & Kubota 1979; Muakkassa & Strick 1979). It may represent a dorsolateral elaboration of the SMA with convergent connections to the SMA (Künzle 1978), which is particularly activated with movements into extrapersonal space (Roland, Skinhøj, Lassen, & Larsen 1980).

It is of interest to consider how patterns of anatomic connection may help to differentiate the SMA from the APA in the primate brain. Künzle (1978) found that, although both areas project to MI, SMA tended to relate

to the medial prefrontal area in front of it whereas the infraarcuate part of area 6, roughly corresponding to an area of cortex around the APA, related to ventrolateral prefrontal cortex below the principal sulcus and the orbital prefrontal cortex. Furthermore, this ventrolateral premotor area was connected with the insular and inferior temporal cortex. The SMA has significant corticospinal projections, whereas the APA does not (Künzle 1978). Furthermore, relationships with parietal cortex are quite different (Petrides & Pandya 1983). Although the SMA has major connections to area 5 of the *superior parietal lobule* (Bowker & Coulter 1981), the APA receives somatosensory projections from SII and combined visual and somatic inputs from the *inferior parietal lobule* (Godschalk et al. 1984; Petrides & Pandya 1983) as well as projections from auditory association cortex (Galaburda & Pandya 1982). Clearly, the APA has access to a wealth of processed polymodal sensory information, a point consistent with the hypothesis developed in this paper and with the physiologic response characteristics of APA (Rizzolatti, Scandolara, Matelli & Gentilucci 1981a; 1981b). Thus the SMA and the APA may be rather unambiguously differentiated on the basis of their patterns of connectivity (see Table 2 and Figures 6 and 7).

Evidence has recently been accumulating to confirm the suggestion that the SMA projects directly into the corticospinal tract (Biber, Kneisley & LaVail 1978; Jones & Wise 1977; Macpherson, Marangoz, Miles & Wiesendanger 1982; Murray & Coulter 1981a). Murray and Coulter (1981a) have reported finding a significant direct projection (7.5% of all projecting neurons) from the SMA into the corticospinal tract using HRP injections into different levels of the spinal cord. SMA projections, along

Table 2. Two routes to primary motor cortex (MI)

	SMA	APA
1. Direct corticospinal projections	yes	no
2. Areas of significant projection in MI	leg arm face	arm face
3. Cortical relationships	SPL SSA SI lateral area 6 medial-dorso-lateral prefrontal anterior cingulate	IPL SII frontoparietal operculum insula orbital prefrontal auditory association peristriate via caudal IPL
4. Unit response to peripheral field stimulation	limited	visual and somatic fields
5. Major thalamic nucleus	VL <sub>o</sub>	X
6. Subcortical dependence	basal ganglia	cerebellum



with those from MI, terminated predominantly in the gray matter of the ventral horn, in contrast to corticospinal projections from the sensory cortices which were directed predominantly to the dorsal horn.

A report by Macpherson et al. (1982) confirms anatomically and functionally that the SMA is coupled directly to spinal centers. These authors injected HRP into cervical and lumbosacral levels of *macaca fascicularis* after mapping the extent of the SMA functionally by intracortical microstimulation (ICMS). HRP-labeled cells were subsequently found in the microexcitable parts of the SMA.

In a study of the corticocortical relationships of the SMA, Bowker and Coulter (1981) found a major reciprocal relationship between the SMA and the medial extension of area 5 on the mesial face of the parietal lobe, an area corresponding to the "supplementary sensory area" (SSA) identified by Penfield and Jasper (1954) in the human brain and more recently examined by Murray and Coulter (1981b). Reciprocal interconnections with lateral area 5, MI, and the more lateral parts of area 6 were identified. The SMA also received a nonreciprocal projection from the primary somatosensory cortex (SI).

The significant relationship with the SSA is of some interest. It is possible that with the successful application of Sanides's architectonic theory to the parietal lobe (Eidelberg & Galaburda 1984), the SSA can be viewed as a focal paralimbic region which is part of the periarchicortical medial protogradation developing from posterior cingulate cortex at the base of the parietal lobe. By applying the same logic Sanides used to analyze the frontal lobe, one can consider the SSA as a parietal analog of the SMA with which it coevolved. The pattern of connectivity of the SSA is very similar to that of the SMA (Murray & Coulter 1981b); in addition the two areas strongly interconnect (Bowker & Coulter 1981). The function of the SSA remains obscure.

Some very important clues about the organization of these structures may be obtained through a detailed analysis of the corticothalamic relations of these areas since both sensory inputs to the cortex and reentrant input from the basal ganglia and the cerebellum are linked to the cortex through thalamic connections. Recent evidence regarding the connections of the "motor" thalamus forms an important basis for the construction of the anatomico-physiologic model of the medial motor programming system presented in section 9.

It is becoming apparent from anatomic and electrophysiologic investigation that pallidal and cerebellar motor reentrant inputs as well as lemniscal inputs are directed to anatomically distinct thalamic targets (Hendry, Jones & Graham 1979; Jones 1981) and that these target zones then project differentially to the cortex. This has recently been shown with electrophysiologic techniques (Yamamoto, Hassler, Huber, Wagner & Sasaki 1983).

Kalil (1978) studied the afferent and efferent linkages of the ventral thalamic nuclei using radioactive tracers in rhesus monkeys. The SMA and the mesial prefrontal cortex rostral to it were found to be major cortical projection zones of the VL<sub>o</sub> and VA nuclei. MI received its thalamic connections from VL<sub>c</sub> and rostral VPL<sub>o</sub>. Projections from VL<sub>c</sub> tended to go to more rostral aspects of area 4 and contiguous caudal parts of area 6. Efferent fibers

from the deep cerebellar nuclei were found to terminate in VPL<sub>o</sub>, VL<sub>c</sub>, and VL<sub>o</sub>, whereas lemniscal efferents terminated primarily in VPL<sub>c</sub>. Basal ganglia outflow via projections from the internal pallidal segment has been found to be directed to thalamic nuclei VA and VL<sub>o</sub> (DeVito & Anderson 1982). Tracey, Asanuma, Jones, and Porter (1980) examined the relationship of different parts of the ventral thalamus with sensorimotor structures. HRP injections into VPL<sub>o</sub> and VL<sub>c</sub> were found to label cells in the deep cerebellar nuclei whereas injections into VL<sub>o</sub> led to retrograde labeling of cells *only* in the internal pallidal segment. Schell and Strick (1984) have recently examined the thalamic connections of the SMA, the arcuate premotor area, and MI, using HRP injections into these areas of the *Macaca mulatta*. Little or no overlap between thalamic projection zones was found. Whereas the SMA was connected most densely with the VL<sub>o</sub>, an area of the thalamus receiving projections almost exclusively from the globus pallidus, the APA was connected most intensively with the medial thalamic nucleus X, an area that receives input primarily from the caudal parts of the deep cerebellar nuclei (Kalil 1981). MI was primarily connected with the VPL<sub>o</sub>, a thalamic nucleus that also receives primarily cerebellar input. It is thus apparent that the two premotor areas, the SMA and the APA, can be distinguished on the basis of subcortical dependence: The SMA receives its reentrant drive from outflow from the basal ganglia via the internal pallidal segment connections to the thalamus; the APA (along with MI) receives its reentrant drive from outflow from the deep cerebellar nuclei via their thalamic projections.

These anatomic studies of pallidothalamic and cerebellothalamic relationships and the corresponding thalamocortical relationships have been examined recently using electrophysiologic techniques in primates (Yamamoto et al. 1983). This study indicated that inhibitory inputs from the globus pallidus reached the lateral-dorsal-rostral part of the primate motor thalamus, whereas the stimulation of the deep cerebellar nuclei produced responses in the medial-ventral-caudal region. Convergence of cerebellar and pallidal projection to single thalamic cells was seen only rarely. These results have been recently confirmed in another laboratory (Huffman, Felpel & Lum 1984). Uno, Ozawa, and Yamamoto (1978) reported that, in the cat, those thalamic cells that showed evidence of inhibitory input from the entopeduncular nucleus – the feline equivalent of the internal pallidal segment – could be activated antidromically by stimulating the medial precruciate cortex, a zone that may correspond to the SMA. A similar electrophysiologic examination in the primate would be very important and could add critical support to the evidence suggesting that the SMA interacts directly with that part of the thalamus being inhibited by pallidal projections whereas the APA interacts with cerebellar-dependent thalamic neurons (Schell & Strick 1984).

Some of the cortical connectivity pattern between the SMA, the APA, and related cortical zones within the hemisphere is shown in Figure 7.

Neuroanatomic and functional evidence is accumulating to support the notion that the cingulate cortex, long felt to be a major site of interaction between the limbic system and the rest of the cerebral cortex (Papez 1937), may be considered to have distinct, but reciprocally



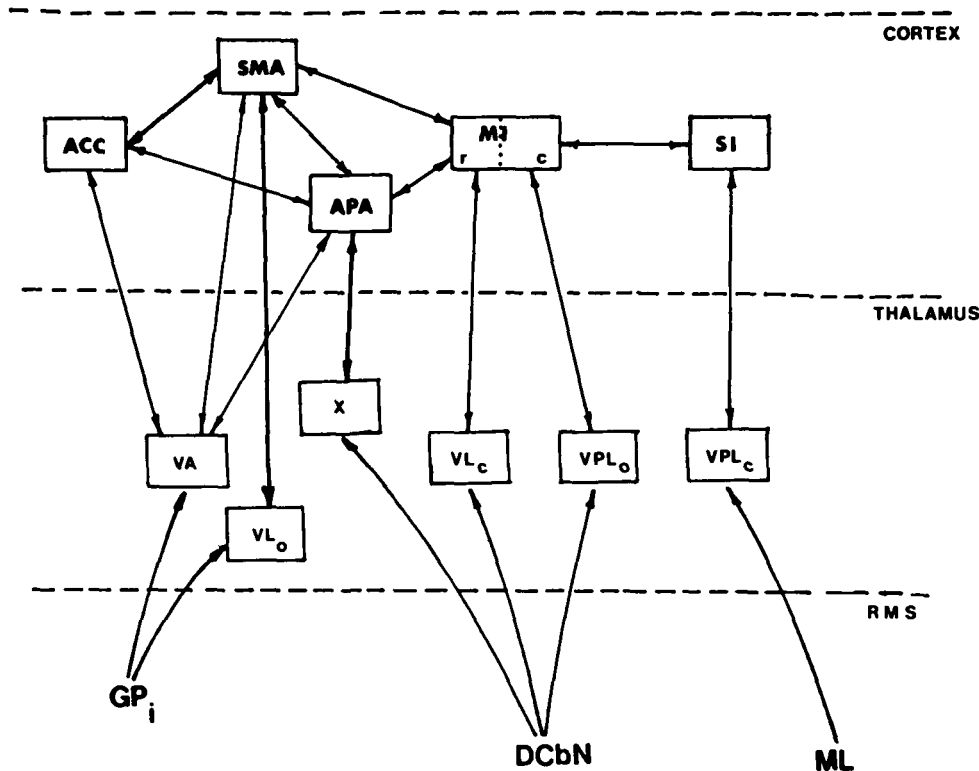

Figure 6. Connections between subcortical structures, thalamic nuclei, and functional sensorimotor cortical areas. The first tier shows the cortical areas and their interconnections, the second the thalamic nuclei found to relate anatomically to the cortical areas (see Baleyrier & Mauguière 1980; Kalil 1981; Schell & Strick 1984), and the third the connections of the reentrant motor subsystems (RMS) and the medial lemniscus (ML). Abbreviations as in Figure 1 with the addition of  $GP_i$ : globus pallidus, internal segment; DCbN: deep cerebellar nuclei. Note that the reentrant input from the  $GP_i$  interacts with ACC and SMA whereas that from the DCbN relates to areas of the ventral thalamus connected to the APA and MI. Inputs from DCbN and  $GP_i$  connect with anatomically distinct zones of the thalamus which, in turn, relate to distinct cortical areas. MI is subdivided here into rostral (r) and caudal (c) components.

interconnected anterior and posterior subdivisions (Baleyrier & Mauguière 1980; Vogt, Rosene & Pandya 1979).

The anterior zone of the cingulate cortex would appear to be an area of high-level efferent integration linked with cortical and subcortical regions (Baleyrier & Mauguière 1980). Stimulation of this region in human epileptic patients produced various forms of highly integrated but isolated motor fragments somewhat reminiscent of those produced with stimulation of the SMA (Talairach, Bancaud, Geier, Bordas-Ferrer, Bonis, Szikla & Rusu 1973). The elicited movements appeared to be movement "primitives" or "subroutines" that could be linked together in context to perform complete movement sequences. With stimulation of the anterior cingulate it was noted that when a movement was elicited it was associated with a spread of excitation to the adjacent frontal medial cortex – most probably including the SMA – and along the cingulate cortex of the same hemisphere as well as across to the corresponding zone of the contralateral cingulate gyrus. With this spread of excitation and the appearance of a motor response there developed a steady 3-8 Hz rhythm in the EEG which was maximal at the vertex (Talairach et al. 1973).

The rostral extension of the anterior cingulate cortex has been studied to determine its role in the control of vocalization in the primate (Aitken 1981; Jürgens &

Müller-Preuss 1977; Jürgens & von Cramon 1982). Jürgens and Müller-Preuss (1977) found that all cortical areas from which vocalization in the primate could be elicited through electrical stimulation received direct inputs from the anterior cingulate cortex. They suggested that the anterior cingulate cortex may not be responsible for the actual specifics of the vocalization but rather maintained thresholds for a particular vocalization across the network, thus controlling the activation of specific behaviors. Jürgens and von Cramon (1982, p. 246) postulated that "anterior cingulate cortex seems to function as a drive-controlling mechanism which determines by its activity the readiness to phonate as well as the intensity."

It could be argued that this is the general role of the anterior cingulate cortex as it relates to *all* action (e.g. Gray 1982a), that is, the control of drive-dependent thresholds and a generalized specification of intensity or "amplitude" of a voluntary act. The major importance of the SMA would then be the intermediary role it could play between the generalized internal drive control manifested through the anterior cingulate cortex and the selection and execution of specific action sequences or motor strategies performed downstream from this point, by virtue of its anatomic position between the anterior cingulate cortex on the one hand and the primary motor cortex on the other.

The SMA may be considered to be "protomotor" para-

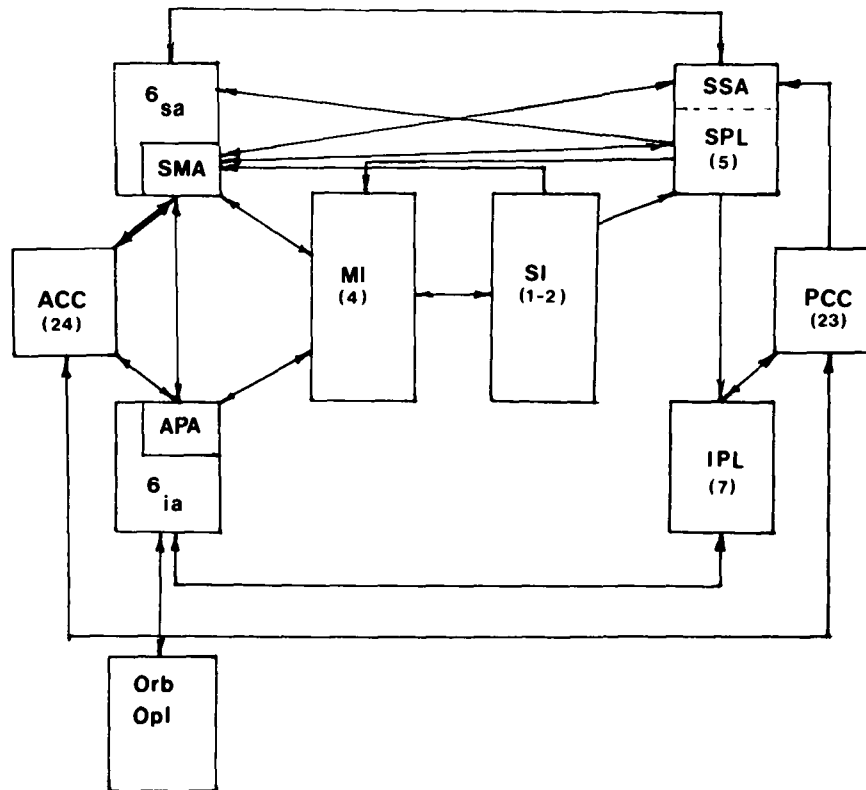

Figure 7. Some of the major cortical relationships of the SMA and related areas shown schematically. Abbreviations as in Figure 1 with the addition of  $6_{sa}$ : supraarcuate component of area 6;  $6_{ia}$ : infraarcuate component of area 6; Orb: orbital frontal cortex; Opl: frontal opercular and insular cortex. Adapted from Jones (1983).

limbic cortex (see section 2.1; Brown 1977; Sanides 1964) located at the confluence of anterior cingulate, superior mesial prefrontal, dorsolateral area 6, and mesial primary motor cortices. It is reciprocally interconnected with the anterior cingulate cortex (Damasio, Van Hoesen & Vilensky 1981) and, as discussed in the previous section, may have “evolved” from ventrally adjacent limbic periarchicortical proisocortex (Sanides 1970). It is part of an efference-synthesizing corticolimbic-reticular system (Watson, Miller & Heilman 1978) which focuses limbic outflow onto motor executive regions (Damasio et al. 1981), thus linking intention formation to the programming and execution of specific actions. Disorders of this system have been shown to lead to a neglect syndrome based, not on a perceptual inability, but rather on a response deficiency (Watson, Heilman, Cauthen & King 1973; Watson et al. 1978). Intimately associated with this system is an afferent-regulating corticolimbic-reticular network that controls the rostral flow of sensory information and thus attentional and perceptual processes, in part through the selective subcortical “gating” of afferent flow and, in part, through the modulation of the responses of the sensory association areas to their afferences (Heilman & Valenstein 1979; Mesulam 1981; Robinson, Goldberg & Stanton 1978; Roland 1981; 1982; Skinner & Yingling 1977; Watson, Valenstein & Heilman 1981). On the basis of differences in connectivity patterns (Baladyier & Mauguière 1980; Vogt et al. 1979), anterior cingulate cortex may be more closely related to the efference-synthesizing system, whereas posterior cingulate cortex may be more directly involved in the afferent-regulating network (see also Watson et al. 1981). Through

multiple linkages and convergences at many different levels between these two systems, an action-perception cycle (Neisser 1976) is formed. One of the major sites for such integration is the prefrontal cortex.

Fuster (1980) has proposed that the prefrontal cortex is necessary for formulating temporally integrated, context-dependent behavioral structures for goal-oriented action, particularly in novel or complex circumstances. Not only does it operate to maintain temporal contiguity, it also acts to suppress interferences or competing tendencies so that goal orientation can be maintained. The orbital prefrontal cortex is particularly important in response control – the suppression or inhibition of interfering tendencies to respond to external inputs when such responses would disrupt purposive behavior. It is part of a system that includes the temporal cortex and the amygdala, which forms a “neural complex essential for the appraisal of the motivational significance of objects” (Fuster 1980, p. 70). It can be argued on the basis of information reviewed in the previous section that the APA should be considered a node in this particular network whereas the SMA is not. It might also be postulated that the component elements of this functional network have evolved from the piriform-derived paleocortical root and, as such, would be part of the lateral protogradation. Similarly, the dorsomedial prefrontal cortex above the principal sulcus of the primate brain may be considered part of the medial protogradation and thus a separate functional network derived from the hippocampal-derived archicortical root. This part of prefrontal cortex is particularly involved in the “integration of spatially and temporally discontinuous elements in

cognition" (Fuster 1980, p. 56) and thus has an important cognitive-perceptual role to play in the context-dependent performance of learned and instinctual behaviors. The SMA, along with the supraarcuate part of area 6, is associated with the dorsal and medial prefrontal system. This system tends to project medially into the cingulum toward retrosplenial and parahippocampal regions as opposed to the ventral and lateral areas of the prefrontal cortex which tend to project into the temporal lobe (Nauta 1964). Thus, what Nauta (1964, p. 405) noted as "a certain dualism in the prefrontolimbic association," may translate into a dualism in functional systems in the hemisphere and a related dualism in the premotor regions, all of which may relate to the manner in which the neocortex has evolved.

To summarize, the SMA is an area of cortical convergence receiving projections from primary and secondary somatosensory areas as well as from parietal association cortex. It lacks extrastriate inputs (Pandya & Kuypers 1969) which do reach the arcuate premotor area via the inferior parietal lobule (area 7). Such visual inputs may also distinguish the SMA from the APA and may be important for certain functions of the APA in visually dependent behaviors (Godschalk, Lemon, Nijs & Kuypers 1981; Kubota & Hamada 1978). The SMA is a zone of internal convergence within the premotor regions (Künzle 1978). It is linked reciprocally with the anterior cingulate part of "limbic" cortex and would appear to be a major site at the cortical level through which limbic outflow may influence cortical and subcortical motor structures (Damasio et al. 1981). Each SMA receives input from MI as well as other parts of premotor and prefrontal cortex and then projects *bilaterally* back to MI (though more densely to ipsilateral MI), to the contralateral SMA, and to various subcortical structures. It sends projections bilaterally to the striatum and also projects strongly to the cerebellar cortex via the pontine nuclei. The SMA also sends direct projections to the spinal cord. Through these projections the SMA could potentially participate in the coordination of both axial and distal musculature, ipsilaterally as well as contralaterally. Its pattern of inputs would indicate that the SMA has available to it sensory data conveying information about the external environment and the body schema (though without the visual input available to the APA) required for setting up and adapting motor programs, as well as limbic-mediated inputs via its reciprocal connections with ventrally adjacent anterior cingulate cortex, conveying motivational-behavioral influences concerning internal needs and drives (Orgogozo & Larsen 1979). Recent data (Schell & Strick 1984) demonstrate that the SMA is a major cortical target of basal ganglia outflow, suggesting that it may preferentially participate in the execution of learned motor sequences (Marsden 1982). The SMA would appear to be a major cortical site mediating the interaction between cortical limbic outflow via anterior cingulate cortex, the context-sensitive, goal-setting functions of the prefrontal cortex (whose outputs, along with those of many other associational areas of the cortex, are integrated and refocused onto the SMA via the basal ganglia reentrant circuit), the sensory analysis functions of the association cortex of the superior parietal lobule, and the executive components of the motor system.

An examination of some of the important issues in brain architectonics and connectivity that relate to the structure of the SMA has been presented. This information may provide important clues about how the SMA might be expected to function physiologically. The most important information may be derived from a careful consideration of the evolutionary perspective and the work of Sanides dealt with in section 2.1.

### 3. Effects of electrical stimulation

Penfield and Welch (1949; 1951) defined the "supplementary" motor area through surface stimulation of the cortex in conscious human epileptic patients. It should be recognized that there are numerous difficulties with the interpretation of this type of data, particularly as it relates to the implied physiologic function of a part of the cortex. A detailed discussion of these problems is beyond the scope of this review.

Penfield and Welch (1951, p. 316) noted a zone of cortex "situated almost altogether within the median longitudinal fissure and anterior to the primary motor foot area" which, when stimulated, produced one of a group of clinical observations, including the following:

a. Inhibition and transient arrest of ongoing voluntary activity: Following the completion of a period of stimulation, the patient often expressed puzzlement at the inability to execute a voluntary act as it had been intended while the stimulation was applied.

b. At higher levels of stimulation, the assumption of a posture, most commonly elevation of the contralateral arm with abduction and external rotation of the shoulder. Vocalization was also produced at some sites, with perseverated syllables heard (e.g. Woolsey et al. 1979). Talairach and Bancaud (1966) observed that a behavior may develop sequentially with continued stimulation at one point.

Woolsey and his colleagues (Woolsey, Settlage, Meyer, Sencer, Hamuy & Travis 1952) found a somatotopic arrangement in SMA in the primate, with responses produced in the face found more anteriorly than those of the upper limb, trunk, and lower limb. In comparing the SMA to MI, they found that the SMA became more readily inexcitable with anesthesia than MI and that thresholds for responses tended to be generally higher in the SMA. Whereas MI rapidly habituated to repetitive stimuli, the SMA responded best to prolonged trains of stimulation. Thus although stimulation of MI produced transient, phasic movements with rapid habituation, the SMA stimulation was found to produce sustained influences on behavior, which did not habituate readily. Similar observations in man led Talairach and Bancaud (1966, p. 341) to postulate that the SMA organizes "postural movements and . . . tonic motility."

When the SMA is stimulated following excision of MI, the movements elicited tend to be more bilateral and proximal (Penfield & Welch 1951; Wiesendanger, Sequin & Künzle 1973). It has been questioned whether with stimulation of the cortical surface current spreads from the stimulating site to activate nearby MI directly or SMA projections to MI modulate MI activity transsynaptically (Wiesendanger et al. 1973; for review, see Humphrey 1979). However, it has recently been demonstrated that



movements of both contralateral proximal and distal limb joints can be produced with intracortical microstimulation of the SMA (Macpherson et al. 1982). This finding led the authors to suggest "the possibility of a close coupling between SMA and spinal motor nuclei" (Macpherson et al. 1982, p. 415), although the coupling was not felt to be as "tight" as that between MI and the segmental motor circuits.

#### 4. Effects of lesions

**4.1. The effects of lesions in primates.** There is little agreement in the literature regarding the effects of lesions of the SMA in subhuman primates (see Humphrey 1979; Wiesendanger 1981). Horsley and Schafer (1888) noted extensive paralysis which followed bilateral ablation of the marginal gyri. They were impressed by the severity of the deficit compared to the effects of removing equal amounts of tissue from the lateral convexity. Travis (1955) found that, whereas unilateral SMA lesions had negligible lasting effects, simultaneous bilateral SMA damage produced a flexion posturing of the limbs. When lesions of MI were extended to include the SMA, changes in postural tone and reflex hyperexcitability appeared. This led Travis to postulate that the SMA played an important role in the development of "spasticity." Coxe and Landau (1965) were not able to reproduce the deficit that Travis reported.

Unilateral SMA ablation, generally, appears to involve more transient and less evident deficits than bilateral ablations. Although there is a transient appearance of both forced grasping (Seyffarth & Denny-Brown 1948) in the contralateral hand of the primate (A. M. Smith 1979; Smith, Bourbonnais & Blanchette 1981) and a mild bilateral apraxia of fractionated distal movement of the upper extremities (C. Brinkman 1982; J. Brinkman 1981), the lasting effect of unilateral SMA ablation in both monkeys and man appears to be an impairment of bimanual coordination (C. Brinkman 1982; J. Brinkman 1981; see section 4.3).

The effect of SMA ablation on the organization of voluntary movements in monkeys has received little attention. Moll and Kuypers (1977) found that premotor ablation that included the SMA but was extended to the lateral premotor areas impaired the ability of a monkey to adapt a trained, visually directed reaching movement of the contralateral limb to reaching around a transparent barrier for a piece of food. The authors postulated that the animal was not able to inhibit a subcortically driven reaching movement evoked by the visual image of the food seen through the barrier. It is unclear, however, to what extent this observation is related to SMA as opposed to APA injury since both areas were damaged in this study. This type of released visually dependent approach behavior, termed "magnetic apraxia" (Denny-Brown 1958) when unilateral or "utilization behavior" (Lhermitte 1983) when bilateral, has been observed in animals conditioned to reach toward visual targets in extrapersonal space (Deuel & Dunlop 1979; Stepien 1974) and in human patients presented with familiar objects (Lhermitte 1983), after damage involving dorsal premotor or adjacent dorsolateral prefrontal cortex. In these situations, behaviors that have been conditioned prior to the lesion become inflexibly linked to presentation of the

visual cue regardless of the context as a result of the damage to areas of the frontal cortex. The way that damage to different subdivisions of the premotor cortex participates in producing such effects remains to be clearly determined.

**4.2. Effects of lesions of the SMA in humans.** Damage to the SMA in patients has been reported to produce effects on speech as well as on limb movement (Alexander & Schmitt 1980; Goldberg, Mayer & Togliola 1981; Jonas 1981; Környey 1975; Masdeu, Schoene & Funkenstein 1978; Racy, Janotta & Lehner 1979; Rubens 1975). The effects on speech are usually observed with damage to the dominant left hemisphere although an exception has been reported (Brust, Plank, Burke, Guobadia & Healtan 1982). The syndrome usually consists of a lack of spontaneous conversational speech with a well-preserved ability to repeat phrases. There is difficulty in initiating speech, with struggle and hesitation. Some argue that the impairment cannot be considered a true aphasia since the structure of the speech produced is intact; they call it instead a "partial mutism" (Brown 1977; Damasio & Van Hoesen 1980). With unilateral SMA damage, the impairment of speech is often transient and the prognosis for recovery appears good (Rubens 1975). This may result from bilateral participation of the SMA in the generation of speech (Larsen, Skinhøj & Lassen 1978).

In a recent paper, McCarthy and Warrington (1984) have proposed a dual mechanism in the speech-production system to account for the striking dissociations seen with certain lesions between the impairment of repeated, nonpropositional speech as opposed to spontaneous, propositional speech, such as that seen with SMA lesions. They propose that speech output can be obtained through a route involving semantic analysis as well as through a direct route between "auditory/phonologic transcoding" and articulatory output. It could be suggested from the hypothesis developed in this paper that the semantic-analysis route involves the SMA and the related components of the medial premotor system that are primarily responsible for the generation of propositional speech, that is, speech that conveys semantic content and emanates from an endogenous source (see also Jonas 1981). On the other hand, the lateral premotor system including the APA (possibly Broca's area of the human brain) and the inferior parietal lobule, may include the auditory-phonologic transcoding "feedback" loop postulated by Lichtheim (1885) to be a direct "route between the auditory images of words and the motor images of words" (McCarthy & Warrington 1984, p. 464). The speech output mode of the medial system would thus be spontaneous voluntary output of propositional speech, whereas that of the lateral system would be repetition (see Table 1, line 9).

Luria (1966) has described, in great detail, patient "Ch," who almost certainly sustained injury to the SMA following a midline frontal depressed skull fracture. The patient exhibited what Luria referred to as "de-automatization" of speech and limb movements. Luria particularly noted a sharp contrast between the relative fluency of speech in dialogue and the considerable difficulty with independent extended speech. The patient was able to reply quickly and directly to questions that required brief, direct responses but was unable to elaborate his

ideas beyond such short, abrupt answers. With regard to this apparent lack of spontaneity, the patient remarked that “thoughts do not enter my head” (Luria, 1966, p. 226). Limb movements were characterized by a disturbance in organizing smooth, integrated sequences. A gross disturbance was noted in the ability to coordinate bimanual acts. The patient would tend to perform a bimanual task by successive acts with each hand separately, particularly when the task required simultaneous asymmetric or reciprocal action. There was a strong tendency, when bimanual simultaneous movement was performed, to produce symmetric mirror movements (see section 4.3). The patient recognized these problems in his own performance and would remark: “it seems as if my hands do not belong to me . . . something holds them back, and they do not do what they should (Luria 1966, p. 230), suggesting that although the image of the intended act was intact and the intent-to-act verbally expressible, the transformation into successful coordinated performance was impaired. This led the patient to interpret his own behavior in terms of an exogenously produced dissociation between intent and action (Bogen 1979; Goldberg et al. 1981). With unilateral movements, the patient’s greatest difficulty occurred in the assembly of component movements into a smooth and continuous sequence. Movement elements in a sequence were performed in isolation, but the formation of a “kinetic melody” governing the smooth and automatic execution of the sequence did not occur even after months of practice. This difficulty was labeled “a disturbance of the formation of motor dynamic stereotypes” (Luria 1966, p. 231). Luria postulated that the disturbance involved a defect in the selective gating of kinesthetic impulses responsible for the rapid and smooth transition from one motor link or “subschema” (Arbib 1981) to the next in a serially organized movement. Similarly, the intention to express a thought spontaneously in words did not lead to a smooth unfolding of a complete propositional sentence.

Laplane et al. (1977) reported observations on three patients in whom unilateral corticectomies of the SMA had been performed to ameliorate intractable epilepsy with SMA foci. They found that, in addition to the partial mutism noted above, the initial effect of the lesion was a severe decrease in spontaneous movement of the limbs which was particularly pronounced contralaterally. Actions not produced spontaneously could be elicited in response to strong spoken commands by the examiner. A contralateral facial paralysis was noted with spontaneous smiling which disappeared when the patient smiled to command. Grasp automatisms were not seen. Several months after the surgery, recovery was almost complete. Patients continued, however, to have difficulty with bimanual coordination (see section 4.3).

Laplane et al. (1977) proposed that the SMA acts to initiate and sustain spontaneous motor activity and that damage to the SMA thus produces more severe impairment of “intentional” action arising primarily out of internal context as opposed to environmentally contingent “responsive” action. Damasio and Van Hoesen (1980) came to similar conclusions in their report of three patients with SMA damage. They hypothesized (p. 359) that the SMA provides the internal “drive” for willed movement” but is not necessary for the “eventual realization” of such movement, presumably because it

was possible to demonstrate that simple movements could be performed when cued from external context.

Goldberg et al. (1981) have reported two cases of left medial frontal cortex infarction involving the SMA in which organized goal-directed movements of the contralateral hand and arm appeared in apparently extravolitional fashion; that is, they arose in conflict with the verbalized internal context. This type of striking dissociative disturbance has been labeled the “alien hand sign” (Bogen 1979; Brion & Jedynak 1972). Although it has been thought that this disturbance results from a deterioration of interhemispheric communication, it has been suggested that its appearance may be related to dysfunction of cortical structures on the mesial wall of the contralateral frontal lobe (Goldberg et al. 1981).

The appearance of extravolitional, goal-directed actions suggests that the SMA may function normally to inhibit such actions unless they are specifically addressed by a volitionally generated signal reflecting internal context. It is possible that the alien hand sign may follow from a disconnection between limbic outflow and the motor executive areas. Just as it may appear from the examination of the dissociative sensory phenomena seen with temporal lobe seizures that a neocortically-elaborated percept requires limbic association to assume “experiential immediacy” (Gloor, Olivier, Quesney, Andermann & Horowitz 1982), so action may require limbic participation to assume its volitional or self-referenced origin. If the neural substrate mediating the coupling of limbic drive to the executive motor areas at the cortical level is impaired, one might expect an impoverishment of spontaneous intentional action arising primarily out of internal context, and, possibly, the appearance of relatively automatic behaviors occurring extravolitionally in response to a particular external context. This might be expected if the lesion resulted in an abnormal imbalance favoring the initiation of environmentally contingent “automatic” actions, which are *responsive* in nature, rather than internally generated actions, which are *anticipatory* in nature (see Figure 8).

Jonas (1981) has reported on an extensive survey of the clinical literature describing speech disturbances associated with SMA lesions. He noted that during the recovery from lesions of the SMA, “nonpropositional ‘automatic’ speech may be initiated easily, *even involuntarily*, while initiation of propositional speech is still difficult or impossible” (Jonas 1981, p. 349; emphasis added). The hypothesis formulated by Jonas to account for these observations was that the intact SMA acts to facilitate and control the initiation of propositional speech, whereas it “plays a role in the suppression of the emission of nonpropositional ‘automatic’ speech” (Jonas 1981, p. 369). It could be argued that this hypothesis can be extended in an analogous fashion to the role of the SMA in voluntary action in general.

#### 4.3. Effects of lesions of the SMA on bimanual coordination: Medial and lateral motor programming systems. C.

Brinkman (1982) and J. Brinkman (1981) have noted that primates with unilateral SMA lesions have difficulty with bimanual coordination tasks requiring independent movements of the two hands. The animals tended to produce mirror-symmetric movements in such situations, as did the patients with SMA lesions. When

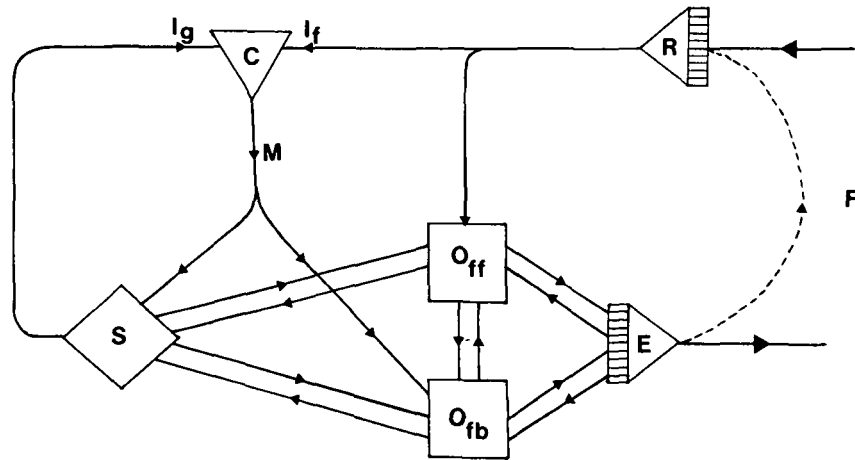

Figure 8. The separation of feed-forward (projectional) and feedback (responsive) control mechanisms in the organization of action (adapted from D. M. MacKay 1978). F: sensorimotor field of action; R: receptor system; E: effector system;  $I_f$ : information submitted to comparator (C) for evaluation against current criteria ( $I_g$ ); M: running indication of match/mismatch between  $I_f$  and  $I_g$ ; S: supervisory system which determines current criteria and supervises and monitors the organizing subsystems  $O_{ff}$  and  $O_{fb}$  whose task it is to "prescribe a running selection from E's repertoire calculated to bring or keep  $I_f$  in line with  $I_g$ " (D. M. MacKay 1978, p. 54).  $O_{ff}$ : subsystem within the organizing system which implements projectional feed-forward control under the direction of S and uses recognition of salient task-relevant features of the current sensory context for anticipation.  $O_{fb}$ : subsystem within the organizing system which implements action in response to a mismatch signal from C. This conceptualization thus enables us to "distinguish between two basically different ways in which action can originate" (D. M. MacKay 1978, p. 55).

Brinkman subsequently sectioned the corpus callosum in the lesioned animals, they were once again able to perform the bimanual task successfully (C. Brinkman 1982). How can these findings be understood?

As has been noted, the SMA of each hemisphere projects to both the ipsilateral and the contralateral primary motor cortices. One can hypothesize that there are two potentially independent but necessarily interactive motor programming channels, *each having access to the executive apparatus for both sides of the body*. If we assume that each SMA is connected to the MIs in such a way that homologous muscles of the two extremities are activated together then one SMA acting alone could very well tend to produce mirror-symmetric movement. Under normal conditions for independent bimanual control it would be necessary for each "active" SMA to establish a dominant role in control of the contralateral limb through its projections to ipsilateral MI and to suppress the other SMA's potential influence through its callosal connections to the contralateral SMA and MI. It is known that synchronous bilateral movements using homologous muscles (i.e. mirror-symmetric movements) are performed with much greater agility than those using non-homologous muscles (Wyke 1969). For bilateral movements requiring synchronous activation of nonhomologous muscles, both hemispheric programming channels would require activation and each SMA would then operate via its connections to ipsilateral MI. To maintain appropriate phase relationships between the two channels so the hands could work together in a complementary, cooperative fashion, communication between the two SMAs via the corpus callosum would be critical. This coordination may be necessary to establish an overall temporal structure for the task that ensures predictable

parallel phase relationships between the two simultaneous programs controlling the two hands (Kelso, Southard & Goodman 1979). However, an alternative mode of bimanual control could be obtained through slower visual guidance mechanisms mediated intrahemispherically by corticocortical extrastriate connections to the more lateral arcuate premotor cortex (Jones, Coulter & Hendry 1978; Pandya & Kuypers 1969). Thus, in corpus callosotomy, the long-term impairment of complex intermanual coordination (Zaidel & Sperry 1977) may be due to an inability to maintain appropriate phasing between two independently operating intrahemispheric programming channels, though this may be partially compensated through visual feedback.

One could then hypothesize the presence of two separate intrahemispheric motor programming systems which follow from the earlier discussions regarding a duality of premotor projections: a medial motor system including the SMA (medial paralimbic protomotor cortex) and the closely associated basal ganglia (Schell & Strick 1984), and a lateral system including ventrolateral arcuate premotor cortex. Such a hypothesis is based on the idea that the SMA is part of a dorsomedial hippocampally derived system which is concerned with perception and representation of space and is necessary for extended, internally dependent, predictive or *projectional* action. This system is more concerned with the general problem of navigating the limb through space than with the more focal problem of accurately acquiring identified objects in "peripersonal" (Rizzolatti, Matelli & Pavesi 1983) or reachable space. The lateral protomotor area, the APA, is part of a ventrolateral piriform-derived system which is concerned with perceiving and recognizing external inputs and investing them with motivational significance,



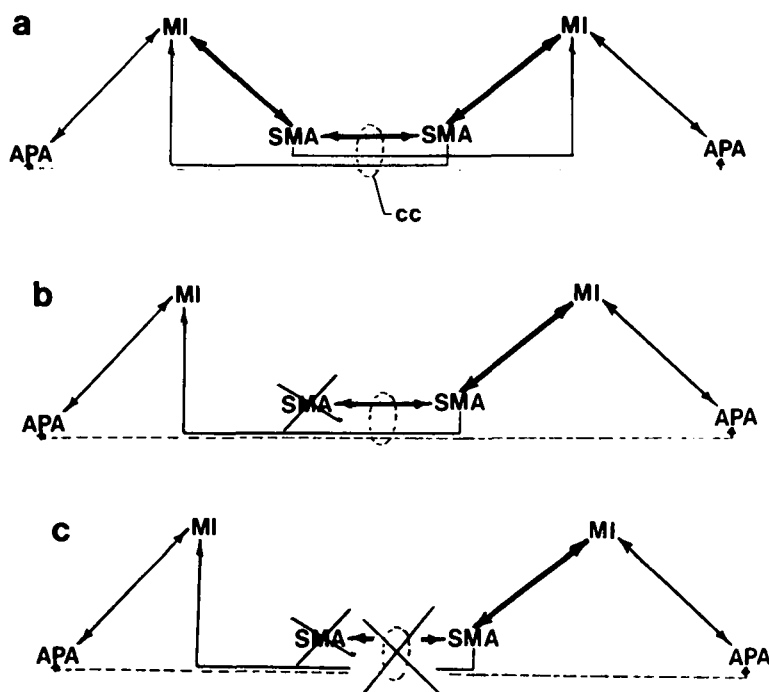

Figure 9. Bihemispheric relationships of the motor areas (see also C. Brinkman 1982; J. Brinkman 1981). Abbreviations as in text with the addition of cc: corpus callosum. (a) Normal pattern of connection. Each SMA is connected to both MIs though more strongly connected ipsilaterally. It also receives predominantly ipsilateral input from the APA. Callosal connections between SMAs are more intensive than those between APAs. (b) With unilateral damage to the SMA, the contralateral remaining SMA predominates in both ipsilateral and contralateral limb control through its projections to the MIs of both hemispheres. This impairs bimanual coordination by increasing the tendency for movements to be mirror symmetric. This tendency is dependent on callosally mediated input from the intact SMA to the contralateral MI and is also responsible for the persisting impairment of simultaneous reciprocal action (see text). (c) With an additional lesion of the corpus callosum, the fibers from the intact SMA to the contralateral MI are disrupted, thus releasing the MI on the left side of the diagram from any medial system control. Bimanual coordination may be improved to some extent (C. Brinkman 1982), but now there is no interhemispheric coordination. The MI on the left is under exclusively lateral system (APA) influence whereas that on the right still has medial (SMA) and lateral (APA) system inputs. This difference in system dependence between the two hemispheres under such conditions could represent the basis for observation of the alien hand phenomenon in human patients with such damage (Goldberg et al. 1981).

an operation depending, for visual recognition, on foveal information (Bear 1983; Ungerleider & Mishkin 1982; see also Trevarthen 1968). It is hypothesized that the ventrolateral premotor system, which has a more direct association with this object analysis and recognition system, is used in the production of interactive, externally contingent *responsive* action driven by the presence and identified nature of specific objects in the organism's immediate environment (Paillard 1982b; Rizzolatti et al. 1983).

Task performance depends on two internal representations of the world: a categoric model of the world at present based on an integration of past and current experience of it, and a probabilistic model of the future which drives the action forward by permitting anticipatory interpolation between the current sensed state and a

future predicted state (Bernstein 1967; Requin, Semjen & Bonnet 1984). Action can occur in response to the world as it is sensed in the present, or it can be guided by projections about how the world will be at a point in the future. The former mode of control would occur through the lateral system and the latter through the medial system, according to the present proposal.

In the more bilaterally organized medial system, the programming of unilateral and bilateral movements requires close callosally mediated interaction between the two hemispheres. Bihemispheric activation of the SMAs and the basal ganglia is seen even with unilateral movement when MI activation is only contralateral (Roland, Meyer, Shibasaki, Yamamoto & Thompson 1982). The medial system predominates when rapid, well learned, "skilled" movement sequences are executed

using primarily kinesthetic information, independent of the requirement for ongoing visual feedback monitoring. The medial system is thus capable of using a model- or hypothesis-driven, feed-forward, predictive mode of control which may rely on efference copy for internal error correction and internal monitoring as the movement unfolds (Angel 1976). Task-relevant components of the model of the future that permit anticipatory control could be built up through an opportunity to "learn" the task with practice. This learning process probably involves acquiring the ability to recognize and use skillfully a set of key selected sensory contexts to trigger or gate component motor subroutines or units assembled for the task. A sensorimotor schematic representation of the task is composed and is essentially "precompiled" and executed in a feed-forward fashion (Arbib 1981), although it is tied at critical points to crucial selected sensory inputs that facilitate the transitions from one motor link to the next. The basal ganglia provide important assistance in this function of rapidly detecting task-relevant contexts (Rolls, Thorpe, Maddison, Roper-Hall, Puerto & Perret 1979) and using this information to select between alternative action strategies. When this function is faulty, there is a failure to specify and initiate component units in an action sequence. The medial system thus attains the capacity for "automatic execution of learned motor plans" (Marsden 1982, p. 537) through the formation of "abbreviated kinetic schemes" (Luria 1966, p. 244).

The lateral system, in contrast, is dependent on sensory feedback, particularly from foveal vision, and it operates using a corrective, input- or data-driven, closed-loop responsive mode of control, somewhat analogous to the manner in which computer code is generated by an interpreter in response to a line of high-level language (see Arbib 1981). This mode of code generation has certain advantages in interactive computing environments but is not very efficient for the rapid execution of complete, extensive programs. The lateral system may thus be important in interactive tasks such as visuomotor tracking of a random signal where anticipation cannot be used to advantage or when one is first learning a complex or novel motor task. This system would be important in integrating object information in responsive action and in preacquisition hand shaping and feedback correction during reaching to an object in space (Jeannerod & Biguer 1982; see also the work of Trevarthen 1968). It is postulated that this system is less callosally dependent than the medial system (Gould, Cusick, Pons & Kaas 1983). Thus, with damage to the medial system SMA and section of the corpus callosum (C. Brinkman 1982), the lateral systems are freed to provide "backup" control for the bimanual task although, if the hypothesis is correct, performance under this condition would presumably be more bound to visual than kinesthetic guidance.

Cortical unit recording and anatomic studies suggest that in the primate brain, the APA plays a special role in visually guided reaching to food (Godschalk et al. 1981; Godschalk & Lemon 1983; Godschalk, Lemon & Kuypers 1983; Godschalk et al. 1984; Kubota & Hamada 1978). Damage to this region in primates produces a deficit in responsive coordinated movements directed toward bringing food to the mouth from contralateral "peripersonal" hemispace, using either direct grasping with the

mouth of food held close to the face or reaching hand-to-mouth action (Rizzolatti et al. 1983). Whereas units in the APA can readily be driven by tactile and visual inputs (Rizzolatti, Scandolara, Matelli & Gentilucci 1981a; 1981b), SMA units tend to be relatively unresponsive to attempts to drive them from the periphery (Brinkman & Porter 1979; see section 5), although the conditions under which these studies tested sensory fields were quite different.

It is important to note that in most situations a state intermediate between the two extremes of the proposed dichotomy of control requirements is in effect, and that both systems would operate cooperatively, in parallel to provide an optimal blend of the two control modes.

The prototypical human disease process affecting the operation of the medial system is Parkinsonism. The motor behavior of patients with Parkinson's disease has been studied extensively and may provide us with important clues about the separate functions of these two putative motor programming systems.

The type of impairment of movement observed in Parkinsonism is a deterioration in the predictive mode of control, the mode that characterizes the operation of the medial system (Flowers 1978; Marsden 1982; Stern, Mayeux, Rosen & Ilson 1983). Parkinson patients have difficulty, for example, in initiating spontaneous movements that depend on prediction and in tracking visual signals when the signals are not totally explicit (Bloxham, Mindel & Frith 1984; Flowers 1978). With the predictive mode of control impaired, they become more dependent on visual feedback for the guidance of movement (Cooke, Brown & Brooks 1978; Stern et al. 1983), presumably turning to remaining functions of the relatively spared lateral premotor system to attempt to substitute for those lost through medial system impairment. The Parkinsonian patient, may, however, become abnormally bound to direct visual input for the guidance of movement and experience difficulty in maintaining the quality of movement if visual cues are degraded (Flowers 1978; Stern et al. 1983). Similarly, primates whose medial system is made dysfunctional by cooling the basal ganglia show particularly severe impairment of learned arm movements when visual guidance is precluded (Hore, Meyer-Lohmann & Brooks 1977).

Furthermore, Parkinsonian patients have a great deal of difficulty performing bimanual tasks in a simultaneous, overlapping fashion (Schwab, Chafetz & Walker 1954). Whereas normal subjects are more adept at using simultaneous as opposed to concurrent (i.e. alternating) strategies in performing familiar bimanual tasks, Parkinsonian patients have significantly less difficulty using the latter mode. They choose to perform such tasks in an alternating, concurrent mode, shifting the visual focus back and forth between the two hands and completing subunits of the task unilaterally and alternately under direct visual control (Podbros 1983). This would suggest that the medial programming system, when intact, is capable of managing the well-learned bimanual task with simultaneous control of nonhomologous muscles of the arms (although an overall temporal structure is imposed to ensure coordinated coupling between the two arms), using "fast" kinesthetic information. The lateral system, having poorer interhemispheric coupling and being more

dependent on slow visual information for limb guidance, operates by performing the bimanual task concurrently rather than simultaneously.

### 5. Cortical unit studies

Neafsey, Hull, and Buchwald (1978a; 1978b) studied the behavior of cortical, thalamic, and subcortical units in the cat during the preparation to move in a delayed reaction time task. They found that the medial precruciate cortical units began to fire at consistently earlier latencies than the lateral motor cortex and suggested that the medial cortex participated in the generation of premovement "set" along with the basal ganglia, whereas the execution of the movement seemed to be more closely related to unit activity in the lateral motor cortex.

Brinkman and Porter (1979) studied the behavior of SMA units in primates associated with a learned, unconstrained arm movement. Eighty percent of the units showed movement-associated modulation that seemed to correspond as often to distal as to proximal joint movement. Testing in the passive, relaxed animal led them to conclude that "very few SMA neurons could be demonstrated to receive inputs from peripheral receptors" (Brinkman & Porter 1979, p. 687). A small tonically firing subpopulation (7%) appeared to inhibit its firing rates throughout the course of the movement, suggesting that such units tonically inhibit the appearance of the learned motor behavior of the contralateral limb. Their findings led them to suggest that "SMA is not involved exclusively in the control of posture, but that its role is a more complex one that includes control over distal extremity musculature as well" (Brinkman & Porter 1979, p. 704).

Tanji, Taniguchi, and Saga (1980) obtained single-unit recordings from the SMA of two monkeys using a prewarned delay reaction time paradigm (Tanji & Evarts 1976). They found a population of SMA units that appeared to set up a differential preparatory state in response to the advance instruction. Of the 201 instruction-related neurons, 94 responded differentially to the motor instruction to "push" or "pull" the manipulandum. This led the authors to conclude that "the SMA . . . plays a part in modifying a sensory-triggered motor output in a behavioral context" (Tanji & Taniguchi 1978, p. 318). Clearly, this situation is one in which prior information allows the animal to *anticipate* the future event by translating an instruction given at one point in time into a need to act in a certain manner at some future point and thus to develop an appropriate preparatory state that would depend on the ability to *predict* future loading states of the limb. Roland et al. (1982) have suggested that the SMA becomes active whenever action depends on a prior instruction which presumably alters the internal context with respect to a future event.

Tanji and Kurata (1982) compared movement-related activity in the SMA to that in MI during sensory-triggered simple reaction time tasks. They found that although the SMA units were not as well correlated with movement onset as were the MI units, the sensory response latencies of the SMA neurons were significantly shorter in the reaction time paradigm than the response latencies of the MI units. SMA units appeared to be upstream from the executive motor apparatus, function-

ing in the sensorimotor association process of the conditioned reaction time paradigm. It would be of some interest in such a paradigm to see whether similarly responding units could be found in the APA and how the response characteristics of APA units compare to those of SMA units.

Weinrich and Wise (1982) have reported a study of cortical units recorded from supraarcuate cortex on the dorsolateral aspect of the primate brain during a visually cued delayed choice reaction task. A significant portion of units in this area responded to set during the delay period although most of these units also modulated their response with the movement. The relative frequency of set-responsive cells in this zone as compared to MI appeared to distinguish the areas. Sakai (1978), exploring more rostrally, found a greater predominance of cells that were strongly related to set and weakly related to the movement itself. This would suggest that there is a gradient as one proceeds poleward from MI into supraarcuate cortex, in which set-related cells occur more frequently and neurons that appear to be related more directly to details of the execution of the movement are found less often.

A clear distinction between unit behavior in the dorsolateral supraarcuate "premotor" cortex from that in the SMA is not immediately evident. It is possible that instruction-responsive cells, which do not clearly alter their activity with the subsequent motor response, occur more frequently in SMA.

From the relatively limited evidence available, it appears that the SMA plays a rather complex role in the control of limb movements which places it upstream from MI. Although it may function, at least in part, to modulate transcortical reflex loop gains through MI (Tanji et al. 1980; Wiesendanger et al. 1973) more direct evidence for the existence of this mechanism is needed. It is unclear from the current studies how the SMA participates in a "self-paced" or relatively spontaneous motor act. In addition, unit behaviors that may distinguish anterior cingulate cortex from SMA have not yet been elaborated. Although detailed issues of physiologic mechanism are best dealt with in comparative animal studies, questions involving "intention," "spontaneity," "expectation," and other aspects of volitional processes reflecting internal subjective states may not be readily understood from animal studies or, at the very least, require highly innovative experimental paradigms.

### 6. Regional cerebral blood-flow studies in humans

In the past decade, the linking of local blood flow in the cerebral cortex to the local metabolic activity and thus to regional neuronal activity initially postulated by Roy and Sherrington in 1890 has been exploited in an attempt to further delineate the pattern of participation of various areas of cerebral cortex *in vivo* during the performance of different activities in humans.

Using a radioactive flow technique, Lassen and his colleagues (Lassen, Ingvar & Skinhøj 1978) have studied patterns of regional cerebral blood flow (rCBF) related to different behaviors. Rapid advances in technology along



with the development of pharmacokinetic models for metabolic tracers have led to the ability to image tomographically the spatial concentrations of substances labeled with positron-emitting isotopes. These advances permit the measurement of regional cerebral blood flow and the local metabolic rate for glucose throughout the brain (e.g. Huang, Phelps, Hoffman, Sideris, Selin & Kuhl 1980; Raichle, Grubb, Gado, Eichling & Ter-Pogossian 1976).

Such rCBF studies have suggested *bilateral* activation of the SMA along with activity of the contralateral precentral motor area when subjects perform learned unilateral sequences of ballistic movements of the fingers – the “motor-sequence” test (Roland, Larsen, Lassen & Skinhøj 1980). When subjects were asked to simulate internally the performance of such movements without actually executing them, only bilateral SMA activation without activation of the contralateral MI was apparent (Orgogozo & Larsen 1979; Roland, Larsen, Lassen & Skinhøj 1980). This led the authors to suggest that the SMA was a “supramotor” area (Orgogozo & Larsen 1979) which “was most likely engaged in the elaboration of motor subroutines that specified the sequence of movements” (Roland et al. 1982, p. 477). In a positron-emission tomographic study of rCBF, Roland et al. (1982) reported that when the subjects performed the “motor-sequence” test, there was a bihemispheric pattern of activation not only of the SMA but also of the basal ganglia and various motor and sensory cortical and subcortical association areas. The activity in the contralateral MI appeared unilaterally. Activity in the cerebellum was not examined.

Evidence from rCBF studies also suggests that there is bilateral activation of the SMA during automatic speech, implying that the SMA participates in the programming of the sequence of motor instructions to produce human speech (Larsen et al. 1978).

It is of interest, in view of the present premise regarding the differentiation of medial protomotor SMA from the lateral protomotor APA in the primate brain, that rCBF studies have shown there to be significant bilateral focal activation of an inferior frontal region in humans performing the motor-sequence test (Roland, Larsen, Lassen & Skinhøj 1980) and a nonvisual task that involved precise movements in extrapersonal space (Roland, Skinhøj, Lassen & Larsen 1980). The authors felt that such activation might be due to internal counting in the first task and to the processing of verbal commands in the second. It is possible, however, that this is the lateral protomotor zone in the human brain and that its more pronounced activation in the second task resulted from a greater dependence on an extrapersonal reference system in this task. It would be of great interest, particularly in view of the material reviewed earlier, to determine whether tasks that rely more heavily on visual input for directed movement through extrapersonal space toward a target activate this area together with inferior parietal and visual association regions as would be predicted from the primate studies.

Orgogozo et al. (1979) studied rCBF activation patterns with the performance of various actions in 52 patients. Their results suggested that the SMA participates in the organization of movements in proportion to the degree of internally developed “intentionality” associated with the

performance of the task, that is, the degree of conscious intentional engagement of the subject in the task.

## 7. Event-related brain potential studies

Electroencephalographic signal components that are related to specific events can be recovered from the scalp or cortex using time-locked averaging techniques applied to a signal ensemble. Such techniques have been applied to examine electrical brain correlates of sensory processes (Hillyard, Picton & Regan 1978), processes of sensorimotor association and information processing (Donchin, Ritter & McCallum 1978), and processes underlying the production of movement (Deecke, Grozinger & Kornhuber 1976).

Recording from the scalp and averaging frames of data captured around the onset of EMG activity recorded from the prime mover for a discrete “self-paced” movement (e.g. finger flexion), it is possible to extract a slow, negative potential preceding the movement, called the readiness potential (RP) or *Bereitschaftspotential* (Deecke et al. 1976; Deecke, Scheid & Kornhuber 1969; Kutas & Donchin 1980; Shibasaki, Barrett, Halliday & Halliday 1980; Vaughn, Costa & Ritter 1968). There appear to be at least two components of the RP: an initial slowly increasing negativity which is fairly widely distributed and bilateral, beginning about 1,000 milliseconds before the movement, and a subsequent component which is marked by an increased acceleration in the negativity (called the NS' component by Shibasaki et al. 1980 which appears to be associated with a gradual development of asymmetry in the topographic distribution, with the contralateral central region becoming steadily more negative than the ipsilateral central area. The RP may first appear in midline electrodes positioned over the SMA (L. Deecke, personal communication; Goldberg, Kwan, Borrett & Murphy 1984b; Kristeva, Keller, Deecke & Kornhuber 1979; Schreiber, Lang, Lang, Kornhuber, Heise, Keidel, Deecke & Kornhuber 1983). This negative potential development appears to be related to a process underlying the preparation to respond and may be influenced by altering various contingencies that could affect the preparatory process, such as prior knowledge of the hand with which the movement is to be made (Kutas & Donchin 1980). Such a potential may in fact be recorded in situations in which human subjects internally plan a movement which is then “vetoed” and never actually overtly occurs (Libet, Wright & Gleason 1983).

In a study of Parkinsonian patients, it was found that the RP developed normally during its initial, symmetric, vertex-centered phase, but then did not subsequently lateralize to the contralateral central area (Deecke & Kornhuber 1978). This was interpreted to indicate that the SMA, located beneath the vertex electrode, functioned in the initial phases of the RP but that a subsequent process, leading to the contralateral movement of the distribution, was impaired. Thus it was postulated that the SMA makes a major contribution to the initial symmetric phase of the potential. More recent data from normal individuals performing complex unilateral tasks such as handwriting indicate an initial appearance of the RP at an electrode placed just anterior to the vertex

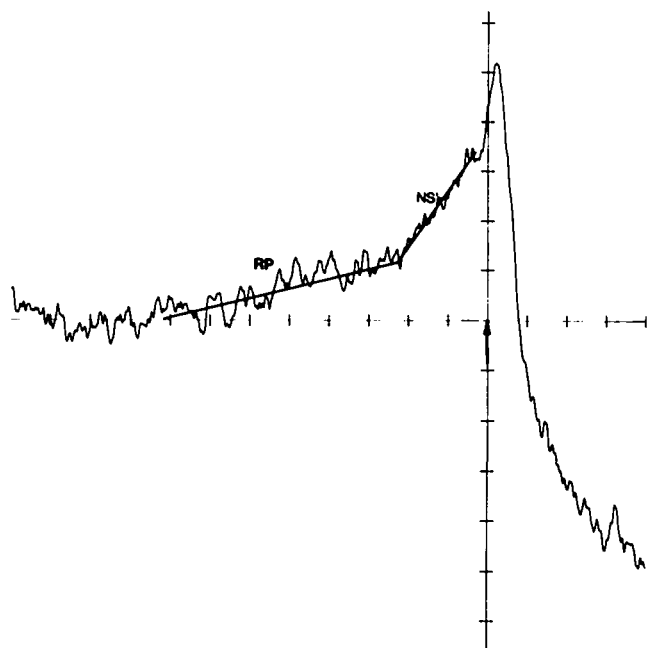

Figure 10. Readiness potential. Grand average of 750 movements performed by 14 subjects with movement onset occurring at location of the vertical arrow. Recording from the vertex with reference to linked earlobe electrodes. Horizontal scale: 250 mS/div. Vertical scale: 2  $\mu$ V/div. RP: readiness potential. NS': see text (Shibasaki et al. 1980).

electrode directly over the SMA (Schreiber et al. 1983). Furthermore, evidence obtained from subjects learning a new motor skill suggests that the SMA also participates importantly in the acquisition of skills (Lang, Lang, Kornhuber, Deecke & Kornhuber 1984).

Libet, Wright, and Gleason (1982) have identified two volitional processes corresponding to two different types of RP recorded when subjects move in coincidence with an external signal or when they move spontaneously. Process I is associated with a widely distributed negative potential seen before 600 mS preceding a planned movement. This process is associated with "either endogenous or externally cued development of a general planning or intention to act at some loosely defined time approaching in the near future" (Libet et al. 1982, p. 333). Process II, associated with a vertex-centered negatively appearing over the SMA at 575 mS or less before the movement, "is associated with the more specific urge or intention to act [and] . . . may be regarded as the one [process] more uniquely associated with a fully independent volitional act, as opposed to a pre-intentionality that is not necessarily endogenous" (Libet et al. 1982, p. 333). Recent work from Libet et al. (1983) suggests that the SMA may be involved in the development of the intention-to-act prior to movement, even if the movement does not subsequently appear. Such findings would suggest that the SMA participates importantly in the development of the readiness to act by conveying internal drive tendencies to the motor executive regions. When movement is subject to the restrictions of an external, particularly a visual, context, the vertex concentration of the potential over the SMA seen in unrestricted "self-initiated" movements may be "diluted" by additional contributions from the lateral premotor zone and related cortex of the

inferior parietal lobe that are needed to integrate the relevant features of the extrapersonal context into the act (Goldberg, Kwan, Borrett & Murphy 1984a). Such findings are roughly comparable to the rCBF results reviewed in section 6. The advantage of the RP is that it can provide temporal resolution not possible with tracer techniques where the need to allow the tracer to distribute and equilibrate means that only steady state information gathered over several tens of seconds, at best, during the activating performance can be obtained. The techniques are complementary in that what rCBF and metabolic studies lack in temporal resolution they more than make up for in spatial resolution when performed with tomographic scanning. It is clear that the recording of such movement-associated potential distributions and the mapping of rCBF and local metabolic rates in the intact human brain using innovative paradigms can be used to address such questions about how activity in different brain regions contributes to the volitional processes associated with a voluntary act.

## 8. Hypothetical model of the medial premotor system

In this section a new model is proposed for the organization of the medial premotor system, and its manner of operation during the microgenesis of a discrete movement is outlined. This model builds on the anatomic data developed in section 2 and postulates how various pathways may be used dynamically in controlling action. The following set of premises make up the proposal:

1. Cortical zones participating in this system are linked reciprocally via mutually excitatory connections to specific, nonoverlapping sections of the ventral thalamus, thus creating a family of positive feedback circuits (Penney & Young 1983). Each of the cortico-thalamo-cortical (CTC) loops can be viewed as giving rise to an oscillatory limit-cycle process both on the basis of mutual excitation, and more important, because of inherent oscillatory characteristics of the thalamic nuclei (Steriade & Deschênes 1984) which can be manipulated to adjust transmission characteristics and thus control the flow of subcortical information through to the cortex (Deschênes, Paradis, Roy & Steriade 1984).

2. Activity within a particular CTC loop can be modulated by inputs coupled through the cortex from the thalamic end of the loop or via corticocortical transmission at the cortical end of the loop.

3. The dynamic state of wide regions of cortex can be influenced by spreading projections from nonspecific thalamic nuclei (Herkenham 1980) as well as other widely projecting subcortical fiber systems directed to the cortex (Morrison & Magistretti 1983).

4. Modulating inputs at the thalamic end of the CTC loops arise from the nucleus reticularis thalami (NRT; Skinner & Yingling 1977), from subcortical reentrant sources from the basal ganglia (internal pallidal segment) or the deep cerebellar nuclei, or from sensory input pathways. Modulating influences from the NRT can control the oscillatory behavior of the thalamic nuclei and thus their transmission characteristics (Steriade, Deschênes & Domich 1983). NRT drive to the thalamic nuclei is in turn controlled selectively from the frontal

cortex and tonically from the mesencephalic reticular formation, a mechanism suggested as a physiologic basis for selective attention (Skinner & Yingling 1977). The reentrant inputs to thalamus from the basal ganglia and the cerebellum, as outline in section 2.2, are directed to specific nonoverlapping regions of the ventral thalamus in such a way that specific limited regions of the cortex can be addressed by these inputs via corresponding thalamic connections.

5. The microgenesis of action develops with the goal of specifying progressively the population of cells that will be selected to become directly active in the execution of the focal overt action. The process would also specify the postural activity preceding the focal activity needed to maintain biomechanical equilibrium (Massion 1979). According to the model, there is a spiral centered on MI which begins as a widespread activation of the cortical mantle providing the contextual basis of the action (Reed 1982). This activity converges to the striatum and passes through to the globus pallidus from which it is focused onto the SMA via the ventral thalamus (see Figure 11, loop 1). This may be viewed as a transformation from context to intention-to-act which is modulated by the limbic system both within the basal ganglia and via projections to the SMA from the anterior cingulate cortex. The major goal of this initial traversal is to select a context-appropriate behavioral strategy or motor "schema" (Cools 1980). The details required to execute the action are then specified through the second limb of the spiral from the SMA and related cortical zones to MI via the transcerebellar (see Figure 11, loop 2) as well as the corticocortical route. The concept of flow of activity from limbic cortex through associational cortices and then to MI with the basal ganglia participating "upstream" from the cerebellum has also been proposed by Paillard (1982a). This flow in the preparation of a discrete action may be related to stages of increasing specification during the process of preparing to move (Requin, Lecas & Bonnet 1983).

6. The inhibitory output of the basal ganglia via the internal pallidal segment interacts in the thalamus with the CTC loops that involve the SMA at their cortical end (Schell & Strick 1984). This drive helps the SMA control the execution of learned, extended motor programs as outlined earlier.

7. The excitatory output of the deep cerebellar nuclei interacts at the thalamic level with the CTC loops that have MI at their cortical end (as well as the APA). These cerebellar outputs may act to perform the detailed temporospatial parameterization of the strategy selected by loop 1 which allows loads to be predicted and anticipated (Hore & Vilis 1984) on the basis of the current sensory context as well as previous experience performing the task. Cerebellar outputs to the thalamus may function to modulate the operation of sensorimotor loops through MI (Mackay & Murphy 1979) in the face of changing background input or task factors that may alter the loading conditions of the performance. Furthermore, the operation of the cerebellar loop could progressively improve the performance of a task as the loading requirements become more familiar with practice. A great deal can be learned about the organization and dynamic operation of this system by careful observation of the sequence of change occurring in cortical activation patterns during

the acquisition of a motor skill (e.g. Lang et al. 1984; Sasaki & Gamba 1982; Taylor 1978).

The model is illustrated in Figure 11. There is a progression of coupled CTC loops starting from anterior cingulate cortex to mesial prefrontal cortex, through to SMA and then to MI with a parallel sequence in ventral thalamus from VA through to VPL<sub>o</sub>. Activity in the initial loops can be controlled by anterior cingulate cortex projections providing for limbic modulation of information flow across the system.

According to this model there is cyclicity (in the oscillation of the CTC loops) as well as reentrant modulation of information processing in the microgenesis of motor outputs. There is thus increasingly specific selection of that population of neurons whose activity will eventually synthesize the resultant action. It is of interest that the presence of "phasic reentrant signaling" on a periodic basis has been postulated by Edelman (1978) in a theoretical model of higher brain function, in which such a construct was shown to be necessary for the dynamic, associative selection of operative neuronal groups in the central nervous system.

## 9. Conclusion

There appears to be some convergence of evidence regarding the role of the SMA in the cortical organization of action. Anatomic data suggest that the SMA stands on an interface between limbic outflow and the motor executive apparatus. Physiological and clinical evidence indicates that one aspect of SMA operation may be efferent integration, that is, the association of limbic inputs conveying internal decisions about action plans with contextual cues from the external environment in order to select and monitor the execution of appropriate subcortically resident motor subroutines. Although the SMA representation has been historically "secondary" by virtue of its being detected long after the classical "primary" representation, the SMA can be viewed as a paralimbic medial "protomotor" (Sanides 1964) cortex, which functions in a "supramotor" (Orgogozo & Larsen 1979) fashion, participating earlier than MI in the translation of motive to intention to action, and exerting control over MI. It can be distinguished in a number of different anatomic and implied functional ways from a lateral "protomotor" APA which also directly projects to areas of MI. Its relationship with cingulate cortex and its presumed evolution over phylogeny out of a hippocampal primordium, suggest a meshing of these concepts with a new theory of septo-hippocampal system (SHS) function, proposed by Gray (1982a), in which the SHS is hypothesized to detect a mismatch between actual and expected stimuli [see also *BBS* multiple book review of Gray (1982a) in *BBS* 5(3) 1982]. Such stimuli could be the perceived outcomes of self-initiated actions. Controlled by decisions made regarding the presence or absence of such a mismatch, the SHS modulates the selective facilitation or inhibition of ongoing motor programs. Gray proposes that the cingulate cortex, via reciprocal projections with the subiculum, not only keeps the limbic system informed about current motor plans, but may also act as an afferent zone through which the SHS can influence the selection of motor programs. The role of the



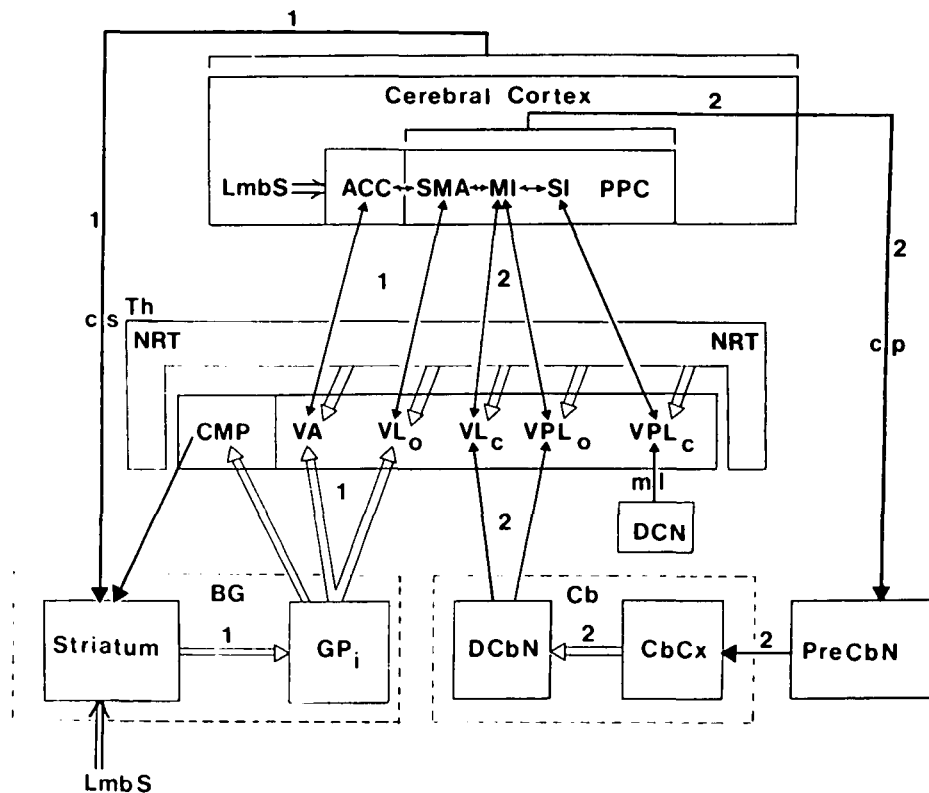

Figure 11. Medial system model. Progressive specification of the details of a discrete action can be viewed as a process whereby cortical activation becomes focused on executive regions through dynamic operation of a widely distributed system. Two sequentially activated loops are hypothesized: (1) A basal ganglia dependent loop gathers convergent input from wide regions of the cortex and then focuses its output back to restricted premotor regions of cortex via thalamic connections from the globus pallidus (GP<sub>i</sub>). It is hypothesized that this loop selects salient task-relevant features from the external context and associates these with cortical regions that can access motor subroutines. It may also be involved in the preparation of the postural basis for the action. The operation of this loop would give rise to early preparatory components of the readiness potential associated with the intention-to-act (volitional process I in Libet et al. 1982; see text section 7). It would also be through operational changes in this loop that the early phases of learning a conditional act (Sasaki & Gamba 1982) would occur. Through the operation of this loop, a strategy of movement is specified (see Nashner & McCollum 1985). This loop is bihemispherically organized and would be activated in a bilateral manner even for unilateral movement. (2) More limited regions of cortex then give rise to inputs which are directed to the cerebellar cortex (CbCx) via the pontine nuclei (PreCbN). These outputs are then focused back through projections from the deep cerebellar nuclei (DCbN) to ventrolateral regions of the thalamus which connect with the primary motor cortex (MI). This loop operates "downstream" from loop 1. It would be instrumental in the lateralization of the neural selection process with preparation of a unimanual act in which output is focused at this stage to the contralateral MI. The refinement of the execution of the act in the later phases of learning (Sasaki & Gamba 1982) and the stage of preparation marked by an acceleration of the readiness potential seen alone in association with a self-initiated act (volitional process II in Libet et al. 1982; see text section 7) would be associated with the operation of this loop. This loop functions to perform context-dependent adjustment of the parameters of the movement strategy selected by operation of loop 1. This model emphasizes the critical nature of information transmission and its control at the level of the thalamic nuclei which may be exerted by the operation of the nucleus reticularis thalami (NRT) inputs to relevant thalamic regions (Scheibel & Scheibel 1967; see text).

SMA as an interface between the cingulate cortex and other cortical and subcortical motor areas would imply that the SMA is involved in the transformation of "intent," as conveyed to it by the SHS via the cingulate cortex, into the specification of action. The SMA thus may play a key transitional role in volitional processes.

Many questions remain. The manner in which the SMAs of the two hemispheres interact during unilateral

and bimanual coordination tasks requires close examination and may be important in understanding the recovery of movement control following unilateral cortical lesions as well as providing some insight into understanding interlimb coordination. The differential participation of the SMA in controlling actions that are generated in a highly spontaneous fashion as opposed to a contextually restricted manner seems to be implied by an examination

of the behaviors associated with SMA damage. An improved understanding of the difference between the roles of the SMA and the lateral arcuate premotor area (and its human equivalent) in the programming of movements is needed, as well as a better differentiation between the participation of anterior cingulate cortex and the SMA in the synthesis of efferent motor patterns. The issue of lateralization of function in the left and right SMA should also be examined carefully.

The recent demonstration by Libet et al. (1983) that a vertex-centered readiness potential is recordable when subjects plan to move but do not subsequently commit an overt act, suggests that SMA activity is critically involved in intentional processes independent of whether or not such activity subsequently leads to action. Whether or not this activity is itself produced directly through a subjective state of the intention to act (Eccles 1982) or arises developmentally in association with a complex integration of critical limbic-originating, sensory, and subcortical inputs, the conjunction of which is dependent upon the context in which the act is being initiated (Rolls 1983), is an issue of fundamental philosophic concern.

It appears evident that further elucidation of SMA function will demonstrate a complex and multifaceted role for this area in the organization of motor behaviors. Answers to questions regarding its mode of operation will probably have far-reaching implications that will extend well beyond the usual concerns of motor control and movement psychology.

#### ACKNOWLEDGMENTS

The author wishes to acknowledge the help of the Medical Research Council of Canada, which supported this work with a Centennial Fellowship. In addition, the author is grateful to W. A. Mackay, M. Arbib, and M. E. Goldberg for reviewing earlier versions of the manuscript and for many helpful comments. The author would also like to thank H. C. Kwan, Y. C. Wong, E. A. Roy, D. Borrett, and J. T. Murphy for many hours of stimulating discussion and guidance during the development of this paper.

## Open Peer Commentary

*Commentaries submitted by the qualified professional readership of this journal will be considered for publication in a later issue as Continuing Commentary on this article. Integrative overviews and syntheses are especially encouraged.*

### A prelude to the Goldberg variations on motor organization

Jason W. Brown

Department of Neurology, New York University Medical Center, New York, N.Y. 10016

What's left out of Goldberg's target article is to my mind at least as important as what's included, namely, an outline of the theory of (action) microgenesis prior to the author's version. The theory, after all, is really an intuition based on pathological case study, for which the available physiological data – short of recording the microtemporal sequence of entrainment in the course of an action – can provide at best only limited support. The theory is most powerful in its coherent account of syndromes that are otherwise finessed by componential models. Some description of these data is therefore necessary to deter-

mine where the target article expands on or simply annotates existing theory, and this constitutes the major part of my commentary.

The idea of microgenesis developed in the Würzburg school, but the term was coined by Heinz Werner for the microtemporal unfolding of object representations. The microgenetic approach was explored in aphasia studies by Arnold Pick (1913) and (though not well appreciated) in apraxia theory by Liepmann (1920), who held that ideational, ideomotor, and limbic forms were moments in the action development. Yakovlev's (1948) paper was important in my own work (1977), as well as that of Sanides (1964; 1970; 1972).

The concept of an action microgeny underlying frontal motor and speech disorders has undergone considerable further specification (see Brown 1979; 1985). It entails the idea that symptoms of brain damage reflect normal subsurface processing mediated by the damaged region. Focal lesions disrupt this microstructure at specific points and expose stages that are otherwise submerged. Symptoms are not attenuations or regressions but subsurface levels processed normally distal to the point of damage.

In this model, an action is a cognitive representation, not a set of concatenated movements, a series of rhythmic levels sequentially entrained, retracing the pattern of evolutionary growth. The action proceeds bottom up from a cognitive core in the upper brain stem and basal ganglia – what one could call the envelope of the action – through mesial paralimbic (anterior cingulate gyrus, SMA) regions to “integration” cortex on the convexity, premotor, and then precentral areas. This sequence is reiterated in every response of the organism. The direction of processing corresponds with that of evolutionary growth, progressing from levels bilaterally organized through (in humans) an intervening stage of asymmetric representation to contralateral motor cortex. Transcortical and callosal fibers serve to maintain complementary (horizontal) levels in phase. Connections between serial (vertical) levels mediate downstream modulation. The Sanides (1970) account, which is an interpretation of growth patterns in forebrain evolution, was developed independently of the clinical model, but maps directly to the anatomical and psychological infrastructure inferred from clinical studies.

An important element in the clinical theory is that levels in action are linked to levels in other cognitive domains. The progression in the action development from its inception in archaic structures organized about the axial and proximal musculature in a primitive, body-centered space (“internal-context” dependent) toward discrete asymmetric movements with the distal musculature on external objects (goal oriented) corresponds with levels in affect, language, and object and space representation (Brown 1983). The space of successive levels in action corresponds with levels in object formation. The zeroing in on target movements in the action specification has its perceptual correlate in the featural analysis of object form. If MI mediates an end point in object representation, then VI mediates an end point in object representation. One cannot buy an evolutionary model of action without the complementary model of perception. On the other hand, microgenesis explains many aspects of action theory not dealt with in purely motor accounts. For example, the coextension of deep (limbic) levels in action with the limbic mediation of prelinguistic conceptual levels in language and perception establishes a contextual background within which the act develops.

Similarly, motivation and volition are not underpinnings of the action but accompaniments of its development. Some actions appear instinctual, others purposeful or goal oriented, still others volitional, in the sense that decisions are made, actions can be delayed, even withheld in pursuit of a goal. Drive develops to states that can be characterized as purposeful or volitional. Disturbances at different moments in microgenesis have different impacts on these states. Intention, the feeling that one is an agent who acts, and the distinction of passive and

active movements, are part of the temporal unfolding of the action, its forward direction and continual surge to externalization.

The clinical material demonstrates that frontal symptoms correspond with successive moments in action microgeny. These can be briefly described as follows:

1. Damage to basal ganglia, and then frontal limbic formations, disrupts the motor envelope, first involving action in "body-on-body" space (Yakovlev 1948), then action in the ego-centric or volumetric space of limbic cognition. There is impaired activation involving the action as a whole (akinetism) or partially (mutism, limb inertia). Fragments are seen in hypoactivity, motor neglect, and lack of spontaneity. Perseveration and response bias are also related to disturbed initiation. Persistence in a behavior is the other side of the inability to go on to the next. Early stages in action generation are bound up with oscillators laying down the respiratory pattern (the breath group of a vocal action), posture, and kinetic rhythms of locomotor function (Bernstein 1967; Schepelmann 1979).

2. Damage to dominant "integration" or premotor cortex on the convexity leads to derailment of the action after adequate initiation. Frontal apraxia involves substitution or defective selection of partial movements. Distractibility and frontal confabulation with bilateral lesions represent derailments within the action structure midway between its activation and final implementation. The view of an action as a derivational series of rhythmic or oscillatory levels helps to explain disorders associated with disruption at this stage: apraxia in relation to motor timing; agrammatism and dysprosody as a disruption of an oscillator – derived (? as a harmonic) from the preceding level – elaborating the rhythmic or prosodic contour of an utterance.

3. Damage to premotor and precentral cortices leads to a defect at the final implementation. The rhythmic structure of the action unfolds to a temporal program which lays down the sequence of digital and articulatory movements. In speech there is misarticulation, then anarthria (phonetic disintegration); in limb action, substitution of partial movements gives way to dyspraxia or clumsiness centered on the distal musculature, and ultimately limb paralysis.

From the pathological series, we can infer that an action has a dynamic and hierarchic structure. This structure begins at a base level (motor envelope) combining an incipient vocal and somatic movement in an archaic space centered on the body axis. The action is organized about the axial and proximal musculature, linked to respiratory and other rhythmic automatisms, and close to motivational and driveline states. Through mesial paralimbic cortex, there is further specification and an isolation of limb, body, and vocal motility. The internal context of the action is established through links with limbic cognition, a stage of symbolic and conceptual organization in which drive fractionates to partial affects. Space is volumetric; an external world is not yet present. There is incipient purposefulness attached to the action; it becomes goal directed as its object undergoes simultaneous differentiation. The final specification into articulatory and (asymmetric) digital movement coocurs with the analysis of object form and the phonological encoding of emerging lexical representations. Cognition is relatively affect free. Action and object space exteriorize together. The feeling of volition requires perceptual exteriorization; volition is the feeling that actions lead outward to a world of stable objects.

This, then, is an outline of the microgenetic theory of action as it has been reconstructed from the case material. Goldberg describes in detail the connectivity of this model and attempts to resolve thalamic and cerebellar contributions. One hopes that this attempt will be viewed as successful, but as noted, the microgenetic account has implications for processing beyond those of action theory. There is a parallel with the microgenesis of language and perception that also needs to be addressed. This theory of action entails primary "sensory" cortex mediating an end point in the microgeny of object representations, not an

early stage of in-processing. Moreover, the account of cortico-thalamic loops should take into consideration the fact that cortical sites in action microgeny are linked to the evolution of the thalamus, since cortex and thalamus are probably functionally coupled in relation to patterns of phylogenetic growth. Clearly, in some sense everything has to be explained before anything can be understood. But we have to start somewhere, and as a good a place as any to begin is with the agenda set forth in the target article, calling for a new direction in neuroscience research.

## Understanding the mind's will

Antonio R. Damasio

Department of Neurology, University of Iowa College of Medicine, Iowa City, Iowa 52240

Few regions of the human or nonhuman primate brain have been as extensively studied as the supplementary motor area and the nearby anterior cingulate. The past decade, in particular, has seen an accumulation of first-rate scientific data obtained by diverse methodological approaches such as neuroanatomy, neurophysiology, clinical neurology, neuropsychology, and neuroradiology. Nonetheless, no consensus has developed regarding the possible functional role of this region. Far less intense scrutiny of other regions of the sensory or multimodal association cortices has produced far greater agreement among researchers. This is not altogether unexpected and might be seen as the fate of higher-order integrative systems of the frontal and anterior temporal cortices. Curiously, nonetheless, I believe there is little justification for such indecision, as the lucid and trenchant review by Goldberg demonstrates. I am in agreement with most of the emphases of his argument and with the general conclusion that the SMA performs a key role in the cerebral organization of action. More specifically, I agree with the notion that the SMA plays a crucial role in volitional processes. All the data collected by Gary Van Hoesen and myself, in animals and humans, points strongly in that direction (see Damasio, Van Hoesen & Vilensky 1981). This region provides the royal avenue, into the cerebral cortex, of the limbic input that pertains to willed movement. A not insignificant result of conceptualizing it in this light is that anatomical and functional knowledge about the SMA and its vicinity will permit us to model the neuronal substrates of the *will* and thus overcome a persistent objection of those who favor a dualist position regarding mind and brain (see Eccles 1984).

Many aspects of the SMA question remain to be properly resolved. The relation to emotion and affect which is so apparent in *cognitive studies of individuals with damage in this area* (see Damasio & Van Hoesen 1983) must be explored further. The relation to language proper must also be clarified further. I believe this relation is nonexistent and that the supplementary motor area has been mentioned in the same breath with language and its disorders only because it plays a role in movement, and inevitably affects both speech production and the will to communicate (see Damasio & Geschwind 1984). It is intriguing to note that there is no convincing evidence for the left and right SMAs in humans having fundamentally different roles; that is, there is no evidence for a dominance effect in this system, something that would have been expected were the system to be an inherent part of cerebral language devices. But here, too, further empirical work is needed.

## The path to action

J. M. Fuster

Department of Psychiatry and Brain Research Institute, University of California, Los Angeles, Calif. 90024

Goldberg's hypothetical model accommodates many facts of phylogeny, anatomy, and physiology of the premotor cortex.



The case for the functional duality that he proposes is assisted mainly by evidence on connectivity and clinical symptomatology. Less direct and less convincing is the support from electrophysiological or animal-lesion studies. However, all the literature reviewed contributes to better understanding of the premotor cortex, the SMA (supplementary motor area) in particular. The proposed mediolateral differentiation is generally plausible and does not seem seriously challenged by anything we know thus far.

Here I should like to call the attention of the author and the reader to another functional differentiation within the frontal neocortex: an antero-posterior gradient of neural involvement in progressively more specific aspects of movement. In terms of cortical geometry, this differentiation is orthogonal to the one Goldberg emphasizes, but conceptually it is not. In fact, the evidence for it complements his model.

There appears to be, in the frontal lobe of humans and monkeys, a hierarchy of cortical areas participating in the organization of behavior. At the top of that hierarchy, to deal with the schemes of behavior, is the associative cortex of the frontal pole, the prefrontal cortex. In the monkey, that part of the cortex is limited posteriorly by the arcuate sulcus; in the human, it includes the areas designated "frontal" and "prefrontal" in Campbell's map (Figure 2). At the bottom of the hierarchy, to deal with the concrete aspects of action, with its microgenesis (Brown 1977), is the MI cortex. Whether there is also hierarchical organization within the large prefrontal region is not clear, but it is likely. Be that as it may, we can construe a processing order from prefrontal areas, through premotor areas, and onto the motor strip, following the general direction of the "arrow" that the principal and arcuate sulci design on the frontal lobe of the macaque. Each stage probably involves reentrant loops through the posterior neocortex, basal ganglia, thalamus, and cerebellum. The connective framework for all that has been anatomically substantiated, but the details of connectivity and mechanism are still unclear.

I submit that the processing toward action, down that cortical hierarchy, is done by recruitment of different frontal areas in varying degrees depending on the temporal breadth and complexity of the behavioral structure that the organism is forming. Simple motor actions and reactions may only involve MI or no frontal cortex at all. Context-dependent and goal-directed behavioral sequences, on the other hand, may involve the entire hierarchy. The prefrontal cortex, and the premotor and motor areas under it, would be critical for those behaviors that require mediation of important cross-temporal contingencies between perception and action (in terms of behavioral integration, cross-spatial contingency is to a large extent reducible to contingency across the time domain, for the simple reason that the organism cannot attend simultaneously to widely spaced objects or locations).

In other words, the longer and wider the perception-action cycle (Neisser 1976; Weizsäcker 1951); the more anterior the range limit of frontal areas needed to close it. Thus, not surprisingly, the prefrontal cortex, and the long cortical and subcortical circuits of which that cortex is a part, are essential for the mediation of the cross-temporal contingency within a single trial of a delay task, such as delayed response or delayed matching to sample (Fuster 1981).

Briefly stated, all frontal areas probably participate to some degree in the temporal organization of behavior, and the most anterior ones, those that constitute the prefrontal region, are especially critical for the integration of behavioral structures that depend on the bridging of substantial discontinuities between percept and action. At the cognitive level, the bridging of those discontinuities relies on two functions: a temporally prospective function of anticipatory set and a temporally retrospective function of short-term (working) memory. In my view (Fuster 1981), these are the two basic functions of the dorso-lateral prefrontal cortex and the foundation of its role in the temporal organization of behavior. I would suggest that those

two functions are simply the expansion, in the temporal (and cognitive) domain, of the two physiological components of the organization of action that Goldberg sees represented in two sectors of the premotor cortex.

To support my contention I would like to focus briefly on single-unit data obtained in the context of behavioral paradigms in which, basically, a given motor act follows, and is contingent upon, a sensory signal. Such data indicate that, in MI, the activity changes of pyramidal tract neurons are closely associated in time with the motor act. When not coinciding with the act, those changes precede it or succeed it, at the most, by only a few hundreds of milliseconds (Tanji & Evarts 1976). In premotor areas we find, by comparison, a looser temporal relationship between firing change and motor act. There, more units are seen in which the signal evokes discharge changes preceding the movement by seconds (Tanji, Taniguchi & Saga 1980; Weinrich & Wise 1982). However, as Goldberg points out, no distinction can be made between medial and lateral premotor cortex on the basis of the unit data obtained so far.

As we move into prefrontal areas, we encounter an even looser temporal relationship between cell discharge and motor action. Through the use of proper paradigms (delay tasks) it can be seen that the signal elicits sustained prefrontal-cell reactions that precede the motor act by several tens of seconds, indeed by minutes (Fuster 1973). Those reactions are not simple sensory afterdischarges, but are contingent on the prospective occurrence of the act (Fuster, Bauer & Jervey 1982). We have been led to conclude that such sustained changes of discharge are related to the two cognitive functions, short-term memory and set, that I have mentioned above (Fuster 1984). Again, however, we are unable to discern, on unit grounds, a topographic separation of those two functions within the prefrontal cortex. Only at the microscopic level can one find a semblance of such separation (Fuster et al. 1982).

To summarize, as we proceed upstream from MI toward more rostral areas, we observe a progressive temporal decoupling of action from the cellular discharge that precedes it and that presumably reflects the participation of neurons in its integration. We also observe a greater dependency of that discharge on the sensory signals that determine the action and precede it by substantial periods of time. These cellular manifestations, in my opinion, reflect a gradient of increasing neuronal involvement, up the hierarchy of frontal areas, in the bridging of progressively longer cross-temporal contingencies. Thus, the gradient that Goldberg in his review traces from MI to premotor cortex does seem to extend polarward into the prefrontal cortex.

In conclusion, unit data, together with data from similarly fragmentary lesion and metabolic studies, suggest that the path from associative (prefrontal) cortex to primary (motor) cortex leads from the broad scheme to the particulars of the action, from the mediation of cross-temporal contingencies involving the plan and the goal to the immediate integration of sensory-motor reaction, a path from the general to the concrete. In a way, the hierarchical descent of motor processing in frontal cortex is the converse and mirror image of the hierarchical ascent of sensory processing in the neocortex behind the central sulcus. There, in posterior cortex, sensory processing, for at least three modalities (Jones & Powell 1970), goes through a hierarchy of cortical stages (probably also involving some as yet unclear subcortical loops), from primary sensory cortex toward polysensory areas and areas of cross-modal association; it is a path from sensation to perception, from the concrete to the general.

Associative areas of both posterior and frontal cortex, and the fiber connections that link them, close the neural cycle that constitutes the substrate of the perception-action cycle at its highest level. At that level, judging from the range and abundance of afferents to prefrontal cortex, the reentrant (feedback) inputs are most diverse and also probably most relevant for the general organization of behavior in the time axis. The SMA, downstream from there, may indeed be the important process-

ing link that Goldberg postulates it is for further specification and elaboration of action.

## Systems and system interactions

J. A. Gray

Department of Psychology, Institute of Psychiatry, London, SE5 8AF, England

Goldberg's target article represents a welcome addition to the growing practice of seeking in the brain, not for a single, discrete structures that can underlie a particular psychological function, but rather for integrated systems able to discharge computational functions that map only loosely onto the traditional categories of psychology. But, although the overall approach is laudable, it misses out what could have been (I believe) one useful contribution, namely, that from learning theory. Whereas the anatomical terms in the argument are well defined, some of the psychological concepts (e.g. "intention" or "action") are not. Indeed, one is in general left to interpret these concepts in their everyday sense, as though the whole enterprise of behavioural analysis and scientific psychology had been a waste of effort. This would be a defensible position if there had been no progress in the analysis of the psychological concepts with which Goldberg deals. However, this is not the case. Recent years have seen considerable progress in the development of theories capable of explaining how an animal learns and executes goal-directed responses (see, e.g., Gray 1975, and Toates, in press). Indeed, I believe that I detected at one or two points in the target article an encouraging homology between the concepts developed by Toates (in press) and Goldberg.

A further encouraging feature of the target article is the way in which it attempts to integrate Goldberg's own system with the systems described by others and attributed to other regions of the brain. My own model of septo-hippocampal function (Gray 1982a, 1982b) is one of the systems picked out in this fashion. In general, I am in agreement with the particular mode of integration that Goldberg proposes. However, I must make one correction: As I have described it, the septo-hippocampal system is concerned only with monitoring the successful achievement of intentions, not with their transformation into action. I explicitly attribute this latter function to other systems in the brain, and I would have thought the system described by Goldberg suitable for this purpose. The interactions between the two systems that I would then envisage are: (1) the supplementary motor area would transmit to the septo-hippocampal system information about which action plans are in progress; and (2) the septo-hippocampal system would inhibit a motor programme currently running in the supplementary motor area if it detects mismatch between actual and expected outcomes.

## The starting function of the SMA

H. H. Kornhuber and L. Deecke

Abteilung Neurologie, Universität Ulm, D-7900 Ulm, Federal Republic of Germany

Whereas Goldberg's target article bases its functional interpretation mainly on anatomical and evolutionary arguments, especially from Sanides (1970), our ideas come from functional data. The discoverers of the supplementary motor area (SMA), Cecile and Oskar Vogt (1919) and the early discussants (principally Kleist 1934 and Foerster 1936) likewise based their interpretations on functional data. The difficulty with anatomy is its ambiguity. For example, on the basis of connectivity Wiesendanger, Seguin, and Künzle (1973) attributed postural function to the SMA. The argument that field-potential

amplitude data are ambiguous has been overcome by the demonstration that the large SMA readiness potential (RP) is independent of potential sources in MI (primary) motor cortex (Deecke & Kornhuber 1978).

In our view the main point that the RP preceding voluntary movement is maximum over the SMA for all movements so far investigated, including finger (Figure 1), hand, toe, mouth, tongue, speech, and eye movements (Becker, Hoehne, Iwase & Kornhuber 1972; Boschert, Hink & Deecke 1983; Deecke, Scheid & Kornhuber 1969; Grözinger, Kornhuber & Kriebel 1979). It seems difficult for most researchers in the field to see the full significance of these data because of the common preoccupation with the omnipotence of the MI motor cortex. Only when we realize that the motor system is decentralized (Kornhuber 1984b) can the uniqueness of the close temporal association of the onset of movements (as different as those of eyes, fingers, and vocal apparatus) with a preceding potential in the SMA be seen.

Because of this functional uniqueness a motivational role with emphasis on the will has been ascribed to the SMA (Kornhuber 1980). However, motivation is a complex function with several independent subfunctions concerning *what* to do, *how* to do it, and *when* to start. The latter function, that of finding the right moment for action, is in our view the task of the SMA (Kornhuber 1984a). This becomes clearer when one compares different motivational situations: In the experimental situation usually used in RP investigations, for example, self-paced simple finger or eye movements, only the SMA becomes active, not the rest of the frontal lobe. If motivation is required to modify motor programs in motor learning, however, the whole convexity of the frontal lobe shows a large surface-negative potential, the amplitude of which shows a significant positive correlation with the success of the learning (Lang, Lang, Kornhuber, Deecke & Kornhuber 1984). On the other hand, in an experimental situation using a manual pursuit movement, which requires attention to an unpredictable stimulus direction but provides a fixed time for the change in direction so that the *temporal* sequence of events is foreseeable, the SMA shows anticipatory activity. It gives rise to a large negative potential, which terminates 500 msec prior to the end of the directed attention potential over parietooccipital areas (Deecke, Heise, Kornhuber, Lang & Lang 1984) (see Figure 2, p. 592).

The supervision of *what* to do and *how* to do it may be provided mainly by the orbital cortex and the frontolateral cortex, respectively (Kleist 1934), although the close temporal association of the RP in the SMA with the onset of voluntary movements fits well with the function of governing *when* to do it, the final "go." Finding the right moment for action involves taking into account both the external and the internal situations. For example, it normally makes little sense to perform a goal-reaching movement in a situation where the subject is falling. The ancient Greeks saw the importance of the right moment; they had a special term for it, "kairós." The SMA RP is larger when the right moment for starting the movement really matters, such as in simultaneous bilateral finger movements, in which the RP in SMA clearly starts earlier than the one in MI (Kristeva & Deecke 1980).

The afferent connections of the SMA seem to be suitable for this function. Whereas the frontolateral cortex, which has to consider *how* to do something, receives afferents mainly from teleperception (hearing and vision), the SMA gets strong afferents from the parietal lobe, which represents integrated knowledge of postural, proprioceptive, and motor conditions. In addition, however, the SMA has strong afferents from the limbic system, from the mediodorsal nucleus (which in turn receives input from the hypothalamus), and from the basal ganglia; it also gets input from the ascending activating system. There is further input from the amygdala, calostrum, prefrontal cortex, and so on. Thus, the SMA is one of the rare universally connected areas of the brain, as should be the case for a key structure making decisions as to the right moment for action.

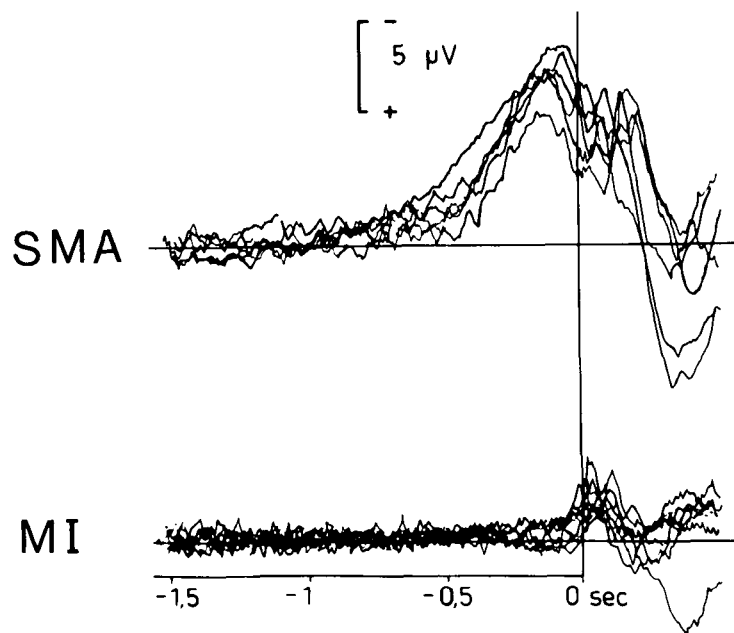

Figure 1. (Kornhuber & Deeke). The readiness potential (RP) over the SMA (recorded against a linked-ear referent) preceding fast flexion movements of the right index finger has its maximum about 100 msec prior to the onset of movement in the EMG (electromyogram) (top, SMA; time 0 coincides with flexor digitorum EMG onset). The motor-cortex hand-area potential, called motor potential (MP) (bottom, MI; recorded bipolarly between the left and right precentral leads) rises about 50 msec preceding EMG onset. This latency corresponds to the firing onset of area 4 pyramidal tract cells. The onset of the decline of the RP (called premotion positivity, PMP; Deecke, Scheid & Kornhuber 1969) is, on the average, about 30 msec earlier than the MP onset. This latency allows for both direct and indirect activation from SMA to MI via cerebellum and basal ganglia. Superposition of experiments with the same subject on different days. Modified from Deecke, Grözinger, and Kornhuber (1976).

Finally, deficits from SMA lesions also seem to fit this functional interpretation. Although unilateral lesions are soon compensated for because of the bilateral representation and the bilateral interconnection of the SMA as stressed by Goldberg, such patients hesitate in starting movement; this becomes even more obvious for actions composed of several movements, as was first reported by Foerster (1936) and confirmed experimentally by Brinkman (1981; 1982), who investigated bimanual coordination in monkeys. Unilateral *chronic* SMA lesions do not cause much deficit either, although mild troubles in concept formation have been reported (Wallesch, Kornhuber, Köllner, Haas & Hufnagl 1983). Large bilateral frontomedial lesions including the SMA in humans abolish initiative and will (Hassler 1980); findings in one of our own patients with bilateral vascular frontomedial lesions confirm these results.

### Volitional processes (planned, spontaneous and conscious) in relation to the SMA

Benjamin Libet

Department of Physiology, School of Medicine, University of California, San Francisco, Calif. 94143

On the basis of his comprehensive review and integration of various lines of evidence, Goldberg concludes that the “medial premotor system” (which includes the supplementary motor area, SMA) is predominantly involved in feed-forward, predictive control of movement, operating relatively independently of sensory, particularly visual, feedback (see loop 1 of the model,

Figure 11). The specification of efferent details required to execute the act is then provided through a second route (loop 2), operating via a lateral premotor–motor system in which output is focused in contralateral primary motor cortex. I first raise some points about the nature of the evidence in relation to Goldberg’s conclusions and how that affects the resulting model; then I comment on the relation of proposed SMA functions to the subjective or conscious intention to act.

Goldberg heuristically relates the operation of his proposed loops 1 and 2 to the sequentially timed volitional processes I and II, respectively, which were identified by Libet, Wright, and Gleason (1982). Process I involves a general or loose intention to act soon; it is associated with a ramplike readiness potential (type I RP) that begins one or more seconds before the act. Process II involves the more specific urge or intention that more immediately precedes the act; it is associated with a component of the readiness potential (type II RP) that begins at about –575 msec (see Libet et al. 1982).

Two features of the type II RP and its related volitional Process II seem at variance with the characteristics assigned by Goldberg to his loop 2. (a) The type II RP can appear without any preceding type I “ramp” when acts are both spontaneous and fully endogenous, with no experience of planning reported by the subjects. If loop 2 is to be associated with our volitional process II in a self-initiated act, then it would not necessarily be operating “downstream” from loop 1 (unless one broadened the concept of loop 1 to include processes much more general in nature and timing, rather than those associated with a type I RP and preparatory processes in the SMA). (b) Type II RPs, associated with spontaneous self-initiated acts without planning, exhibit a substantial dominance at the vertex; the simul-



## VISUAL TRACKING

### Supplementary motor area, midline

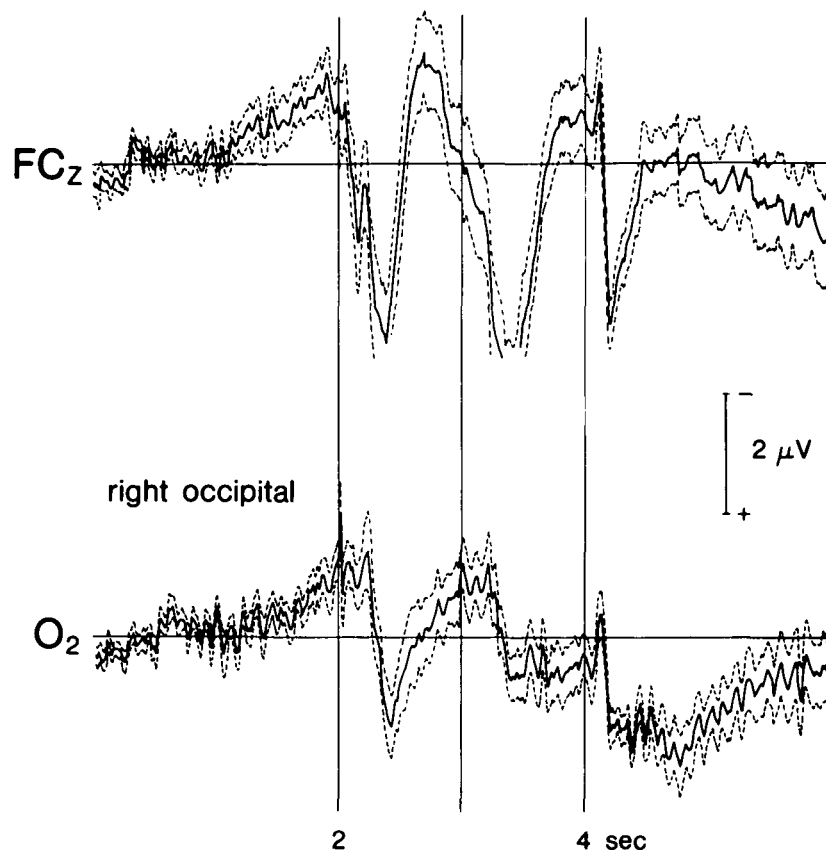

Figure 2. (Kornhuber & Deecke). Anticipatory behavior of SMA ( $FC_z$ , top) and directed attention potential of the occipital lobe ( $O_2$ , bottom) in a visuomotor hand-tracking experiment in which the subjects started the stimulus sequence by a self-paced hand movement which is preceded by an RP and occurring at time 2, at which time the self-delivered visual stimulus (point on a television screen) started to move randomly. At time 3, a sudden change in movement direction occurred. At time 4 the stimulus movement stopped and returned to the starting position. In this situation, where the time sequence is predictable for the subject, the SMA shows a large anticipatory potential that occurs in advance of the change in movement direction but goes to rest (with a positive potential) about 300 msec before the change in direction. By contrast, the occipital and parietal cortex still pay attention while analyzing the new direction of the stimulus. In this experiment, even the motor-cortex hand area contralateral to the moving hand showed a positive (relaxation) potential during tracking. The movement is obviously executed – under the guidance of the occipital and posterior parietal areas – by subcortical mechanisms. In this paradigm featuring a fixed-time program, the SMA gives its “go” command well in advance and leaves the final execution of the action to those cortical areas that have the best information as to when they have finished their stimulus-dependent sensory analysis. Grand averages over 16 subjects; broken lines, standard error. From Deecke, Heise, Kornhuber, Lang and Lang (1984).

taneously recorded RP over the contralateral precentral (motor area) site was only about half that at the vertex, although it was considerably larger than that at the ipsilateral precentral site. This suggests that the SMA (and the medial premotor system) plays an important role even during most of the 0.5 sec just preceding the act; if so, the volitional phase represented by loop 2 could not be a function simply of the lateral premotor system, although the latter would undoubtedly be engaged during this time. It would appear, therefore, that the operation of loops 1 and 2 should not necessarily be designed to operate in the sequentially delineated fashion proposed by Goldberg, and that the medial system (or at least its SMA portion) is in fact involved

in the preparation of spontaneous, endogenous acts even to within approximately 50–100 msec before the outflow from the motor cortex (Libet et al. 1982; Libet, Wright & Gleason 1983).

Goldberg cites evidence that distinguishes between SMA and the arcuate (or lateral) premotor area partly on the basis of the latter’s “access to . . . processed polymodal sensory information” (see Table 2). He suggests that this differential connectivity is consistent with the hypothesis developed in his paper, that the SMA is involved in the “model- . . . driven, feed-forward, predictive mode of control which may rely on efference copy for internal error correction,” whereas the lateral premotor system may be important in responsive actions which depend

upon sensory (especially visual) feedback for correction. However, there is in fact direct evidence that the SMA in humans itself generates large late components of ERPs elicited by all modalities of sensory input – somatosensory, auditory, and visual (Libet, Alberts, Wright, Lewis & Feinstein 1975; confirmed in part by Buser, Bancaud & Chauvel 1985). (Our original data were included in a published symposium article and Goldberg cannot be blamed for having missed it.) Such findings indicate that the SMA, in man at least, does receive and respond to polymodal sensory information. How such information is used by the SMA in its functioning is not clearly known, but the possibility that peripheral sensory information does play some significant role even in the organizing of a spontaneous voluntary motor act should perhaps not be excluded.

How the introspectively conscious intention to act may be related to conclusions about the SMA, as an area of transformation of intent and volition into motor action, is a question mostly avoided by Goldberg except for a remark near the end of the conclusions and a reference to Eccles (1982). Some observational evidence on this fundamental question does exist and may begin to form a basis for further development, if the question is directly confronted. (a) Among the effects of lesions of the SMA in human subjects, as reviewed by Goldberg, is the striking loss of spontaneity of movement even when subjects can move appropriately in response to external cues or commands. The further informative question would be, Do the patients still experience conscious intentions or desires to move or act even though such spontaneous endogenous acts are not being expressed? This question does not appear to have been actively and definitively pursued by those who have studied the relatively rare individuals with SMA lesions, although a more thorough search of the literature on this specific point might turn up more. From Luria's (1966) extensive report about patient "Ch," one gains the impression that the subject may still have experienced intentions to act even though his disorder included not only a deficiency of voluntary and verbal motor expression but also some disturbance in developing and organizing the thought patterns that may precede some motor actions; however, direct questions about the patient's conscious feelings of intention were apparently not put or reported by Luria. Laplane, Talairach, Meininger, Bancaud, and Orgogozo (1977) suggest that the SMA functions to initiate spontaneous movements, but they also fail to report direct interrogations of the patients on their introspective feelings of intention and the like. (b) Libet, Gleason, Wright, and Pearl (1983) have provided evidence that SMA activity, as presumably reflected in the vertex-centered readiness potential, begins substantially before the subject is consciously aware of wanting or deciding to move. Whereas this indicates that spontaneous voluntary acts are initiated unconsciously, it does not exclude conscious control. (This whole issue is now discussed fully by Libet in this issue of *BBS*.) The suggestion in Goldberg's conclusions, that the SMA may translate or integrate "limbic inputs conveying internal decisions about action plans," could conceivably be part of the unconscious initiating process. But the question of where and how any final conscious triggering or vetoing of the volitional motor action is imposed – as, for example, possibly in the SMA – remains a potentially investigatable one.

## Preparation yes, intention no

E. J. Neafsey

Department of Anatomy, Loyola University Medical Center, Maywood, Ill. 60153

Although I agree with much of Goldberg's target article and am impressed with the major synthetic effort his review represents, I nonetheless remain unconvinced that the SMA (supplementary motor area) is importantly involved in the "intention-to-

act." I do not mean to imply that the SMA is not involved in the brain's "preparation-to-act"; the data Goldberg has reviewed, including my own work in the laboratory of Buchwald and Hull (Neafsey, Hull & Buchwald 1978a; 1978b), has clearly demonstrated that the SMA is one of a number of brain regions that become active relatively early in the process of generating a spontaneous movement. My disagreement is with the word "intention," which implies some type of mental state or conscious experience. The studies in humans that Goldberg himself cites seem to demonstrate clearly that stimulation or lesion of the SMA causes no loss of the intention-to-act. For example, Penfield and Welch's (1951) patient whose SMA was stimulated reported no disruption of his intention to move; it was his execution of the act that was impaired. Similarly, Luria's (1966) patient with a presumed SMA lesion did not lose the capacity to form an image of his intended act or the actual intention to act. Finally, Goldberg's own report of the alien hand sign following SMA lesions (Goldberg, Mayer & Togli 1981) suggests that the SMA does *not* act as a substrate for mental intention since these movements were unintended; that is, intention was intact and not lost following SMA damage. Perhaps more relevant to the question of what the SMA's role is in preparing to act is the recent finding from my laboratory by Sievert (1985) that the rat's presumed SMA (Neafsey & Sievert 1982) is the only cortical area with corticospinal terminations in the *medial* part of the ventral horn. This region contains motor neurons projecting to axial musculature as well as interneurons that give rise to propriospinal connections (Kuypers 1981). These findings suggest that the SMA may be more concerned with postural stabilization and other more "general tetrapod" functions (Sanides 1970, as cited by Goldberg), possibly involving interlimb coordination. As Goldberg has pointed out, stimulation in the SMA often evokes bilateral limb movements (Penfield & Welch 1951; Wiesendanger, Sequin & Künzle 1973).

I would also like to suggest that in his conceptualization of the medial and lateral premotor systems Goldberg consider the possibility that the medial system may *not* be derived from the hippocampal source that Abbie (1940) and Sanides (1970) have proposed. Yakovlev (1968) has suggested that a significant part of the frontal lobe is derived from the paleocortex of the olfactory lobes rather than from the hippocampus. This suggestion has been confirmed by the work of Haberly and Price (1978) and Wyss and Sripanidkulchai (1983) who have shown that the medial allocortex of the frontal lobe, the ventral tenia tecta, is a typical olfactory cortex and not hippocampal cortex. If the medial premotor system does not derive from the hippocampus, the predictive, "hippocampal" mode of operation ascribed to it by Goldberg becomes less certain.

Yakovlev's (1959) work may also suggest a possible explanation for the greater "bilaterality" of more medial cortical areas such as the SMA. He has pointed out that in the developmental abnormality known as holotelencephaly (or holoprosencephaly) the originally unpaired telencephalic vesicle remains undivided because of failure of the saggital fissure to develop. This suggests that the more medial cortical areas are more bilateral in function because they developed from a single, unpaired midline cortex with bilateral descending projections.

Another issue on which I disagree with Goldberg is his attribution of a "limbic drive" or motivational function to the anterior cingulate cortex (ACC). Recent anatomical work (Baleydier & Mauguière 1980; Vogt, Rosene & Pandya 1979) has tended to remove the ACC from the limbic-system orbit by failing to confirm projections from the anterior thalamic nuclei to the ACC. The thalamic projections to the ACC appear instead to arise from the midline, intralaminar, mediodorsal, and ventral anterior nuclei. The recent description of significant projections from the monkey ACC to the superior colliculus (Leichnetz, Spencer, Hardy & Astruc 1981) also suggests the ACC may be more related to attention or orientation than to motivation or drive.

On a more general note, Diamond (1979) has suggested that the "motor cortex" should be defined as layer V of the entire neocortex rather than as the precentral gyrus. If the entire cortex is thus viewed as "motor," it becomes unnecessary to construct schemes of cortical function based on extensive corticocortical *sequential* interactions which finally lead to motor output from the precentral gyrus. It makes more sense to try to define the particular "motor function" of each individual cortical area and to consider the cortex as a whole to be made up of a *parallel* array of sensory-motor processors which have some limited communication with each other via corticocortical connections. Schell and Strick (1984) have suggested a similar idea in their important paper on the thalamocortical relations of MI, SMA, and APA.

Although this commentary has been somewhat critical, I found Goldberg's review and proposal extremely useful and stimulating. The paper is an excellent effort at a comprehensive synthesis of how the motor system works that should provoke much discussion and experimental work.

### Architecture and connections of the premotor areas in the rhesus monkey

Deepak N. Pandya and Helen Barbas

Edith Nourse Rogers Memorial Hospital, Bedford, Mass. and Department of Anatomy and Neurology, Boston University School of Medicine, and Department of Health Sciences, Boston University, Boston, Mass. 02215

To help gain understanding of the structural organization of the supplementary motor area, Goldberg has used an evolutionary-architectonic approach proposed by Sanides (1970). According to Sanides, the medially situated supplementary motor area (SMA) has evolved from the archicortical (hippocampal) moiety, whereas the ventrolateral arcuate premotor area (APA) has its origin in the paleocortical (olfactory) moiety. On the basis of the differential origin of these two premotor areas, along with a series of connectational, behavioral, physiologic, and clinical observations, Goldberg has proposed a distinct functional role for these premotor areas. Although neither the supplementary motor area nor the ventrolateral arcuate premotor region is critical for the execution of a motor act per se, each area seems to have a unique role in motor behavior. Thus the SMA seems to be involved in the intentional aspect and initiation of movement and is influenced by interoceptive stimuli. On the other hand, the APA has been implicated in motor tasks in response to exteroceptive stimuli.

The evolutionary-architectonic approach, viewed in isolation, has been considered a rather esoteric tool in the study of cerebral organization. However, in conjunction with connectational characteristics, evolutionary architectonics has proved fruitful in the investigation of a number of cortical regions (Barbas & Pandya 1982; Galaburda & Pandya 1983; Pandya & Sanides 1973). We have used this approach to study the organization of the premotor cortex in the rhesus monkey (Barbas & Pandya 1981). Although we concur with the basic approach proposed by Goldberg, we would like to include some additional observations.

The premotor cortex can be broadly subdivided into a dorsal and a ventral sector (Figure 1). The dorsal premotor region extends medially to the upper bank of the cingulate sulcus, and the ventral premotor region extends up to the frontal operculum. The dorsal premotor cortex is basically agranular, whereas the ventral (APA) is characterized by an incipient granular layer interposed between layers III and V. On the basis of the evolutionary-architectonic approach, the dorsal premotor region originates in the proisocortex of the cingulate gyrus (area 24, archicortical moiety), from which a series of successive laminar changes are observed dorsally toward the spur of the arcuate sulcus. The ventral premotor cortex shows a comparable sequential laminar differentiation originating from

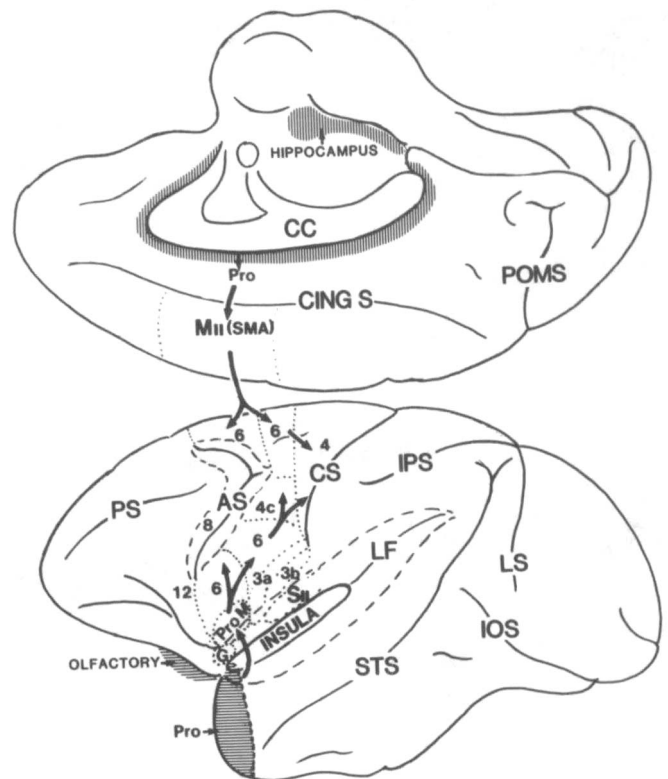

Figure 1. (Pandya and Barbas). Diagrammatic representation of dorsal (hippocampal-cingulate) and ventral (olfactory-insular) architectonic trends showing progressive architectonic steps leading to dorsal and ventral sectors of premotor (area 6) and motor (area 4) cortices in macaca mullata. Note that the dorsal (SMA) and ventral (pro M) supplementary motor areas are interposed between their respective proisocortices (pro) and premotor regions (area 6). Abbreviations: AS, arcuate sulcus; CC, corpus callosum; CING S, cingulate sulcus; CS, central sulcus; IOS, inferior occipital sulcus; IPS, intraparietal sulcus; LF, lateral fissure; LS, lunate sulcus; POMS, parieto-occipito-medial sulcus; PS, principal sulcus; STS, superior temporal sulcus.

the insular proisocortex (paleocortical moiety), and proceeding dorsally toward the spur of the arcuate sulcus where the dorsal and ventral premotor trends meet. These two premotor trends differentiate further caudally toward the motor cortex.

In the above schema the supplementary motor area occupies the medial part of the dorsal premotor region and is viewed as one stage in the progressive architectonic differentiation of the dorsal premotor trend. It should be noted that the supplementary motor area contains a rather complete, albeit crude, representation of the body (Woolsey, Settlage, Meyer, Sencer, Hamuy & Travis 1952). In contrast, the laterally situated dorsal premotor cortex contains predominantly the representation of the trunk. The ventral arcuate premotor region contains in part a representation of the head and neck. Within the ventral premotor region the frontal operculum seems to be at an architectonic stage equivalent to that of the medial SMA, and can thus be considered as a ventral supplementary motor area (ProM) on architectonic grounds. Whether this view will be supported by other experimental approaches remains to be established.

The dorsolateral and ventrolateral sectors of the premotor cortex have several distinguishing connectational features (Figure 2; Barbas & Pandya 1981; Godschalk, Lemon, Kuypers & Ronday 1984; Muakkassa & Strick 1979). The rostral portion of the dorsolateral premotor cortex is reciprocally connected with the neighboring dorsal prefrontal cortex and with the dorsocaudal premotor region, but not with the motor cortex. On



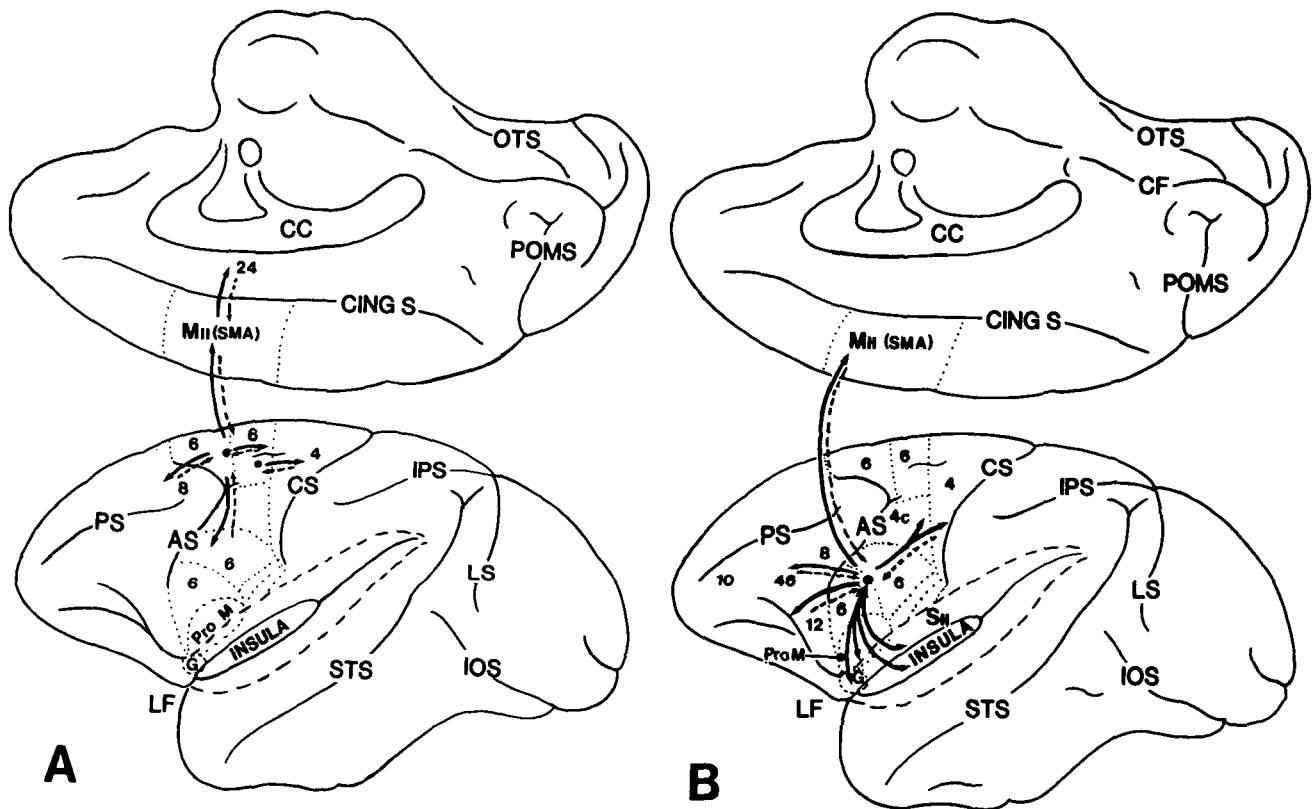

Figure 2. (Pandya and Barbas). Diagrams showing intrinsic (vicinity) connections of dorsal (A) and ventral (B) premotor areas. Abbreviations: AS, arcuate sulcus; CC, corpus callosum; CF, calcarine fissure; CING S, cingulate sulcus; CS, central

sulcus; IOS, inferior occipital sulcus; IPS, intraparietal sulcus; LF, lateral fissure; LS, lunate sulcus; OTS, occipito-temporal sulcus; POMS, parieto-occipito-medial sulcus; PS, principal sulcus; STS, superior temporal sulcus.

the other hand, the caudal premotor region has direct connections with the motor cortex as well as with the more rostrally situated dorsal premotor and prefrontal cortices. The ventral arcuate premotor area, on the other hand, is directly connected with the motor cortex and with the prefrontal cortex. In addition, the ventral premotor region, which is characterized by a granular layer and thus resembles more a sensory than a motor type of cortex, has widespread connections with the neighboring gustatory area and with the frontal operculum and insula. These sensory-related links of the ventral arcuate premotor region are not surprising, since it contains a head and neck representation. Anatomic observations thus support a role of the arcuate premotor region in motor responses to sensory stimuli, as suggested by Goldberg on the basis of physiologic and behavioral studies.

In contrast to the sensory-related nature of the ventral premotor region, the dorsally situated agranular premotor area has connections that are restricted to the dorsal prefrontal and motor cortices. Viewed in the light of classic physiologic studies, which show that the dorsal premotor cortex contains predominantly a representation of the trunk, its limited projection pattern is not surprising. Both the physiologic and architectonic-connectional studies would, therefore, predict different roles for the dorsal and ventral premotor regions.

The supplementary motor area on the medial surface contains a rather complete body representation and is reciprocally connected with both the dorsal and ventral premotor regions as well as with the motor cortex (Benjamin & Van Hoesen 1982). It should be noted that the supplementary visual area MT is also connected with each unimodal cortical visual area (Maunsell & Van Essen 1983). Similarly, the supplementary auditory area receives input from all auditory specific cortices, as does SII from all somatosensory areas (Jones & Powell 1970; Pandya,

Hallett & Mukherjee 1969). Supplementary cortical areas, therefore, seem to be zones of convergence of projections from their modality-specific regions, or, in the case of the supplementary motor area, with the motor cortex and the adjacent premotor regions. Architectonically, all supplementary areas are at a similar stage of laminar differentiation within the confines of their respective sensory modality or the motor-related cortex. Both the architectonic characteristics and the convergent connectional features of the supplementary areas suggest that they may have a primordial but integral role in sensation or motor behavior.

### Participation of SMA neurons in a "self-paced" motor act

R. Porter

John Curtin School of Medical Research, Australian National University, Canberra City ACT 2601, Australia

In the recordings that were made by Brinkman and Porter (1979) the natural discharges of neurons located within the supplementary motor area (SMA) were studied while monkeys performed spontaneous, self-paced, natural movements with either the contralateral or the ipsilateral forelimb. These natural movements included a lever-pulling task which could be timed and also a range of other movements such as food collection with different trajectories and attitudes of the arm, hand, and fingers which were, without doubt, internally motivated, projectional (feed-forward) responses with inputs from internal drives, potentially of limbic or prefrontal origin. In these situations, cellular activity in the SMA was dramatically modulated in close temporal association with the movement itself. Such closely

linked relationships between neuronal discharge in the SMA and movement were not frequently observed in the triggered (by an afferent stimulus) movements studied by Tanji and Kurata (1982) in a simple reaction-time task. This distinction between the neurophysiological results obtained in self-paced (volitional) and in triggered (reactive) movements performed by monkeys is in accord with the studies of regional cerebral blood flow (rCBF) over SMA in humans when a variety of motor acts were performed (Orgogozo, Larsen, Roland & Lassen 1979). The more intentional (voluntary) drive that was needed, the greater was the participation of the SMA in the organisation of the movement performance as evidenced by changes in rCBF.

Brinkman and Porter (1979) were able to demonstrate that a given neuron in the SMA showed this dramatic modulation in its firing (usually a burst of impulses) in association with a particular movement (e.g. wrist extension) whenever it was performed and in whatever context – that is, as part of reaching out for the lever or collecting food, or releasing a grip, or in grooming behaviour. Individual SMA neurons were associated with such movement actions about either proximal joints or distal joints, including associations of many SMA neurons with finger movements. Moreover, in the majority of cases, the burst that a given neuron produced in association with every wrist-extension movement, for example, was produced whether that movement was made with the ipsilateral or the contralateral limb. Only 5% of over 270 SMA neurons studied in these experiments were demonstrated to send their axons into the pyramidal tract.

Hence the evidence *does* implicate the SMA in self-paced movements. It suggests that individual SMA neurons are related in their activity to individual components of complex movements and that all movement components, both those about proximal joints and those about distal ones are “represented” in the activities of different SMA neurons. Most of these SMA influences must be directed through corticocortical pathways, such as those to MI on both sides of the brain, and not immediately through the pyramidal tract to reach the motor apparatus of the spinal cord. Brinkman and Porter (1979) could find little evidence for a major domination of the firing of SMA neurons by inputs from peripheral receptors in the limb. It may be that if these have access to SMA (via pathways from parietal cortex or SSA, for example) the signals are so highly processed by the time they are delivered to the SMA that the effect is no longer detectable as a short latency response to a peripheral stimulus. It may also be that SMA neurons are not wired for triggered motor responses to peripheral stimuli, but are particularly concerned with self-initiated acts.

## Free will and motor subroutines: Too much for a small area

Giacomo Rizzolatti

*Istituto di Fisiologia Umana, Università di Parma, 43100 Parma, Italy*

I have read Goldberg's target article with great interest and am very sympathetic to his attempt to assign different functions to the medial and lateral premotor systems. I also think that this interpretation of the role of the lateral system in motor programming is basically correct. This system, which in the monkey includes cortical areas FBA and FCBm, is strongly stimulus dependent. This dependence comprises a rather broad range of stimulus–response relations that vary from a rigid stimulus–response link, like that in the sensory systems, to a stimulus susceptibility conditional on a particular motor state (Rizzolatti, Scandolara, Gentilucci & Camarda 1981), to a relation where the stimulus is transformed into an appropriate movement pattern (neurons, for example, that respond to objects that require a particular hand–finger configuration to be grasped; Gentilucci, Matelli, Fogassi & Camarda, in preparation).

I am much less happy with Goldberg's conceptualization of the medial system. Basically two sets of properties are attributed to it. The first set is proper to what in common language are called voluntary movements. The context sensitivity is “internal,” the action mode “projectional,” the speech output “spontaneous.” The second set refers to how the actions are executed rather than their origin. The medial system is considered responsible for the computation of trajectories for reaching targets; its sensory dependence is proprioceptive; this system should be involved in the organization of fluent motor sequences. Although empirical evidence for this last set of properties certainly exists, assigning a particular role to the medial system in internally generated movements is not a strong hypothesis, nor is it supported by convincing evidence.

Internally generated movements are usually considered to have no external stimulus setting the occasion for their occurrence. When do these movements occur? I can see three main cases: (a) The movements occur in response to verbal instructions that specify the motor action but not the exact timing of its onset. (b) The movements take place as a consequence of a mental image. (c) They are due to an internal drive.

The first case is difficult to differentiate conceptually from a classical visual delayed response. Verbal stimuli are not different, as far as their effects on motor responses are concerned, from other stimuli. As most other stimuli do, they prompt a given response. So it is illogical to consider the movement of a finger subsequent to a verbal command categorically different from an arm movement toward a nice red apple. The second case is conceptually interesting. It is difficult to accept the idea, however, that a special premotor system has developed in order to allow individuals to respond to their mental images. Furthermore, mental images probably originate in those same areas where sensory stimuli are processed (see Kosslyn 1983). The third case is by far the most interesting. Let us imagine a hungry wild animal searching for food. Since the prey it is looking for is not around, its motor behavior is internally generated. Are the movements forming this and similar motivation-generated behaviors organized by the supplementary motor area? They may be, but I doubt it. The main reason for my skepticism is that any type of movement of a certain complexity, be it stimulus related or internally generated, must have a spatial reference. Whereas this spatial reference does exist in the lateral programming system, it is absent in the medial one. Anatomically, this system is not connected with parietal areas involved in space perception; physiologically, its neurons (with very rare exceptions) do not appear to have visual responses. So the medial system lacks the prerequisites for a system responsible for motor actions, regardless of whether these are related to an internal state, free will, or whatever one means by the term “internally generated movement.” I agree with Goldberg that the context of the medial system is internal, but only in the sense that movements generated by this system are related to proprioception and to computation of the muscle activation necessary for a given motor act.

To conclude, let me make a short comment on the “evidence” that the supplementary motor area (SMA) is crucially involved in voluntary behavior. This idea stems from two sources: regional blood flow measurements and event-related brain potentials. The blood-flow experiments I am aware of (see also the citations where this is discussed in the target article) can all be explained with the concept that the SMA is engaged in the elaboration of motor subroutines (see Roland, Meyer, Shibasaki, Yamamoto & Thompson 1982). As for the readiness potentials, I doubt that their localization is precise enough to indicate the involvement of a specific anatomical area as opposed to a large cerebral region that includes areas in front of the SMA as well as others at deeper locations. Summing up, any idea of a crucial role of the medial programming system in voluntary movements is not substantiated by convincing evidence and, theoretically, is very weak.

## Naturalizing the context for interpreting SMA function

John P. Scholz, M. T. Turvey, and J. A. S. Kelso

Department of Psychology, University of Connecticut, Storrs, Conn. 06268 and Haskins Laboratories, New Haven, Conn. 06511

Clinical and experimental evidence presented in the target article supports the contention that the SMA (supplementary motor area) plays an important role in the control and coordination of actions. The presence of the "alien hand sign" and difficulties initiating voluntary actions in patients with SMA damage appear to suggest a role in intentional processes. The evidence presented, however, does not support a model in which the SMA serves to translate the intent to act into the "selection, linkage, initiation, and anticipatory control of a set of 'precompiled' motor subroutines." As Goldberg notes, results of studies involving electrical stimulation or lesions of the SMA in subhuman primates are controversial. In addition, infarcts affecting the SMA are rarely confined to this area alone, and diaschisis is undoubtedly an important factor in determining the behavioral manifestations of any brain lesion. It is also unclear how much can be concluded from studies of patients suffering from intractable epilepsy in which the area of focal seizure activity, here the SMA, has been resected. Can one assume that other brain regions are functioning normally?

An understanding of the neural support for action will surely be fostered by behavioral studies of patients with documented lesions in restricted areas of the neuraxis. There is reason to question, however, the wisdom of any model of neural function that treats (1) a particular brain structure as functioning in relative isolation from the total system of which it is a part, and (2) a function as circumscribed by a particular brain structure. We concur with Schmitt (1978, p. 1) that

theories based on partial systems are subject to the component-systems dilemma that bedevils all attempts at biological generalization. Such theories fail to articulate and effectively deal with the essence of the problem, which is the distributive aspect that emerges from the complex interaction of functional units . . . in the brain.

Nor are the roles of different brain regions necessarily distinct or fixed. Recent evidence from sensory mapping studies shows, for example, that topographic cortical maps may move and change shape spontaneously, or in response to experience (Merzenich, Nelson, Stryker, Cyander, Schoppman & Zook 1984). What is important are the relational aspects among component processes participating in the generation of an act (Fentress 1984). As Bernstein (1967) argued, this will necessarily involve both traditionally conceived "motor and "sensory" processes (although we agree with Gibson 1966 and Reed 1982 that this dichotomy is less than ideal).

Attempts to model CNS function with "machine" concepts may be misguided. In our view, notions such as motor programs, schemas, and the like obscure rather than aid an understanding of the basis for the control and coordination of action (e.g. Kelso 1981; Kugler, Kelso & Turvey 1980). A more principled attack on these issues follows the well-worn path of natural science. What are the physical strategies by which systems self-organize and by which cooperative states defined over very many microcomponents are assembled? And how might these strategies apply to the neuromuscular system in the production of voluntary acts? For example, primate movements exhibit discrete and rhythmic properties qualitatively similar to physical systems of quite different material structure, that is, mass-spring systems (e.g. Bizzi, Polit & Morasso 1976; Fel'dman & Latash 1982; Kelso & Holt 1980). The coordinated unitary state of a pair of limbs, rhythmically oscillating at the same tempo, seems to be assembled through conservation of

mass, energy, and momentum (Kugler & Turvey, in press). And transitions occurring from one gait to another in locomoting animals, as well as transitions found in bimanual coordination of humans seem to obey principles similar to those determining phase transitions in nonanimate systems (Kelso 1984). If movements are assembled and sustained through natural principles then it is in the context of such principles that SMA function is to be understood. For example, how are these principles appropriately constrained? Does SMA function contribute non-holonomic constraints (i.e. constraints that temporarily restrict the system's trajectory from among the many possibilities). If so, how?

Similar qualms can be raised about equating the predictive control of behavior with internal models of possible linkages among events. In natural settings there is information available to specify how an animal must organize its neuromuscular system in order to achieve its goals (Gibson 1979; Turvey & Kugler 1984). Information relevant to the control of actions is available to and may be detected by a number of perceptual systems (e.g. auditory, haptic, visual, etc; Gibson 1966; 1979). In the case of vision, information in the specificational sense is optical structure lawfully generated by the layout of surfaces and by movements relative to those surfaces. It contrasts with information in the injunctional-indicational sense (such as an instruction to push or pull), which is more nearly arbitrary than lawful. Goldberg implies that the latter sense of information (1) underwrites intentional acts, and (2) constitutes the format for the space-time expectancies making up the predictive model. Neither implication seems warranted except perhaps in extreme cases. A stop sign provides information in the indicational sense. It informs the automobile driver that one must stop, but it does not tell the driver how to do so, that is, when to begin braking, how hard to brake, and so on. Fortunately, information specific to these control requirements is available to the driver in the optical flow field (Lee 1976).

As intimated, information in the specificational sense is prospective. It informs an animal about the possibilities for action and about the outcomes of current action if present conditions persist. The importance of specificational information to the prospective control of actions has been shown in a number of recent studies involving different skilled actions and different species (for reviews, see Lee 1980; Turvey & Kugler 1984). Thus, Goldberg's impression that vision functions retrospectively, primarily in a feedback mode, is surely off the mark. The upshot of the foregoing is that Goldberg is evaluating the SMA's role in intentional activity under a too restricted interpretation of prospective control.

Similarly, efforts to elucidate the role of neural processes in the generation of acts, and attempts to understand the deficits exhibited by patients with CNS damage, will be served better by natural, ecologically representative tasks (see also Kelso & Tuller 1981 for similar arguments regarding apraxic disturbances). For example, Goldberg cites evidence from studies of Parkinsonian patients in support of his model. In general, these have involved visuomotor tracking tasks in which the visual target is a patch of light whose motions are arbitrarily constrained. Although patients with Parkinsonism perform poorly in this task compared to normal individuals, it is questionable to what extent the task touches upon the true functional deficit exhibited by these patients. It may be misleading to draw conclusions from such artificial settings about how damaged brain regions function in normal situations where the informational basis for "predictive behavior" is largely law based. Paradigms such as those developed, say, by Lee (1980; for visuomotor coordination) and Nashner (Nashner & McCollum 1985) for postural-volitional relations should not only illuminate the SMA's functional significance in more natural tasks, but may also clarify its role in braiding the two kinds of information discussed herein.



## Neuronal processes involved in initiating a behavioral act

Wolfram Schultz

*Institut de Physiologie, Université de Fribourg, 1700 Fribourg, Switzerland*

In studying neuronal mechanisms involved in the initiation of a behavioral act one encounters several questions: (i) Is the initiation process generated within the brain, or by an outside source having access to the biological brain machinery (Eccles 1982)? (ii) Does a conscious decision occur before the initiation process (would this decision then be the initiation itself?), or is the act unconsciously initiated, and consciousness plays a role, deciding whether or not to "veto" it (Libet, Gleason, Wright & Pearl 1983; Libet, Wright & Gleason 1983), or do both possibilities coexist [see also Libet, in this issue of *BBS*]? (iii) Are the initiation processes similar for different types of behavior, as, for example, movements reliably elicited by rigid trigger stimuli, compared to more loosely timed "spontaneous" movements with less constraints (see Sasaki & Gamba 1981)? (iv) Is it a unidirectional, sequential, single-path flow of neuronal information that underlies the initiation process, which many authors appear to favor, or could it rather be that several brain centers participate simultaneously in different aspects of the prospective act in a converging mode, in which mutual interactions and feedback loops would also be common? The first proposition of point (iv) would be something like the motor analog of the "grandmother cell" in the neurophysiology of sensory perception. Although point (i) is difficult to resolve from a purely biological point of view, point (ii) was investigated with an ingenious experimental design and has led to the spectacular finding that a freely voluntary act may be initiated unconsciously (Libet et al. 1983). This may also help in evaluating some of the propositions of the first point (Eccles 1982). Still, the scope of the present target article lies in the realms of the last two points.

According to present concepts, the motor complex can largely be regarded as the final common motor output station of the brain; some of its neurons are only two synapses away from the muscle fiber. The supplementary motor area (SMA) then, with its monosynaptic link to the motor cortex, is something like a supramotor structure, one station upstream from the final motor output, for the following reasons: Single cell activity in relation to a triggered arm movement starts earlier in the SMA than in the motor cortex (Tanji & Kurata 1982), readiness potentials preceding movements are different and being earlier over SMA than over motor cortex in humans (Deecke & Kornhuber 1978), regional blood-flow studies have shown that the SMA is actively engaged in mental attention or preparation mechanisms for specific finger movements (Roland, Larsen, Lassen & Skinhøj 1980). In addition to discussing the SMA's direct influence on the motor cortex, current theories also view it as a structure involved in the initiation of behavior at a very early stage, possibly the site where the first impulse in the brain originates for starting the behavioral initiation process (Eccles 1982). Future research may perhaps delineate this more clearly.

The SMA also projects to another brain system which is importantly involved in the generation of behavior, the basal ganglia. In particular, the nigrostriatal dopamine (DA) system plays a key role in behavioral mechanisms, as evidenced by the deficits occurring after its destruction. The akinesia in humans with Parkinson's disease and in experimental animals with lesions of the DA system is characterized by a virtually complete absence of behavioral acts (see Schultz 1982). These comprise both "spontaneous" and stimulus-triggered movements of the extremities, head, and eyes (Schultz & Studer 1984 and unpublished data). With less complete akinesia, animals are still deficient in "spontaneous" movements but are able to react to direct behavioral triggers. In this situation, the onset of muscle activity in the prime movers is considerably delayed, indicating

a partial deficit in movement-initiation processes. Direct electrophysiological recording of DA cell activity in the unlesioned, awake monkey in the same controlled behavioral situation (reaction-time paradigm) shows that DA cells respond with a peak latency of about 100 ms to the behavioral trigger before the movement occurs (Schultz 1984a). However, DA cells do not appear to be reliably activated before "spontaneous" movements. They were found to increase their activity mostly during the movement phase (Schultz, Ruffieux & Aebischer 1983). Taking these data together, it seems that the activity of DA cells plays a key role in the initiation of behavioral acts, but it may not represent the neuronal trigger mechanism that actively starts a common behavioral initiating process, if such a trigger exists at all. It is possible, however, that DA cells play an active role in one kind of behavior, that is, stimulus-triggered movements.

When considering the function of the SMA in relation to behavioral initiation mechanisms, we are faced with at least one other structure that is also strongly implicated in this function, the nigrostriatal DA system. Although the respective roles of both structures in these mechanisms already appear to be quite different, we are unable to judge at present whether one of the two structures may be dominating the other or whether they would work in parallel, each contributing a piece to the puzzle that needs to be complete so that a behavioral act can occur. In the latter case, we would view the SMA as contributing a frontal cortical function of possibly cognitive character related to more abstract aspects of the evolving act, whereas the DA system would be engaged in a basic behavioral activating mechanism which would be expressed postsynaptically in the striatum, in caudate-initiating mechanisms and putamen-execution mechanisms (Crutcher & DeLong 1984; Rolls, Thorpe & Maddison 1983). The activities of both systems, the SMA and the DA system, would converge in the striatum, and the evolving neuronal activity would successively become more and more focused on the details of the behavioral act, up to addressing individual motor units, during its progression through pallidum, thalamus, and cortex (see also Schultz 1984b).

## New findings on the behavior of supplementary motor area neurons recorded from task-performing monkeys

Jun Tanji

*Department of Physiology, School of Medicine, Hokkaido University, Sapporo 060, Japan*

Our recently published findings on supplementary motor area (SMA) neuronal activity (Kurata & Tanji 1985; Tanji & Kurata 1985) seem to provide some additional clues for understanding SMA function. They are mostly consistent with the proposal in the target article concerning the role of the SMA in the specification and elaboration of action according to the current behavioral context. Two major findings and their implications are described.

**1. SMA activity following motor instructions.** SMA neuronal activity was observed during a preselection process of either starting to perform or refraining from performing a motor task according to the modality of sensory signals. Monkeys were trained to respond to signals in two different ways in a behavioral paradigm. In one condition, a cuing signal required the animal to be prepared to start a key-press movement promptly in response to a forthcoming tone burst but to refrain from moving if the forthcoming signal was vibrotactile. In a second condition, a different cuing signal required the animal to be prepared to execute the movement if the vibrotactile signal, but not the tone burst, was presented. High-frequency cue-induced activity occurred in the SMA (49% of task-related neurons). Two-thirds

of the units exhibited a differential response to one of the two signals. Of these, 95 neurons showed the first category of response: Their activity changes continued until the occurrence of the triggering signal, in response to which the animal started the movement. The response terminated gradually and was not temporally correlated with the signal or movement onset. This type of neuronal response to cues seems to be related to a process leading to correct initiation of the movement following an appropriately selected sensory signal. In the second category (24 neurons), the neuronal response continued until the occurrence of nontriggering signals, after which it subsided gradually. When there was no nontriggering signal, the response was observed during the period in which the nontriggering signal could have appeared. This response seems to be related to a process leading to suppression of the movement at the occurrence of the nontriggering signal. In contrast to SMA neurons, few neurons in the precentral motor cortex (if any) exhibited such selective instruction responses. These results seem to indicate that the SMA plays an important role in a preparatory process in which motor responses are linked to sensory signals in particular, intended ways.

#### 2. SMA responses to nonmovement-triggering sensory signals.

SMA neurons often respond to sensory signals even though they do not serve as movement triggers. In the behavioral paradigm explained in the previous section, it was found that a group of SMA neurons responded to the auditory or somatic signal *regardless of* whether the animal started a movement immediately following its occurrence or refrained from moving in spite of its occurrence. It is possible that these neurons are monitoring sensory signals for further use in a diverse behavioral context not necessarily contingent on movement initiation. Another group of SMA neurons responded to the auditory or somatic signal *only when* the animal remained immobile. This type of response seems most useful for phasic suppression of the movement. There is a possibility that, in addition to the above-mentioned cue-dependent response developing gradually until the occurrence of the nontriggering signal, the response to the nontriggering signal itself serves to prevent the occurrence of nonwilled movement. The finding is thus consistent with Goldberg's hypothesis that the SMA may function to inhibit motor actions unless they are specifically addressed by a volitionally generated signal reflecting internal context.

## Medial versus lateral motor control

Michael Weinrich

Department of Neurology, Palo Alto VA Medical Center and Stanford University, Palo Alto, Calif. 94304

Goldberg's is a thoughtful and provocative review of the anatomy and physiology of the supplementary motor cortex. There are several points that need elaboration, however. The distinction between a medial motor system concerned with rapid preprogrammed movements and a lateral system dependent upon sensory feedback, although heuristically interesting, is not as sharp as the author implies. Patients with apraxias due to premotor lesions have difficulty performing learned rapid sequences of movements, but may execute simple movements well (Geschwind 1975). On the other hand, there are numerous clinical reports of Parkinsonian patients (cited as disease of the medial system) able to perform rapid well learned movements when placed in an appropriate context with sufficient stimulation (Adams & Victor 1981). Humphrey and Reed (1983) have reported evidence suggesting "two partially independent central systems: one organized for reciprocal activation of antagonist muscles and another for their coactivation," both within MI. In our studies of the premotor cortex in macaques, we found that premotor neurons responded to visual cues prior to both rapid "ballistic" movements and slower, visually guided move-

ments (Weinrich & Wise 1982; Weinrich, Wise & Mauritz 1984).

The model of SMA function proposed draws heavily on anatomic connections with little attention to the physiology of the transformations in information that must take place. Modulation of thalamic oscillations is suggested as an important mechanism in the motor system, yet these oscillations are present only in sleep, drowsiness, and barbiturate anesthesia (Deschenes, Paradis, Roy & Steriade 1984). Although the weight of evidence certainly suggests that the premotor cortex is involved in visually guided movements and the supplementary motor area is involved in sequences of movements and in bimanual tasks, it is still unclear what information is actually encoded in the discharges of neurons in these areas. To date, single-unit studies in these areas have not revealed any movement variables tightly coupled to the trains of action potentials. Studies in MI (Humphrey, Schmidt & Thompson 1970) and primary visual cortex (Tolhurst, Movshon & Dean 1983) suggest that we may have to study aggregates of neuronal spike trains to derive a statistically meaningful representation of encoded information. If this is true for the SMA then the problem will be to understand how the activity of a group of neurons in the SMA influences the activity of groups of neurons in its projection areas. The technology of multiunit electrodes and the tools for analyzing simultaneous multiunit recordings are just now beginning to reach practical development. As these techniques improve we should be able to develop models of the function of the SMA based on the transformation of information.

## The SMA: A "supplementary motor" or a "supramotor" area?

Mario Wiesendanger

Institut de Physiologie, Université de Fribourg, 1700 Fribourg, Switzerland

Goldberg's review deals with the remarkable change in views about the functional significance of the SMA (supplementary motor area) that has arisen in recent years, mainly on the basis of observations on the human brain. To recapitulate briefly, it has been demonstrated that local changes of cerebral blood flow (CBF) are prominent in the region of the SMA on both sides when subjects are asked to "mentalize" a complex finger task; that the readiness potentials occurring before self-initiated movements are largest over the SMA; and that neurological patients with SMA lesions have a striking poverty of movements and of spontaneous speech. This has to be contrasted with the early descriptions of the SMA by the two pioneers, Penfield (Penfield & Welch 1951) and Woolsey (Woolsey, Settlage, Meyer, Sencer, Hamuy & Travis 1952) when the SMA was viewed, at least in monkeys, as a second, smaller motor cortex with a less detailed somatotopy (pictorially represented in the textbooks as the "brother-simiusculus" or "homunculus" on the mesial wall). Its function was seen mainly in terms of posture and tone. The question may thus be asked, Is the SMA implicated in "lower" motor control functions or does it play a "higher" role in the process of movement initiation? Is it "supplementary" (i.e. a complement, an addition, an appendix) to the "main" motor cortex? Or, as suggested by Orgogozo and Larsen (1979), who were impressed by their CBF data, is it a "supramotor" area? The question goes beyond terminology and perhaps deserves some comments.

The problem, in my opinion, resides in the areal definition of the SMA which was operational and based on the effects of repetitive electrical stimulation of the cortical surface. Clearly, the SMA was part of the motor fields (the "excitable cortex") and, according to the terminology of Foerster (1936) and of the Vogts, (Vogt & Vogt 1919), part of the frontal "extrapyramidal" cortex. The SMA of Penfield was situated in the agranular cortex of medial area 6, mainly in medial area 6a $\beta$ ; and this is the region

where most students would place the SMA in subhuman primates. However, Goldberg's definition of the human SMA does not correspond to the original one: In referring to Braak's (1980) pigmento-architectural work on the human cerebral cortex, he proposes that "the superofrontal magnopyramidal region . . . anterior to the superior and medial aspects of the *paraganglionic belt*" would probably come "*closest to being congruent with the SMA*" (my italics). Translating this into more familiar regional designations, the SMA should, according to Goldberg, be placed *anterior to area 6* (= *paraganglionic belt*). The outline of Braak's superofrontal magnopyramidal region is illustrated in Goldberg's Figure 4, which indeed shows that this region reaches far into the medial parts of the granular frontal cortex (Brodmann's area 9; compare also with Campbell's intermediate agranular cortex in Figure 2).

I do not contest the possibility that Braak's "superofrontal magnopyramidal region" may fit with the region of characteristic CBF changes during the planning of movements. This may also be the crucial region for the production of the severe akinetic and aphasic disorders seen with frontomedial lesions. In his introduction, Goldberg cautiously and rightly speaks of a "*medial bilaterally organized premotor system*," and I would add that this medial neural system almost certainly transgresses cytoarchitectonic boundaries, implicating also the agranular prefrontal cortex and possibly also anterior limbic cortex.

Of course, it is legitimate to associate clinical entities or characteristic metabolic changes occurring in defined behavioral sequences with the corresponding cortical area and to give it a name. In this case, however, it appears problematic to me to use a term – supplementary motor area – that was defined on the basis of electrical stimulation and found to be entirely in the medial agranular motor field of area 6. The problem becomes apparent when one realizes that much of what is said about the anatomical relationships and about the single-unit studies is founded on studies in monkeys with the SMA defined as medial area 6 (or the medial paraganglionic belt of Braak).

It might well be that, eventually, one will have to adopt regional entities in the cerebral cortex which are functionally more meaningful than, for example, the SMA as originally defined. For the time being, however, it seems to me that we are not yet in a position to propose new structural–functional subdivisions, at least not at the finer level of micro-electrophysiology and modern hodology. The concept of a medial–frontal system that includes the frontal association cortex, as outlined in Goldberg's model, may be a useful guide in clinical–neuropsychological research, however.

## Author's Response

### Where there is a "will," there is a way (to understand it)

Gary Goldberg

Moss Rehabilitation Hospital, Philadelphia, Pa. 19141

*Volition* or *willing* is an act of the mind directing its thought to the production of any action, and thereby exerting its power to produce it . . . He that shall turn his thoughts inwards upon what passes in his mind when he wills, shall see that the will or power of volition is conversant about nothing but our own *actions*; terminates there; and reaches no further; and that volition is nothing but that particular determination of the mind, whereby, barely by a thought, the mind endeavors

Table 1. Outline of author's response

Topic	Commentators
1. The distributed-systems approach to analyzing brain function	Brown; Gray; Kornhuber & Deecke; Scholz, Turvey & Kelso
2. Clinical data and interpreting the effect of focal lesions	Brown; Scholz et al.
3. Drive, intention, preparation, and "free will" in voluntary action	Damasio; Neafsey; Porter; Rizzolatti
4. Lateral and medial premotor mechanisms	Deecke & Kornhuber; Libet; Pandya & Barbas; Rizzolatti; Tanji;
5. The Parkinson connection	Schultz; Weinrich
6. Toward a functional evolutionary architectonics	Brown; Fuster; Kornhuber & Deecke; Pandya & Barbas
7. Hodology and micro-electrophysiology versus clinical neuropsychology: Can the gap be bridged?	Porter; Tanji; Weinrich; Wiesendanger
8. Volitional processes, the readiness potential, and the SMA	Libet
9. Summary	

to give rise, continuation, or stop, to any action which it takes to be in its power.  
(Locke 1690)

In the target article, an effort was made to integrate information from a wide variety of sources addressing the question of the role of the SMA in the control of action by the brain. In the process, several hypotheses were developed and presented and an attempt was made to support these ideas with the data reviewed. The approach has been necessarily speculative and multidisciplinary and has produced a set of commentaries touching upon a wide range of issues. Many of these would require several thousand words each for an adequate reply, and several of them are at the outer boundaries of my personal area of expertise. I would like to thank the commentators for taking the time to review the target article and for their thoughtful analyses, to which I will now endeavor to respond. I have structured my reply as outlined in Table 1. The more general issues are considered first, followed by more specific considerations.

**1. The distributed-systems approach to analyzing brain function.** It has become quite clear in reviewing emerging concepts in modern psychology and physiology that approaches to understanding brain function that embrace either a narrow localizationist or undifferentiated anti-localizationist view are hopelessly doomed to failure. Although I did not explicitly state my views regarding these basic ideas in the target article, I had hoped to convey them in the nature of my approach to the subject. This approach has been accurately perceived by Gray. I do not believe that the SMA functions in "relative isolation from the total system of which it is a part," as Scholz, Turvey & Kelso contend I have implied. On the contrary, the importance of the SMA derives directly from the



nature of its interactions with other regions defined in the medial premotor system, both through its interactions with other cortical regions and through its connections with thalamus and reentrant subcortical inputs. Its place within this system will determine the nature of its role in the microgenetic process that accompanies the unfolding of an action (Brown 1977 and Brown's commentary). The SMA is viewed as a crucial link in a widely distributed brain system (see Kornhuber & Deecke). In approaching this basic issue, I would agree with Luria's suggestion that *"the material basis of the higher nervous processes is the brain as a whole but that the brain is a highly differentiated system whose parts are responsible for different aspects of the unified whole"* (Luria 1980, p. 33; see also Mesulam 1981 for a discussion of the concept of a functional brain network). One approach to studying brain-behavioral relations can then be expressed as the determination of which aspects of a complete behavior can be linked to the operation of identified individual processing nodes within the functional network of interest. Activation studies in normal individuals can help to define the operative functional networks associated with particular forms of behavior. Careful clinical studies of patients and experimental animals with localized brain damage may begin to determine how a behavior is affected differently by lesions of different components of the network. The fundamental structure of the network, the interconnections between the component processing nodes at cortical and subcortical levels, and the details of the tissue microstructure in each of the regions comprising the network, are all products of the evolution of the organism and thus the behaviors manifested by the operation of the network can be viewed, in part, as "derived products of evolution" (Yakovlev 1948, p. 313). Yakovlev, elaborating upon this idea, further states:

The behavior of a living organism is total; every heart beat, every twitch of a muscle, every movement and posture is an integral part of the total behavior which evolves and proceeds as a unity in time. At any given moment the behavior of a living organism represents the culmination of the evolution not only of its own behavior, but of the behavior of the species and of all living matter as a common stock of all species. (Yakovlev 1948, p. 315)

It is thus implied that through a careful examination of the evolution of the "stereodynamic organization" (Yakovlev 1948, p. 314) of functional networks within the central nervous system over phylogeny we may begin to understand their role in behavior. Although I would agree that, at a basic level, biological movement is subject to the same lawful physical constraints as that of inanimate matter, as Scholz et al. contend, surely the accumulated biological information inherent in the evolved structure of the central nervous system must also have some relevance and should be included in the "naturalized context" in which we are to understand SMA function.

The basic structure of the network is laid down during development under genetically directed biochemical guidance and constitutes what Edelman (1978) has called the "primary repertoire." Within the general anatomic limits imposed, a great deal of variation in detail can develop through ontogeny as specific neuronal groups are selected in concert with the experience of the individual.

Synaptic patterns are highly malleable, and principles of competition for synaptic space and activity-dependent enhancement of synaptic strength determine the "secondary repertoire" of selected neuronal groups (Edelman 1978; Edelman & Finkel 1984). This "firmware" can be reshaped to some extent in response to peripheral restructuring, behavioral manipulation, and cortical lesions (Edelman & Finkel 1984; Merzenich, Kaas, Wall, Sur, Nelson, Felleman 1983; Merzenich, Nelson, Stryker, Cynader, Schoppmann & Zook 1984; Rasmusson, Turnbull & Leech 1985). [See also Ebbesson: "Evolution and Ontogeny of Neural Circuits" *BBS* 7(3) 1984.] Such changes have been shown to produce systematic alterations in the functional maps within somatosensory cortex, for example, but are unlikely to transform totally the nature of operation of a given brain region. As we are elaborating the dynamic capacities of brain networks, it should also be noted that the physiologic activation patterns associated with the performance of a conditioned task may evolve systematically during the acquisition of the ability to perform skillfully (Sasaki & Gamba 1982) and may also be transformed when the network compensates physiologically for the development of dysfunction within one component of the network (Sasaki & Gamba 1984). Given this range of flexibility and variation (which deserves careful attention and further exploration), it is still possible and desirable to infer basic, steady-state, normative functions for a particular brain region such as the SMA within the operative context of the functional brain network of which it is a part.

## 2. Clinical data and interpreting the effect of focal lesions.

The clinical manifestations of lesions of the medial aspect of the frontal lobes can be quite striking, particularly in the acute phase (see, e.g., Damasio & Van Hoesen 1983 for an additional case description) as the clinical data reviewed indicate. Many of the behavioral observations are obvious at the bedside and do not require elaborate "unnatural" testing procedures (although I believe that Scholz et al. tend to overemphasize the need to avoid contrived test conditions). Patients do not speak or move unless commanded to do so or, at best, have a limited and grossly impaired ability to initiate and maintain a spontaneous behavior. They may react with dismay when the hand reaches to a pencil, picks it up, and begins to scribble (the "alien hand sign") and may hold the limb in the lap to prevent it from reaching out to grasp nearby objects to which the limb appears to be magnetically drawn ("self-restriction"). Although the clinical observations may be subject to the criticisms of Scholz et al., our knowledge of brain-behavior correlation has, despite these limitations, advanced significantly over the past century through careful clinicopathologic correlation and stimulation of the brains of epileptic subjects. Many of the basic conclusions drawn by neurologists and neurosurgeons from their clinical experience and insights, in spite of recognized limitations of their methods, have been confirmed and expanded in recent times using physiologic imaging techniques in normal human volunteers.

There is some disagreement about the way a clinical behavioral symptom should be interpreted in the brain-

damaged subject. Although it has been suggested that a clinical symptom should be interpreted as a manifestation of informational disconnection between component processing structures in a network (Geschwind 1965), **Brown** has elaborated the modern theory of microgenesis (reviewed here in his commentary), in which the clinical symptom is viewed as the achievement of a normally covert, preliminary phase in the process underlying the normal expression of the behavior.<sup>1</sup> I have obviously relied heavily on the latter approach in the target article, and **Brown's** eloquent, aptly titled commentary is a most welcome enhancement. The integration of evolutionary biology with the understanding of behavior is powerfully expressed in **Yakovlev's** 1948 paper. These ideas, together with the evolutionary architectonics of **Sanides (1972)**, become entwined in **Brown's** microgenetic analyses, forming a fertile context in which SMA function can be interpreted. With damage to the SMA and related structures in the medial premotor system, the developing action is arrested in **Yakovlev's** intermediate system in which the axial basis for the action is formed. This is the system of emotive outward expression; it is noteworthy that patients with medial frontal lesions have been reported to display a most unusual form of emotion-related facial paresis in which weakness of the contralateral half of the face becomes apparent only with a spontaneous emotional facial expression (this is exactly the reverse of what is most often seen with lateral lesions; see **Damasio & Van Hoesen 1983; Laplane, Talairach, Meininger, Bancaud & Orgogozo 1977**). When the orderly microgenetic sequence associated with an action is bypassed, short-circuited, or disrupted, action either does not achieve externalization or externalizes without the simultaneous achievement of a volitional self-referenced basis (as would occur, for example, in a movement produced by electrical stimulation of the motor cortex). What I would add to this formulation is the possibility that, as an explanation for the appearance of the alien hand sign, the process of differentiation of extrapersonal object space which would normally accompany the microgenesis of an object-directed action, can lead to the anomalous externalization of such action *without the associated simultaneous microgenetic development of an active self or the normal "feeling of volition"* (**Brown**).

**3. Drive, intention, preparation, and "free will" in voluntary action.** Involuntary movement is frequently observed in clinical populations. Most often it is characterized by two fundamental features: (a) lack of goal orientation and (b) lack of a feeling of cognitive agency. Intention and motivation are tied up in the concept of goal orientation and the idea of following a plan (**Brand 1984**). An extensive literature on the neurobiology of motivated behaviors exists (e.g. **Mogenson & Phillips 1976**), but a detailed consideration is beyond the scope of this examination. Volition is linked to the idea of cognitive agency, of an active self that "wills" the purposeful behavior. The organism acts to solve a motor problem (**Bernstein 1984**) with its movement, and the achievement of the solution is the immediate goal of the act. Intention can be viewed as the answer to the question, "What are you trying to do?" (**D. C. MacKay 1985**). The answer may be related directly to objects in extrapersonal space ("I am trying to pick up

this cup") in which the action must be directly linked to recognizable external referents, or it may not be directly linked to an immediate external object or event as in the instances listed by **Rizzolatti**.

I think that some of **Rizzolatti's** criticisms arise out of the impression that the hypothesized medial and lateral premotor systems are postulated to operate in a mutually exclusive fashion. I suggest instead that they cooperate under many circumstances to organize an action sequence. One major difference between the lateral system and the medial system is their subcortical dependence, with a major linkage between SMA and basal ganglia which appears to be absent laterally (**Schell & Strick 1984**). There is also clear evidence from **Tanji's** laboratory (reviewed in his commentary) for unit responses in the SMA to instructional stimuli. How do these inputs obtain access to the SMA if its cortical projection pattern indicates only limited somatosensory input? I would suggest that task-relevant sensory inputs are selected during the process of learning the task and are focused on the SMA via the basal ganglia circuit. This would provide a basis for the participation of the SMA in instruction-related action. Are similar instruction-related units seen in the arcuate region? Similar arguments could be made for the operation of the SMA in internally generated actions due to internal drive. There must be some fundamental reason why basal ganglia outputs interact with the medial system and bypass the arcuate premotor area, as has been shown in the important anatomical work of **Schell and Strick (1984)**.

With regard to the question of participation of the SMA in the organization of movements related to mental images, recent work by **Roland and Friberg (1985)** suggests that areas of the superior prefrontal cortex immediately anterior to the SMA are consistently activated in human subjects asked to perform tasks that involve the generation of mental imagery without overt behavior. Whether these regions are actively involved in the internalized task or are involved in a process of memory retrieval is not clear. The SMA itself did not become significantly active in these tasks not involving overt action. However, the immediately adjacent superior prefrontal regions were strongly activated and would lead one to speculate that, had a motor act been related to these imagery tasks, this activity would then have spread to involve SMA. Furthermore, the finding that a pure bilateral activation of the SMA is associated with the "internal simulation" of the motor sequence test (**Roland, Larsen, Lassen & Skinhøj 1980**) can be interpreted as the exercising of a mental image of the task which becomes externalized with the additional activation of the primary motor cortex. The SMA may be a small area, but, in the context of its cortical and subcortical relationships, it is in a position to receive and make use of a great deal of convergent information.

The issue raised by **Neafsey** regarding the distinction between the "intention-to-act" and the "preparation-to-act" is problematic because it is difficult to address in animal studies. I also think that some of the disagreement may be semantic because of a difficulty with the terminology and basic philosophical intricacies (e.g. **Brand 1984**) involved in dealing with intentional action (all of which requires much more careful consideration by those

who study voluntary movement, as Gray rightly points out).

I did not mean to imply in the target article that, as a result of damage to the medial frontal cortex, the image of the act is always totally *lost*. Rather, there is an extreme paucity of spontaneous behavior in the face of an intact executive ability in an apparently alert patient. If stimulated sufficiently, the patient can move normally. If asked to repeat a phrase, the patient will exhibit normal speech. When asked about their initial impairments after recovery the patients often report that their "mind was 'empty'" (Damasio & Van Hoesen 1983, p. 98; see also Luria 1966, p. 226) and that they did not speak or move because they felt there was no need to do so even though they were aware of what was occurring around them. This has been interpreted as an abnormality in the development of drive states associated with specific actions (Damasio, Van Hoesen & Vilensky 1981). The alien hand sign can be interpreted as a disorder of intention because the patient reports that the behavior of the limb is dissociated from the patient's own volition; that is, the limb performs normally organized acts directed toward goals linked to objects in extrapersonal space in which the patient does not perceive himself as causal agent.

I would agree with Damasio's analysis that medial frontal lesions produce an interference with the will to speak or act spontaneously, and I would add that, in some instances, acts can occur extravolitionally. Although this appears to be the case, it does not preclude the possibility suggested by Neafsey that the role of the axially directed corticospinal projection from the SMA is to *prepare* a postural basis for action – a function that would be consistent with its "protomotor" identification and the anatomy of its spinal projection. However, relatively few SMA neurons project into the corticospinal tract (see Porter). The suggestion that this is the *only* function of the SMA in action would appear to be quite incorrect and would directly contradict many of the studies reviewed, which indicate a broader role of the SMA in the programming and coordination of self-initiated actions and the observation of a relationship of SMA activity with distal as well as proximal joint movement. The commentary of Porter and the observations of Brinkman and Porter (1979) are representative examples.

**4. Lateral and medial premotor mechanisms.** In a consideration of mechanisms underlying the initiation of an action, the motivational context, the sensory dependencies and requirements of the task, and the nature of the motor response itself will all have some bearing on what structures become involved in the organization of the action (Rolls 1983). In the target article it was proposed that acts could be heuristically divided into those that followed and depended on the accurate recognition of external objects ("responsive acts") and those that depended more exclusively on internal context or on an internalized model of the world that allowed an action to be extrapolated into the future ("projectional acts"). It was proposed that one of the main differences between the lateral and medial premotor systems corresponding to these action modes was the way in which sensory input was directed to the two systems. Rizzolatti's work supports the notion that the lateral system is "strongly stimulus dependent," and Pandya & Barbas note that the

ventral premotor region has the architectonic structure of a sensory-related region; its major role may be in the "sensory guidance of movement" (Godschalk, Lemon, Kuypers & Rondan 1984, p. 410). Furthermore, this system is linked to orbitofrontal, opercular-insular, and inferior temporal cortex (Künzle 1978), which form part of a system that includes the amygdala and the ventral striatum, a system that recognizes and discriminates external stimuli, associates motivational significance with them, and then selects and initiates responses to these stimuli (see Rolls 1983 for a recent review).

Recent data from electrocortical stimulation and evoked potential recording in human epileptic patients (H. Lüders, personal communication, 1985; Lüders, Lesser, Dinner, Hahn, Salanga & Morris 1985; Lüders, Lesser, Dinner, Morris & Hahn 1983) suggest that there exists an area in the region of the inferior frontal convolution in front of the prerolandic gyrus and distinct from the primary motor area that receives short latency somatosensory input at latencies comparable to that of the primary somatosensory cortex. Application of electrical stimulation to this identified region is associated with an inability of the patient to perform voluntary rapid alternating movements of the eyes, tongue, hands, or feet (ipsi- or contralaterally). Stimulation of this region also produces speech and writing arrest. It is quite possible that this region is the human analog of the lateral arcuate premotor region in the primate brain (see also Sugar, Chusid & French 1948).

With regard to the role of sensory input to the medial system and the SMA, Libet indicates that he and his coworkers have observed sensory evoked potentials recorded intraoperatively in epileptic patients (Libet, Alberts, Wright, Lewis & Feinstein 1975). A review of the data, which were reported for a very limited number of patients, suggests that the responses have a relatively long latency and could have been volume-conducted from deeper sites. Foit, Larsen, Hattori, Skinhøj, and Lassen (1980) reported a study of regional cerebral blood flow with somatosensory stimulation and found significant response in the region of the SMA in only two out of seven subjects, which contrasted with the finding that all the subjects showed significant increases in rCBF in SMA with activation by voluntary movement. This would suggest that, in agreement with the observation of Brinkman and Porter (1979), the SMA receives relatively few direct, short-latency inputs from the periphery and is much more readily activated with limb movement. It is possible that variable, long-latency inputs may reach the SMA, as Porter indicates, via a more circuitous route. Recent unit data comparing SMA and lateral premotor regions in similar tasks support the postulated differences between these two regions based on the degree to which they respond to external inputs (C. Brinkman 1985).

Tanji's studies of unit activity in the SMA are of particular interest and provide a perspective complementary to that of Porter. In this work, it is demonstrated that SMA units do respond to sensory inputs but only in a situation in which the animal has been conditioned to interpret specific stimuli as conveying instructional information directly relevant to a future decision to act. In this paradigm, the SMA participates in a process by which the animal is able to anticipate future requirements for action or inaction using present information with this ability



having been acquired by learning stimulus–response and reward contingencies. This is the essential basis of projectional action. One immediately wonders through what route these stimuli have gained access to the SMA and by what processes during the learning of the task these responses developed. There do not appear to be direct cortical projections, for example, from the auditory cortex to the SMA. It is possible that such inputs are selectively routed subcortically to the SMA via the basal ganglia (Rolls, Thorpe & Maddison 1983; Rolls, Thorpe, Maddison, Roper-Hall, Puerto & Perrett 1979).

**Kornhuber & Deecke** have provided a most illuminating commentary and an attractive alternative proposal for the differences in role between the medial and lateral premotor systems which is clearly supported by their functional data. I do not believe the two formulations (mine and theirs) to be altogether incompatible. Certainly, one of the most important considerations in the decision of when to act is, What will be the future consequence of a decision to act *now*? In other words an accurate probabilistic model of the future must underlie the choice of when to act (Bernstein 1984; see also Requin, Semjen & Bonnet 1984), whereas a categorical model of extrapersonal space as it stands at present would be necessary for determining the details of “what to do” (orbitofrontal) and “how to do it,” (ventrolateral premotor), particularly when such extrapersonal factors are critical for the successful performance of the task. I would suggest two experiments to Kornhuber & Deecke that may help to further clarify these issues. Both are variants of the visuomotor tracking task:

a. Change the paradigm so that the temporal and spatial structure of the task is invariant from trial to trial, then collect topographically recorded data while the subjects are at an early stage of learning the task and again at a later stage when the task has been fully mastered and the predictability of the task structure has been fully incorporated by the subject. An analysis of how the topography of the signals evolves with the learning of the task may help to shed more light on these issues. Does the entire frontal region continue to participate after the task and the spatiotemporal contingencies are apparent to the subject and presumably incorporated into the strategy assumed by the subject?

b. Perform the inverse of the experiment reported. On each trial, vary the temporal structure of the task (the timing of the “break points” would be randomly varied between trials although the total length of each trial would be constant for averaging purposes) so that the subject cannot anticipate when to initiate his responses, but keep the spatial component (i.e. the direction of the target point on each segment) invariant. Averages could then be computed across subjects. Such a study would help to affirm the idea that spatial (how to act) and temporal (when to act) components of the task are dealt with by separate systems.

One other issue that **Kornhuber & Deecke** commentary raises indirectly is that of a postmovement phase of outcome evaluation accompanied by a large positivity which resembles a P300 component. This is viewed by the Ulm group as a temporary “shutting off” of the attentional processing associated with the preparation preceding the movement (Lang, Lang, Heise, Deecke & Kornhuber 1984). I would suggest the possibility that the

positive P300-like postmovement potential reflects a match–mismatch check of the adequacy of the action performed in terms of its goal achievement (see Donchin, Ritter & McCallum 1978 for a discussion of the match–mismatch hypothesis of P300 generation; see also D. M. MacKay 1984). In this way, each action can be viewed as a hypothetico-deductive experiment. Each premovement “hypothesis” phase is followed by an evaluative “deductive” phase in which a conclusion is drawn as to the success or failure of the planned action in achieving its intended goal. Information thus obtained can be incorporated in the internal models being used to control the actions. In this way each action is seen as an active exploration of the world whose product is information that can then be incorporated into an internal model which can be used to raise the probability of achieving the desired outcome of the motor problem (Bernstein 1984). When perceived result and expected result (here the “task-relevant” stimuli being evaluated are those providing information about goal achievement) match, a relatively small P300 would be produced, indicating the outcome has little informational value. When there is a mismatch between the outcome expected from an action (i.e. that which one is trying to achieve) and that perceived to have occurred following completion of the action, a large P300 would be expected, reflecting the need to revise the internal model that gave rise to the unconfirmed expectation (Donchin et al. 1978; D. M. MacKay 1984). This process of evaluating goal achievement can also be viewed as a process of drawing closure on each segment of an action sequence (Desmedt 1981) and may therefore be exploited to study how the brain subdivides a sequential task into its individual components and to study the dynamics of the hypothesize–test cycle occurring in sequential behaviors.

**5. The Parkinson connection.** In the target article, Parkinsonism is considered a prototypical disorder related to dysfunction of the medial premotor system. I have portrayed the basal ganglia as forming a functional bridge between sensory and prefrontal association regions (as related primarily through the caudate nucleus; DeLong 1982) and the SMA. Its function in this position is to link specific aspects of the sensory context to the selection of motor programs and to suppress unwanted programs (see also Rolls, Thorpe, Perrett, Maddison, Caan, Wilson & Ryan 1981; Rolls et al. 1979). The relative roles of interoceptive and exteroceptive stimuli in this process suggest that nigrostriatal dopaminergic function is particularly important in the process whereby motor patterns are selected on the basis of nonexteroceptive inputs (Jaspers, Schwarz, Sontag & Cools 1984). Cools (1980, p. 361) states the hypothesis as follows: “dopaminergic activity determines the animal’s ability to select the best (motor) strategy . . . under pressure of factors intrinsic to the organism.”

Parkinsonian patients have difficulty switching and initiating motor and cognitive programs that are not directly linked to exteroceptive information, again suggesting a duality in the nature of the control of those acts that involve interoceptive direction and those that follow from exteroceptive stimuli (see also **Weinrich**). For example, the patient who cannot spontaneously initiate walking can often begin to walk when instructed to step over a

series of obstacles placed on the floor. Patients can sometimes facilitate the initiation of movement themselves by using mental imagery to create imaginary stimuli (Stern, Lander & Lees 1980). I do not agree with Weinrich that this phenomenon is related to the kinesiologic nature of the movement (i.e. "ballistic" vs. "ramp"), but would suggest that this problem has more to do with how the patient gains access to motor programs regardless of their structure. In Schultz's akinetic monkeys there is a distinction in the behavior of the animals between the ability to react to "direct behavioral triggers" and the initiation of "'spontaneous' movements," such that, in the partially lesioned animal who continues to remain unable to move spontaneously, delayed but definite triggered movements are possible. This would agree with the clinical impression from Parkinsonian patients. However, the unit data from the unlesioned animals do not provide a clear reason for this difference on the basis of the behavior of the sampled dopamine (DA) units of the nigrostriatal system alone. The data Schultz presents indicate that the nigrostriatal cells studied are not critically involved in the initiation of spontaneous behaviors (although they may be important in tonically sustaining them) despite the fact that DA depletion produces a more powerful suppression of spontaneous actions.

Penney and Young (1983) suggest that the akinesia of Parkinson's disease is due to the development of a sort of regenerative inertia in the positive feedback system from cortex to striatum to globus pallidus and back to the cortex (SMA) via thalamus, producing an inability of the loop to be appropriately modulated. The role of the nigrostriatal dopaminergic projection is to modulate the responsiveness of this loop by inhibiting the corticostriatal flow through the striatum, thus reducing the regenerative gain in the loop, allowing functional transitions to occur. Presumably, with loss of DA in the nigrostriatal projection, this loop effectively "locks up," producing the akinetic state. Apparently this condition is much more effective in reducing action based on factors intrinsic to the animal than it is in reducing those caused by extrinsic stimuli. The mechanism by which extrinsic stimuli are able to activate movement in the face of poor spontaneous initiation in Parkinsonism is not well understood but may relate to multiple linkages within the basal ganglia with forebrain nuclei (Graybiel & Ragsdale 1979), to projections from ventral striatum to the substantia nigra and ventral pallidum (Nauta, Smith, Faull & Domesick 1978), or to the pattern and nature of direct corticonigral drive. Heimer, Switzer and Van Hoesen (1982) have suggested that the ventral striatopallidal system functions in parallel with the neostriatum-globus pallidus (dorsal striatopallidal system) such that "the ventral striato-pallidal system has a stronger role in initiating movements in response to emotionally or motivationally powerful stimuli" (Heimer et al. 1982, p. 87), whereas the dorsal striatopallidal system "may play a preeminent role in initiating motor activities stemming from cognitive activities" (Heimer et al. 1982, pp. 86–87). Studies of the ventral striatum (i.e. nucleus accumbens, olfactory tubercle, and the islands of Calleja) indicate that it may be an important interface zone between the linking of limbic associations to environmental stimuli and the generation of action (see Mogenson, Jones & Yim 1980). There thus appears to be a duality of function in the striatopallidal

systems which corresponds to that identified for the cortical premotor regions in the target article. There is a second major DA system impinging on the medial premotor system – the so-called mesocortical system, which sends direct inhibitory projections from the ventral tegmental area to the anterior cingulate cortex and related mesial frontal cortex as well as to the ventral striatum and to various limbic regions (Moore & Bloom 1978). It is unlikely that we will fully understand the participation of the DA projections in the initiation of spontaneous and triggered behaviors until we can clarify how these two projection systems differentially perform and interact in the operation of the dorsal and ventral striatopallidal systems and the putative medial and lateral premotor cortical systems.

**6. Toward a functional evolutionary architectonics.** Solid architectonic support has been provided by Pandya & Barbas together with additional information to add weight to the differentiation of the ventrolateral part of area 6 from the dorsomedial component in both a structural sense and an implied functional sense. I would only add to their comments the idea that the ventral premotor region does appear to contain a forelimb representation in the posterior bank of the inferior limb and spur of the arcuate sulcus (Godschalk et al. 1984; Muakkassa & Strick 1979).

Together with the comments of Fuster this suggests that there is fundamental value in attempting to integrate knowledge about evolutionary cortical architectonics with functional information capitalizing on the "indissoluble unity of structure and function (behavior) of living matter" (Yakovlev 1948, p. 314). This is not meant to play down the importance of physiologic data (see Kornhuber & Deecke), but knowledge of biologic form and its phylogenetic development can provide an important and valuable context in which to interpret the functional data. Phylogenetically older structures are likely to assume more integral, deep, rudimentary aspects of function whereas those of recent development can be viewed as surface elaborations correlating with the emergence of phylogenetically more recent behaviors. Thus progressive structural gradations can be viewed as correlates of behavioral continua and may be linked to microgenetic bases of behavior. The explosive growth of the prefrontal association regions in primates and man along the anterior–posterior axis can accordingly be seen as a structural correlate of the development and elaboration of the ability to control and maintain complex contiguous goal-directed behavioral sequences spanning wide chunks of time (see Fuster's commentary). It is interesting that the culminating structure in this developmental sequence is the primary sensorimotor cortex, suggesting a link between these cognitive functions and the role of the primary sensorimotor cortex in fine detail coordinative ability.

**7. Hodology and microelectrophysiology versus clinical neuropsychology: Can the gap be bridged?** The difficulty associated with loosely interchanging the use of the term SMA with that of "medial premotor system" has been quite correctly pointed out by Wiesendanger. This is particularly problematic in the analysis of the clinical data in which it is quite unlikely that pure lesions involving the

SMA as defined by electrical stimulation are obtained. It also produces difficulties in correlating rCBF studies with exact anatomic locations and architectonic fields, and there readily appears a confusion between traditional definitions of the location of the SMA and those that are defined otherwise. I have added to this confusion by having misrepresented Braak's definition of his supero-frontal magnopyramidal field (see Braak, 1980, p. 99). This field, in its posterior extent, *overlaps* the dorsal and medial aspects of the paraganglionic belt, although it does extend well beyond this region anteriorly and thus goes beyond the region of the SMA as defined by electrical stimulation, though it would be expected to contain SMA thus identified. Hodology, however, would indicate that the SMA is a zone of remarkable convergence within this system (e.g. Künzle 1978; Wiesendanger & Wiesendanger 1985; see also Kornhuber & Deecke) and that it is a region from which a massive bilateral projection to primary motor cortex emanates, implicating it as a crucial structure within this system. The extent to which functions I have attributed to the SMA should rightly be associated with adjacent structures on the mesial surface of the frontal lobes remains to be clearly determined experimentally.

I do not agree, however, with Wiesendanger's pessimism regarding the value of interaction between micro-electrophysiologic and clinical-neuropsychological research. Although it is quite clear that a great deal more precision in anatomic definition is possible in micro-electrode unit recording, it is also clear that paradigm design that will help to define the functional relevance of unit behavior in association regions of the cortex must begin to borrow more heavily from neuropsychological considerations. It is also evident that data obtained from unit studies in primates, such as that reported in the Porter and Tanji commentaries, provide useful insights into the neuropsychological deficits of patients with SMA damage. Less focal approaches to electrophysiologic recording (such as the acquisition of transcortical field potentials or the use of multiunit recording technology) would permit the simultaneous sampling of population activity in well-defined regions; this may allow analysis to proceed at an intermediate level of definition (see also Weinrich). Obviously, microelectrophysiologic studies in human subjects are limited by ethical considerations, and necessarily less anatomically precise techniques must be applied. However, great strides have been made in this area using physiologic imaging techniques (e.g. Phelps & Mazziotta 1985; see also Roland & Friberg 1985; Sokoloff 1985) and scalp electric field mapping (see Libet and Kornhuber & Deecke). Ultimately the challenge of such brain research is similar to that of all multidisciplinary fields of endeavor: The goal will be to reach some form of synthesis that adequately integrates information obtained using widely disparate approaches at many structural and functional levels and across a variety of species.

**8. Volitional processes, the readiness potential, and the SMA.** I wish to reexamine briefly my attempt to relate the operation of components of the putative medial premotor system to the volitional processes Libet has identified using the readiness potential. First of all, I did not mean to imply that the operations of loop 1 and loop 2 do not overlap in time even though they may become active in

sequence. Second, both loop 1 and loop 2 are meant to become operative with medial system activity only. Third, loop 2 operation is *not* necessarily preceded by loop 1 activity. Thus, in the endogenous, spontaneous, self-initiated act that does not depend critically upon external information for its timing, loop 2 predominates, and loop 1, which normally integrates the learned elements of the sensory context into the task, is not used. Loop 2 operation entails activity in the SMA and MI only without activation of other regions of cortex. Thus the topographic distribution of the readiness potential (RP) associated with the operation of loop 2 would be expected to be dominated by vertex (SMA) activity, agreeing with the observation that the type II RP has this distribution (see Libet commentary). When a particular feature of the sensory context is linked to the timing of the response, loop 1 activity is added, with the associated basal ganglia-dependent detection of the critical elements of the context and the associated selection of the appropriate motor program. In this case, widespread sensory association cortical activity occurs initially, overlapping the subsequent phase of SMA activity. Thus the vertex domination of the RP would be less apparent when loop 1 and loop 2 work together preceding onset of movement, corresponding to volitional process I (activity in loop 1) preceding and overlapping with volitional process II (activity in loop 2). The data suggest also that SMA activity would generally overlap with activity in MI in loop 2 activation.

I would accordingly agree with Libet's point of clarification that loops 1 and 2 do not operate in strictly serial fashion. There may be a significant overlap, although the onset of loop 1 activity, when it occurs, generally precedes the onset of loop 2 activity. This would actually correspond to three topographic phases which we have observed in the distribution of the RP: (a) An initial phase of widespread activity with minimal vertex dominance, (b) progressive increase in vertex activity corresponding to increasing recruitment of activity in the SMA (this usually begins at around -500 mS and is marked by an inflection in the signal recorded at the vertex electrode; see Figure 10 in the target article where this point occurs at the intersection of the components labeled RP and NS'; see also Shibasaki, Barrett, Halliday & Halliday 1980, as well as Figure 1 in Kornhuber & Deecke), and (c) lateralization of the distribution to contralateral central areas as MI becomes active. With a type II volitional process active alone, only phases (b) and (c) would be seen, and, because there would be no overlap of phase (a) with phase (b) in this situation, the vertex domination of the distribution would be expected to be greater than in the type I-type II combination seen with an externally contingent action (Goldberg, Kwan, Borrett & Murphy 1985; see Response Figure 1).

With regard to Libet's question concerning whether patients with damage to the medial system experience a conscious "intention to act," I think that careful consideration of Luria's description ("thoughts do not enter my head"; Luria 1966, p. 226) and that of Damasio and Van Hoesen (1983) would indicate that, at least in the initial acute phase of the damage, these patients sustain a decrease in the frequency of such experiences, which they are able to report retrospectively. With unilateral damage, however, the patient recovers quickly from this



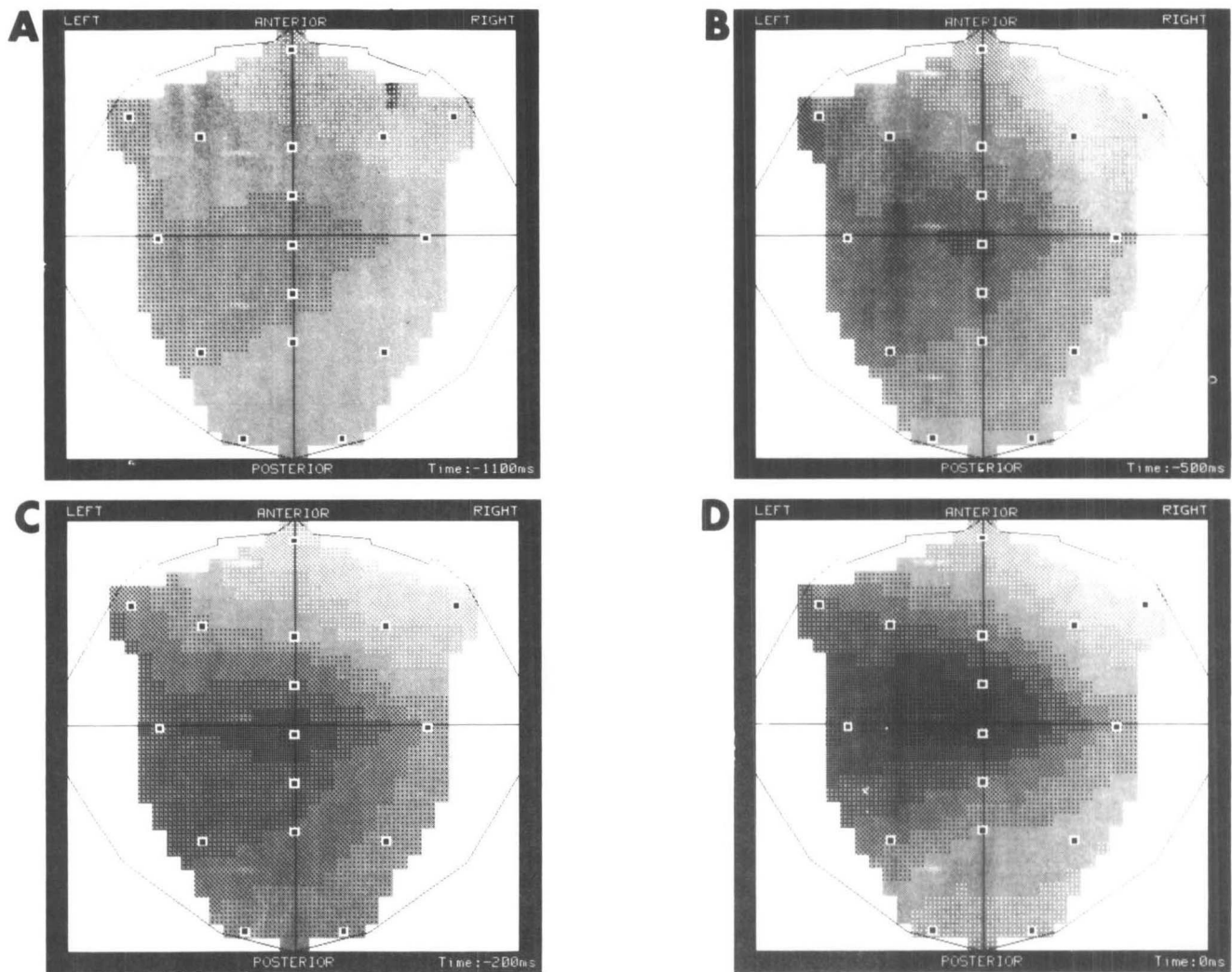

thumb. Maps were generated from grand average data collected from 14 normal subjects. Maps show top view projection of the field at selected points in time preceding the onset of EMG activity in the prime mover (flexor pollicis longus).

state, although with bilateral damage, as **Kornhuber & Deecke** note, a lasting state of akinetic mutism is observed. I would be very interested in further details of what “direct questions about the patient’s conscious feelings of intention” would be of value so that we can illuminate further this very important issue the next time we have such a patient appear before us.

As for the issue of timing of unconscious awareness of the intent to act, I think that the microgenetic analysis is useful together with the proposed model of the putative medial premotor system presented in the target article in trying to relate the point at which the awareness of impending movement occurs to presumed physiologic processes occurring during the moments preceding the beginning of the action. As outlined above and in **Brown’s** commentary, the conscious feeling of volition in behavior may be viewed as a simultaneous development occurring with the progress toward externalization of the action in microgenesis. Where precisely in the microgenetic sequence this feeling of volition becomes conscious is uncertain, but Libet’s data clearly imply that it develops at a point after the initial appearance of the RP on the scalp and therefore after the beginning of Volitional Process I and phase (a) identified above in the topograph-

ic description of the RP distribution. In his target article in this issue Libet reports that the time of the initial awareness of intending to move occurs at around 200 mS prior to movement onset. The type II RP recorded with the fully endogenous, self-initiated movements began at around 550 mS before the movement (see Libet: “Unconscious Cerebral Initiative and the Role of Conscious Will in Voluntary Action” this issue of *BBS*). Topographic recording of the RP in such a situation reveals a symmetric, vertex-centered distribution from the onset of the RP until about -150 mS. Then the field begins to lateralize, with an additional asymmetric negativity over the contralateral central region appearing slowly so that, at the moment the movement begins, the negative field involves the vertex and the contralateral central region (see also **Kornhuber & Deecke**, Figure 1). I would suggest that the emergence of the conscious awareness of movement may somehow be linked to this transformation in field configuration (in terms of the topographic phases defined above, this corresponds to the transition from phase b to phase c). Whereas the active structures are bilateral SMA areas and related subcortical regions, the process preceding the act has not yet achieved a critical “momentum” needed for verbalizable conscious

awareness; but with the transition of activity in loop 2 of the proposed model from a bilaterally organized, symmetric process to one in which asymmetry arises with a unilateral movement (presumably with rising activation in the contralateral primary motor cortex, MI), the process may acquire this new attribute. This process of recruiting MI may also correlate with a decreasing reversibility of the act. That is, the likelihood of a successful application of the “veto” decreases as the stage of MI activation is engaged. How and where this critical transformation in the process associated with a volitional act occurs is not immediately apparent, but it may occur in the transcerebellar Loop 2 of the proposed system.

**9. Summary.** One of the most fundamental features of human experience is the capacity for conscious control of action, yet the attempt to understand the scientific basis of this experience has seemed elusive, if not impossible. It involves profound issues of causation in biological systems and has led to a debate (examined in detail by Sperry 1983) between those who call for the need to recognize open-ended causal links in which there is an interaction between “mental” and “physical” entities (e.g. Eccles 1982; Popper & Eccles 1977) and those who maintain the position that “mental activity is not an additional *force* over and above those physically detectable in the brain, but an additional *internal aspect* of the total human activity, of which the brain (and body) activity is the complementary ‘external’ aspect” (D. M. MacKay 1966, p. 423) and that “higher order mental forms are . . . dependent on, and inseparable from the physiological substrate” (Sperry 1983, p. 98). The phenomena of consciousness in action are thus viewed as emergent properties arising from neural activity. This relationship is roughly analogous to the way the appearance of letters on the screen of my personal computer is related to the flow of electrons through its integrated circuits. There is the intermediate level where, through concepts of information and control, order and symbolic meaning are assigned to the physical events by applying specific constraints to them (but see Stuart 1985 for a discussion of the formal scientific problems that arise out of the anthropocentric tendency to attribute information-processing ability to a biological system). Thus the word-processing software running on my machine constrains the activity of its circuitry so that I can have a purposeful interaction with the equipment and can complete this document. What makes me quite unlike this machinery in front of me (thankfully!) is a profoundly different history.

I believe, together with some of the commentators, that with our growing understanding of SMA functions, we may be beginning to scratch the surface of a solution to the question of what constitutes the neural substrate of conscious action. The challenge posed is at once a difficult and intensely exciting one and the answers we find may well shape in profound ways the way we view our existence in the world.

#### ACKNOWLEDGMENTS

I would like to take this opportunity to acknowledge the support of Dr. J. T. Demopoulos and the board and administration of Moss Rehabilitation Hospital.

#### NOTE

I. I am not so certain that these are altogether conflicting points of view, and, with careful consideration, they could be usefully seen as complementary approaches.

#### References

- Abbie, A. (1940) Cortical lamination in the monotremata. *Journal of Comparative Neurology* 72:428–67. [taGG, EJN]
- Adams, R. D. & Victor, M. (1981) *Principles of neurology*. McGraw-Hill. [MWe]
- Aitken, P. G. (1981) Cortical control of conditioned and spontaneous vocal behavior in rhesus monkeys. *Brain and Language* 13:171–84. [taGG]
- Alexander, M. P. & Schmitt, M. A. (1980) The aphasia syndrome of stroke in the left anterior cerebral artery territory. *Archives of Neurology* 37:97–100. [taGG]
- Angel, R. W. (1976) *Efference copy in the control of movement*. Neurology (Minneapolis) 26:1164–68. [taGG]
- Arbib, M. A. (1981) Perceptual structures and distributed motor control. In *Handbook of physiology: The nervous system*, vol. 2, *Motor control*, ed. V. B. Brooks. American Physiological Society. [taGG]
- Baleydier, C. & Mauguière, F. (1980) The duality of the cingulate gyrus of the monkey: Neuroanatomical study and functional hypothesis. *Brain* 103:525–54. [taGG, EJN]
- Barbas, H. & Pandya, D. N. (1981) Frontal lobe afferent input to area 6 in the rhesus monkey. *Society for Neuroscience Abstracts* 7:414. [DP]
- (1982) Cytoarchitecture and intrinsic connections of the frontal cortex in the rhesus monkey. *Society for Neuroscience Abstracts* 8:933. [DP]
- Bear, D. M. (1983) Hemispheric specialization and the neurology of emotion. *Archives of Neurology* 40:195–202. [taGG]
- Becker, W., Hoehne, O., Iwase, K. & Kornhuber, H. H. (1972) Bereitschaftspotential, prämotorische Positivierung und andere Hirnpotentiale bei sakkadischen Augenbewegungen. *Vision Research* 12:431–36. [HHK]
- Benjamin, D. & Van Hoesen, G. W. (1982) Some afferents of the supplementary motor area (SMA) in the monkey. *Anatomical Record* 202:15A. [DP]
- Bernstein, N. A. (1967) *The co-ordination and regulation of movements*. Pergamon Press. [JWB, taGG, JPS]
- (1984) Trends and problems in the study of investigation of physiology of activity. In: *Human motor actions: Bernstein reassessed*, ed. H. T. A. Whiting, North-Holland. [rGG]
- Biber, M. P., Kneisley, L. W. & LaVail, J. H. (1978) Cortical neurons projecting to the cervical and lumbar enlargements of the spinal cord in young and adult rhesus monkeys. *Experimental Neurology* 59:492–508. [taGG]
- Bizzi, E., Polit, A. & Morasso, P. (1976) Mechanisms underlying achievement of final head position. *Journal of Neurophysiology* 39:435–44. [JPS]
- Bloxham, C. A., Mindel, T. A. & Frith, C. D. (1984) Initiation and execution of predictable and unpredictable movements in Parkinson's disease. *Brain* 107:371–84. [taGG]
- Bogen, J. E. (1979) The callosal syndrome. In: *Clinical neuropsychology*, ed. K. M. Heilman & E. Valenstein. Oxford University Press. [taGG]
- Boschert, J., Hink, R. F. & Deecke, L. (1983) Finger movement versus toe movement-related potentials: Further evidence for supplementary motor area (SMA) participation prior to voluntary action. *Experimental Brain Research* 55:73–80. [HHK]
- Bowker, R. M. & Coulter, J. D. (1981) Intracortical connectivities of somatic sensory and motor areas: Multiple cortical pathways in monkeys. In: *Cortical sensory organization*, vol. 1, *Multiple somatic areas*, ed. C. N. Woolsey. Humana Press. [taGG]
- Braak, H. (1980) *Architectonics of the human telencephalic cortex*. Springer-Verlag. [tarGG, MWi]
- Brand, M. (1984) *Intending and acting: Toward a naturalized action theory*. MIT Press. [rGG]
- Brinkman, C. (1981) Lesions in supplementary motor area interfere with a monkey's performance of a bimanual coordination task. *Neuroscience Letters* 27:267–70. [HHK]
- (1982) Callosal section abolishes bimanual coordination deficit resulting from supplementary motor area lesion in the monkey. *Society for Neuroscience Abstracts* 8:734. [taGG, HHK]
- (1985) Comparison of the activity of neurones in the supplementary motor and premotor areas associated with self-paced movements in the monkey. *Experimental Brain Research* 58:A7. [rGG]
- Brinkman, C. & Porter, R. (1979) Supplementary motor area of the monkey: Activity of neurons during performance of a learned motor task. *Journal of Neurophysiology* 42:681–709. [tarGG, RP]



## References/Goldberg: Supplementary motor area

- Brinkman, J. (1981) Lesions in supplementary motor area interfere with a monkey's performance of a bimanual coordination task. *Neuroscience Letters* 27:267–70. [taGG]
- Brian, S. & Jedynak, C.-P. (1972) Trouble du transfert interhémisphérique à propos de trois observations de tumeurs du corps calleux: Le signe de la main étrangère. *Revue Neurologique* 126:257–66. [taGG]
- Brodman, K. (1908) Beiträge zur histologischen Lokalisation der Grosshirnrinde. 4. Mitteilung: Die Cortexgliederung des Menschen. *Journal of Psychology and Neurology* 10:231–46. [tarGG]
- Brown, J. W. (1977) *Mind, brain and consciousness: The neuropsychology of cognition*. Academic Press. [JWB, JMF, tarGG]
- (1979) Language representation in the brain. In: *Neurobiology of social communication in primates*, ed. H. Steklis & M. Raleigh. Academic Press. [JWB]
- (1983) Microstructure of perception. *Cognition and Brain Theory* 6:145–84. [JWB]
- (1985) Frontal lobe syndromes. In: *Handbook of clinical neurology*, 2d ed., ed. P. Vinken, G. Bruyn & H. Klawans. Elsevier. [JWB]
- Brust, J. C. M., Plank, C., Burke, A., Cuobadia, M. M. I. & Heaton, E. B. (1982) Language disorder in a right-hander after occlusion of the right anterior cerebral artery. *Neurology* 32:492–97. [taGG]
- Buser, P., Bancaud, J. & Chauvel, P. (1982) A study of some connections of the human SMA. *Experimental Brain Research*, suppl., in press. [BL]
- Campbell, A. W. (1905) *Histological studies on the localization of cerebral function*. Cambridge University Press. [taGG]
- Cooke, J. D., Brown, J. D. & Brooks, V. B. (1978) Increased dependence on visual information for movement control in patients with Parkinson's disease. *Canadian Journal of Neurological Sciences* 5:413–15. [taGG]
- Cools, A. R. (1980) Role of the neostriatal dopaminergic activity in sequencing and selecting behavioral strategies: Facilitating of processes involved in selecting the best strategy in a stressful situation. *Behavioral and Brain Research* 1:361–68. [tarGG]
- Coxe, W. S. & Landau, W. M. (1965) Observations upon the effect of supplementary cortex ablation in the monkey. *Brain* 88:763–72. [taGG]
- Crutcher, M. D. & DeLong, M. R. (1984) Single cell studies of the primate putamen. 2. Relations to direction of movement and pattern of muscular activity. *Experimental Brain Research* 53:244–58. [WS]
- Damasio, A. & Geschwind, N. (1984) The anatomical basis of language: Recent advances. *Annual Review of Neurosciences* 7:127–47. [ARD]
- Damasio, A. R. & Van Hoesen, G. W. (1980) Structure and function of the supplementary motor area. *Neurology* 30:359. [taGG]
- (1983) Emotional disturbances associated with focal lesions of the limbic frontal lobe. In: *The neuropsychology of human emotion: Recent advances*, ed. K. M. Heilman & P. Satz. Guilford Press. [ARD, rGG]
- Damasio, A. R., Van Hoesen, G. W. & Vilenky, J. (1981) Limbic-motor pathways in the primate: A means for emotion to influence motor behavior. *Neurology* 31:60. [ARD, tarGG]
- Dart, D. A. (1934) The dual structure of the neopallium: Its history and significance. *Journal of Anatomy* 69:3–19. [taGG]
- Deecke, L., Grozinger, B. & Kornhuber, H. H. (1976) Voluntary finger movement in man: Cerebral potentials and theory. *Biological Cybernetics* 23:99–119. [taGG, HHK]
- Deecke, L., Heise, B., Kornhuber, H. H., Lang, M. & Lang, W. (1984) Brain potentials, associated with voluntary manual tracking: Bereitschaftspotential, conditioned pre-motion positivity, directed attention potential, and relaxation potential. Anticipatory activity of the limbic and frontal cortex. *Annals of the New York Academy of Sciences* 425:450–64. [HHK]
- Deecke, L. & Kornhuber H. H. (1978) An electrical sign of participation of the mesial "supplementary" motor area in human voluntary finger movement. *Brain Research* 159:473–76. [taGG, HHK, WS]
- Deecke, L., Scheid, P. & Kornhuber H. H. (1969) Distribution of the readiness potential, pre-motion positivity, and motor potential of human cerebral cortex preceding voluntary finger movements. *Experimental Brain Research* 7:158–68. [taGG, HHK]
- DeLong, M. R. (1982) Cortico-basal ganglia loops. In: *Neural coding of motor performance*, ed. J. Massion, J. Paillard, W. Schultz & M. Wiesendanger. *Experimental Brain Research*, supp. 7. Springer-Verlag. [rGG]
- Denny-Brown, D. (1958) Nature of apraxia. *Journal of Nervous and Mental Diseases* 126:9–32. [taGG]
- (1966) *The cerebral control of movement*. Thomas. [taGG]
- Deschênes M., Paradis, M., Roy, J. P. & Steriade M. (1984) Electrophysiology of neurons of lateral thalamic nuclei in cat: Resting properties and burst discharges. *Journal of Neurophysiology* 51:1196–1219. [taGG, MWe]
- Desmedt, J. E. (1981) Scalp-recorded cerebral event-related potentials in man as point of entry into the analysis of cognitive processing. In: *The organization of the cerebral cortex*, ed. F. O. Schmitt, F. G. Worden, G. Adelman & S. D. Dennis. MIT Press. [rGG]
- Deuel, R. K. & Dunlop, N. L. (1979) Role of frontal polysensory cortex in guidance of limb movements. *Brain Research* 169:183–88. [taGG]
- DeVito, J. L. & Anderson, M. E. (1982) An autoradiographic study of efferent connections of the globus pallidus in *Macaca mulatta*. *Experimental Brain Research* 46:107–17. [taGG]
- Diamond, I. T. (1979) The subdivisions of neocortex: A proposal to revise the traditional view of sensory, motor, and association areas. In: *Progress in psychobiology and physiological psychology*, vol. 8, ed. J. M. Sprague & A. N. Epstein. Academic Press. [EJN]
- Donchin, E., Ritter, W. & McCallum, W. C. (1978) Cognitive psychophysiology: The endogenous components of the ERP. In: *Event-related brain potentials in man*, ed. E. Callaway, P. Tueting & S. H. Koslow. Academic Press. [tarGG]
- Eccles, J. C. (1982) The initiation of voluntary movements by the supplementary motor area. *Archiv für Psychiatrie und Nervenkrankheiten* 231:423–41. [tarGG, BL, WS]
- (1984) The wonder of being human. In: *Our brain and our mind*, ed. J. C. Eccles & D. Robinson. Macmillan. [ARD]
- Edelman, G. M. (1978) Group selection and phasic reentrant signaling: A theory of higher brain function. In: *The mindful brain: Cortical organization and the group-selective theory of higher brain function*. MIT Press. [tarGG]
- Edelman, G. M. & Finkel, L. H. (1984) Neuronal group selection in the cerebral cortex. In: *Dynamic aspects of neocortical function*, ed. G. M. Edelman, W. E. Gall & W. M. Cowan. John Wiley. [rGG]
- Eidelberg, D. & Galaburda, A. M. (1984) Inferior parietal lobule: Divergent architectonic asymmetries of the human brain. *Archives of Neurology* 41:843–52. [taGG]
- Erickson, T. C. & Woolsey, C. N. (1951) Observations of the supplementary motor area of man. *Transactions of the American Neurological Association* 76:50–52. [taGG]
- Fel'dman, A. G. & Latash, M. L. (1982) Afferent and efferent components of joint position sense: Interpretation of kinesthetic illusions. *Biological Cybernetics* 42:205–14. [JPS]
- Fentress, J. C. (1984) The development of coordination. *Journal of Motor Behavior* 16:99–134. [JPS]
- Flowers, K. (1978) Lack of prediction in the motor behaviour of parkinsonism. *Brain* 101:35–52. [taGG]
- Foerster, O. (1936) Motorische Felder und Bahnen. In: *Handbuch der Neurologie*, Vol. 6, ed. O. Bumke & O. Förster. Springer. [HHK, MWi]
- Foit, A., Larsen, B., Hattori, S., Skinhøj, E. & Lassen, N. A. (1980) Cortical activation during somatosensory stimulation and voluntary movement in man: A regional cerebral blood flow study. *Electroencephalography and Clinical Neurophysiology* 50:426–36. [rGG]
- Fuster, J. M. (1973) Unit activity in prefrontal cortex during delayed-response performance: Neuronal correlates of transient memory. *Journal of Neurophysiology* 36:61–78. [JMF]
- (1980) *The prefrontal cortex: Anatomy, physiology, and neuropsychology of the frontal lobe*. Raven Press. [taGG]
- (1981) Prefrontal cortex in motor control. In: *Handbook of physiology, nervous system*, vol. 2, (ed. V. B. Brooks). American Physiological Society. [JMF]
- (1984) Behavioral electrophysiology of the prefrontal cortex. *Trends in Neurosciences* 7:408–14. [JMF]
- Fuster, J. M., Bauer, R. H. & Jervey, J. P. (1982) Cellular discharge in the dorsolateral prefrontal cortex of the monkey in cognitive tasks. *Experimental Neurology* 77:679–94. [JMF]
- Galaburda, A. M. & Pandya, D. N. (1982) Role of architectonics and connections in the study of primate brain evolution. In: *Primate brain evolution: Methods and concepts*, ed. E. Armstrong & D. Falk. Plenum Press. [taGG]
- (1983) The intrinsic, architectonic and connective organization of the superior temporal region of the rhesus monkey. *Journal of Comparative Neurology* 221:169–84. [DP]
- Geschwind, N. (1965) Disconnexion syndromes in animals and man. *Brain* 88:237–94, 585–644. [rGG]
- (1975) The apraxias: Neural mechanisms of disorders of learned movement. *American Scientist* 63:188–95. [MWe]
- Gibson, J. J. (1966) *The senses considered as perceptual systems*. Houghton-Mifflin. [JPS]
- (1979) *The ecological approach to visual perception*. Houghton-Mifflin. [JPS]
- Gloor, P., Olivier, A., Quesney, L. F., Andermann, F. & Horowitz, S. (1982) The role of the limbic system in experiential phenomena of temporal lobe epilepsy. *Annals of Neurology* 12:129–44. [taGG]



- Godschalk, M. & Lemon, R. N. (1983) Involvement of monkey premotor cortex in preparation of arm movements. *Experimental Brain Research*, *suppl.* 7:114-19. [taGG]
- Godschalk, M. & Lemon, R. N. (1983) Involvement of monkey premotor cortex in preparation of arm movements. *Experimental Brain Research*, (*suppl.*) 7:114-19. [taGG]
- Godschalk, M., Lemon, R. N., Kuypers, H. G. J. M. & Ronday, H. K. (1984) Cortical afferents and efferents of monkey postarcuate area: An anatomical and electrophysiological study. *Experimental Brain Research* 56:410-24. [tarGG, DP]
- Godschalk, M., Lemon, R. N., Nijs, H. G. T. & Kuypers, H. G. J. M. (1981) Behaviour of neurons in monkey peri-arcuate and precentral cortex before and during visually guided arm and hand movements. *Experimental Brain Research* 44:113-16. [taGG]
- Goldberg, G. (1984) Response and projection: A reinterpretation of the premotor concept. In: *Neuropsychology of apraxia and related disorders*, ed. E. A. Roy. Elsevier/North Holland. [taGG]
- Goldberg, G., Kwan, H. C., Borrett, D. & Murphy, J. T. (1984a) Differential topography of the movement-associated scalp potential with internal vs. external dependence of movement timing. *Archives of Physical Medicine and Rehabilitation* 65:630. [taGG]
- (1984b) Topography of the movement-associated scalp potential suggests initiation of spontaneous movement by the supplementary motor area. *Archives of Physical Medicine and Rehabilitation* 65:662. [taGG]
- (1985) Topography of the movement-associated potential with self-initiated and externally contingent action. In preparation. [rGG]
- Goldberg, G., Mayer, N. H. & Togliola, J. U. (1981) Medial frontal cortex infarction and the alien hand sign. *Archives of Neurology* 38:683-68. [taGG, EJN]
- Gould, H. J., III, Cusick, C. G., Pons, T. P. & Kaas, J. H. (1983) The relation of callosal connections to microstimulation maps of precentral motor cortex in owl monkeys. *Society for Neuroscience Abstracts* 9:309. [taGG]
- Gray, J. A. (1975) *Elements of a two-process theory of learning*. Academic Press. [JAG]
- (1982a) *The neuropsychology of anxiety: An enquiry into the functions of the septo-hippocampal system*. Oxford University Press. [taGG, JAG]
- (1982b) *Précis of Gray's The neuropsychology of anxiety: An enquiry into the functions of the septo-hippocampal system*. *Behavioral and Brain Sciences* 5:469-84. [JAG]
- Graybiel, A. M. & Ragsdale, C. W., Jr. (1979) Fiber connections of the basal ganglia. *Progress in Brain Research* 51:239-82. [rGG]
- Green, J. R., Angevine, J. B., White, J. C., Jr., Edes, A. D. & Smith, R. D. (1980) Significance of the supplementary motor area in partial seizures and in cerebral localization. *Neurosurgery* 6:66-75. [taGG]
- Grözing, B., Kornhuber, H. H. & Kriebel, J. (1979) Participation of mesial cortex in speech: Evidence from cerebral potentials preceding speech production in man. *Experimental Brain Research*, *suppl.* 2:189-92. [HHK]
- Haberly, L. B. & Price, J. L. (1978) Association and commissural fiber systems of the olfactory cortex of the rat: Systems originating in the olfactory peduncle. *Journal of Comparative Neurology* 181:781-808. [EJN]
- Hassler, R. (1980) Brain mechanisms of intention and attention with introductory remarks on other volitional processes. *Progress in Brain Research* 54:585-614. [HHK]
- Heilman, K. M. & Valenstein, E. (1979) Mechanisms underlying hemispatial neglect. *Annals of Neurology* 5:166-70. [taGG]
- Heimer, L., Switzer, R. D. & Van Hoesen, G. W. (1981) Ventral striatum and ventral pallidum: Components of the motor system? *Trends in Neuroscience* 5:83-87. [rGG]
- Hendry, S. H. C., Jones, E. G. & Graham, J. (1979) Thalamic relay nuclei for cerebellar and certain related fiber systems in the cat. *Journal of Comparative Neurology* 185:679-714. [taGG]
- Herkenham, M. (1980) Laminar organization of thalamic projections to the rat cortex. *Science* 207:532-33. [taGG]
- Hillyard, S. A., Picton, T. W. & Regan, D. (1978) Sensation, perception and attention: Analysis using ERPs. In: *Event-related brain potentials in man*, ed. E. Callaway, P. Tueting & S. H. Koslow. Academic Press. [taGG]
- Hore, J., Meyer-Lohmann, J. & Brooks, V. B. (1977) Basal ganglia cooling disables learned arm movements of monkeys in the absence of visual guidance. *Science* 195:584-86. [taGG]
- Hore, J. & Vilis, T. (1984) Loss of set in muscle responses to limb perturbations during cerebellar dysfunction. *Journal of Neurophysiology* 51:1137-48. [taGG]
- Horsley, V. & Schafer, E. A. (1888) A record of experiments upon the functions of the cerebral cortex. *Philosophical Transactions of the Royal Society of London* 179B:1-45. [taGG]
- Huang, S.-C., Phelps, M. E., Hoffman, E. J., Sideris, K., Selin, C. J. & Kuhl, D. E. (1980) Noninvasive determination of local cerebral metabolic rate of glucose in man. *American Journal of Physiology* 238:E69-E82. [taGG]
- Huffman, R. D., Felpel, L. P. & Lum, J. (1984) An extracellular microelectrode study of globus pallidus and cerebellar projections to the thalamus of the monkey. *Society for Neuroscience Abstracts* 10:180. [taGG]
- Humphrey, D. R. (1979) On the cortical control of visually directed reaching: Contributions by nonprecentral motor areas. In: *Posture and movement*, ed. R. E. Talbot & D. R. Humphrey. Raven Press. [taGG]
- Humphrey, D. R. & Reed, D. J. (1983) Separate cortical systems for control of joint movement and joint stiffness: Reciprocal activation and coactivation of antagonist muscles. In: *Advances in neurology*, vol. 39, *Motor control in health and disease*, ed. J. E. Desmedt. Raven Press. [MWe]
- Humphrey, D. R., Schmidt, E. M. & Thompson, W. D. (1970) Predicting measures of motor performance from multiple spike trains. *Science* 179:758-62. [MWe]
- Jackson, J. H. (1884) The Croonian lectures: Evolution and dissolution of the nervous system. *British Medical Journal* 1:591-93, 660-63, 703-7. [taGG]
- Jaspers, R., Schwarz, M., Sontag, K. H. & Cools, A. R. (1984) Caudate nucleus and programming behaviour in cats: Role of dopamine in switching motor patterns. *Behavioural Brain Research* 14:17-28. [rGG]
- Jeannerod, M. & Biguer, B. (1982) Visuomotor mechanisms in reaching within extrapersonal space. In: *Analysis of visual behavior*, ed. D. J. Ingle, M. A. Goodale & R. J. W. Mansfield. MIT Press. [taGG]
- Jonas, S. (1981) The supplementary motor region and speech emission. *Journal of Communication Disorders* 14:349-73. [taGG]
- Jones, E. G. (1981) Functional subdivisions and synaptic organization of the mammalian thalamus. *International Review of Physiology* 25:173-245. [taGG]
- (1983) The nature of the afferent pathways conveying short-latency inputs to primate motor cortex. In: *Motor control mechanisms in health and disease*, ed. J. E. Desmedt. Raven Press. [taGG]
- Jones, E. G., Coulter, J. D. & Hendry, S. H. C. (1978) Intracortical connectivity of architectonic fields in the somatic sensory, motor, and parietal cortex of monkeys. *Journal of Comparative Neurology* 181:291-348. [taGG]
- Jones, E. G. & Powell, T. P. S. (1970) An anatomical study of converging sensory pathways within the cerebral cortex of the monkey. *Brain* 93:793-820. [JMF, DP]
- Jones, E. G. & Wise, S. P. (1977) Size, laminar and columnar distribution of efferent cells in the sensory-motor cortex of monkeys. *Journal of Comparative Neurology* 175:391-438. [taGG]
- Jürgens, U. & Müller-Preuss, P. (1977) Convergent projections of different limbic vocalization areas in the squirrel monkey. *Experimental Brain Research* 29:75-83. [taGG]
- Jürgens, U. & von Cramon, D. (1982) On the role of the anterior cingulate cortex in phonation: A case report. *Brain and Language* 15:234-48. [taGG]
- Kalil, K. (1978) Neuroanatomical organization of the primate motor system: Afferent and efferent connections of the ventral thalamic nuclei. In: *Multidisciplinary perspectives in event-related brain potential research*, ed. D. A. Otto. U.S. Government Printing Office. [taGG]
- (1981) Projections of the cerebellar and dorsal column nuclei upon the thalamus of the rhesus monkey. *Journal of Comparative Neurology* 195:25-50. [taGG]
- Kelso, J. A. S. (1981) Contrasting perspectives on order and regulation in movement. In: *Attention and performance*, vol. 9, ed. J. Long & A. Baddeley. Erlbaum. [JPS]
- (1984) Phase transitions and critical behavior in human bimanual coordination. *American Journal of Physiology: Regulatory, Integrative, and Comparative* 246:R1000-4. [JPS]
- Kelso, J. A. S. & Holt, K. S. (1980) Exploring a vibratory systems analysis of human movement production. *Journal of Neurophysiology* 43:1183-96. [JPS]
- Kelso, J. A. S., Southard, D. L. & Goodman, D. (1979) On the nature of human interlimb coordination. *Science* 203:1029-31. [taGG]
- Kelso, J. A. S. & Tuller, B. H. (1981) Toward a theory of apraxic syndromes. *Brain and Language* 12:224-45. [JPS]
- Kleist, K. (1934) *Gehirnpathologie*. J. A. Barth. [HHK]
- Kornhuber, H. H. (1980) Introduction. *Progress in Brain Research* 54:x-xii. [HHK]
- (1984a) Attention, readiness for action, and the stages of voluntary decision - some electrophysiological correlates in man. *Experimental Brain Research*, *suppl.* 9:420-29. [HHK]

## References/Goldberg: Supplementary motor area

- (1984b) Mechanisms of voluntary movement. In: *Cognition and motor processes*, ed. W. Prinz & A. F. Sanders. Springer. [HHK]
- Környey, E. (1975) Aphasie transcorticale et écholalie: Le problème de l'initiative de la parole. *Revue Neurologique* 131:347–63. [taGG]
- Kosslyn, S. M. (1983) *Ghosts in the mind's machine*. W. W. Norton. [GR]
- Kristeva, R. & Deecke, L. (1980) Cerebral potentials preceding right and left unilateral and bilateral finger movements in sinistrals. *Progress in Brain Research* 54:748–54. [HHK]
- Kristeva, R., Keller, E., Deecke, L. & Kornhuber, H. H. (1979) Cerebral potentials preceding unilateral and simultaneous bilateral finger movements. *Electroencephalography and Clinical Neurophysiology* 47:229–38. [taGG]
- Kubota, K. & Hamada, I. (1978) Visual tracking and neuron activity in the post-arcuate area in monkeys. *Journal of Physiology (Paris)* 74:297–312. [taGG]
- Kugler, P. N., Kelso, J.A.S. & Turvey, M. T. (1980) On the concept of coordinative structures as dissipative structures: 1. Theoretical lines of convergence. In: *Tutorials in motor behavior*, ed. G. E. Stelmach & J. Requin. North-Holland. [JPS]
- Kugler, P. N. & Turvey, M. T. (in press) *Information, natural law and the self-assembly of rhythmic movement*. Erlbaum. [JPS]
- Künzle, H. (1978) An autoradiographic analysis of the efferent connections from premotor and adjacent prefrontal regions (areas 6 and 9) in *Macaca fascicularis*. *Brain and Behavioral Evolution* 15:185–234. [tarGG]
- Kurata, K. & Tanji, J. (1985) Contrasting neuronal activity in supplementary and precentral motor cortex of monkeys. 2. Responses to movement triggering vs. nontriggering sensory signals. *Journal of Neurophysiology* 53:142–52. [JT]
- Kutas, M. & Donchin, E. (1980) Preparation to respond as manifested by movement-related brain potentials. *Brain Research* 202:95–115. [taGG]
- Kuypers, H. G. J. M. (1981) Anatomy of descending systems. In: *Handbook of physiology*. Section 1: *The nervous system*. Vol. 2, *Motor control*, pt. 2, ed. J. M. Brookhart & V. B. Mountcastle. American Physiological Society. [EJN]
- Lang, W., Lang, M., Heise, B., Deecke, L. & Kornhuber, H. H. (1984) Brain potentials related to voluntary hand tracking, motivation and attention. *Human Neurobiology* 3:235–40. [rGG]
- Lang, W., Lang, M., Kornhuber, A., Deecke, L. & Kornhuber, H. H. (1984) Human cerebral potentials and visuomotor learning. *Pflügers Archiv. European Journal of Physiology* 399:342–44. [taGG, HHK]
- Laplante, D., Talairach, J., Meininger, V., Bancaud, J. & Orgogozo, J. M. (1977) Clinical consequences of corticectomies involving the supplementary motor area in man. *Journal of Neurological Sciences* 34:310–14. [tarGG, BL]
- Larsen, B., Skinhøj, E. & Lassen, N. A. (1978) Variations in regional cerebral blood flow in the right and the left hemispheres during automatic speech. *Brain* 101:193–209. [taGG]
- Lassen, N. A., Ingvar, K. H. & Skinhøj, E. (1978) Brain function and blood flow. *Scientific American* 239(4):62–71. [taGG]
- Lee, D. N. (1976) A theory of visual control of braking based on information about time-to-collision. *Perception* 5:437–59. [JPS]
- (1980) Visuo-motor coordination in space-time. In: *Tutorials in motor behavior*, ed. G. E. Stelmach & J. Requin. North-Holland. [JPS]
- Leichnetz, G. R., Spencer, R. F., Hardy, S. G. P. & Astruc, J. (1981) The prefrontal corticocortical projection in the monkey: An anterograde and retrograde horseradish peroxidase study. *Neuroscience* 6:1023–41. [EJN]
- Lhermitte, F. (1983) "Utilization behaviour" and its relation to lesions of the frontal lobes. *Brain* 106:237–55. [taGG]
- Libet, B., Alberts, W. W., Wright, E. W., Lewis, M. & Feinstein, B. (1975) Cortical representation of evoked potentials relative to conscious sensory responses and of somatosensory qualities – in man. In: *The somatosensory system*, ed. H. H. Kornhuber. George Thieme. [rGG, BL]
- Libet, B., Gleason, C. A., Wright, E. W., Jr. & Pearl, D. K. (1983) Time of conscious intention to act in relation to onset of cerebral activities (readiness-potential): The unconscious initiation of a freely voluntary act. *Brain* 106:623–42. [BL, WS]
- Libet, B., Wright, E. W., Jr. & Gleason, C. A. (1982) Readiness-potentials preceding unrestricted "spontaneous" vs. pre-planned voluntary acts. *Electroencephalography and Clinical Neurophysiology* 54:322–35. [taGG, BL]
- (1983) Preparation- or intention-to-act in relation to pre-event potentials recorded at the vertex. *Electroencephalography and Clinical Neurophysiology* 56:367–72. [taGG, BL]
- Lichtheim, L. (1885) On aphasia. *Brain* 7:433–84. [taGG]
- Liepmann, H. (1920) *Apraxie. Ergebnisse der ges. Medizin* 1:516–43. [JWB]
- Locke, J. (1690) *Essay concerning human understanding*. Quoted by M. Brand (1984) *Intending and acting: Toward a naturalized action theory*. MIT Press. [rGG]
- Lüders, H., Lesser, R. P., Dinner, D. S., Hahn, J. F., Salanga, V. & Morris, H. H. (1985) The secondary sensory area in humans: Evoked potential and electrical stimulation studies. *Annals of Neurology* 17:177–84. [rGG]
- Lüders, H., Lesser, R. P., Dinner, D. S., Morris, H. H. & Hahn, J. (1983) Inhibition of motor activity elicited by electrical stimulation of the human cortex. *Epilepsia* 24:519. [rGG]
- Luria, A. R. (1966) *Human brain and psychological processes*. Harper & Row. [tarGG, BL, EJN]
- (1980) *Higher cortical functions in man*. 2d ed. Basic Books. [rGG]
- McCarthy, R. & Warrington, E. K. (1984) A two-route model of speech production: Evidence from aphasia. *Brain* 107:463–85. [taGG]
- MacKay, D. G. (1985) A theory of the representation, organization and timing of action with implications for sequencing disorders. In: *Neuropsychological studies of apraxia and related disorders*, ed. E. A. Roy. North-Holland. [rGG]
- MacKay, D. M. (1966) Cerebral organization and the conscious control of action. In: *Brain and conscious experience*, ed. J. C. Eccles. Springer-Verlag. [rGG]
- (1978) The dynamics of perception. In: *Cerebral correlates of conscious experience*, ed. P. A. Buser & A. Rougeul-Buser. North-Holland. [taGG]
- (1984) Do "evaluation potentials" reflect cognitive assessment? *Experimental Brain Research* 55:184–86. [rGG]
- Mackay, W. A. & Murphy, J. T. (1979) Cerebellar influence on proprioceptive control loops. In: *Cerebro-cerebellar interactions*, ed. J. Massion & K. Sasaki. Elsevier/North Holland Biomedical Press. [taGG]
- Macpherson, J. M., Marangoz, C., Miles, T. S. & Wiesendanger, M. (1982) Microstimulation of the supplementary motor area (SMA) in the awake monkey. *Experimental Brain Research* 45:410–16. [taGG]
- Marsden, C. D. (1982) The mysterious motor function of the basal ganglia: The Robert Wartenberg lecture. *Neurology* 32:3514–39. [taGG]
- Masdeu, J. C., Schoene, W. C. & Funkenstein, H. (1978) Aphasia following infarction of the left supplementary motor area. *Neurology* 28:1220–23. [taGG]
- Massion, J. (1979) Role of motor cortex in postural adjustments associated with movement. In: *Integration in the nervous system*, ed. H. Asanuma & V. J. Wilson. Igaku Shoin. [taGG]
- Matsumura, M. & Kubota, K. (1979) Cortical projection to hand–arm motor area from post-arcuate area in macaque monkeys: A histological study of retrograde transport of horseradish peroxidase. *Neuroscience Letters* 11:241–46. [taGG]
- Maunsell, J. H. R. & Van Essen, D. C. (1983) The connections of the middle temporal visual area (MT) and their relationship to a cortical hierarchy in the macaque monkey. *Journal of Neuroscience* 3:2563–86. [DP]
- Merzenich, M. M., Kaas, J. H., Wall, J. T., Sur, M., Nelson, R. J. & Felleman, D. J. (1983) Progression of change following median nerve section in the cortical representation of the hand in areas 3b and 1 in adult owl and squirrel monkeys. *Neuroscience* 10:639–65. [rGG]
- Merzenich, M. M., Nelson, R. J., Stryker, M. P., Cynader, M., Schoppmann, A. & Zook, J. M. (1984) Somatosensory cortical map changes following digit amputation in adult monkeys. *Journal of Comparative Neurology* 224:591–604. [rGG, JPS]
- Mesulam, M.-M. (1981) A cortical network for directed attention and unilateral neglect. *Annals of Neurology* 10:309–25. [tarGG]
- Mogenson, G. J., Jones, D. L. & Yim, C. Y. (1980) From motivation to action: Functional interface between the limbic system and the motor system. *Progress in Neurobiology* 14:69–97. [rGG]
- Mogenson, G. J. & Phillips, A. G. (1976) Motivation: A psychological construct in search of a physiological substrate. *Progress in Psychobiology and Physiological Psychology* 6:189–243. [rGG]
- Moll, L. & Kuypers, H. G. J. M. (1977) Premotor cortical ablations in monkeys: Contralateral changes in visually guided reaching behavior. *Science* 198:317–19. [taGG]
- Moore, R. Y. & Bloom, F. E. (1978) Central catecholamine neuron systems: Anatomy and physiology of the dopamine systems. *Annual Review of Neuroscience* 1:129–69. [rGG]
- Morgane, P. J., Galaburda, A. M. & Jacobs, M. S. (1983) Evolutionary aspects of cortical organization in the dolphin brain. *Society for Neuroscience Abstracts* 9:1067. [taGG]
- Morrison, J. H. & Magistretti, P. J. (1983) Monoamines and peptides in cerebral cortex: Contrasting principles of cortical organization. *Trends in Neuroscience* 6:146–51. [taGG]
- Muakkassa, K. F. & Strick, P. L. (1979) Frontal lobe inputs to primate motor cortex: Evidence for four somatotopically organized premotor areas. *Brain Research* 177:176–82. [tarGG, DP]

- Murphy, J. T., Kwan, H. C., Mackay, W. A. & Wong, Y. C. (1978) Spatial organization of precentral cortex in awake primates. 3. Input-output coupling. *Journal of Neurophysiology* 41:1132–39. [taGG]
- Murray, E. A. & Coulter, J. D. (1981a) Organization of corticospinal neurons in the monkey. *Journal of Comparative Neurology* 195:339–65. [taGG]
- (1981b) Supplementary sensory area: The medial parietal cortex in the monkey. In: *Cortical sensory organization*, vol. 1: *Multiple somatic areas*, ed. C. N. Woolsey. Humana Press. [taGG]
- Nashner, L. M. & McCollum, G. (1985) The organization of human postural movements: A formal basis and experimental synthesis. *Behavioral and Brain Sciences* 8:135–72. [taGG, JPS]
- Nauta, W. J. H. (1964) Some efferent connections of the prefrontal cortex in the monkey. In: *The frontal and granular cortex in behavior*, ed. J. M. Warren & K. Akert. McGraw-Hill. [taGG]
- Nauta, W. J. H., Smith, C. P., Faull, R. L. M. & Domesick, V. B. (1978) Efferent connections and nigral afferents of the nucleus accumbens septi in the rat. *Neuroscience* 3:385–401. [rGG]
- Neafsey, E. J., Hull, C. D. & Buchwald, N. A. (1978a) Preparation for movement in the cat. 1. Unit activity in the cerebral cortex. *Electroencephalography and Clinical Neurophysiology* 44:706–13. [taGG, EJM]
- (1978b) Preparation for movement in the cat. 2. Unit activity in the basal ganglia and thalamus. *Electroencephalography and Clinical Neurophysiology* 44:714–23. [taGG, EJM]
- Neafsey, E. J. & Sievert, C. (1982) A second forelimb motor area exists in rat frontal cortex. *Brain Research* 232:151–56. [EJM]
- Neisser, U. (1976) *Cognition and reality: Principles and implications of cognitive psychology*. Freeman. [JMF, taGG]
- Orgogozo, J. M. & Larsen, B. (1979) Activation of the supplementary motor area during voluntary movement suggests it works as a supramotor area. *Science* 206:847–50. [taGG, MWi]
- Orgogozo, J. M., Larsen, B., Roland, P. E. & Lassen, N. A. (1979) Activation de l'aire motrice supplémentaire au cours des mouvements volontaire chez l'homme: Etudes par le débit sanguin cérébral focal. *Revue Neurologique* 135:705–17. [taGG, RP]
- Paillard, J. (1982a) Apraxia and the neurophysiology of motor control. *Philosophical Transactions of the Royal Society of London* B298:111–34. [taGG]
- (1982b) The contribution of peripheral and central vision to visually guided reaching. In: *Analysis of visual behaviour*, ed. D. J. Ingle, M. A. Goodale & R. J. W. Mansfield. MIT Press. [taGG]
- Pandya, D. N., Hallett, M. & Mukherjee, S. K. (1969) Intra- and interhemispheric connections of the neocortical auditory system in the rhesus monkey. *Brain Research* 14:49–65. [DP]
- Pandya, D. N. & Kuypers, H. G. J. M. (1969) Corticocortical connections in the rhesus monkey. *Brain Research* 13:13–36. [taGG]
- Pandya, D. N. & Sanides, F. (1973) Architectonic parcellation of the temporal operculum in the rhesus monkey and its projection pattern. *Zeitschrift für Anatomie und Entwicklungsgeschichte* 139:127–61. [DP]
- Papez, J. (1937) A proposed mechanism of emotion. *American Medical Association Archives of Neurology and Psychiatry* 38:725–43. [taGG]
- Penfield, W. (1954) Mechanisms of voluntary movement. *Brain* 77:1–17. [taGG]
- Penfield, W. & Jasper, H. (1954) *Epilepsy and the functional anatomy of the human brain*. Little, Brown. [taGG]
- Penfield, W. & Rasmussen T. (1950) *The cerebral cortex of man: A clinical study of localization of function*. Macmillan. [taGG]
- Penfield, W. & Welch, K. (1949) The supplementary motor area in the cerebral cortex of man. *Transactions of the American Neurological Association* 74:179–84. [taGG]
- (1951) The supplementary motor area of the cerebral cortex: A clinical and experimental study. *American Medical Association Archives of Neurology and Psychiatry* 66:289–317. [taGG, EJM, MWi]
- Penney, J. B., Jr. & Young, A. B. (1983) Speculations on the functional anatomy of basal ganglia disorders. *Annual Review of Neuroscience* 6:73–94. [tarGG]
- Petrides, M. & Pandya, D. N. (1983) Projections to frontal cortex from the posterior parietal region in the rhesus monkey. *Society for Neurosciences Abstracts* 9:40. [taGG]
- Phelps, M. E. & Mazziotta, J. C. (1985) Positron emission tomography: Human brain function and biochemistry. *Science* 228:799–809. [rGG]
- Pick, A. (1913) *Die agrammatischen Sprachstörungen*. Springer. [JWB]
- Pieper, C. F., Goldring, S., Jenny, A. B. & McMahon, J. P. (1980) Comparative study of cerebral cortical potentials associated with voluntary movements in monkey and man. *Electroencephalography and Clinical Neurophysiology* 48:266–92. [taGG]
- Podobros, L. Z. (1983) Bimanual performance of parkinson patients: Simultaneous vs. concurrent tasks. *Society for Neuroscience Abstracts* 9:654. [taGG]
- Popper, K. R., & Eccles, J. C. (1977) *The self and its brain*. Springer International. [rGG]
- Racy, A., Janotta, F. S. & Lehner, L. H. (1979) Aphasia resulting from occlusion of the left anterior cerebral artery. *Archives of Neurology* 36:221–24. [taGG]
- Raichle, M. E., Grubb, R. L., Cado, M. H., Eichling, J. O. & Ter-Pogossian, M. M. (1976) Correlation between regional cerebral blood flow and oxidative metabolism. *Archives of Neurology* 33:523–26. [taGG]
- Rasmussen, D. D., Turnbull, B. C. & Leech, C. K. (1985) Unexpected reorganization of somatosensory cortex in a raccoon with extensive forelimb loss. *Neuroscience Letters* 55:167–72. [rGG]
- Reed, E. S. (1982) An outline of a theory of action systems. *Journal of Motor Behavior* 14:98–134. [taGG, JPS]
- Requin, J., Lecas, J.-C. & Bonnet, M. (1983) Some experimental evidence for a three-step model of motor preparation. In: *Preparatory processes*, ed. S. Kornblum & J. Requin. Erlbaum. [taGG]
- Requin, J., Semjen, A. & Bonnet, M. (1984) Bernstein's purposeful brain. In: *Human motor actions: Bernstein reassessed*, ed. H. T. A. Whiting. Elsevier/North-Holland. [tarGG]
- Rizzolatti, G., Matelli, M. & Pavesi, G. (1983) Deficits in attention and movement following the removal of postarcuate (area 6) and prearcuate (area 8) cortex in macaque monkeys. *Brain* 106:655–73. [taGG]
- Rizzolatti, G., Scandolara, C., Gentilucci, M. & Camarda, R. (1981) Response properties and behavioral modulation of "mouth" neurons of the postarcuate cortex (area 6) in macaque monkeys. *Brain Research* 255:421–24. [CR]
- Rizzolatti, G., Scandolara, C., Matelli, M. & Gentilucci, M. (1981a) Afferent properties of periarculate neurons in macaque monkeys. 1. Somatosensory responses. *Behavioural Brain Research* 2:125–46. [taGG]
- (1981b) Afferent properties of periarculate neurons in macaque monkeys. 2. Visual responses. *Behavioural Brain Research* 2:147–63. [taGG]
- Robinson, D. L., Goldberg, M. E. & Stanton, G. B. (1978) Parietal association cortex in the primate: Sensory mechanisms and behavioral modulations. *Journal of Neurophysiology* 41:910–32. [taGG]
- Roland, P. E. (1981) Somatotopical tuning of postcentral gyrus during focal attention in man. *Journal of Neurophysiology* 46:744–54. [taGG]
- (1982) Cortical regulation of selective attention in man: A regional cerebral blood flow study in man. *Journal of Neurophysiology* 48:1059–78. [taGG]
- Roland, P. E. & Friberg, L. (1985) Localization of cortical areas activated by thinking. *Journal of Neurophysiology* 53:1219–43. [rGG]
- Roland, P. E., Larsen, B., Lassen, N. A. & Skinhøj, E. (1980) Supplementary motor area and other cortical areas in organization of voluntary movements in man. *Journal of Neurophysiology* 43:118–36. [tarGG, WS]
- Roland, P. E., Meyer, E., Shibasaki, T., Yamamoto, Y. L. & Thompson, C. J. (1982) Regional cerebral blood flow changes in cortex and basal ganglia during voluntary movements in normal human volunteers. *Journal of Neurophysiology* 48:467–80. [taGG, GR]
- Roland, P. E., Skinhøj, E., Lassen, N. A. & Larsen, B. (1980) Different cortical areas in man in organization of voluntary movements in extrapersonal space. *Journal of Neurophysiology* 43:137–50. [taGG]
- Rolls, E. T. (1983) The initiation of movements. *Experimental Brain Research*, supp. 7:97–113. [tarGG]
- Rolls, E. T., Thorpe, S. J. & Maddison, S. P. (1983) Responses of striatal neurons in the behaving monkey. 1. Head of the caudate nucleus. *Behavioural Brain Research* 7:179–210. [rGG, WS]
- Rolls, E. T., Thorpe, S. J., Maddison, S., Roper-Hall, A., Puerto, A. & Perret, D. (1979) Activity of neurones in the neostriatum and related structures in the alert animal. In: *The neostriatum*, ed. I. Divac & R. G. E. Oberg. Pergamon Press. [tarGG]
- Rolls, E. T., Thorpe, S. J., Perrett, D. I., Maddison, S., Caan, W., Wilson, F. & Ryan, S. (1981) Neuronal responses in the striatum of the behaving monkey: Implications for understanding striatal function and dysfunction. In: *Advances in physiological sciences*, vol. 2, *Regulatory functions of the CNS*, ed. J. Szentagothai, J. Hamori & M. Palkovits. Pergamon Press. [rGG]
- Roy, C. S. & Sherrington, C. S. (1890) On the regulation of the blood-supply of the brain. *Journal of Physiology* (London) 11:85–108. [taGG]
- Rubens, A. B. (1975) Aphasia with infarction in the territory of the anterior cerebral artery. *Cortex* 11:239–50. [taGG]
- Sakai, M. (1978) Single unit activity in a border area between the dorsal prefrontal and premotor regions in the visually conditioned motor task of monkeys. *Brain Research* 147:377–83. [taGG]
- Sanides, F. (1964) The cyto-myeloarchitecture of the human frontal lobe and



- its relation to phylogenetic differentiation of the cerebral cortex. *Journal für Hirnforschung* 6:269–82. [JWB, taGG]
- (1970) Functional architecture of motor and sensory cortices in primates in the light of a new concept of neocortex evolution. In: *The primate brain: Advances in primatology*, vol. 2, ed. C. Noback & W. Montagna. Appleton. [JWB, taGG, HHK, EJN, DP]
- (1972) Representation in the cerebral cortex and its areal lamination patterns. In: *The structure and function of nervous tissue*, vol. 5, ed. G. H. Bourne. Academic Press. [JWB, taGG]
- Sasaki, K. & Gemba, H. (1981) Cortical field potentials preceding self-paced and visually initiated hand movements in one and the same monkey and influences of cerebellar hemispherectomy upon the potentials. *Neuroscience Letters* 25:287–92. [WS]
- (1982) Development and change of cortical field potentials during learning processes of visually initiated hand movements in the monkey. *Experimental Brain Research* 48:429–37. [taGG, WS]
- (1984) Compensatory motor function of the somatosensory cortex for dysfunction of the motor cortex following cerebellar hemispherectomy in the monkey. *Experimental Brain Research* 56:532–38. [rGG]
- Scheibel, M. E. & Scheibel, A. B. (1967) Structural organization of nonspecific thalamic nuclei and their projection toward cortex. *Brain Research* 6:60–94. [taGG]
- Schell, G. R. & Strick, P. L. (1984) The origin of thalamic input to the arcuate premotor and supplementary motor areas. *Journal of Neuroscience* 4:539–60. [taGG, EJN]
- Schepelmann, F. (1979) Rhythmic patterns of motor activity after lesions of the central nervous system in man. *Acta Neurochirurgica* 49:153–89. [JWB]
- Schmitt, F. O. (1978) Introduction. In: *The mindful brain*, ed. G. M. Edelman & V. B. Mountcastle. MIT Press. [JPS]
- Schreiber, H., Lang, M., Lang, W., Kornhuber, A., Heise, B., Keidel, M., Deecke, L. & Kornhuber, H. H. (1983) Frontal hemispheric differences in the Bereitschaftspotential associated with writing and drawing. *Human Neurobiology* 2:197–202. [taGG]
- Schultz, W. (1982) Depletion of dopamine in the striatum as an experimental model of Parkinsonism: Direct effects and adaptive mechanisms. *Progress in Neurobiology* 18:121–66. [WS]
- (1984a) Primate dopamine cell activity in relation to behavioral acts. *Clinical Neuropharmacology* 7, supp. 1:90–91. [WS]
- (1984b) Recent physiological and pathophysiological aspects of Parkinsonian movement disorders (minireview). *Life Sciences* 34:2213–23. [WS]
- Schultz, W., Ruffieux, A. & Aebischer, P. (1983) The activity of pars compacta neurons of the monkey substantia nigra in relation to motor activation. *Experimental Brain Research* 51:377–87. [WS]
- Schultz, W. & Studer, A. (1984) Behavioral observations and analysis in monkey, with dopamine cell lesions induced by N-methyl-4-phenyl-1,2,3,6-tetrahydropyridine (NMPTP). *Neuroscience Letters*, supp. 18:S161. [WS]
- Schwab, R. S., Chafetz, M. E. & Walker, S. (1954) Control of two simultaneous voluntary motor acts in normals and in parkinsonism. *Archives of Neurology and Psychiatry* 75:591–98. [taGG]
- Seyffarth, H. & Denny-Brown, D. (1948) The grasp reflex and the instinctive grasp reaction. *Brain* 71:109–81. [taGG]
- Shibasaki, H., Barrett, G., Halliday, E. & Halliday, A. M. (1980) Components of the movement-related cortical potential and their scalp topography. *Electroencephalography and Clinical Neurophysiology* 49:213–26. [taGG]
- Sievert, C. F. (1985) An anatomical, electrophysiological, and behavioral comparison of the primary and supplementary motor areas of the rat. Ph.D. dissertation, Loyola University of Chicago. [EJN]
- Skinner, J. E. & Yingling, C. D. (1977) Central gating mechanisms that regulate event-related potentials and behavior: A neural model for attention. In: *Attention, voluntary contraction and event-related cerebral potentials*, ed. J. E. Desmedt. Karger. [taGG]
- Smith, A. M. (1979) The activity of neurons in the supplementary motor area during a maintained precision grip. *Brain Research* 172:315–27. [taGG]
- Smith, A. M., Bourbonnais, D. & Blanchette, G. (1981) Interaction between forced grasping and a learned precision grip after ablation of the supplementary motor area. *Brain Research* 222:395–400. [taGG]
- Smith, G. E. (1907) A new topographical survey of the human cerebral cortex being an account of the distribution of the anatomically distinct cortical areas and their relationship to the cerebral sulci. *Journal of Anatomy* 41:237–54. [taGG]
- Sokoloff, L. (1985) *Brain imaging and brain function*. Raven Press. [rGG]
- Sperry, R. (1983) *Science and moral priority: Merging mind, brain and human values*. Columbia University Press. [rGG]
- Stepián, I. (1974) The magnet reaction: A symptom of prefrontal ablation. *Acta Neurobiologica Experientia* 34:145–60. [taGG]
- Steriade, M. & Deschênes, M. (1984) The thalamus as a neuronal oscillator. *Brain Research Reviews* 8:1–63. [taGG]
- Steriade, M., Deschênes, M. & Domich, L. (1983) Abolition of spindling rhythmicity in thalamocortical cells disconnected from the reticularis thalami nucleus. *Society for Neuroscience Abstracts* 9:1213. [taGG]
- Stern, G. M., Lander, C. M. & Lees, A. J. (1980) Akinetic freezing and trick movements in Parkinson's disease. *Journal of Neural Transmission*, supp. 16:137–41. [rGG]
- Stern, Y., Mayeux, R., Rosen, J. & Ilson, J. (1983) Perceptual motor dysfunction in Parkinson's disease: A deficit in sequential and predictive voluntary movement. *Journal of Neurology, Neurosurgery and Psychiatry* 46:145–51. [taGG]
- Stuart, C. I. J. M. (1985) Physical models of biological information and adaptation. *Journal of Theoretical Biology* 113:441–54. [rGG]
- Sugar, O., Chusid, J. G. & French, J. D. (1948) A second motor area in the monkey (*Macaca mulatta*). *Journal of Neuropathology and Experimental Neurology* 7:182–84. [rGG]
- Talairach, J. & Bancaud, J. (1966) The supplementary motor area in man. (Anatomo-functional findings by stereoelectroencephalography in epilepsy.) *International Journal of Neurology* 5:330–47. [taGG]
- Talairach, J., Bancaud, J., Geier, S., Bordas-Ferrer, M., Bonis, A., Szikla, G. & Rusu, M. (1973) The cingulate gyrus and behavior. *Electroencephalography and Clinical Neurophysiology* 34:45–52. [taGG]
- Tanji, J. & Evarts, E. V. (1976) Anticipatory activity of motor cortex neurons in relation to direction of intended movement. *Journal of Neurophysiology* 39:1062–68. [JMF, taGG]
- Tanji, J. & Kurata, K. (1979) Neuronal activity in the cortical supplementary motor area related with distal and proximal forelimb movements. *Neuroscience Letters* 12:201–6. [taGG]
- (1982) Comparison of movement-related activity in two cortical motor areas of primates. *Journal of Neurophysiology* 48:633–53. [taGG, RP, WS]
- (1985) Contrasting neuronal activity in supplementary and precentral motor cortex of monkeys. 2. Responses to instructions determining motor responses to forthcoming signals of different modalities. *Journal of Neurophysiology* 53:129–41. [JT]
- Tanji, J. & Taniguchi, K. (1978) Does the supplementary motor area play a part in modifying motor cortex reflexes? *Journal of Physiology (Paris)* 74:317–19. [taGG]
- Tanji, J., Taniguchi, K. & Saga, T. (1980) Supplementary motor area: Neuronal response to motor instructions. *Journal of Neurophysiology* 43:60–68. [JMF, taGG]
- Taylor, M. J. (1978) Bereitschaftspotential during the acquisition of a skilled motor task. *Electroencephalography and Clinical Neurophysiology* 45:568–76. [taGG]
- Toates, F. (in press) *Motivation systems*. Cambridge University Press. [JAG]
- Tolhurst, D. J., Movshon, J. A. & Dean, A. F. (1983) The statistical reliability of signals in single neurons in cat and monkey visual cortex. *Vision Research* 23:775–85. [MWE]
- Tracey, D. J., Asanuma, C., Jones, E. G. & Porter, R. (1980) Thalamic relay to motor cortex: Afferent pathways from brain stem, cerebellum, and spinal cord in monkeys. *Journal of Neurophysiology* 44:532–54. [taGG]
- Travis, A. M. (1955) Neurological deficiencies following supplementary motor area lesions in *Macaca mulatta*. *Brain* 78:174–98. [taGG]
- Trevarthen, C. (1968) Two mechanisms of vision in primates. *Psychologische Forschung* 31:299–377. [taGG]
- Turvey, M. T. & Kugler, P. N. (1984) An ecological approach to perception and action. In: *Human motor actions: Bernstein reassessed*, ed. H. T. A. Whiting. North-Holland. [JPS]
- Ungerleider, L. G. & Mishkin, M. (1982) Two cortical visual systems. In: *Analysis of visual behaviour*, ed. D. J. Ingle, M. A. Goodale & R. J. W. Mansfield. MIT Press. [taGG]
- Uno, M., Ozawa, N. & Yamamoto, K. (1978) Antidromic responses of thalamic VL neurons to cortical stimulation in cats. In: *Integrative control functions of the brain*, ed. M. Ito, N. Tsukahara, K. Kubota & K. Yagi. Elsevier. [taGG]
- Van Buren, J. M. & Fedio, P. (1976) Functional representation on the medial aspects of the frontal lobes in man. *Journal of Neurosurgery* 44:275–89. [taGG]
- Vaughn, H. G., Jr., Costa, L. D. & Ritter, W. (1968) Topography of the human motor potential. *Electroencephalography and Clinical Neurophysiology* 25:1–10. [taGG]
- Vogt, B. A., Rosene, D. L. & Pandya, D. N. (1979) Thalamic and cortical afferents differentiate anterior from posterior cingulate cortex in the monkey. *Science* 204:205–7. [taGG, EJN]
- Vogt, C. & Vogt, O. (1919) Allgemeiner Ergebnisse unserer Hirnforschung 4. Die physiologische Bedeutung der architektonischen Rindenfelderung auf Grund neuer Rindenreizungen. *Journal für Psychologie und Neurologie (Leipzig)* 25:339–462. [taGG, HHK, MWi]

- Wallesch, C. W., Kornhuber, H. H., Köllner, C., Haas, H. C. & Hufnagl, J. M. (1983) Language and cognitive deficits resulting from medial and dorsolateral frontal lobe lesions. *Archiv für Psychiatrie und Nervenkrankheiten* 233:279–96. [HHK]
- Watson, R. T., Heilman, K. M., Cauthen, J. C. & King, F. A. (1973) Neglect after cinglectomy. *Neurology* 23:1003–7. [taGG]
- Watson, R. T., Miller, B. D. & Heilman, K. M. (1978) Nonsensory neglect. *Annals of Neurology* 3:505–8. [taGG]
- Watson, R. T., Valenstein, E. & Heilman, K. M. (1981) Thalamic neglect: Possible role of the medial thalamus and nucleus reticularis in behavior. *Archives of Neurology* 38:501–6. [taGG]
- Weinrich, M. & Wise, S. P. (1982) The premotor cortex of the monkey. *Journal of Neuroscience* 2:1329–45. [JMF, taGG, MWe]
- Weinrich, M., Wise, S. P. & Mauritz, K. H. (1984) A neurophysiological study of the premotor cortex in the rhesus monkey. *Brain* 107:385–414. [MWe]
- Weizsäcker, V. von (1950) *Der Gestaltkreis*. Thieme. [JMF]
- Wiesendanger, M. (1981) Organization of secondary motor areas of cerebral cortex. In: *Handbook of physiology: The nervous system*, vol. 2, *Motor control*, ed. V. B. Brooks. American Physiological Society. [taGG]
- Wiesendanger, M., Seguin, J. J. & Künzle, H. (1973) The supplementary motor area – a control system for posture? In: *Control of posture and locomotion*, ed. R. B. Stein, K. G. Pearson, R. S. Smith & J. B. Redford. Plenum Press. [taGG, HHK, EJN]
- Wiesendanger, R. & Wiesendanger, M. (1985) Afferent connections of the supplementary motor area. *Experimental Brain Research* 58:A1. [rGG]
- Woolsey, C. N., Erickson, T. C. & Gilson, W. E. (1979) Localization in somatic sensory and motor areas of human cerebral cortex as determined by direct recording of evoked potentials and electrical stimulation. *Journal of Neurosurgery* 51:476–506. [taGG]
- Woolsey, C. N., Settlage, P. H., Meyer, D. R., Sencer, W., Hamuy, T. P. & Travis, A. M. (1952) Patterns of localization in precentral and “supplementary” motor areas and their relation to the concept of a premotor area. *Research Publications of the Association for Research in Nervous and Mental Disease* 30:238–64. [taGG, DNP, MWi]
- Wyke, M. (1969) Influence of direction of the rapidity of bilateral arm movements. *Neuropsychologia* 7:189–94. [taGG]
- Wyss, R. M. & Sripanidkulchai, K. (1983) The indusium griseum and anterior hippocampal continuation in the rat. *Journal of Comparative Neurology* 219:251–72. [EJN]
- Yakovlev, P. I. (1948) Motility, behavior and the brain. *Journal of Nervous and Mental Diseases* 107:313–35. [JWB, rGG]
- (1959) Pathoarchitectonic studies of cerebral malformation. 3. Arrhinencephalies (holotelencephalies). *Journal of Neuropathology and Experimental Neurology* 18:22–55. [EJN]
- (1968) Telencephalon “impar,” “semipar” and “totopar.” (Morphogenetic, tectogenetic and architectonic definitions.) *International Journal of Neurology* 6:245–65. [EJN]
- Yamamoto, T., Hassler, R., Huber, C., Wagner, A. & Sasaki, K. (1983) Electrophysiologic studies on the pallido- and cerebellothalamic projections in squirrel monkeys (*Saimiri sciureus*). *Experimental Brain Research* 51:77–87. [taGG]
- Zaidel, D. & Sperry, R. W. (1977) Some long-term motor effects of cerebral commissurotomy in man. *Neuropsychologia* 15:193–204. [taGG]

## Cognitive Science/Bradford Books

### Artificial Intelligence

The Very Idea  
*John Haugeland*

The idea that human thinking and machine computing are "radically the same" provides the central theme for this marvelously lucid and witty book on what artificial intelligence is all about. Although presented entirely in non-technical terms it neither oversimplifies the science nor evades the fundamental philosophical issues.

\$14.95

### Visual Cognition

*edited by Steven Pinker*

These essays which first appeared as a special issue of *Cognition*, tackle some of the central issues in visual cognition. They present experimental techniques from cognitive psychology, new ways of modeling cognitive processes on computers from artificial intelligence, and new ways of studying brain organization from neuropsychology.

\$17.50 softcover

### Beyond Analytic Philosophy

Doing Justice to What We Know

*Hao Wang*

Wang's cogent critique of the tradition of modern analytic philosophy focuses on the work of its central figures—Russell, Carnap, and Quine—and finds it wanting. In its place, he unfolds his own original view of what philosophy could

and should be. "A rich and fascinating contribution to the recent history of philosophy and meta-philosophy."—Sir Peter Strawson,

Magdalen College, Oxford

\$17.50

### A Cognitive Theory of Metaphor

*Earl R. Mac Cormac*

In this book, Earl Mac Cormac presents an original and unified cognitive theory of metaphor using philosophical arguments which draw

upon evidence from psychological experiments and theories.

\$22.50

### Knowing Who

*Stephen E. Boër and William G. Lycan*

This study explores the little-understood notions of "knowing who someone is," "knowing a person's identity," and related locutions. It locates these within the context of a general theory of believing and a semantical theory

of belief- and knowledge-ascriptions. Boër and Lycan apply their analysis to each of several important issues in philosophy of language, philosophy of mind, and ethical theory.

\$22.50

### Conceptual Change in Childhood

*Susan Carey*

This case study of children's acquisition of biological knowledge between ages 4 to 10 draws on evidence from a variety of sources—from clinical interviews to experimental examination of inferential processes—to trace the emergence of biology as a separate domain of intuitive theorizing.

\$15.00

### The Acquisition of Syntactic Knowledge

*Robert Berwick*

A landmark work in computational linguistics that is of great importance both theoretically and practically because it shows that much of English grammar can be learned by a simple program.

\$27.50

28 Carleton Street  
Cambridge, MA 02142

## THE MIT PRESS