

Konrad Zuse's **Rechnender Raum**
(*Calculating Space*)

1st. re-edition¹ written in L^AT_EX by A. German and H. Zenil

As published in *A Computable Universe: Understanding & Exploring
Nature as Computation*, World Scientific, 2012



Painting by Konrad Zuse (under the pseudonym “Kuno See”).

Followed by an Afterword
by Adrian German and Hector Zenil ²

¹with kind permission by all parties involved, including MIT and Zuse’s family.

²The views expressed in the afterword do not represent the views of those organisations with which the authors are affiliated.

Calculating Space (“Rechnender Raum”)[‡]

Konrad Zuse

Contents

1	INTRODUCTION	1
2	INTRODUCTORY OBSERVATIONS	3
2.1	Concerning the Theory of Automaton Theory	3
2.2	About Computers	5
2.3	Differential Equations from the Point of View of the Automaton Theory	8
2.4	Maxwell Equations	10
2.5	An Idea about Gravitation	13
2.6	Differential Equations and Difference Equations, Digitalization	13
2.7	Automaton Theory Observations of Physical Theories	14
3	EXAMPLES OF DIGITAL TREATMENT OF FIELDS AND PARTICLES	19
3.1	The Expression “Digital Particle”	19
3.2	Two-Dimensional Systems	27
3.3	Digital Particles in Two-Dimensional Space	30
3.4	Concerning Three-Dimensional Systems	34
4	GENERAL CONSIDERATIONS	37
4.1	Cellular Automaton Theory	37
4.2	Digital Particles and Cellular Automaton Theory	39
4.3	On the Theory of Relativity	39

[‡]Schriften zur Datenverarbeitung, Vol. 1, 1969 Friedrich Vieweg & Sohn, Braunschweig, 74 pp. MIT Technical Translation Translated for Massachusetts Institute of Technology, Project MAC, by: Aztec School of Languages, Inc., Research Translation Division (164), Maynard, Massachusetts and McLean, Virginia AZT-70-164-GEMIT Massachusetts Institute of Technology, Project MAC, Cambridge, Massachusetts 02139—February 1970

4.4	Considerations of Information Theory	41
4.5	About Determination and Causality	48
4.6	On Probability	52
4.7	Representation of Intensity	53
5	CONCLUSIONS	55

DEDICATION TO DR. SCHUFF

The work which follows stands somewhat outside the presently accepted method of approach, and it was for this reason rather difficult to find a publisher ready to undertake publication of such a work. For this reason I am indebted to the Vieweg Press and especially to Dr. Schuff for undertaking publication. Dr. Schuff suggested that a summary be printed in the Journal "Elektronische Datenverarbeitung" (Electronic Data Processing), which appeared last year.

The tragic death of Dr. Schuff has deeply shaken his friends, and we will always remember him with affection.

1 INTRODUCTION

It is obvious to us today that numerical calculations can be successfully employed in order to illuminate physical relationships. Thereby we obtain a more or less close interrelationship between the mathematicians, the physicists and the information processing specialists, corresponding to Fig. 1. Mathematical systems serve for the construction of physical models, the numerical calculation of which is carried out today with electronic data processing equipment.

The function of the data processing specialists is primarily that of finding the most useful numerical solutions for the models which the mathematicians and physicists have developed. The feedback effect of data processing on the models and the physical theories itself is expressed indirectly in the preferential use of those methods for which numerical solutions are particularly easy to obtain.

The close interplay between the mathematicians and the physicists has had a particularly favorable effect on the development of models

in theoretical physics. The modern quantum theory system is very largely pure and applied mathematics. The question therefore appears justified whether data processing can have no more than an effectuating part in the interplay or whether it can also be the source of fruitful ideas which themselves influence the physical theories. The question is all the more justified since a new branch of science, automaton theory, has developed in close cooperation with data processing.

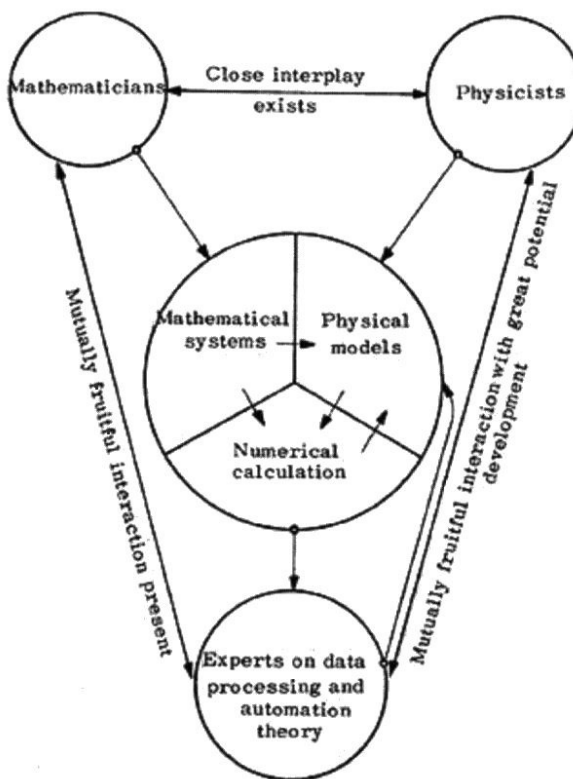

Figure 1

In the following pages, several ideas along these lines will be developed. No claim is made to completeness in the treatment of the subject.

Such a process of influence can issue from two directions:

1. The development and supplying of algorithmic methods, which can serve the physicist as new tools by which he can translate his theoretical knowledge into practical results. Among these are included first all numerical methods, which are still the primary tool in the use of electronic calculating machines. The ideas expressed in the chapters which follow could contribute particularly to the problem of numerical stability.

Among these are symbolic calculations, which command an ever growing importance today. The numerical calculation of a formula is not meant by this, but the algebraic treatment of the formulas themselves as they are expressed in symbols. Precisely in quantum mechanics, extensive formula development is necessary before the actual numerical calculation can be carried out. This very interesting field will not be covered in the material which follows.

2. A direct process of influencing, particularly by the thought patterns of automaton theory, the physical theories themselves could be postulated. This subject is without a doubt the more difficult, but also the more interesting.

Therein lies the understandable difficulty that different fields of knowledge must be brought into association with one another. Already the field of physics is splitting up into specialized areas. The mathematical methods of modern physics alone are no longer familiar to every mathematician and an understanding of them requires years of specialized study.

But even the theories and fields of knowledge related to data processing are already dividing into different special branches. Formal logic, information theory, automaton theory and the theory of formula language may be cited as examples. The idea of collecting these fields (to the extent which they are relevant) under the term "cybernetics" has not yet become widely accepted. The conception of cybernetics as a bridge between the sciences is very fruitful, entirely independent of the different definitions of the term itself.

The author has developed several basic ideas toward this end, which he considers of value to be presented for discussion. Some of these ideas in their present, still immature form may not be reconcilable with the proven concepts of theoretical physics. The goal has been reached if only discussion

occurs and provokes stimulation which one day leads to solutions, which are also acceptable to the physicists.

The method applied below is at present still heuristic in nature. The author considers the conditions not yet ripe for the formulation of a precise theoretical system. First of all, the existing mathematical and physical models will be considered in Chapter 2 from the viewpoint of the theory of automaton. Several examples of digital models are presented in Chapter 3, and the expression “digital particle” is introduced. In Chapter 4, several general thoughts and considerations based on the results of Chapters 2 and 3 will be developed, and in Chapter 5, the prospects for the possibility of further developments are considered briefly.

2 INTRODUCTORY OBSERVATIONS

2.1 Concerning the Theory of Automaton

The theory of automaton today is already a widely developed, and to an extent very abstract, theory about which considerable literature has been written. Nevertheless, the author would like to distinguish between the actual automaton theory itself and the thought patterns connected with this theory, of which considerable use will be made in the following chapters. A thorough understanding of the automaton theory is not necessary to an understanding of the chapters which follow.

The automaton theory appeared at about the same time as the development of modern data processing equipment. The design and the working method of these arrangements necessitated theoretical investigations based on different mathematical methods; for example, that of mathematical logic. The first useful result of this development was connection mathematics, in which particularly the statement calculus of mathematical logic can play an important part. Of particular importance is the realization that all information can be broken up into yes-no values (bits). The “truth values” of statement calculus assume only two ratings (true and false). The connecting operations and the rules of statement calculus can therefore be viewed as the elementary operations of information processing. Fig. 2 shows the elementary connections corresponding to the three basic operations of statement calculus, conjunction, disjunction and negation.

Further research led to introduction of the term “state” of an automaton. In addition, input data and output data play a role. From input and initial state the new state and the output are obtained, corresponding to the algorithm built into the automaton. Fig. 3 shows the schematic diagram of an

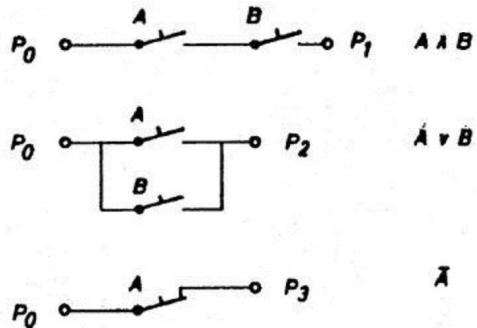

Figure 2

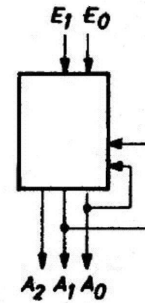

Figure 3

automaton for a two-place binary register. In the figure, E_1 and E_0 represent the inputs on which a two place binary number can be entered and A_2 , A_1 and A_0 represent the outputs, which have the meaning of a three-place binary number. The two-place binary number formed from the figures A_1 and A_0 is relayed back to the automaton and represents the eventual state of the binary number. (In this case the states symbolize a number already entered into the addition process, to which the number E_1 , E_0 is to be added).

The algorithm given by the automaton can be represented by state tables in simple cases. These have the form of a matrix, and for every state and every input combination they give the resultant state or output combination. Fig. 4 shows the state table for the automaton in Fig. 3. In this particular case the state table represents an addition table. The theory of the automaton investigates the different possible diffractions of such an automaton and sets forth a series of general rules concerning its method of operation.

$E \backslash A$	00	01	10	11
00	000	001	010	011
01	001	010	011	100
10	010	011	100	101
11	011	100	101	110

Figure 4

It is important for what follows that the terms finite, autonomous and cellular automaton be understood. A finite automaton works with a discrete number of discrete states; it is roughly equivalent to a digital data processing machine, which is made up of a limited number of elements, each element capable of taking a limited number of states (at least two), with the result that the whole automaton can accept only a limited number of states. Similar conditions hold for the inputs and outputs. The autonomous automaton can accept no inputs (the outputs are also relatively inconsequential). It can

be represented, therefore, by a machine that operates independently, once started. Its states follow linearly in sequence, once the initial combination has been started, and the operational process cannot be influenced externally by the absence of one of the inputs.

The cellular automaton represents a special form of automaton built out of interrelated, periodically-recurring cells. This type of automaton is of particular importance for the observations which follow. Later it will be discussed in greater detail.

By the term “automaton theoretical way of thinking” we understand a manner of observation according to which a technical, mathematical or physical model is viewed from the standpoint of a lapse of states, which follow one another according to predetermined rules.

2.2 About Computers

The automaton theory can be used as an abstract mathematical system, yet these thought structures can also be related to technical models, and similarly the automaton theory can be used for describing automatons, particularly those suited for information processing. In current expanded usage, the term “compute” is identical with “information processing.” By analogy, the terms “computer” and “information-processing machine” may be taken as identical.

We distinguish between two classes of computers: analog computers and digital computers. In an analog computer, the steps in the calculation are performed in an “analog” model. Magnitudes representing numerical values are theoretically represented through continual physical magnitudes, such as positions of mechanical parts (torsion angle), tension, velocities, and the like. The machine operates essentially without end. The represented values lie obviously below certain technical limits. These are established by maximum values and by the accuracy of the system. The maximum values are given by a clearly-defined upper limit which corresponds to the technical limits of the system. In contrast, the accuracy has no clearly-defined magnitude, because it depends on change and on external influences (temperature, moisture, the presence of disturbing fields, etc.) One well-known analog computer is the slide rule. Fig. 5 shows a mechanical adding mechanism the form of a lever which can be replaced with a rotating mechanism with gears, as in Fig. 6. This mechanism is known in engineering by the inappropriate term “differential mechanism” and is employed in the rear axle of every automobile.

A typical construction element of analog machines is represented by the integration mechanism shown in Fig. 7. This operates with a friction disc A

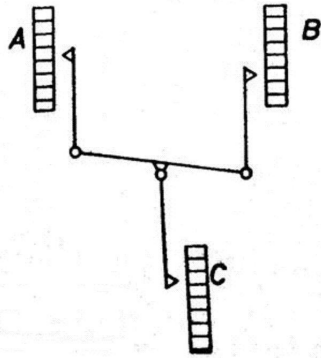

Figure 5

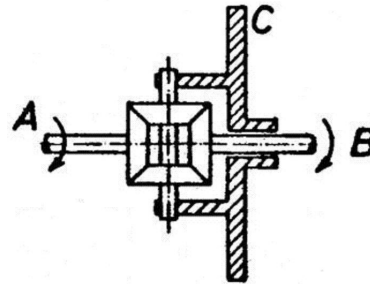

Figure 6

in contact with a friction wheel B . The distance r of the friction wheel B from the axle of A can be varied. In this way, the mechanism can be used for integration. In modern analog instruments, these mechanical elements are replaced by electronic ones. An integration can, for example, be carried out by charging a condenser.

Noncontinuous processes are generally not reproducible with analog instruments; in other words, analog computers are poorly designed for these processes.

With digital computers, all values are represented by numbers. Because a digital computer can hold only

a certain limited sum of numbers, there is available for the representation of continuous values only a limited supply of values. This implies considerable divergence from mathematical models. Mathematical values are subject to the concept of infinity in two respects.

First, the absolute magnitude of the numbers is unlimited; furthermore, between any two given values an infinite number of intermediate values may be assumed to exist. For this reason, computers have (independent of the number code employed) maximum values which, out of technical considerations (number of places of the register and storage), cannot be exceeded. In addition, the values proceed in step-fashion. There are neighboring values between which no additional intermediate values may be inserted. This

$$R d\psi = r dy$$

$$\psi = \frac{1}{R} \int r dy$$

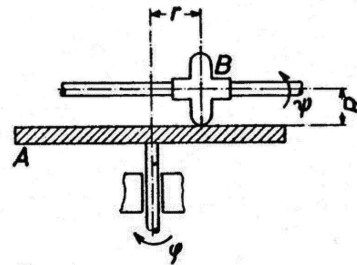

Figure 7

results in limited accuracy among other consequences. In contrast to the analog computers, the accuracy of digital computers is strictly defined and is not subject to any coincidental influences.

A further conclusion is that no digital computer can precisely reproduce the results of processes defined by arithmetic axiom. Thus, for example, the mathematical formula

$$\frac{a \cdot b}{a} = b$$

has general validity, with the one exception that a cannot be equal to 0. There is no finite automaton capable of reproducing this fact precisely and generally. It is possible, nevertheless, by increasing the number of places before and after the decimal point, for a digital computer to approach infinitely close to the laws of arithmetic.

We in the field of mathematics have already become so accustomed to the concept of infinity that we accept it without considering that every infinite term is related to a series expansion or to a limiting process ("for every number there is one which follows it"). By relating this process to automaton theory, we obtain in place of a static, predetermined, finite automaton a series of automatons which are constructed according to a definite plan and differ from one another only in the number of places. The plan for construction of an automaton with n places is given; in addition, there are instructions for converting an n -place automaton to one with $n + 1$ places. By use of the limiting process $\lim_{n \rightarrow \infty}$ with the aid of series expansion the automaton rule for arithmetic operations is obtained.

The digital computer, because of its special ability to handle not only numbers but also general information (in contrast to the analog computer), has opened up completely new fields, discussed below in greater detail. In general, all calculation problems can be solved on a digital computer, whereas analog computers are better suited to special tasks. It must be stressed that digital computers work in a strictly determinative way. Using the same algorithm (i.e., the same program) and introducing the same input values, the same results must always be obtained. The limited accuracy always results in the same degree of inaccuracy in the results when an operation is performed several times on the same inputs. This is in contrast to the analog computer, in which the limited accuracy has a different effect each time the program is run and can be expressed only in terms of statistical probability.

By way of supplementary comments, it may be observed that hybrid systems have been developed which consist of a mixture of the principles of the digital and of the analog computer.

This can be simply carried out *via* a system in which the two computers operate side-by-side. They are joined by a digital-analog converter and an analog-digital converter (Fig. 8). In systems of this type, the single parts of the problem are divided in such a way that the more appropriate device is chosen for each subdivision of the problem.

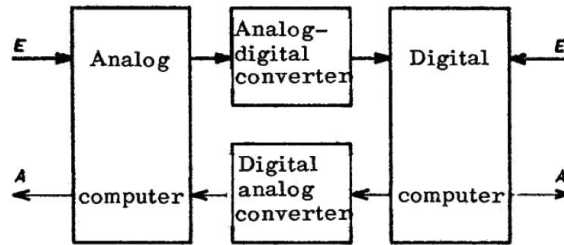

Figure 8

The joining of the two systems can also be accomplished by the representation of the values themselves. Thus, for example, a magnitude may be characterized by the pulse density (Fig. 9). Pulses themselves have a digital character, for they are normalized in intensity and duration; they are therefore digital, but their density (the number of pulses per unit time) can have any number of intermediate values, and it is therefore analog in character. A commonly-held opinion today is that the human nervous system operates on this principle.

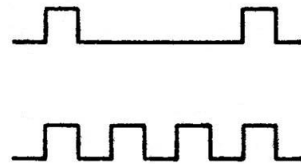

Figure 9

2.3 Differential Equations from the Point of View of the Automaton Theory

Observation of several differential equations reveals that this way of thinking is by no means self-evident to mathematicians and physicists. There are at our disposal a number of models of physical data, which can be represented by differential equations. For example, we can take a simple differential equation to represent the upper surface shape of a liquid in a rotating vessel, according to which at every point on the surface, the normal to the surface is determined by the vector sum of the gravitational and centrifugal accelerations (Fig. 10).

This equation is written:

$$y' = \frac{r\omega^2}{g}$$

where ω is the angular velocity of the container.

The solution is very easy to obtain analytically:

$$y = \frac{\omega^2}{2g} \cdot r^2$$

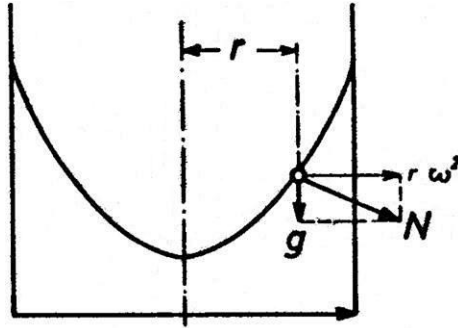

Figure 10

In reality, we have here an expression valid for the situation only after equilibrium has been established. For every equilibrium situation there is an initiating action. In the experiment with a rotating vessel initially at rest, the rotatory motion must be transferred to the liquid through frictional forces. Only after complex wave interaction, which diminishes with time, will equilibrium be established. For this reason it is not possible to describe the actual processes in this transition by means of our differential equation. The processes taking place during this period are considerably more complicated, and they are almost impossible to describe mathematically. We realize also that it is not necessary to follow each of these complicated processes when only the final state is of interest to us.

The relationships are very similar to many partial differential equations. These equations are used to describe the stress divisions of an equilibrium situation in plane and solid stress states. The establishment of equilibrium occurs in actuality *via* a highly complicated sequence of steps, in which once again the braking of these processes is the condition for the eventual establishment of equilibrium.

Differential equations describe only the final condition in the case of the theory of ideally incompressible fluids. The actual process leading to establishment of the end condition of equilibrium from a state of rest is hardly conceivable without taking compressibility and braking processes into account.

In the case of these differential equations, the issue is not one of a fundamental law, which can be described in terms of automaton theory as a functional variable of different, sequentially-occurring states. This also has an influence on the possible numerical solutions. Differential equations which describe an allowed sequence of states of a system are often easier to solve numerically than those which represent no more than a control function over the final state. In fact, solutions for such end states must usually be found in a stepwise solution, often with help of a relaxation process. It is not necessary to attach value to the step-wise approximations of the final state in order to simulate natural or technical processes; thus, it is possible to apply mathematically-simpler processes in the approximation.

A differential equation which describes an evolutionary process from the

point of view of the automaton theory may be called the “yield” form, because the following state arises from a given state through operation of the differential on the given state. In the case of liquids and gases, inclusion of the compression term leads first to this yield form. The state of a system is given by the pressure and velocity distribution. The differences in pressure result in forces leading to a new velocity distribution, which itself leads to a new density and therefore pressure distribution through the movement of the masses. The “state” of the field may be described, therefore, by a scalar density field γ and a velocity field v . The equation may be expressed in the yield form as follows:

$$k \operatorname{grad} \gamma \Rightarrow \frac{\partial v}{\partial t}$$

$$-\operatorname{div} v \Rightarrow \frac{\partial \gamma}{\partial t}$$

(k is a factor which is determined by the physical conditions). The algorithmic character is even more clearly expressed in the following form:

$$v + k(\operatorname{grad} \gamma)dt \Rightarrow v$$

$$\rho - (\operatorname{div} v)dt \Rightarrow \gamma$$

Corresponding to the normal rules of programming language (algorithmic language), the same symbols on both sides of the yield sign refer to different sequential states of the system (v, γ) .

In the case of incompressible fluids there is the condition $\operatorname{div} v = 0$.

This equation has no algorithmic character and cannot, as a result, be transformed into the yield form. It represents merely one condition for the correctness of a solution obtained by another means.

2.4 Maxwell Equations

Maxwell equations can also be studied from this point of view. We will limit ourselves to those equations describing the expansion of a field in a vacuum:

$$\operatorname{rot} H = \frac{1}{c} \frac{\partial E}{\partial t} \quad \operatorname{div} E = 0$$

$$\operatorname{rot} E = -\frac{1}{c} \frac{\partial H}{\partial t} \quad \operatorname{div} H = 0$$

Both equations, which contain the differential operator **rot** can be converted to the yield form easily:

$$E + c(\text{rot } H)dt \Rightarrow E$$

$$H - c(\text{rot } E)dt \Rightarrow H$$

(the rotor of H gives the increment of E ; the rotor of E gives the increment of H).

Both divergence equations, on the other hand, have no yield form. If the wave region of the field is taken into account we obtain:

$$\text{div } E = 4\pi\rho$$

This equation is not sufficient for the algorithmic description of the law of wave propagation. Are Maxwell equations therefore incomplete? They are used to describe the propagation of transverse, but not longitudinal, waves. The reason that Maxwell equations in their usual form are sufficient for the description of all processes occurring in electromagnetic fields rests on the fact that there exist in nature no growing, newly-appearing or disappearing waves. Only displacements of charge occur. With this sort of displacement, Maxwell equations are sufficient to describe the changes in fields associated with the displacements. The author has been unable to locate a precise mathematical proof of this in any text, but it must be assumed. An interesting comment in this regard is found in “Beckersauter” (page 186), where the field for a uniformly-moving charge is developed. This results, interestingly enough, in elliptical deformation of the previously spherically-symmetric field. This deformation corresponds to the Lorentz contraction hypothesis. It is possible to reformulate the statement that “Maxwell equations are invariable in relation to the specialized theory of relativity”: “As a result of nature’s use of the trick of lateral expansion (rotor) in an expanding field, the system of the specialized theory of relativity is logically based”.

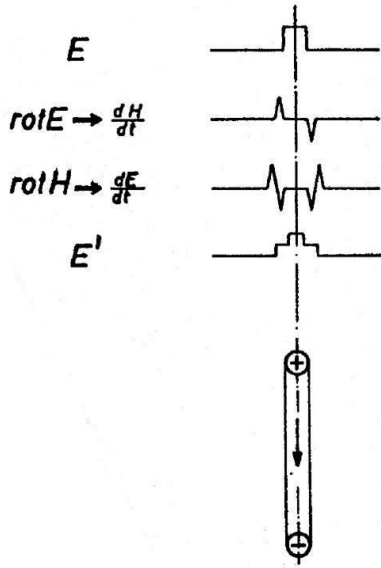

Figure 11

We can conceive of the functional nature of this lateral expansion as follows: given that we want to calculate the field between two opposite charges $+e$ and $-e$, let us assume that we do not know the field distribution in itself well-known and also easily derivable. We begin, as shown in Fig. 11, with a distribution sure to be false, by simply joining $+e$ and $-e$ by a linearly-constant force from the origin to the terminus. Application of the Maxwell equations to this field distribution results in a multistep asymptotic approximation of the field to be determined.

It is also demonstrated in this process that we obtain results without using the equation

$$-\text{div } E \Rightarrow \frac{\partial \gamma}{\partial t}$$

in the treatment of electromagnetic fields, although, as we have seen, this equation is necessary for the treatment of compressible fluids. We need not even introduce the electric field density γ . The fact that results are obtained without this term is not proof that nature works without resort to field density. Assuming that such a condition did exist, nevertheless, it would be nearly impossible to demonstrate its existence, for both “rotor” equations establish in themselves a field distribution such that

$$\text{div } E = 0$$

is generally satisfied. As a result, the divergent makes no contribution to the field distribution. Because it is impossible to create or destroy charges, we have no experimental means of testing the validity of the law of longitudinal expansion in nature.

What, then, is the rationale for examining this law? The question is interesting in connection with the concept of numerical stability, and it will be considered again below.

2.5 An Idea about Gravitation

A short consideration of gravitation is introduced in this regard. If we accept the validity of the Maxwell equations, in their transmitted sense, for gravitation as well, then a simple explanation of the expansion of gravitational fields by moving masses and the invariance of the laws of celestial mechanics based on this distribution is applied to the special relativity theory. Because the relative velocity of the heavenly bodies within our observation range lie on the order of magnitude of 1/10,000 of the speed of light, the gravitational magnetic fields were simply so weak that they were immeasurable. To be sure, small damping of planetary movements must be considered. The author would be very grateful for a critical observation of these thoughts by the physicists.

2.6 Differential Equations and Difference Equations, Digitalization

If differential equations are expressed “yield” form, according to the automaton theory, then they can be simulated by a technical model (an automaton) and solved. In itself the analog computer is the ideal automaton. It works, at least in theory, with continuous values and operates constantly; in other words, we have a continuous flow of states, the latter of which is always determined by that which precedes it. In practice, analog computers are used primarily for calculation of differential equations. Nevertheless, there is a rather narrow limit to the capabilities of the analog computer. For partial differential equations, analogous technical models are available only under special circumstances.

The solution of differential equations with a digital automaton is immediately complicated by the previously-mentioned difficulties: differential equations operate with continuous values and infinite field densities. Digital instruments operate with discontinuous values. An infinite field density would require an infinite storage capacity and infinite calculating time. Therefore it is necessary to reach compromises in both regards.

One normally proceeds from differential equations to difference equations when numerical solutions are sought. In this process, the values obtained are still regarded as continuous. In fact, the transition from differential equations to difference equations involves two boundary transitions: (1) $\Delta x \rightarrow dx$, and (2) enlargement of the number of places of the included magnitudes. The first boundary transition leads constantly to a limiting value which the second transition anticipates; in other words, constructing difference

quotients makes sense only if the gradations between values are much smaller than the chosen Δ -value. This fact has a definite influence on the numerical stability of a calculation.

If the transitions are carried out in such a way that the values remain of approximately the same order of magnitude as the step values, the staircase shape of the curve is maintained, and it is impossible to construct a differential quotient.

In the observations that follow, this distance will be utilized with design, specifically through consequential further development of the thoughts on digitalization.

Systematic narrowing of the number of places of the magnitudes being treated results in the limitation of variables to those encompassed by elementary logic; for example, yes-no values or triply-variable values. As we will discover later, triple values and the trinary number system based on these values has certain advantages, since rounding up and rounding down are easier to carry out and the division by 6 necessitated by the division of the field area into 6 neighboring cells is also easier to calculate. By attaching the values $+1$, 0 and -1 to the numbers, this corresponds to the possible electrical particles $+e$, 0 , $-e$.

The continuous field density must be separated into single values for numerical solution, a process which is easiest with a grid. The simplest grid is doubtless an orthogonal one. There are other possible choices: the triangular and hexagonal grids in two dimensions, for example, and a grid in three dimensions corresponding to the most dense packing of spheres. If several different field values arise in the calculation (for example, velocity vectors and densities), it is not necessary that these values be localized on the same grid point. There is no need for the three components of a spatial vector to be localized. In this case, a division is possible as well. There is no further necessity in the construction of a digital space structure to approximate the laws of Euclidean space. A number of general observations on the presentation of physical problems were presented earlier from the viewpoint of the automaton theory.

2.7 Automaton Theory Observations of Physical Theories

Up to this point we have considered only the problem of using computers to approximate physical models and to follow physical processes numerically. It would be possible in this context to suggest a fundamentally different question: to what extent are the realizations gained from study of calculable solutions useful when applied directly to the physical models? *Is nature*

digital, analog or hybrid? And is there essentially any justification for asking such a question?

The classical models of physics are doubtless analog in nature. The field strength of different potentials, like the force of gravity, are not subject to a “particularization”. There are no such limits as “threshold values” (minimal size), limiting values (maximum values) or limits on the density of the field itself. Even the extension of classical laws by the theory of relativity is entirely within the conception of the continuum. Only for velocity is an absolute upper limit assumed to exist (that of the speed of light), and that concept is completely in accord with “analog” thought.

It was first with the introduction of the particular nature of matter through its subdivision into molecules, atoms and elementary particles that a few quantities assumed a discrete character, but this is not necessarily to be equated with “digital” interpretation of the laws of nature. The classical many-body problem was of an analog nature, even when each of the single bodies possessed individual characteristics with discrete properties (masses).

Quantum physics is the first to deviate in several respects from the concept of infinite quantities, to the extent that it assumes only discrete values for certain physical quantities. Best known is the relationship between frequency and energy of a light quantum, which is defined by the formula $E = h \cdot \gamma$, where h is a universal constant of nature. To be sure, the energy itself is not quantized, but only the quotient $\frac{E}{\gamma}$. This is somewhat different from the case where the energy can have only a discrete number of values because of the limited number of places in the calculator of a digital computer.

The postulates of the quantum theory have far-reaching consequences in relation to the quantization of different physical quantities. The conceptions of the classical spatial continuum are being abandoned, it is true, but not through replacement of the continuum by a grid of discrete values, rather through a process whereby one moves to fundamentally different starting points, similar to a configuration room of higher dimensions, in which probability values are defined (for example, the probability of a particle being in a certain place at a certain time). Even in this concept the idea of the continuum is not rejected, for the differential equations of quantum mechanics are governed by no restrictions in relation to the magnitudes of fields.

The models of modern physics are concerned, therefore, both with continuous and discrete values. It would seem appropriate to consider a hybrid system. It will be extremely difficult to find a technical model of a hybrid computer which behaves according to the laws of quantum physics.

We have recognized the preliminary conclusion that our physical models

may best be conceived of as hybrid systems. Can conclusions with respect to nature be drawn from this? Is nature itself therefore to be considered a hybrid system?

We have not yet disposed of completely digital physical models. If we are completely impartial, it appears a justified question whether infinitely-divisible quantities (in other words, really continuous quantities) have any reality in nature. What would be the consequences, for example, if we were to shift to complete quantification of all the laws of nature and were to assume in principle that every physical magnitude is subject to some sort of quantification?

Before an examination of the real question is attempted, let us examine first the classical model of thermodynamics, through which the relationship of gases is treated by the model of rubber balls moving freely through space and colliding with each other. If the static behavior of these balls is replaced by a differential equation, it is valid only for spatial dimensions that are large in comparison to the average distance between the individual particles. In effect, the model can be viewed as analog on a large scale, yet in detail it is characterized by the particle nature of matter.

What would the calculated solution look like, if we were to imitate directly the model of flying, colliding particles?

Of course, the starting point is no longer a differential equation; the flight paths of single particles are followed with digital calculations (Figs. 12, 13 and 14).

It is quite simple for modern electronic computers to draw up a program for this purpose. We do not wish to become involved in these calculations in the course of our discussion (the calculation itself is relatively involved and boring) because a large number of particles are necessary for the results to have statistical value. The flight paths are simple to calculate, since they are rectilinear (gravity effects disregarded).

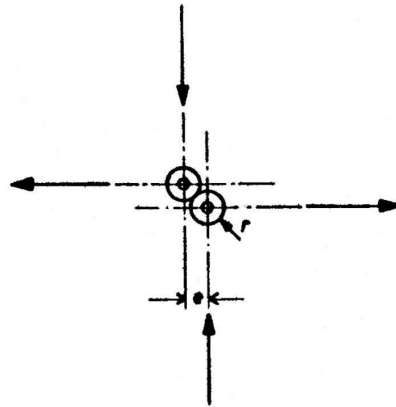

Figure 12

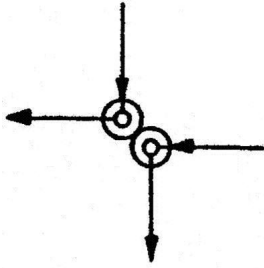

Figure 13

The collision processes are the interesting part. Equal mass and equal elasticity of the particles is assumed. We shall first consider the case in which the particles meet exactly; i.e., first, that the paths lie in one plane and mutually intersect, and second, that the centers of both particles meet simultaneously at the point of intersection. This case is uninteresting, for the case of the elastic collision is not

significantly different from that in which both particles continue undisturbed on their ways, if each particle is considered individually. Furthermore, in general situations, the probability of such a situation arising approaches 0 as the accuracy of the calculation is improved. Therefore, only those cases are of interest in which the paths do not exactly cross, or in which the centers arrive at the approximate intersection at only approximately the same time.

In this case the particles have different paths after the collision than before it. It is not necessary to stop here and establish the collision law firmly. The behavior depends on the size of the particles and the law of elasticity. Large particles collide more frequently than small ones. Hard particles behave differently than soft ones. The statistical result of the behavior of a large number of particles is the same. If we compare such a calculation model with the physical model, the following interesting aspects arise.

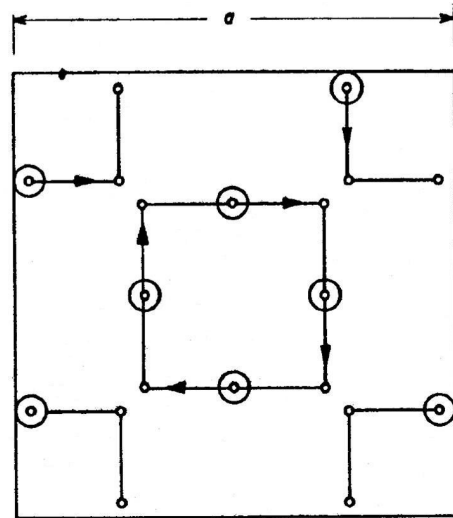

Figure 14

In the case of both models, we can see that in general ordered states give rise to disordered states, or entropy increases. In any case, we can devise certain exceptional cases, for which a given entropy remains constant. Take, for example, a vessel with exactly parallel sides and a series of particles, the paths of which are exactly perpendicular to these walls and sufficiently far apart from each other that there is no mutual interaction of the particles. In this case, the paths remain unchanged in the sense of classical mechanics. This is also the case in the computer model if the coordinate system on which the calculation is based is set parallel or orthogonal to the walls. There are certainly other interesting

special cases for which collision processes between the particles occur, yet nevertheless a certain ordering remains in force (Fig. 14).

We are now aware that modern physics has replaced this classical picture. Collision processes between single particles are not precisely determinable, according to modern physics. There exist only the laws of probability, which correspond to the laws of classical mechanics, taken as a statistical average. Scattering is due to this effect, with the result that even for the theoretically-assumed special cases, the order of the system decreases with time and the entropy increases. How is this reproduced in the computer model? As long as we do not specifically program this scattering effect into our model, the carefully-constructed special case mentioned above does not exhibit any scattering effect. However, as soon as the system, through the introduction of a small scattering input, becomes out of step with the special ordering, the situation is similar to that obtained with the models of modern mechanics. It is not generally necessary to pay particular attention to scattering effects. The error inherent in the computation—special cases excepted—have the same effect (Fig. 14). The classical model demands absolute accuracy in calculations, requiring in the computer model an instrument with an infinite number of places. Since this is not possible in practice, calculation errors enter into the collision processes, which have the effect—similar to the model of modern mechanics—that divergences from the paths predicted by the theories of classical mechanics appear. It would be possible to express these deviations by a statistical law. A significant difference does exist, however. In the model of modern mechanics the errors are real; in the computational model everything is strictly predetermined, not in the sense of classical mechanics but in the sense of defined calculating inputs, which can only approach the classical model. Both result in an increase in entropy.

The initially equivalent result (i.e., the increase in entropy) arises in both cases from the slight deviations from classical mechanics. In modern physical models, these deviations are defined by probability laws; in the case of computer models through defined calculation errors.

This may appear unimportant at first glance. Yet if we extend this thought process somewhat further, very interesting consequences in relation to causality may be drawn, which will be developed in Chapter 4.

Matrix mechanics can also be considered in the automaton theory. In any case, we need an automaton in which the transition from one state to the next is determined by probability laws. The transition matrices of matrix mechanics correspond to the state tables of the automaton. This possibility of automaton-theoretical observations will not be considered at greater length. In the next chapter, a few examples of digital treatment of

field and particle problems will be presented.

3 EXAMPLES OF DIGITAL TREATMENT OF FIELDS AND PARTICLES

3.1 The Expression “Digital Particle”

Let us first consider one-dimensional space. In this regard we can relate an example from hydromechanics and one from counter engineering. Let us consider the behavior of frictionless gases in a straight cylinder. After eliminating and collecting terms that are irrelevant for our purposes (density, etc.), we can obtain a somewhat simplified relationship of the real physical forces.

We have two quantities: p (pressure), which we fix in discrete points 1, 2 and 3, and v (velocity), which we express in intermediate points 1', 2' and 3'.

$$\begin{array}{cccccc} p & 1 & 2 & 3 & 4 & 5 \\ v & 1' & 2' & 3' & 4' & 5' \end{array}$$

Δ_p^s and Δ_v^s representing the difference in p - and v -values between neighboring points, Δ_p^t and Δ_v^t corresponding to the differences between p and v in consecutive time intervals.

The following differential equations then hold:

$$\begin{array}{l} k_0 \Delta_p^s \Rightarrow \Delta_v^t \\ k_1 \Delta_v^s \Rightarrow \Delta_p^t \end{array}$$

Expressed in words: the change in velocity is proportional to the change in pressure and the difference in pressure is proportional to the change in velocity. In the second equation, the terminus Δ_p^t is converted in order to indicate that it refers to a Δ_p after that of the first equation. The two factors k_0 and k_1 , which contain the physical characteristics Δ_x (length component) and Δ_t (time component), can be combined for our purposes into a single factor k . We then obtain:

$$\begin{array}{l} -\Delta_p^s \Rightarrow \Delta_v^t \\ -k \Delta_v^s \Rightarrow \Delta_p^t \end{array}$$

The sign \rightarrow is used to indicate that Δ_p in the second equation is not identical with that in the first equation.

It is clear that these equations can be converted from differential equations to difference equations when Δ_x and Δ_t are allowed to approach 0.

Exactly the opposite condition is of interest to us. Although mathematicians and programmers generally attempt to set up difference equations in such a way that the differential equation at the basis of the difference equation is approximated as nearly as possible, we are able to resolve the question by using the most general digitalization possible.

We are now able to convert a physical pulse law to an engineering counter law. If we let the quantities p and v and the corresponding values Δ_p and Δ_v assume only integral values, we must choose a whole number value of k in order for the difference equation to give whole number results. If we first let $k = 1$, we obtain the equations:

$$\begin{aligned} -\Delta_p^s &\Rightarrow \Delta_v^t \\ -\Delta_v^s &\Rightarrow \Delta_p^t \end{aligned}$$

We further attempt to assign p and v the smallest possible values, i.e. $-1, 0$ and $+1$, and to study the behavior of the system that satisfies these conditions. We obtain as a result the following arithmetic relation:

$$\begin{aligned} v - \Delta_p^s &\Rightarrow v \\ p - \Delta_v^s &\Rightarrow p \end{aligned}$$

Fig. 15 shows a simple calculating scheme for this rule. We have the four values $v, -\Delta v, p$ and $-\Delta p$ per unit time. The spatial sectors are opposed to one another. Zero values are not written for purposes of simplicity. Four stable elementary forms are represented [(1), (2), (3) and (4)] which we will consider as mutually-independent "digital particles". There are two time units, t_1 and t_2 , respectively, for the values $v, -\Delta v, p$ and $-\Delta p$; v and p are assumed for t_1 . It follows from this that $-\Delta v$ and $-\Delta p$ correspond to time interval t_2 and, following through the above equation, the values v and p correspond to the next time interval t_2 .

The equations relate to the traveling of a simple pulse. The particles are stable only at this velocity. At the same time, this velocity is the highest one possible for the system. The system permits no other velocities. Fig. 16 shows a graphic version of this pulse.

From the standpoint of the automaton theory, we are concerned with a linearly-expanded infinite automaton which is repeated periodically in the automaton (cellular automaton). The v - and p -values represent the states of the automaton; Δv and Δp are derived from them. The above equation establishes the function according to which the subsequent state arises from the previous one.

superposition rule applies; i.e., the single forms can be considered independently of one another, as a result of which it is natural that values greater than 1 appear. This means that two oppositely moving particles do not influence one another, but pass by or pass through one another without changing shape. In a system strictly described by the superposition rule, there are no results possible which correspond to the reactions between elementary particles known in physics. This provides our evidence that it is not necessary to build linear elements into our models. The simplest and roughest form is general limiting of the values above and below. This may be demonstrated from the examples in Fig. 20. Here we have two approaching digital particles, specifically in examples (1) and (2) on the left, corresponding to the previous reaction according to the superposition rule. We can see that in example (1), values +2 and -2 arise. In example (3), the particles pass through one another without values greater than +1 and -1 arising.



Figure 21

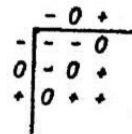

Figure 22

In this situation, an interesting result of crude digitalization may be observed. The course of the collision process differs with the phase state of the distance between the two particles. This is not outwardly visible. Fig. 20 shows example (1) with a limiting law corresponding to Fig. 21. Here there are only three values: -, 0 and +. Fig. 22 shows the relevant calculating system. It is constructed so that $1 + 1$ results in a value of 1. We can see that in spite of this limitation, the particles are free to intersect one another, a result which in itself would not be expected at first glance, for crude curtailments of the calculating rule were made. Application of the calculating rule of Fig. 22 to example (2) yields nothing new, of course, because in the example the values -2 and +2 are not to be found.

It is interesting that in spite of this, a certain reaction process in particle interaction can be noted. If we consider examples (2) and (3), for example, it can be seen that in the case of (3), in contrast to (2), a certain retardation of the process may be observed. In (2) the particles intersect and proceed away from one another unhindered. In (3) we might argue that the particles first react with one another and that two new digital particles are emitted as a result of this reaction. The question as to whether (2) or (3) occurs is again dependent on the distance phase state and is outwardly a matter

of chance. Without knowledge of the fine spatial structure, it can only be determined that in our example two fundamental situations are possible in particle interaction, for each of which the probability of occurrence is 1/2.

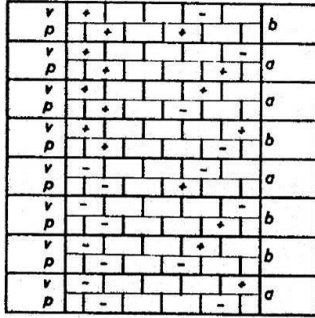

Figure 23

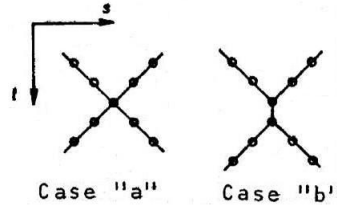

Figure 24

Fig. 23 shows a summary of the eight possible cases in particle interaction; Fig. 24 represents the schematic, idealized particle paths for the two different interaction patterns a and b. It must be explicitly stressed that the paths are idealized particle paths. In reality, our model represents not continuous movement, but a process of stepwise progress.

It is interesting to note that in the nonlinear calculating rule (Fig. 22), an isolated pressure point results in the emission of two particles (Fig. 25).

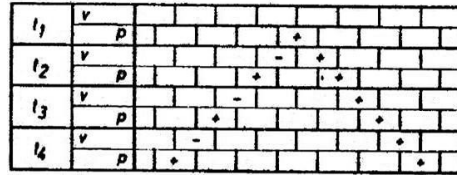

Figure 25

Establishment of limiting values obviously sets limits on the free superposition processes. In the case of unlimited values, particles corresponding to Fig. 15 are also theoretically superimposable. That means that we can construct a pressure mountain of any height with its accompanying velocity distribution which satisfies the step-wise extension rule; i.e., which remains stable. These stable "larger" particles are always divisible into elementary particles. This is no longer true when the rule corresponding to Fig. 22 is applied.

Our initial position, in which we have chosen the factor 1 relative to the Δ -value, corresponds to a very hard medium in the assigned physical pattern of a gas-filled cylinder. A more flexible situation is obtained when the factor is made smaller. In this case, nonintegral numbers arise in more accurate calculation. If we wish to continue with whole numbers or to introduce only

minimal gradations, rounding up and rounding down must be introduced. In this respect also the ternary system is superior to the binary one. The value 1/2 lies exactly midway between 0 and 1. The values 1/3 and 2/3 can also be precisely inserted between the values 0 and 1.

From there we want to make the following start:

$$v - \frac{\Delta p}{3} \Rightarrow v$$

$$p - \frac{\Delta v}{3} \Rightarrow p$$

Values $\Delta_p/3$ and $\Delta_v/3$ rounded up or down to whole numbers. Fig. 26 (1) shows a stable particle in this system with a period of $3\Delta t$. The velocity of propagation is 1/3 of that of the particle in the corresponding figure (Fig. 15). This corresponds as well to the physical model, in which a soft medium has a slower speed of sound. Here we have the situation that the "speed of switching" between neighboring particles is considerably higher (in the example three times as great) than the particle velocity.

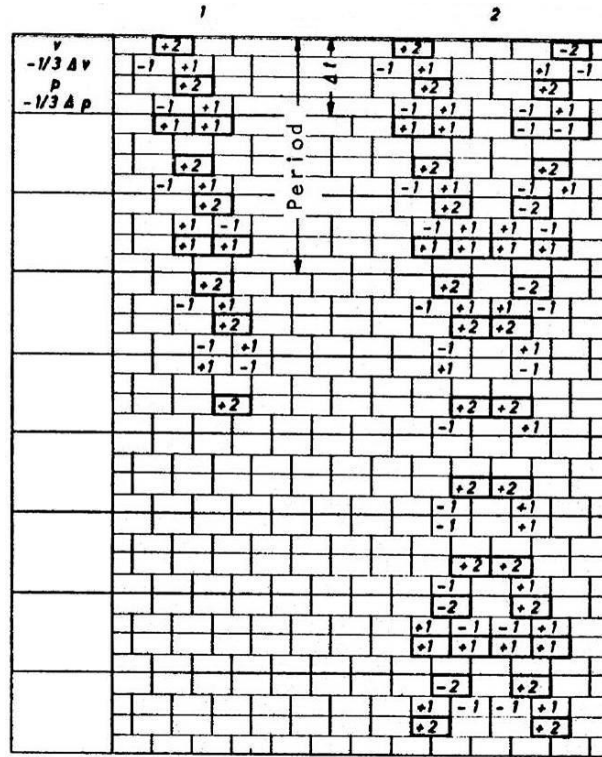

Figure 26

In more complicated models of "calculating space", it would be conceivable that speeds of light corresponding to maximum particle velocities, which are considerably slower than the speed of switching, exist. This does not mean, however, that in such a model "signal speeds" greater than the speed of light (in the model) are possible. The speed of switching has a purely local meaning.

It is interesting that a digital particle assumes different configurations in the course of a period. The pressure pulse appears in part alone with a value of +2, in part as a pair with the values +1 and +1. The position

of the particle is definable for the following period, but not without further information for the single phases of a given period. Is this not analogous to the quantum theory, which relates position and momentum through the uncertainty principle? In any case the computer model, in spite of the apparent error, is characterized by strict predetermined happenings.

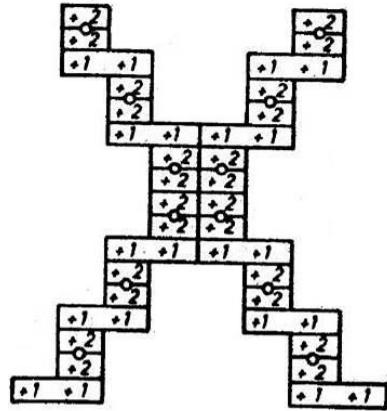

Figure 27

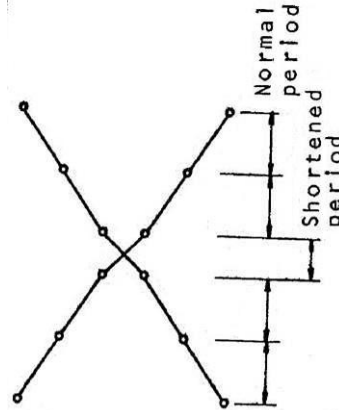

Figure 28

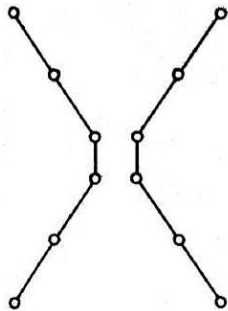

Figure 29

Figures 26, 27, 28 and 29 show the process of interaction of two such particles, and more specifically Fig. 26 (2) shows the detailed calculating scheme and Fig. 27 an excerpt from it, in which only the p -values are represented, while Fig. 28 shows the idealized particle path. The figures demonstrate that the particles do not simply pass beyond one another, but that they do react, this time with shortening of the interaction time (in contrast to Fig. 24). The process can also be represented as one of repulsion (Fig. 29).

Here it may be seen in the mode of viewing the figures that terms like “passing through” and “repulsion” lose meaning when applied to the reaction of digital particles. The quantum theory has yielded corresponding results, although not in digital form.

In particle interaction corresponding to Fig. 26, there are certainly many more differentiable cases apparent from systematic investigation, in comparison with the example from Fig. 23. We must first investigate which particles are possible in this system. The influence of the separation phases must also be taken into account, and finally the possibilities of the particles interacting

in different phases must be considered.

It is not the purpose of this paper to carry out an exhaustive examination. The previous observation of a few simple examples stimulates a whole series of interesting concepts.

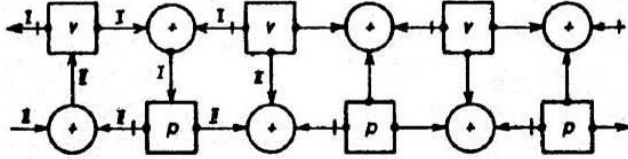

Figure 30

Fig. 30 shows the block diagram for a calculating space corresponding to the previously-introduced calculating rule. The

squares v and p represent registers to which numbers can be added. The shifting parts of the system, which serve to carry out subtraction, are represented by the circles marked with Δ . The vertical line at the exit of the Δ -members means negation. The block diagram can, of course, be subdivided into its single shifting elements. The symbols in current use reduce the shifting to its single elements, which correspond to the basic operations of Boolean algebra (conjunction, disjunction and negation). The three value information elements used here had to be converted to binary elements via two Boolean variables (2 bit). Out of 4 possible combinations of these two values, only three are employed. For this reason, a more detailed representation is omitted. In order to render the block diagram in Fig. 30 operable, clean pulsing is necessary. Therefore the pulse beats are represented in Fig. 30 by I and II. In this process it is taken for granted that the pure addition members work without time delay to build the Δ -values, while the registers transmit their information further only with the addition of the following pulse. This pulsing corresponds to the fine structure of the time dimension.

3.2 Two-Dimensional Systems

Let us examine briefly the two-dimensional system. The simplest structure is a grid corresponding to an orthogonal coordinate system. The system possesses two definite axes which enter into even simple pulse propagation. We shall start with a simple rule, where every grid point can have the states 0 and 1. In every time interval one such 1 is transmitted to every neighboring grid point. The combination of pulses arising from different neighboring points is carried out in accordance with the disjunction rule. If the state of the grid point (x, y) is $\phi_{x,y}$, we obtain the following equation:

$$\phi_{x-1,y} \vee \phi_{x+1,y} \vee \phi_{x,y-1} \vee \phi_{x,y+1} \Rightarrow \phi_{x,y}$$

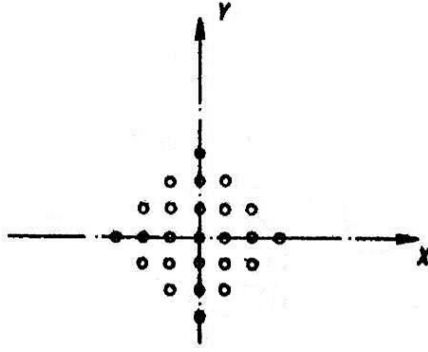

Figure 31

Expansion along the coordinate axes is faster than along the diagonals. Little can be developed with such a rule, since after a short time it leads to a state in which all spatial points reach the state "1" and thereby no configurations, particles, etc. are possible (Fig. 31).

Next we will consider a similar rule, in which nevertheless many-place values are allowed and combination occurs by addition. In the

transfer between the grid points the values are multiplied by a factor k . We obtain the formula for this rule:

$$K(\phi_{x-1,y} + \phi_{x+1,y} + \phi_{x,y-1} + \phi_{x,y+1}) \Rightarrow \phi_{x,y}$$

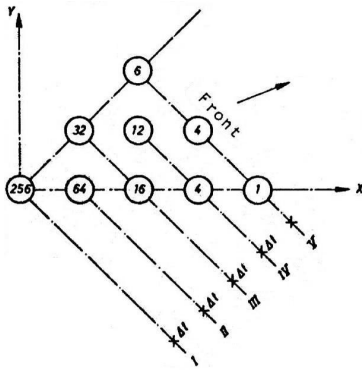

Figure 32

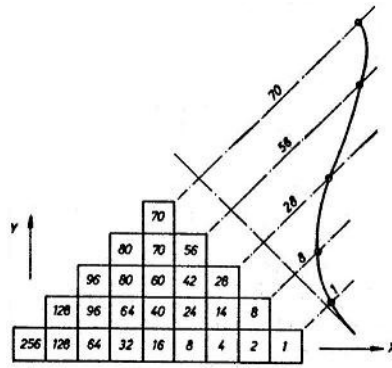

Figure 33

Two examples for the factors $1/4$ and $1/2$ are given in Figures 32 and 33. For reasons of symmetry it is necessary to consider only a 45° section. As in Fig. 32, the values are entered only for the front of the pulse. The roman numerals correspond to the individual time phases with a separation time of Δt . We can see from the examples that the front moves as represented in Fig. 31; i.e., with its peak along the coordinate axis, although the values along the diagonals are greater. The forward-rushing point very soon reaches its peak.

Because we cannot assume an infinite number of small values in digital space, the minimum value is soon reached; i.e., the peak dies out. It would be interesting to follow the progress of such an expansion with the help of a calculating machine. The question of particular interest is whether and how quickly the values converge in a circular expansion pattern.

One thing is clear: it is impossible to construct digital particles from such a rule. We must find other rules.

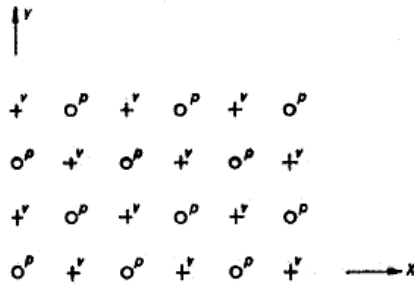

Figure 34

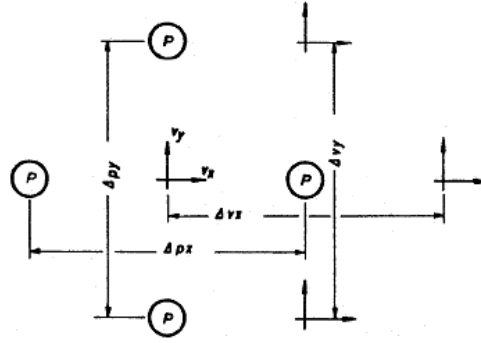

Figure 35

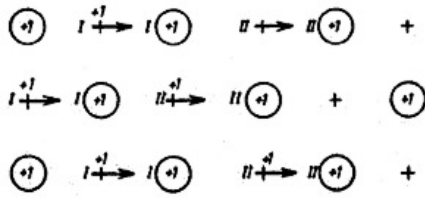

Figure 36

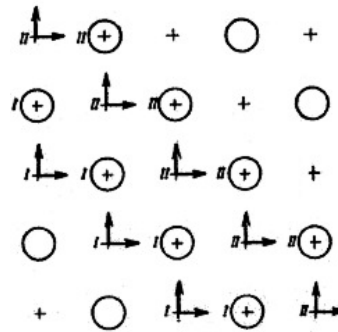

Figure 37

It is possible to take the rules for linear space, which give rise to stable particles, and apply them to two-dimensional space. Of course, we then need an interrelationship of the two dimensions, for without it the single orthogonal grid points would have an independent existence.

Fig. 34 shows one possibility of arranging the v - and p -values in a checkerboard. Fig. 35 shows the individual values which emerge. Two components, v_x and v_y , must be considered for v . One value is sufficient for p .

The two axes are coupled through p .

We can now formulate the following rule:

$$\begin{aligned} v_x - \Delta p_x &\Rightarrow v_x \\ v_y - \Delta p_y &\Rightarrow v_y \\ p - (\Delta v_x + \Delta v_y) &\Rightarrow p \end{aligned}$$

Because of the coupling through p , individual pulses corresponding to Figures 15 and 16 vanish. Stable, although not infinitely parallel, wave fronts can be built. Fig. 36 shows such a wave front parallel to one of the coordinate axes, and Fig. 37 shows a diagonally-moving wave. Fig. 38 shows a propagation relation between the two waves. The propagation velocities are functions of direction.



Figure 38

It would be interesting to consider the different consequences of more or less crude digitalization in this case. Because the rules are related to the equations of rarefied gas dynamics and hydrodynamics, it is interesting whether (for example) the hydrodynamically stable structure of a vortex can be crudely digitalized and “digital elements” can be constructed. This investigation can be carried out only with the help of calculating machines.

In order to construct stable particles in two-dimensional space, we shall first consider another manner.

3.3 Digital Particles in Two-Dimensional Space

We shall assume an orthogonal grid pattern, corresponding to Fig. 39. We no longer make the distinction between v - and p -points, but allow for each point the values p_x, p_y . For reasons of simplicity we first assume that the p -values can take on the values $-, 0, +$. We can then speak of p -arrows or of short arrows. First we establish that an isolated arrow (an arrow which has no perpendicular arrow arising at the same grid point) is directly transmitted to the next grid point. Fig. 40 shows the four possible examples of this sort of single isolated pulse. It can be transmitted forward only in an orthogonal direction. We can first determine that there are two cases of interaction between two arrows approaching in the same orthogonal.

Both of these are shown in Fig. 41. In one case, the arrows continue away from one another; in the other they cancel one another. Which case occurs depends on the separation phase. We still need a rule for the case of intersecting arrows. This is demonstrated in Fig. 42. Two intersecting arrows exist at point Z at time I . According to our previous rules, they

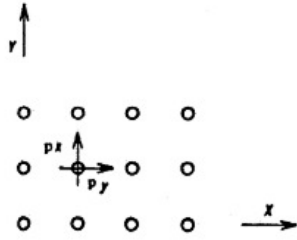

Figure 39

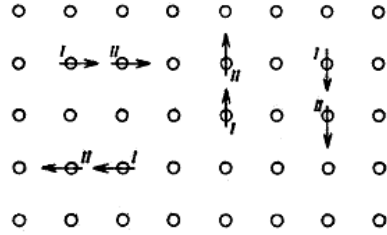

Figure 40

would be propagated forward, each in its own direction, independent of the other. Now we establish that the two arrows are in fact propagated forward in their respective directions toward points *B* and *C*, and at points *B* and *C* they exchange direction. We obtain in this way a stable particle of period $2\Delta t$, which is propagated diagonally forward (Fig. 43).

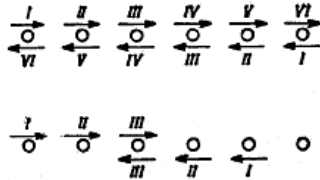

Figure 41

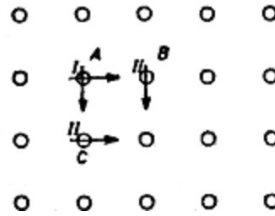

Figure 42

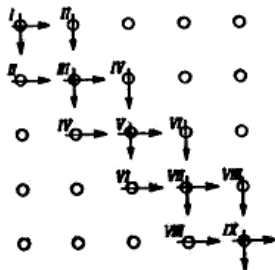

Figure 43

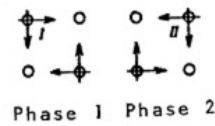

Figure 44



Figure 45

It is interesting to note that pockets arise from this rule which are fixed to 4 neighboring grid points; they have a period $2\Delta t$ (Fig. 44). A doubly-stable pocket with period Δt is also possible (Fig. 45). As may be seen from

additional examples, these pockets cannot be destroyed.

We now have particles which can be propagated in eight discrete directions in a plane and standing pockets as well. Figures 46-57 give a series of interesting examples for the interaction of such particles. At first we shall maintain the condition that arrows may have only the values $-$, 0 , $+$. Two oppositely-directed arrows cancel one another at the same grid point, and two with the same orientation act as a single isolated arrow.

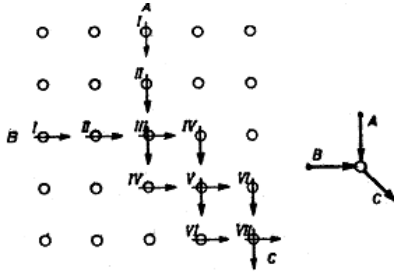

Figure 46

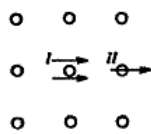

Figure 47

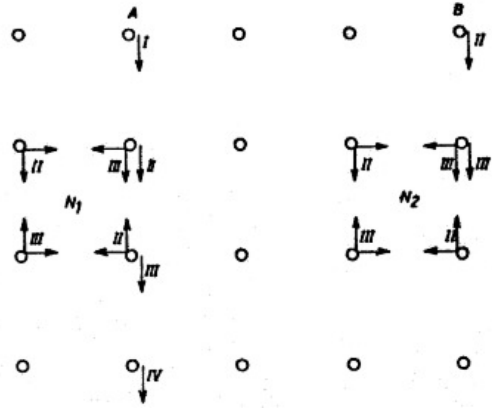

Figure 48

It may be seen that the course of the different interactions is dependent on both time and separation phases. The particles can cross through one another, cancel one another or build new particles. Pockets are insidious because they can destroy particles without disappearing themselves. On the other hand, pockets can arise from specific forms of interaction (Figs. 55 and 57). In the model of a cosmos which functions according to this rule, all particles would eventually be converted into hard pockets. This model is therefore of little use.

In the interaction it is highly significant whether the point of intersection of the particle paths lies on a discrete defined point in the coordinate system. In this case a reaction occurs (for example, Figs. 52 and 53).

The possibilities of this system can be investigated by permitting the introduction of arrows of different absolute length. For arrows pointing in the same direction we use the addition rule. It is more difficult to expand the rule of Fig. 42 to include two intersecting arrows of different lengths. We can reach the following agreement.

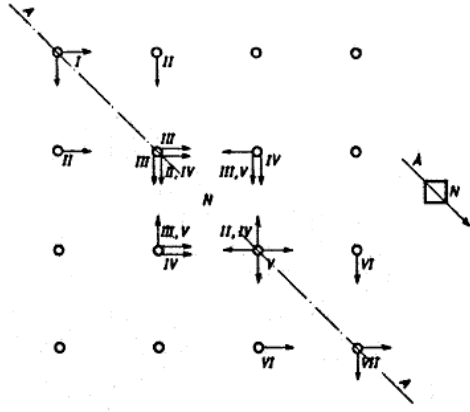

Figure 49

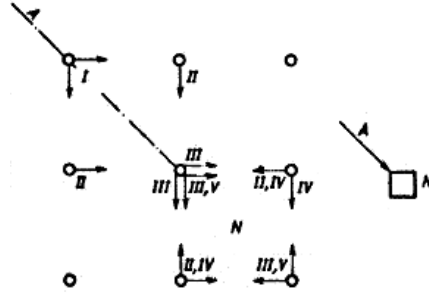

Figure 50

In the case of mutually-orthogonal arrows, the longer arrow is divided into two parts; the contribution of one is equivalent to that of the arrow orthogonal to it and combines with the first as in Fig. 42. The remainder acts as an isolated arrow (Fig. 58).

We are now able to construct particles having different directions of propagation. The number of different directions possible is dependent on the number of values possible for the contribution of the arrow.

Fig. 59 shows an example with a ratio of the arrows of 5 : 2. The direction of movement corresponds to the ratio of the arrows. The particles pass through different phases. The particle in Fig. 59 has a period of $7\Delta t$. In the course of one period the particles pass through a discrete coordinate point Q (zero phase point). The particles “disappear” at intervals. It is possible to construct lines of the same phase (phase lines $\tau_0 - \tau_6$).

Fig. 60 represents an example of the limitation of the possible discrete directions of motion. It must be stressed that there exists an interdependence between the velocity of propagation and direction. The chosen propagation rule permits no difference in velocity of the particles moving in the same direction.

Figures 61-66 show another series of interesting cases of interaction between such particles. Again the process of interaction is phase-dependent. A reaction between two particles always occurs, when they are respectively at the zero point at intersection (for example, Figs. 61 and 62). But they can also react under other circumstances, as the examples in Figures 65 and 66 show. In these cases, the already-mentioned phase lines play a part. We

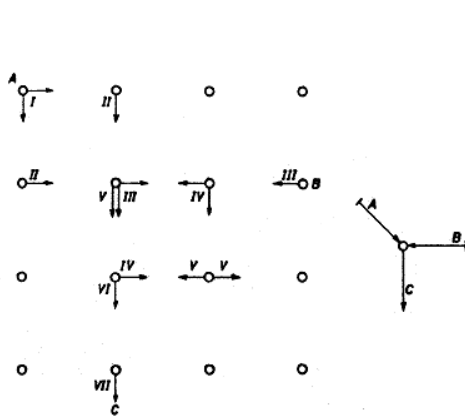

Figure 51

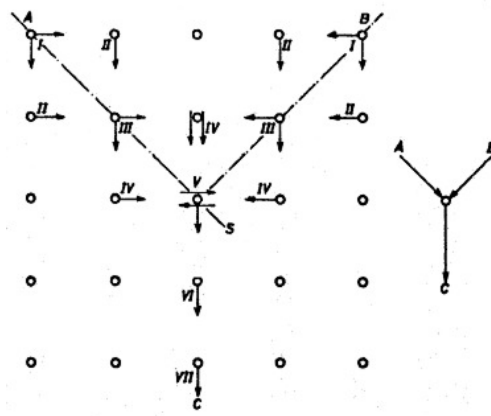

Figure 52

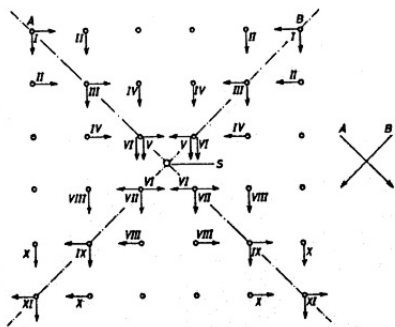

Figure 53

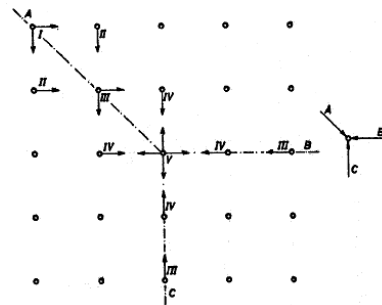

Figure 54

could construct a time phase line R , which represents both particles. If this passes through the point of intersection of the particle paths S , a reaction is possible (Figs. 65 and 66).

Of course, these examples are very simple and primitive. But even these simple forms yield an abundance of suggestions; they show that the basic method of digitalization adopted is of greatest interest and that development of the rules will yield additional concepts.

3.4 Concerning Three-Dimensional Systems

The concepts developed in Sections 3.2 and 3.3 can also be applied to three-dimensional systems. The studies of the author are not yet complete in this area and should be reserved for further investigation.

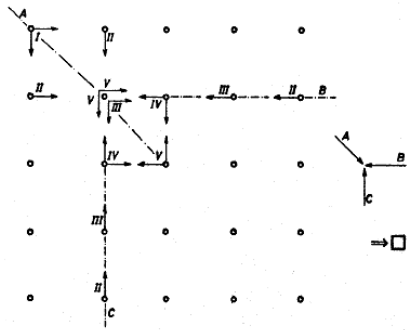

Figure 55

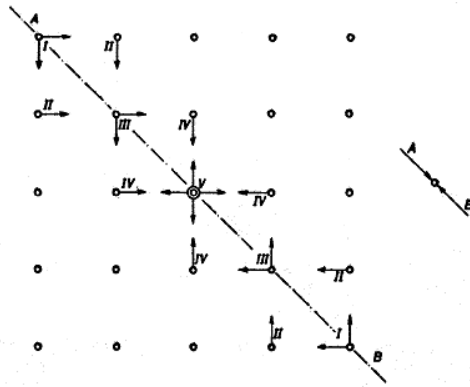

Figure 56

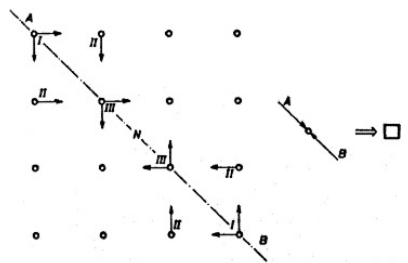

Figure 57

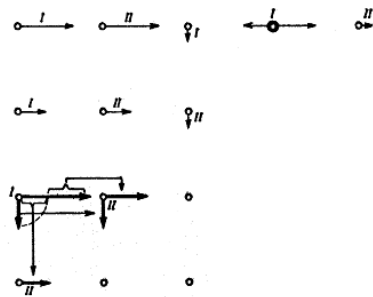

Figure 58

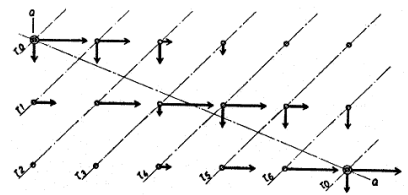

Figure 59

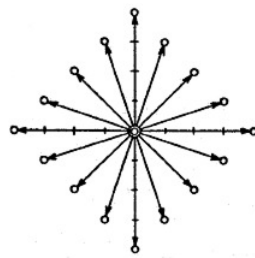

Figure 60

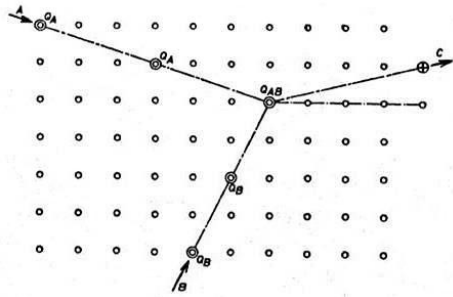

Figure 61

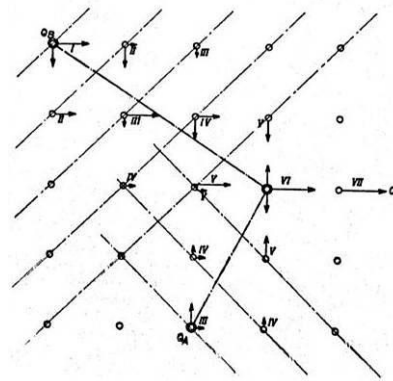

Figure 62

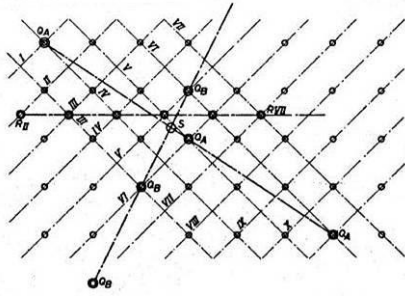

Figure 63

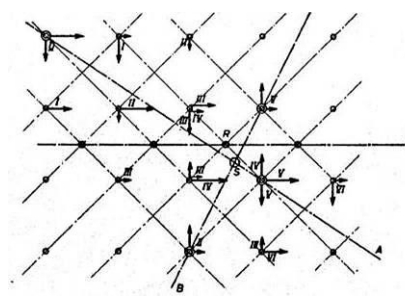

Figure 64

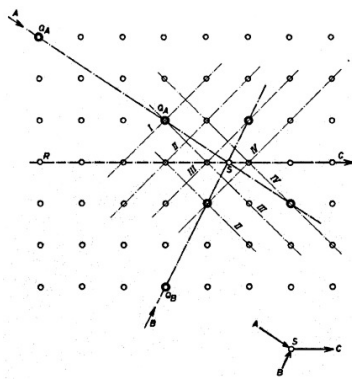

Figure 65

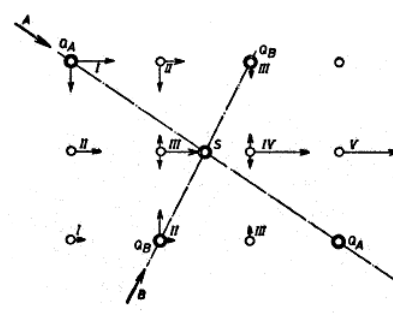

Figure 66

4 GENERAL CONSIDERATIONS

4.1 Cellular Automatons

The examples of digitalization of fields and particles which have been presented are in their present unfinished form still far removed from being able to serve in the formulation of physical rules. Nevertheless, they give a rough impression of the possibilities for using the tools of the automaton theory to answer physical questions.

The examples have dealt primarily with point grids. A single cellular automaton consists, therefore, of a point grid which is bound to neighboring points through information exchange. In the cases shown in Figures 34 and 35, the grids are checkerboards of two different values, p and v , in grid form. There exist different possibilities for their combination, so that division into single automatons is not specific. This does not affect the behavior of the entire system.

In general, division of the continuum into discrete cellular automatons has different consequences, depending on the precise division. The idea of a grid spatial structure is already treated in various contexts by physicists, although not in regard to automaton theory. Generally speaking, the idea that the cosmos could really be subdivided into such cells is sharply repudiated by physicists. We agree that space cannot be viewed as a continuum even in infinitely small sections. The concept of a smallest length is already widely accepted today, while not in relation to the idea of subdivision into a point grid, but more as the principal limit in the differentiation of two different particles. The doubts relating to a grid structure are essentially as follows:

- (a) A grid structure would abolish the isotropy of space.

It is clear that a regular grid pattern establishes preferred directions. This has an effect, for example, in the expansion of fields (Figs. 31, 38) and in the discrete possible directions in which a digital particle can move (Fig. 60). We know of no physical experiments which would provide a key to preferred directions of this type, but the field has not been systematically studied for this effect. Sober reflection reveals, nevertheless, that it is worthwhile to consider rules for a grid like spatial structure which do not allow the grid structure to become visible in regions of smaller and intermediate energy and frequencies. The grid constant must be assumed to be considerably smaller than the elementary shortest length of approximately 10^{-13} cm (Bopp assumes even 10^{-56} cm). The field of normal optics, for example, works with wavelengths of extraordinary length in comparison with these lengths. It is hardly possible to think of an experiment which could

determine the eventual discrete propagation direction of photons, when we assume the accuracy of such a change in direction (in circular measure) to be of the same order of magnitude that we are capable of differentiating between frequencies, namely 10^{-12} (Mössbauer effect).

Results of this sort can first be expected in the very high energy ranges, when wavelength and length of the period approach the grid constant. Only today do we have the capability to carry out such experiments. The author must leave it to the decision of the physicists whether and within which limits these phenomena could be observed with the aid of present experimental techniques.

(b) Curved volumes, as they are assumed from the general theory of relativity, are hard to represent with the grid structure of space. Bopp has chosen the expedient of assuming a Cartesian space in which the three spatial coordinates each converge on themselves. This can be imagined in two-dimensional space by assuming a toroid.

There are, of course, many possible deviations from these consequences. The whole subject is still too young for one to be able to draw final positive or negative conclusions. The following possibilities can be mentioned:

(α) The assumption of fixed circuits in the form of cellular automata is not the only logical possibility for defining logical connections between discrete values in space. If we introduce the change in the circuits as a function of the results of the previous process, variable circuits can be regularly developed.

(β) The concept of the growing automaton is closely related to the regular variability of circuits.

Both possibilities require at first a very well-prepared theory. Since automaton theory is a young field, the possibilities of which are in no respect exhausted, we can expect further developments in the direction being considered.

(γ) The assumption of a grid implicitly assumes that of an inertial system, which is contradictory to a strict interpretation of the theory of relativity. This will be considered at greater length.

In this light, the use of an orthogonal network is the most convenient way of beginning investigations. The results obtained in this manner will certainly be just as valid when in the course of time automaton theory yields new methods for use.

4.2 Digital Particles and Cellular Automaton

Digital particles may be considered as disturbances in the normal conditions of a cellular automaton. This disturbance has a distinct pattern which is subject to periodic changes. According to automaton theory, every state evolves from the preceding one; nevertheless, the entire pattern can fluctuate in the process. To a certain extent we are concerned with “flowing states”. In accordance with this, digital particles can be regarded as “self reproducing systems”. A given pattern is generated in a neighboring region of the cellular automaton.

In the examples in Chapter 3, digital fields and digital particles are treated separately. Modern field theory takes pains to explain even elementary particles through singularities and special forms of fields. Automaton theory is understandably well-suited to digitalize such interpretations and to subject them to the rules of automaton theory. The author hopes to be able to treat this subject in greater depth in another contribution.

4.3 On the Theory of Relativity

The question of the isotropy of space obviously requires coming to grips with the theory of relativity. The Lorentz transformations so important to the special theory of relativity, can obviously be infinitely approximated by numerical estimates. Nevertheless, it is very difficult to simulate in digital form the consistent form of the model of the theory of relativity. Our physical experience tells us immediately that no excellent coordinate system can be proven to exist, and that we are justified in considering each coordinate system to be as valid as the next one, in which case the Lorentz transformations formulate the relationships between these inertial systems. The strict interpretation of the special theory of relativity leads, however, to the conclusion that in reality no superior coordinate system exists, and that it is useless to search for such a system experimentally. In any representation of the cosmos as cellular automaton, it is almost impossible to avoid the assumption of a superior system of movement. We can construct the structure of cellular automaton in such a way that a greater number, although still a finite quantity, of superior coordinate systems are available. The constance of the speed of light in all inertial systems is represented by the digital simulation of the Lorentz transformations and the related shortening of bodies.

In any case, a relation between the speed of light and the speed of transmission between the individual cells of the cellular automaton must result from such a model. These do not need to be identical. In contrast, it may

be assumed that the speed of transmission from cell to cell must be greater than the speed of propagation of the signal obtained from this transmission. This greater speed of transmission has only a local meaning. Because of the anisotropy of the calculating space it is different in different directions, In any case the “digital” model, in comparison with the analog model of the relativity theory, yields a significant difference: the closer the velocity of the inertial system approaches the standard of the speed of light, the more critical the digital simulation of the processes becomes. In the case of energy-rich particles, we come to processes which can be characterized (at least to some extent) as a “miscalculation” of calculating space. In this way the essentially different behavior of particles of very high energy (high velocity, high frequency) can be explained.

A strict interpretation of the special theory of relativity has as a consequence that for every inertial system another one can be imagined, which moves with an initial velocity less than c . The physical rules are just as valid in the second system as in the first. This process can be repeated as often as desired, at least in principle. The complete monstrosity of this thought is only vaguely clear. Here it must be said again that every conception of infinity presupposes a limiting process. Here we are concerned with an infinitely frequent repetition of reaction of another inertial system which moves relative to the previous one. This process has a few consequences if observations of an information theoretical nature are applied, as we will consider in the following.

The following statement is also of interest.

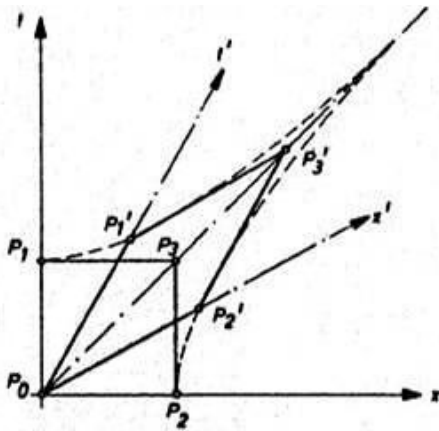

Figure 67

P_2, P_3 is equal to the shifting volume of a period. If this particle moves relative to the system x, t we can we can speak of a second inertial sys-

We shall first introduce the term “shifting volume”. This is equal to the number of shifting parts involved multiplied by the number of shifting beats which take part in a given process, for example the period of a digital particle. Fig. 67 shows a simplified representation, in which it may be assumed that a disturbance representing the digital particle extends for a distance $P_0 - P_1$. The particle is assumed to be stationary in the inertial system x, t . In this case, the space $P_0, P_1,$

tem x' , t , according to the special theory of relativity, relative to which the moving particle is stationary. The inversion corresponding to the Lorentz transformations yields the shifting volume P_0, P'_1, P'_2, P'_3 .

This is equal in area to the shifting volume P_0, P_1, P_2, P_3 . We can speak therefore, of invariance of the shifting volume.

4.4 Considerations of Information Theory

The term information gains considerable meaning in the process of these different considerations. Information theory has formulated the term “information content” with clarity in regard to news-transmitting systems. For this reason, we are inclined to consider information theory as the theory of information processing. This is not correct, however. The easily accomplished application of terms from information theory in the neighboring field of news transmission unfortunately leads to frequent confusion. Even in the present observations we must be clear of our understanding of information content. It is difficult to speak of physical processes in terms of news transmission. This would be of interest in itself only insofar as we could include people in our consideration. If we assume an infinitely fine propagation of our news, transmitted through electromagnetic waves, it must be infinitely conserved, as long as limits are not established for them by the temporal finiteness of the universe. Metaphorically we can also consider the rays in the universe approaching us from other stars as news for people, in which case the question of the information content of this news makes sense.

Such a relationship between man and nature is to be found in the modern statement of the quantum theory, which attempts to relate all measurable quantities in a mathematical system. The information which we obtain from nature about the structure of atomic shells consists largely of the frequencies of the emitted light quanta. In this case, the use of the term “information content” is meaningful. The matter will not be further investigated here.

If we disregard this definition of information as the means of news transmission, it is still not possible to speak of information content of inhabited systems, if we consider the width of variation of the possible shapes of an object, a pattern or the like. Thus, a punch card may contain, due to its variability, a definite information content, measured in bits.

The technical characteristics of the punch card itself, including the accompanying punching and readout systems, set upper limits to the amount of information which can be entered, which is defined as information capacity. In news transmission this capacity does not need to be completely used, so that the information transmitted from sender to receiver on the punch

card can be below capacity.

It is also possible to speak of a maximum possible information capacity of a finite automaton, if we consider the number of its possible states as a measure. If this is equal to n , the information content is $\log_2(n)$ (logarithm to the base two). A programmed calculating machine represents this type of automaton, as we are aware. If such an instrument has m members, for each of which there are two possible positions (for example, flip-flops, ferrite nuclear rings in the storage, etc.), then the number of possible states is 2^m and the information capacity is equal to m . In this process no distinctions are made between the individual possible states. In the total of 2^m possible states every state is counted in which every register and storage unit is dissolved (i.e., set at zero) as are the states, as a result of which the solution of a very complicated differential equation is held in storage. Emotionally, we naturally tend to assume that the equipment contains no information in its zero state, although in the second state mentioned extremely interesting scientific results are available for use by mathematicians. This example shows the necessity for great caution in the definition of terms in information theory. The difference in this situation is that for the receiver, the two states have a fundamentally different meaning. The state of "everything dissolved" is only an extension of the receiver's knowledge that the machine is in the ground state at the moment, while in the second case, the receiver's knowledge is increased with regard to significant results.

If no account is taken of these individual values of information for the receiver, then the conclusion may be drawn that the information content of a finite automaton cannot be increased while running a calculation. Because the calculation is made completely automatically after introduction of the program and the input values, the results are established from the beginning. The results have greater value for the person using the equipment: for why would he let the computer perform a calculation if not to increase his knowledge, which is only possible if the final state of the automaton has a greater information content than the starting state.

The first result of viewing the cosmos as a cellular automaton is that the single cells represent a finite automaton. The question to what extent it is possible to consider the entire universe as a finite automaton depends on the assumption which we make in relation to its dimensions. If we take the toroid of higher order, as already suggested by Bopp, we are dealing with a finite automaton on the whole. It is originally valid that the individual cells can accept a limited number of states and have therefore only a limited information content. This is equally true for the entire cosmos, if we make suitable assumptions about its limits.

Automaton theory demonstrates that different characteristic running patterns are possible for a finite automaton, several of which will be considered.

For every given state there is a succeeding state. It is therefore possible to express the relation "state A dissolves state B" as relation $F(A, B)$ and to represent it in the form of an arrow diagram. Such an arrow diagram is often called a "graph". Figures 68a-d show different types of arrow diagrams. It is important to remember that every state can have only one succeeding state, although there are several preceding states which can dissolve it. The process figures show that an autonomous automaton must end in a periodic cycle in every case, which under certain conditions can also degenerate into a single final state.

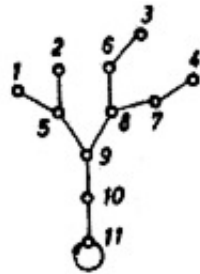

Fig. 68a.

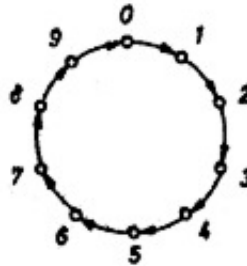

Fig. 68b.

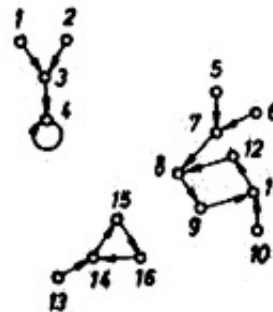
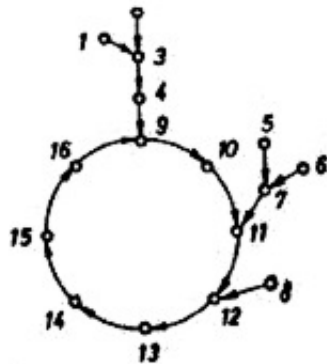

Figure 68

This knowledge cannot be transferred to the individual cells of a cellular automaton, for they are related to neighboring cells through information exchange and therefore do not result in an autonomous finite automaton. In the assumptions of limits on the cosmos in the universe, we are con-

cerned with a finite autonomous automaton as soon as we exclude any sort of influences of a greater external world. The first result is the somewhat disillusioning consequence that the cosmic process must of necessity end in a periodic cycle. This realization, in itself logically unassailable, has other implications when examined quantitatively.

The dimensions of the universe are assumed to be on the order of magnitude of 10^{41} elementary lengths (10^{-13} cm) by some physicists (approximately 10 million light years). We are concerned therefore with a volume of approximately 10^{123} elementary cubes of the elementary length on a side. If an individual bit of information content is assigned to each of these elementary cubes, then we have already $2^{10^{123}}$ different states of the universe to consider. This number represents only a lower limit. In reality, a much finer grid must be assumed, for which it is not yet known how many variations at each grid point are possible. It must further be considered that space calculates extremely exactly. The relation of electrostatic interactions to those from gravitational fields is about $10^{40} : 1$. The interaction of nuclear forces are again orders of magnitude stronger. The higher of the two values represents in reality only a lower limit, which is most likely many orders of magnitude too small.

If we assume the number of time pulses to approach the order of magnitude of the spatial expansion, in effect 10^{41} , the result is obtained that in spite of this long time only a vanishingly small portion of the possible states of the cosmos can exist. There are $2^{10^{82}}$ types of reaction ways possible, each of which is independent of any other. This also means that the number of deflections and branchings is incomprehensibly great. The previously considered observations of automaton theory relating to Fig. 68 lose all predictive value. Of what value is the realization that the evolution of the universe follows a periodic cycle, when even within the already very large range of time being considered one single period at most can pass, and most likely not even that?

The consideration of closed processes, i.e. of shifting processes involving a digital particle, appears more fruitful. We have already observed that a digital particle consists of a series of periodically-repeating patterns in a cellular automaton and that they are not fixed in position, but can move in the space of the single cells like the moving writing machine. The term "flowing state" was already introduced.

The question of the information content of a digital particle can be considered from several points of view. At first the digital particle accepts a set position in space at a particular point in time. The information content of the digital particle cannot be greater than the information capacity of this

position in space, which is determined by the sum of the possible states of this region. It is highly unlikely that every variation in state of such a limited region corresponds to a digital particle. It is much more likely that a limited selection dissolves individual stable period patterns.

We can inquire, entirely independent of the space associated with a digital particle, how many pattern variations representing phases of a digital particle are in fact possible? It is advantageous to classify the patterns along different lines:

- (1) type;
- (2) direction and velocity (pulse);
- (3) phase state;
- (4) position of the particle.

An answer to Question 1 assumes that we have at our disposal a model which permits different types of digital particles, as we have in nature with photons and electrons, etc.

An answer to Question 2 requires that our model accept different velocities and directions of propagation of the periodic pattern.

The phase sequence results from the periodic pattern sequence associated with the special type of particle and pulse.

Question 4 has meaning only when the interrelationship of the particles is considered. It is, of course, impossible for a closed region of space to hold the information about its own state.

The examples of Figures 42-66 from Chapter 3 satisfy these conditions only to a limited extent. First, the model permits representation of only one type of particle. Further only the direction may be varied, but not the velocity. The length of the periods of the individual particles is not constant, but this is not of interest to our consideration. The information content of this type of particle depends on the accuracy of representation of the arrow length or on the number of places with which it is digitally represented. If we assume absolute lengths of a component for Example 4, then we obtain 9 different arrow lengths, including the zero value, for that component; in two-dimensional space there are 81 different pulse variations. On the basis of these possible variations in the particles, even within the given limits it is possible to determine the information content of a particle. Each of these particles has a series of associated phase states, so that the number of possible patterns of digital particles is still greater. The particle in Fig. 59 has, for example, 7 different phase states ($\tau_0 - \tau_6$).

The question of information retention in the reaction between digital particles is an interesting one. In the examples given in Chapter 3, pulse arrows are added in the course of reaction. This means that the number of

places in the pulse arrow of the new resultant particle must be greater than the number of places in the reacting particle. If we eliminate arrow length of 0 for purposes of simplicity and assume that the arrow of the reacting particle can be represented by binary places, then the arrow of the resultant particle must be represented by 4 binary places. Before the reaction we have 2 particles, each of which has an information content of 2×3 bits (a total of 12 bits). After the reaction we have a particle with an information capacity of only $2 \times 4 = 8$ bits. During the reaction we have lost 4 bits of information. In this process we have permitted the arrow of the resultant particle to be represented by a greater number of places. This already means in itself the admission of a new type of particle. If this is not permitted, a rule must be found which takes effect whenever the permitted number of places are exceeded in the process of addition. If we simply assume that the maximum value may not be exceeded, then successive reactions lead after a certain period of time to the result that we are left with particles with the absolute maximum pulse arrows.

The examples chosen here for digital particles are still much too simple to be strictly related to physical processes. Actually, we are never confronted in nature with the situation that particles of the same type react with one another, not to mention the result that two such particles react to give a particle of a higher type. Conservation of energy, of pulse, of spin charge and so forth holds for elementary particles in physics. It is only when models of digital particles are at our disposal, with the help of which terms can be represented, that comparative observations with elementary particles in physics and their reactions are possible.

It is a question of obvious interest whether conservation of the different magnitudes cited in correspondingly-constructed digital particles is related to a corresponding conservation of information. The problem becomes even more complicated when fields are also considered. The author can only state the question without offering an answer to it. Perhaps the question is not so terribly important. Somehow the question amounts to the problem of "configuration", which is known to be very difficult to handle mathematically.

Here we come squarely into contact with one of the difficulties of information theory. In news transmission, the greatest possible information content is obtained when the probability of the individual signals is distributed as uniformly as possible. This situation is referred to as the maximum entropy of information. It is easily possible to consider this in such a way that every possibility of relating previously-received news to the following symbol must of necessity diminish the information content, which limits through related redundancy the freedom on the selection of symbols (news, the con-

tent of which one can already predict, has no information content). Every sort of configuration necessarily represents through its rules a limitation of the possible means of representation and diminishes thereby the information content. Conservation of information and conservation of configuration are therefore contradictory to a certain extent.

The question whether or not tested terms in physics (energy, effective quantum, elementary charge, mass, etc.) can be interpreted by the terms of information theory or of information processing cannot yet be answered. In the model of a cellular automaton constructed so that processes occur in it which can be related to the listed physical quantities, these quantities must be represented by the construction of the circuits; i.e., by the values represented in the circuits.

Even more important than the term information content is that of information exchange. Something dynamic, not something static, results from circuit principles. Perhaps it could be called conservation of events or complication of events (Dr. Reche suggested the idea of “conservation of complicatedness”, although in another connection). Viewed this way, the shifting process acquires added meaning. If the effective quantum is assigned the dimension “shifting process”, we obtain the dimension “shifting process per unit time” for energy. The principle of conservation of energy can then be interpreted as the principle of conservation of events. The term “effective quantum” already points to a close relationship to shiftlike effects, namely the shifting process. The representation of energy as an “event” makes the relationship between energy and frequency more easily understandable. These thoughts are for the time being only simple speculation. Their purpose is to stimulate the application of automaton theoretical means of observation in physics.

A consideration of the Heisenberg uncertainty principle in the light of information theory follows. If a storage capacity of m bits is available for the digital representation of two quantities A and B , we are free to distribute the two quantities with different numbers of places and even differing precisions on the number of places. If n places are assigned to A , B has $m - n$ places. The error in A is on the order of magnitude of 2^{-n} , that of B the order of magnitude of $2^{-(m-n)}$. The product of both errors yields the constant 2^{-m} .

It is possible to assume that both conjugated quantities A and B are not directly represented by the pattern of digital particles, but represent derived quantities which appear only in certain processes. The limitations on the information content of the digital particles do not permit both quantities to be represented with the maximum possible accuracy. In the case of digital particles, even if one of the quantities is completely indeterminate, the other

cannot be represented with ideal accuracy, but only with the maximum accuracy permitted by the limitations on the number of places. The following can be stated with regard to the principles of conservation: limiting values of the upper and lower sums must be considered. The laws of addition do not have unlimited validity. Similarly losses enter in the construction of models by falling below the threshold values. Digital models are possible in which, in spite of this occurrence, laws of conservation can be defined.

4.5 About Determination and Causality

The question of determination and causality is closely related to observations from information and automaton theory. The expression “causality” is not strictly used in the literature. In the following it is always used to mean that which is generally referred to as “determination”, namely the definition of the succeeding state of a closed system as a function of the preceding state. The entire universe can be seen as a closed system, to the extent the necessary consequences of this assumption are taken into account.

Automaton theory works with the concept of the state of an automaton. Finite automatons can receive a limited number of states. If there is no entrance signal, the resultant state results from that which preceded it because of the algorithmus basic to the automaton. Because automaton theory works with abstract concepts, this conversion from one state to the next occurs in theory without intermediate steps. Automaton theory does not ask the question exactly how this conversion occurs in an operating automaton. It is concerned solely with the fact that, for example, a flip-flop takes place from one state to another in the space of a certain time, the pulse time. The technological analysis of the turnover process, which is possible, lies outside the range of automaton theory observations, as long as it is not concerned with the comprehension of such details.

The opinion is held by some physicists, for instance Arthur March¹, that direct conversion of an atom from one stable state to another is difficult to reconcile with the rule of causality. He understands the idea of causality in such a way that conversion from one closed system to the next requires a continual process. This interpretation can hardly resist the automaton theoretical consideration of physical processes. It cannot be assumed that this idea is based on reality. The process of thinking in whole numbers and in discrete states requires a thought process of non-continuous transitions, in which the law of causality is formulated in algorithms. Work with discrete

¹For example, see March, Arthur: *Die physikalische Erkenntnis und ihre Grenzen* (Physical Perception and Its Limits), p. 19.

states and quantification as such does not necessarily require rejection of the causal manner of observation.

This continuous transition in the sense of automaton theory must be differentiated from the thought of the continuous transition between the individual stable states of an atom. Since we are not able to analyze the process of such a transition experimentally, all theories on this subject belong to the realm of speculation. In the automaton theoretical sense, the natural objective is to create models which enable these transitions to be followed individually and permit explanation of the emission or absorption of photons in the associated process. We cannot predict whether this goal will ever be reached. The often-argued opinion that such transitions are essentially unanalyzable and that such experiments should be subordinated to more fruitful endeavors can, however, be refuted. Quantum physics provides statistical laws for such processes through which individual determinations are supplanted by statistical determinations. This subject will be pursued further in connection with the discussion of probability.

It is important to inquire whether the determination is valid in both time directions; i.e., whether later states of the system are clearly functions of the previous states as well as the reverse. The classical model of mechanics satisfies this demand for time symmetry ideally. Statistical quantum mechanics introduces the idea of probability and observes a deviation from time symmetry in the increase in entropy. In general, finite automata follow laws determined in only the positive direction. The algorithm establishes only which state arises from the given one, not the reverse. It is possible to construct automata in which the previous state is determined by the one which follows it, but this does not necessarily imply symmetry in the time direction. A consideration of computers may clarify this. A computer is—assuming unobjectionable work—determined in the positive time direction. In general, calculating processes are not reversible, which may be seen from consideration of the basic operations on which all higher calculations are based and which are not reversible (for example, $a \vee b \Rightarrow c$). A calculator is one example of a calculating machine which is effectively determined in both directions, because it counts forward in one time direction and backward in the other, to the extent that we consider only the state tables and do not analyze the processes individually.

The different characteristic types of operation of an autonomous automaton were already discussed in 4.4 in connection with Fig. 68. Type 68b would correspond to an automaton determined in both directions, as is the calculator mentioned.

A difference remains nevertheless: in the positive time direction, the rule

by which the following state is related to the preceding one is explicitly given by the algorithm. In the negative time direction, there exists a single correlation, to be sure, but this correlation is only implicitly given; i.e., it cannot be directly calculated without further knowledge. This difference is not clearly visible in the diagrams corresponding to Fig. 68 and in the state table corresponding to Fig. 4. In any case, this type of representation is possible only for very simple automata and serves more for primary experiments than for practical determinations of the automaton operation process. The actual rule for the formation of the following state from the preceding one is given by the automaton circuits. We are able to say that an autonomous automaton is determined in the positive time direction and that in special cases of negative time direction a “pseudodetermination” exists.

The relationships of digital particles are similar in the cases discussed in Chapter 4.4. As long as such a particle follows its path independent of outside influences, a single sequence of states occurs. As soon as we consider the sequence of two particles, the conditions are immediately different. In this case, the examples in Chapter 3, Figures 42-66 refer to irreversible processes. The basic shifting rule regulates the processes in the interaction of the particles, There is no sort of inducement for a particle to divide into two particles at any time. This statement makes only one assertion about the models used in Chapter 3. The question whether it is possible to construct usable models of digital particles which do not have this characteristic is difficult to answer. This is the same problem as the one confronting the physicist in the decay of elementary particles or atomic nuclei. The present state of theoretical physics is such that we can only give probability laws for such processes. In a model which follows a predetermined operation process and excludes working elements, in accordance with the probability laws, there are only two means of solution:

- (a) the digital model is constructed in such a way that it contains a sort of clock which dissolves the process when a certain state has been reached;
- (b) the influence of the environment, (for example that of fields through which the digital particle moves) is taken into account. In the process of moving through its different phases, a particle can pass through critical states in which the influence of the environment (frequency, etc.) causes particle division.

The present state of physical theories does not permit the drawing of conclusions about physical laws from these possibilities of digital models. What has already been said for the transition from one atomic state to another is equally relevant here: no experiment permits an examination behind the scenes, and all theories are essentially speculative in character. Nevertheless,

it has been possible to determine a certain dependence of radioactivity at high temperatures, which corresponds to the assumption of critical situations influenced by the environment.

One result is important, in any respect: the assumption of valid determination only in the positive time direction is not influenced in the least by the dissolution of physical laws into the laws of probability. Similarly, the increase in entropy is not necessarily related to this question. From the viewpoint of automaton theory, each of these questions takes on another meaning. Entropy can be explained in a digital model, the operation of which is strictly determined.

Let us consider the classical model of physics from this point of view. As already mentioned, the validity of the determination, particularly in both time directions, requires absolute accuracy of the individual processes. It may hardly be assumed that serious considerations of the extreme significance of this assumption in regard to information theory have been made. Such a model requires an infinitely fine structure of spatial and temporal relationships. An infinite information content is required for an unlimited spacetime element. It is practically impossible to simulate such a model with computers because of the necessity of infinite number of places required. The sources of error are correspondingly great in the extremely large number of collisions between gas molecules, and these errors quickly lead to deviations from theoretical processes. This means that the better the causality rule is approximated in the reverse time direction, the more calculations we must be prepared to carry out in our model. This leads to the result that simulations of universal systems with causality functioning in both time directions belong to the category of “unsolvable” problems.

Of course, it can be said that this is true only for calculating simulative models. But this result should encourage us to reconsider the matter. Are we justified in assuming a model of nature for which no calculable simulation is possible?

From this point of view, it appears that the frequently advanced argument of determination in both time directions should be fundamentally reexamined.

The question of time symmetry of the physical laws is frequently discussed in connection with the reflective characteristics of space. The observations of automaton theory might be of significant value in furthering this discussion.

4.6 On Probability

The problem of determination in modern physics is closely related to the laws of probability. An observation from automaton theory may be inserted here. It is of course possible to build mathematical systems, such as matrix mechanics and wave mechanics, in which probability values play a significant part. The automaton theoretician can introduce the idea of probability into his theories and can establish a successive state dependent on probability values. To this point, the process is a simple mathematical game on paper. It becomes critical when we attempt to construct finished forms of such mechanisms which operate according to the laws of probability. Such calculations have been carried out in our calculating automatons with considerable success for some time (Monte-Carlo method). The element of chance is introduced into the calculation in the form of “chance values”. The generation of these chance values is the decisive problem. There are two ways to accomplish this.

- (a) The values are generated by simulation of the dice method and that type of number series, in which no sort of dependence between the numbers exists. Such a number series can be developed from the calculation of irrational numbers (π , for example). In reality, this process is strictly determined. Nevertheless, we speak of pseudo-chance values. This process is completely sufficient when the generation rule for such chance values is carefully chosen.
- (b) A mechanism is taken from nature which is either so complicated that it cannot be shown to be regular or for which it can be said that, according to the valid laws of physics, it provides “real” probability values. The dice mechanism belongs to the first sort, where causal rules play a role but for which, in the case of a sufficiently carefully built die, equal probability for every case can be shown. The same is true for all games of chance (roulette, etc.). In the other case we rely on the fact that, for example, the radioactivity of a certain material is subject to strict probability laws. Whether the probability process is in reality determined in these atoms is not significant, for experience shows that in any case the laws of probability can be assumed without leading to incorrect results. In this case the calculating automaton regards the probability values to a certain extent as external input values. It remains true, however, that real probability values are hardly possible in technical automatons.

It must also be remembered that the choice of algorithm for creation of the pseudo-chance values is highly significant in Case (a). This means that only those choices from the range of basic number series are possible which follow one another as irregularly as possible and which have the most uniform possible distribution of probability. This means that longer series of the same number and series of numbers in the same separation (1, 2, 3) must be excluded, although these series are just as probable or improbable in real series of chance values as any other number series.

Of course, we can ask the purely speculative question whether true probability laws are admissible to automaton theoretical observations of physical processes. This question is a philosophical one, and is only noted here, without an answer.

4.7 Representation of Intensity

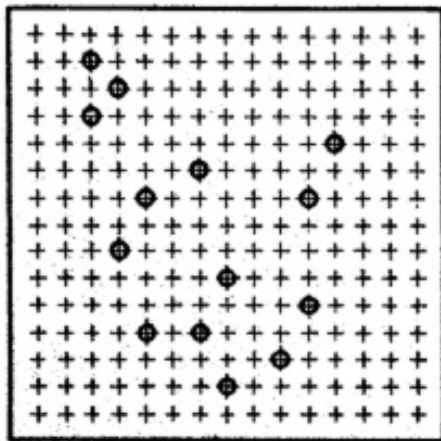

Figure 69

The representation of intensity of field strengths and other numerical quantities in cellular automata must be specially considered. For this reason, a few basic possibilities are considered here.

Fig. 69 shows a two-dimensional grid in which individual grid points are occupied by elementary logical values; for example, yes-no values. If we assign to these values the numbers 0 and 1, the statistical distribution of the 1 values represents a scale for field strength. This sort of representation can accomplish little,

of course, if many orders of magnitude of density must be taken into account. As already mentioned, the relationships of electrostatic interactions to gravitational interactions is on the order of $10^{40} : 1$. If we wanted to represent these intensity differences in a three-dimensional space corresponding to Fig. 69 using yes-no values, a cube with a side length of approximately 10^{13} grid units would be necessary. This represents only a lower limit, for in reality field strengths can differ by even greater orders of magnitude. If we take a grid with the elementary length of 10^{-13} cm accepted by physicists, it would mean that a space of many cubic centimeters would be necessary, according to these calculations, to represent the field intensity. This type

of model cannot be very useful, entirely independent of the fact that it is extremely difficult to establish laws for stable digital particles with this sort of statistical distribution.

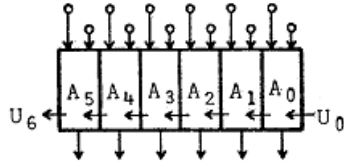

Figure 70

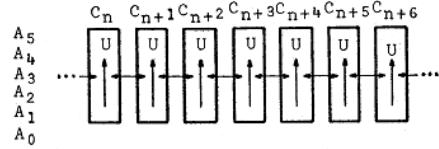

Figure 71

A much more rational method is offered by the principle of place values. This does not lead to the idea to construct calculating automatons according to the principle of Fig. 69. Fig. 70 shows the ideal arrangement of an adding machine consisting of neighboring cells and among which a hierarchical ordering is seen. The individual cells are coordinated with numbers of different value. This is reflected in the one-sided construction of the transmission process $u_0 - u_6$.

Fig. 71 shows the transmission of this thought process to a linear cellular automaton. Each cell is allied with a complete adding machine. Each cell C_i is subdivided into the individual addition steps $A_0 \dots A_5$. In the construction of such a shifting system it must be remembered that the transmissions among levels within the cell must be coordinated in time with the transmission of information between the individual cells.

This principle is relatively easy to put into practice for one-dimensional and two-dimensional cellular automatons. Theoretically it can be applied to three- and more-dimensional automatons without any modifications. In addition to the dimensions, which correspond to the topological arrangement of neighboring cells (space dimension), there is also a level dimension. This is only imaginable in three-dimensional space and must be constructively built into (projected into) three-dimensional space.

The further question can be asked whether in a symmetrically built cellular automaton a hierarchical ordering can be introduced by the manner of occupancy. Fig. 72 demonstrates the principle. The single cells can contain, for example, single addition steps and are not able to accept several-place numbers. These are divided among several neighboring cells, according to the place value principle. The difficulty arises in the fact that this sort of arrangement is of the nature of occupancy. If the concept is applied to a several-dimensional automaton, it is easy to see that major complications develop.

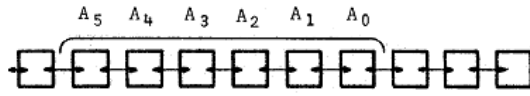

Fig. 72a

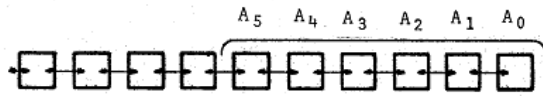

Fig. 72b

Figure 72

Cellular automaton provide an elegant solution when each cell contains a complete calculating system, as symbolically represented in Fig. 73. These single calculating systems contain both information-processing and information-storing

elements.

The net automaton represented in Fig. 74 is a further development of the cellular automaton corresponding to Fig. 73. The individual cells are responsible here for only information processing. Branching lines B connect the individual cells and serve both for information transmission and for information storage. The individual cells can consist of single-place adding units, according to the series principle valid for calculating machines. Preliminary investigations by the author have shown that this type of automaton is highly successful, specifically in the solution of numerical problems as well as in simulation of physical processes. More specific consideration will be the subject of another paper.

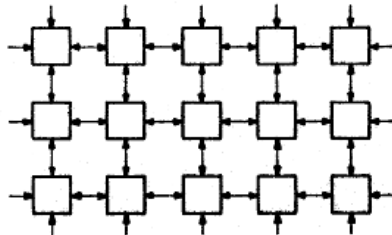

Figure 73

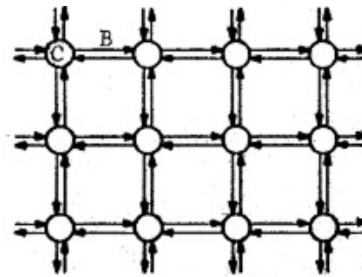

Figure 74

5 CONCLUSIONS

Even if these observations do not result in new, easily understood solutions, it may still be demonstrated that the methods suggested have opened several new perspectives which are worthy of being pursued. Incorporation of the concepts of information and the automaton theory in physical observations

will become even more critical, as even more use is made of whole numbers, discrete states and the like.

A relating of different possible conceptualizations is attempted in the following table:

CLASSICAL PHYSICS	QUANTUM MECHANICS	CALCULATING SPACE
Point mechanics	Wave mechanics	Automaton theory Counter algebra
Particles	Wave-particle	Counter state, digital particle
Analog	Hybrid	Digital
Analysis	Differential equations	Difference equations and logical operations
All values continuous	A number of values quantized	All values have only discrete values
No limiting values	With the exception of the speed of light, no limiting values.	Minimum and maximum values for every possible magnitude
Infinitely accurate	Probability relation	Limits on calculation accuracy
Causality in both time directions	Only static causality, division into probabilities Classical mechanics is statistically approximated Based on formulas	Causality only in the positive time direction introduction of probability terms possible, but not necessary Are the limits of probability of quantum physics explainable with determinate space structures? Based on counters

In view of the possibilities listed, it is clear that there are several different points of view possible:

- (1) "The ideas of calculating space contradict some recognized concepts of present-day physics (for example, space isotropy); therefore, the fundamental basis must be false."
- (2) "The laws of calculating space must be revised with the object of eliminating the existing contradictions."

- (2) “The possibilities arising from the ideas of calculating space are in themselves so interesting that it is worthwhile to reconsider those concepts of traditional physics which are called into question and to examine their validity from new points of view.”

The author has greatly enjoyed being able to discuss this subject with a few mathematicians and physicists. The greatest handicap to cooperation is certainly the difference in terms between the individual, specialized fields of knowledge. We hope that this chasm will be bridged in time and that through cybernetics, a true bridge between physics and the automaton theory can be built.

Independent of the possibility that the idea of calculating space can be directly applied to physical determinations, there remains the major task of providing theoretical physics with an aid in calculating and of finding numerical solutions to very complicated relationships. In spite of the use of huge computers in the field of physics, the applications of “software” in physics are still much more limited than the applications of “hardware”. With huge accelerators that cost hundreds of million dollars we are able to obtain particles of very great energy, requiring a fundamental reexamination of the general validity of our basic theoretical hypotheses. Is there not a considerable danger that the software lags behind the hardware of physics, and that we will soon be unable to evaluate the determinative results of our practical experiments?

In the field of information processing we are already spending equivalent amounts on hardware and software. In physics the ratio of expenditures is probably between 1:20 and 1:100. The result in chemistry is about the same. Although the laws of electron shells have been generally known for a long time, young scientists are able to explore them only within circumscribed limits in precise, analytical chemistry. The author hopes that the ideas of calculating space after a period of adaptation will be of assistance. The first step would be further development of the models of the automaton theory approximately along the lines suggested in this article. When this process has reached a certain maturity, then specific goals can be set.

It must be stressed that the experiments of the author are confined to pen and paper experiments. Further experimentation must be carried out with the help of modern computers.

Afterword to Konrad Zuse's *Rechnender Raum*

Adrian German¹ & Hector Zenil²

¹School of Informatics and Computing,
Indiana University Bloomington, USA

²Department of Computer Science,
University of Sheffield, UK

There are many parallels between Zuse's and Turing's interests. In the mid 1930s, some researchers were engaged in what amounted to an inquiry into the nature of computation, and trying to figure out whether it would be possible to build a computing machine. In part this was a consequence of Hilbert's programme, but it was no doubt also due to a certain chain of historical events. As pointed out by Raúl Rojas¹, people started to think about computers when it was time to build computers. There were of course Schönfinkel (SKI combinators), Church (λ calculus), Post (tag systems), Kleene (recursive functions), Turing (a-machines), among a few others.

Perhaps the main difference between all the other approaches and Zuse's lies in the fact that Zuse was a civil engineer aiming to solve concrete problems and, as such, his approach was quintessentially practical. Thus Zuse's goal was from the beginning that of building a concrete, mechanical realization of computation. Turing's approach falls mid-way between the purely abstract and a practical realization. This fact alone may explain why Turing's work was, in the end, more visible than others. Zuse's approach being an engineer's answer to the question of computation, his solution took the form of an actual machine ².

Zuse may not have realized that there was a fundamental concept behind the question all these people were asking and ultimately trying to answer (Zuse was working in relative isolation, unlike the others, who for the most part knew of each other). Turing finally provided the closest answer to the question with his concept of computation universality, the founding notion of Computer Science. Paradoxically, today's digital computers may be more similar in some respects to Zuse's than to Turing's idealization, certainly

¹In a recent talk *Zuse and Turing in Context* in Cambridge, UK on February 18, 2012.

²The most comprehensive source of information is the Konrad Zuse Internet Archive curated by Raúl Rojas available online at <http://www.zib.de/zuse/home.php> (accessed in April 2012). His son, Horst Zuse, maintains his father's homepage, available at <http://www.horst-zuse.homepage.t-online.de/konrad-zuse.html> (accessed in April 2012). And Juergen Schmidhuber³ also maintains a website devoted to Zuse, available at <http://www.idsia.ch/~juergen/zuse.html> (accessed in April 2012).

because Zuse had to deal with the minutiae of actually building a physical machine (for ex., the IEEE Standard for floating-point coding is almost the same as the representation used in Zuse's Z1 and Z3). Zuse never thought of universality as Turing did, but as Rojas has proved, not without some creativity, the Z1 and Z3 *accidentally* (because it was never Zuse's purpose, and he didn't even formulate the question) turn out to be capable of universal computation⁴. Zuse never thought about how the machine could get into an unbounded computation (necessary for universality), for example, and if it did, how to make it stop (Rojas suggests that there would have had to be a mechanical/electrical hack to arbitrarily stop the machines, with the required computation finished and somehow encoded among other computations in the output, if unbounded computation were allowed—by, for example, looping a punched card).

Upon graduating in 1935, Zuse became a stress analyst for the Henschel Aircraft Company, where he worked on problems of aircraft vibration. Stress analysis involved formidable calculations, which at the time could only be performed with great difficulty using teams of human “computers” equipped with desk calculating machines.⁵ Zuse thought that many of the calculations he was performing could simply be automatized. With a 1936 research grant from the *Reichsluftfahrtministerium* (the German ministry of aviation), he coincidentally built his first computing machine between 1936 and 1938, and in 1938 he was building his second one, using phone relays unlike the first one, which was mechanical. His Z3 was completed in 1941, was fully operational, and was able to perform calculations⁶. His Z1 was already programmable even though mechanical, using punched tapes.

His main motivation to switch from a mechanical to an electronic mode was a concern about reliability—he wanted to build resilient and fault-tolerant machines—but the Z3 built with electronic relays was logically equivalent to the Z1. The Z1 and Z3 could be programmed and could perform all arithmetical calculations, could load and store information in binary and were capable of floating-point calculations (whereas the Mark I and the ENIAC in the U.S. still represented data in decimals, even though they both operated

⁴See Raul Rojas' “The Architecture of Konrad Zuse's Early Computing Machines,” in “The First Computers – History and Architecture,” MIT Press, 2000, pp. 237-262, edited by R. Rojas and Ulf Hashagen.

⁵<http://www.independent.co.uk/news/people/obituary--konrad-zuse-1526795.html> (accessed in April 2012).

⁶An online video made at the Deutschen Museum München shows how the Z3 worked, using examples of arithmetical division and square roots: <http://www.youtube.com/watch?v=J98KVfeC8fU> (accessed in April 2012)

with binary gates, and were unable to handle floating-point calculations). Zuse decided to use the binary system and metallic plates that could move only in one direction, i.e. they could only shift position, just as modern digital computers do at their lowest working level (Zuse seemed to believe that mechanical devices and digitally based calculations were more reliable as compared to, for example, vacuum tubes, as suggested by Helmut Schreyer, Zuse’s friend.).

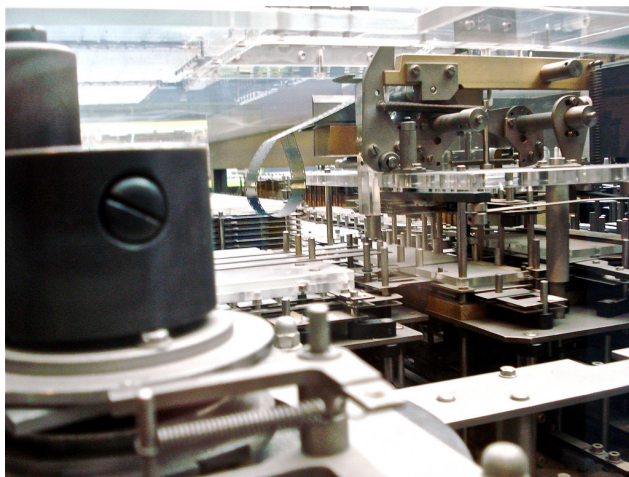

Figure 75: Replica of the first mechanical computer designed by Konrad Zuse, the Z1, finished in 1938. It was a binary electrically driven mechanical calculator which used Boolean logic and binary floating point numbers. Picture taken by H. Zenil, *Deutsches Technikmuseum* (“German Museum of Technology”), Berlin.

Zuse and Turing never met but they became acquainted with each other’s work. Zuse mentions Turing’s work in his autobiography, and it is known that Turing was on the program/reviewing committee of at least one colloquium that Zuse attended—but not Turing—at the Max-Planck-Gesellschaft in Göttingen in 1947. Had Turing attended they would actually have met.

But if Zuse didn’t hit upon the concept of universal computation, he was interested in another very deep question, the question of the nature of nature: “Is nature digital?” He tended toward an affirmative answer, and his ideas were published, according to Horst Zuse (Konrad’s eldest son), in the *Nova Acta Leopoldina*. Horst was born precisely when Konrad was thinking about *Rechnender Raum* for the first time (the common translation into English is *Calculating Space* but the phrase in his native German carries a lot more cognitive weight than its plain English counterpart, in light of the ideas treated in Zuse’s piece: calculation, computation of nature, space

and/or the universe). Hector Zenil (HZ) met Prof. Horst Zuse (a professor at the Technische Universität of Berlin) in the Autumn of 2006 during a conference dinner in Berlin. The conference topic was precisely “Is the Universe a Computer?” (Ist das Universum ein Computer?) and it was held at the Deutschen Technikmuseum and organized to mark the Year of Informatics (Informatik Jahr) in Germany.⁷

Konrad Zuse did, however, acknowledge the problems likely to be faced in attempting to reconcile a digital view of the universe with theories of physics assumed to work in continuum spaces. But according to Konrad Zuse, the laws of physics could be explained in terms of laws of switches or relays (not a surprise as he had experienced the transformation of his machines from mechanical to electronic form through the use of relays), and thought of physical laws as computing approximations captured by mathematical models. It is clear from *Rechnender Raum* that Zuse knew that differential equations could be solved by digital systems and took this fact as evidence in favor of a digital theory.

Years before John von Neumann explained the advantages of a computer architecture in which the processor is separated from the memory, Zuse had already arrived at the same conclusion. As a computer builder in the 1930s, Zuse worked as an amateur completely outside the mathematical community, on his own time, in the evenings and on weekends, in the living room of his parents’ house. He did, however, obtain some financial assistance from a local calculating machine manufacturer. He also persuaded Helmut Schreyer, a former university classmate, to work with him. It was on the advice of his friend Schreyer that Zuse moved from mechanical to electro-mechanical, telephonic relays.

In his autobiography⁸, Zuse writes that in 1939, as war broke out, he was drafted into the infantry to serve on the front lines. He never saw action as a soldier. His military service was to last six months, “six months during which I had plenty of time to contemplate the ideas developed and captured in my diary notes of 1937 and 1938.” He was exempted from active duty and discharged so he could undertake work directly related to weapons development, as a structural engineer in the Special Division F at Henschel Aircraft Company, where remote-controlled flying bombs were developed.

In 1941, shortly after the Z3 was completed, Zuse went back to work as a structural engineer in aircraft construction with Henschel, a day job while

⁷HZ wrote a blog post about it, available online at <http://www.mathrix.org/liquid/archives/is-the-universe-a-computer>.

⁸“The Computer – My Life,” published in German by Springer-Verlag in 1993 and translated into English in 2010, the anniversary of Zuse’s birth.

starting a company, *Zuse Apparatebau* (Zuse Apparatus Construction), to manufacture his machines. When the Z3 became operational, it was the world's first practical automatic computer, and for 2 years remained the only one. A second machine, the Z4, was quickly commissioned. During the war Z3 was demonstrated before several departments, yet it was never put into everyday operation. In 1944 the Z3 was destroyed in an air raid but it was reconstructed in 1960 and set up in the *Deutsches Museum* in Munich.

Zuse and Schreyer had, however, to abandon the building where their computer was housed. As the war came to an end, Zuse retreated to Hinterstein, a village in the southeast of Germany, where his eldest son (Horst) was born. There he reconstituted his Z4 computer in a stable, and it became the world's first operational commercial computer, leased to the ETH Zürich (one of the two universities of the Swiss Federal Institutes of Technology). Then he began working in an area that didn't require physical resources—computer programming. He devised a language, the Plankalkül (meaning “formal system for planning” or “calculus of programs”; “a universal language” according to Zuse, who compared it to an “artificial brain”), which anticipated some programming concepts that surfaced later, and can be considered the first high-level programming language, although no compiler or interpreter was ever written for it. In 1945, perhaps with the same motivation that led Turing to turn to chess, namely the fact that the game was believed to epitomize human intelligence while seeming highly algorithmic, Zuse worked on chess playing algorithms formulated as routines in his Plankalkül. One year before, in 1944, he had organized his work into a dissertation⁹ which was never defended formally. The title he chose for his work was “Beginnings of a Theory of General Computing,” trying to establish the foundations of what is today generally understood as information processing: “Computing (*Rechnen*)”, he wrote, “means, in general, forming new data from given data according to some rule.” The concept of the algorithm would later replace his concept of *Vorschrift* (or rule). His programming language, like the logic, design and construction of his computing machines, was entirely his own work, carried out in isolation from developments elsewhere.

While still in Hinterstein he wrote a treatise entitled “Freedom and Causality in the Light of the Computing Machine”. In his autobiography he writes: “I think the majority of researchers involved in the development of the computer have at some point in their lives, in one way or another

⁹See “The Plankalkül of Konrad Zuse – Revisited” by Friedrich L. Bauer, in “The First Computers – History and Architecture,” cited earlier.

considered the question of the relationship between human free will and causality.” This was to be the major impetus for the work that led to the translation presented in this volume:

“While considering causality it suddenly occurred to me that the universe could be conceived as a gigantic computing machine. I had the relay calculator in mind: relay calculators contain relay chains. When a relay is triggered, the impulse propagates through the entire chain. The thought went through my head that this must also be how a quantum of light propagates. The thought settled firmly; over the years I have developed it into a concept of the *Rechnender Raum*, or ‘computing universe’. However, it was to be another thirty years before I succeeded in formulating the idea correctly.”

In 1967, Zuse suggested that the universe itself was running on a cellular automaton or a similar computational structure, a metaphysical position known today as digital physics, a subject Ed Fredkin had himself taken up before becoming acquainted with the work of Zuse. Excited to discover this work, Fredkin invited Zuse to Cambridge, MA. The translation of *Rechnender Raum* reproduced here, from a German (published) version of Zuse’s ideas, was in fact commissioned during Ed Fredkin’s tenure as Director of MIT’s Project MAC¹⁰ (the AI lab that was a precursor of the current MIT AI labs)

More than twenty years after his *Rechnender Raum*, in Zuse’s autobiography, he wrote:

“In the final analysis, the concept of the computing universe requires a rethinking of ideas, for which physicists are not yet prepared. Yet it is clear that earlier concepts have reached the limits of their possibilities; but no one dares to switch to a fundamentally new track. Yet, with quantization, the preliminary steps towards a digitalization of physics have already been taken; but only a few physicists have attempted to think along the lines of these new categories of computer science. [...] This was illustrated quite clearly during the conference on the Physics of Computation, held May 6-8, 1981 [at MIT]. What was typical at this conference was that, although the relationship between

¹⁰Ed Fredkin is also a contributor to *A Computable Universe: Understanding & Exploring Nature as Computation*.



Figure 76: (How) Does Nature Compute? A Panel Discussion organized by A. German and H. Zenil during the last day of the 2008 NKS Midwest Conference, featuring (in order): Greg Chaitin, Ed Fredkin, Rob de Ruyter, Anthony Leggett, Cristian Calude, Tommaso Toffoli and Stephen Wolfram, moderated by (from left to right) Gerardo Ortiz, George Johnson and Hector Zenil, at the University of Indiana Bloomington. See <http://www.cs.indiana.edu/~dgerman/2008midwestNKSconference/>

physics and computer science, and/or computer hardware, was examined in detail, the questions of the physical possibilities and limits of computer hardware still dominated the discussions. The deeper question, to what extent processes in physics can be explained as computer processes, was dealt with only marginally at this otherwise very advanced conference.”

The original of *Rechnender Raum* seems to have been lost. To our knowledge the translation commissioned by Project MAC (the precursor to the current MIT Computer Science and Artificial Intelligence Laboratory or *CSAIL*) was never published in a journal¹¹. It is reproduced here translated into modern \LaTeX , which required quite a bit of work, despite having used OCR techniques with *Mathematica* first, in order to avoid starting completely from

¹¹Scanned copies of a short German version and the translation into English, accompanied by additional contextual material, are available online at Schmidhuber’s website *Zuse’s thesis* at <http://www.idsia.ch/~juergen/digitalphysics.html>. The German version is also at <http://www.zib.de/zuse/Inhalt/Texte/Chrono/60er/Pdf/76scan.pdf> (links accessed in April 2012)

scratch. It is published in this volume without changes, except for perhaps a few corrected typos and redistribution of text and images to fit the book format. The material is at once dated and surprisingly contemporary: “I propose that in an information-theoretic analysis, objects and elementary dimensions of physics must not be complemented by the concept of information, but rather should be explained by it.” Zuse was always aware of the hypothetical nature of his thesis: “The concept of the computing universe is still just a hypothesis; nothing has been proved. However, I am confident that this idea can help unveil the secrets of nature.”

Zuse refers the more skeptical among us to a quote from Freeman Dyson (“Innovation in Physics” published in *Scientific American*, Vol. 199, No. 3, (September 1958), pp. 74-82.): “A few months ago Werner Heisenberg and Wolfgang Pauli believed that they had made an essential step forward in the direction of a theory of elementary particles. Pauli happened to be passing through New York, and was prevailed upon to give a lecture explaining the new ideas to an audience which included Niels Bohr. Pauli spoke for an hour, and then there was a general discussion during which he was criticized rather sharply by the younger generation. Finally Bohr was called on to make a speech summing up the argument. ‘We are all agreed,’ he said, ‘that your theory is crazy. The question which divides us is whether it is crazy enough to have a chance of being correct. My own feeling is that it is not crazy enough.’”

“Imagination,” Zuse used to say, “is the key to all progress.”

A. German and H. Zenil

Bloomington, IN. USA and Sheffield, UK